

November
2011



VW197 Series LCD Monitor

User Guide

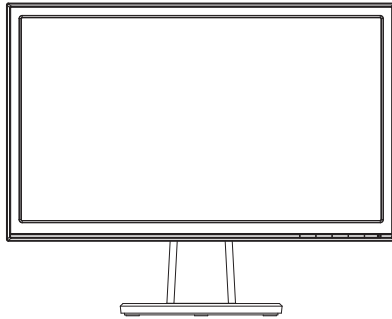

Table of contents

Notices.....	iii
Safety information	iv
Care & Cleaning	v
1.1 Welcome!	1-1
1.2 Package contents.....	1-1
1.3 Assembling the monitor	1-2
1.4 Monitor introduction	1-3
1.4.1 Front of the LCD monitor.....	1-3
1.4.2 Rear of the LCD monitor	1-5
1.4.3 Wiring to comply with TCO Certified (VW197TR/VW197NR/VW197SR/VW197DR).....	1-6
2.1. Detaching the arm/stand (for VESA wall mount)	2-1
2.2. Adjusting the monitor	2-2
3.1 OSD (On-Screen Display) menu	3-1
3.1.1 How to reconfigure	3-1
3.1.2 OSD Function Introduction	3-1
3.2 Specifications.....	3-5
3.3 Troubleshooting (FAQ).....	3-6
3.4 Supported timing list	3-7

Copyright © 2011 ASUSTeK COMPUTER INC. All Rights Reserved.

No part of this manual, including the products and software described in it, may be reproduced, transmitted, transcribed, stored in a retrieval system, or translated into any language in any form or by any means, except documentation kept by the purchaser for backup purposes, without the express written permission of ASUSTeK COMPUTER INC. ("ASUS").

Product warranty or service will not be extended if: (1) the product is repaired, modified or altered, unless such repair, modification or alteration is authorized in writing by ASUS; or (2) the serial number of the product is defaced or missing.

ASUS PROVIDES THIS MANUAL "AS IS" WITHOUT WARRANTY OF ANY KIND, EITHER EXPRESS OR IMPLIED, INCLUDING BUT NOT LIMITED TO THE IMPLIED WARRANTIES OR CONDITIONS OF MERCHANTABILITY OR FITNESS FOR A PARTICULAR PURPOSE. IN NO EVENT SHALL ASUS, ITS DIRECTORS, OFFICERS, EMPLOYEES OR AGENTS BE LIABLE FOR ANY INDIRECT, SPECIAL, INCIDENTAL, OR CONSEQUENTIAL DAMAGES (INCLUDING DAMAGES FOR LOSS OF PROFITS, LOSS OF BUSINESS, LOSS OF USE OR DATA, INTERRUPTION OF BUSINESS AND THE LIKE), EVEN IF ASUS HAS BEEN ADVISED OF THE POSSIBILITY OF SUCH DAMAGES ARISING FROM ANY DEFECT OR ERROR IN THIS MANUAL OR PRODUCT.

SPECIFICATIONS AND INFORMATION CONTAINED IN THIS MANUAL ARE FURNISHED FOR INFORMATIONAL USE ONLY, AND ARE SUBJECT TO CHANGE AT ANY TIME WITHOUT NOTICE, AND SHOULD NOT BE CONSTRUED AS A COMMITMENT BY ASUS. ASUS ASSUMES NO RESPONSIBILITY OR LIABILITY FOR ANY ERRORS OR INACCURACIES THAT MAY APPEAR IN THIS MANUAL, INCLUDING THE PRODUCTS AND SOFTWARE DESCRIBED IN IT.

Products and corporate names appearing in this manual may or may not be registered trademarks or copyrights of their respective companies, and are used only for identification or explanation and to the owners' benefit, without intent to infringe.

Notices

Federal Communications Commission Statement

This device complies with Part 15 of the FCC Rules. Operation is subject to the following two conditions:

- This device may not cause harmful interference, and
- This device must accept any interference received including interference that may cause undesired operation.

This equipment has been tested and found to comply with the limits for a Class B digital device, pursuant to Part 15 of the FCC Rules. These limits are designed to provide reasonable protection against harmful interference in a residential installation. This equipment generates, uses and can radiate radio frequency energy and, if not installed and used in accordance with manufacturer's instructions, may cause harmful interference to radio communications. However, there is no guarantee that interference will not occur in a particular installation. If this equipment does cause harmful interference to radio or television reception, which can be determined by turning the equipment off and on, the user is encouraged to try to correct the interference by one or more of the following measures:

- Reorient or relocate the receiving antenna.
- Increase the separation between the equipment and receiver.
- Connect the equipment to an outlet on a circuit different from that to which the receiver is connected.
- Consult the dealer or an experienced radio/TV technician for help.



As an Energy Star® Partner, our company has determined that this product meets the Energy Star® guidelines for energy efficiency.

Canadian Department of Communications Statement

This digital apparatus does not exceed the Class B limits for radio noise emissions from digital apparatus set out in the Radio Interference Regulations of the Canadian Department of Communications.

This class B digital apparatus complies with Canadian ICES-003.

Safety information

- Before setting up the monitor, carefully read all the documentation that came with the package.
- To prevent fire or shock hazard, never expose the monitor to rain or moisture.
- Never try to open the monitor cabinet. The dangerous high voltages inside the monitor may result in serious physical injury.
- If the power supply is broken, do not try to fix it by yourself. Contact a qualified service technician or your retailer.
- Before using the product, make sure all cables are correctly connected and the power cables are not damaged. If you detect any damage, contact your dealer immediately.
- Slots and openings on the back or top of the cabinet are provided for ventilation. Do not block these slots. Never place this product near or over a radiator or heat source unless proper ventilation is provided.
- The monitor should be operated only from the type of power source indicated on the label. If you are not sure of the type of power supply to your home, consult your dealer or local power company.
- Use the appropriate power plug which complies with your local power standard.
- Do not overload power strips and extension cords. Overloading can result in fire or electric shock.
- Avoid dust, humidity, and temperature extremes. Do not place the monitor in any area where it may become wet. Place the monitor on a stable surface.
- Unplug the unit during a lightning storm or if it will not be used for a long period of time. This will protect the monitor from damage due to power surges.
- Never push objects or spill liquid of any kind into the slots on the monitor cabinet.
- To ensure satisfactory operation, in case use at a PC then it should use the monitor only with computers which have appropriate configured receptacles marked between 100-240V AC.
- If you encounter technical problems with the monitor, contact a qualified service technician or your retailer.
- The wall socket shall be installed near the equipment and shall be easily accessible.

Care & Cleaning

- Before you lift or reposition your monitor, it is better to disconnect the cables and power cord. Follow the correct lifting techniques when positioning the monitor. When lifting or carrying the monitor, grasp the edges of the monitor. Do not lift the display by the stand or the cord.
- Cleaning. Turn your monitor off and unplug the power cord. Clean the monitor surface with a lint-free, non-abrasive cloth. Stubborn stains may be removed with a cloth dampened with mild cleaner.
- Avoid using a cleaner containing alcohol or acetone. Use a cleaner intended for use with the LCD. Never spray cleaner directly on the screen, as it may drip inside the monitor and cause an electric shock.

The following symptoms are normal with the monitor:

- The screen may flicker during the initial use due to the nature of the fluorescent light. Turn off the Power Switch and turn it on again to make sure that the flicker disappears.
- You may find slightly uneven brightness on the screen depending on the desktop pattern you use.
- When the same image is displayed for hours, an afterimage of the previous screen may remain after switching the image. The screen will recover slowly or you can turn off the Power Switch for hours.
- When the screen becomes black or flashes, or cannot work anymore, contact your dealer or service center to fix it. Do not repair the screen by yourself!

Conventions used in this guide



WARNING: Information to prevent injury to yourself when trying to complete a task.



CAUTION: Information to prevent damage to the components when trying to complete a task.



IMPORTANT: Information that you **MUST** follow to complete a task.



NOTE: Tips and additional information to aid in completing a task.

Where to find more information

Refer to the following sources for additional information and for product and software updates.

1. ASUS websites

The ASUS websites worldwide provide updated information on ASUS hardware and software products. Refer to <http://www.asus.com>

2. Optional documentation

Your product package may include optional documentation that may have been added by your dealer. These documents are not part of the standard package.

1.1 Welcome!

Thank you for purchasing the ASUS® VW197 Series LCD monitor!

The latest widescreen LCD monitor from ASUS provides a crisper, broader, and brighter display, plus a host of features that enhance your viewing experience.

With these features, you can enjoy the convenience and delightful visual experience that the VW197 Series brings you!

1.2 Package contents

Check your VW197 Series LCD Monitor package for the following items:

- ✓ LCD monitor
- ✓ Monitor stand and base
- ✓ User manual CD
- ✓ Quick start guide
- ✓ Warranty card
- ✓ Power cord
- ✓ VGA cable
- ✓ Audio cable (VW197T/TR/S/SR)
- ✓ Cable holder (VW197TR/NR/SR/DR)



-
- If any of the above items is damaged or missing, contact your retailer immediately.
-

1.3 Assembling the monitor

To assemble the monitor:

1. Have the front of the monitor face down on a table.
2. Insert the stand to the monitor which shows as below picture.
3. Connect the base with the monitor. A click indicates that the base has been connected successfully.
4. Adjust the monitor to the angle that is most comfortable.



- We recommend that you cover the table surface with soft cloth to prevent damage to the monitor.

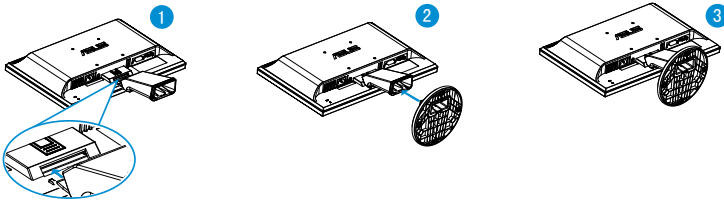

1.4 Monitor introduction

1.4.1 Front of the LCD monitor

1.4.1.1 VW197T/VW197TR/VW197S/VW197SR

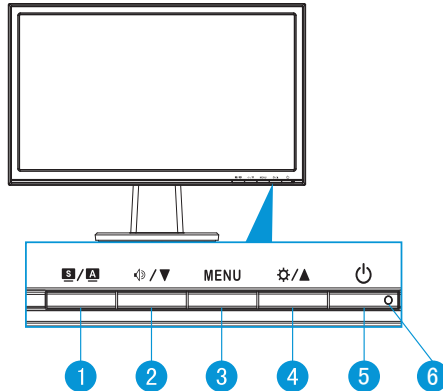

1. **S / A** Button:
 - Automatically adjust the image to its optimized position, clock, and phase by long pressing this button for 2-4 seconds (for VGA mode only).
 - Use this hot key to switch from six video preset modes (Scenery Mode, Standard Mode, Theater Mode, Game Mode, Night View Mode, and sRGB Mode) with SPLENDID™ Video Intelligence Technology.
 - Exit the OSD menu or go back to the previous menu as the OSD menu is active.
2. **Speaker / ▼** Button:
 - Press this button to decrease the value of the function selected or move to the next function.
 - This is also a hot key for Volume adjustment.
3. **MENU** Button:
 - Press this button to enter the OSD menu.
 - Press this button to enter/select the icon (function) highlighted while the OSD is activated.
4. **⚙ / ▲** Button:
 - Press this button to increase the value of the function selected or move right/up to the next function.
 - This is also a hot key for Brightness adjustment.
5. **⏻** Power Button:
 - Press this button to turn the monitor on/off.

6. Power Indicator

- The color definition of the power indicator is as the below table.

Status	Description
Blue	ON
Amber	Standby mode
OFF	OFF

1.4.1.2 VW197N/VW197NR/VW197D/VW197DR

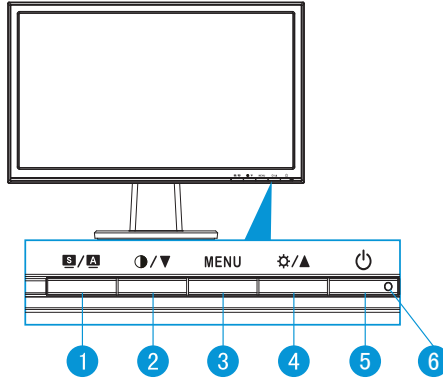

1. **S / A** Button:
 - Automatically adjust the image to its optimized position, clock, and phase by long pressing this button for 2-4 seconds (for VGA mode only).
 - Use this hot key to switch from six video preset modes (Scenery Mode, Standard Mode, Theater Mode, Game Mode, Night View Mode, and sRGB Mode) with SPLENDID™ Video Intelligence Technology.
 - Exit the OSD menu or go back to the previous menu as the OSD menu is active.
2. **O / ▼** Button:
 - Press this button to decrease the value of the function selected or move to the next function.
 - This is also a hot key for Contrast adjustment.
3. **MENU** Button:
 - Press this button to enter the OSD menu.
 - Press this button to enter/select the icon (function) highlighted while the OSD is activated.
4. **⚙️ / ▲** Button:
 - Press this button to increase the value of the function selected or move right/up to the next function.
 - This is also a hot key for Brightness adjustment.

5.  Power Button:
 - Press this button to turn the monitor on/off.
6. Power Indicator
 - The color definition of the power indicator is as the below table.

Status	Description
Blue	ON
Amber	Standby mode
OFF	OFF

1.4.2 Rear of the LCD monitor

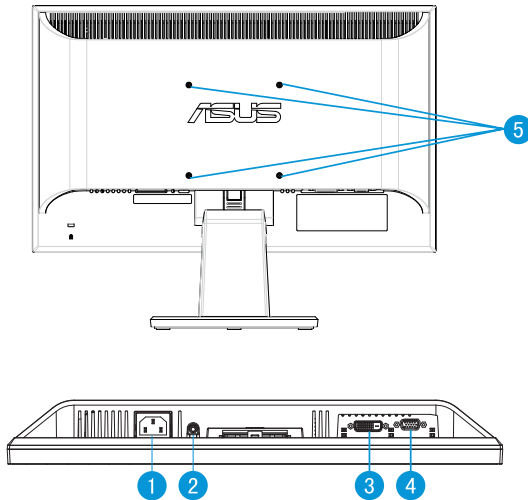

1	AC-IN port
2	Audio Line-in port (VW197T/TR/S/SR)
3	DVI port (VW197T/TR/N/NR)
4	VGA port
5	Screw Holes for VESA Wall Mount

1.4.3 Wiring to comply with TCO Certified (VW197TR/VW197NR/VW197SR/VW197DR)

1. Connect the power cord and signal cable.
2. Tie the power cord and signal cable with cable holder.



-
- The location of holder should be about 10cm away from one end of the power cord and cable.
-

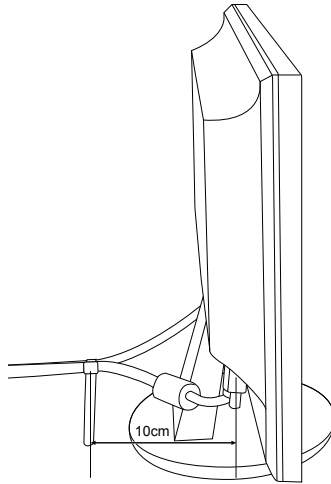

2.1. Detaching the arm/stand (for VESA wall mount)

The detachable stand of the VW197 Series LCD monitor is specially designed for VESA wall mount.

To detach the arm/stand:

1. Have the front of the monitor face down on a table.
2. Press the plastic release button on the rear of the monitor shows as below picture.
3. Detach the stand from the monitor.



- We recommend that you cover the table surface with soft cloth to prevent damage to the monitor.

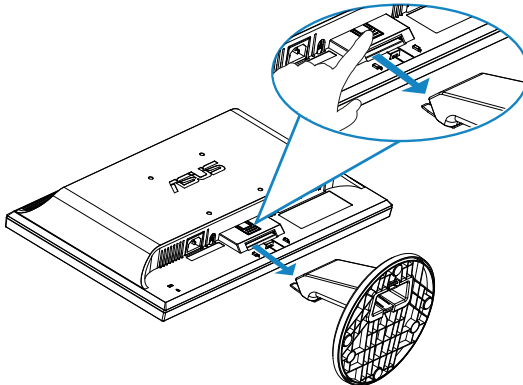

- The VESA wall mount kit (100 x 100 mm) is purchased separately.

2.2. Adjusting the monitor

- For optimal viewing, we recommend that you look at the full face of the monitor, then adjust the monitor to the angle that is most comfortable for you.
- Hold the stand to prevent the monitor from falling while changing its angle.
- You can adjust the monitor's angle from -5° to 20° .

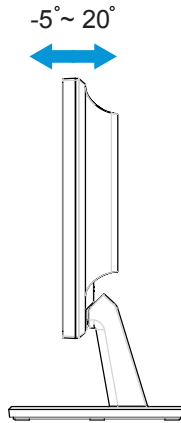

3.1 OSD (On-Screen Display) menu

3.1.1 How to reconfigure

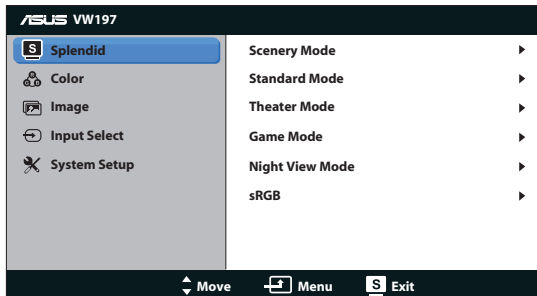

1. Press the MENU button to activate the OSD menu.
2. Press ▼ and ▲ to navigate through the functions. Highlight and activate the desired function by pressing the MENU button. If the function selected has a sub-menu, press ▼ and ▲ again to navigate through the sub-menu functions. Highlight and activate the desired sub-menu function by pressing the MENU button.
3. Press ▼ and ▲ to change the settings of the selected function.
4. To exit the OSD menu, press the **S** button. Repeat step 2 and step 3 to adjust any other function.

3.1.2 OSD Function Introduction

1. Splendid

This function contains six sub-functions that you can select for your preference. Each mode has the Reset selection, allowing you to maintain your setting or return to the preset mode.

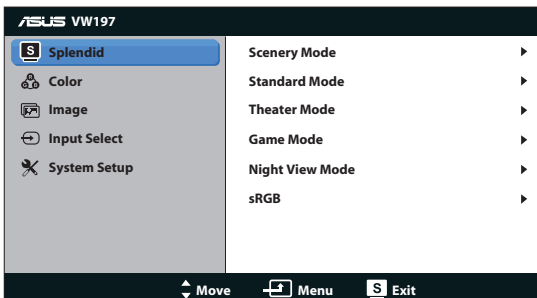

- **Scenery Mode:** This is the best choice for scenery photo displaying with SPLENDID™ Video Intelligence Technology.

- **Standard Mode:** This is the best choice for document editing with SPLENDID™ Video Intelligence Technology.
- **Theater Mode:** This is the best choice for movie watching with SPLENDID™ Video Intelligence Technology.
- **Game Mode:** This is the best choice for game playing with SPLENDID™ Video Intelligence Technology.
- **Night View Mode:** This is the best choice for playing dark-scene game or watching dark-scene movie with SPLENDID™ Video Intelligence Technology.
- **sRGB:** This is the best choice for viewing photos and graphics from PCs.



- In the **Standard Mode**, the **Saturation, Skin Tone, Sharpness, ASCR** are not user-configurable.
- In the **sRGB**, the **Brightness, Contrast, Saturation, Color Temp, Skin Tone** and **ASCR** are not user-configurable.

2. Color

Select the image color you like from this function.

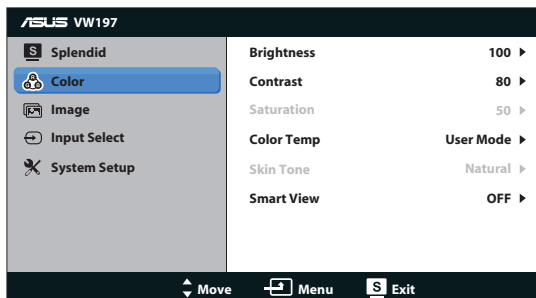

- **Brightness:** The adjusting range is from 0 to 100.
- **Contrast:** The adjusting range is from 0 to 100.
- **Saturation:** The adjusting range is from 0 to 100.
- **Color Temp.:** Contain three preset color modes (Cool, Normal, Warm) and one User Mode.
- **Skin Tone:** Contain three color modes including Reddish, Natural, and Yellowish.
- **Smart View:** Turn the Smart View Function on or off.



- In the User Mode, colors of R (Red), G (Green), and B (Blue) are user configurable; the adjusting range is from 0 ~ 100.

3. Image

You can adjust the image Sharpness, Aspect Control, ASCR, Position (VGA only), and Focus (VGA only) from this main function.

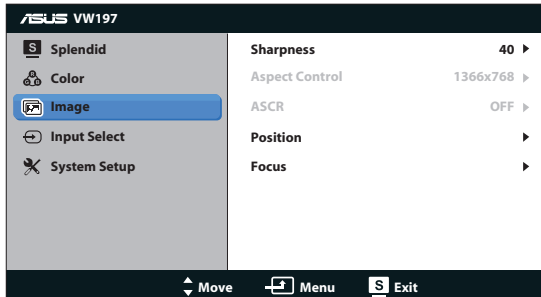

- **Sharpness:** Adjust the picture sharpness. The adjusting range is from 0 to 100.
- **Aspect Control:** Adjust the aspect ratio to “1366x768”, “1360x768” or “4:3”.
- **ASCR:** Select ON or OFF to enable or disable dynamic contrast ratio function.
- **Position:** Adjust the horizontal position (H-Position) and the vertical position (V-Position) of the image. The adjusting range is from 0 to 100 (Only available for VGA input).
- **Focus:** Reduce Horizontal-line noise and Vertical-line noise of the image by adjusting (Phase) and (Clock) separately. The adjusting range is from 0 to 100 (Only available for VGA input).

4. Input Select

Select the input source from VGA or DVI (VW197T/TR/N/NR).

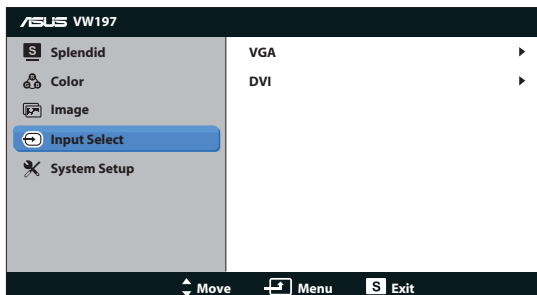

5. System Setup

Adjust the system configuration.

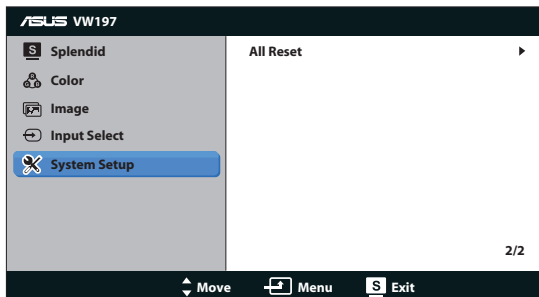
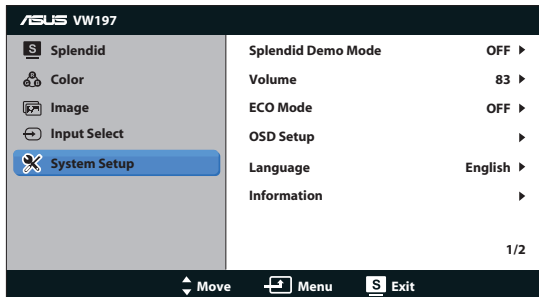





- **Splendid Demo Mode:** Activate the demo mode for the Splendid function.
- **Volume:** Adjust the Volume level of speakers (VW197T/TR/S/SR).
- **ECO Mode:** Turn the ECO Mode Function on or off.
- **OSD Setup:** Adjust the horizontal position (H-Position), vertical position (V-Position), OSD Timeout, DDC/CI, and Transparency of the OSD screen.
- **Language:** Select OSD language. The selections are English, French, German, Spanish, Italian, Dutch, Russian, Traditional Chinese, Simplified Chinese, Japanese and Korean.
- **Information:** Display the monitor information.
- **All Reset:** Select “Yes” to revert all settings to the factory default mode.

3.2 Specifications

Model	VW197T/TR/N/NR/S/SR/D/DR
Panel Size	18.5"W (47.0cm)
Max. Resolution	1366x768
Backlight Tech.	LED Backlight Technology
Brightness (Typ.)	250cd/m ²
Intrinsic Contrast Ratio (Typ.)	1000:1
Viewing Angle (H/V), (CR≥10)	170°/160°
Display Colors	16.7 M
Response Time	5ms (Tr+Tf)
Analog Input	D-Sub
Digital Input	DVI(VW197T/TR/N/NR only)
Speaker (Build-in)	1W x 2 (VW197T/TR/S/SR only)
Tilt	-5° ~ +20°
VESA Wall Mounting	Yes (100mm x 100mm)
Phys. Dimension (WxHxD)	445x370x185mm
Box Dimension (WxHxD)	507x150x322mm
Net Weight (Esti.)	3.1 kg
Gross Weight (Esti.)	4.9 kg
Voltage Rating	AC 100~240V(Built-in)

3.3 Troubleshooting (FAQ)

Problem	Possible Solution
Power LED is not ON	<ul style="list-style-type: none"> • Press the  button to check if the monitor is in the ON mode. • Check if the power cord is properly connected to the monitor and the power outlet.
The power LED lights amber and there is no screen image	<ul style="list-style-type: none"> • Check if the monitor and the computer are in the ON mode. • Make sure the signal cable is properly connected the monitor and the computer. • Inspect the signal cable and make sure none of the pins are bent. • Connect the computer with another available monitor to check if the computer is properly working.
Screen image is too light or dark	<ul style="list-style-type: none"> • Adjust the Contrast and Brightness settings via OSD.
Screen image is not centered or sized properly	<ul style="list-style-type: none"> • Press the  /  button for two seconds to automatically adjust the image (for VGA input only). • Adjust the H-Position or V-Position settings via OSD (for VGA input only).
Screen image bounces or a wave pattern is present in the image	<ul style="list-style-type: none"> • Make sure the signal cable is properly connected to the monitor and the computer. • Move electrical devices that may cause electrical interference.
Screen image has color defects (white does not look white)	<ul style="list-style-type: none"> • Inspect the signal cable and make sure that none of the pins are bent. • Perform All Reset via OSD. • Adjust the R/G/B color settings or select the Color Temperature via OSD.
Screen image is blurry or fuzzy	<ul style="list-style-type: none"> • Press the  /  button for two seconds to automatically adjust the image (for VGA input only). • Adjust the Phase and Clock settings via OSD.
No sound or sound is low (VW197T/TR/S/SR)	<ul style="list-style-type: none"> • Ensure that the audio cable is properly connected to the monitor and the computer. • Adjust the volume settings of both your monitor and computer. • Ensure that the computer sound card driver is properly installed and activated.

3.4 Supported timing list

PC Supported Primary Timing				
Mode	Resolution	H(KHz)	V(Hz)	Pixel (MHz)
VGA	640x480	31.469	60	25.175
	640x480	37.861	72	31.5
	640x480	37.5	75	31.5
SVGA	800x600	35.156	56	36
	800x600	37.879	60	40
	800x600	48.077	72	50
	800x600	46.875	75	49.5
XGA	1024x768	48.363	60	65
	1024x768	56.476	70	75
	1024x768	60.023	75	78.75
WXGA+	1366x768	47.712	60	85.5
IBM Modes, Factory Preset Timing				
Mode	Resolution	H(KHz)	V(Hz)	Pixel (MHz)
DOS	640x350	31.469	70	25.175
DOS	720x400	31.469	70	28.322
MAC Modes, Factory Preset Timing				
Mode	Resolution	H(KHz)	V(Hz)	Pixel (MHz)
VGA	640x480	35	67	30.24
SVGA	832x624	49.725	75	57.2832