



CRW-5224A-U
External CD-RW
52x/24x/52x CD-RW Drive

User's Manual



Copyrights/Disclaimer

Copyright © 2002 ASUSTeK COMPUTER INC. All Rights Reserved.

No part of this manual, including the products and software described in it, may be reproduced, transmitted, transcribed, stored in a retrieval system, or translated into any language in any form or by any means, except documentation kept by the purchaser for backup purposes, without the express written permission of ASUSTeK COMPUTER INC. ("ASUS").

ASUS PROVIDES THIS MANUAL "AS IS" WITHOUT WARRANTY OF ANY KIND, EITHER EXPRESS OR IMPLIED, INCLUDING BUT NOT LIMITED TO THE IMPLIED WARRANTIES OR CONDITIONS OF MERCHANTABILITY OR FITNESS FOR A PARTICULAR PURPOSE. IN NO EVENT SHALL ASUS, ITS DIRECTORS, OFFICERS, EMPLOYEES OR AGENTS BE LIABLE FOR ANY INDIRECT, SPECIAL, INCIDENTAL, OR CONSEQUENTIAL DAMAGES (INCLUDING DAMAGES FOR LOSS OF PROFITS, LOSS OF BUSINESS, LOSS OF USE OR DATA, INTERRUPTION OF BUSINESS AND THE LIKE), EVEN IF ASUS HAS BEEN ADVISED OF THE POSSIBILITY OF SUCH DAMAGES ARISING FROM ANY DEFECT OR ERROR IN THIS MANUAL OR PRODUCT.

Product warranty or service will not be extended if: (1) the product is repaired, modified or altered, unless such repair, modification or alteration is authorized in writing by ASUS; or (2) the serial number of the product is defaced or missing.

The product name and revision number are both printed on the product itself. Manual revisions are released for each product design represented by the digit before and after the period of the manual revision number. Manual updates are represented by the third digit in the manual revision number.

SPECIFICATIONS AND INFORMATION CONTAINED IN THIS MANUAL ARE FURNISHED FOR INFORMATIONAL USE ONLY, AND ARE SUBJECT TO CHANGE AT ANY TIME WITHOUT NOTICE, AND SHOULD NOT BE CONSTRUED AS A COMMITMENT BY ASUS. ASUS ASSUMES NO RESPONSIBILITY OR LIABILITY FOR ANY ERRORS OR INACCURACIES THAT MAY APPEAR IN THIS MANUAL, INCLUDING THE PRODUCTS AND SOFTWARE DESCRIBED IN IT.

Products and corporate names appearing in this manual may or may not be registered trademarks or copyrights of their respective companies, and are used only for identification or explanation and to the owners' benefit, without intent to infringe.

Product Name:	ASUS External CD-RW Drive (CRW-5224A-U)
Manual Version:	First Edition V1 E1134
Release Date:	December 2002

Contents

Copyrights/Disclaimer	2
FCC/CDC Statements	4
ASUS Contact Information	5
Safety Information	6
Installation Notices	6
Using the Device	7
Package Contents	8
Welcome!	9
Product Introduction	9
Features	9
Front Panel	12
Rear Panel	13
Installation	14
System Requirements	14
Setting the Jumper Terminals	15
Installing the CD-RW Drive	16
Connecting the Drive Cables	18
Installing CRW-5224A-U driver.....	18
Checking the drive in the System Properties.....	20
Properly unplugging CRW-5224A-U device	21
CD-RW Drive Basics	22
Placing a Disc into the Drive	22
Ejecting a Disc from the Drive	23
Using the Emergency Eject Pinhole	24
Using Compact Discs	25
Cleaning a Disc	25
Handling a Disc	25
Technical Information	26
Environmental Specifications	26
Electrical and Audio Specifications	26

FCC/CDC Statements

Federal Communications Commission Statement

This device complies with FCC Rules Part 15. Operation is subject to the following two conditions:

- This device may not cause harmful interference, and
- This device must accept any interference received including interference that may cause undesired operation.

This equipment has been tested and found to comply with the limits for a Class B digital device, pursuant to Part 15 of the FCC Rules. These limits are designed to provide reasonable protection against harmful interference in a residential installation. This equipment generates, uses and can radiate radio frequency energy and, if not installed and used in accordance with manufacturer's instructions, may cause harmful interference to radio communications. However, there is no guarantee that interference will not occur in a particular installation. If this equipment does cause harmful interference to radio or television reception, which can be determined by turning the equipment off and on, the user is encouraged to try to correct the interference by one or more of the following measures:

- Reorient or relocate the receiving antenna.
- Increase the separation between the equipment and receiver.
- Connect the equipment to an outlet on a circuit different from that to which the receiver is connected.
- Consult the dealer or an experienced radio/TV technician for help.

WARNING! *The use of shielded cables for connection of the monitor to the graphics card is required to assure compliance with FCC regulations. Changes or modifications to this unit not expressly approved by the party responsible for compliance could void the user's authority to operate this equipment.*

Canadian Department of Communications Statement

This digital apparatus does not exceed the Class B limits for radio noise emissions from digital apparatus set out in the Radio Interference Regulations of the Canadian Department of Communications.

This class B digital apparatus complies with Canadian ICES-003.

ASUS Contact Information

ASUSTeK COMPUTER INC. (Asia-Pacific)

Address: 150 Li-Te Road, Peitou, Taipei, Taiwan 112
General Tel: +886-2-2894-3447
General Fax: +886-2-2894-3449
General Email: info@asus.com.tw

Technical Support

MB/Optical Drives (Tel): +886-2-2890-7121 (English)
Notebook (Tel): +886-2-2890-7122 (English)
Desktop/Server (Tel): +886-2-2890-7123 (English)
Support Fax: +886-2-2890-7698
Support Email: tsd@asus.com.tw
Web Site: www.asus.com
Newsgroup: cscnews.asus.com.tw

ASUS COMPUTER INTERNATIONAL (America)

Address: 6737 Mowry Avenue, Mowry Business Center,
Building 2, Newark, CA 94560, USA
General Fax: +1-510-608-4555
General Email: tmd1@asus.com

Technical Support

Support Fax: +1-510-608-4555
General Support: +1-502-933-8713
Notebook Support: +1-877-918-ASUS (2787)
Web Site: www.asus.com
Support Email: tsd@asus.com

ASUS COMPUTER GmbH (Germany and Austria)

Address: Harkortstr. 25, 40880 Ratingen, BRD, Germany
General Fax: +49-2102-442066
General Email: sales@asuscom.de (for marketing requests only)

Technical Support

Support Hotline: MB/Optical Drives: +49-2102-9599-0
Notebook (Tel): +49-2102-9599-10
Support Fax: +49-2102-9599-11
Support (Email): www.asuscom.de/de/support (for online support)
Web Site: www.asuscom.de

Safety Information

Observe the following precautions before installing and using the ASUS External CD-RW (CRW-5224A-U) Drive!

Installation Notices

Do not place this device in an unstable position, or in one that vibrates.

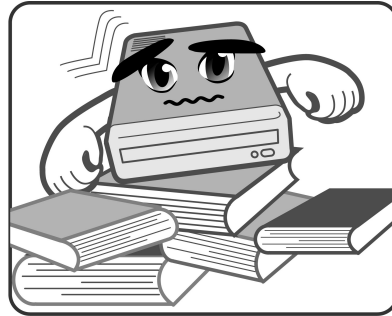

Do not place this device in areas where there is direct sunlight, high humidity, or damp condition.

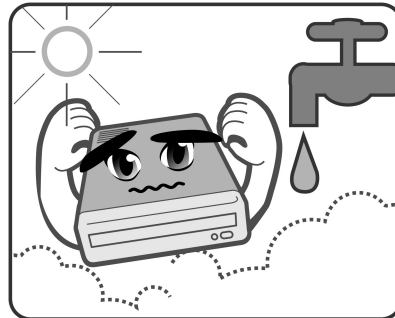

Do not use or place this device near magnetic fields, televisions, or radios, where there is interference that may affect the performance of the drive.

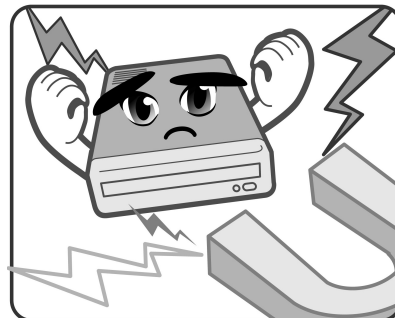

Do not attempt to disassemble or repair the drive. Opening the drive may result to exposure to laser radiation.

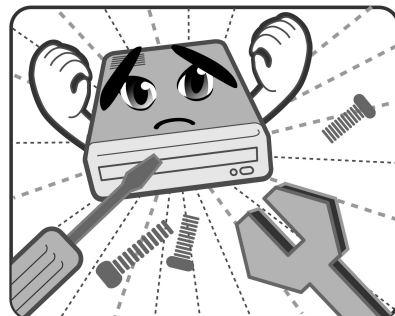

Safety Information

Using the Device

- Use of any controls, adjustments, or procedures other than those specified in this manual may result to hazardous radiation exposure.
- Do not attempt to disassemble the drive.
- Do not move the device from a cold to a warm or hot environment. Drastic change of temperature is harmful to the device.
- Before moving or uninstalling the drive, remove disc from it, if any.
- Prevent liquids or any metal to get into the device. If this situation occurs, contact your retailer for help.
- Do not use any evaporating solvents to clean the device. If you accidentally sprayed any solvent on the device, use a clean cloth to wipe it. You may also use a neutral cleaner to dilute the solvent to easily wipe it from the device.
- Try not to interrupt the supply of power while the device is in reading or writing mode.
- Do not place damaged or warped discs inside the device. A warped disc may break while in use and damage the device.
- Do not place discs into the device immediately if they came from a cold environment, specially during cold seasons. Wait until the discs have reached room temperature.

Conventions used in this guide

To make sure that you perform certain tasks properly, take note of the following symbols used throughout this manual.



WARNING/DANGER: Information to prevent injury to yourself when trying to complete a task.

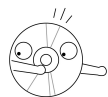

CAUTION: Information to prevent damage to the components when trying to complete a task.



IMPORTANT: Information that you **MUST** follow to complete a task.

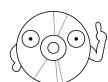

NOTE: Tips and additional information to aid in completing a task.

Package Contents

Upon opening your ASUS External CD-RW (CRW-5224A-U) drive package, check if all the following items are present and in good condition. If any of the items is damaged or missing, contact your retailer immediately.

- ASUS External CD-RW drive (CRW-5224A-U)
- ASUS External CD-RW drive stand
- USB 2.0 cable
- Power cable and adapter
- Emergency eject pin and instruction
- ASUS High-Speed CD-R blank disc
- ASUS Ultra-Speed CD-RW blank disc
- User's Manual (English and Traditional Chinese)
- Multi-language quick installation poster
- Bundled software CD
 - CD recording software
 - Win98SE USB 2.0 driver

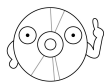

The above items are available in retail boxes only.

Welcome!

Thank you for buying the **ASUS External (CRW-5224A-U) Drive!**

To ensure proper installation and use of this device, read the instructions and other important information contained in this manual.

Product Introduction

Specifications

The CRW-5224A-U has the following specifications.

- **Speeds**
 - CD-R Write Speed 52x, 48x, 40x, 32x, 24x, 16x, 12x, 8x, 4x
 - CD-RW Write Speed 24x, 16x, 12x, 10x, 8x, 4x, 2x
 - Read Speed 52x max (CAV)~7800 KB/Sec
 - DAE Speed 52x max (CAV)~7800 KB/Sec
 - Random Access Time 100 ms
- **Interface** USB 2.0
- **Technology support** *FlextraSpeed™* Technology
FlextraLink™ Technology
Double Dynamic Suspension System II (DDSS II)
CAV Recording Technology
- **Buffer Memory Size** 2 MB
- **Application discs** 12cm or 8 cm diameter, 1.2mm thick
CD-Audio, CD-ROM, CD-ROM/XA, CD-I,
Mixed Mode CD-ROM, Photo CD, CD-Extra,
Video CD, CD-Text, DVCD, CD-G, Karaoke
CD, I-trax, Bootable CD
- **Writing Mode** Track-at-Once, Disc-at-Once,
Session-at-Once, Multi-Session, Packet Write,
DAO-RAW Mode
- **Dimensions** 155.6 (w) x 226 (d) x 50 (h) mm
- **Mass** 1398 g (3.08 lbs)

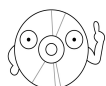

Refer to the section “Technical Information” on page 26 for detailed specifications.

Features

The ASUS CRW-5224A-U is an External CD-RW drive with 52x Write, 24x ReWrite and 52x Read capabilities. The drive complies with the Universal Serial Bus 2.0 (USB 2.0) specifications and comes equipped with the latest innovative technologies in CD recording.

ASUS External CD-RW drives are accentuated by the latest innovations in CD-recording technology, namely: *FlextraSpeed*[™], *FlextraLink*[™], DDSS II (Double Dynamic Suspension System II) and the Constant Angular Velocity (CAV) recording method.

The following sub-sections describe these technologies in detail.

***FlextraSpeed*[™] Technology**

The ASUS *FlextraSpeed*[™] technology provides the optimum solution to ensure quality recording when using discs that require flexible speeds. The CRW-5224A-U drive employs this technology that allows automatic recording speed adjustment based on the recording media.

In addition to the fact that there are low and high quality recording media, various other factors such as dye layer, temperature, humidity, dust, fingerprints, etc., affect the recording characteristics of CD-R and CD-RW discs. Due to these factors, some discs may not be able to stand the high-speed capabilities of the latest CD-RW drives. The *FlextraSpeed*[™] technology solves this problem by automatic assessment of the disc quality and recording capability. The recording speed is based on these factors. If you use a high quality recording disc, you can maximize the recording capability of the drive and get the best quality output. If you use a low quality disc, the drive speed adjusts to the level that is most appropriate for the disc, still optimizing the disc recording capability.

The *FlextraSpeed*[™] technology also helps maintain the CD-RW drive because of the controlled motor rotation speeds and reduced noise caused by spindle air, thus prolonging the drive motor's life and ensuring high-quality recording.

FlextraLink™ Technology

The ASUS *FlextraLink™* technology provides a seamless combination of flexibility and ultra-reliable recording quality.

FlextraLink™ incorporates a flexible strategy that prevents buffer underrun problems caused by an empty data buffer. This CD-RW drive technology allows continuous monitoring of the data buffer status during the write process. Once the available data drops to approximately 1% of the total buffer capacity, the drive stops recording and marks the last write position. When new data is received from the host, it is loaded to the data buffer, and the laser is repositioned to link the new data with the data already written. *FlextraLink™* uses minimal system resources so that your PC remains fully operational throughout the writing process, and available for other applications.

The diagram below shows the advantage of the *FlextraLink™* recording technology.

FlextraLink™ Technology Solution

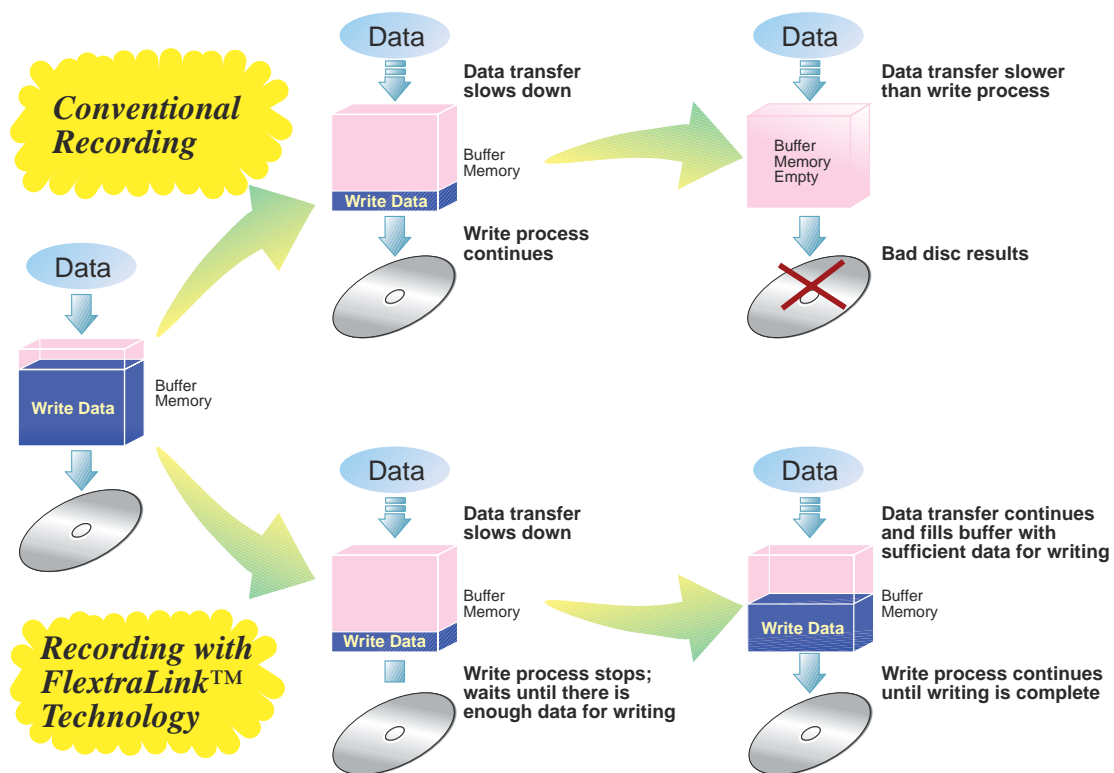



Double Dynamic Suspension System (DDSS II)

The DDSS II is an enhanced follow-up to the DDSS anti-vibration system developed by ASUS. The DDSS CD-ROM technology is designed to reduce the vibration generated from spindle rotation of over 8900 rpm of 40X CD-ROM drives. The DDSS II improves this feature by handling up to over 10,000 rpm of the new 50X drives. In addition, the DDSS II stabilizes the pick-up head of the drive in both horizontal and vertical directions, making tracking and focusing even more precise.

Like the DDSS, the DDSS II vibration absorption structure contains a “dynamic mass” that can absorb the vibration caused by high revolution of spindle motor. However, the DDSS II moves the dynamic mass to be suspended to the chassis, thus providing more stability and accuracy when accessing data from the disc.

The following diagram illustrates the DDSS/DDSS II design structure.

DDSS / DDSS II Design Structure

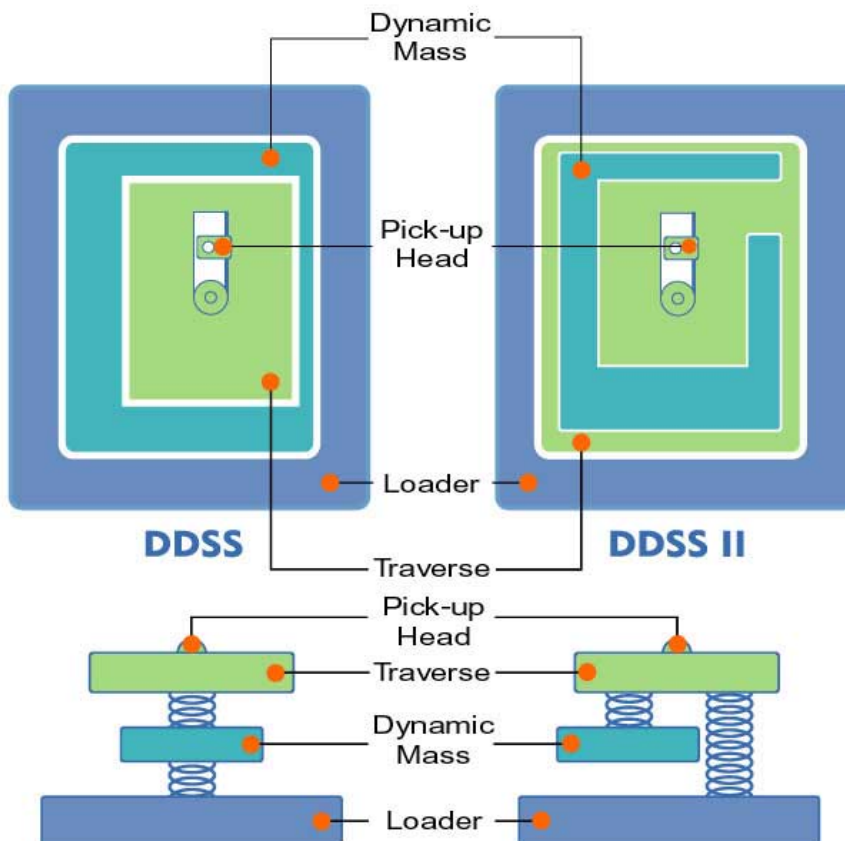

Constant Angular Velocity (CAV) Recording Technology

The CRW-5224A-U drive employs the Constant Angular Velocity (CAV) recording method. With CAV recording, the drive spindle motor rotates the disc at the same speed regardless of the radial position of the pickup head. This means that there is a higher transfer rate when writing data to the outer tracks of the disc than to the inner tracks, as the head traverses a longer linear path on the outer than the inner part of the disc.

Although the transfer rates vary, and may not be at maximum, depending on the part of the disc being written to, the CAV method allows faster recording speed because the rotation speed does not have to change when the head writes data to different areas of the disc. This is primarily advantageous for computer applications.

CAV Recording Method

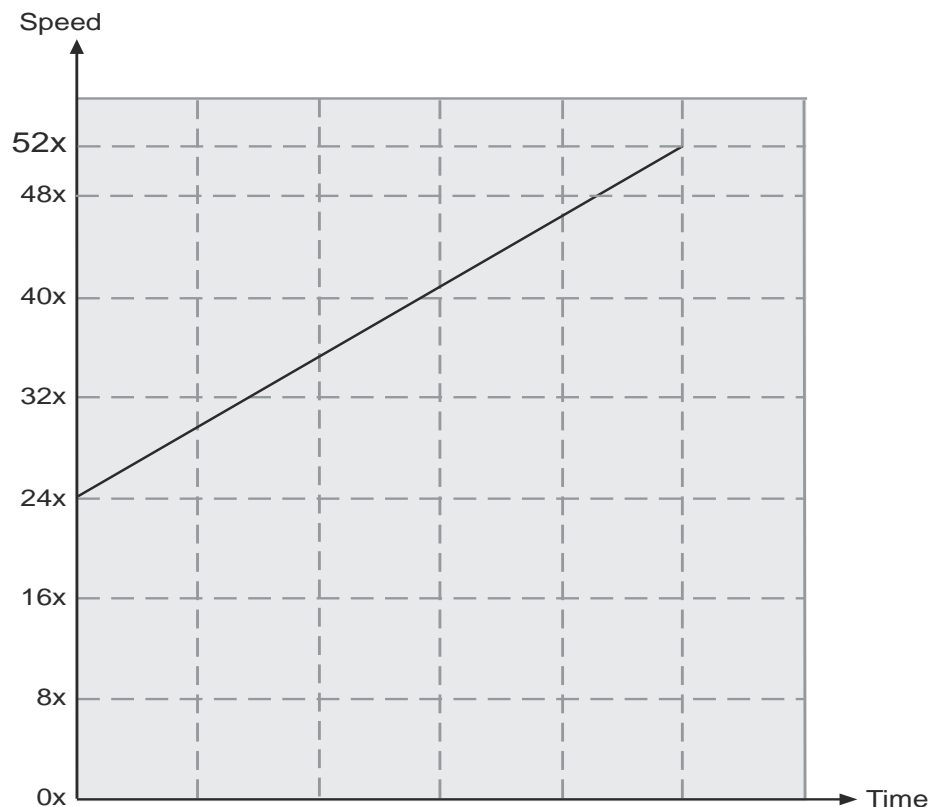

Front Panel

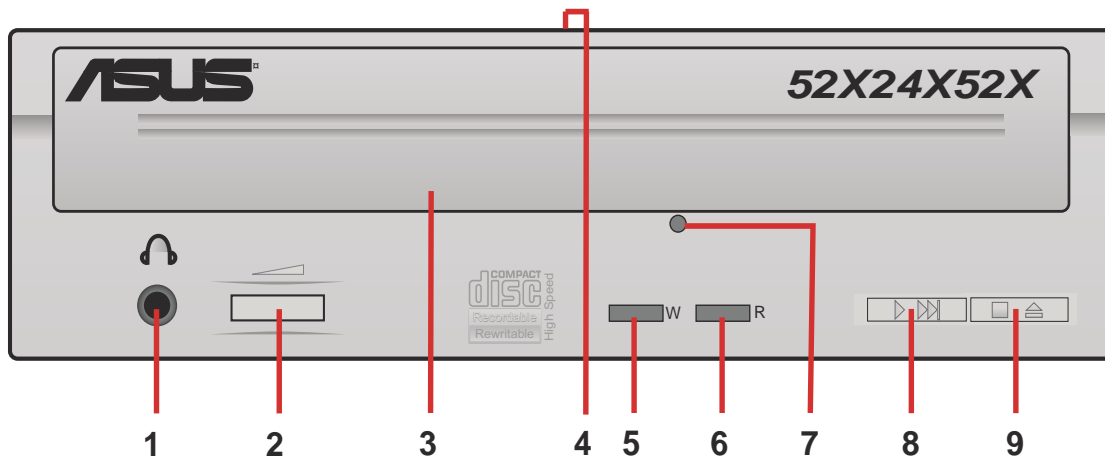

1. Headphone Jack

This jack allows you to connect a headphone with a stereo mini-plug. If you enable *digital CD audio properties* for this device, the audio out function of this jack is disabled.

2. Headphone Volume Dial

To adjust volume of headphone connected, turn dial to the left to decrease volume; turn to the right to increase volume.

3. Disc Tray

This tray holds the disc.

4. Power Indicator

This LED lights green when drive power is ON and turns off when drive power supply is OFF.

5. WRITE Indicator (Red LED)

This LED flashes while data is being written on the disc.

6. READ Indicator (Green LED)

This LED is ON when a disc is present in the drive tray. The LED flashes while data is being read from the disc.

7. Emergency Eject Pinhole

To manually eject the tray and the disc. See page 24, for details on using the emergency eject pinhole.

8. PLAY/SKIP Button

This button has two functions. If the drive is idle, pressing this button will start playing a loaded audio disc from the first track. While in the PLAY mode, pressing this button skips to the next track on the disc.

9. STOP/EJECT Button

This button has two functions. Pressing this button at any time ejects the disc tray. While in PLAY mode, pressing this button stops playing the disc loaded in the drive.

Rear Panel

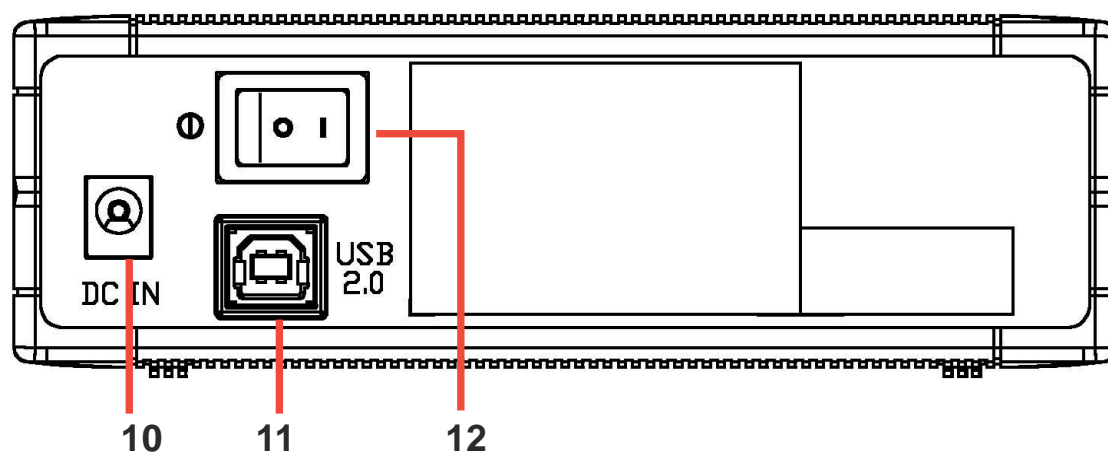

10. 12V Power jack

This jack is for the AC adaptor power cable.

11. USB connector

A standard Universal Serial Bus (USB 2.0) plug and play interface.

12. Power switch

Turns the power supply ON or OFF. Switching to “|” icon means ON and switching to “O” side means OFF.

Installation

System Requirements

Before installing and using the External CD-RW drive, make sure that your computer system meets the following requirements.

- IBM-compatible Pentium II - 333 MHz or higher PC
- Windows 98SE/ME/2000/XP operating system
- At least 64MB RAM (128MB recommended)



*Do not use damaged or warped disc in the CD-RW drive.
The disc may break apart during use and cause potential
body injury or damage to your drive.*

0

Connecting the Drive Cables

1. Connect the USB cord - B series plug to the drive USB 2.0 connector.
2. Connect the USB cord - A series plug to the USB 2.0 connector on your PC.
3. Connect the adapter cable to DC IN power connector.
4. Connect the adapter power cord to the AC adapter.
5. Connect the adapter power cord to a power source.



All the cable plugs are slotted so that they fit in only one orientation. If a plug does not fit in completely, try reversing it. DO NOT use too much force when fitting the cable plugs.

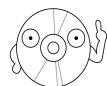
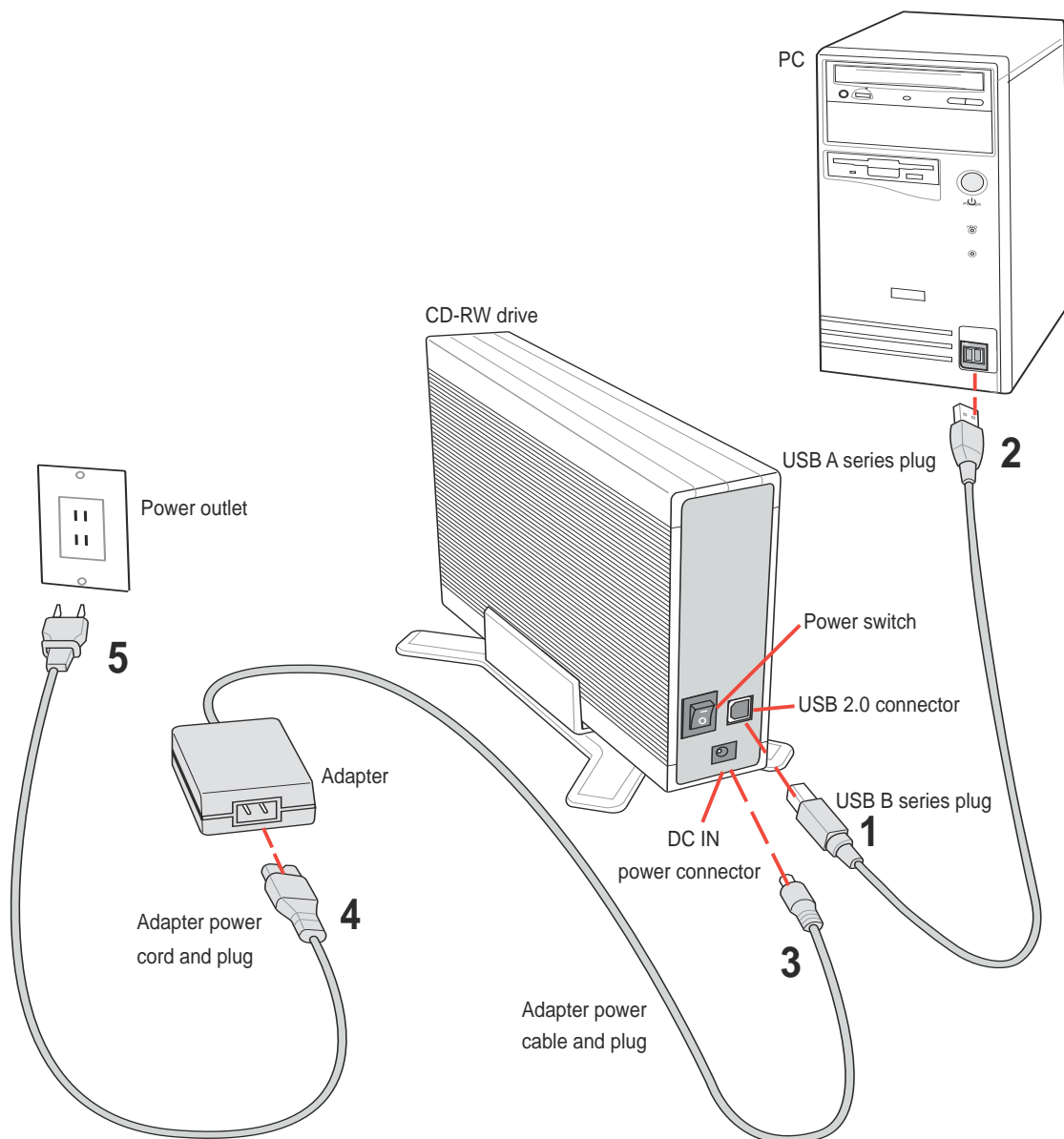

Power plug types may vary in different countries or regions around the world.

For Windows 98SE™ users: Installing the CRW-5224A-U driver

Windows 98 Second Edition users need to install the CRW-5224A-U device driver for the PC to recognize the new hardware installed. A device driver is the software program that makes a device work on an operating system (OS).

Follow these steps to install the CRW-5224A-U driver:

1. Make sure all cable connections to the drive and the PC are properly connected.
2. Boot PC.
3. Insert the bundled software CD in the CD drive of your PC.
4. Turn on the External CRW-5224A-U drive.

5. After boot-up, the OS will detect a new hardware was found. Follow the wizard to copy the driver files to your system.

Click **Next**.



6. Windows 98SE™ can automatically search for the best driver for the device, select (Recommended) option.

Click **Next**.

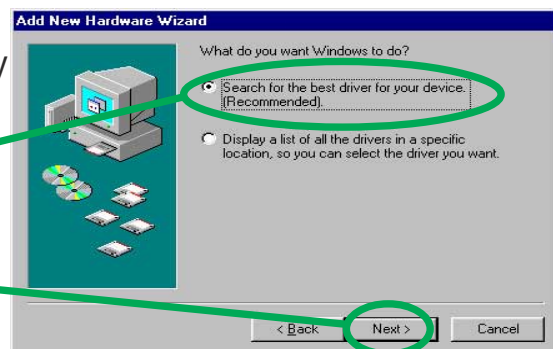

7. Specify the location of the driver .INF file , click on **Browse**.



8. Locate the file folder name “ASUS_RW_USB” in the CD ROM drive.
Click **OK**.

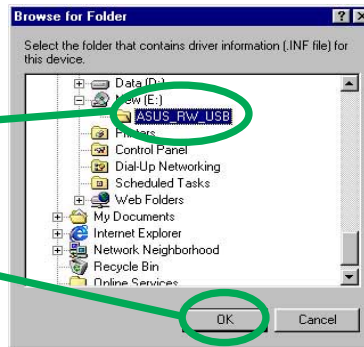

9. The specific location of the drive will appear on the combo list box.
Click **Next**.

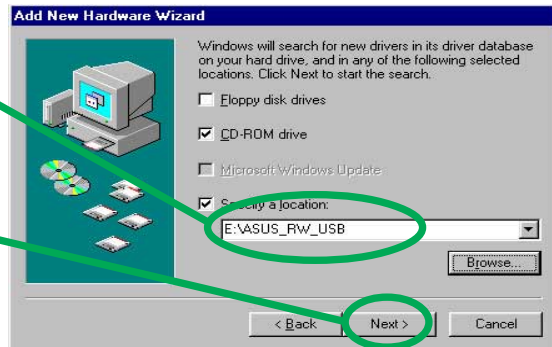

10. After searching, the location of the driver and driver .INF file name is displayed.
Click **Next**.



11. A message box with the installation progress bar is displayed. If cancelled, the installation process has to be repeated from the start.



12. The CRW-5224A-U driver is successfully installed.
Click **Finish** to start using your external drive!

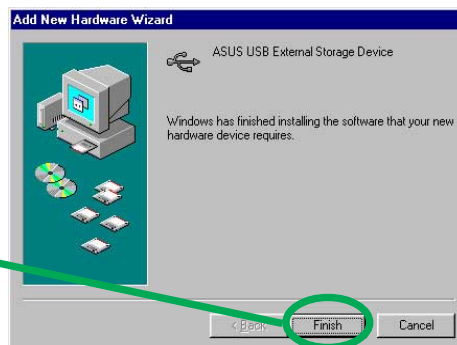

Checking the drive in the System Properties

To make sure the CRW-5224A-U external drive is recognized by the computer, follow these steps to check the computer system properties.

1. Right-click **My Computer** icon on your desktop.
2. On the pop-up menu, click **Properties**.
3. Click the **Device Manager** tab on the system properties dialogue box.
4. Click on CD-ROM from the list.

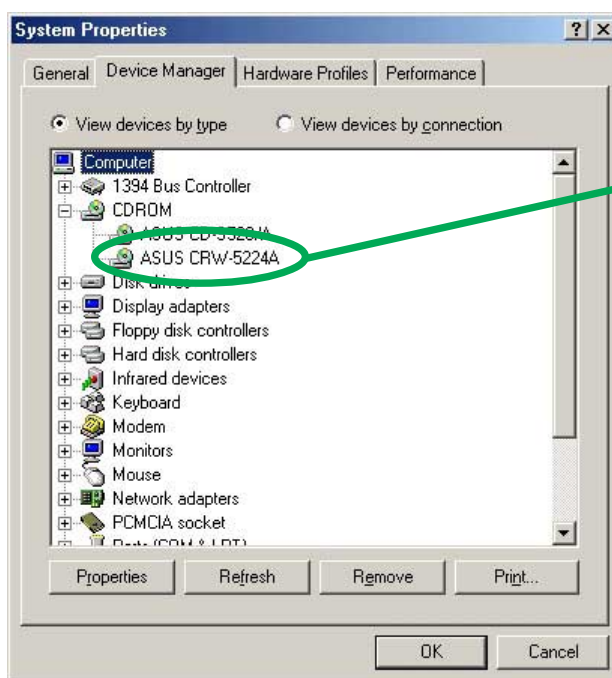

ASUS CRW-5224A drive name should appear here.

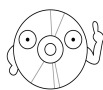

Screen display may vary depending on the operating system (OS) version.

Properly unplugging CRW-5224A-U device

The CRW-5224A-U when installed needs to be properly unplugged or disconnected from the computer to avoid computer to crash or possible data loss.

Follow these steps to safely unplug your CRW-5224A-U drive from the PC.

1. Locate the **Unplug or Eject Hardware** icon found in the taskbar.



Double-click on the icon.

2. Select the name of the hardware device ("ASUS CRW-5224A"), to unplug.

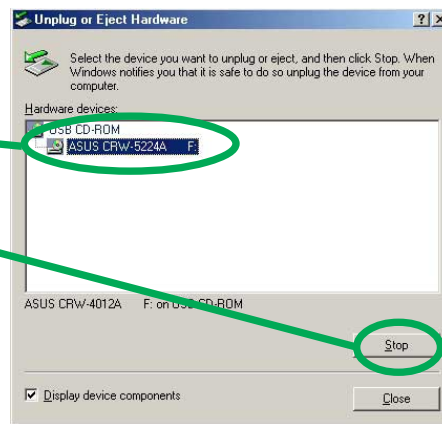

Click **Stop**.

3. Confirm the device to be stopped. Again, select the name of the device you want to unplug.



Click **OK**.

4. The device can now be safely unplugged from the system.



Click **OK**.

5. The screen display will go back to the **Unplug or Eject Hardware** dialogue box. Click on **Close**.

CD-RW Drive Basics

Placing a Disc into the Drive

1. Press the eject button on the front of the drive to eject the tray.

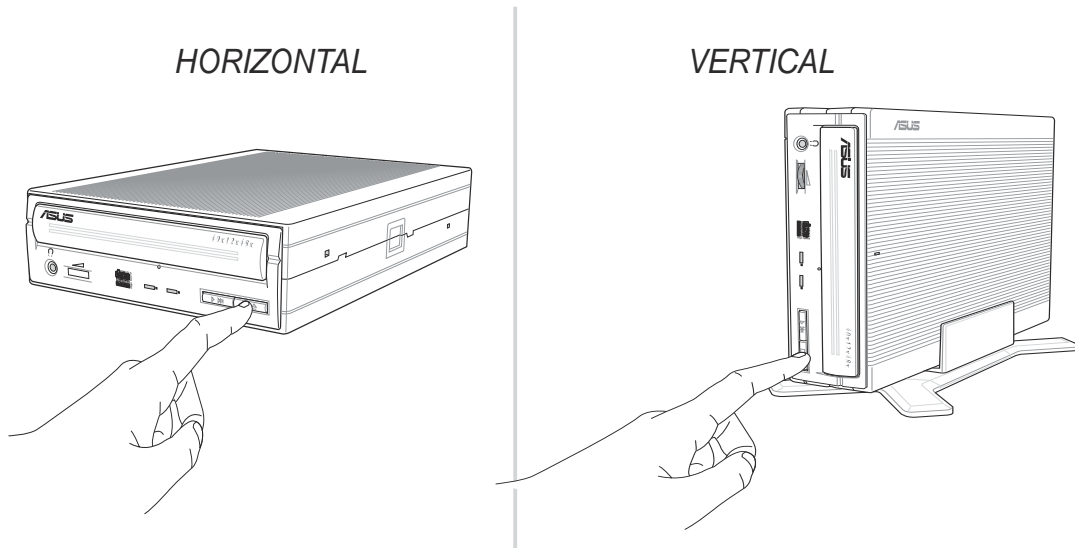

2. When the drive tray ejects out of the drive, place the disc on the tray with the label side facing out.

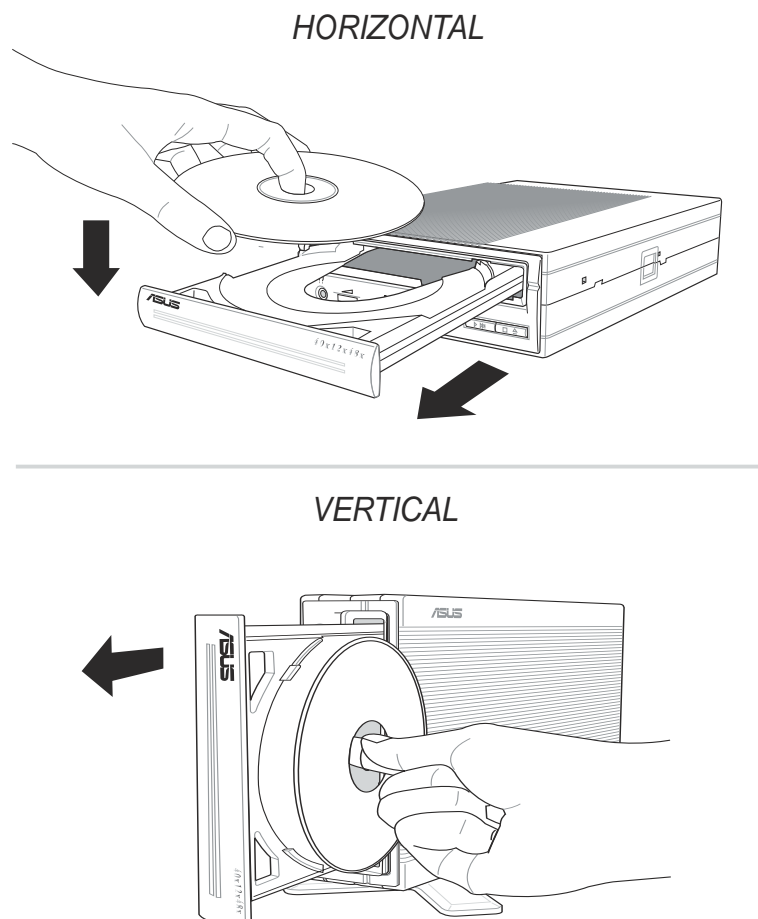

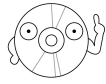

If you are using a 12-cm disc, place it on the tray making sure that it fits the outer circular border. This border helps hold the disc in place. If you are using an 8-cm disc, place it on the inner circular border on the tray. However, 8-cm discs can only be used in horizontal drive mounting orientation.

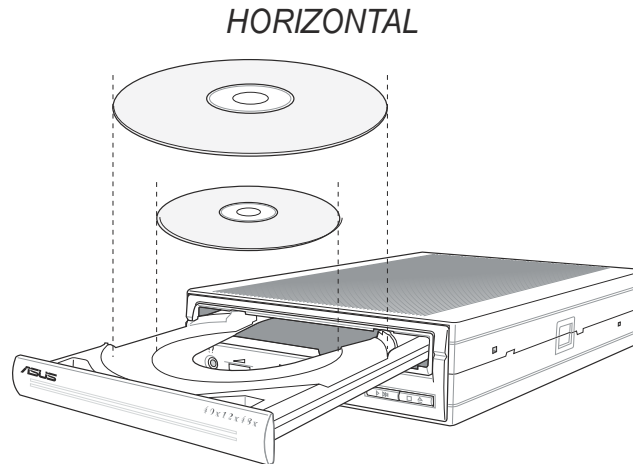

3. Press the drive eject button or lightly push the center of the drive tray to replace the tray inside the drive.

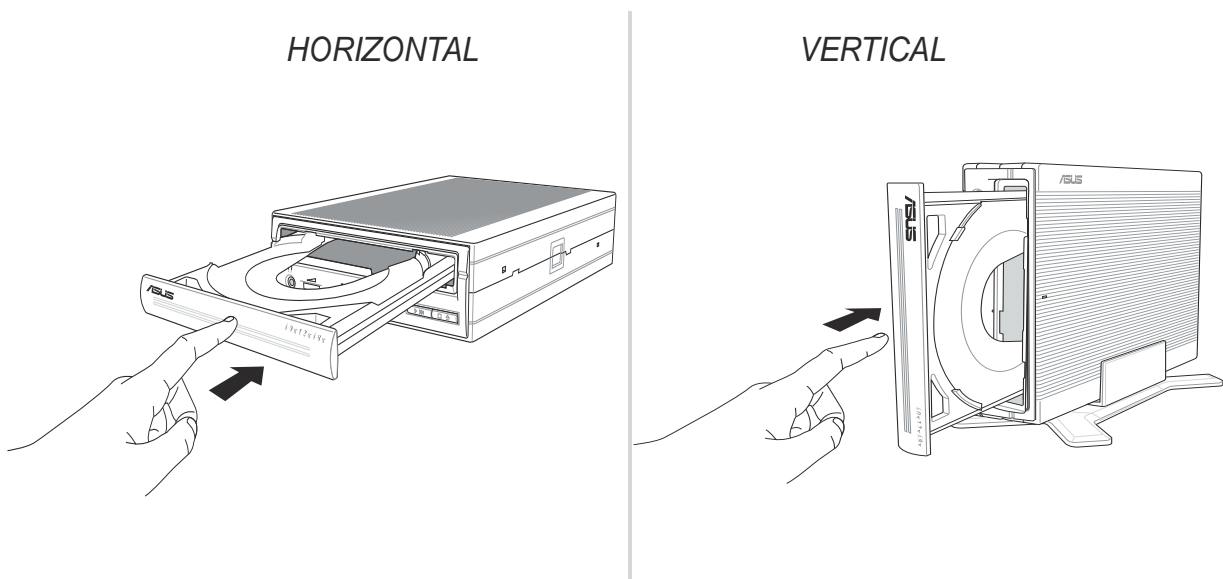

Ejecting a Disc from the Drive

1. Press the eject button on the front of the drive to eject the tray.
2. Carefully remove the disc from the tray.
3. Press the drive eject button or lightly push the center of the drive tray to load the tray back into the drive.

Using the Emergency Eject Pinhole

The emergency eject pinhole on the front of the drive allows you to manually eject the drive tray and remove a disc from the drive in the following instances:

- supply of power to the computer is cut due to electrical power outage
- the drive malfunctions

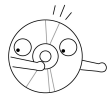

Use the manual method only as a last resort when the eject button does not work. Make sure that you have turned off your CD-RW drive before ejecting the drive tray.

Follow these steps to eject the drive tray using the emergency pinhole.

1. Insert the eject pin that came with the drive package. You may also use a paper clip or any pointed rod small enough to fit into the emergency pinhole.

HORIZONTAL

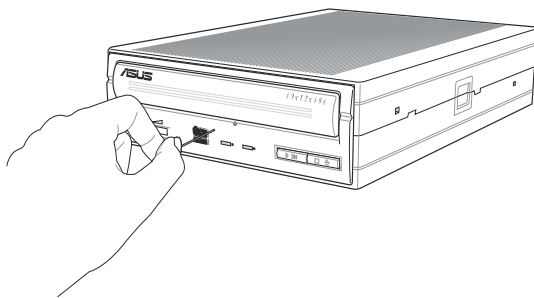

VERTICAL

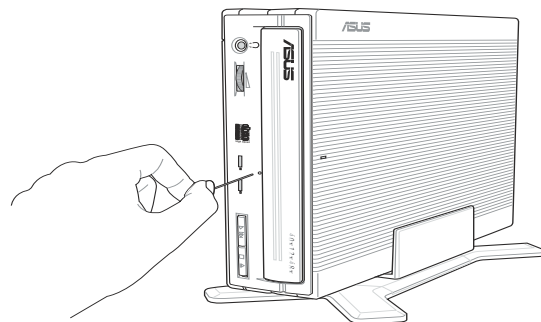

2. Carefully pull the tray out and remove the disc.

HORIZONTAL

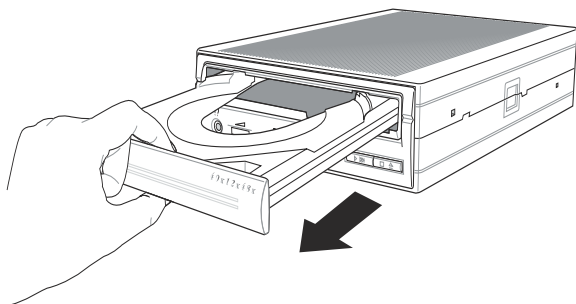

VERTICAL

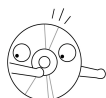
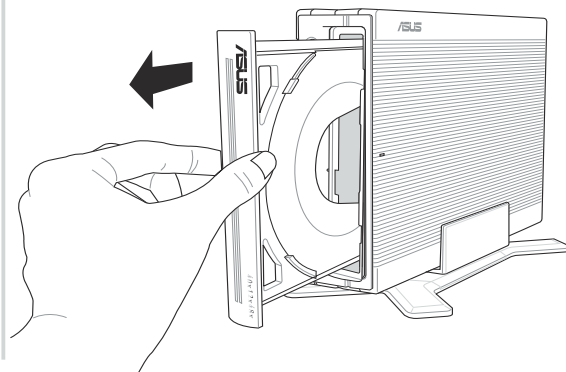

Do not force the tray open; wait until the eject pin has dislodged the tray to avoid breaking the tray panel.

Using Compact Discs

Take note of the instructions in this section when using compact discs. These instructions will help you avoid damaging the discs and your CD-RW drive.

Cleaning a Disc

Spray the disc with compressed air for about five seconds to get rid of the dust on a disc.

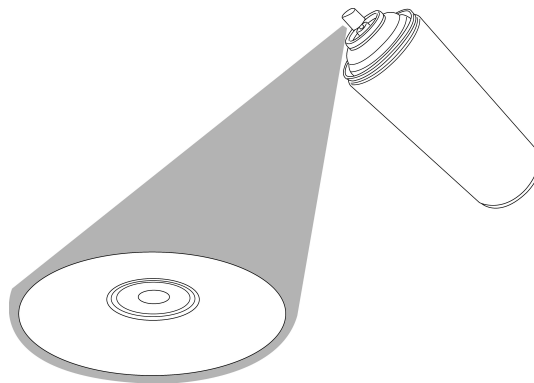

Handling a Disc

Hold a disc by the edges. Do not touch the disc surface.

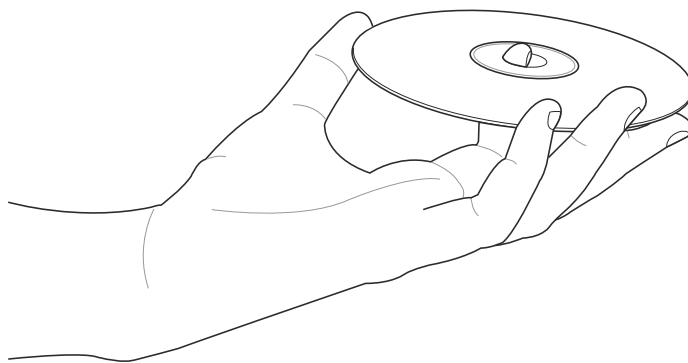

Technical Information

Environmental Specifications

Temperature	Operation:	5°C < to < 45°C
	Storage:	- 20°C to < 60°C
Humidity	Operation:	20% to 80% non-condensing
	Storage:	15% to 85% non-condensing
Vibration	Operation:	0.5G peak at 5 ~ 500 Hz
	Storage:	2.0G peak at 10 ~ 500 Hz
Impact	Non-operation:	1 oct/min – no damage Less than 50G – (at 11ms/half sine wave, 3 shock/each side)
	Packaged:	1 oct/min – no damage 91 cm high – (1 corner, 3 edges, 6 surfaces)
Acoustic	Access mode:	41.5 dB TYP
	Read mode:	44.5 dB TYP
(Microphone located 50cm in front of the drive, 120 cm above the drive at 30° angle.)		
Reliability	MTBF:	100,000 power on hours
	ODC (Read):	20% of power on time
	ODC (Write):	1% of power on time
Mean Time To Repair (MTTR)		30 minutes

Electrical and Audio Specifications

Power Source	Input Linear Voltage	100/240 V AC
	Input Linear Frequency	50/60 Hz
	Input Linear Current	1.2 A
I/O Terminal	USB terminal	USB B type (High Speed)
Audio	No. of channels	2 (stereo)
	Sampling frequency	44.1 kHz
	Quantization	16 bits
	Distortion	0.2% max. (at 1 kHz)
	S/N ratio	70 dB
	Output: Headphone	0.7 V rms (typical)