

**P8Z77-I
DELUXE**

ASUS[®]

Motherboard

E7987

Second Edition
January 2013

Copyright © 2013 ASUSTeK COMPUTER INC. All Rights Reserved.

No part of this manual, including the products and software described in it, may be reproduced, transmitted, transcribed, stored in a retrieval system, or translated into any language in any form or by any means, except documentation kept by the purchaser for backup purposes, without the express written permission of ASUSTeK COMPUTER INC. ("ASUS").

Product warranty or service will not be extended if: (1) the product is repaired, modified or altered, unless such repair, modification of alteration is authorized in writing by ASUS; or (2) the serial number of the product is defaced or missing.

ASUS PROVIDES THIS MANUAL "AS IS" WITHOUT WARRANTY OF ANY KIND, EITHER EXPRESS OR IMPLIED, INCLUDING BUT NOT LIMITED TO THE IMPLIED WARRANTIES OR CONDITIONS OF MERCHANTABILITY OR FITNESS FOR A PARTICULAR PURPOSE. IN NO EVENT SHALL ASUS, ITS DIRECTORS, OFFICERS, EMPLOYEES OR AGENTS BE LIABLE FOR ANY INDIRECT, SPECIAL, INCIDENTAL, OR CONSEQUENTIAL DAMAGES (INCLUDING DAMAGES FOR LOSS OF PROFITS, LOSS OF BUSINESS, LOSS OF USE OR DATA, INTERRUPTION OF BUSINESS AND THE LIKE), EVEN IF ASUS HAS BEEN ADVISED OF THE POSSIBILITY OF SUCH DAMAGES ARISING FROM ANY DEFECT OR ERROR IN THIS MANUAL OR PRODUCT.

SPECIFICATIONS AND INFORMATION CONTAINED IN THIS MANUAL ARE FURNISHED FOR INFORMATIONAL USE ONLY, AND ARE SUBJECT TO CHANGE AT ANY TIME WITHOUT NOTICE, AND SHOULD NOT BE CONSTRUED AS A COMMITMENT BY ASUS. ASUS ASSUMES NO RESPONSIBILITY OR LIABILITY FOR ANY ERRORS OR INACCURACIES THAT MAY APPEAR IN THIS MANUAL, INCLUDING THE PRODUCTS AND SOFTWARE DESCRIBED IN IT.

Products and corporate names appearing in this manual may or may not be registered trademarks or copyrights of their respective companies, and are used only for identification or explanation and to the owners' benefit, without intent to infringe.

Offer to Provide Source Code of Certain Software

This product may contain copyrighted software that is licensed under the General Public License ("GPL") and under the Lesser General Public License Version ("LGPL"). The GPL and LGPL licensed code in this product is distributed without any warranty. Copies of these licenses are included in this product.

You may obtain the complete corresponding source code (as defined in the GPL) for the GPL Software, and/or the complete corresponding source code of the LGPL Software (with the complete machine-readable "work that uses the Library") for a period of three years after our last shipment of the product including the GPL Software and/or LGPL Software, which will be no earlier than December 1, 2011, either (1) for free by downloading it from <http://support.asus.com/download>;

or

(2) for the cost of reproduction and shipment, which is dependent on the preferred carrier and the location where you want to have it shipped to, by sending a request to:

ASUSTeK Computer Inc.
Legal Compliance Dept.
15 Li Te Rd.,
Beitou, Taipei 112
Taiwan

In your request please provide the name, model number and version, as stated in the About Box of the product for which you wish to obtain the corresponding source code and your contact details so that we can coordinate the terms and cost of shipment with you.

The source code will be distributed WITHOUT ANY WARRANTY and licensed under the same license as the corresponding binary/object code.

This offer is valid to anyone in receipt of this information.

ASUSTeK is eager to duly provide complete source code as required under various Free Open Source Software licenses. If however you encounter any problems in obtaining the full corresponding source code we would be much obliged if you give us a notification to the email address gpl@asus.com, stating the product and describing the problem (please do NOT send large attachments such as source code archives etc to this email address).

Contents

Safety information.....	vi
About this guide.....	vii
P8Z77-I DELUXE specifications summary.....	ix

Chapter 1: Product introduction

1.1	Welcome!.....	1-1
1.2	Package contents.....	1-1
1.3	Special features.....	1-2
1.3.1	Product highlights.....	1-2
1.3.2	Dual Intelligent Processors 2 with DIGI+ VRM.....	1-3
1.3.3	ASUS Exclusive Features.....	1-4
1.3.4	ASUS Quiet Thermal Solution.....	1-6
1.3.5	ASUS EZ DIY.....	1-6
1.3.6	Other special features.....	1-7

Chapter 2: Hardware information

2.1	Before you proceed.....	2-1
2.2	Motherboard overview.....	2-2
2.2.1	Motherboard layout.....	2-2
2.2.2	Central Processing Unit (CPU).....	2-4
2.2.3	System memory.....	2-5
2.2.4	Expansion slot.....	2-14
2.2.5	Onboard switches.....	2-16
2.2.6	Onboard LEDs.....	2-18
2.2.7	Internal connectors.....	2-20
2.2.8	Jumper.....	2-27
2.3	Building your computer system.....	2-28
2.3.1	Additional tools and components to build a PC system.....	2-28
2.3.2	CPU installation.....	2-29
2.3.3	CPU heatsink and fan assembly installation.....	2-31
2.3.4	DIMM installation.....	2-33
2.3.5	Motherboard installation.....	2-34
2.3.6	ATX Power connection.....	2-36
2.3.7	SATA device connection.....	2-37
2.3.8	Front I/O Connector.....	2-38
2.3.9	Expansion Card installation.....	2-39
2.3.10	USB BIOS Flashback.....	2-40
2.3.11	Rear panel connection.....	2-41
2.3.12	Audio I/O connections.....	2-43

Contents

2.4	Starting up for the first time.....	2-45
2.5	Turning off the computer.....	2-45

Chapter 3: BIOS setup

3.1	Knowing BIOS.....	3-1
3.2	BIOS setup program.....	3-1
	3.2.1 EZ Mode.....	3-2
	3.2.2 Advanced Mode.....	3-3
3.3	Main menu.....	3-5
3.4	Ai Tweaker menu.....	3-7
3.5	Advanced menu.....	3-16
	3.5.1 CPU Configuration.....	3-17
	3.5.2 PCH Configuration.....	3-19
	3.5.3 SATA Configuration.....	3-20
	3.5.4 System Agent Configuration.....	3-21
	3.5.5 USB Configuration.....	3-22
	3.5.6 Onboard Devices Configuration.....	3-23
	3.5.7 APM.....	3-25
	3.5.8 Network Stack.....	3-25
3.6	Monitor menu.....	3-26
3.7	Boot menu.....	3-29
3.8	Tools menu.....	3-31
	3.8.1 ASUS EZ Flash 2 Utility.....	3-31
	3.8.2 ASUS O.C. Profile.....	3-31
	3.8.3 ASUS SPD Information.....	3-32
3.9	Exit menu.....	3-33
3.10	Updating BIOS.....	3-34
	3.10.1 ASUS Update utility.....	3-34
	3.10.2 ASUS EZ Flash 2 utility.....	3-37
	3.10.3 ASUS CrashFree BIOS 3 utility.....	3-38
	3.10.4 ASUS BIOS Updater.....	3-39

Chapter 4: Software support

4.1	Installing an operating system.....	4-1
4.2	Support DVD information.....	4-1
	4.2.1 Running the support DVD.....	4-1
	4.2.2 Obtaining the software manuals.....	4-2
4.3	Software information.....	4-3
	4.3.1 AI Suite II.....	4-3
	4.3.2 TurboV EVO.....	4-4

Contents

4.3.3	DIGI+ VRM.....	4-8
4.3.4	EPU.....	4-10
4.3.5	FAN Xpert.....	4-11
4.3.6	Probe II.....	4-12
4.3.7	Sensor Recorder	4-13
4.3.8	Ai Charger+	4-14
4.3.9	USB 3.0 Boost.....	4-15
4.3.10	Wi-Fi GO!	4-16
4.3.11	USB Charger+.....	4-29
4.3.12	USB BIOS Flashback Wizard.....	4-31
4.3.13	Network iControl.....	4-33
4.3.14	ASUS Update.....	4-36
4.3.15	MyLogo2	4-37
4.3.16	Audio configurations.....	4-39
4.4	Introduction to Intel® 2012 Desktop responsiveness technologies	4-40
4.4.1	System Requirements for Intel® 2012 Desktop responsiveness technologies.....	4-40
4.4.2	Intel® Smart Response Technology.....	4-42
4.4.3	Intel® Rapid Start Technology.....	4-43
4.4.4	Intel® Smart Connect Technology.....	4-49
4.5	RAID configurations	4-52
4.5.1	RAID definitions	4-52
4.5.2	Installing Serial ATA hard disks	4-53
4.5.3	Setting the RAID item in BIOS	4-53
4.5.4	Intel® Rapid Storage Technology Option ROM utility	4-53
4.6	Creating a RAID driver disk.....	4-57
4.6.1	Creating a RAID driver disk without entering the OS.....	4-57
4.6.2	Creating a RAID driver disk in Windows®.....	4-57
4.6.3	Installing the RAID driver during Windows® OS installation.....	4-58
4.6.4	Using a USB floppy disk drive.....	4-59
Chapter 5: Multiple GPU technology support		
5.1	LucidLogix Virtu MVP	5-1
	Installing LucidLogix Virtu MVP.....	5-1
	Setting up your display.....	5-2
	Configuring LucidLogix Virtu MVP	5-3
Appendix		
	Notices	A-1
	ASUS Recycling/Takeback Services.....	A-2
	RF Equipment Notices	A-3

Safety information

Electrical safety

- To prevent electrical shock hazard, disconnect the power cable from the electrical outlet before relocating the system.
- When adding or removing devices to or from the system, ensure that the power cables for the devices are unplugged before the signal cables are connected. If possible, disconnect all power cables from the existing system before you add a device.
- Before connecting or removing signal cables from the motherboard, ensure that all power cables are unplugged.
- Seek professional assistance before using an adapter or extension cord. These devices could interrupt the grounding circuit.
- Ensure that your power supply is set to the correct voltage in your area. If you are not sure about the voltage of the electrical outlet you are using, contact your local power company.
- If the power supply is broken, do not try to fix it by yourself. Contact a qualified service technician or your retailer.

Operation safety

- Before installing the motherboard and adding devices on it, carefully read all the manuals that came with the package.
- Before using the product, ensure all cables are correctly connected and the power cables are not damaged. If you detect any damage, contact your dealer immediately.
- To avoid short circuits, keep paper clips, screws, and staples away from connectors, slots, sockets and circuitry.
- Avoid dust, humidity, and temperature extremes. Do not place the product in any area where it may become wet.
- Place the product on a stable surface.
- If you encounter technical problems with the product, contact a qualified service technician or your retailer.

About this guide

This user guide contains the information you need when installing and configuring the motherboard.

How this guide is organized

This guide contains the following parts:

- **Chapter 1: Product introduction**
This chapter describes the features of the motherboard and the new technology it supports.
- **Chapter 2: Hardware information**
This chapter lists the hardware setup procedures that you have to perform when installing system components. It includes description of the switches, jumpers, and connectors on the motherboard.
- **Chapter 3: BIOS setup**
This chapter tells how to change system settings through the BIOS Setup menus. Detailed descriptions of the BIOS parameters are also provided.
- **Chapter 4: Software support**
This chapter describes the contents of the support DVD that comes with the motherboard package and the software.
- **Chapter 5: LucidLogix Virtu MVP**
This chapter describes how to configure LucidLogix Virtu MVP.

Where to find more information

Refer to the following sources for additional information and for product and software updates.

1. **ASUS websites**
The ASUS website provides updated information on ASUS hardware and software products. Refer to the ASUS contact information.
2. **Optional documentation**
Your product package may include optional documentation, such as warranty flyers, that may have been added by your dealer. These documents are not part of the standard package.

Conventions used in this guide

To ensure that you perform certain tasks properly, take note of the following symbols used throughout this manual.



DANGER/WARNING: Information to prevent injury to yourself when trying to complete a task.



CAUTION: Information to prevent damage to the components when trying to complete a task.



IMPORTANT: Instructions that you **MUST** follow to complete a task.



NOTE: Tips and additional information to help you complete a task.

Typography

Bold text

Indicates a menu or an item to select.

Italics

Used to emphasize a word or a phrase.

<Key>

Keys enclosed in the less-than and greater-than sign means that you must press the enclosed key.

Example: <Enter> means that you must press the Enter or Return key.

<Key1> + <Key2> + <Key3>

If you must press two or more keys simultaneously, the key names are linked with a plus sign (+).

Example: <Ctrl> + <Alt> +

P8Z77-I DELUXE specifications summary

CPU	LGA1155 socket for Intel® 3 rd / 2 nd Generation Core™ i7 / i5 / i3 / Pentium® / Celeron® processors Supports 22nm / 32nm CPU Supports Intel® Turbo Boost technology 2.0* * The Intel® Turbo Boost technology 2.0 support depends on the CPU types. ** Refer to www.asus.com for Intel® CPU support list.
Chipset	Intel® Z77 Express Chipset
Memory	2 x DIMMs, max. 16GB, DDR3 2400(O.C.)* / 2200(O.C.)* / 2133(O.C.) / 1866(O.C.) / 1600 / 1333 / 1066 MHz, non-ECC, un-buffered memory Dual-channel memory architecture Supports Intel® Extreme Memory Profile (XMP) * Hyper DIMM support is subject to the physical characteristics of individual CPUs. Please refer to Memory QVL (Qualified Vendors List) for details.
Expansion slots	1 x PCI Express 3.0* / 2.0 x16 slot * PCIe 3.0 speed is supported by Intel® 3 rd generation processors.
VGA	Integrated Graphics Processor - Intel® HD Graphics support Multi-VGA output support: DisplayPort, HDMI, DVI-I port - Supports DisplayPort 1.1a with max. resolution 2560 x 1600@60Hz - Supports HDMI with max. resolution 1920 x 1200@60Hz - Supports DVI-I Single Link with max. resolution 1920 x 1200 @60Hz - Supports Intel® InTru™ 3D / Quick Sync Video / Clear Video HD Technology / Insider™
Multi-GPU support	Supports LucidLogix Virtu MVP Technology* * LucidLogix Virtu MVP supports Windows 7 operating systems.
Storage	Intel® Z77 Express Chipset: - 2 x SATA 6.0 Gb/s ports (gray) with RAID 0, 1, 5, 10 support - 2 x SATA 3.0 Gb/s ports (blue) with RAID 0, 1, 5, 10 support - 2 x eSATA 3.0 Gb/s ports (on the back panel) with RAID 0, 1, 5, 10 support - Supports Intel® Smart Response Technology, Intel® Rapid Start Technology, Intel® Smart Connect Technology* * Supports on Intel® Core™ processor family with Windows® 7 operating systems.
LAN	Intel® 82579V Gigabit LAN- Dual interconnect between the integrated LAN controller and physical layer (PHY)
Wireless Data Network	Wi-Fi 802.11 a/b/g/n supports dual frequency band 2.4 GHz/ 5 GHz ASUS Wi-Fi GO! Utility
Bluetooth	Bluetooth v4.0 Bluetooth v3.0 + HS
Audio	Realtek® ALC898 8-channel High Definition Audio CODEC* - Absolute Pitch 192khz/24bit true BD lossless sound - DTS UltraPC II - DTS Connect - Supports Jack-Detection, Multi-streaming and Front Panel Jack-Retasking - Optical S/PDIF out ports at back I/O * Use a chassis with HD audio module in the front panel to support an 8-channel audio output.

(continued on the next page)

P8Z77-I DELUXE specifications summary

USB	<p>Intel® Z77 Express Chipset - supports ASUS USB 3.0 Boost UASP Mode*</p> <ul style="list-style-type: none">- 2 x USB 3.0/2.0 ports at the mid-board for front panel support- 2 x USB 3.0/2.0 ports at the back panel (blue) <p>Intel® Z77 Express Chipset</p> <ul style="list-style-type: none">- 8 x USB 2.0/1.1 ports (4 ports at the mid-board, 4 ports at the back panel) <p>ASMedia® USB 3.0 controllers - supports ASUS USB 3.0 Boost UASP Mode**</p> <ul style="list-style-type: none">- 2 x USB 3.0/2.0 ports at the back panel (blue) <p>* The USB 3.0 ports only support Windows® 7 or later versions operating systems. The UASP standard only supports Windows® 8.</p> <p>** The USB 3.0 ports only support Windows® XP or later versions operating systems. The UASP standard only supports Windows® 8.</p>
ASUS unique features	<p>ASUS Dual Intelligent Processors 2 with DIGI+ VRM</p> <ul style="list-style-type: none">- Industry leading digital 10-phase power design (8-phase for CPU, 2-phase for iGPU) <p>ASUS EPU</p> <ul style="list-style-type: none">- EPU <p>ASUS TPU</p> <ul style="list-style-type: none">- Auto Tuning, TurboV, GPU Boost, TPU switch <p>ASUS Wi-Fi GO!:</p> <ul style="list-style-type: none">- Wi-Fi GO! Function: DLNA Media Hub, Smart Motion Control, File Transfer, Remote Desktop, Remote Keyboard & Mouse, Capture & Send (available with V1.01.00 or later)- Wi-Fi GO! Remote for portable Smartphone/Tablet, supporting iOS and Android systems.- Wi-Fi Engine for network sharing and connection: Client Mode, AP Mode. <p>ASUS Exclusive Features:</p> <ul style="list-style-type: none">- ASUS UEFI BIOS EZ Mode featuring friendly graphics user interface- Network iControl featuring instant network bandwidth domination for top network program in use.- USB 3.0 Boost featuring the latest USB 3.0 UASP standard- USB Charger+ featuring quick-charging function for all smart devices.- AI Charger+- Disk Unlocker featuring 3TB+ HDD support- AI Suite II- Anti Surge- MemOK! <p>ASUS Quiet Thermal Solution:</p> <ul style="list-style-type: none">- ASUS Fanless Design: Heatsink solution- ASUS Fan Xpert <p>ASUS EZ DIY:</p> <ul style="list-style-type: none">- ASUS USB BIOS Flashback with USB BIOS Flashback Wizard for EZ BIOS download scheduling- ASUS UEFI BIOS EZ Mode featuring friendly graphics user interface- ASUS O.C. Tuner- ASUS CrashFree BIOS 3- ASUS EZ Flash 2 <p>ASUS Q-Design:</p> <ul style="list-style-type: none">- ASUS Q-Shield- ASUS Q-Cable

(continued on the next page)

P8Z77-I DELUXE specifications summary

ASUS exclusive overclocking features	<p>Precision Tweaker 2:</p> <ul style="list-style-type: none"> - vCore: 191-step Vcore voltage control - iGPU: 128-step iGPU voltage control - vCCSA: 191-step System Agent voltage control - vDRAM Bus: 188-step Memory voltage control - vPCH: 8-step Chipset voltage control at 0.050v increment - vCPU_PLL: 2-step CPU control at 0.100v increment <p>SFS (Stepless Frequency Selection):</p> <ul style="list-style-type: none"> - BCLK/PCIE frequency tuning from 80MHz up to 300MHz at 0.1MHz increment <p>Overclocking Protection:</p> <ul style="list-style-type: none"> - ASUS C.P.R.(CPU Parameter Recall)
Back Panel I/O Ports	<ul style="list-style-type: none"> 1 x DisplayPort 1 x HDMI port 1 x DVI-I port 2 x antenna ports (for Wi-Fi 802.11 a/b/g/n and Bluetooth v4.0/3.0+HS) 1 x Optical S/PDIF Out port 2 x eSATA ports 1 x LAN (RJ-45) port 4 x USB 3.0/2.0 ports (blue, 1 supports USB BIOS Flashback) 4 x USB 2.0/1.1 ports 1 x USB BIOS Flashback button 1 x Clear CMOS button 6-channel Audio I/O ports
Internal I/O connectors	<ul style="list-style-type: none"> 1 x USB 3.0/2.0 connector supports additional 2 USB ports (19-pin) 2 x USB 2.0/1.1 connectors support additional 4 USB ports 2 x SATA 6.0 Gb/s connectors (gray) 2 x SATA 3.0 Gb/s connectors (blue) 1 x CPU Fan connector (4-pin) 1 x Chassis Fan connectors (4-pin) System Panel connector (Q-Cable) Front panel audio connector (AAFP) 24-pin EATX Power connector 8-pin EATX 12V Power connector 1 x MemOK! button 1 x Clear CMOS jumper 1 x S/PDIF out header 1 x Chassis Intrusion header 1 x TPU switch 1 x speaker header
BIOS features	<p>64 Mb Flash ROM, UEFI AMI BIOS, PnP, DMI2.0, WfM2.0, SM BIOS 2.5, ACPI 2.0a, Multi-language BIOS, ASUS EZ Flash 2, ASUS CrashFree BIOS 3, F12 PrintScreen, F3 Shortcut Function and ASUS DRAM SPD (Serial Presence Detect) memory information</p>
Manageability	<p>WfM 2.0, DMI 2.0, WOL by PME, PXE</p>
Accessories	<ul style="list-style-type: none"> 2 x Wi-Fi ring moving antennas 2 x Serial ATA 6.0Gb/s cables 2 x Serial ATA 3.0Gb/s cables ASUS Q-Shield ASUS Q-Cable User Manual
Support DVD	<ul style="list-style-type: none"> Drivers ASUS Utilities ASUS Update Anti-virus software (OEM version)
Form factor	<p>mini-ITX Form Factor, 6.7" x 6.7" (17cm x 17cm)</p>

*Specifications are subject to change without notice.

Chapter 1

1.1 Welcome!





Thank you for buying an ASUS® P8Z77-I DELUXE motherboard!

The motherboard delivers a host of new features and latest technologies, making it another standout in the long line of ASUS quality motherboards!

Before you start installing the motherboard, and hardware devices on it, check the items in your package with the list below.

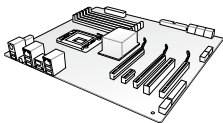
1.2 Package contents

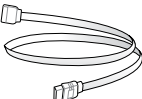
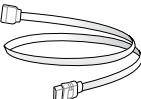
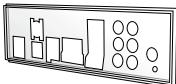
Check your motherboard package for the following items.

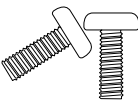
		
ASUS P8Z77-I DELUXE motherboard	User manual	Support DVD
		
2 x Serial ATA 6.0 Gb/s cables	2 x Serial ATA 3.0 Gb/s cables	1 x ASUS Q-Shield
		
2 x Wi-Fi Ring moving antennas	1 x ASUS Q-Cable	1 bag of screws



- If any of the above items is damaged or missing, contact your retailer.
- The illustrated items above are for reference only. Actual product specifications may vary with different models.

1.3 Special features

1.3.1 Product highlights

LGA1155 socket for Intel® Second/Third Generation Core™ i7 / i5 / i3 / Pentium® / Celeron® Processors

This motherboard supports the Intel® 3rd/2nd generation Core™ i7/i5/i3/Pentium®/Celeron® processors in the LGA1155 package, with iGPU, memory, and PCI Express controllers integrated to support onboard graphics out with dedicated chipsets, 2-channel (2 DIMMs) DDR3 memory, and 16 PCI Express 3.0/2.0 lanes. This provides great graphics performance. Intel® 3rd/2nd generation Core™ i7/i5/i3/Pentium®/Celeron® processors are among the most powerful and energy efficient CPUs in the world.

Intel® Z77 Express Chipset

The Intel® Z77 Express Chipset is a single-chipset designed to support the 1155 socket Intel® 3rd/2nd generation Core™ i7/i5/ i3/Pentium®/Celeron® processors. It provides improved performance by utilizing serial point-to-point links, allowing increased bandwidth and stability. Additionally, Z77 chipset provides 4 USB 3.0 ports for 10 times faster data retrieval speed. Moreover, Intel® Z77 Express Chipset can also enable iGPU function, letting users enjoy the latest Intel® integrated graphic performance.

Dual-Channel DDR3 2400(O.C.) / 2200(O.C.) / 2133(O.C.) / 1866(O.C.) / 1600 / 1333 / 1066 MHz Support

The motherboard supports DDR3 memory that features data transfer rates of DDR3 2400(O.C.) / 2200(O.C.) / 2133(O.C.) / 1866(O.C.) / 1600 / 1333 / 1066 MHz to meet the higher bandwidth requirements of the latest 3D graphics, multimedia, and Internet applications. The dual-channel DDR3 architecture enlarges the bandwidth of your system memory to boost system performance.

PCI Express® 3.0*

PCI Express® 3.0 (PCIe 3.0) is the latest PCI Express bus standard with improved encoding schemes that provide twice the performance of the current PCIe 2.0. The total bandwidth for a x16 link reaches a maximum of 32Gb/s, double the 16Gb/s of PCIe 2.0 (in x16 mode). As such, PCIe 3.0 provides users an unprecedented data speeds, combined with the convenience and seamless transition offered by complete backward compatibility with PCIe 1.0 and PCIe 2.0 devices. PCIe 3.0 will become a must-have feature for users who wish to improve and optimize graphic performance, as well as have the latest technology available to them.

* PCI 3.0 speed is supported by Intel® 3rd generation Core™ processors.

Complete USB 3.0 Integration

Double USB Access, Double Convenience

ASUS facilitates the strategic USB 3.0 accessibility for both the front and rear panel – 6 USB 3.0 ports in total. Experience the latest plug & play connectivity at speeds up to 10 times faster than USB 2.0. The P8Z77-I DELUXE affords greater convenience to high speed connectivity.

Intel® Smart Response Technology

SSD Speed with HDD Capacity

Intel® Smart Response Technology boosts overall system performance by using an installed fast SSD (min 18.6GB available capacity required) as a cache for frequently accessed data. Key benefits include reduced load and wait times, and lower power consumption through the elimination of unnecessary hard drive spin. This technology combines SSD performance with hard drive capacity, operating up to 6X faster than a hard drive-only system.

* Intel® Smart Response Technology is supported by 3rd/2nd generation Intel® Core™ processor family on Windows® 7™ operating systems.

** Operating systems must be installed on the HDD to launch Intel® Smart Response Technology. The capacity of the SSD is reserved for caching function.

Intel® Smart Connect Technology

Your computer could receive web updates with fresh content for selected applications, even when setting the system to sleep. This means less time waiting for applications to start, update and sync with the cloud, providing a more efficient way.

Intel® Rapid Start Technology

Allows your computer to quickly resume from a lower-power hibernate state in seconds. Saving system memory to the designed SSD, provides your computer a faster wake-up response time, while keeping the energy use low.

1.3.2 Dual Intelligent Processors 2 with DIGI+ VRM

The world's first Dual Intelligent Processors from ASUS pioneered the use of two onboard chips—EPU (Energy Processing Unit) and TPU (TurboV Processing Unit). New generation Dual Intelligent Processors 2 with DIGI+ VRM digital power design launch control into a new era, empowering users with superior flexibility and perfect precision to ensure optimized performance, extreme system stability and greater power efficiency.

ASUS DIGI+ VRM

Digital Power Control: Digital Power Design for the CPU and iGPU

All-new digital CPU power controls work perfectly together to match digital power signal (SVID) requests from the CPU, with ultra-fast sensing and response efficiently delivering precision power. Accurate delivery reduces waste, and provides more stable CPU Vcore voltages. Users can adjust CPU and its processor graphics (iGPU) voltages for various overclocking scenarios, with accurate input through UEFI BIOS tuning or the exclusive ASUS interface. This proprietary design increases overclocking headroom to push performance to its full potential.

TPU

The Ultimate Turbo Processor

Unleash your performance with ASUS' simple onboard switch or AI Suite II utility. The TPU chip offers precise voltage control and advanced monitoring through Auto Tuning and TurboV functions. Auto tuning offers a user friendly way to automatically optimize the system for fast, yet stable clock speeds, while TurboV enables unlimited freedom to adjust CPU frequencies and ratios for optimized performance in diverse situations.

EPU

Energy Efficiency All Around

Tap into the world's first real-time PC power saving chip through AI Suite II utility. Get total system-wide energy optimization by automatically detecting current PC loadings and intelligently moderating power consumption. This also reduces fan noise and extends component longevity.

1.3.3 ASUS Exclusive Features

Wi-Fi GO!

ASUS Wi-Fi GO! makes enjoying home entertainment easier than ever! Exclusive Wi-Fi functions provide DLNA streaming so you can enjoy a home theater PC, while providing remote access to your PC with a smart device. ASUS Wi-Fi GO! leads the market by integrating Wi-Fi connectivity, DLNA access, and all smart devices with a one-stop utility for a futuristic connected lifestyle.

Wi-Fi hotspot setup for convenience:

Quickly set up and connect anywhere at home, thanks to instant soft access point and device detection. Build your network without an extra router!

Turn smartphones and tablets into a remote control:

1. **Remote Desktop** - access your PC from a tablet? No sweat! Control your PC in real-time from a mobile device for complete comfort. This function brings notebook-like convenience by creating a virtual remote desktop, offering portable access to your data in desktop with a smartphone or pad.
2. **Motion control your PC** - entertaining and customizable! Using natural gestures, you can move directionally to use applications with a smartphone or tablet's motion sensors. For example, in media players you can fast forward, go next, stop or create a music playing motion control profile. You can even set program sensor scenarios to design your own motion-based game!
3. **Remote keyboard and mouse** - sit back and control your computer by using your tablet's built-in QWERTY keyboard to type and click!

DLNA streaming made easy:

Enjoy HD content, music and photos from the PC on your DLNA devices via Wi-Fi connectivity, the perfect match for creating your own home theater!

Easy file and screenshot transfers:

Send and share files and screenshots from your PC to your smart devices directly with a touch over Wi-Fi.

USB Charger+

With a dedicated onboard controller, quick-charge your smart devices such as iProducts, smartphones, tablets and more, all up to 3X faster, even when the PC is powered off, in sleep, or hibernation mode.

Ai Charger+

ASUS Ai Charger+, the latest Ai Charger* version, brings you to a new level of USB3.0 fast charging experience. With its easy and user-friendly interface, you can not only easily charge iPod, iPhone and iPad, but also BC 1.1** standard mobile devices three times*** as fast as before.



* Ai Charger is ASUS unique fast-charging software which supports iPod, iPhone and iPad.

** Check your USB mobile device manufacturer if it fully supports the BC 1.1 function.

***The actual charging speed may vary with your USB device's conditions.

GPU Boost

Go to the Limit with iGPU Level Up!

GPU Boost accelerates the integrated GPU for extreme graphics performance. The user-friendly interface facilitates flexible frequency adjustments. It easily delivers stable system-level upgrades for every use.

USB 3.0 Boost

Faster USB 3.0 Transmission with UASP

New ASUS USB 3.0 Boost technology supports UASP (USB Attached SCSI Protocol), the latest USB 3.0 standard. With USB 3.0 Boost technology, a USB device's transmission speed is significantly increased up to 170%, adding to an already impressive fast USB 3.0 transfer speed. ASUS software automatically accelerates data speeds for compatible USB 3.0 peripherals without the need for any user interaction.



- The UASP support varies with models.
- Due to Intel® USB 3.0 Controller limitation, the USB 3.0 Boost is not supported in Windows® XP.

USB BIOS Flashback

Easy, Worry-free USB BIOS Flashback

A truly revolutionary hardware-based BIOS update solution. USB BIOS Flashback offers the most convenient way ever to update the BIOS! It allows users to update new UEFI BIOS versions, even without hardware such as a CPU or DRAM installed into the motherboard. Just plug in a USB flash drive containing the BIOS file, and press the BIOS Flashback button for 3 seconds with the power supply connected. The UEFI BIOS will then automatically update without requiring further interaction. With its new complementary Windows® application, users can regularly check for UEFI BIOS updates, and downloads the latest BIOS automatically. Hassle-free updating for the ultimate convenience!

Network iControl

Real-time Network Bandwidth Control

With a single-click on/off button, the application currently in use has its data and network bandwidth prioritized over other programs. Moreover, you can prioritize your favorite software easily by configuring profiles through the intuitive user interface. Within the profile, programs can be pre-scheduled to run in a specific time period to avoid network congestion and long-waits on downloads. Auto PPPoE network connection provides a one-step setup for enhanced online convenience. Overall, it's an intuitive network bandwidth control center.

AI Suite II

One-stop Access to Innovative ASUS Features

With its user-friendly interface, ASUS AI Suite II consolidates all the exclusive ASUS features into one simple to use software package. It allows you to supervise overclocking, energy management, fan speed control, voltage and sensor readings, and even interact with mobile devices via Wi-Fi. This all-in-one software offers diverse and ease to use functions, with no need to switch back and forth between different utilities.

MemOK!

Any Memory is A-OK!

MemOK! quickly ensures memory boot compatibility. This remarkable memory rescue tool requires a mere push of a button to patch memory issues. MemOK! determines fail-safe settings and dramatically improves your system boot success. Get your system up and running in no time!

1.3.4 ASUS Quiet Thermal Solution

ASUS Fan Xpert

ASUS Fan Xpert intelligently allows you to adjust the CPU fan and chassis fan speeds according to different ambient temperatures caused by different climate conditions in different geographic regions and your PC's loading. The built-in variety of useful profiles offer flexible controls of fan speed to achieve a quiet and cool environment.

1.3.5 ASUS EZ DIY

ASUS UEFI BIOS (EZ Mode)

Flexible and Easy BIOS Interface

ASUS UEFI BIOS offers the first mouse-controlled graphical BIOS designed with selectable modes, providing a user-friendly interface that goes beyond the traditional keyboard-only controls. It also fully-utilizes 2.2TB and larger hard drives in 64-bit operating systems with native support.

ASUS exclusive interface

EZ Mode displays frequently-accessed info. Users can choose system performance settings, and drag and drop boot priorities. Advanced Mode for performance enthusiasts includes detailed DRAM settings via a dedicated memory info page for complete insight.

New upgrade! Quick and easy information for enhanced system control

- F12 BIOS snapshot hotkey for sharing UEFI information and troubleshooting
- New F3 Shortcut for most accessed information
- ASUS DRAM SPD (Serial Presence Detect) information for accessing memory information, detecting faulty DIMMs, and helping with difficult POST situations.

ASUS Q-Shield

Easy and Comfortable Installations

The specially designed ASUS Q-Shield does without the usual "fingers" - making it convenient and easy to install. With better electric conductivity, it ideally protects your motherboard against static electricity and shields it against Electronic Magnetic Interference (EMI).

ASUS EZ-Flash 2

ASUS EZ Flash 2 is a user-friendly utility that allows you to update the BIOS without using a bootable floppy disk or an OS-based utility.

1.3.6 Other special features

LucidLogix Virtu MVP

LucidLogix Virtu MVP featuring HyperFormance™ Technology boosts your PCIe graphics card up to 60% beyond its original performance. Designed for Intel® processor graphics and Windows® 7 PCs, it perfectly combines the performance of discrete graphic cards with fast computing iGPU. Also, with newly designed Virtual Sync, users can enjoy a smoother gaming experience by eliminating tearing artifacts. LucidLogix Virtu MVP can also dynamically assigns tasks to the best available graphics resource, based on power, performance, and system load. This allows users to fully utilize 3x faster video conversion with Intel® Quick Sync Video technology while retaining high-end 3D rendering and gaming performance, provided by both NVIDIA and AMD graphic cards. When the discrete graphic card is not required, power consumption goes automatically down to near zero, making the system more environmentally-friendly. For users searching for perfection, LucidLogix Virtu MVP provides great graphical performance, and the best flexibility and efficiency.

* **LucidLogix Virtu MVP supports Windows® operating system.**

** **Intel® Quick Sync Video feature is supported by 3rd/2nd generation Intel® Core™ processor family**

DisplayPort 1.1a Support

DisplayPort is a digital display interface standard that delivers up to 10.8 Gbps of bandwidth over standard cables, providing billions of colors and bi-directional communications, thus enabling the fastest refresh rates, and the highest resolution digital display through a single cable. Also, it supports HDCP copy protection for Blu-ray discs. Simply output 3D signals through the connected DisplayPort 1.1a cable with your 3D display, then you can sit back and enjoy a perfect 3D animation experience.

HDMI Support

Enjoy Full HD 1080p Multimedia Home-Theater Entertainment

High Definition Multimedia Interface (HDMI) is a set of digital video standards that delivers multi-channel audio and uncompressed digital video for full HD 1080p visuals through a single cable. Supporting HDCP copy protection such as HD DVD and blu-ray discs, HDMI provides you with the highest quality home theater experience.

DTS UltraPC II

DTS UltraPC II delivers an exceptional 7.1 surround experience through the most popular PC audio setups—your existing stereo speakers or headphones. In addition to virtual surround, it upgrades the original sound to new levels with Audio Restoration, recreating dynamic range of audio files. Symmetry mode improves the balance of perceived loudness across different input sources, and enhances boost audio quality through high hand low frequency equalization. With these technologies, users experience better home theater audio with ease.

DTS Connect

Expand Your PC Audio Experience

To get the most out of your audio entertainment across all formats and quality levels, DTS Connect combines two enabling technologies, DTS Neo:PC™ upmixes stereo sources (CDs, MP3s, WMAs, internet radio) into as many as 7.1 channels of incredible surround sound. Consumers can connect their PC to a home theater system. DTS Interactive is capable of performing multi-channel encoding of DTS bitstreams on personal computers, and sending encoded bitstreams out of a digital audio connection (such as S/PDIF or HDMI) designed to deliver audio to an external decoder.

ErP Ready

The motherboard is European Union's Energy-related Products (ErP) ready, and ErP requires products to meet certain energy efficiency requirement in regards to energy consumptions. This is in line with ASUS vision of creating environment-friendly and energy-efficient products through product design and innovation to reduce carbon footprint of the product and thus mitigate environmental impacts.

2.1 Before you proceed

Take note of the following precautions before you install motherboard components or change any motherboard settings.



-
- Unplug the power cord from the wall socket before touching any component.
 - Before handling components, use a grounded wrist strap or touch a safely grounded object or a metal object, such as the power supply case, to avoid damaging them due to static electricity.
 - Hold components by the edges to avoid touching the ICs on them.
 - Whenever you uninstall any component, place it on a grounded antistatic pad or in the bag that came with the component.
 - Before you install or remove any component, ensure that the ATX power supply is switched off or the power cord is detached from the power supply. Failure to do so may cause severe damage to the motherboard, peripherals, or components.
-

2.2 Motherboard overview

2.2.1 Motherboard layout

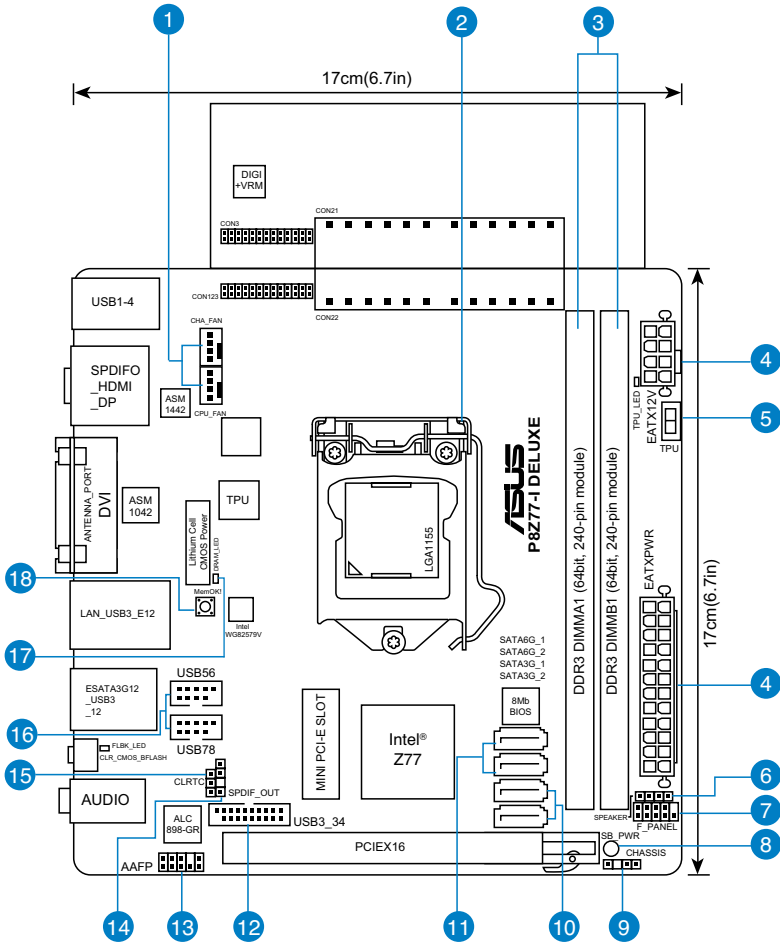

Refer to 2.2.7 Internal connectors and 2.3.12 Rear panel connection for more information about rear panel connectors and internal connectors.

Layout contents

Connectors/Jumpers/Slots		Page
1.	CPU and chassis fan connectors (4-pin CPU_FAN,4-pin CHA_FAN)	2-24
2.	LGA1155 CPU socket	2-4
3.	DDR3 DIMM slots	2-5
4.	ATX power connectors (24-pin EATXPWR, 8-pin EATX12V)	2-25
5.	TPU switch	2-17
6.	Speaker connector (4- pin SPEAKER)	2-25
7.	System panel connector (10-1 pin F_PANEL))	2-26
8.	Onboard LED (SB_PWR)	2-18
9.	Chassis intrusion connector (4-1 pin CHASSIS)	2-23
10.	Intel® Z77 Serial ATA 3.0 Gb/s connectors (7-pin SATA3G_1/2 [blue])	2-21
11.	Intel® Z77 Serial ATA 6.0 Gb/s connectors (7-pin SATA6G_1/2 [gray])	2-20
12.	USB 3.0 connector (20-1 pin USB3_34)	2-22
13.	Front panel audio connector (10-1 pin AAFP)	2-24
14.	Digital audio connector (4-1 pin SPDIF_OUT)	2-23
15.	Clear RTC RAM (3-pin CLRRTC)	2-27
16.	USB 2.0 connectors (10-1 pin USB56, USB78)	2-22
17.	DRAM LED	2-19
18.	MemOK! switch	2-16

2.2.2 Central Processing Unit (CPU)

The motherboard comes with a surface mount LGA1155 socket designed for the Intel® 3rd/2nd Generation Core™ i7 / Core™ i5 / Core™ i3 / Pentium® / Celeron® Processors.

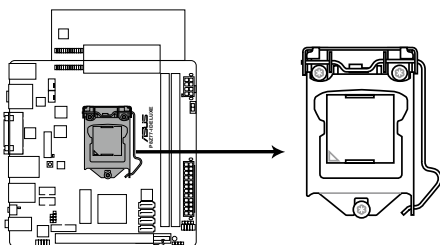

P8Z77-I DELUXE CPU socket LGA1155



Ensure that all power cables are unplugged before installing the CPU.



- The LGA1156 CPU is incompatible with the LGA1155 socket. DO NOT install a LGA1156 CPU on the LGA1155 socket.
 - Upon purchase of the motherboard, ensure that the PnP cap is on the socket and the socket contacts are not bent. Contact your retailer immediately if the PnP cap is missing, or if you see any damage to the PnP cap/socket contacts/motherboard components. ASUS will shoulder the cost of repair only if the damage is shipment/transit-related.
 - Keep the cap after installing the motherboard. ASUS will process Return Merchandise Authorization (RMA) requests only if the motherboard comes with the cap on the LGA1155 socket.
 - The product warranty does not cover damage to the socket contacts resulting from incorrect CPU installation/removal, or misplacement/loss/incorrect removal of the PnP cap.
-

2.2.3 System memory

The motherboard comes with two Double Data Rate 3 (DDR3) Dual Inline Memory Modules (DIMM) slots.



A DDR3 module is notched differently from a DDR or DDR2 module. DO NOT install a DDR or DDR2 memory module to the DDR3 slot.

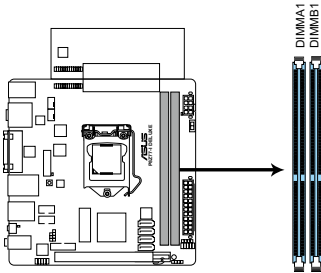

P8Z77-I DELUXE 240-pin DDR3 DIMM sockets

Recommended memory configurations

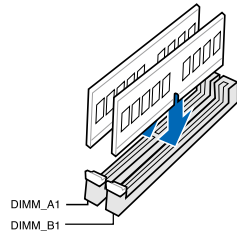
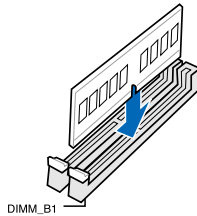
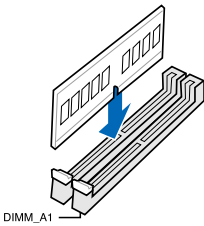

Memory configurations

You may install 1GB, 2GB, 4GB and 8GB unbuffered and non-ECC DDR3 DIMMs into the DIMM sockets.



- You may install varying memory sizes in Channel A and Channel B. The system maps the total size of the lower-sized channel for the dual-channel configuration. Any excess memory from the higher-sized channel is then mapped for single-channel operation.
- Due to Intel® 2nd generation processors' behavior, DDR3 2200/2000/1800 MHz memory module will run at DDR3 2133/1866/1600 MHz frequency as default.
- According to Intel CPU spec, DIMM voltage below 1.65V is recommended to protect the CPU.
- Always install DIMMs with the same CAS latency. For optimum compatibility, we recommend that you obtain memory modules from the same vendor.
- Due to the memory address limitation on 32-bit Windows OS, when you install 4GB or more memory on the motherboard, the actual usable memory for the OS can be about 3GB or less. For effective use of memory, we recommend that you do any of the following:
 - Use a maximum of 3GB system memory if you are using a 32-bit Windows OS.
 - Install a 64-bit Windows OS when you want to install 4GB or more on the motherboard.

For more details, refer to the Microsoft® support site at <http://support.microsoft.com/kb/929605/en-us>.
- This motherboard does not support DIMMs made up of 512Mb (64MB) chips or less (Memory chip capacity counts in Megabit, 8 Megabit/Mb = 1 Megabyte/MB).



- The default memory operation frequency is dependent on its Serial Presence Detect (SPD), which is the standard way of accessing information from a memory module. Under the default state, some memory modules for overclocking may operate at a lower frequency than the vendor-marked value. To operate at the vendor-marked or at a higher frequency, refer to section **3.4 Ai Tweaker menu** for manual memory frequency adjustment.
- For system stability, use a more efficient memory cooling system to support a full memory load (2 DIMMs) or overclocking condition.

P8Z77-I DELUXE Motherboard Qualified Vendors Lists (QVL) DDR3 2400(O.C.) MHz capability

Vendors	Part No.	Size	SS/ DS	Chip Brand	Chip NO.	Timing	Voltage	DIMM socket support (Optional)	
								1 DIMM	2 DIMMs
CORSAIR	CMGTX8(XMP)	8GB(2GB x 4)	SS	-	-	10-12-10-27	1.65V	*	*
G.SKILL	F3-19200CL11Q-16GBZHD(XMP)	16GB(4GB x4)	DS	-	-	11-11-11-31	1.65V	*	*
G.SKILL	F3-19200CL9D-4GBPIS(XMP)	4GB(2x 2GB)	DS	-	-	9-11-9-28	1.65V	*	*
GEIL	GET34GB2400C9DC(XMP)	2GB	DS	-	-	9-11-9-27	1.65V	*	*
KINGMAX	FLLE88F-C8KKAA HAIS(XMP)	2GB	SS	-	-	10-11-10-30	1.8V	*	*
Transcend	TX2400KLU-4GK(427652)(XMP)	4GB(2 x 2GB)	SS	-	-	-	1.65V	*	*
Transcend	TX2400KLU-4GK(381850)(XMP)	4GB(2x 2GB)	SS	-	-	9	1.65V	*	*
Transcend	TX2400KLU-4GK(374243)(XMP)	4GB(2x 2GB)	DS	-	-	9	1.65V	*	*
PATRIOT	PVV34G2400C9K(XMP)	4GB(2x 2GB)	DS	-	-	9-11-9-27	1.65V	*	*

* The 2400MHz memory modules above are supported by this motherboard; however, the actual frequency support varied depending on the O.C. margin of the installed CPU.

** Due to Intel 2nd generation processors' behavior, DDR3 2200 and above/2000/1800 MHz memory module runs at DDR3 2133/1866/1600 MHz frequency as default.

P8Z77-I DELUXE Motherboard Qualified Vendors Lists (QVL) DDR3 2225(O.C.) MHz capability

Vendors	Part No.	Size	SS/ DS	Chip Brand	Chip NO.	Timing	Voltage	DIMM socket support (Optional)	
								1 DIMM	2 DIMMs
Kingston	KHX2250C9D3T1K2/ 4GX(XMP)	4GB(2x 2GB)	DS	-	-	-	1.65V	*	*

* The 2225MHz memory modules above are supported by this motherboard; however, the actual frequency support varied depending on the O.C. margin of the installed CPU.

** Due to Intel 2nd generation processors' behavior, DDR3 2200 and above/2000/1800 MHz memory module runs at DDR3 2133/1866/1600 MHz frequency as default.

P8Z77-I DELUXE Motherboard Qualified Vendors Lists (QVL) DDR3 2200(O.C.) MHz capability

Vendors	Part No.	Size	SS/ DS	Chip Brand	Chip NO.	Timing	Voltage	DIMM socket support (Optional)	
								1 DIMM	2 DIMMs
G.SKILL	F3-17600CL8D-4GBPS(XMP)	4GB(2 x 2GB)	DS	-	-	8-8-8-24	1.65V	*	*
GEIL	GET34GB2200C9DC(XMP)	2GB	DS	-	-	9-10-9-28	1.65V	*	*
GEIL	GET38GB2200C9ADC(XMP)	4GB	DS	-	-	9-11-9-28	1.65V	*	*
KINGMAX	FLKE85F-B8KJAA-FEIS(XMP)	2GB	DS	-	-	-	-	*	*
KINGMAX	FLKE85F-B8KHA EEIH(XMP)	4GB(2 x 2GB)	DS	-	-	-	1.5V-1.7V	*	*
KINGMAX	FLKE85F-B8KJA FEIH(XMP)	4GB(2 x 2GB)	DS	-	-	-	1.5V-1.7V	*	*

* The memory modules in 2200MHz and above are supported by this motherboard; however, the actual frequency support varies depending on the O.C. margin of the installed CPU.

** Due to Intel 2nd generation processors' behavior, DDR3 2200 and above/2000/1800 MHz memory module runs at DDR3 2133/1866/1600 MHz frequency as default.

P8Z77-I DELUXE Motherboard Qualified Vendors Lists (QVL) DDR3 2133(O.C.) MHz capability

Vendors	Part No.	Size	SS/ DS	Chip Brand	Chip NO.	Timing	Voltage	DIMM socket support (Optional)	
								1 DIMM	2 DIMMs
A-DATA	AX3U2133GC2G9B-DG2(XMP)	2GB	SS	-	-	9-11-9-27	1.55-1.75V	*	*
CORSAIR	CMT16GX3M4X2133C9(XMP 1.3)	16GB(GB x4)	DS	-	-	9-11-10-27	1.50V	*	*
CORSAIR	CMT4GX3M2A2133C9(XMP)	4GB(2x 2GB)	DS	-	-	9-10-9-24	1.65V	*	*
CORSAIR	CMT4GX3M2B2133C9(XMP)	4GB(2x 2GB)	DS	-	-	9-10-9-27	1.50V	*	*
G.SKILL	F3-17000CL9Q-16GBZ(XMP)	16GB(4GB x4)	DS	-	-	9-11-10-28	1.65V	*	*
GEIL	GE34GB2133C9DC(XMP)	2GB	DS	-	-	9-9-9-28	1.65V	*	*
GEIL	GU34GB2133C9DC(XMP)	4GB(2 x 2GB)	DS	-	-	9-9-9-28	1.65V	*	*
KINGSTON	KHX2133C9AD3T1K2/4GX(XMP)	4GB(2x 2GB)	DS	-	-	-	1.65V	*	*
KINGSTON	KHX2133C9AD3X2K2/4GX(XMP)	4GB(2 x 2GB)	DS	-	-	9-11-9-27	1.65V	*	*
KINGSTON	KHX2133C9AD3T1K4/8GX(XMP)	8GB(4 x 2GB)	DS	-	-	9-11-9-27	1.65V	*	*
KINGSTON	KHX2133C9AD3T1FK4/8GX(XMP)	8GB(4x 2GB)	DS	-	-	-	1.65V	*	*

P8Z77-I DELUXE Motherboard Qualified Vendors Lists (QVL) DDR3 2000(O.C.) MHz capability

Vendors	Part No.	Size	SS/ DS	Chip Brand	Chip NO.	Timing	Voltage	DIMM socket support (Optional)	
								1 DIMM	2 DIMMs
Apacer	78.AAGD5.9KD(XMP)	6GB(3 x 2GB)	DS	-	-	9-9-9-27	1.65V	*	*
CORSAIR	CMZ4GX3M2A2000C10(XMP)	4GB(2 x 2GB)	SS	-	-	10-10-10-27	1.50V	*	*
CORSAIR	CMT6GX3M3A2000C8(XMP)	6GB(3 x 2GB)	DS	-	-	8-9-8-24	1.65V	*	*
G.SKILL	F3-16000CL9D-4GBFLS(XMP)	4GB(2 x 2GB)	DS	-	-	9-9-9-24	1.65V	*	*
G.SKILL	F3-16000CL9D-4GBTD(XMP)	4GB(2 x 2GB)	DS	-	-	9-9-9-27	1.65V	*	*
G.SKILL	F3-16000CL6T-6BPPIS(XMP)	6GB (3x 2GB)	DS	-	-	6-9-6-24	1.65V	*	*
GEIL	GLP34GB2000C9DC(XMP)	4GB(2 x 2GB)	DS	-	-	9-9-9-28	1.65V	*	*
KINGSTON	KHX2000C9AD3T1K2/ 4GX(XMP)	4GB(2x 2GB)	DS	-	-	-	1.65V	*	*
KINGSTON	KHX2000C9AD3W1K2/ 4GX(XMP)	4GB(2x 2GB)	DS	-	-	-	1.65V	*	*
KINGSTON	KHX2000C9AD3T1K2/ 4GX(XMP)	4GB(2 x 2GB)	DS	-	-	9	1.65V	*	*
KINGSTON	KHX2000C9AD3W1K3/ 6GX(XMP)	6GB(3x 2GB)	DS	-	-	-	1.65V	*	*
KINGSTON	KHX2000C9AD3T1K3/ 6GX(XMP)	6GB (3x 2GB)	DS	-	-	-	1.65V	*	*
Transcend	TX2000KLN-8GK(XMP)	8GB(2 x 4GB)	DS	-	-	-	1.6V	*	*
Asint	SLA302G08-ML2HB(XMP)	4GB	DS	HYNIX	H5TQ2G8 3BFR H9C	-	-	*	*
PATRIOT	PVT36G2000LLK	6GB(3 x 2GB)	DS	-	-	8-8-8-24	1.65V	*	*

P8Z77-I DELUXE Motherboard Qualified Vendors Lists (QVL) DDR3 1866(O.C.) MHz capability

Vendors	Part No.	Size	SS/ DS	Chip Brand	Chip NO.	Timing	Voltage	DIMM socket support (Optional)	
								1 DIMM	2 DIMMs
CORSAIR	CMT4GX3M2A1866C9(XMP)	4GB(2 x 2GB)	DS	-	-	9-9-9-24	1.65V	*	*
CORSAIR	CMT6GX3MA1866C9(XMP)	6GB(3 x 2GB)	DS	-	-	9-9-9-24	1.65V	*	*
CORSAIR	CMZ8GX3M2A1866C9(XMP)	8GB(2 x 4GB)	DS	-	-	9-10-9-27	1.50V	*	*
G.SKILL	F3-14900CL9Q-16GBZL(XMP)	16GB(4 x 4GB)	DS	-	-	9-10-9-28	1.5V	*	*
G.SKILL	F3-14900CL10Q2- 64GBZLD(XMP)	64GB(8x 8GB)	DS	-	-	10-11-10-30	1.5V	*	*
G.SKILL	F3-14900CL9D-8GBXL(XMP)	8GB(2 x 4GB)	DS	-	-	9-10-9-28	1.5V	*	*
G.SKILL	F3-14900CL9Q-8GBXL(XMP)	8GB(4 x 2GB)	DS	-	-	9-9-9-24	1.6V	*	*
KINGSTON	KHX1866C9D3T1K3/ 3GX(XMP)	3GB(3 x 1GB)	SS	-	-	-	1.65V	*	*
KINGSTON	KHX1866C9D3K4/16GX(XMP)	16GB(4 x 4GB)	DS	-	-	-	1.65V	*	*
KINGSTON	KHX1866C9D3T1K3/ 6GX(XMP)	6GB(3 x 2GB)	DS	-	-	-	1.65V	*	*
KINGSTON	KHX1866C11D3P1K2/8G	8GB(2 x 4GB)	DS	-	-	-	1.5V	*	*

P8Z77-I DELUXE Motherboard Qualified Vendors Lists (QVL)

DDR3 1600 MHz capability

Vendors	Part No.	Size	SS/DS	Chip Brand	Chip NO.	Timing	Voltage	DIMM socket support (Optional)	
								1 DIMM	2 DIMM
A-DATA	AM2U16BC2P1	2GB	SS	A-DATA	3CCD-1509A EL1126T	-	-	*	*
A-DATA	AD31600E001GM(O)U3K	3GB(3 x 1GB)	SS	-	-	8-8-8-24	1.65V-1.85V	*	*
A-DATA	AX3U1600XB2G79-2X(XMP)	4GB(2 x 2GB)	DS	-	-	7-9-7-21	1.55V-1.75V	*	*
A-DATA	AM2U16BC4P2	4GB	DS	A-DATA	3CCD-1509A EL1126T	-	-	*	*
A-DATA	AX3U1600GC4G9-2G(XMP)	8GB(2 x 4GB)	DS	-	-	9-9-9-24	1.55V-1.75V	*	*
A-DATA	AX3U1600XC4G79-2X(XMP)	8GB(2 x 4GB)	DS	-	-	7-9-7-21	1.55V-1.75V	*	*
CORSAIR	TR3X3G1600C8D(XMP)	3GB(3 x 1GB)	SS	-	-	8-8-8-24	1.65V	*	*
CORSAIR	CMD12GX3M6A1600C8(XMP)	12GB(6x2GB)	DS	-	-	8-8-8-24	1.65V	*	*
CORSAIR	CMP4GX3M2A1600C8(XMP)	4GB(2 x 2GB)	DS	-	-	8-8-8-24	1.65V	*	*
CORSAIR	CMP4GX3M2A1600C9(XMP)	4GB(2 x 2GB)	DS	-	-	9-9-9-24	1.65V	*	*
CORSAIR	CMP4GX3M2C1600C7(XMP)	4GB(2 x 2GB)	DS	-	-	7-8-7-20	1.65V	*	*
CORSAIR	CMX4GX3M2A1600C9(XMP)	4GB(2 x 2GB)	DS	-	-	9-9-9-24	1.65V	*	*
CORSAIR	CMX4GX3M2A1600C9(XMP)	4GB(2 x 2GB)	DS	-	-	9-9-9-24	1.65V	*	*
CORSAIR	TR3X6G1600C8 G(XMP)	6GB(3 x 2GB)	DS	-	-	8-8-8-24	1.65V	*	*
CORSAIR	TR3X6G1600C8D G(XMP)	6GB(3 x 2GB)	DS	-	-	8-8-8-24	1.65V	*	*
CORSAIR	TR3X6G1600C9 G(XMP)	6GB(3 x 2GB)	DS	-	-	9-9-9-24	1.65V	*	*
CORSAIR	CMP8GX3M2A1600C9(XMP)	8GB(2 x 4GB)	DS	-	-	9-9-9-24	1.65V	*	*
CORSAIR	CMX8GX3M2A1600C7R(XMP)	8GB(2 x 4GB)	DS	-	-	7-8-7-20	1.50V	*	*
CORSAIR	CMX8GX3M4A1600C9(XMP)	8GB(4 x 2GB)	DS	-	-	9-9-9-24	1.65V	*	*
Crucial	BL25664BN1608.16FF(XMP)	6GB(3 x 2GB)	DS	-	-	-	-	*	*
G.SKILL	F3-12800CL9D-2GBNQ(XMP)	2GB(2 x 1GB)	SS	-	-	9-9-9-24	1.5V	*	*
G.SKILL	F3-12800CL7D-4GBRH(XMP)	4GB(2 x 2GB)	SS	-	-	7-7-7-24	1.6V	*	*
G.SKILL	F3-12800CL7D-4GBECO(XMP)	4GB(2 x 2GB)	DS	-	-	7-7-8-24	XMP 1.35V	*	*
G.SKILL	F3-12800CL7D-4GBRM(XMP)	4GB(2 x 2GB)	DS	-	-	7-8-7-24	1.6V	*	*
G.SKILL	F3-12800CL8D-4GBRM(XMP)	4GB(2 x 2GB)	DS	-	-	8-8-8-24	1.60V	*	*
G.SKILL	F3-12800CL9D-4GBECO(XMP)	4GB(2 x 2GB)	DS	-	-	9-9-9-24	XMP 1.35V	*	*
G.SKILL	F3-12800CL9D-4GBRL(XMP)	4GB(2 x 2GB)	DS	-	-	9-9-9-24	1.5V	*	*
G.SKILL	F3-12800CL9T-6GBNQ(XMP)	6GB(3 x 2GB)	DS	-	-	9-9-9-24	1.5V~1.6V	*	*
G.SKILL	F3-12800CL7D-8GBRH(XMP)	8GB(2 x 4GB)	DS	-	-	7-8-7-24	1.6V	*	*
G.SKILL	F3-12800CL8D-8GBECO(XMP)	8GB(2 x 4GB)	DS	-	-	8-8-8-24	XMP 1.35V	*	*
G.SKILL	F3-12800CL9D-8GBRL(XMP)	8GB(2 x 4GB)	DS	-	-	9-9-9-24	1.5V	*	*
GEIL	GET316GB1600C9QC(XMP)	16GB (4x 4GB)	DS	-	-	9-9-9-28	1.6V	*	*
GEIL	GV34GB1600C8DC(XMP)	2GB	DS	-	-	8-8-8-28	1.6V	*	*
KINGMAX	FLGD45F-B8MF7 MAEH(XMP)	1GB	SS	-	-	7	-	*	*
KINGMAX	FLGE85F-B8KJ9A FEIS(XMP)	2GB	DS	-	-	-	-	*	*
KINGMAX	FLGE85F-B8MF7 MEEH(XMP)	2GB	DS	-	-	7	-	*	*
KINGSTON	KHX1600C9D3P1K2/4G	4GB(2 x 2GB)	SS	-	-	-	1.5V	*	*
KINGSTON	KHX1600C9D3K3/12GX(XMP)	12GB(3x4GB)	DS	-	-	9-9-9-27	1.65V	*	*
KINGSTON	KHX1600C9D3T1BK3/12GX(XMP)	12GB(3x4GB)	DS	-	-	9-9-9-27	1.65V	*	*
KINGSTON	KHX1600C9D3K4/16GX(XMP)	16GB (4GB x4)	DS	-	-	-	1.65V	*	*
KINGSTON	KHX1600C9AD3/2G	2GB	DS	-	-	-	1.65V	*	*
KINGSTON	KVR1600D3N11/2G-ES	2GB	DS	KTC	D1288JPN DPLD9U	11-11-11-28	1.35V-1.5V	*	*
KINGSTON	KHX1600C7D3K2/4GX(XMP)	4GB (2x 2GB)	DS	-	-	-	1.65V	*	*
KINGSTON	KHX1600C8D3K2/4GX(XMP)	4GB(2 x 2GB)	DS	-	-	8	1.65V	*	*
KINGSTON	KHX1600C8D3T1K2/4GX(XMP)	4GB(2 x 2GB)	DS	-	-	8	1.65V	*	*
KINGSTON	KHX1600C9D3K2/4GX(XMP)	4GB(2 x 2GB)	DS	-	-	9	1.65V	*	*
KINGSTON	KHX1600C9D3LK2/4GX(XMP)	4GB(2 x 2GB)	DS	-	-	9	XMP 1.35V	*	*
KINGSTON	KHX1600C9D3K2K2/4GX(XMP)	4GB(2 x 2GB)	DS	-	-	9-9-9-27	1.65V	*	*
KINGSTON	KHX1600C9D3T1K3/6GX(XMP)	6GB (3x 2GB)	DS	-	-	-	1.65V	*	*
KINGSTON	KHX1600C9D3K3/6GX(XMP)	6GB(3 x 2GB)	DS	-	-	9	1.65V	*	*
KINGSTON	KHX1600C9D3T1BK3/6GX(XMP)	6GB(3 x 2GB)	DS	-	-	9-9-9-27	1.65V	*	*
KINGSTON	KHX1600C9D3K2/8GX(XMP)	8GB(2 x 4GB)	DS	-	-	9-9-9-27	1.65V	*	*
KINGSTON	KHX1600C9D3P1K2/8G	8GB(2 x 4GB)	DS	-	-	-	1.5V	*	*

(continued on the next page)

P8Z77-I DELUXE Motherboard Qualified Vendors Lists (QVL) DDR3 1600 MHz capability (continued)

Vendors	Part No.	Size	SS/ DS	Chip Brand	Chip NO.	Timing	Voltage	DIMM socket support (Optional)
								1 DIMM 2 DIMMs
Super Talent	WA160UX6G9	6GB(3 x 2GB)	DS	-	-	9	-	* *
Transcend	JM1600KLN-8GK	8GB(4GBx2)	DS	Transcend	TK483PCW3	-	-	* *
Asint	SLZ3128M8-EGJ1D(XMP)	2GB	DS	Asint	3128M8-GJ1D	9-9-9-24	1.6V	* *
Asint	SLA302G08-EGG1C(XMP)	4GB	DS	Asint	302G08-GG1C	-	-	* *
Asint	SLA302G08-EGJ1C(XMP)	4GB	DS	Asint	302G08-GJ1C	-	-	* *
Elixir	M2P2G64CB8HC9N-DG(XMP)	2GB	DS	-	-	-	-	* *
Mushkin	998659(XMP)	6GB(3 x 2GB)	DS	-	-	9-9-9-24	-	* *
Mushkin	998659(XMP)	6GB(3 x 2GB)	DS	-	-	9-9-9-24	1.5~1.6V	* *
PATRIOT	PGS34G1600LLKA	4GB(2 x 2GB)	DS	-	-	7-7-7-20	1.7V	* *
SanMax	SMD-4G68HP-16KZ	4GB	DS	HYNIX	H5TQ2G8 3BFR PBC	-	-	* *

P8Z77-I DELUXE Motherboard Qualified Vendors Lists (QVL) DDR3 1333 MHz capability

Vendors	Part No.	Size	SS/ DS	Chip Brand	Chip NO.	Timing	Voltage	DIMM socket support (Optional)
								1 DIMM 2 DIMMs
A-DATA	AD31333001GOU	1GB	SS	A-Data	AD30908C8D- 151C E0906	-	-	* *
A-DATA	AD3U1333C2G9	2GB	SS	A-DATA	3CCD-1509HNA1126L	-	-	* *
A-DATA	AD6311B0823EV	2GB	SS	A-Data	3CCA-1509A	-	-	* *
A-DATA	AM2U139C2P1	2GB	SS	ADATA	3CCD-1509A EL1127T	-	-	* *
A-DATA	AX3U1333C2G9-BP	2GB	SS	-	-	-	-	* *
A-DATA	AD31333G001GOU	3GB(3 x 1GB)	SS	-	-	8-8-8-24	1.65-1.85V	* *
A-DATA	AXDU1333C2G9-2G(XMP)	4GB(2 x 2GB)	SS	-	-	9-9-9-24	1.25V-1.35V (low voltage)	* *
A-DATA	AD31333G002GMU	2GB	DS	-	-	8-8-8-24	1.65-1.85V	* *
A-DATA	AD6311C1624EV	4GB	DS	A-Data	3CCA-1509A	-	-	* *
A-DATA	AM2U139C4P2	4GB	DS	ADATA	3CCD-1509A EL1127T	-	-	* *
A-DATA	SU3U1333W8G9-B	8GB	DS	ELPIDA	J4208BASE-DJ-F	-	-	* *
Apacer	78.A1GC6.9L1	2GB	DS	Apacer	AM5D5808DEWSBG	-	-	* *
Apacer	78.A1GC6.9L1	2GB	DS	Apacer	AM5D5808FEQSBG	9	-	* *
Apacer	AU02GFA33C9NBGC	2GB	DS	Apacer	AM5D5808APQSBG	-	-	* *
Apacer	78.B1GDE.9L10C	4GB	DS	Apacer	AM5D5808CEHSBG	-	-	* *
CORSAIR	TR3X3G1333C9 G	3GB(3 x 1GB)	SS	-	-	9-9-9-24	1.50V	* *
CORSAIR	TR3X6G1333C9 G	6GB(3x 2GB)	SS	-	-	9-9-9-24	1.50V	* *
CORSAIR	CMD24GX3M6A1333C9(XMP)	24GB(6x4GB)	DS	-	-	9-9-9-24	1.60V	* *
CORSAIR	TW3X4G1333C9D G	4GB(2 x 2GB)	DS	-	-	9-9-9-24	1.50V	* *
CORSAIR	CM3X4GA1333C9N2	4GB	DS	CORSAIR	256MBDCJ GELC0401136	9-9-9-24	-	* *
CORSAIR	CMX4GX3M1A1333C9	4GB	DS	-	-	9-9-9-24	1.50V	* *
CORSAIR	CMDBGX3M4A1333C7	8GB(4 x 2GB)	DS	-	-	7-7-7-20	1.60V	* *
Crucial	CT12864BA1339.8FF	1GB	SS	Micron	9FF22D9KPT	9	-	* *
Crucial	CT25664BA1339.16FF	2GB	DS	Micron	9KF27D9KPT	9	-	* *
Crucial	BL25664BN1337.16FF (XMP)	6GB(3 x 2GB)	DS	-	-	7-7-7-24	1.65V	* *
ELPIDA	EBJ10UE8EDF0-DJ-F	1GB	SS	ELPIDA	J1108EDSE-DJ-F	-	1.35V(low voltage)	* *
ELPIDA	EBJ21UE8EDF0-DJ-F	2GB	DS	ELPIDA	J1108EDSE-DJ-F	-	1.35V(low voltage)	* *
G.SKILL	F3-10600CL8D-2GBHK(XMP)	1GB	SS	G.SKILL	-	-	-	* *
G.SKILL	F3-10600CL9D-2GBNQ	2GB(2 x 1GB)	SS	-	-	9-9-9-24	1.5V	* *
G.SKILL	F3-10666CL7T-3GBPK(XMP)	3GB(3 x 1GB)	SS	-	-	7-7-7-18	1.5~1.6V	* *
G.SKILL	F3-10666CL8D- 4GBECO(XMP)	4GB(2 x 2GB)	DS	-	-	8-8-8-8-24	XMP 1.35V	* *
G.SKILL	F3-10666CL7T-6GBPK(XMP)	6GB(3 x 2GB)	DS	-	-	7-7-7-18	1.5~1.6V	* *
G.SKILL	F3-10666CL7D-8GBRH(XMP)	8GB(2 x 4GB)	DS	-	-	7-7-7-21	1.5V	* *

(continued on the next page)

P8Z77-I DELUXE Motherboard Qualified Vendors Lists (QVL)

DDR3 1333 MHz capability

Vendors	Part No.	Size	SS/DS	Chip Brand	Chip NO.	Timing	Voltage	DIMM socket support (Optional)	
								1 DIMM	2 DIMMs
GEIL	GV32GB1333C9DC	2GB(2 x 1GB)	DS	-	-	9-9-9-24	1.5V	*	*
GEIL	GG34GB1333C9DC	4GB(2 x 2GB)	DS	GEIL	GL1L128M88BA12N	9-9-9-24	1.3V(low voltage)	*	*
GEIL	GV34GB1333C9DC	4GB(2 x 2GB)	DS	-	-	9-9-9-24	1.5V	*	*
GEIL	GVP34GB1333C7DC	4GB(2 x 2GB)	DS	-	-	7-7-7-24	1.5V	*	*
Hynix	HMT112U6TFR8A-H9	1GB	SS	Hynix	H5TC1G83TFRH9A	-	1.35V(low voltage)	*	*
Hynix	HMT325U6BFR8C-H9	2GB	SS	Hynix	H5TQ2G83BFRH9C	-	-	*	*
Hynix	HMT125U6TFR8A-H9	2GB	DS	Hynix	H5TC1G83TFRH9A	-	1.35V(low voltage)	*	*
Hynix	HMT351U6BFR8C-H9	4GB	DS	Hynix	H5TQ2G83BFRH9C	-	-	*	*
KINGMAX	FLFD45F-B8KL9 NAE5	1GB	SS	KINGMAX	KKB8FNWBFGNX-27A	-	-	*	*
KINGMAX	FLFE85F-C8KF9 CAES	2GB	SS	KINGMAX	KFC8FMFXF-DXX-15A	-	-	*	*
KINGMAX	FLFE85F-C8KL9 NAE5	2GB	SS	KINGMAX	KFC8FNLXF-DXX-15A	-	-	*	*
KINGMAX	FLFE85F-C8KM9 NAE5	2GB	SS	KINGMAX	KFC8FNMXF-BXX-15A	-	-	*	*
KINGMAX	FLFE85F-B8KL9 NEE5	2GB	DS	KINGMAX	KKB8FNWBFGNX-26A	-	-	*	*
KINGMAX	FLFF65F-C8KL9 NEE5	4GB	DS	KINGMAX	KFC8FNLXF-DXX-15A	-	-	*	*
KINGMAX	FLFF65F-C8KM9 NEE5	4GB	DS	KINGMAX	KFC8FNMXF-BXX-15A	-	-	*	*
KINGSTON	KVR1333D3N9/1G(low profile)	1GB	SS	ELPIDA	J1108BDBG-DJ-F	9	1.5V	*	*
KINGSTON	KVR1333D3N9/2G(low profile)	2GB	SS	Hynix	H5TQ2G83AFRH9C	9	-	*	*
KINGSTON	KVR1333D3S8N9/2G	2GB	SS	Micron	IID77 D9L GK	-	1.5V	*	*
KINGSTON	KVR1333D3S8N9/2G-SP (low profile)	2GB	SS	ELPIDA	J2108BCSE-DJ-F	-	1.5V	*	*
KINGSTON	KVR1333D3N9/2G(low profile)	2GB	DS	ELPIDA	J1108BFBG-DJ-F	9	1.5V	*	*
KINGSTON	KVR1333D3N9/2G	2GB	DS	KTC	D1288JPNLD9U	9	1.5V	*	*
KINGSTON	KVR1333D3N9/2G	2GB	DS	ELPIDA	J1108BDSJ-DJ-F	9	1.5V	*	*
KINGSTON	KVR1333D3N9/2G-SP(low profile)	2GB	DS	KTC	D1288JEMFG9DU	-	1.5V	*	*
KINGSTON	KVR1333D3N9/2G-SP(low profile)	2GB	DS	KINGSTON	D1288JPSFPDG9U	-	1.5V	*	*
KINGSTON	KHX1333C7D3K2/4GX(XMP)	4GB(2 x 2GB)	DS	-	-	7	1.65V	*	*
KINGSTON	KHX1333C9D3UK2/4GX(XMP)	4GB(2 x 2GB)	DS	-	-	9	XMP 1.25V	*	*
KINGSTON	KVR1333D3N9/4G(low profile)	4GB	DS	ELPIDA	J2108BCSE-DJ-F	9	1.5V	*	*
KINGSTON	KVR1333D3N9/4G(low profile)	4GB	DS	ELPIDA	J2108BCSE-DJ-F	-	1.5V	*	*
KINGSTON	KVR1333D3N9/4G	4GB	DS	KTC	D2568JENCNG9U	-	1.5V	*	*
KINGSTON	KVR1333D3N9/4G	4GB	DS	Hynix	H5TQ2G83AFR	-	-	*	*
KINGSTON	KVR1333D3N9/4G-SP(low profile)	4GB	DS	KINGSTON	D2568JENCNG9U	-	1.5V	*	*
Micron	MT4JTF12864AZ-1G4D1	1GB	SS	Micron	QJD12D9LQG	-	-	*	*
Micron	MT8JTF12864AZ-1G4F1	1GB	SS	Micron	9FF22D9KPT	9	-	*	*
Micron	MT8JTF25664AZ-1G4D1	2GB	SS	Micron	QJD12D9L GK	-	-	*	*
Micron	MT8JTF25664AZ-1G4M1	2GB	SS	MICRON	IJM22 D9PFT	-	-	*	*
Micron	MT16JTF25664AZ-1G4F1	2GB	DS	Micron	9KF27D9KPT	9	-	*	*
Micron	MT16JTF51264AZ-1G4D1	4GB	DS	Micron	OLD22D9L GK	-	-	*	*
NANYA	NT4GC64B8HG0NF-CG	4GB	DS	NANYA	NT5C8256M8GN-CG	-	-	*	*
PSC	AL7F8G73F-DJ2	1GB	SS	PSC	A3P1GF3FGF	-	-	*	*
PSC	AL8F8G73F-DJ2	2GB	DS	PSC	A3P1GF3FGF	-	-	*	*
SAMSUNG	M378B2873FHS-CH9	1GB	SS	SAMSUNG	K4B1G0846F	-	-	*	*
SAMSUNG	M378B5773DH0-CH9	2GB	SS	SAMSUNG	K4B2G0846D	-	-	*	*
SAMSUNG	M378B5673FH0-CH9	2GB	DS	SAMSUNG	K4B1G0846F	-	-	*	*
SAMSUNG	M378B5273CH0-CH9	4GB	DS	SAMSUNG	K4B2G0846C	-	-	*	*
SAMSUNG	M378B1G73AH0-CH9	8GB	DS	SAMSUNG	K4B4G0846A-HCH9	-	-	*	*
Super Talent	W1333UA1GH	1GB	SS	Hynix	H5TQ1G83TFR	9	-	*	*
Super Talent	W1333UX2G8(XMP)	2GB(2x 1GB)	SS	-	-	8	-	*	*
Super Talent	W1333UB2GS	2GB	DS	SAMSUNG	K4B1G0846F	9	-	*	*
Super Talent	W1333UB4GS	4GB	DS	SAMSUNG	K4B2G0846C	-	-	*	*
Super Talent	W1333UX6GM	6GB(3x 2GB)	DS	Micron	0BF27D9KPT	9-9-9-24	1.5V	*	*
Transcend	JM1333KLN-2G	2GB	SS	Hynix	H5TQ2G83BZRH9C	-	-	*	*

(continued on the next page)

P8Z77-I DELUXE Motherboard Qualified Vendors Lists (QVL) DDR3 1333 MHz capability (continued)

Vendors	Part No.	Size	SS/ DS	Chip Brand	Chip NO.	Timing	Voltage	DIMM socket support (Optional)	
								1 DIMM	2 DIMMs
Transcend	TS256MLK64V3U	2GB	DS	Micron	9GF27D9KPT	-	-	*	*
Century	PC3-10600 DDR3-1333 9-9-9	1GB	SS	NANYA	NT5CB128M8DN-CF	-	-	*	*
Elixir	M2F2G64CB88B7N-CG	2GB	SS	Elixir	N2CB2G80BN-CG	-	-	*	*
Elixir	M2F2G64CB88D7N-CG	2GB	SS	Elixir	N2CB2G80DN-CG	-	-	*	*
Elixir	M2F2G64CB88G7N-CG	2GB	SS	Elixir	N2CB2G80GN-CG	-	-	*	*
Elixir	M2F4G64CB88B5N-CG	4GB	DS	Elixir	N2CB2G80BN-CG	-	-	*	*
Elixir	M2F4G64CB88D5N-CG	4GB	DS	Elixir	N2CB2G80DN-CG	-	-	*	*
KINGSHARE	KSRPCD313332G	2GB	DS	PATRIOT	PM128M8D385-15	-	-	*	*
KINGSTEK	KSTD3PC-10600	2GB	SS	MICRON	PE911-125E	-	-	*	*
Kingtiger	2GB DIMM PC3-10666	2GB	DS	SAMSUNG	SEC 904 HCH9 K4B1G0846D	-	-	*	*
Kingtiger	KTG2G1333PG3	2GB	DS	-	-	-	-	*	*
MARKVISION	BMD32048M1333C9-1123	2GB	DS	MARKVI SION	M3D1288P-13	-	-	*	*
MARKVISION	BMD34096M1333C9-1124	4GB	DS	MARKVI SION	M3D2568E-13	-	-	*	*
PATRIOT	PSD31G13332H	1GB	DS	-	-	9	-	*	*
PATRIOT	PSD31G13332	1GB	DS	PATRIOT	PM64M8D38U-15	-	-	*	*
PATRIOT	PSD32G13332H	2GB	DS	-	-	-	-	*	*
PATRIOT	PG38G1333EL(XMP)	8GB	DS	-	-	9-9-9-24	1.5V	*	*
RAMAXEL	RMR1870ED48E8F-1333	2GB	DS	ELPIDA	J1108BDBG-DJ-F	-	-	*	*
RAMAXEL	RMR1870EC58E9F-1333	4GB	DS	ELPIDA	J2108BCSE-DJ-F	-	-	*	*
RiDATA	C304627CB1AG22Fe	2GB	DS	RiDATA	N/A	9	-	*	*
RiDATA	E304459CB1AG32Cf	4GB	DS	RiDATA	N/A	9	-	*	*
SILICON POWER	SP001GBLTU133S01	1GB	SS	NANYA	NT5CB128M8AN-CG	9	-	*	*
SILICON POWER	SP001GBLTU133S02	1GB	SS	Elixir	N2CB1680AN-C6	9	-	*	*
SILICON POWER	SP002GBLTU133S02	2GB	DS	Elixir	N2CB1680AN-C6	9	-	*	*
TAKEMS	TMS1GB364D081-107EY	1GB	SS	-	-	7-7-7-20	1.5V	*	*
TAKEMS	TMS2GB364D081-107EY	2GB	DS	-	-	7-7-7-20	1.5V	*	*
TAKEMS	TMS2GB364D081-138EY	2GB	DS	-	-	8-8-8-24	1.5V	*	*
TAKEMS	TMS2GB364D082-138EW	2GB	DS	-	-	8-8-8-24	1.5V	*	*
UMAX	E41302GP0-73BDB	2GB	DS	UMAX	U2S24D30TP-13	-	-	*	*

P8Z77-I DELUXE Motherboard Qualified Vendors Lists (QVL) DDR3 1066 MHz capability (continued)

Vendors	Part No.	Size	SS/ DS	Chip Brand	Chip NO.	Timing	Voltage	DIMM socket support (Optional)	
								1 DIMM	2 DIMMs
Crucial	CT12864BA1067.8FF	1GB	SS	Micron	9GF22D9KPT	7	-	*	*
Crucial	CT25664BA1067.16FF	2GB	DS	Micron	9HF22D9KPT	7	-	*	*
ELPIDA	EBJ10UE8EDF0-AE-F	1GB	SS	ELPIDA	J1108EDSE-DJ-F	-	1.35V (low voltage)	*	*
ELPIDA	EBJ21UE8EDF0-AE-F	2GB	DS	ELPIDA	J1108EDSE-DJ-F	-	1.35V (low voltage)	*	*
KINGSTON	KVR1066D3N771G (low profile)	1GB	SS	ELPIDA	J1108BFSE-DJ-F	7	1.5V	*	*
KINGSTON	KVR1066D3N72G	2GB	DS	ELPIDA	J1108BDSE-DJ-F	7	1.5V	*	*
KINGSTON	KVR1066D3N74G	4GB	DS	Hynix	H5TQ2G83AFR	7	1.5V	*	*
Micron	MT8JTF12864AZ-1G1F1	1GB	SS	Micron	9GF22D9KPT	7	-	*	*
Micron	MT16JTF25664AZ-1G1F1	2GB	DS	Micron	9HF22D9KPT	7	-	*	*
Kingtiger	2GB DIMM PC3-8500	2GB	DS	Hynix	H5TQ1G83AFP G7C	-	-	*	*



**Side(s): SS - Single-sided DS - Double-sided
DIMM support:**

- **1 DIMM:** Supports one (1) module inserted into any slot as Single-channel memory configuration. **We suggest that you install the module into A1 slot.**
 - **2 DIMMs:** Supports two (2) modules inserted into both slots as one pair of Dual-channel memory configuration.
-



- ASUS exclusively provides hyper DIMM support function.
 - Hyper DIMM support is subject to the physical characteristics of individual CPUs. Load the X.M.P. or D.O.C.P. settings in the BIOS for the hyper DIMM support.
 - Visit the ASUS website for the latest QVL.
-

2.2.4 Expansion slot



Ensure to unplug the power cord before adding or removing expansion cards. Failure to do so may cause you physical injury and damage motherboard components.

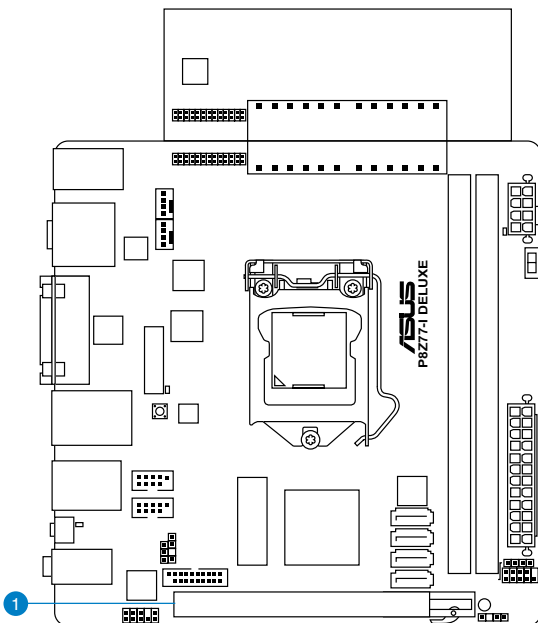

Slot No.	Slot Description
1	PCIe 3.0/2.0 x16 slot (x16)



- The PCIe 3.0 speed is supported by Intel® 3rd generation Core™ processors.

IRQ assignments for this motherboard

	A	B	C	D	E	F	G	H
Intel PCH SATA Controller #0	-	-	-	shared	-	-	-	-
Intel PCH SATA Controller #1	-	-	-	shared	-	-	-	-
SMBUS Controller		-	shared	-	-	-	-	-
Thermal Controller		-	shared	-	-	-	-	-
EHCI #0	-	-	-	-	-	-	-	shared
EHCI #1	shared	-	-	-	-	-	-	-
PCIe x16	shared	shared	shared	shared	-	-	-	-
ASMedia USB 3.0	shared	shared	shared	shared	-	-	-	-
Intel 82579V LAN	-	-	-	-	shared	-	-	-

2.2.5 Onboard switches

Onboard switches allow you to fine-tune performance when working on a bare or open-case system. This is ideal for overclockers and gamers who continually change settings to enhance system performance.

1. MemOK! switch

Installing DIMMs that are incompatible with the motherboard may cause system boot failure, and the DRAM_LED near the MemOK! switch lights continuously. Press to begin automatic memory compatibility tuning for successful boot.

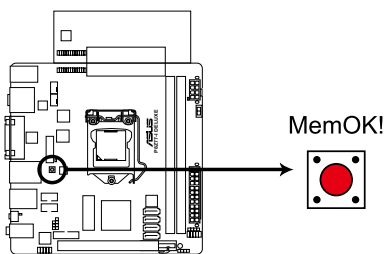

P8Z77-I DELUXE MemOK! switch



- Refer to section **2.2.6 Onboard LEDs** for the exact location of the DRAM_LED.
- The DRAM_LED also lights when the DIMM is not properly installed. Turn off the system and reinstall the DIMM before using the MemOK! function.
- The MemOK! switch does not function under Windows™ OS environment.
- During the tuning process, the system loads and tests failsafe memory settings. It takes about 30 seconds for the system to test one set of failsafe settings. If the test fails, the system reboots and test the next set of failsafe settings. The blinking speed of the DRAM_LED increases, indicating different test processes.
- Due to memory tuning requirements, the system automatically reboots when each timing set is tested. If the installed DIMMs still fail to boot after the whole tuning process, the DRAM_LED lights continuously. Replace the DIMMs with ones recommended in the Memory QVL (Qualified Vendors Lists) in this user manual or on the ASUS website at www.asus.com.
- If you turn off the computer and replace DIMMs during the tuning process, the system continues memory tuning after turning on the computer. To stop memory tuning, turn off the computer and unplug the power cord for about 5–10 seconds.
- If your system fail to boot due to BIOS overclocking, press the MemOK! switch to boot and load BIOS default settings. A message will appear during POST reminding you that the BIOS has been restored to its default settings.
- We recommend that you download and update to the latest BIOS version from the ASUS website at www.asus.com after using the MemOK! function.

2. TPU switch

Turning this switch to **Enable** will automatically optimize the system for fast, yet stable clock speeds.



For ensuring the system performance, turn the switch setting to **Enable** when the system is powered off.

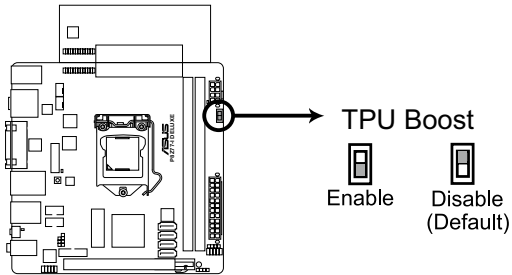

P8Z77-I DELUXE TPU Boost switch



- The TPU LED near the TPU switch lights when the switch setting is turned to **Enable**. Refer to section **2.2.6 Onboard LEDs** for the exact location of the TPU LED.
- If you change the switch setting to **Enable** under the OS environment, the TPU function will be activated after the next system bootup.
- You may use the TurboV and Auto Tuning feature in the TurboV EVO application, adjust the BIOS setup program, or enable the TPU switch at the same time. However, the system will use the last setting you have made.

2.2.6 Onboard LEDs

1. Onboard LED

The motherboard comes with a standby power LED that lights up to indicate that the system is ON, in sleep mode, or in soft-off mode. This is a reminder that you should shut down the system and unplug the power cable before removing or plugging in any motherboard component. The illustration below shows the location of the onboard LED.

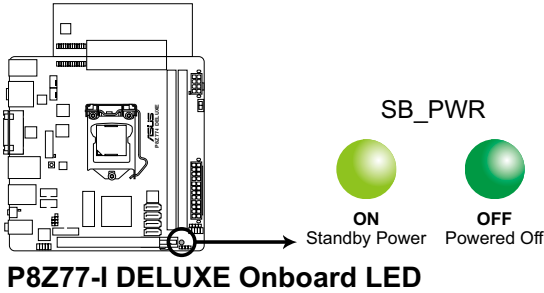

2. TPU LED

The TPU LED lights when the TPU switch is turned to **Enable**.

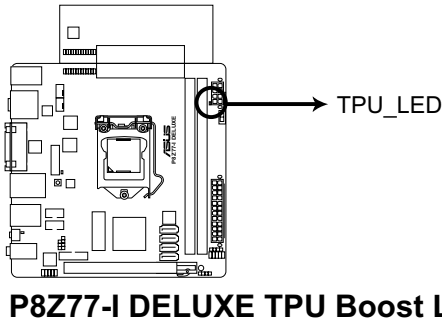

3. BIOS_FLBK LED

The BIOS_FLBK LED lights when the BIOS-FLBK function is enabled.

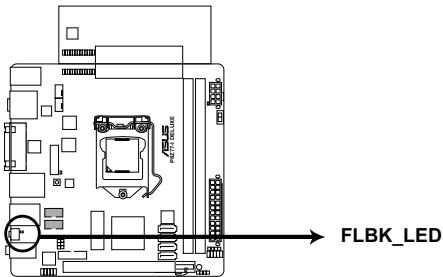

P8Z77-I DELUXE FLBK LED

4. DRAM LED

DRAM LED checks the DRAM in sequence during motherboard booting process. If an error is found, the LED next to the error device will continue lighting until the problem is solved. This user-friendly design provides an intuitional way to locate the root problem within a second.

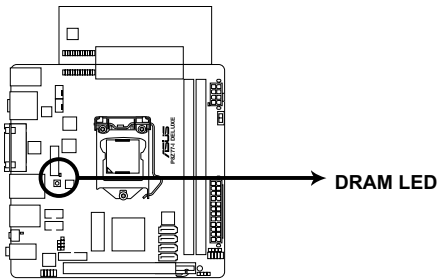

P8Z77-I DELUXE DRAM LED

2.2.7 Internal connectors

1. Intel® Z77 Serial ATA 6.0 Gb/s connectors (7-pin SATA6G_1/2 [gray])

These connectors connect to Serial ATA 6.0 Gb/s hard disk drives via Serial ATA 6.0 Gb/s signal cables.

If you installed Serial ATA hard disk drives, you can create a RAID 0, 1, 5, and 10 configuration with the Intel® Rapid Storage Technology through the onboard Intel® Z77 chipset.

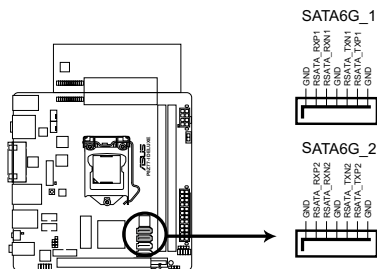

P8Z77-I DELUXE SATA 6.0Gb/s connectors



- These connectors are set to [AHCI Mode] by default. If you intend to create a Serial ATA RAID set using these connectors, set the **SATA Mode** item in the BIOS to [RAID Mode]. Refer to section **3.5.3 SATA Configuration** for details.
- Before creating a RAID set, refer to section **4.4 RAID configurations** or the manual bundled in the motherboard support DVD.
- When using NCQ, set the **SATA Mode** in the BIOS to [AHCI Mode]. Refer to section **3.5.3 SATA Configuration** for details.
- You must install Windows® XP Service Pack 3 or later versions before using Serial ATA hard disk drives. The Serial ATA RAID feature is available only if you are using Windows® XP SP3 or later versions.

2. Intel® Z77 Serial ATA 3.0 Gb/s connectors (7-pin SATA3G_1/2 [blue])

These connectors connect to Serial ATA 3.0 Gb/s hard disk drives and optical disc drives via Serial ATA 3.0 Gb/s signal cables.

If you installed Serial ATA hard disk drives, you can create a RAID 0, 1, 5, and 10 configuration with the Intel® Rapid Storage Technology through the onboard Intel® Z77 chipset.

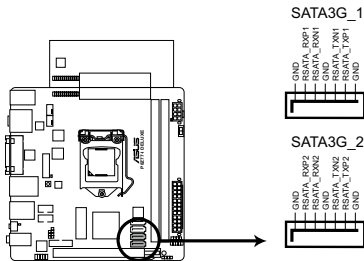

P8Z77-I DELUXE SATA 3.0Gb/s connectors



- These connectors are set to [AHCI Mode] by default. If you intend to create a Serial ATA RAID set using these connectors, set the **SATA Mode** item in the BIOS to [RAID Mode]. Refer to section **3.5.3 SATA Configuration** for details.
- Before creating a RAID set, refer to section **4.4 RAID configurations** or the manual bundled in the motherboard support DVD.
- When using NCQ, set the **SATA Mode** in the BIOS to [AHCI Mode]. Refer to section **3.5.3 SATA Configuration** for details.
- You must install Windows® XP Service Pack 3 or later versions before using Serial ATA hard disk drives. The Serial ATA RAID feature is available only if you are using Windows® XP SP3 or later versions.

3. USB 3.0 connector (20-1 pin USB3_34)

This connector is for the additional USB 3.0 ports, and complies with the USB 3.0 specification that supports up to 5Gbps connection speed. If the USB 3.0 front panel cable is available from your system chassis, with this USB 3.0 connector, you can have a front panel USB 3.0 solution.

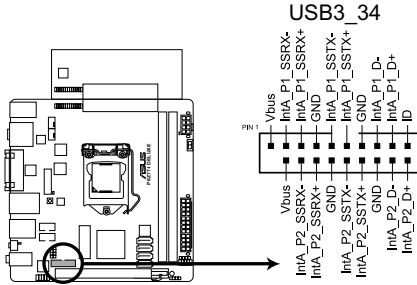

P8Z77-I DELUXE USB3.0 Front panel connector



Due to Intel® limitations, the USB3_34 only support Windows® 7 operating system.

4. USB 2.0 connectors (10-1 pin USB56~USB78)

These connectors are for USB 2.0 ports. Connect the USB module cable to any of these connectors, then install the module to a slot opening at the back of the system chassis. These USB connectors comply with USB 2.0 specification that supports up to 480Mbps connection speed.

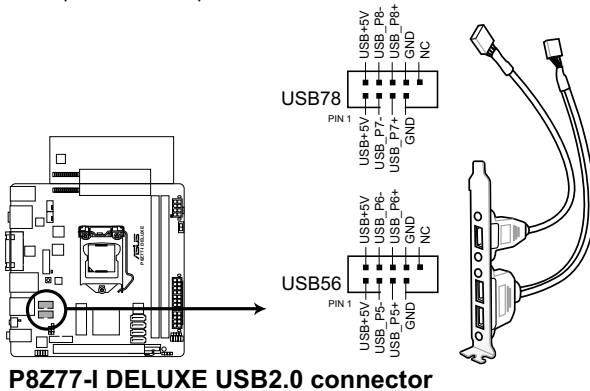

P8Z77-I DELUXE USB2.0 connector



Never connect a 1394 cable to the USB connectors. Doing so will damage the motherboard!



The USB 2.0 module is purchased separately.

5. Digital audio connector (4-1 pin SPDIF_OUT)

This connector is for an additional Sony/Philips Digital Interface (S/PDIF) port(s). Connect the S/PDIF Out module cable to this connector, then install the module to a slot opening at the back of the system chassis.

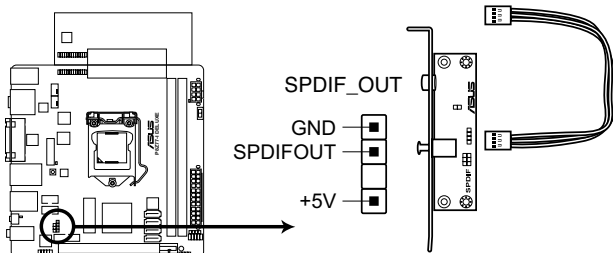

P8Z77-I DELUXE Digital audio connector



The S/PDIF module is purchased separately.

6. Chassis intrusion connector (4-1 pin CHASSIS)

This connector is for a chassis-mounted intrusion detection sensor or switch. Connect one end of the chassis intrusion sensor or switch cable to this connector. The chassis intrusion sensor or switch sends a high-level signal to this connector when a chassis component is removed or replaced. The signal is then generated as a chassis intrusion event.

By default, the pin labeled "Chassis Signal" and "Ground" are shorted with a jumper cap. Remove the jumper caps only when you intend to use the chassis intrusion detection feature.

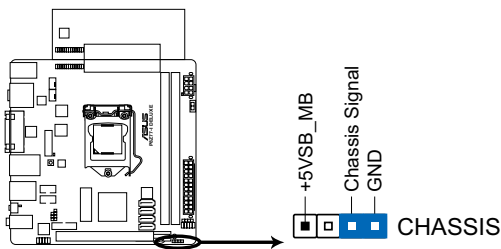

P8Z77-I DELUXE Chassis intrusion connector

7. CPU and chassis fan connectors (4-pin CPU_FAN; 4-pin CHA_FAN)

Connect the fan cables to the fan connectors on the motherboard, ensuring that the black wire of each cable matches the ground pin of the connector.

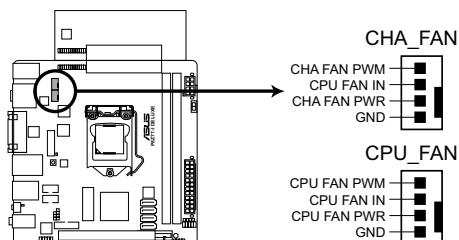

P877-I DELUXE fan connectors



Do not forget to connect the fan cables to the fan connectors. Insufficient air flow inside the system may damage the motherboard components. These are not jumpers! Do not place jumper caps on the fan connectors!



- The CPU_FAN connector supports the CPU fan of maximum 1A (12 W) fan power.
- The CPU_FAN, CHA_FAN connectors support the ASUS FAN Xpert feature.

8. Front panel audio connector (10-1 pin AAFP)

This connector is for a chassis-mounted front panel audio I/O module that supports either HD Audio or legacy AC'97 audio standard. Connect one end of the front panel audio I/O module cable to this connector.

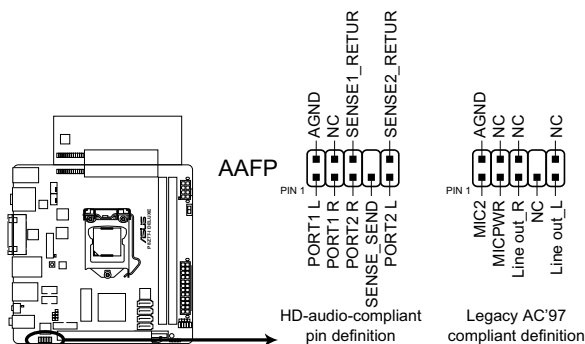

P877-I DELUXE Front panel audio connector



- We recommend that you connect a high-definition front panel audio module to this connector to avail of the motherboard's high-definition audio capability.
- If you want to connect a high-definition front panel audio module to this connector, set the **Front Panel Type** item in the BIOS setup to **[HD]**; if you want to connect an AC'97 front panel audio module to this connector, set the item to **[AC97]**. By default, this connector is set to **[HD]**.

9. ATX power connectors (24-pin EATXPWR; 8-pin EATX12V)

These connectors are for ATX power supply plugs. The power supply plugs are designed to fit these connectors in only one orientation. Find the proper orientation and push down firmly until the connectors completely fit.

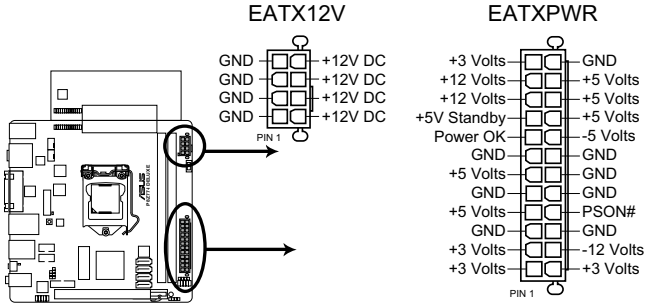

P8Z77-I DELUXE ATX power connectors



- For a fully configured system, we recommend that you use a power supply unit (PSU) that complies with ATX 12 V Specification 2.3 and provides a minimum power of 350W.
- Do not forget to connect the 4-pin/8-pin EATX12 V power plug; otherwise, the system will not boot.
- Use of a PSU with a higher power output is recommended when configuring a system with more power-consuming devices. The system may become unstable or may not boot up if the power is inadequate.
- If you are uncertain about the minimum power supply requirement for your system, refer to the Recommended Power Supply Wattage Calculator at <http://support.asus.com/PowerSupplyCalculator/PSCalculator.aspx?SLanguage=en-us> for details.

10. Speaker connector (4-pin SPEAKER)

This 4-pin connector is for the chassis-mounted system warning speaker. The speaker allows you to hear system beeps and warnings.

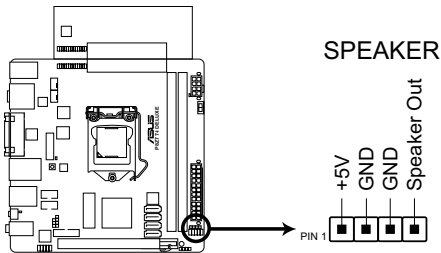

P8Z77-I DELUXE Speaker Out Connector

11. System panel connector (10-1 pin PANEL)

This connector supports several chassis-mounted functions.

The ASUS Q-Cable allows you to easily connect or disconnect the chassis front panel cables even when you have already installed the components and installed the motherboard to the chassis.

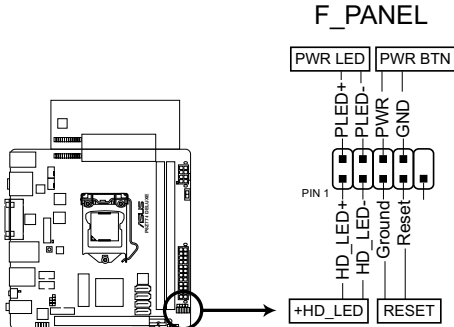

P8Z77-I DELUXE System panel connector

Q-Cable

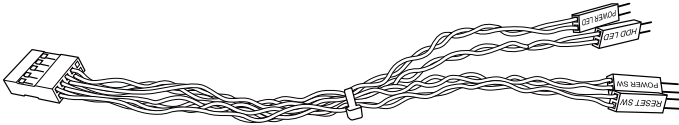

- **System power LED (2-pin PLED)**

This 2-pin connector is for the system power LED. Connect the chassis power LED cable to this connector. The system power LED lights up when you turn on the system power, and blinks when the system is in sleep mode.

- **Hard disk drive activity LED (2-pin +HDLED)**

This 2-pin connector is for the HDD Activity LED. Connect the HDD Activity LED cable to this connector. The IDE LED lights up or flashes when data is read from or written to the HDD.

- **Power/Soft-off button (2-pin PWRBTN)**

This 2-pin connector is for the system power button.

- **Reset button (2-pin RESET)**

This 2-pin connector is for the chassis-mounted reset button for system reboot without turning off the system power.

2.2.8 Jumper

Clear RTC RAM (3-pin CLRRTC)

This jumper allows you to clear the Real Time Clock (RTC) RAM in CMOS. You can clear the CMOS memory of date, time, and system setup parameters by erasing the CMOS RTC RAM data. The onboard button cell battery powers the RAM data in CMOS, which include system setup information such as system passwords.

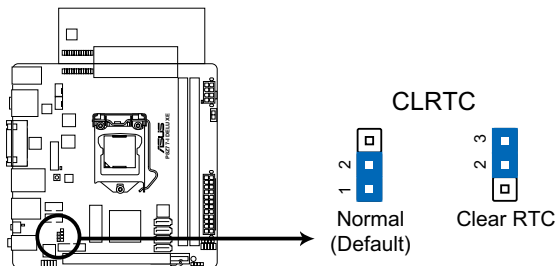

P8Z77-I DELUXE Clear RTC RAM

To erase the RTC RAM

1. Turn OFF the computer and unplug the power cord.
2. Move the jumper cap from pins 1-2 (default) to pins 2-3. Keep the cap on pins 2-3 for about 5–10 seconds, then move the cap back to pins 1-2.
3. Plug the power cord and turn ON the computer.
4. Hold down the key during the boot process and enter BIOS setup to re-enter data.





Except when clearing the RTC RAM, never remove the cap on CLRRTC jumper default position. Removing the cap will cause system boot failure!



- If the steps above do not help, remove the onboard battery and move the jumper again to clear the CMOS RTC RAM data. After clearing the CMOS, reinstall the battery.
- You do not need to clear the RTC when the system hangs due to overclocking. For system failure due to overclocking, use the C.P.R. (CPU Parameter Recall) feature. Shut down and reboot the system so the BIOS can automatically reset parameter settings to default values.

2.3 Building your computer system

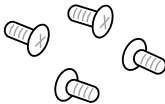
2.3.1 Additional tools and components to build a PC system

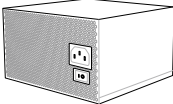
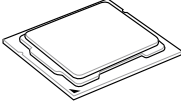
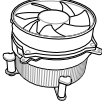
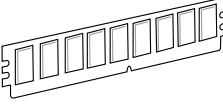
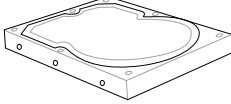
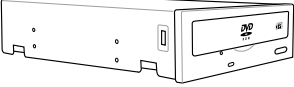
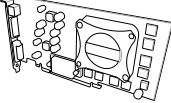
	
1 bag of screws	Philips (cross) screwdriver
	
PC chassis	Power supply unit
	
Intel LGA 1155 CPU	Intel LGA 1155 compatible CPU Fan
	
DIMM	SATA hard disk drive
	
SATA optical disc drive (optional)	Graphics card (optional)



The tools and components in the table above are not included in the motherboard package.

2.3.2 CPU installation



The LGA1156 CPU is incompatible with the LGA1155 socket. DO NOT install a LGA1156 CPU on the LGA1155 socket.

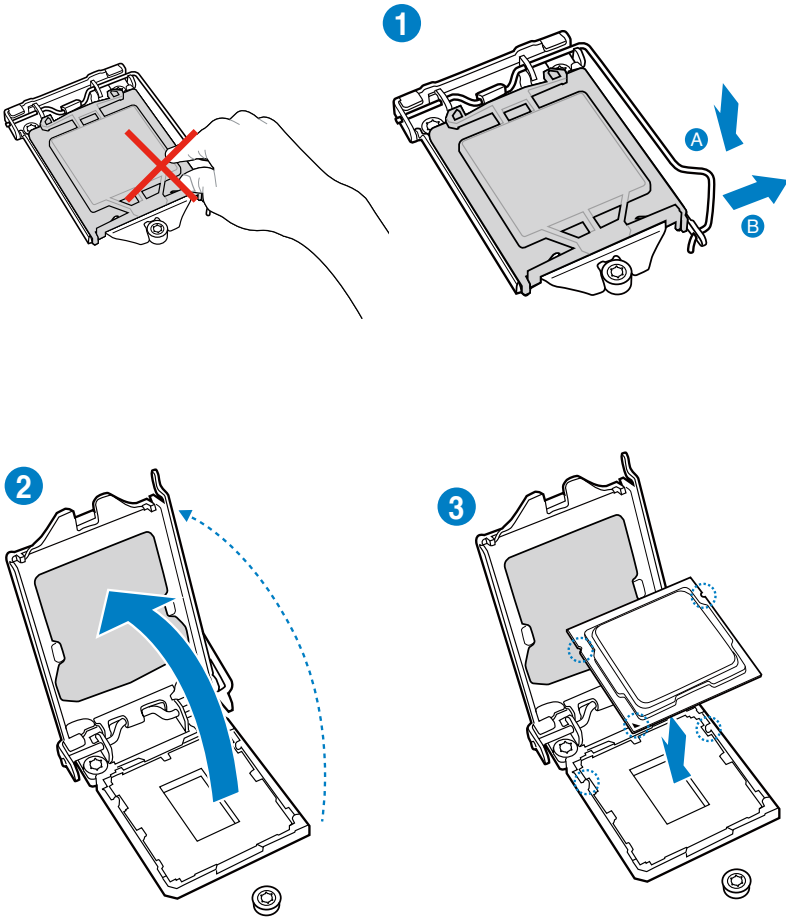

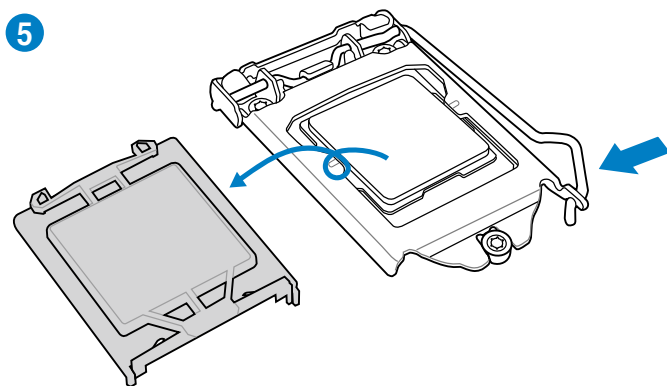
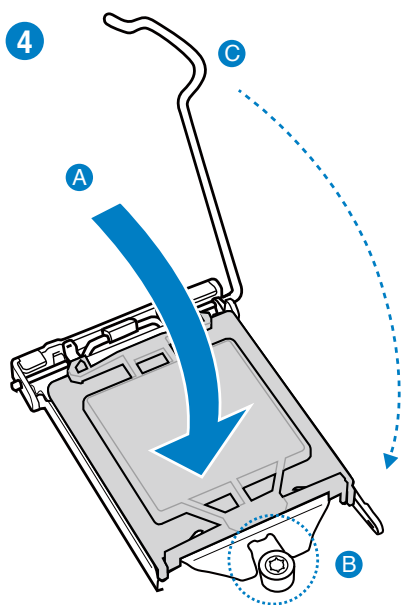

2.3.3 CPU heatsink and fan assembly installation

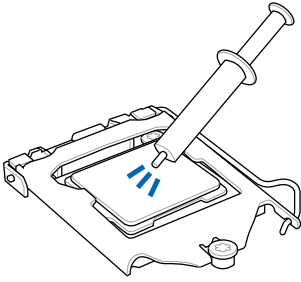

Apply the Thermal Interface Material to the CPU heatsink and CPU before you install the heatsink and fan if necessary.

To install the CPU heatsink and fan assembly

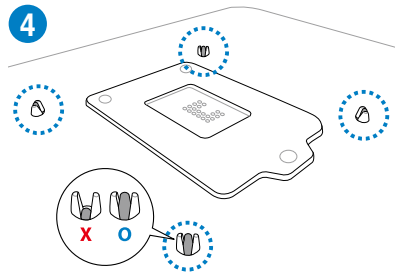
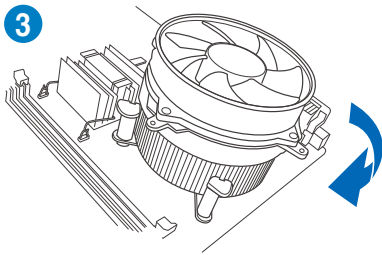
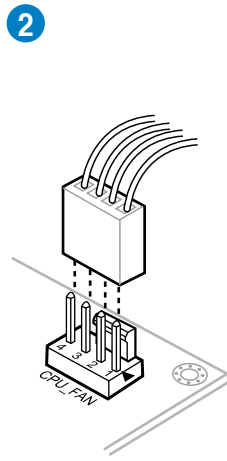
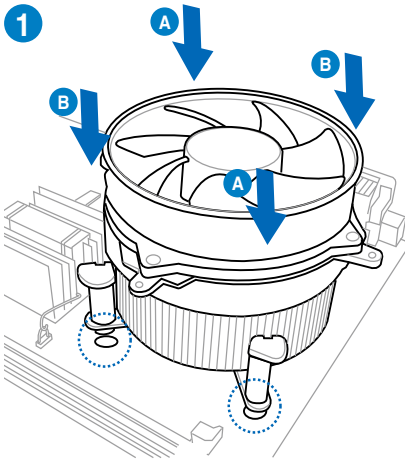

To uninstall the CPU heatsink and fan assembly

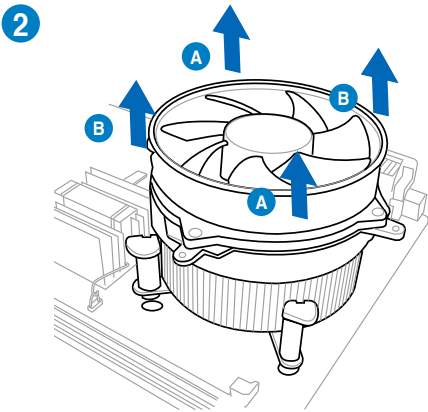
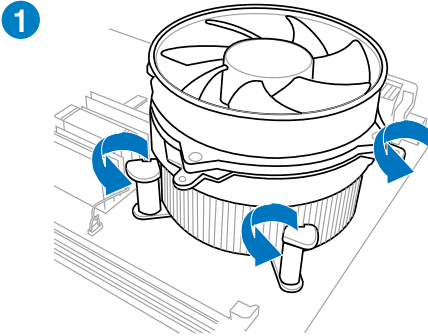

2.3.4 DIMM installation

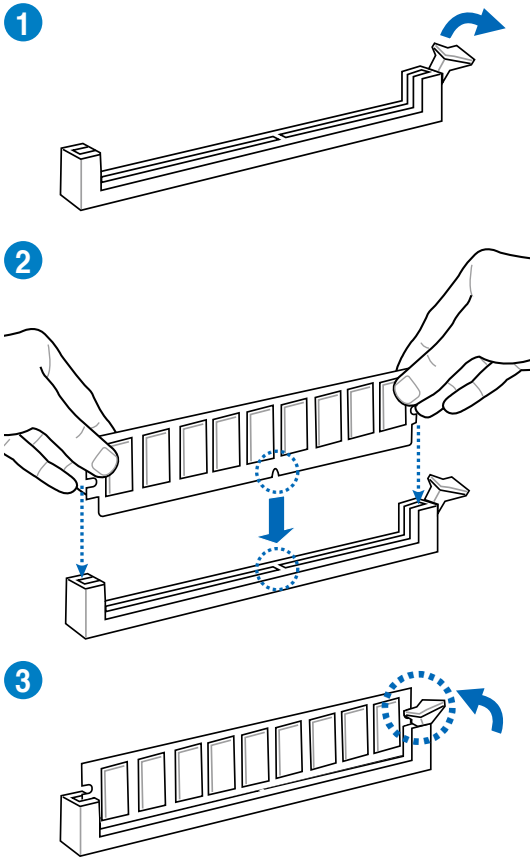

To remove a DIMM

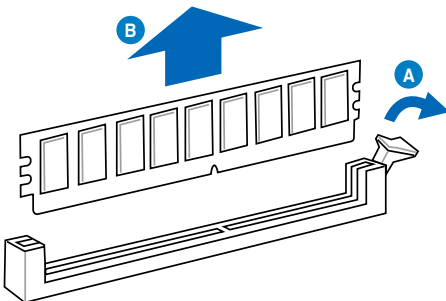

2.3.5 Motherboard installation

To install the P8Z77-I DELUXE into a chassis:

1. Locate and remove the two screws near the Vcore card on the motherboard using a screw driver..



The screws secure the heatsink to the Vcore card.

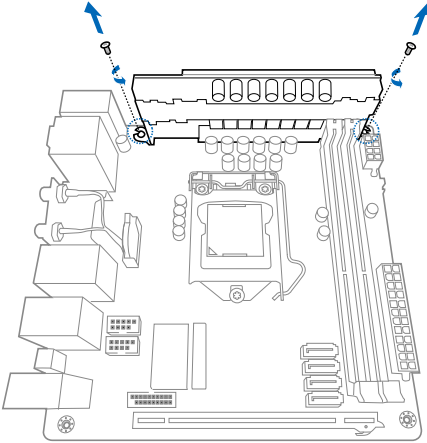

2. Place the motherboard into the chassis, ensuring that its rear I/O ports are aligned to the chassis's rear I/O panel.
3. Place four screws into the holes indicated by circles to secure the motherboard to the chassis. Use the screws you removed earlier for holes indicated with A, and two screws bundled with the chassis for holes indicated with B.

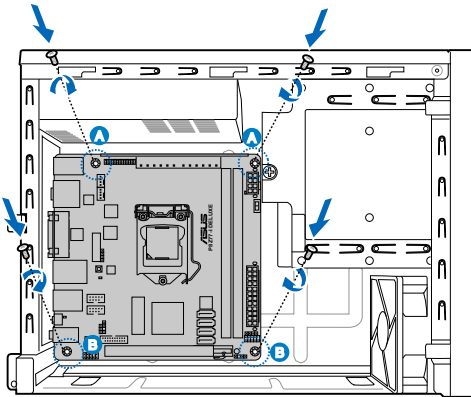

If the screw thread of the screws holes in the chassis is thin, then use the slim screws that bundled with the motherboard.

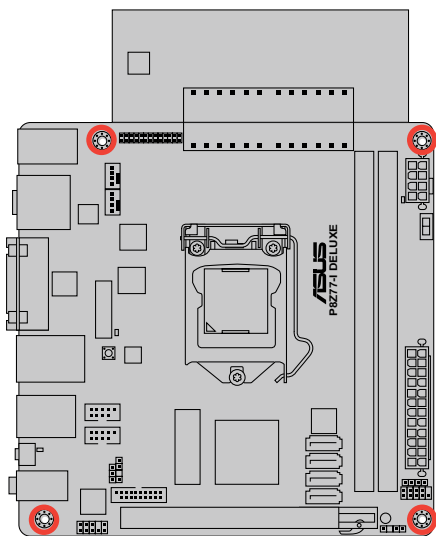

DO NOT overtighten the screws! Doing so can damage the motherboard.

2.3.6 ATX Power connection

1

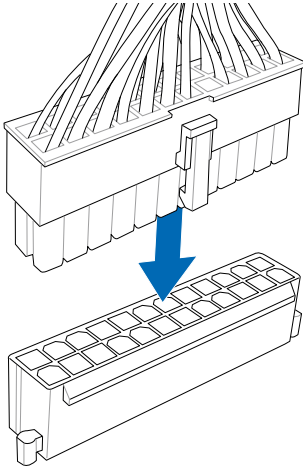

2

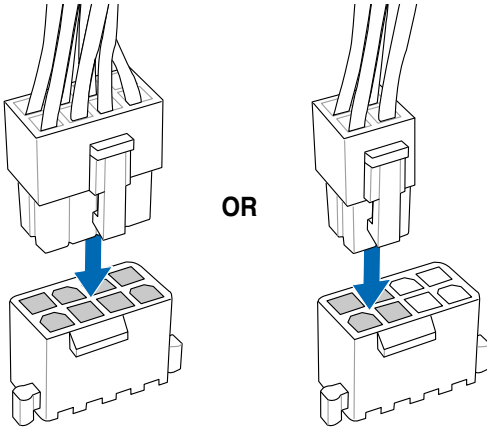

2.3.7 SATA device connection

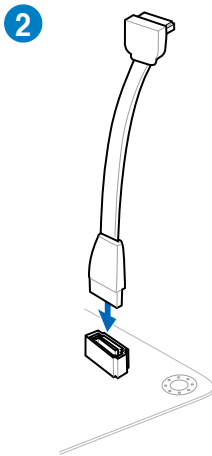
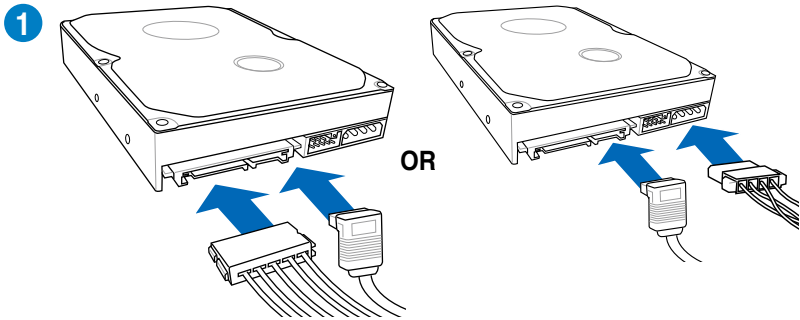

2.3.8 Front I/O Connector

To install front panel Connector (or Q-Cable)

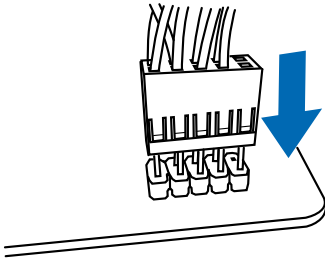

To install USB 2.0 Connector

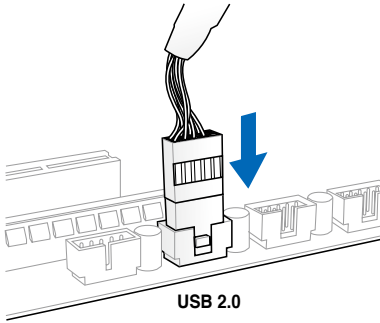

To install front panel audio connector

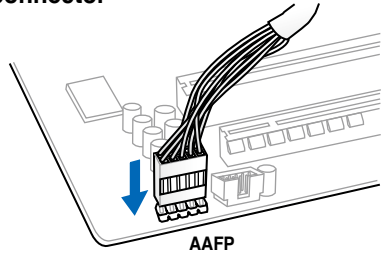

To install USB 3.0 Connector

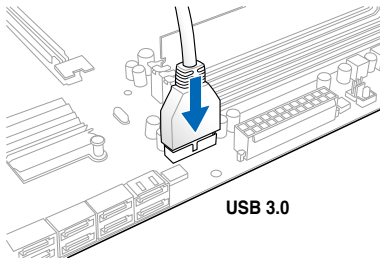

2.3.9 Expansion Card installation

To install PCIe x16 cards

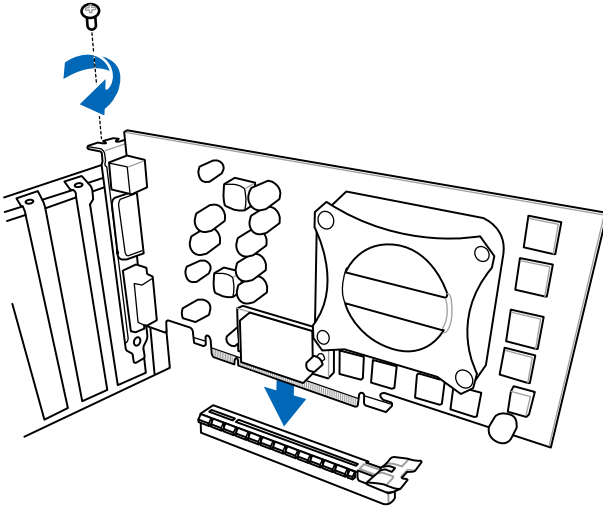

2.3.10 USB BIOS Flashback

USB BIOS Flashback offers the most convenient way to flash the BIOS. It allows overclockers to try new BIOS versions easily without having to enter their existing BIOS or operating system. Just plug in USB storage and push the dedicated button for 3 seconds, and the BIOS is automatically flashed using standby power. Worry-free overclocking for the ultimate convenience!

- 1 Download the BIOS Flashback program from the ASUS service website (www.asus.com). Save it to a USB portable disk, and place it in the root directory.
- 2 Plug the USB flash drive to the USB3.0 port (marked in red) on the rear I/O panel.
- 3 Press the BIOS Flashback button for 3 seconds, and the light will begin to flash (on the third second).
- 4 The Flashback function is enabled once the light starts to flash.
- 5 The flashing rate of the light signal accelerates along with the updating speed.
- 6 BIOS update is complete once the light signal goes out.

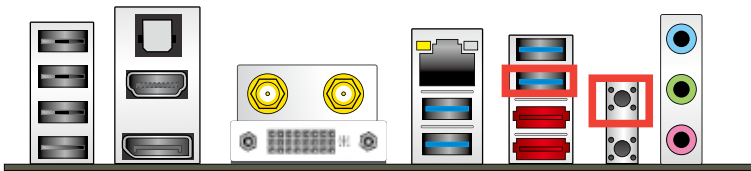

1. Do not unplug portable disk, power system, or press the CLR_CMOS button while BIOS update is ongoing, otherwise update will be interrupted. In case of interruption, please follow the recommended procedures again to complete BIOS update.
2. If the light flashes for five seconds and turns into a stable lighting, this means that the BIOS Flashback is not operating properly. This may be caused by: 1. Improper installation of the portable disk. 2. Error in file name or incompatibility in file format. If this is the case, please restart the system to turn off the light.
3. Updating BIOS may have risks. If the BIOS program is damaged during the process causing the system unable to reboot, please contact the local service station for help.

2.3.11 Rear panel connection

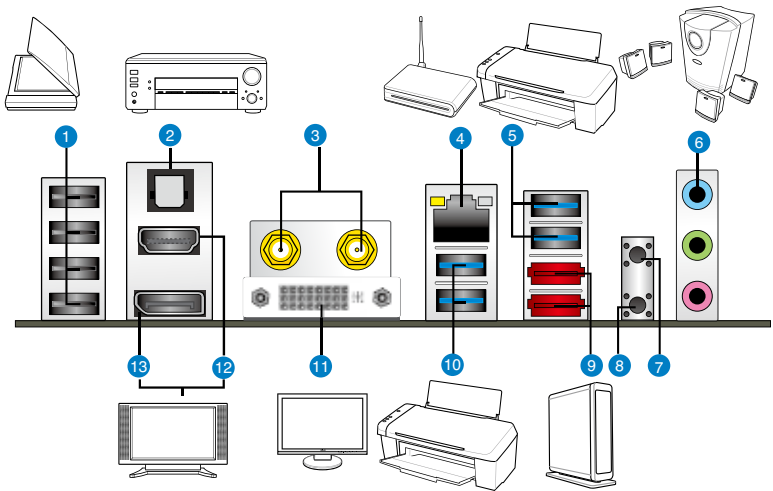

Rear panel connectors	
1. USB 2.0 ports 1-4	8. Clear CMOS button
2. Optical S/PDIF Out port	9. External SATA ports 1 and 2
3. ASUS Wi-Fi GO! card (Wi-Fi 802.11 and Bluetooth v4.0/30.+HS)*	10. Asmedia USB 3.0 ports 1 and 2, support ASUS USB 3.0 UASP Mode
4. Intel® LAN (RJ-45) port**	11. DVI-I port
5. Intel® USB 3.0 ports 1 and 2, support ASUS USB 3.0 UASP, bottom port supports USB BIOS Flashback and USB Charger+	12. HDMI port
6. Audio I/O ports***	13. DisplayPort
7. USB BIOS Flashback button	

*, ** and ***: Refer to the tables on the next page for LAN port LED and audio port definitions.



Due to Intel® limitations, the USB3_12 only support Windows® 7 operating system.



- Press the Clear CMOS switch to clear BIOS setup information only when the system hangs due to overclocking.
- DO NOT insert a different connector to the external SATA port.
- Due to USB 3.0 controller limitation, USB 3.0 devices can only be used under Windows® OS environment and after the USB 3.0 driver installation.
- USB 3.0 devices can only be used as data storage only.
- We strongly recommend that you connect USB 3.0 devices to USB 3.0 ports for faster and better performance for your USB 3.0 devices.



ASUS Wi-Fi GO! card automatically sets itself to the country's available Wi-Fi channels.

** LAN ports LED indications

Activity Link LED		Speed LED	
Status	Description	Status	Description
OFF	No link	OFF	10 Mbps connection
ORANGE	Linked	ORANGE	100 Mbps connection
BLINKING	Data activity	GREEN	1 Gbps connection

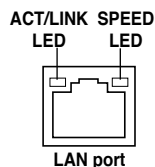

*** Audio 2, 4, 6, or 8-channel configuration

Ports	Headset 2-channel	4-channel	6-channel	8-channel
Light Blue (Rear panel)	Line In	Rear Speaker Out	Rear Speaker Out	Rear Speaker Out
Lime (Rear panel)	Line Out	Front Speaker Out	Front Speaker Out	Front Speaker Out
Pink (Rear panel)	Mic In	Mic In	Bass/Center	Bass/Center
Lime (Front panel)	-	-	-	Side Speaker Out

2.3.12 Audio I/O connections

Audio I/O ports

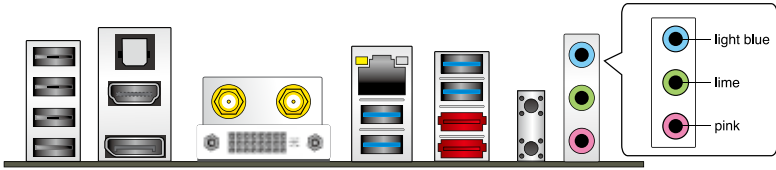

Connect to Headphone and Mic

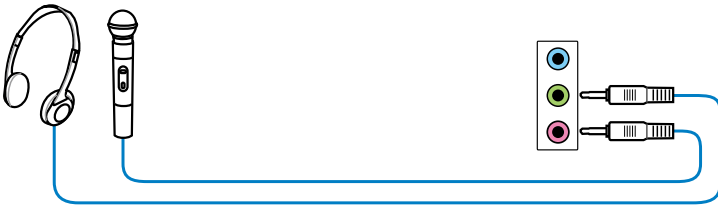

Connect to Stereo Speakers

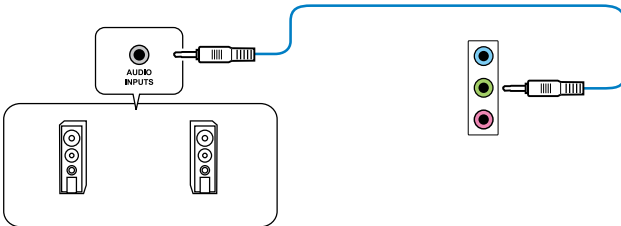

Connect to 2.1 channel Speakers

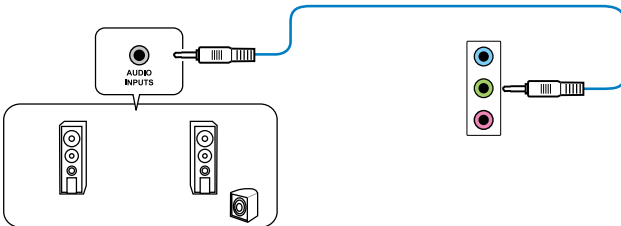

Connect to 4.1 channel Speakers

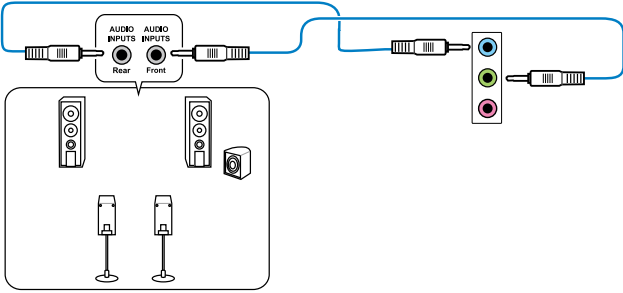

Connect to 5.1 channel Speakers

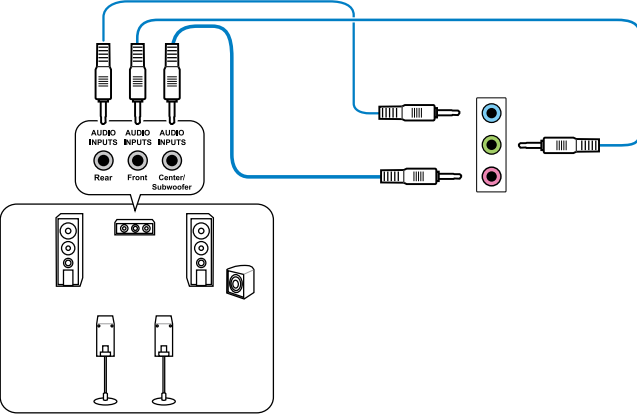

Connect to 7.1 channel Speakers

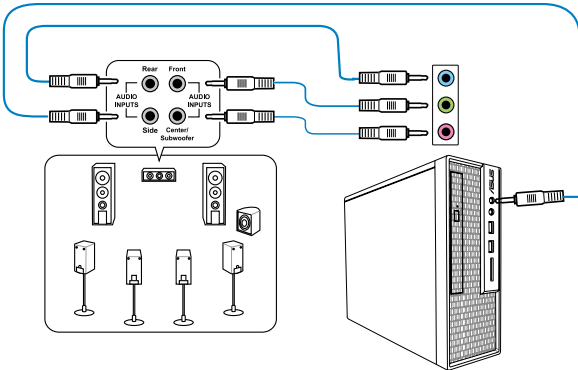

2.4 Starting up for the first time

1. After making all the connections, replace the system case cover.
2. Be sure that all switches are off.
3. Connect the power cord to the power connector at the back of the system chassis.
4. Connect the power cord to a power outlet that is equipped with a surge protector.
5. Turn on the devices in the following order:
 - a. Monitor
 - b. External SCSI devices (starting with the last device on the chain)
 - c. System power
6. After applying power, the system power LED on the system front panel case lights up. For systems with ATX power supplies, the system LED lights up when you press the ATX power button. If your monitor complies with the “green” standards or if it has a “power standby” feature, the monitor LED may light up or change from orange to green after the system LED turns on.

The system then runs the power-on self tests or POST. While the tests are running, the BIOS beeps* (refer to the BIOS beep codes table below) or additional messages appear on the screen. If you do not see anything within 30 seconds from the time you turned on the power, the system may have failed a power-on test. Check the jumper settings and connections or call your retailer for assistance.

* You can hear the BIOS beep only when you have connected a buzzer to the speaker header.

BIOS Beep	Description
One short beep	VGA detected Quick boot set to disabled No keyboard detected
One continuous beep followed by two short beeps then a pause (repeated)	No memory detected
One continuous beep followed by three short beeps	No VGA detected
One continuous beep followed by four short beeps	Hardware component failure

7. At power on, hold down the <Delete> key to enter the BIOS Setup. Follow the instructions in Chapter 3.

2.5 Turning off the computer

While the system is ON, pressing the power switch for less than four seconds puts the system on sleep mode or soft-off mode, depending on the BIOS setting. Pressing the power switch for more than four seconds lets the system enter the soft-off mode regardless of the BIOS setting.

Chapter 3

3.1 Knowing BIOS



The new ASUS UEFI BIOS is a Unified Extensible Interface that complies with UEFI architecture, offering a user-friendly interface that goes beyond the traditional keyboard-only BIOS controls to enable a more flexible and convenient mouse input. Users can easily navigate the new UEFI BIOS with the same smoothness as their operating system. The term "BIOS" in this user manual refers to "UEFI BIOS" unless otherwise specified.

BIOS (Basic Input and Output System) stores system hardware settings such as storage device configuration, overclocking settings, advanced power management, and boot device configuration that are needed for system startup in the motherboard CMOS. In normal circumstances, the default BIOS settings apply to most conditions to ensure optimum performance. **We recommend that you not change the default BIOS settings** except in the following circumstances:

- An error message appears on the screen during the system bootup and requests you to run the BIOS Setup.
- You have installed a new system component that requires further BIOS settings or update.



Inappropriate settings of the BIOS may result to instability or failure to boot. **We strongly recommend that you change the BIOS settings only with the help of a trained service personnel.**

3.2 BIOS setup program

A BIOS setup program is provided for BIOS item modification. When you start up the computer, the system provides you with the opportunity to run this program. Press during the Power-On Self-Test (POST) to enter the Setup utility. Otherwise, POST continues with its test routines.

If you wish to enter Setup after POST, press <Ctrl> + <Alt> + <Delete>, or press the reset button on the system chassis to restart the system. You can also turn the system off and then turn it back on to restart the system. Do this last option only if the first two failed.



- The BIOS setup screens shown in this section are for reference purposes only, and may not exactly match what you see on your screen.
- Ensure that a USB mouse is connected to your motherboard if you want to use the mouse to control the BIOS setup program.
- If the system becomes unstable after changing any BIOS setting, load the default settings to ensure system compatibility and stability. Select the **Load Optimized Defaults** item under the **Exit** menu. See section **3.9 Exit Menu** for details.
- If the system fails to boot after changing any BIOS setting, try to clear the CMOS and reset the motherboard to the default value. See section **2.2.5 Onboard switches** for information on how to erase the RTC RAM.
- The BIOS setup program does not support the bluetooth devices.

The BIOS setup program is designed to make it as easy to use as possible. Being a menu-driven program, it lets you scroll through the various submenus and select from the available options using a keyboard or a USB mouse.

The BIOS setup program can be used under two modes: **EZ Mode** and **Advanced Mode**. You can change modes from the **Exit** menu or from the **Exit/Advanced Mode** button in the **EZ Mode/Advanced Mode** screen.

3.2.1 EZ Mode

By default, the EZ Mode screen appears when you enter the BIOS setup program. The EZ Mode provides you an overview of the basic system information, and allows you to select the display language, system performance mode and boot device priority. To access the Advanced Mode, click **Exit/Advanced Mode**, then select **Advanced Mode** or press F7 hot key for the advanced BIOS settings.



The default screen for entering the BIOS setup program can be changed. Refer to the **Setup Mode** item in section 3.7 **Boot menu** for details.

Clicks to display all fan speeds if available

Selects the display language of the BIOS setup program

Exits the BIOS setup program without saving the changes, saves the changes and resets the system, or enters the Advanced Mode

Displays the CPU/motherboard temperature, CPU/5V/3.3V/12V voltage output, CPU/chassis/power fan speed

Quiet
Performance
Energy Saving

Normal

Power Saving mode

Normal mode

ASUS Optimal mode

Boot Priority

Selects the boot device priority

Displays the Advanced mode menus

Displays the system properties of the selected mode on the right hand side

Selects the Advanced mode functions

Loads optimized default

Selects the boot device priority

Shortcut (F3) Advanced Mode (F7) Boot Menu(F8) Default(F5)



- The boot device options vary depending on the devices you installed to the system.
- The **Boot Menu(F8)** button is available only when the boot device is installed to the system.

3.2.2 Advanced Mode

The Advanced Mode provides advanced options for experienced end-users to configure the BIOS settings. The figure below shows an example of the Advanced Mode. Refer to the following sections for the detailed configurations.



To access the Advanced Mode, click **Exit**, then select **Advanced Mode** or press **F7** hotkey.



Menu bar

The menu bar on top of the screen has the following main items:

Main	For changing the basic system configuration
Ai Tweaker	For changing the overclocking settings
Advanced	For changing the advanced system settings
Monitor	For displaying the system temperature, power status, and changing the fan settings.
Boot	For changing the system boot configuration
Tool	For configuring options for special functions
Exit	For selecting the exit options and loading default settings

Menu items

The highlighted item on the menu bar displays the specific items for that menu. For example, selecting **Main** shows the Main menu items.

The other items (Ai Tweaker, Advanced, Monitor, Boot, Tool, and Exit) on the menu bar have their respective menu items.

Back button

This button appears when entering a submenu. Press <Esc> or use the USB mouse to click this button to return to the previous menu screen.

Submenu items

A greater than sign (>) before each item on any menu screen means that the item has a submenu. To display the submenu, select the item and press <Enter>.

Pop-up window

Select a menu item and press <Enter> to display a pop-up window with the configuration options for that item.

Scroll bar

A scroll bar appears on the right side of a menu screen when there are items that do not fit on the screen. Press the Up/Down arrow keys or <Page Up> / <Page Down> keys to display the other items on the screen.

Navigation keys

At the bottom right corner of the menu screen are the navigation keys for the BIOS setup program. Use the navigation keys to select items in the menu and change the settings.

General help

At the top right corner of the menu screen is a brief description of the selected item. Use <F12> key to capture the BIOS screen and save it to the removable storage device.

Configuration fields

These fields show the values for the menu items. If an item is user-configurable, you can change the value of the field opposite the item. You cannot select an item that is not user-configurable.

A configurable field is highlighted when selected. To change the value of a field, select it and press <Enter> to display a list of options.

3.3 Main menu

The Main menu screen appears when you enter the Advanced Mode of the BIOS Setup program. The Main menu provides you an overview of the basic system information, and allows you to set the system date, time, language, and security settings.



Security

The Security menu items allow you to change the system security settings.

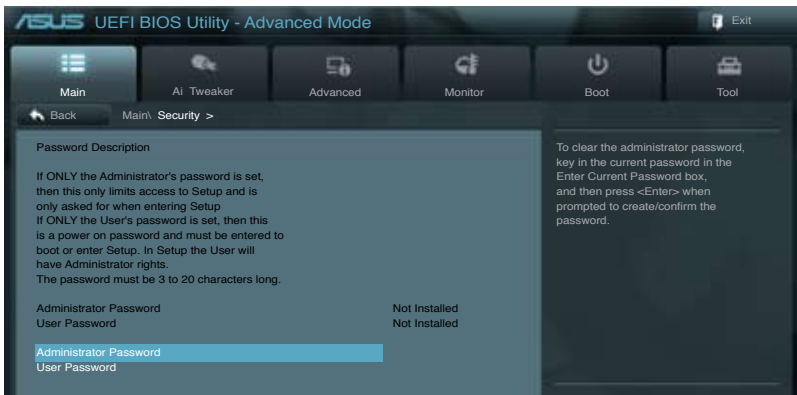

- If you have forgotten your BIOS password, erase the CMOS Real Time Clock (RTC) RAM to clear the BIOS password. See section 2.3.5 **Onboard switches** for information on how to erase the RTC RAM.
- The **Administrator** or **User Password** items on top of the screen show the default **Not Installed**. After you set a password, these items show **Installed**.

Administrator Password

If you have set an administrator password, we recommend that you enter the administrator password for accessing the system. Otherwise, you might be able to see or change only selected fields in the BIOS setup program.

To set an administrator password:

1. Select the **Administrator Password** item and press <Enter>.
2. From the **Create New Password** box, key in a password, then press <Enter>.
3. Confirm the password when prompted.

To change an administrator password:

1. Select the **Administrator Password** item and press <Enter>.
2. From the **Enter Current Password** box, key in the current password, then press <Enter>.
3. From the **Create New Password** box, key in a new password, then press <Enter>.
4. Confirm the password when prompted.

To clear the administrator password, follow the same steps as in changing an administrator password, but press <Enter> when prompted to create/confirm the password. After you clear the password, the **Administrator Password** item on top of the screen shows **Not Installed**.

User Password

If you have set a user password, you must enter the user password for accessing the system. The **User Password** item on top of the screen shows the default **Not Installed**. After you set a password, this item shows **Installed**.

To set a user password:

1. Select the **User Password** item and press <Enter>.
2. From the **Create New Password** box, key in a password, then press <Enter>.
3. Confirm the password when prompted.

To change a user password:

1. Select the **User Password** item and press <Enter>.
2. From the **Enter Current Password** box, key in the current password, then press <Enter>.
3. From the **Create New Password** box, key in a new password, then press <Enter>.
4. Confirm the password when prompted.

To clear the user password, follow the same steps as in changing a user password, but press <Enter> when prompted to create/confirm the password. After you clear the password, the **User Password** item on top of the screen shows **Not Installed**.

3.4 Ai Tweaker menu

The Ai Tweaker menu items allow you to configure overclocking-related items.



Be cautious when changing the settings of the Ai Tweaker menu items. Incorrect field values can cause the system to malfunction.



The configuration options for this section vary depending on the CPU and DIMM model you installed on the motherboard.



Scroll down to display the following items:



Ai Overclock Tuner [Auto]

Allows you to select the CPU overclocking options to achieve the desired CPU internal frequency. Select any of these preset overclocking configuration options:

- [Auto] Loads the optimal settings for the system.
- [Manual] Allows you to individually set overclocking parameters.
- [X.M.P.] If you install memory modules supporting the eXtreme Memory Profile (X.M.P.) Technology, choose this item to set the profiles supported by your memory modules for optimizing the system performance.



The item BCLK/PEG Frequency appears only when you set the Ai Overclock Tuner to [Manual].

BCLK/PEG Frequency [XXX]

Allows you to adjust the CPU and VGA frequency to enhance the system performance. Use the <+> and <-> keys to adjust the value. You can also key in the desired value using the numeric keypad. The values range from 80.0MHz to 300.0MHz.

eXtreme Memory Profile

This item appears only when you set the Ai Overclock Tuner item to [X.M.P.] and allows you to select the X.M.P. mode supported by your memory module. Configuration options: [Profile #1] [Profile #2]

ASUS MultiCore Enhancement [Enabled]

- [Enabled] Sets to [Enabled] for maximum performance under XMP/Manual/User-defined memory frequency mode.
- [Disabled] Set to [Disabled] for default core ratio settings.

Turbo Ratio [Auto]

Allows you to set the CPU ratio automatically or manually.

- [Auto] Sets all Turbo Ratio to Intel® CPU default settings automatically.
- [Manual] Sets the Turbo Ratio for every core-activation condition of a full unlocked CPU manually.



When the Turbo Ratio is set to [Manual], the following items appear:

Ratio Synchronizing Control [Enabled]

- [Enabled] Allows you to set an individual Turbo Ratio for every core-activation condition
- [Disabled] Allows you to set one single Turbo Ratio for all core-activation conditions.

1-Core Ratio Limit [Auto]

Use the <+> and <-> keys to adjust the value.

2-/3-/4-Core Ratio Limit [Auto]

These items become configurable only when you set the **Turbo Ratio** to [Manual] and the **Ratio Synchronizing Control** item to [Disabled]. Use the <+> and <-> keys to adjust the value.

Internal PLL Overvoltage [Auto]

Allows you to enable Internal PLL Over-voltage for K-SKU CPUs to get extreme overclocking capability. Configuration options: [Auto] [Enabled] [Disabled]

CPU bus speed : DRAM speed ratio mode [Auto]

Allows you to set the CPU bus speed to DRAM speed ratio mode.

- [Auto] DRAM speed is set to the optimized settings.
 [100:133] The CPU bus speed to DRAM speed ratio is set to 100:133.
 [100:100] The CPU bus speed to DRAM speed ratio is set to 100:100.

Memory Frequency [Auto]

Allows you to set the memory operating frequency. The configuration options vary with the **BCLK/PEG Frequency** item settings.



Selecting a very high memory frequency may cause the system to become unstable! If this happens, revert to the default setting.

iGPU Max. Frequency [Auto]

Allows you to set the iGPU maximum frequency. The values range from xxxxMHz (by CPU) to 3000MHz with a 50MHz interval. Use <+>/<-> to adjust the value.

EPU Power Saving Mode [Disabled]

Allows you to enable or disable the EPU power saving function. Configuration options: [Disabled] [Enabled]

EPU Setting [Auto]

This item appears only when you set the **EPU Power Saving Mode** item to [Enabled.] and allows you to select the EPU power saving mode. Configuration options: [Auto] [Light Power Saving Mode] [Medium Power Saving Mode] [Max Power Saving Mode]

OC Tuner

OC Tuner automatically overclocks the frequency and voltage of CPU and DRAM for enhancing the system performance. Configuration options: [OK] [Cancel]

DRAM Timing Control

The sub-items in this menu allow you to set the DRAM timing control features. Use the <+> and <-> keys to adjust the value. To restore the default setting, type [auto] using the keyboard and press the <Enter> key.



Changing the values in this menu may cause the system to become unstable! If this happens, revert to the default settings.

Primary Timings

DRAM CAS# Latency [Auto]

Configuration options: [Auto] [1 DRAM Clock] – [15 DRAM Clock]

DRAM RAS# to CAS# Delay [Auto]

Configuration options: [Auto] [1 DRAM Clock] – [15 DRAM Clock]

DRAM RAS# PRE Time [Auto]

Configuration options: [Auto] [1 DRAM Clock] – [15 DRAM Clock]

DRAM RAS# ACT Time [Auto]

Configuration options: [Auto] [1 DRAM Clock] – [255 DRAM Clock]

DRAM COMMAND Mode [Auto]

Configuration options: [Auto] [1 DRAM Clock] [2 DRAM Clock] [3 DRAM Clock]

Secondary Timings

DRAM RAS# to RAS# Delay [Auto]

Configuration options: [Auto] [1 DRAM Clock] – [15 DRAM Clock]

DRAM REF Cycle Time [Auto]

Configuration options: [Auto] [1 DRAM Clock] – [511 DRAM Clock]

DRAM Refresh Interval [Auto]

Configuration options: [Auto] [1 DRAM Clock] – [65535 DRAM Clock]

DRAM WRITE Recovery Time [Auto]

Configuration options: [Auto] [1 DRAM Clock] – [31 DRAM Clock]

DRAM READ to PRE Time [Auto]

Configuration options: [Auto] [1 DRAM Clock] – [15 DRAM Clock]

DRAM FOUR ACT WIN Time [Auto]

Configuration options: [Auto] [1 DRAM Clock] – [63 DRAM Clock]

DRAM WRITE to READ Delay [Auto]

Configuration options: [Auto] [1 DRAM Clock] – [15 DRAM Clock]

DRAM CKE Minimum pulse width [Auto]

Configuration options: [Auto] [1 DRAM Clock] – [15 DRAM Clock]

DRAM CAS# Write Latency [Auto]

Configuration options: [Auto] [1 DRAM Clock] – [15 DRAM Clock]

DRAM RTL (CHA) [Auto]

Configuration options: [Auto] [1 DRAM Clock] – [63 DRAM Clock]

DRAM RTL (CHB) [Auto]

Configuration options: [Auto] [1 DRAM Clock] – [63 DRAM Clock]

DRAM IO-L (CHA) [Auto]

Configuration options: [Auto] [Delay 1 Clock] – [Delay 15 Clock]

DRAM IO-L (CHB) [Auto]

Configuration options: [Auto] [Delay 1 Clock] – [Delay 15 Clock]

Third Timings

tWRDR (DD) [Auto]

Configuration options: [Auto] [1 DRAM Clock] – [8 DRAM Clock]

tRWDR (DD) [Auto]

Configuration options: [Auto] [1 DRAM Clock] – [8 DRAM Clock]

tRWSR [Auto]

Configuration options: [Auto] [1 DRAM Clock] – [8 DRAM Clock]

tRR (DD) [Auto]

Configuration options: [Auto] [1 DRAM Clock] – [8 DRAM Clock]

tRR (DR) [Auto]

Configuration options: [Auto] [1 DRAM Clock] – [8 DRAM Clock]

tRRSR [Auto]

Configuration options: [Auto] [4 DRAM Clock] – [7 DRAM Clock]

tWW (DD) [Auto]

Configuration options: [Auto] [1 DRAM Clock] – [8 DRAM Clock]

tWW (DR) [Auto]

Configuration options: [Auto] [1 DRAM Clock] – [8 DRAM Clock]

tWWSR [Auto]

Configuration options: [Auto] [4 DRAM Clock] – [7 DRAM Clock]

MISC

MRC Fst Boot [Enabled]

Configuration options: [Enabled] [Disabled]

DRAM CLK Period [Auto]

Configuration options: [Auto] [1 DRAM Clock] – [14 DRAM Clock]

Transmitter Slew (CHA) [Auto]

Configuration options: [Auto] [1 DRAM Clock] – [7 DRAM Clock]

Transmitter Slew (CHB) [Auto]

Configuration options: [Auto] [1 DRAM Clock] – [7 DRAM Clock]

Receiver Slew (CHA) [Auto]

Configuration options: [Auto] [1 DRAM Clock] – [7 DRAM Clock]

Receiver Slew (CHB) [Auto]

Configuration options: [Auto] [1 DRAM Clock] – [7 DRAM Clock]

MCH Duty Sense (CHA) [Auto]

Configuration options: [Auto] [1 DRAM Clock] – [31 DRAM Clock]

MCH Duty Sense (CHB) [Auto]

Configuration options: [Auto] [1 DRAM Clock] – [31 DRAM Clock]

Channel A DIMM Control [Enable Both DIMMS]

Configuration options: [Enable Both DIMMS] [Disable DIMM0] [Disable DIMM1] [Disable Both DIMMS]

Channel B DIMM Control [Enable Both DIMMS]

Configuration options: [Enable Both DIMMS] [Disable DIMM0] [Disable DIMM1] [Disable Both DIMMS]

DRAM Read Additional Swizzle [Auto]

Configuration options: [Auto] [Enabled] [Disabled]

DRAM Write Additional Swizzle [Auto]

Configuration options: [Auto] [Enabled] [Disabled]

CPU Power Management

The sub-items in this menu allow you to set the CPU ratio and features.

CPU Ratio [Auto]

Allows you to manually adjust the maximum non-turbo CPU ratio. Use <+> and <-> keys to adjust the value. The valid value ranges vary according to your CPU model.

Enhanced Intel SpeedStep Technology [Enabled]

Allows you to enable or disable the Enhanced Intel® SpeedStep Technology (EIST).

[Disabled] Disables this function.

[Enabled] The operating system dynamically adjusts the processor voltage and core frequency which may result in decreased average consumption and decreased average heat production.

Turbo Mode [Enabled]

Allows you to enable your core processor's speed to run faster than the marked frequency in a specific condition. Configuration options: [Disabled] [Enabled]



The first three items below appear only when you set the Turbo Mode to **[Enabled]**.

Long Duration Power Limit [Auto]

Allows you to limit the turbo ratio's long duration power. Use the <+> and <-> keys to adjust the value.

Long Duration Maintained [Auto]

Allows you to maintain the turbo ratio's long duration power. Use the <+> and <-> keys to adjust the value.

Short Duration Power Limit [Auto]

Allows you to limit the turbo ratio's long duration power. Use the <+> and <-> keys to adjust the value.

Primary Plane Current Limit [Auto]

Maximum instantaneous current allowed at any given time for CPU cores. Use <+> and <-> key to adjust the value at 0.125A increment. .

Secondary Plane Current Limit [Auto]

Maximum instantaneous current allowed at any given time for Internal Graphics cores. Use <+> and <-> key to adjust the value at 0.125A increment.

DIGI+ VRM

CPU Load-Line Calibration [Auto]

Load-line is defined by Intel VRM spec and affects CPU voltage. The CPU working voltage will decrease proportionally to CPU loading. Higher value gets a higher voltage and better overclocking performance, but increases the CPU and VRM thermal. This item allows you to adjust the voltage range from the following percentages to boost the system performance: 0% (Regular), 25% (Medium), 50% (High), 75% (Ultra High) and 100% (Extreme). Configuration options: [Auto] [Regular] [Medium] [High] [Ultra High] [Extreme]



The actual performance boost may vary depending on your CPU specification.

CPU Voltage Frequency [Auto]

Frequency switching affects the VRM transient response, and the thermal component. Higher frequency gets quicker transient response. Configuration options: [Auto] [Manual]



DO NOT remove the thermal module when switching to Manual Mode. The thermal conditions should be monitored.

CPU Fixed Frequency [300]

This item appears only when you set the **CPU Voltage Frequency** item to [Manual], and allows you to set a fixed CPU frequency. Use the <+> and <-> keys to adjust the value. The values range from 200k Hz to 400k Hz with a 10k Hz interval.

VRM Spread Spectrum [Disabled]

This item becomes configurable only when you set the **CPU Voltage Frequency** item to [Auto] and allows you to enable the spread spectrum to enhance system stability.

CPU Power Phase Control [Standard]

Allows you to control the power phase based on the CPU's demands.

Configuration options: [Standard] [Optimized] [Extreme] [Manual Adjustment]



DO NOT remove the thermal module when switching to Extreme and Manual Mode. The thermal conditions should be monitored.

CPU Power Duty Control [T.Probe]

DIGI + VRM Duty control adjusts the current and thermal conditions of every component's phase.

Configuration options: [T. Probe] - Select to maintain the VRM thermal balance.

[Extreme] - Select to maintain the VRM current balance.

CPU Current Capability [100%]

Allows you to configure the total power range, and extends the overclocking frequency range simultaneously. Configuration options: [100%] [110%] [120%] [130%] [140%]



Choose a higher value when overclocking, or under a high CPU loading for extra power support.

CPU Power Response Control [Auto]

The DIG+ VRM controller provides a faster, and precise power response rate for the CPU.

Apply a higher value for an extreme overclocking. Configuration options: [Auto] [Regular]

[Medium] [High] [Ultra High]



The actual performance boost may vary depending on your CPU configuration.

iGPU Load-line Calibration [Auto]

Allows you to set the iGPU Load-line Calibration. Configuration options: [Auto] [Regular]

[High] [Extreme]

iGPU Current Capability [100%]

Allows you to set the iGPU Current Capability. Configuration options: [100%] [110%] [120%] [130%]



DO NOT remove the thermal module while changing the DIGI+ VRM related parameters. The thermal conditions should be monitored.

CPU Voltage [Offset Mode]

[Manual Mode] Allows you to set a fixed CPU voltage.

[Offset Mode] Allows you to set the Offset voltage.

CPU Offset Mode Sign [+]

This item appears only when you set the **CPU Voltage** item to [Offset Mode].

[+] To offset the voltage by a positive value.

[-] To offset the voltage by a negative value.



Some of the following items are adjusted by typing the desired values using the numeric keypad and press the <Enter> key. You can also use the <+> and <-> keys to adjust the value. To restore the default setting, type [auto] using the keyboard and press the <Enter> key.

CPU Offset Voltage [Auto]

This item appears only when you set the **CPU Voltage** item to [Offset Mode] and allows you to set the Offset voltage. The values range from 0.005V to 0.635V with a 0.005V interval.

CPU Manual Voltage [Auto]

This item appears only when you set the **CPU Voltage** item to [Manual Mode] and allows you to set a fixed CPU voltage. The values range from 0.800V to 1.990V with a 0.005V interval.



Refer to the CPU documentation before setting the CPU voltage. Setting a high voltage may damage the CPU permanently, and setting a low voltage may make the system unstable.

iGPU Voltage [Offset Mode]

[Manual Mode] Allows you to set a fixed iGPU voltage.

[Offset Mode] Allows you to set the iGPU Offset voltage.

iGPU Offset Voltage [Auto]

This item appears only when you set the **iGPU Voltage** item to [Offset Mode] and allows you to set the Offset voltage. The values range from 0.005 to 0.635V with a 0.005V interval.

iGPU Manual Voltage [Auto]

This item appears only when you set the **iGPU Voltage** item to [Manual Mode] and allows you to set a fixed iGPU voltage. The values range from 0.800V to 1.990V with a 0.005V interval.

DRAM Voltage [Auto]

Allows you to set the DRAM voltage. The values range from 1.200V to 2.135V with a 0.005V interval.



According to Intel CPU specifications, DIMMs with voltage requirement over 1.65V may damage the CPU permanently. We recommend you install the DIMMs with the voltage requirement below 1.65V.

VCCSA Voltage [Auto]

Allows you to set the VCCSA voltage. The values range from 0.610V to 1.560V with a 0.005V interval.

PCH Voltage [Auto]

Allows you to set the Platform Controller Hub voltage. The values range from 1.05V to 1.40V with a 0.05V interval.



- The values of the CPU Manual Voltage, CPU Offset Voltage, DRAM Voltage, VCCSA Voltage, and PCH Voltage items are labeled in different color, indicating the risk levels of high voltage settings.
- The system may need better cooling system to work stably under high voltage settings.

	White	Yellow	Pink	Red
CPU Manual Voltage	0.8V–1.04V	1.045V–1.09V	1.095V–1.14V	1.145V–1.99V
CPU Offset Voltage	0.005V–0.05V	0.055V–0.1V	0.105V–0.15V	0.155V–0.635V
DRAM Voltage	1.2V–1.575V	1.58V–1.65V	1.655V–1.725V	1.73V–2.135V
VCCSA Voltage	0.61V–0.97V	0.975V–1.015V	1.02V–1.06V	1.065V–1.56V
PCH Voltage	1.05V–1.1V	1.15V	1.2V	1.25V–1.40V



The values of CPU Manual Voltage and CPU Offset Voltage vary with CPUs.

CPU PLL Voltage [Auto]

Allows you to set the CPU and PCH PLL voltage. Configuration options: [Auto] [+0.10V]

CPU Spread Spectrum [Auto]

- [Auto] Automatic configuration.
- [Disabled] Enhances the BCLK overclocking ability.
- [Enabled] Sets to [Enabled] for EMI control.

3.5 Advanced menu

The Advanced menu items allow you to change the settings for the CPU and other system devices.



Be cautious when changing the settings of the Advanced menu items. Incorrect field values can cause the system to malfunction.



3.5.1 CPU Configuration

The items in this menu show the CPU-related information that the BIOS automatically detects.



The items shown in this screen may be different due to the CPU you installed.



Scroll down to display the following items:



Intel Adaptive Thermal Monitor [Enabled]

[Enabled] Enables the overheated CPU to throttle its clock speed to cool down.

[Disabled] Disables the CPU thermal monitor function.

Active Processor Cores [All]

Allows you to choose the number of CPU cores to activate in each processor package. The configuration options vary with the CPU types.

Limit CPUID Maximum [Disabled]

[Enabled] Allows legacy operating systems to boot even without support for CPUs with extended CPUID functions.

[Disabled] Disables this function.

Execute Disable Bit [Enabled]

[Enabled] Enables the No-Execution Page Protection Technology.

[Disabled] Forces the XD feature flag to always return to zero (0).

Intel® Virtualization Technology [Disabled]

[Enabled] Allows a hardware platform to run multiple operating systems separately and simultaneously, enabling one system to virtually function as several systems.

[Disabled] Disables this function.

Hardware Prefetcher [Enabled]

[Enabled] Allows you to turn on/off the Mid Level Cache (L2) streamer prefetcher.

[Disabled] Disables this function.

Adjacent Cache Line Prefetch [Enabled]

[Enabled] Allows a hardware platform to perform adjacent cache line prefetching.

[Disabled] Disables this function.

CPU Power Management Configuration

This item allows you to manage and configure the CPU's power.

CPU Ratio [Auto]

Allows you to set the ratio between the CPU Core Clock and the BCLK Frequency. Use <+> and <-> keys to adjust the ratio. The valid value ranges vary according to your CPU model.

Enhanced Intel SpeedStep Technology [Enabled]

Allows you to enable or disable the Enhanced Intel® SpeedStep Technology (EIST).

[Disabled] The CPU runs at its default speed.

[Enabled] The operating system controls the CPU speed.

Turbo Mode [Enabled]

Allows you to set the processor cores to run faster than the marked frequency in a specific condition. Configuration options: [Enabled] [Disabled]

CPU C1E [Auto]

[Auto] Set this item automatically.

[Enabled] Enables the C1E support function. This function must be enabled to enable or disable the Intel® Turbo Mode Technology.

[Disabled] Disables the function.

CPU C3 Report [Auto]

Allows you to disable or enable the CPU C3 report to OS.

[Auto] Set this item automatically.

[Enabled] Enables the C3 Report support function.

[Disabled] Disables the function.

CPU C6 Report [Auto]

Allows you to disable or enable the CPU C6 report to OS.

[Auto] Set this item automatically.

[Enabled] Enables the C6 Report support function.

[Disabled] Disables the function.

3.5.2 PCH Configuration

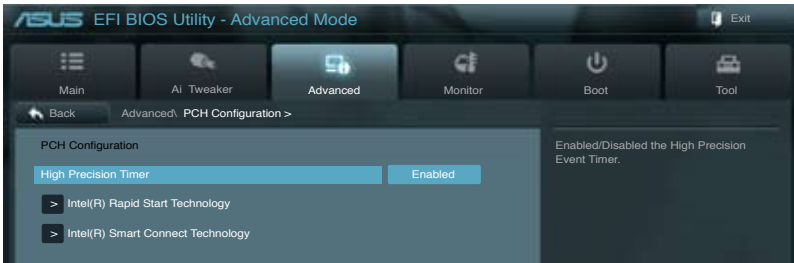

High Precision Timer [Enabled]

Allows you to enable or disable the High Precision Event Timer. Configuration options: [Enabled] [Disabled]

Intel(R) Rapid Start Technology

Intel(R) Rapid Start Technology [Disabled]

Allows you to enable or disable the Intel(R) Rapid Start Technology. Configuration options: [Enabled] [Disabled]



The following three items appear only when you set the **Intel(R) Rapid Start Technology** to [Enabled].

Entry on S3 RTC Wake [Enabled]

Allows you to enable or disable the iFFS invocation upon S3 RTC wake. Configuration options: [Enabled] [Disabled]

Entry After [Immediately]

This item appears only when you set the **Entry on S3 RTC Wake** to [Enabled] and allows you to set the RTC wake timer at S3 entry. Configuration options: [Immediately] [1 minute] [2 minutes] [5 minutes] [10 minutes] [15 minutes] [30 minutes] [1 hour] [2 hours]

Active Page Threshold Support [Enabled]

Allows you to enable or disable the Active Page Threshold Support. Configuration options: [Enabled] [Disabled]

Active Memory Threshold [x]

This item appears only when you set the **Active Page Threshold Support** to [Enabled] and allows you to set the Active Memory Threshold. When the partition size is larger than the Active Page Threshold size, the system will try to support the Intel(R) Rapid Start Technology. When the item is set to zero, the system automatically checks whether the partition size is enough at S3 entry. Key in the desired value using the numeric keypad.

Intel(R) Smart Connect Technology

ISCT Configuration [Disabled]

Allows you to enable or disable the ISCT configuration. Configuration options: [Enabled] [Disabled]

3.5.3 SATA Configuration

While entering Setup, the BIOS automatically detects the presence of SATA devices. The SATA Port items show **Not Present** if no SATA device is installed to the corresponding SATA port.

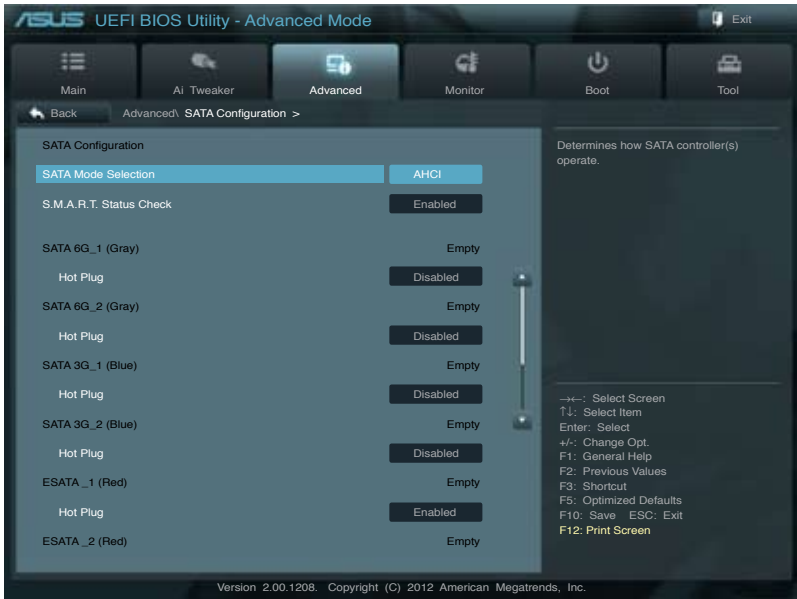

Scroll down to display the following items:

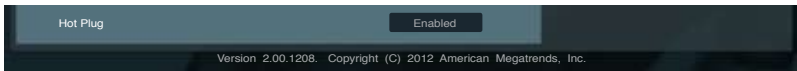

SATA Mode Selection [AHCI]

Allows you to set the SATA configuration.

[IDE] Set to [IDE Mode] when you want to use the Serial ATA hard disk drives as Parallel ATA physical storage devices.

[AHCI] Set to [AHCI Mode] when you want the SATA hard disk drives to use the AHCI (Advanced Host Controller Interface). The AHCI allows the onboard storage driver to enable advanced Serial ATA features that increases storage performance on random workloads by allowing the drive to internally optimize the order of commands.

[RAID] Set to [RAID Mode] when you want to create a RAID configuration from the SATA hard disk drives.

S.M.A.R.T. Status Check [Enabled]

S.M.A.R.T. (Self-Monitoring, Analysis and Reporting Technology) is a monitor system. When read/write of your hard disk errors occur, this feature allows the hard disk to report warning messages during the POST. Configuration options: [Enabled] [Disabled]

Hot Plug [Disabled]

These items appear only when you set the **SATA Mode Selection** item to [AHCI] or [RAID], and allow you to enable/disable SATA Hot Plug Support. Configuration options: [Disabled] [Enabled]

3.5.4 System Agent Configuration

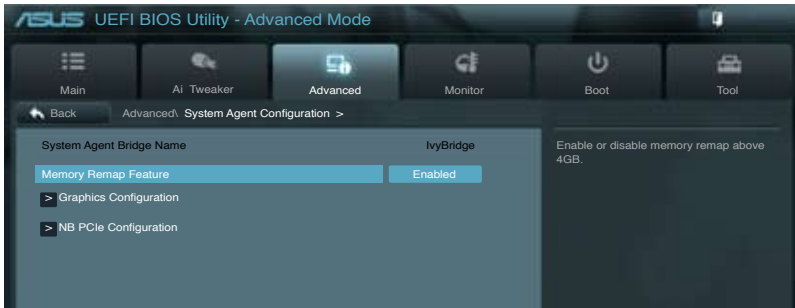

Memory Remap Feature [Enabled]

Allows you to enable remapping the memory above 4GB.

[Enabled] Enables the function.

[Disabled] Disables this function.

Graphics Configuration

Allows you to select a primary display from iGPU, and PCIe graphical devices.

Primary Display [Auto]

Allows you to select which of the iGPU/PCIE Graphics device should be the Primary Display. Configuration options: [Auto] [IGPU] [PCIE]

iGPU Memory [64M]

Allows you to select the amount of system memory allocated to DVMT 5.0 used by the iGPU. The configuration options vary with the system memory. Configuration options: [32M] [64M] [96M] [128M] ~ [448M] [480M] [512M] [1024M]

Render Standby [Enabled]

Allows you to enable the Intel Graphics Render Standby support to reduce the iGPU power use when idle. Configuration options: [Disabled] [Enabled]

iGPU Multi-Monitor [Disabled]

Allows you to enable the iGPU Multi-Monitor. For Lucid Virtu MVP function supports, set this item to [Enabled] to empower both integrated and discrete graphics. iGPU shared system memory size is fixed in 64MB. Configuration options: [Disabled] [Enabled]

NB PCIe Configuration

Allows you to configure the NB PCI Express settings.

PCIEX16 Link Speed [Auto]

Allows you to configure the PCIEX16 speed.

Configuration options: [Auto] [Gen1] [Gen2] [Gen3]

3.5.5 USB Configuration

The items in this menu allow you to change the USB-related features.

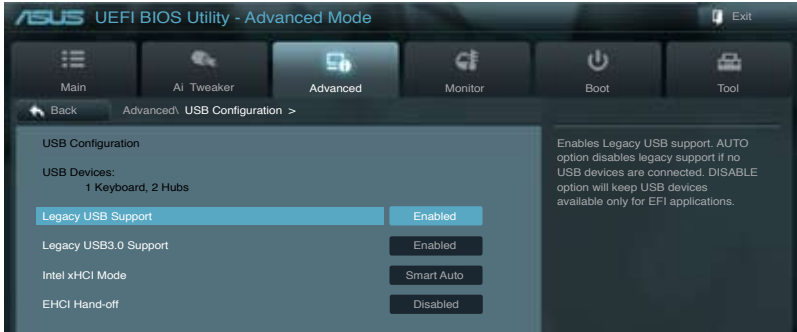

The **USB Devices** item shows the auto-detected values. If no USB device is detected, the item shows **None**.

Legacy USB Support [Enabled]

[Enabled] Enables the support for USB devices on legacy operating systems (OS).

[Disabled] The USB devices can be used only for the BIOS setup program.

[Auto] Allows the system to detect the presence of USB devices at startup. If detected, the USB controller legacy mode is enabled. If no USB device is detected, the legacy USB support is disabled.

Legacy USB3.0 Support [Enabled]

This item appears only when you set the previous item to [Auto] or [Enabled] and allows you to enable or disable the Legacy USB 3.0 Support.

[Enabled] Enables the support for USB 3.0 devices on legacy operating systems (OS).

[Disabled] Disables the function.

Intel xHCI Mode [Smart Auto]

Allows you to select the Intel xHCI Mode. Configuration options: [Smart Auto] [Auto] [Enabled] [Disabled]

EHCI Hand-off [Disabled]

[Enabled] Enables the support for operating systems without an EHCI hand-off feature.

[Disabled] Disables the function.

3.5.6 Onboard Devices Configuration

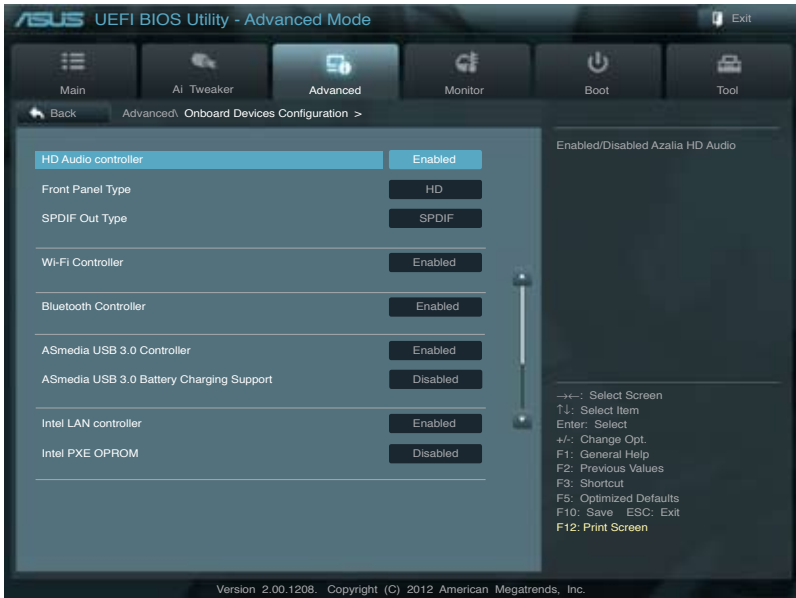

HD Audio Controller [Enabled]

[Enabled] Enables the High Definition Audio Controller.

[Disabled] Disables the controller.



The following two items appear only when you set the **HD Audio Controller** item to [Enabled].

Front Panel Type [HD]

Allows you to set the front panel audio connector (AAFP) mode to legacy AC'97 or high-definition audio depending on the audio standard that the front panel audio module supports.

[HD] Sets the front panel audio connector (AAFP) mode to high definition audio.

[AC97] Sets the front panel audio connector (AAFP) mode to legacy AC'97

SPDIF Out Type [SPDIF]

[SPDIF] Sets to [SPDIF] for SPDIF audio output.

[HDMI] Sets to [HDMI] for HDMI audio output.

Wi-Fi Controller [Enabled]

[Enabled] Enables the onboard Wi-Fi controller.

[Disabled] Disables the controller.

Bluetooth Controller [Enabled]

[Enabled] Enables the onboard bluetooth controller.

[Disabled] Disables the controller.

ASmedia USB 3.0 Controller [Enabled]

[Enabled] Enables the USB 3.0 controller.

[Disabled] Disables the controller.

ASmedia USB 3.0 Battery Charging Support [Disabled]

This item appears only when you set the previous item to [Enabled] and allows you to enable or disable the ASmedia USB 3.0 Battery Charging Support.

[Enabled] Enables Asmedia USB 3.0 fast battery charging support for USB 3.0 devices complying with the BC 1.1 regulation.

[Disabled] Disables battery charging support.

Intel LAN Controller [Enabled]

[Enabled] Enables the Intel LAN controller.

[Disabled] Disables the controller.

Intel PXE OPROM [Disabled]

This item appears only when you set the previous item to [Enabled] and allows you to enable or disable the PXE OptionRom of the Intel LAN controller.

Configuration options: [Enabled] [Disabled]

3.5.7 APM

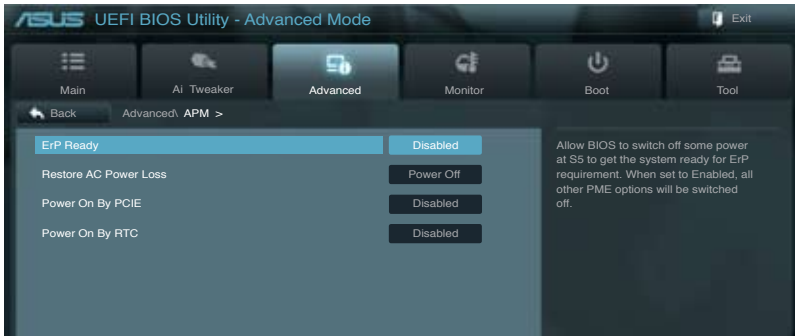

ErP Ready [Disbaled]

This item allows user to switch off some power at S5 to get the system ready for ErP requirement. When set to Enabled, all other PME options will be switched off.
Configuration options: [Disabled] [Enabled]

Restore AC Power Loss [Power Off]

- [Power On] The system goes into on state after an AC power loss.
- [Power Off] The system goes into off state after an AC power loss.
- [Last State] The system goes into either off or on state, whatever the system state was before the AC power loss.

Power On By PCIE [Disabled]

- [Disabled] Disables the PCIE devices to generate a wake-on-LAN feature of the Intel LAN device.
- [Enabled] Enables the PCIE devices to generate a wake-on-LAN feature of the Intel/LAN device.

Power On By RTC [Disabled]

- [Disabled] Disables RTC to generate a wake event.
- [Enabled] When set to [Enabled], the items **RTC Alarm Date (Days) and Hour/Minute/Second** will become user-configurable with set values.

3.5.8 Network Stack

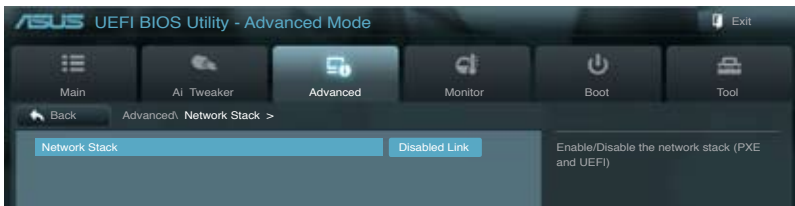

Network Stack [Disable Link]

This item allows user to disable or enable the UEFI network stack.
Configuration options: [Disable Link] [Enable]

3.6 Monitor menu

The Monitor menu displays the system temperature/power status, and allows you to change the fan settings.



Scroll down to display the following items:

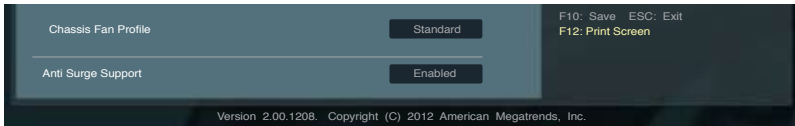

CPU Temperature / MB Temperature [xxx°C/xxx°F]

The onboard hardware monitor automatically detects and displays the CPU and motherboard temperatures. Select **Ignore** if you do not wish to display the detected temperatures.

CPU Fan Speed [xxxx RPM] or [Ignore] / [N/A]

Chassis Fan Speed [xxxx RPM] or [Ignore] / [N/A]

The onboard hardware monitor automatically detects and displays the CPU, chassis, and power fan speed in rotations per minute (RPM). If the fan is not connected to the motherboard, the field shows **N/A**. Select **Ignore** if you do not wish to display the detected speed.

CPU Voltage, 3.3V Voltage, 5V Voltage, 12V Voltage

The onboard hardware monitor automatically detects the voltage output through the onboard voltage regulators. Select **Ignore** if you do not want to detect this item.

CPU Q-Fan Control [Enabled]

[Disabled] Disables the CPU Q-Fan control feature.

[Enabled] Enables the CPU Q-Fan control feature.

CPU Fan Speed Low Limit [200 RPM]

This item appears only when you enable the **CPU Q-Fan Control** feature and allows you to disable or set the CPU fan warning speed.

Configuration options: [Ignore] [100 RPM] [200 RPM] [300 RPM] [400 RPM] [500 RPM]

CPU Fan Profile [Standard]

This item appears only when you enable the **CPU Q-Fan Control** feature and allows you to set the appropriate performance level of the CPU fan.

[Standard] Sets to [Standard] to make the CPU fan automatically adjust depending on the CPU temperature.

[Silent] Sets to [Silent] to minimize the fan speed for quiet CPU fan operation.

[Turbo] Sets to [Turbo] to achieve maximum CPU fan speed.

[Manual] Sets to [Manual] to assign detailed fan speed control parameters.



The following four items appear only when you set **CPU Fan Profile** to [Manual].

CPU Upper Temperature [70]

Use the <+> and <-> keys to adjust the upper limit of the CPU temperature. The values range from 20°C to 75°C.

CPU Fan Max. Duty Cycle(%) [100]

Use the <+> and <-> keys to adjust the maximum CPU fan duty cycle. The values range from 20% to 100%. When the CPU temperature reaches the upper limit, the CPU fan will operate at the maximum duty cycle.

CPU Lower Temperature [20]

Use the <+> and <-> keys to adjust the lower limit of the CPU temperature. The values range from 20°C to 75°C.

CPU Fan Min. Duty Cycle(%) [20]

Use the <+> and <-> keys to adjust the minimum CPU fan duty cycle. The values range from 0% to 100%. When the CPU temperature is under 20°C, the CPU fan will operate at the minimum duty cycle.

Chassis Q-Fan Control [Enabled]

[Disabled] Disables the Chassis Q-Fan control feature.

[Enabled] Enables the Chassis Q-Fan control feature.

Chassis Fan Speed Low Limit [600 RPM]

This item appears only when you enable the **Chassis Q-Fan Control** feature and allows you to disable or set the chassis fan warning speed.

Configuration options: [Ignore] [200 RPM] [300 RPM] [400 RPM] [500 RPM] [600 RPM]

Chassis Fan Profile [Standard]

This item appears only when you enable the **Chassis Q-Fan Control** feature and allows you to set the appropriate performance level of the chassis fan.

[Standard] Sets to [Standard] to make the chassis fan automatically adjust depending on the chassis temperature.

[Silent] Sets to [Silent] to minimize the fan speed for quiet chassis fan operation.

[Turbo] Sets to [Turbo] to achieve maximum chassis fan speed.

[Manual] Sets to [Manual] to assign detailed fan speed control parameters.



The following four items appear only when you set **Chassis Fan Profile** to [Manual].

Chassis Upper Temperature [70]

Use the <+> and <-> keys to adjust the upper limit of the CPU temperature. The values range from 40°C to 90°C.

Chassis Fan Max. Duty Cycle(%) [100]

Use the <+> and <-> keys to adjust the maximum chassis fan duty cycle. The values range from 60% to 100%. When the chassis temperature reaches the upper limit, the chassis fan will operate at the maximum duty cycle.

Chassis Lower Temperature [40]

Displays the lower limit of the chassis temperature.

CPU Fan Min. Duty Cycle(%) [60]

Use the <+> and <-> keys to adjust the minimum chassis fan duty cycle. The values range from 60% to 100%. When the chassis temperature is under 60°C, the chassis fan will operate at the minimum duty cycle.

Anti Surge Support [Enabled]

This item allows you to enable or disable the Anti Surge function.

Configuration options: [Disabled] [Enabled]

3.7 Boot menu

The Boot menu items allow you to change the system boot options.

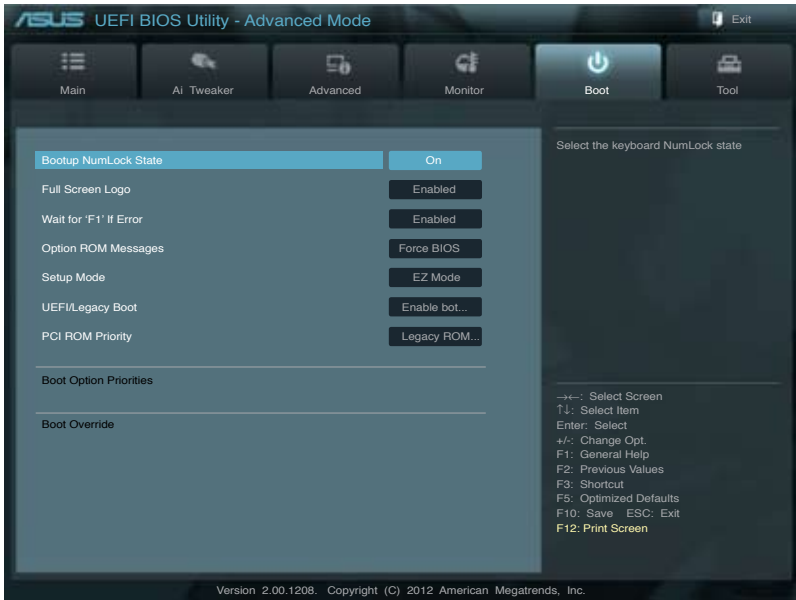

Bootup NumLock State [On]

[On] Sets the power-on state of the NumLock to [On].

[Off] Sets the power-on state of the NumLock to [Off].

Full Screen Logo [Enabled]

[Enabled] Enables the full screen logo display feature.

[Disabled] Disables the full screen logo display feature.



Set this item to [Enabled] to use the ASUS MyLogo 2™ feature.

Wait For 'F1' If Error [Enabled]

[Disabled] Disables this function.

[Enabled] The system waits for the <F1> key to be pressed when error occurs.

Option ROM Messages [Force BIOS]

[Force BIOS] The third-party ROM messages will be forced to display during the boot sequence.

[Keep Current] The third-party ROM messages will be displayed only if the third-party manufacturer had set the add-on device to do so.

Setup Mode [EZ Mode]

[Advanced Mode] Sets Advanced Mode as the default screen for entering the BIOS setup program.

[EZ Mode] Sets EZ Mode as the default screen for entering the BIOS setup program.

UEFI/Legacy Boot [Enable both UEFI and Legacy]

[Enable both UEFI and Legacy] Enables both UEFI and Legacy boot.

[Disable UEFI] Enables the Legacy boot, and disables the UEFI boot.

[Disable Legacy] Enables the UEFI boot, and disables the Legacy boot.

PCI ROM Priority [Legacy ROM]

[Legacy ROM] Launch Legacy ROM

[EFI Compatible ROM] Launch UEFI Compatible ROM

Boot Option Priorities

These items specify the boot device priority sequence from the available devices. The number of device items that appears on the screen depends on the number of devices installed in the system.



-
- To select the boot device during system startup, press <F8> when ASUS Logo appears.
 - To access Windows OS in Safe Mode, do any of the following:
 - Press <F5> when ASUS Logo appears.
 - Press <F8> after POST.
-

Boot Override

These items displays the available devices. The number of device items that appears on the screen depends on the number of devices installed in the system. Click an item to start booting from the selected device.

3.8 Tools menu

The Tools menu items allow you to configure options for special functions. Select an item then press <Enter> to display the submenu.

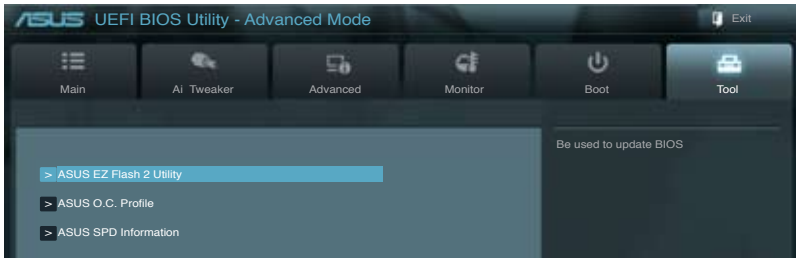

3.8.1 ASUS EZ Flash 2 Utility

Allows you to run ASUS EZ Flash 2. When you press <Enter>, a confirmation message appears. Use the left/right arrow key to select between [Yes] or [No], then press <Enter> to confirm your choice.



For more details, refer to **section 3.10.2 ASUS EZ Flash 2 utility**.

3.8.2. ASUS O.C. Profile

This item allows you to store or load multiple BIOS settings.

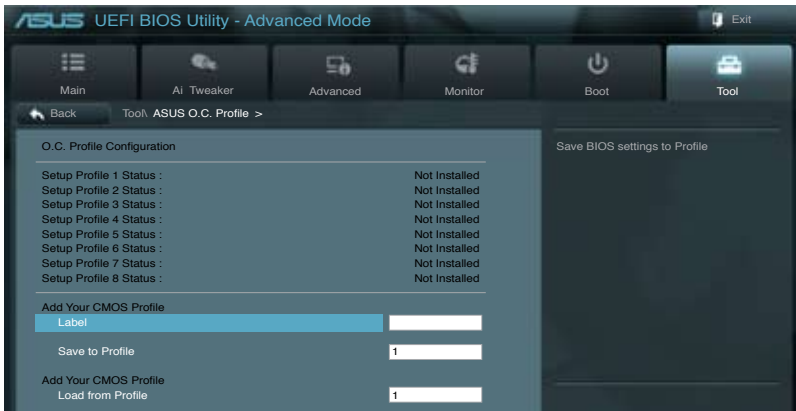

The **Setup Profile Status** items show **Not Installed** if no profile is created.

Save to Profile

Allows you to save the current BIOS settings to the BIOS Flash, and create a profile. Key in a profile number from one to eight, press <Enter>, and then select **Yes**.

Load from Profile

Allows you to load the previous BIOS settings saved in the BIOS Flash. Key in the profile number that saved your BIOS settings, press <Enter>, and then select **Yes**.



- DO NOT shut down or reset the system while updating the BIOS to prevent the system boot failure!
- We recommend that you update the BIOS file only coming from the same memory/CPU configuration and BIOS version.

3.8.3. ASUS SPD Information

Allows you to view the DRAM SPD information.

ASUS UEFI BIOS Utility - Advanced Mode

Main AI Tweaker Advanced Monitor Boot Tool

Back Tool: ASUS SPD Information >

DIMM Slot #	DIMM_A1
Manufacturer	Samsung
Module Size	1024 MBytes
Maximum Bandwidth	1333 Mhz
Part Number	M391B2873DZ1-CH9
Serial Number	060369f9
Product Week/Year	50/2012
SPD Ext.	XMP

JEDEC ID	JEDEC
Frequency(Mhz)	1333
Voltage (V)	1.500
CAS# Latency (tCL)	9
RAS# to CAS# (tRCD)	9
RAS# Precharge(tRP)	9
tRAS	24
tRC	33
tWR	10
tRRD	4
tRFC	74
tWTR	5
tRTP	5
tFAW	20

Legend:

- ←: Select Screen
- ↑↓: Select Item
- Enter: Select
- +/-: Change Opt.
- F1: General Help
- F2: Previous Values
- F8: Shortcut
- F5: Optimized Defaults
- F10: Save ESC: Exit
- F12: Print Screen

Version 2.00.1208. Copyright (C) 2012. American Megatrends, Inc.

3.9 Exit menu

The Exit menu items allow you to load the optimal default values for the BIOS items, and save or discard your changes to the BIOS items. You can access the **EZ Mode** from the Exit menu.

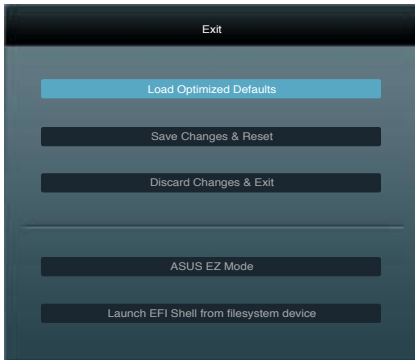

Load Optimized Defaults

This option allows you to load the default values for each of the parameters on the Setup menus. When you select this option or if you press <F5>, a confirmation window appears. Select **Yes** to load the default values.

Save Changes & Reset

Once you are finished making your selections, choose this option from the Exit menu to ensure the values you selected are saved. When you select this option or if you press <F10>, a confirmation window appears. Select **Yes** to save changes and exit.

Discard Changes & Exit

This option allows you to exit the Setup program without saving your changes. When you select this option or if you press <Esc>, a confirmation window appears. Select **Yes** to discard changes and exit.

ASUS EZ Mode

This option allows you to enter the EZ Mode screen.

Launch EFI Shell from filesystem device

This option allows you to attempt to launch the EFI Shell application (shellx64.efi) from one of the available filesystem devices.

3.10 Updating BIOS

The ASUS website publishes the latest BIOS versions to provide enhancements on system stability, compatibility, or performance. However, BIOS updating is potentially risky. If there is no problem using the current version of BIOS, **DO NOT manually update the BIOS**. Inappropriate BIOS updating may result in the system's failure to boot. Carefully follow the instructions of this chapter to update your BIOS if necessary.



Visit the ASUS website (www.asus.com) to download the latest BIOS file for this motherboard.

The following utilities allow you to manage and update the motherboard BIOS setup program.

1. **ASUS Update:** Updates the BIOS in Windows® environment.
2. **ASUS EZ Flash 2:** Updates the BIOS using a USB flash drive.
3. **ASUS CrashFree BIOS 3:** Restores the BIOS using the motherboard support DVD or a USB flash drive when the BIOS file fails or gets corrupted.
4. **ASUS BIOS Updater:** Updates and backups the BIOS in DOS environment using the motherboard support DVD and a USB flash disk drive.

Refer to the corresponding sections for details on these utilities.



Save a copy of the original motherboard BIOS file to a USB flash disk in case you need to restore the BIOS in the future. Copy the original motherboard BIOS using the **ASUS Update** or **BIOS Updater** utilities.

3.10.1 ASUS Update utility

The ASUS Update is a utility that allows you to manage, save, and update the motherboard BIOS in Windows® environment. The ASUS Update utility allows you to:

- Update the BIOS directly from the Internet
- Download the latest BIOS file from the Internet
- Update the BIOS from an updated BIOS file
- View the BIOS version information

This utility is available in the support DVD that comes with the motherboard package.



ASUS Update requires an Internet connection either through a network or an Internet Service Provider (ISP).

Launching ASUS Update

After installing AI Suite II from the motherboard support DVD, launch ASUS Update by clicking **Update > ASUS Update** on the AI Suite II main menu bar.



Quit all Windows® applications before you update the BIOS using this utility.

Updating the BIOS through the Internet

To update the BIOS through the Internet:

1. From the ASUS Update screen, select **Update BIOS from Internet**, and then click **Next**.



2. Select the ASUS FTP site nearest you to avoid network traffic.
If you want to enable the BIOS downgradable function, check the checkbox before the item.



3. Select the BIOS version that you want to download. Click **Next**.

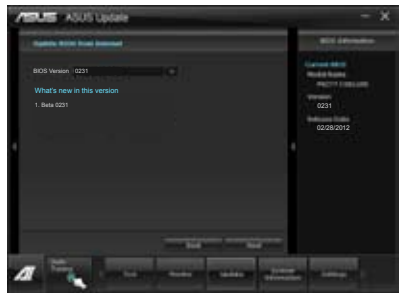

4. You can decide whether to change the BIOS boot logo, which is the image appearing on screen during the Power-On Self-Tests (POST). Click **Yes** if you want to change the boot logo or **No** to continue.
5. Follow the onscreen instructions to complete the update process.

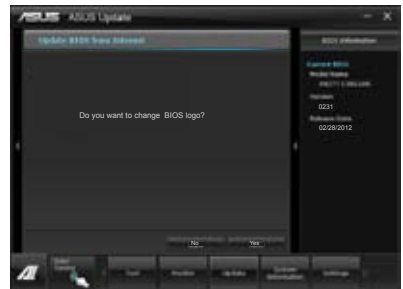

Updating the BIOS through a BIOS file

To update the BIOS through a BIOS file:

1. From the ASUS Update screen, select **Update BIOS from file**, and then click **Next**.



2. Locate the BIOS file from the Open window, click **Open**, and click **Next**.



3. You can decide whether to change the BIOS boot logo. Click **Yes** if you want to change the boot logo or **No** to continue.
4. Follow the onscreen instructions to complete the update process.



- The screenshots in this section are for reference only. The actual BIOS information vary by models.
- Refer to the software manual in the support DVD or visit the ASUS website at www.asus.com for detailed software configuration.

3.10.2 ASUS EZ Flash 2 utility

The ASUS EZ Flash 2 feature allows you to update the BIOS without having to use a bootable floppy disk or an OS-based utility.



Before you start using this utility, download the latest BIOS from the ASUS website at www.asus.com.

To update the BIOS using EZ Flash 2:

1. Insert the USB flash disk that contains the latest BIOS file to the USB port.
2. Enter the Advanced Mode of the BIOS setup program. Go to the **Tool** menu to select **ASUS EZ Flash Utility** and press <Enter> to enable it.

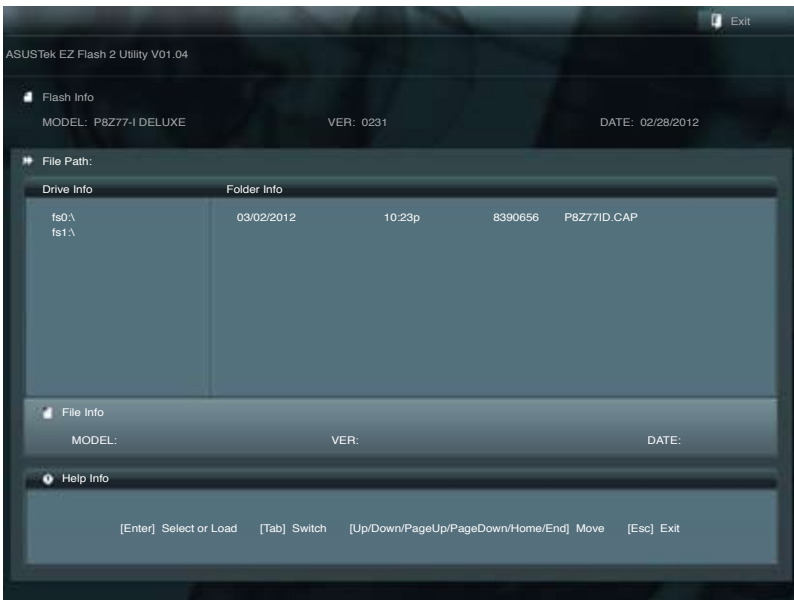

3. Press <Tab> to switch to the Drive Info field.
4. Press the Up/Down arrow keys to find the USB flash disk that contains the latest BIOS, and then press <Enter>.
5. Press <Tab> to switch to the Folder Info field.
6. Press the Up/Down arrow keys to find the BIOS file, and then press <Enter> to perform the BIOS update process. Reboot the system when the update process is done.



-
- This function can support devices such as a USB flash disk with FAT 32/16 format and single partition only.
 - DO NOT shut down or reset the system while updating the BIOS to prevent system boot failure!
-



Ensure to load the BIOS default settings to ensure system compatibility and stability. Select the **Load Optimized Defaults** item under the **Exit** menu. See section 3.9 **Exit Menu** for details.

3.10.3 ASUS CrashFree BIOS 3 utility

The ASUS CrashFree BIOS 3 utility is an auto recovery tool that allows you to restore the BIOS file when it fails or gets corrupted during the updating process. You can restore a corrupted BIOS file using the motherboard support DVD or a USB flash drive that contains the BIOS file.



-
- The BIOS file in the motherboard support DVD may be older than the BIOS file published on the ASUS official website. If you want to use the newer BIOS file, download the file at support.asus.com and save it to a USB flash drive.
 - Before using this utility, rename the BIOS file in the removable device into **P8Z77ID.CAP**.
-

Recovering the BIOS

To recover the BIOS:

1. Turn on the system.
2. Insert the motherboard support DVD to the optical drive, or the USB flash drive containing the BIOS file to the USB port.
3. The utility automatically checks the devices for the BIOS file. When found, the utility reads the BIOS file and enters ASUS EZ Flash 2 utility automatically.
4. The system requires you to enter BIOS Setup to recover BIOS setting. To ensure system compatibility and stability, we recommend that you press <F5> to load default BIOS values.



DO NOT shut down or reset the system while updating the BIOS! Doing so can cause system boot failure!

3.10.4 ASUS BIOS Updater

The ASUS BIOS Updater allows you to update BIOS in DOS environment. This utility also allows you to copy the current BIOS file that you can use as a backup when the BIOS fails or gets corrupted during the updating process.



The succeeding utility screens are for reference only. The actual utility screen displays may not be same as shown.

Before updating BIOS

1. Prepare the motherboard support DVD and a USB flash drive in FAT32/16 format and single partition.
2. Download the latest BIOS file and BIOS Updater from the ASUS website at <http://support.asus.com> and save them on the USB flash drive.



- NTFS is not supported under DOS environment. Do not save the BIOS file and BIOS Updater to a hard disk drive or USB flash drive in NTFS format.
- Do not save the BIOS file to a floppy disk due to low disk capacity.

3. Turn off the computer and disconnect all SATA hard disk drives (optional).

Booting the system in DOS environment

1. Insert the USB flash drive with the latest BIOS file and BIOS Updater to the USB port.
2. Boot your computer. When the ASUS Logo appears, press <F8> to show the **BIOS Boot Device Select Menu**. Insert the support DVD into the optical drive and select the optical drive as the boot device.

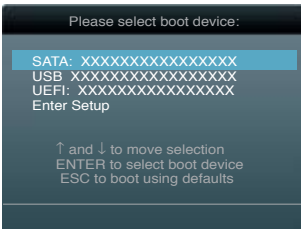

3. When the **Make Disk** menu appears, select the **FreeDOS command prompt** item by pressing the item number.
4. At the FreeDOS prompt, type **d:** and press <Enter> to switch the disk from Drive C (optical drive) to Drive D (USB flash drive).



Updating the BIOS file

To update the BIOS file using BIOS Updater

1. At the FreeDOS prompt, type `bupdater /pc /g` and press <Enter>.

```
D:\>bupdater /pc /g
```

2. The BIOS Updater screen appears as below.

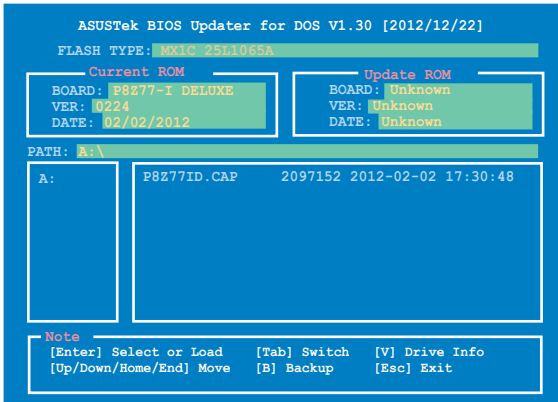

3. Press <Tab> to switch between screen fields and use the <Up/Down/Home/End> keys to select the BIOS file and press <Enter>. BIOS Updater checks the selected BIOS file and prompts you to confirm BIOS update.



4. Select **Yes** and press <Enter>. When BIOS update is done, press <ESC> to exit BIOS Updater. Restart your computer.



DO NOT shut down or reset the system while updating the BIOS to prevent system boot failure!



- For BIOS Updater version 1.04 or later, the utility automatically exits to the DOS prompt after updating BIOS.
- Ensure to load the BIOS default settings to ensure system compatibility and stability. Select the **Load Optimized Defaults** item under the **Exit** BIOS menu. See Chapter 3 of your motherboard user manual for details.
- Ensure to connect all SATA hard disk drives after updating the BIOS file if you have disconnected them.

Chapter 4

4.1 Installing an operating system

This motherboard supports Windows® XP/ 64-bit XP/ 7 / 64-bit 7 operating systems (OS). Always install the latest OS version and corresponding updates to maximize the features of your hardware.



- Motherboard settings and hardware options vary. Use the setup procedures presented in this chapter for reference only. Refer to your OS documentation for detailed information.
- Ensure that you install the Windows® XP Service Pack 3 or later versions before installing the drivers for better compatibility and system stability.

4.2 Support DVD information

The support DVD that comes with the motherboard package contains the drivers, software applications, and utilities that you can install to avail all motherboard features.



The contents of the support DVD are subject to change at any time without notice. Visit the ASUS website at www.asus.com for updates.

4.2.1 Running the support DVD

Place the support DVD into the optical drive. The DVD automatically displays the Drivers menu if Autorun is enabled in your computer. Click each menu tab and select the items you want to install.

The Drivers menu shows the available device drivers if the system detects installed devices. Install the necessary drivers to use the devices.

The Make Disk menu contains items to create the RAID/AHCI driver disk.

The Manual menu contains the list of supplementary user manuals. Click an item to open the folder of the user manual.

The Utilities menu shows the applications and other software that the motherboard supports.

Click the Contact tab to display the ASUS contact information.

Click an icon to display DVD/ motherboard information

Click an item to install

Click to display more items



If Autorun is NOT enabled in your computer, browse the contents of the support DVD to locate the file ASSETUP.EXE from the BIN folder. Double-click the ASSETUP.EXE to run the DVD.

4.2.2 Obtaining the software manuals

The software manuals are included in the support DVD. Follow the instructions below to get the necessary software manuals.



The software manual files are in Portable Document Format (PDF). Install the Adobe® Acrobat® Reader from the Utilities menu before opening the files.

1. Click the **Manual** tab. Click **ASUS Motherboard Utility Guide** from the manual list on the left.



2. The **Manual** folder of the support DVD appears. Double-click the folder of your selected software.

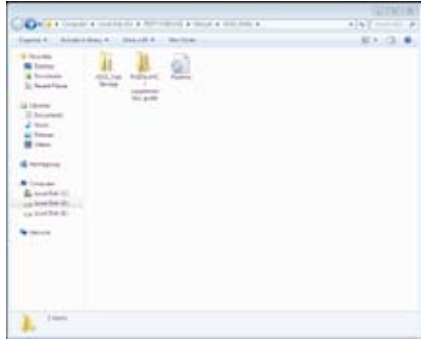

3. Some software manuals are provided in different languages. Double-click the language to show the software manual.

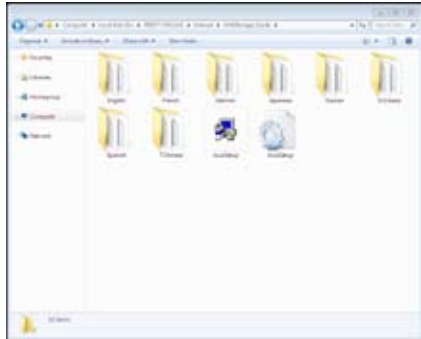

The screenshots in this section are for reference only. The actual software manuals containing in the support DVD vary by models.

4.3 Software information

Most of the applications in the support DVD have wizards that will conveniently guide you through the installation. View the online help or readme file that came with the software application for more information.

4.3.1 AI Suite II

AI Suite II is an all-in-one interface that integrates several ASUS utilities and allows users to launch and operate these utilities simultaneously.

Installing AI Suite II

To install AI Suite II on your computer

1. Place the support DVD to the optical drive. The Drivers installation tab appears if your computer has enabled the Autorun feature.
2. Click the Utilities tab, then click **AI Suite II**.
3. Follow the onscreen instructions to complete installation.

Using AI Suite II

AI Suite II automatically starts when you enter the Windows® operating system (OS). The AI Suite II icon appears in the Windows® notification area. Click the icon to open the AI Suite II main menu bar.

Click each button to select and launch a utility, to monitor the system, to update the motherboard BIOS, to display the system information, and to customize the settings of AI Suite II.

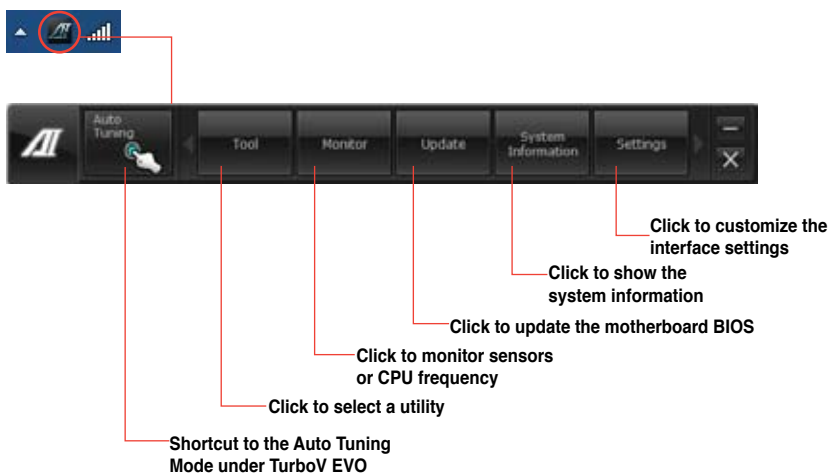

- The **Auto Tuning** button appears only on models with the TurboV EVO function.
- The applications in the Tool menu vary with models.
- The screenshots of AI Suite II in this user manual are for reference only. The actual screenshots vary with models.
- Refer to the software manual in the support DVD or visit the ASUS website at www.asus.com for detailed software configuration.

4.3.2 TurboV EVO

ASUS TurboV EVO introduces **TurboV** that allows you to manually adjust the CPU frequency and related voltages as well as **Auto Tuning** function that offers automatic and easy overclocking and system level up. After installing AI Suite II from the motherboard support DVD, launch TurboV EVO by clicking **Tool > TurboV EVO** on the AI Suite II main menu bar.



Refer to the software manual in the support DVD or visit the ASUS website at www.asus.com for detailed software configuration.

TurboV

TurboV allows you to overclock the BCLK frequency, CPU voltage, IMC voltage, and DRAM Bus voltage in Windows® environment and takes effect in real-time without exiting and rebooting the OS.



Refer to the CPU documentation before adjusting CPU voltage settings. Setting a high voltage may damage the CPU permanently, and setting a low voltage may make the system unstable.



For system stability, all changes made in TurboV will not be saved to BIOS settings and will not be kept on the next system boot. Use the **Save Profile** function to save your customized overclocking settings and manually load the profile after Windows starts.

The screenshot shows the ASUS TurboV EVO software interface. On the left, there are two main sections: 'Manual Mode' and 'Advanced Mode'. The 'Manual Mode' section includes sliders for BCLK Frequency (980), CPU Voltage (1.050), and BCLK Voltage (1.500). The 'Advanced Mode' section includes sliders for VCCSA Voltage (1.020), CPU PLL Voltage (1.8), and PCI Voltage (1.02). On the right, there is a 'CPU' section showing real-time values: CPU Frequency (1604.6 MHz), CPU Voltage (1.050 V), GPU Frequency (0350.0 MHz), and CPU Usage (0%). At the bottom, there are buttons for 'Save Profile', 'Load Profile', 'Undo', 'Apply', 'Restore', and 'Settings'. Red lines and boxes connect these elements to descriptive text labels.

- Click to select mode
- Load profile
- Target values
- Current values
- Click to show settings
- Click to restore all start-up settings
- Save the current settings as a new profile
- Voltage Adjustment bars
- Undoes all changes without applying
- Applies all changes immediately

Using Advanced Mode

Click on the **Advanced Mode** tab to adjust the advanced voltage settings.



CPU Ratio

Allows you to manually adjust the CPU ratio.

1. Click on the **CPU Ratio** tab.
2. Drag the adjustment bar upwards or downwards to the desired value.
3. Click on **Apply** to make the change take effect.



- Set the **CPU Ratio Setting** item in BIOS to [Auto] before using the CPU Ratio function in TurboV. Refer to Chapter 3 of your motherboard user manual for details.
- The CPU Ratio bars show the status of the CPU cores, which vary with your CPU model.

Auto Tuning / GPU Boost

ASUS TurboV EVO includes two auto tuning / GPU Boost modes, providing the most flexible auto-tuning options.



- The overclocking result varies with the CPU model and the system configuration.
- To prevent overheating from damaging the motherboard, a better thermal environment is strongly recommended.

- **Fast Tuning:** fast CPU overclocking
- **Extreme Tuning:** extreme overclocking for CPU, GPU and memory

Using Fast Tuning

1. Click the **Auto Tuning** tab and then click **Fast**.
2. Read through the warning messages and click **OK** to start auto-overclocking.



3. TurboV automatically overclocks the CPU, saves BIOS settings and restarts the system. After re-entering Windows, a message appears indicating auto tuning success. Click **OK** to exit.



Using Extreme Tuning

1. Click the **Auto Tuning** tab and then click **Extreme**.
2. Read through the warning messages and click **OK** to start auto-overclocking.

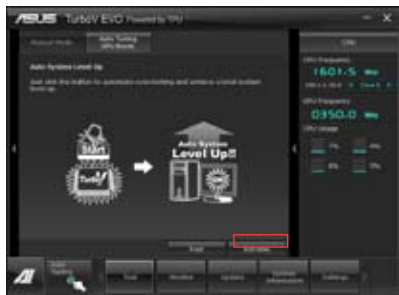

3. TurboV automatically overlocks the CPU and memory and restarts the system. After re-entering Windows, a message appears indicating the current overclocking result. To keep the result, click **Stop**.



4. If you did not click **Stop** in the previous step, TurboV automatically starts further system overclocking and stability test. An animation appears indicating the overclocking process. Click **Stop** if you want to cancel the Overclocking process.



5. TurboV automatically adjusts and saves BIOS settings and restarts the system. After re-entering Windows, a message appears indicating auto tuning success. Click **OK** to exit.



4.3.3 DIGI+ VRM

ASUS DIGI+ VRM allows you to adjust VRM voltage and frequency modulation to enhance reliability and stability. It also provides the highest power efficiency, generating less heat to longer component lifespan and minimize power loss.

After installing AI Suite II from the motherboard support DVD, launch DIGI+ VRM by clicking **Tool > DIGI+ VRM** on the AI Suite II main menu bar.



Items	Function description
1	CPU Load-line Calibration It allows you to adjust the voltage range to control CPU Load Line. Set to a high value for system performance or to a low value for power efficiency.
2	CPU Current Capability A higher value provides wider total power range and extends the overclocking frequency range simultaneously.
3	CPU Voltage Frequency It allows you to enable Spread Spectrum to enhance system stability.
4	iGPU Load-line Calibration iGPU Load-line is based on Intel VRM specifications, and affects the iGPU voltage. A higher value can get a higher iGPU voltage and a good performance, but decreases the CPU and VRM thermal conditions.
5	iGPU Current Capability A higher value brings higher iGPU power range, and extends the overclocking frequency range simultaneously to enhance the iGPU performance.
6	CPU Power Phase Control Increase phase number under heavy system loading to get more transient and better thermal performance. Reduce phase number under light system loading to increase VRM efficiency.
7	CPU Power Response Control The DIGI+ VRM controller provides a faster and precise power response rate for CPU. Apply a higher value for an extreme overclocking.
8	CPU Power Duty Control CPU Power Duty Control adjusts the current of every VRM phase and the thermal of every phase component.



- The actual performance boost may vary depending on your CPU specification.
- Do not remove the thermal module. The thermal conditions should be monitored.



Refer to the software manual in the support DVD or visit the ASUS website at www.asus.com for detailed software configuration.

4.3.4 EPU

EPU is an energy-efficient tool that satisfies different computing needs. This utility provides several modes that you can select to save system power. Selecting Auto mode will have the system shift modes automatically according to current system status. You can also customize each mode by configuring settings like CPU frequency, GPU frequency, vCore Voltage, and Fan Control.

Launching EPU

After installing AI Suite II from the motherboard support DVD, launch EPU by clicking **Tool > EPU** on the AI Suite II main menu bar.

The screenshot shows the ASUS EPU utility interface. At the top, there are three operating modes: **Auto** (selected), **High performance**, and **Max. power saving**. Below these are five system property categories: **Transparency**, **Performance**, **Connectivity**, **Reliability**, and **Energy Saved**. A central pentagon icon is used to navigate between these categories. On the right, an **EPU Status** window is open, showing icons for CPU, GPU, Fan, vCore, and Memory, with the CPU icon highlighted. It also displays **Reduced CO2 Emission** (0.000 mg), a **Clear** button, and **Current CPU Power** (3.56 W@50C).

Multiple system operating modes - Points to the mode selection area at the top.

Displays the following message if no VGA power saving engine is detected. - Points to a small error message box.

The items lighting up means power saving engine is activated - Points to the highlighted CPU icon in the EPU Status window.

Displays the amount of CO2 reduced - Points to the 'Reduced CO2 Emission' value.

***Shifts between the display of Total and Current CO₂ reduced** - Points to the 'Clear' button.

Displays the current CPU power - Points to the 'Current CPU Power' value.

Advanced settings for each mode - Points to the bottom navigation bar with buttons like 'Auto Tuning', 'Tool', 'Monitor', 'Update', 'System Information', and 'Settings'.

Displays the system properties of each mode - Points to the central pentagon icon.



- * Select **From EPU Installation** to show the CO₂ that has been reduced since you installed EPU.
- * Select **From the Last Reset** to show the total CO₂ that has been reduced since you click the **Clear** button.
- Refer to the software manual in the support DVD or visit the ASUS website at www.asus.com for detailed software configuration.

4.3.5 FAN Xpert

Fan Xpert intelligently allows you to adjust both the CPU and chassis fan speeds according to different ambient temperatures caused by different climate conditions in different geographic regions and your PC's system loading. The built-in variety of useful profiles offer flexible controls of fan speed to achieve a quiet and cool environment.

Launching FAN Xpert

After installing AI Suite II from the motherboard support DVD, launch FAN Xpert by clicking **Tool > Fan Xpert** on the AI Suite II main menu bar.

Using FAN Xpert

Click **Fan Name** to select a fan and then click **Setting** to select a preset mode for your selected fan.

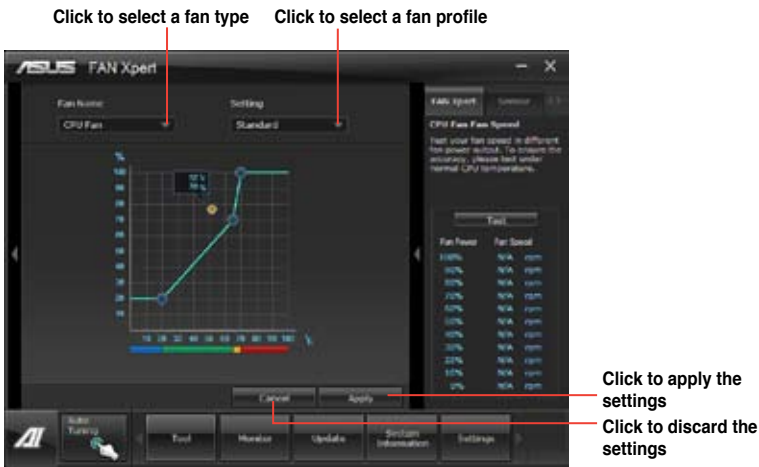

Fan setting

- **Disable:** disables the **Fan Xpert** function.
- **Standard:** adjusts the fan speed in a moderate pattern.
- **Silent:** minimizes the fan speed for quiet fan operation.
- **Turbo:** maximizes the fan speed for the best cooling effect.
- **User:** Allows you to configure the CPU fan profile under certain limitations.



Refer to the software manual in the support DVD or visit the ASUS website at www.asus.com for detailed software configuration.

4.3.6 Probe II

Probe II is a utility that monitors the computer's vital components, and detects and alerts you of any problem with these components. Probe II senses fan rotations, CPU temperature, and system voltages, among others. With this utility, you are assured that your computer is always at a healthy operating condition.

Launching Probe II

After installing AI Suite II from the motherboard support DVD, launch Probe II by clicking **Tool > Probe II** on the AI Suite II main menu bar.

Configuring Probe II

Click the **Voltage/Temperature/Fan Speed** tabs to activate the sensors or to adjust the sensor threshold values. The **Preference** tab allows you to customize the time interval of sensor alerts, or change the temperature unit.

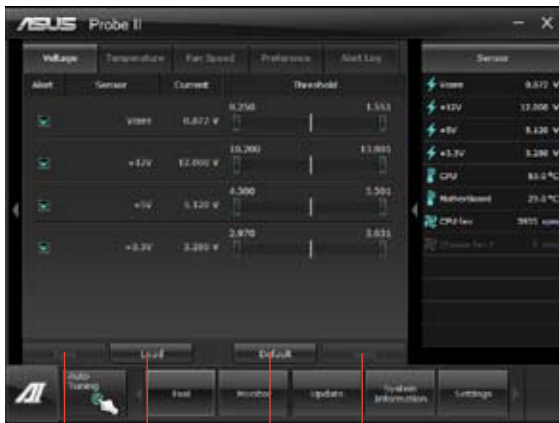

Saves your configuration

Loads your saved configuration

Loads the default threshold values for each sensor

Applies your changes



Refer to the software manual in the support DVD or visit the ASUS website at www.asus.com for detailed software configuration.

4.3.7 Sensor Recorder

Sensor Recorder monitors the changes in the system voltage, temperature, and fan speed on a timeline. The History Record function allows you to designate specific time spans on record to keep track of the three system statuses for certain purposes.

Launching Sensor Recorder

After installing AI Suite II from the motherboard support DVD, launch Sensor Recorder by clicking **Tool > Sensor Recorder** on the AI Suite II main menu bar.

Using Sensor Recorder

Click on **Voltage/ Temperature/ Fan Speed** tabs for the status you want to monitor. Colored lines will automatically appear on the diagram to indicate the immediate changes in the system status.



Using History Record

1. Click on the **History Record** tab and adjust the settings on the left for **Record Interval** and **Record Duration** according to need.
2. Click on **Start Recording** to start measurement and recording of each sensor.
3. To stop recording, click on **Recording** again.
4. To track the recorded contents, set **Type/ Date/ Select display items** to display the history details.

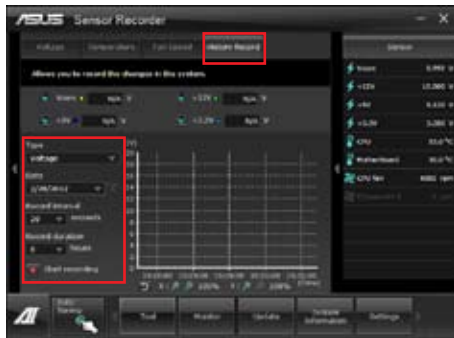

Click on **Monitor > Sensor** on the AI Suite II main menu bar and a highlight of the system statuses will appear on the right panel.

4.3.8 Ai Charger+

Battery Charging Version 1.1 (BC 1.1), a USB Implementers Forum (USB-IF) certified USB charging function, is designed to make USB charging faster than the standard USB devices. If your USB device supports the BC 1.1 function*, when you connect your USB device to your system, the system automatically detects your USB device and starts a fast USB charging. The charging speed may get 3 times faster than that of the standard USB devices**.



- * Check your USB device manufacturer if it fully supports the BC 1.1 function.
- ** The actual charging speed may vary with your USB device's conditions.
- Ensure to remove and reconnect your USB device after enabling or disabling Ai Charger+ to ensure normal charging function.



4.3.9 USB 3.0 Boost

The ASUS exclusive USB 3.0 Boost provides speed boost for USB 3.0 devices and the up-to-date support of USB Attached SCSI Protocol (UASP). With USB 3.0 Boost, you can accelerate the transfer speed of your USB 3.0 devices with ease.

Launching USB 3.0 Boost

After installing AI Suite II from the motherboard support DVD, launch USB 3.0 Boost by clicking **Tool > USB 3.0 Boost** on the AI Suite II main menu bar.

Configuring USB 3.0 Boost

1. Connect a USB 3.0 device to the USB 3.0 port.
2. USB 3.0 Boost automatically detects the property of the connected device and switches to **Turbo** mode or **UASP** mode (if UASP is supported by the connected device).
3. You can manually switch the USB 3.0 mode back to **Normal** mode at any time.



- Refer to the software manual in the support DVD or visit the ASUS website at www.asus.com for detailed software configuration.
- Due to Intel® chipset limitation, Intel® USB 3.0 ports do not support ASUS 3.0 Boost in Windows XP operating system.
- Use the USB 3.0 devices for high performance. The data transfer speed varies with USB devices.

4.3.10 Wi-Fi GO!

Wi-Fi GO! allows you to wirelessly stream media files to DLNA devices, remotely control and access your computer using your mobile device, and easily transfer files between your computer and mobile device.



- Install the Wi-Fi GO! card and the driver before using this feature.
- Wi-Fi GO! is supported only on Windows® 7.
- All devices using the Wi-Fi GO! functions must be in the same network.

Using Wi-Fi GO!

To launch Wi-Fi GO!, click **Tool > Wi-Fi GO!** on the AI Suite II menu bar.



Wi-Fi GO! functions

- **DLNA Media Hub:** Provides support to the latest DLNA standard, and allows you to stream media files to a DLNA-supported device.
- **Remote Desktop:** Allows you to view your computer's desktop and remotely operate your computer in real-time from your mobile device.
- **Remote Keyboard and Mouse:** Allows you to use your mobile device's touch panel as a remote keyboard and mouse for your computer.
- **Smart Motion Control:** Allows you to remotely control your computer using your mobile device's customized motions.
- **File Transfer:** Allows you to transfer files between your computer and mobile device.
- **Capture and Send:** Allows you to take screenshots and send them to a mobile device.



Launch Wi-Fi GO! Remote on your mobile device to use Wi-Fi GO! Remote control functions. For more details, refer to next section **Wi-Fi GO! Remote**.

Wi-Fi GO! Remote

Install the Wi-Fi GO! Remote application on your mobile device to use Wi-Fi GO!'s remote control functions.



- Wi-Fi GO! supports iOS 3.2/Android 2.3 mobile devices or later versions.
- For iOS devices, download the Wi-Fi GO! Remote from iTunes store. For Android devices, download the Wi-Fi GO! Remote from Android Market or from ASUS support DVD.

Launching Wi-Fi GO! Remote

1. Turn on your mobile device's Wi-Fi connection. Ensure that your mobile device is within the same network as your computer.
2. On your mobile device, tap  and tap **Enter** on the Wi-Fi GO! Remote page.
3. Tap the computer you want to connect to your mobile device.

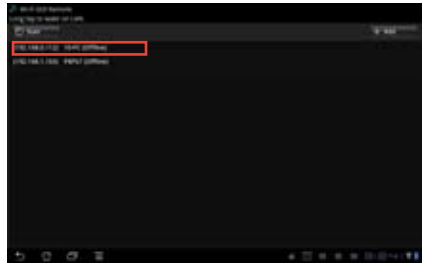

Ensure to enable the WAKE-ON-LAN function of your computer. Right-click **Computer > Manage > Device Manager > Network Adapters**, right-click the selected module card (Broadcom for P8Z77-V DELUXE and Atheros for P8Z77-V PRO/P8Z77-V), click **Properties > Power Management** and tick **Allow this device to wake the computer** and **Only allow a magic packet to wake the computer**.

Wi-Fi GO! Remote menu

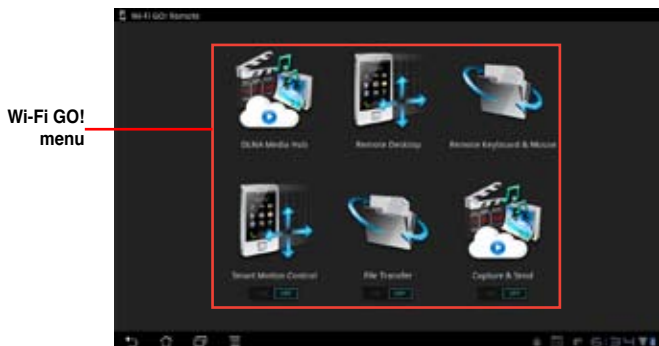

- Tap **ON** to enable **Smart Motion Control, File Transfer and Capture and Send**.
- The Wi-Fi GO! Remote's user interface shown above is for reference only and may vary with the mobile device's operating system.

Below are the supported screen resolution of your mobile devices:

Screen type	Low Density (120, ldpi)	Medium Density (160, mdpi)	High Density (240, hdpi)	Extra high density (320, xhdpi)
Screen Resolution	1024 x 600	WXGA (1280x800) 1024 x 768 1280 x 768	1536 x 1152 1920 x 1152 1920 x 1200	2048 x 1536 2560 x 1536 2560 x 1600

DLNA Media Hub

DLNA Media Hub allows you to stream your multimedia files to your DLNA-supported device and remotely control playback using your mobile device or your computer.

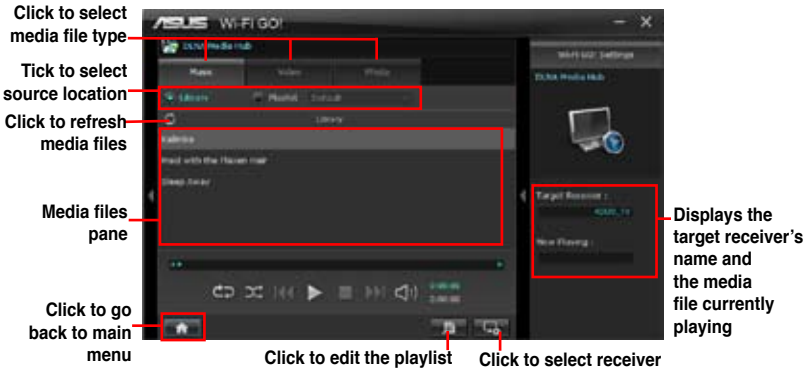

Using the DLNA Media Hub

- From the main screen, click **DLNA Media Hub**.
- Click  to select a device as your receiver.
 - When using your DLNA display (such as DLNA TV) as the receiver, ensure that DLNA function is enabled.
 - When using another computer as the receiver, launch **Windows Media Player**, click **Stream > Allow remote control of my Player** to remotely control media playback.



- When using the computer as sender and receiver, launch **Windows Media Player**, click **Stream > Allow remote control of my Player** and **Automatically allow devices to play my media**.

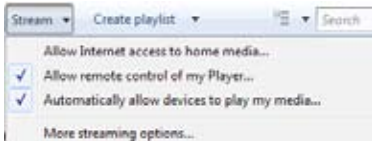

- Only computers under Windows® 7 support the DLNA Media Hub function.
- Keep the Windows Media Player open. Ensure that your media file formats supported on Windows Media Player and DLNA playback devices.

- Click any of the tabs to select your preferred media file type.

To play music:

1. Click **Music** tab.
2. Tick **Library** to view or play files.

Tick **Playlist** and select an existing playlist from the dropdown list.
3. Click a music file, and click 

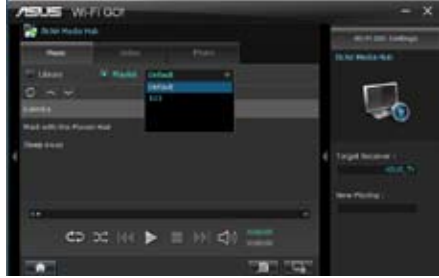



To edit the library:

1. Tick **Library**.
2. Click  to add or delete music files.
3. Click **Add** and locate the file from the directory. To delete, tick the selected file and click **Delete**.
4. Click **OK**.



To edit the music playlist:

1. Tick **Playlist**.
2. Click .
3. Tick to select or deselect the music file and click **Save Profile**.
4. Select the profile name and click **Save**. To add as a new playlist, key in your profile name and click **Save**.
5. To delete playlist, select the profile and click .



To play a video file:

1. Click **Video** tab.
2. Tick **Library** to view the video files from your local computer. Tick **Playlist** to view the video files saved in your profile.
3. Click the video file you want to watch, and click .
4. Change the resolution from the **Quality** dropdown list.

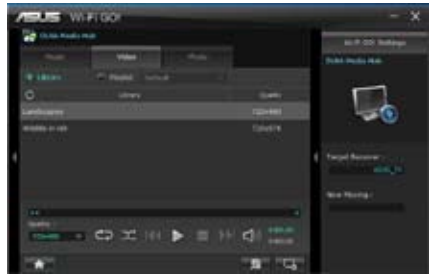

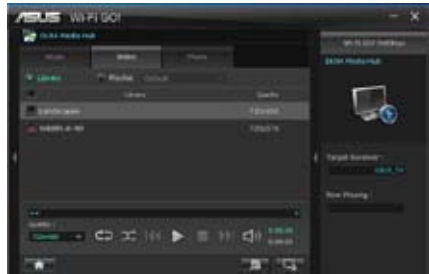

To edit the video library:

1. Tick **Library**.
2. Click  to add or delete video files.
3. Click **Add** and locate the file from the directory. To delete, tick the selected file and click **Delete**.
4. Click **OK**.



To edit the video playlist:

1. Tick **Playlist**.
2. Click .
3. Tick to select or deselect the video file and click **Save Profile**.
4. Select the profile name and click **Save**. To add as a new playlist, key in your profile name and click **Save**.
5. To delete playlist, select the profile and click .

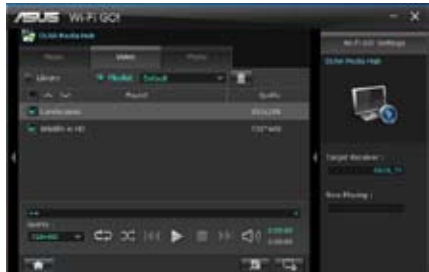

To view images:

1. Click **Photo** tab.
2. Tick **Library** to view the image files from your local computer. Tick **Playlist** to view the image files saved in your profile.

An image slideshow plays when pressing .





To edit the image library:

1. Tick **Library**.
2. Click  to add or delete image files.
3. Click **Add** and locate the file from the directory. To delete, tick the selected file and click **Delete**.
4. Click **OK**.



To edit the image playlist:

1. Tick **Playlist**.
2. Click .
3. Tick to select or deselect the image file and click **Save Profile**.
4. Select the profile name and click **Save**. To add as a new playlist, key in your profile name and click **Save**.
5. To delete playlist, select the profile and click .



Using the DLNA Media Hub via Wi-Fi GO! Remote

You can access the DLNA Media Hub on your mobile device via Wi-Fi GO! Remote.

1. Tap **DLNA Media Hub**.
2. Select and tap the receiver name.



3. Tap **Music, Video or Photo**, select a file and tap .



Your mobile device's Wi-Fi GO! interface may vary with the mobile device's operating system.

Remote Desktop

Remote Desktop allows you to view your computer's desktop and remotely operate your computer in real-time from your mobile device.

Using the Remote Desktop

1. From the main screen, click **Remote Desktop**.
2. Select a suitable codec **Auto**, **Image optimization**, or **Speed optimization** for your mobile device.
3. Click **Apply**.



Using the Remote Desktop via Wi-Fi GO! Remote

When the **Remote Desktop** is enabled, the mobile device shows the contents of your desktop.



The Wi-Fi GO! Remote's user interface shown above is for reference only and may vary with the mobile device's operating system.

Remote Keyboard and Mouse

Allows you to use your mobile device's touch panel as a remote keyboard and mouse for your computer.

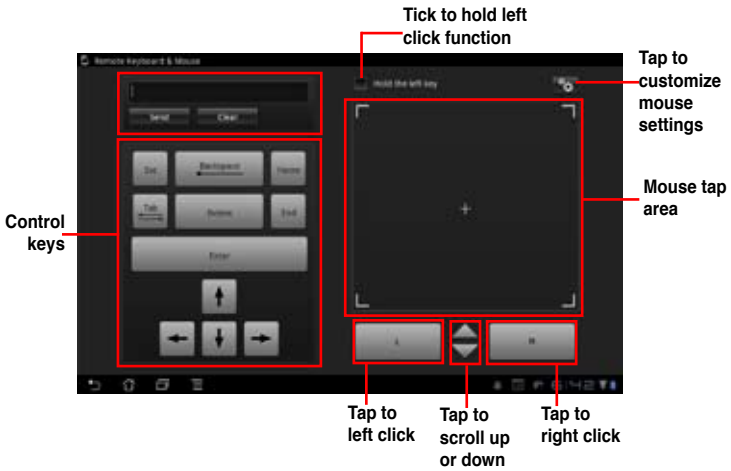

Mouse settings

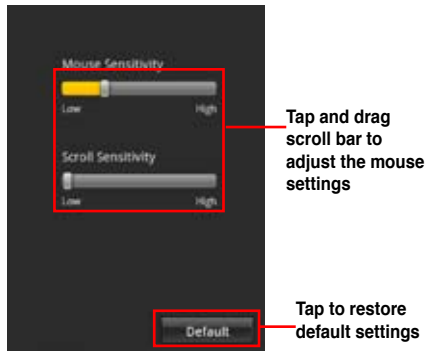

Smart Motion Control

Allows you to customize your motions in your computer to launch an application or function using your remote-enabled mobile device.



Before using Smart Motion Control, ensure that your computer is connected to your mobile device. For more details, refer to the section **Wi-Fi GO! Remote**.

Using the Smart Motion Control

1. Ensure to turn ON the **Smart Motion Control** in your mobile device.
2. In your computer, click **Smart Motion Control** in the main menu. Three function tabs provide you the three types of remote control modes namely **Movement**, **Proximity**, and **Camera**. Your computer instantly detects the connected mobile devices.
3. From the dropdown lists of the Action fields  in the **Movement** tab, select the function that you want to correspond with the action.
4. Click **Apply & Save** to save and apply the settings immediately. Click **Apply** to launch the settings without saving it.
5. Move your device corresponding to your specified function.
6. In the **Proximity** tab, select the function or application that will launch or run in your computer when your mobile device's touch panel is near or close to a stationary or moving object.
7. In the **Camera** tab, click  to take pictures, or click  to record a movie.

The files are automatically saved in the mobile device's SD card.



Your device must support a motion sensor function.



File Transfer

Allows you to transfer files wirelessly between your computer and mobile device.

Ensure to turn **ON** the File Transfer function in your mobile device.



Before using File Transfer, ensure that your computer is connected to your mobile device. For more details, refer to the section **Wi-Fi GO! Remote**.



- Android mobile devices can send and receive files.
- iOS mobile devices can only send files.

Using File Transfer

1. Right-click the file and click **Send to > [Device name]**.
2. After the transfer is complete, click **OK**.

Using File Transfer via Wi-Fi GO! Remote

When the **File Transfer** is enabled, the mobile device shows the files in your mobile device.

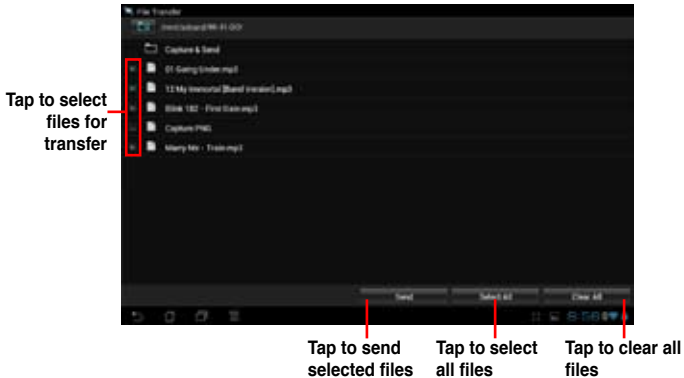

The Wi-Fi GO! Remote's user interface shown above is for reference only and may vary with the mobile device's operating system.

Capture & Send

Allows you to capture screenshots and send them wirelessly to other mobile devices.



Before using Capture and Send, ensure that your computer is connected to your mobile device. For more details, refer to the section **Wi-Fi GO! Remote**.



- This function only supports Android 2.3 and later versions.
- This function will be available on Wi-Fi GO! Remote 1.01.00 version.

Securing your computer for Wi-Fi GO! Remote functions

Wi-Fi GO! Settings allows you to create a password for your computer.

To create a password:

1. Click  in the main menu.
2. Tick **Use Password** and key in your password.
3. Click **Apply**.



- When you launch the Wi-Fi GO! Remote, the application prompts you to key in the computer's password.
- Your password must contain 6-12 letters or numbers.

4.3.11 USB Charger+

This utility allows you to fast-charge your portable USB devices even if your PC is off, in Sleep Mode, or Hibernate Mode.

Launching the USB Charger+

To launch this utility, open the **AI Suite II**, then click **Tool > USB Charger+**.



* The illustration above shows that no device connected to your PC for fast-charging.

USB fast-charging mode settings

Click the dropdown box, and select a proper charge mode when your PC is off, in Sleep Mode, or Hibernate Mode.

- **Disable:** disables the USB fast-charging function.
- **ASUS:** fast-charges your connected ASUS devices.
- **Apple:** fast-charges your connected Apple devices.
- **Kindle:** fast-charges your Kindle devices.
- **Others:** charges other portable USB devices.



The utility cannot detect the devices connected to your computer if the charging mode is enabled.



Setting up the charging function

When a portable device is connected to the USB port of the PC, the USB Charger+ automatically detects the kind of your device.

Charging the device

Click  to fast-charge your device.



Clicking the  stops the charging of your connected device, and rescans for other detected devices. Click the  to re-enable the fast-charging.

Disabling the charging function

Click  to stop charging your device.



4.3.12 USB BIOS Flashback Wizard

This utility allows you to check and save the latest BIOS version to a USB storage device. With ASUS USB BIOS Flashback hardware feature, the system BIOS is conveniently updated without booting your system.

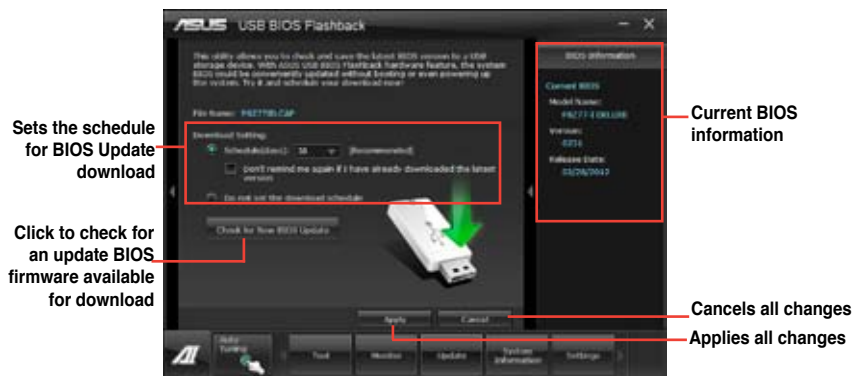

Scheduling the latest BIOS download

1. In the **Download Setting** field, tick **Schedule (days)** and select the number of days for the next download update available.
2. Click **Apply** to save the BIOS download schedule. Click **Cancel** to cancel the changes made.

Downloading the updated BIOS

Plug the flash drive before you start downloading.



1. Click **Check for New BIOS Update** to look for an updated BIOS firmware.
2. Wait for the system to check the latest BIOS firmware.

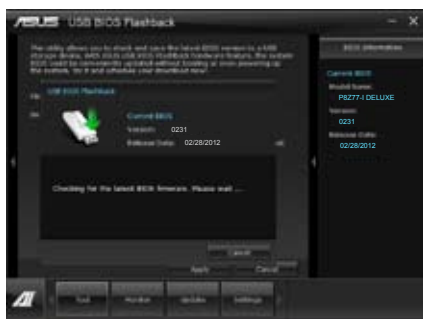

1. After the utility detects a new BIOS firmware, save the BIOS firmware by clicking  from the **Save to** field, select the USB flashdrive, and click **Download**.

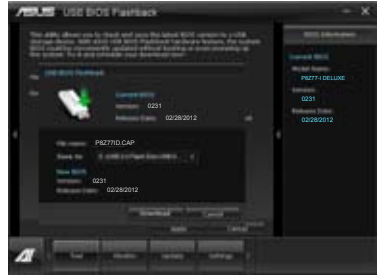

2. After the download is complete, click **OK**.

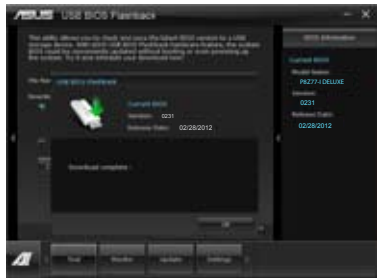

After you download the BIOS file to your flash drive, you can update the motherboard's BIOS. Refer to **2.3.10 USB BIOS Flashback** for details.

4.3.13 Network iControl

ASUS Network iControl, a one-stop setup network control center that gives you the EZ Start, Quick Connection, and EZ Profile functions, makes it easier for you to manage your network bandwidth. It also allows you to automatically connect to a PPPoE network for a more convenient online experience.

To launch Network iControl, click **Tool > Network iControl** from AI Suite II main menu bar.



- Ensure to install the LAN drivers before using this function.
- Network iControl is only supported under Windows 7 and can only support the onboard LAN.

Using EZ Start

EZ Start allows you to quickly activate Network iControl, and set the highest bandwidth priority for your top currently running program.

To use EZ Start:

1. Click the **EZ Start** tab.
2. Click **ON/OFF** to enable/disable Network iControl.



- By default, Network iControl is set to ON.
- When switched off, the **Quick Connection**, **EZ Profile** and **Info** are disabled.
- You may monitor the bandwidth priority from your desktop's taskbar.

3. Tick **Set current network program as the highest priority** to enable **User Profile**.
4. Select a profile and click **Apply**.



You may also apply your personal profile in **EZ Start**.

The screenshot shows the ASUS Network iControl application window. The interface includes several tabs: 'EZ Start', 'Quick Connection', 'EZ Profile', and 'Info'. The 'EZ Start' tab is active, showing a 'Turn ON Network iControl for a smoother on-line experience' message and a 'Network iControl' logo. Below this, there are 'ON' and 'OFF' buttons. A red box highlights the 'ON' button, with a label 'Select ON to activate Network iControl'. The 'User Profile' section has a checkbox labeled 'Set current network program as the highest priority' which is checked. A red box highlights this checkbox, with a label 'Tick to enable the network program as the highest priority'. Below the checkbox is a dropdown menu showing 'Auto'. A red box highlights the dropdown, with a label 'Click to select a profile'. To the right, there is a 'Network iControl Settings' panel with a list of programs and their bandwidth usage. A red box highlights this panel, with a label 'Displays the current network programs bandwidth'. At the bottom of the 'User Profile' section is an 'Apply' button, highlighted with a red box and labeled 'Click to apply the settings made'. The bottom of the window has a taskbar with buttons for 'AI Suite II', 'Tool', 'Monitor', 'Update', 'System Information', and 'Settings'.

Using Quick Connection

Configuring the PPPoE connection settings

Before enabling the Network iControl's **Quick Connection** functions, you must configure the PPPoE connection settings

To configure the PPPoE settings:

1. Right-click  in the taskbar, and select **Open Network and Sharing Center**.

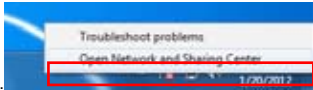

2. Right-click the PPPoE Connection, and select **Properties**.

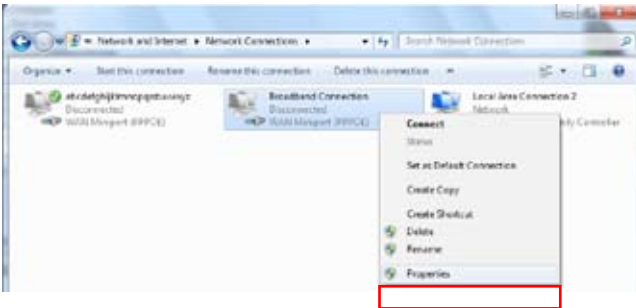

3. Click the **Options** tab, and deselect **Prompt for name and password, certificate, etc.** Click **OK** to complete the auto PPPoE connection settings.

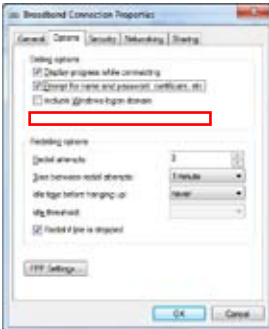

- You only need to configure the PPPoE connection settings once.
- Obtain the necessary information about your PPPoE connection from your network provider.



Configuring the Quick Connection

To configure the auto-PPPoE connection:

1. Click the **Quick Connection** tab.
2. Tick **Automatically connect online anytime** option, then select the connection name in the **Connection Name** dropdown box.
3. Click **Apply** to enable PPPoE automatic network connection.



You can also enable the **No Delay TCP** function to help improve the network performance.

Click to select Connection Name

Tick to set the auto PPPoE connection

Click to apply settings

Click ON to improve network performance

4.3.14 ASUS Update

ASUS Update lays out the options for updating BIOS on your system. Update BIOS utility on your system or simply save the utility for later use just by following the directions on this convenient updating feature.

Launching ASUS Update

After installing AI Suite II from the motherboard support DVD, launch ASUS Update by clicking **Update> ASUS Update** on the AI Suite II main menu bar.

Using ASUS Update

Select the way you would like to do with the BIOS utility. Click on **Next** and follow the instructions to complete your request.

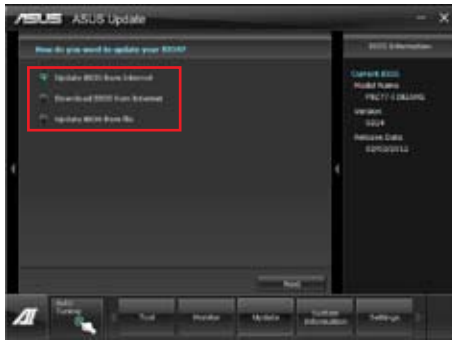

- **Update BIOS from Internet**
Download the latest BIOS utility from the ASUS service website (www.asus.com) and follow the suggested procedures to update the BIOS version on your system.
- **Download BIOS from Internet**
Download the latest BIOS utility from the ASUS service website (www.asus.com) and save for later use.
- **Update BIOS from file**
Use the BIOS utility demanded from a source file to update the BIOS version on your system.



There may be risks of system crash when updating BIOS. Backing up the original BIOS utility is recommended before updating.

4.3.15 MyLogo2

This MyLogo utility lets you customize the boot logo. The boot logo is the image that appears on screen during the Power-On-Self-Tests (POST). Personalize your computer from the very beginning!

Launching ASUS Update

After installing AI Suite II from the motherboard support DVD, launch MyLogo by clicking **Update> MyLogo** on the AI Suite II main menu bar.



Using MyLogo

Select the way you would like to do update your boot logo. Then click Next and follow the given instructions.

Change the BIOS boot logo of my motherboard

1. Under Current BIOS, click **Browse** and choose the desired image for your boot logo. Then click on Next.



2. Click on **Auto Tune** to adjust image size compatibility or adjust the resolution bar.
3. You can click on Booting Preview to preview the boot image. Then click Next.
4. Click on Flash to start updating the image to the boot logo.
5. Click on Yes to reboot or you can also see the new logo next time you restart your computer.



Change the boot logo of a downloaded BIOS file and update (or do not update) this BIOS to the motherboard

1. At BIOS File, **Browse** to download the requested BIOS file to your system. This utility will help you detect the compatibility of the BIOS version.
2. Then at Picture File, Browse to select the desired image for boot logo. Click Next.
3. Follow steps 2-5 in **Change the BIOS boot logo of my motherboard** to complete logo update.



The fullscreen logo application in BIOS utility must be enabled for MyLogo to take effect.

4.3.16 Audio configurations

The Realtek® audio CODEC provides 8-channel audio capability to deliver the ultimate audio experience on your computer. The software provides Jack-Sensing function, S/SPDIF Out support, and interrupt capability. The CODEC also includes the Realtek® proprietary UAJ® (Universal Audio Jack) technology for all audio ports, eliminating cable connection errors, and giving users plug and play convenience.

Follow the installation wizard to install the Realtek® Audio Driver from the support DVD that came with the motherboard package.

If the Realtek audio software is correctly installed, you will find the **Realtek HD Audio Manager** icon on the taskbar. Double-click on the icon to display the Realtek HD Audio Manager.



Realtek HD Audio Manager

A. Realtek HD Audio Manager with DTS UltraPC II for Windows® 7™

Configuration option tabs (vary with the audio devices connected)



B. Realtek HD Audio Manager for Windows XP



- Refer to the software manual in the support DVD or visit the ASUS website at www.asus.com for detailed software configuration.
- Due to Intel® Z77 platform does not support Windows® Vista™, Realtek HD Audio driver is only supported by Windows® 7™/Windows® XP™.
- To play Blu-Ray disc, make sure to use an HDCP compliant monitor.

4.4 Introduction to Intel® 2012 Desktop responsiveness technologies

This document details the overview of the installation and configuration procedures of the Intel® 2012 Desktop responsiveness technologies.

Intel® 2012 Desktop responsiveness technologies feature the three technologies:

- Intel® Smart Response Technology
- Intel® Rapid Start Technology
- Intel® Smart Connect Technology

4.4.1 System Requirements for Intel® 2012 Desktop responsiveness technologies

In order for the system to run smoothly for the Intel® 2012 Desktop responsiveness, you must meet the following requirements:

1. CPU: Intel® 3rd/2nd generation Core Processor family
2. OS: Windows® 7 operating systems
3. SSD: One dedicated SSD (Solid State Disk) to support Intel® Smart Response and Intel® Rapid Start Technology is necessary.



Refer to the **SSD Capacity Requirements** table for the information of SSD size, partition capacity, and system memory requirements.

4. HDD: At least one HDD (Hard Disk Drive) for the system OS drive.
5. DRAM: To enable Intel® Rapid Start Technology, DRAM size smaller than 8GB is required.



Ensure to enable the acceleration of Intel® Smart Response Technology before creating the partition for the Intel® Rapid Start Technology.

SSD Capacity Requirements

SSD Partition Capacity Requirements		System DRAM		
		2GB	4GB	8GB
Intel® storage combinations	Intel® Rapid Start	2GB	4GB	8GB
	Intel® Smart Response	20GB	20GB	20GB
	Intel® Smart Response and Intel® Rapid Start	Separate 20GB and 2GB partition (SSD size > 22GB)	Separate 20GB and 4GB partition (SSD size > 24GB)	Separate 20GB and 8GB partition (SSD size > 28GB)
	Intel® Smart Response, Intel® Rapid Start, and Intel® Smart Connect	Separate 20GB and 2GB partition (SSD size > 22GB)	Separate 20GB and 4GB partition (SSD size > 24GB)	Separate 20GB and 8GB partition (SSD size > 28GB)



- The SSD used for Intel® Rapid Start and Intel® Smart Response is not allowed for creating RAID.
- Due to OS behavior, Intel® Rapid Start Technology works inefficiently with over 4GB system memory under Windows® 7 32-bit operating system.
- Only Intel® internal SATA ports (gray and blue) support Intel® 2012 Desktop responsiveness technologies.
- The performance of Intel® Smart Response Technology and Intel® Rapid Storage Technology vary by the installed SSD.

4.4.2 Intel® Smart Response Technology

Intel® Smart Response Technology boosts overall system performance. It uses an installed fast SSD (min. 20GB available) as a cache for frequently accessed operations, speeding up hard drive/main memory interaction. Key benefits are expedited hard drive speeds, reduced load and wait times, and maximized storage utilization. Power consumption also goes down by reducing unnecessary hard drive spin.



Before applying Intel® Smart Response Technology, setting the SATA Mode BIOS item to [RAID mode] in BIOS setup is necessary. Refer to section 3.5.3 **SATA Configuration** for details

Installing Intel® Smart Response Technology

1. Place the support DVD to the optical drive. The Drivers installation tab appears if your computer has enabled the Autorun feature.
2. Click the **Drivers** tab, then click **Intel® Rapid Storage Technology Driver** software.
3. Follow the onscreen instructions to complete the installation.

Using the Intel® Smart Response Technology

1. Click **Accelerate** to launch Smart Response Technology settings.



2.
 - a. Select the SSD you want to use to accelerate your storage system.
 - b. Select the size allocated for SSD caching.
 - c. Select which HDD for caching.
 - d. **Enhanced mode:** WRITE THROUGH, write to SSD and HDD at the same time.
Maximized mode: WRITE BACK, write to SSD and write back to HDD in a later time.

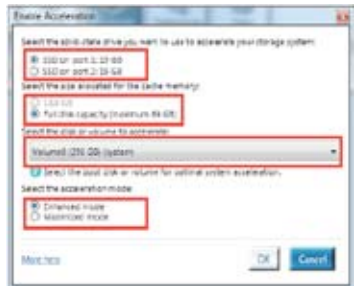

3. Select **Disable Acceleration** to disable this function, and select **Change Mode** to switch acceleration mode to Enhanced/Maximized.



- To enable Intel® Smart Response Technology, you need at least one SSD ($\geq 20\text{GB}$) and a HDD, and only one SSD can be assigned for caching.
- If you want to restore the OS, go to **BIOS Option ROM > Acceleration Options** and remove the **Disks/Volume Acceleration** to disable Intel® Smart Response Technology. Refer to Chapter 4, section Installing Serial ATA hard disk for the entry of BIOS Option ROM.
- The maximum caching size on the SSD is 64GB. If it exceeds, the storage capacity left out for caching can still be identified by the system for normal storage.

4.4.3 Intel® Rapid Start Technology

Intel® Rapid Start Technology allows you to quickly resume your computer from sleeping mode. Saving your computer's system memory to the configured SSD provides a faster wake-up response time, but keeps the energy in a low profile.



- Before applying Intel® Rapid Start Technology, go to **Advanced Mode > Advanced > PCH Configuration** in BIOS item, and enable Intel® Rapid Start Technology.
- Ensure to follow the procedure **Creating a partition** precisely to enable the Intel Rapid Start function. Error message appears if you install the Intel® Rapid Start Utility before creating a partition.

Creating a partition



- Ensure to backup your data before using the Microsoft partition tool. Incorrect partitioning process will result to data loss.
 - Adjusting the DRAM to a high frequency will result to unstable system performance.
1. Go to Start, right-click **Computer > Manage > Disk Management**.
 2. Select the SSD that you want to create the partition.

- Right click the **New Volume** that you want to shrink from, and select **Shrink Volume**.

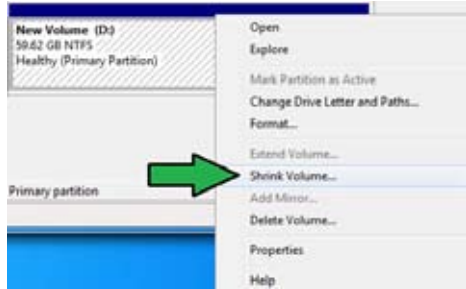

- If your SSD is not initialized and unformatted:
 - Right click the disk that you want to create the partition, and select **Initialize**.
 - Right click the unallocated volume, select **New Simple Volume**, and follow the remaining steps.



If your SSD is smaller than 64GB, and is set to **Full disk capacity** caching option for Intel® Smart Response, you can not see any volume in the Disk Management. Ensure to set your cache memory value of **18.6GB** in Intel® Smart Response to allow enough capacity for the Intel® Rapid Start partition.

- Key in the required partition size, and must be equal to the system DRAM memory (1GB = 1024MB). Click **Shrink**.

Go to **Start > Control Panel > System and Security > System**, and check the DRAM size information.

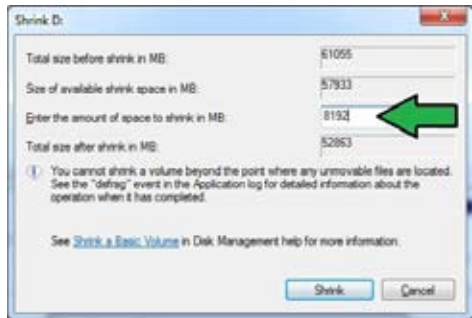

The unallocated volume is allocated to the selected disk.

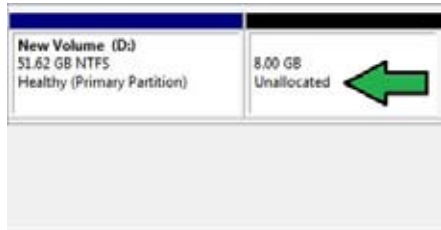

6. To launch the disk partitioning tool, click **Start > Programs > Accessories > Command Prompt** tool.
7. Type **diskpart** and press **Enter**.
8. In the diskpart prompt, type **list disk** after DISKPART, and press **Enter**. Select the disk with the unallocated volume by typing **select disk x** (x = disk number), and press **Enter**.

```
DISKPART> list disk

Disk ###  Status         Size      Free      Dyn  Gpt
-----  -
Disk 0    Online         2794 GB   1824 KB   *
Disk 1    Online         59 GB     8 GB

DISKPART> select disk 1

Disk 1 is now the selected disk.
```



- The value "x" refers to a disk number where you created the unallocated partition.
- Refer to step 5 for details about the unallocated disk space in the SSD.

9. Type **create partition primary**, and press **Enter**.

```
DISKPART> create partition primary

DiskPart succeeded in creating the specified partition.

DISKPART>
```

10. After creating a primary partition, type **detail disk**, and press **Enter** to view the details of the partitioned disk.

```
DISKPART> detail disk

Disk ###  Group Name          Partition Name      Size      Status      Info
-----  -
Disk 1    New Volume          Intel(R) Rapid Start Partition  51 GB     Healthy
Disk 2    New Volume          Intel(R) Rapid Start Partition  8 GB      Healthy
```

11. Select the RAW volume which has the same size as the shrunk volume, type **select volume x** (x = number), and press **Enter** to store the Intel® Rapid Start partition.

```
DISKPART> select volume 3

Volume 3 is the selected volume.

DISKPART>
```



- The value "x" refers to a disk number where you want to create the store partition.

12. Type `set id=84 override`, press **Enter**, and wait for the “shrinking process” until the Disk Management utility identifies a new partition called **Hibernation Partition**.

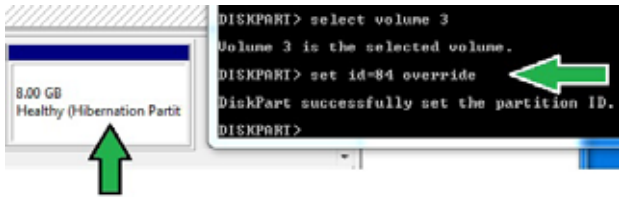

The **Hibernation Partition** does not appear when you choose “GPT (GUID Partition Table store type)”. Ensure the “Unallocated” disappears from the volume, and a new partition is identified.

13. Reboot the system after creating the partition.



The partition for Intel® Rapid Start Technology is incomplete if the computer is not rebooted, and this results to function failure of Intel® Rapid Start Technology.

Enabling and disabling the Intel® Rapid Start Technology under the OS



Install the Intel® Rapid Start Technology first from your support DVD in order to launch the Intel® Rapid Start Manager.

After creating the partition, launch the Intel® Rapid Start Manager to enable or disable the Intel® Rapid Start Technology.

1. Click the **Show hidden icons** arrow from the right side of the task bar, and click **Intel® Rapid Start Technology Manager** icon.

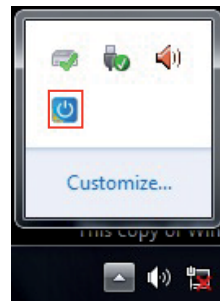

2. Tick **On** in the Status field to enable the function, and click **Save**.

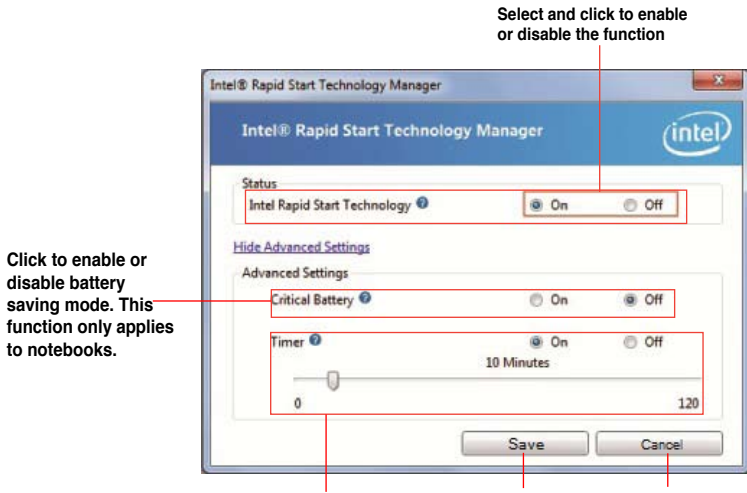

Select and click to enable or disable the function

Click to enable or disable battery saving mode. This function only applies to notebooks.

Click to enable or disable the timer. When enabled, move the scroll bar to the desired time. When the system is idle for more than the time period you set, the system automatically goes into the Intel® Rapid Start mode. Default time is 10 minutes.

Click to save the settings made. Click to cancel the settings made.

Recovering the partition

This procedure allows you to delete the Intel® Rapid Start Technology from your system, and recover the partition you made for the Intel Rapid® Start Technology installation.

1. Run the **Command Prompt** tool.
2. Type `diskpart` and press **Enter**.
3. At the diskpart prompt, type `list disk` after DISKPART, and press **Enter**.

```
DISKPART> list disk
Disk ###  Status         Size         Free         Dgn  Cpt
-----  -
Disk 0    Online         2794 GB     1824 KB     *
Disk 1    Online         59 GB       0 B
```

4. Select the disk (SSD) where the Intel® Rapid Start Technology is installed for volume recovery, type `select disk x` (x = number), and press **Enter**.

```
DISKPART> select disk 1
Disk 1 is now the selected disk.
DISKPART> _
```



The value “x” refers to a disk number where you want to delete the store partition.

- Type `list partition`, press **Enter**, and select the partition where the Intel® Rapid Start Technology is installed by typing `select partition x` (x = number), and press **Enter**.

```
DISKPART> list partition

Partition ###  Type              Size      Offset
-----
Partition 1    Primary           51 GB     1824 KB
Partition 2    OEM                8 GB      51 GB

DISKPART> select partition 2
Partition 2 is now the selected partition.
DISKPART>
```



The value "x" refers to a disk number where you want to delete the store partition.

- Type `delete partition override`, and press **Enter**. The diskpart utility deletes the selected partition.

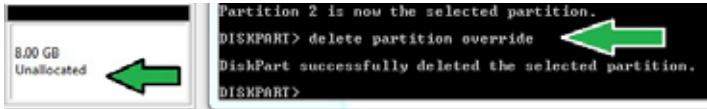

- In the desktop, click **Start**, right-click **Computer**, and click **Manage**.
- In the Computer Management window, click **Disk Management**, right click the shrunk new volume, and select **Extend Volume**.

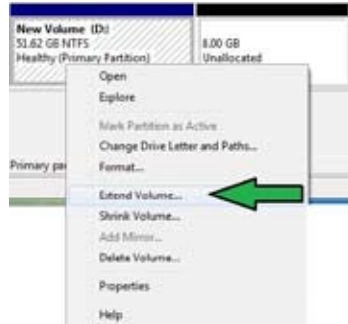

- As the Extend Volume Wizard appears, click **Next**.



- Click **Next** after selecting the default selected disk.

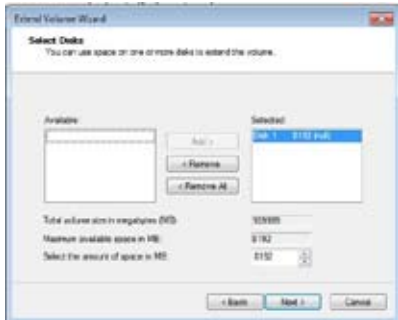

- Extend volume setup is completed. Click **Finish** to recover the Intel® Rapid Start Technology partition.
- Reboot the system after deleting the partition.
- Go to **Start > Control Panel > Programs > Programs and Features >** to remove the Intel® Rapid Start Manager for the complete deletion of Intel® Rapid Start Technology.

4.4.4 Intel® Smart Connect Technology

The Intel® Smart Connect Technology is a feature that provides the latest content updates and energy efficiency to your computer's platform.

Once installed and activated, the Intel® Smart Connect Technology periodically wakes up the system from sleeping mode, performs user state gathering, and initiates re-entry to sleeping mode to wake-up after a set time interval.



- Intel® Smart Connect Technology supports Windows® Live Mail, Microsoft Outlook, and Seismic applications.
- It is necessary to enable the items of the PCH Configuration in the BIOS before applying the Intel® Smart Connect Technology. Go to **Advanced Mode > Advanced > PCH Configuration**, and enable the Intel® Smart Connect Technology.

Installing the Intel® Smart Connect Technology

- Place the support DVD to the optical drive.
- Go to **Utilities**, and click **Intel® Smart Connect Technology**.
- As the setup wizard appears, click **Next** to begin the setup.
- Tick **I accept the terms in the License Agreement**, and click **Next**.

5. Select all and click **Next** for **Custom Setup**.



6. Click **Install** to proceed the installation.
7. Click **Yes** to restart your system, and for the newly installed Intel® Smart Connect Technology to take effect.

Using the Intel® Smart Connect Technology



- Before the system goes to sleep mode, ensure to keep your applications on the desktop, and enter the applications, passwords.
- Ensure that the internet is in connection when enabling the Intel® Smart Connect Technology.

1. Click **Start > All Programs > Intel > Intel® Smart Connect Technology**.
2. In the **Basic** tab, click **Enable Updating**. When enabled, the **Advanced** tab is available for advanced function settings.

The Advanced tab is activated when updating is enabled

Click to view version information and help topics

Click to configure the basic settings

Click to enable or disable the function

When updating is enabled, click to reset all settings to default.

When the scroll bar is activated, adjust the waking up time period for Internet data update.

- To disable the updating function, click **Disable Updating**. Clicking this button automatically disables the configuration in the **Advanced** tab. To reset to defaults, click **Reset All to Defaults**.

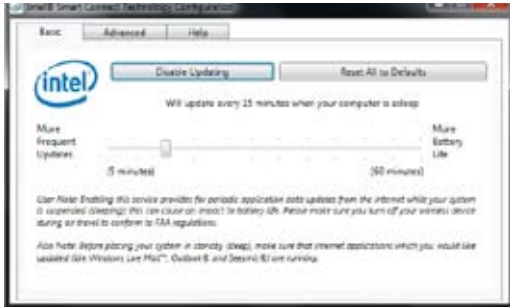

- In the **Advanced** tab, set up the schedule during low power usage time period for power saving. This setting only applies to the assigned time period.



- In the **Help** tab, click **About** to view the feature's version. Click **Topics** to learn more about the Intel® Smart Connect Technology and its configuration.

4.5 RAID configurations

The motherboard supports the following SATA RAID solutions:

- **Intel® Rapid Storage Technology** with RAID 0, RAID 1, RAID 10 and RAID 5 support.



- You must install Windows® XP Service Pack 3 or later versions before using Serial ATA hard disk drives. The Serial ATA RAID feature is available only if you are using Windows® XP SP3 or later versions.
- Due to Windows® XP / Vista limitation, a RAID array with the total capacity over 2TB cannot be set as a boot disk. A RAID array over 2TB can only be set as a data disk only.
- If you want to install a Windows® operating system to a hard disk drive included in a RAID set, you have to create a RAID driver disk and load the RAID driver during OS installation. Refer to section **4.6 Creating a RAID driver disk** for details.

4.5.1 RAID definitions

RAID 0 (Data striping) optimizes two identical hard disk drives to read and write data in parallel, interleaved stacks. Two hard disks perform the same work as a single drive but at a sustained data transfer rate, double that of a single disk alone, thus improving data access and storage. Use of two new identical hard disk drives is required for this setup.

RAID 1 (Data mirroring) copies and maintains an identical image of data from one drive to a second drive. If one drive fails, the disk array management software directs all applications to the surviving drive as it contains a complete copy of the data in the other drive. This RAID configuration provides data protection and increases fault tolerance to the entire system. Use two new drives or use an existing drive and a new drive for this setup. The new drive must be of the same size or larger than the existing drive.

RAID 5 stripes both data and parity information across three or more hard disk drives. Among the advantages of RAID 5 configuration include better HDD performance, fault tolerance, and higher storage capacity. The RAID 5 configuration is best suited for transaction processing, relational database applications, enterprise resource planning, and other business systems. Use a minimum of three identical hard disk drives for this setup.

RAID 10 is data striping and data mirroring combined without parity (redundancy data) having to be calculated and written. With the RAID 10 configuration you get all the benefits of both RAID 0 and RAID 1 configurations. Use four new hard disk drives or use an existing drive and three new drives for this setup.

4.5.2 Installing Serial ATA hard disks

The motherboard supports Serial ATA hard disk drives. For optimal performance, install identical drives of the same model and capacity when creating a disk array.

To install the SATA hard disks for a RAID configuration:

1. Install the SATA hard disks into the drive bays.
2. Connect the SATA signal cables.
3. Connect a SATA power cable to the power connector on each drive.

4.5.3 Setting the RAID item in BIOS

You must enable the RAID function in the BIOS Setup before creating RAID set(s) using SATA HDDs. To do this:

1. Enter the BIOS Setup during POST.
2. Go to the **Advanced** menu > **SATA Configuration**, and then press <Enter>.
3. Set the **SATA Mode** item to [RAID Mode].
4. Save your changes, and then exit the BIOS Setup.



Refer to Chapter 3 for details on entering and navigating through the BIOS Setup.



Due to chipset limitation, when set any of SATA ports to RAID mode, all SATA ports run at RAID mode together.

4.5.4 Intel® Rapid Storage Technology Option ROM utility

To enter the Intel® Rapid Storage Technology Option ROM utility:

1. Turn on the system.
2. During POST, press <Ctrl> + <I> to display the utility main menu.

```
Intel(R) Rapid Storage Technology - Option ROM - v10.5.1.1070
Copyright(C) 2003-10 Intel Corporation. All Rights Reserved.

[ MAIN MENU ]
1. Create RAID Volume
2. Delete RAID Volume
3. Reset Disks to Non-RAID
4. Recovery Volume Options
5. Acceleration Options
6. Exit

[ DISK/VOLUME INFORMATION ]

RAID Volumes:
None defined.

Physical Devices:
Port Device Model Serial # Size Type/Status (Vol ID)
0 ST3160812AS 9LS0HJA4 149.0GB Non-RAID Disk
1 ST3160812AS 9LS0F4HL 149.0GB Non-RAID Disk
2 ST3160812AS 3LS0JYL8 149.0GB Non-RAID Disk
3 ST3160812AS 9LS0B75H 149.0GB Non-RAID Disk

[↑↓]-Select [ESC]-Exit [ENTER]-Select Menu
```

The navigation keys at the bottom of the screen allow you to move through the menus and select the menu options.



The RAID BIOS setup screens shown in this section are for reference only and may not exactly match the items on your screen.



The utility supports maximum four hard disk drives for RAID configuration.

Creating a RAID set

To create a RAID set:

1. From the utility main menu, select **1. Create RAID Volume** and press <Enter>. The following screen appears:

```
Intel(R) Rapid Storage Technology - Option ROM - v10.5.1.1070
Copyright(C) 2003-10 Intel Corporation. All Rights Reserved.

-----[ CREATE VOLUME MENU ]-----
Name: Volume0
RAID Level: RAID0(Stripe)
Disks: Select Disks
Strip Size: 128KB
Capacity: 0.0 GB
Sync: N/A
Create Volume

-----[ HELP ]-----

Enter a unique volume name that has no special characters and is
16 characters or less.

[↑↓]-Change [TAB]-Next [ESC]-Previous Menu [ENTER]-Select
```

2. Enter a name for the RAID set and press <Enter>.
3. When the **RAID Level** item is selected, press the up/down arrow key to select a RAID level to create, and then press <Enter>.
4. When the **Disks** item is selected, press <Enter> to select the hard disk drives you want to include in the RAID set. The **SELECT DISKS** screen appears:

```
-----[ SELECT DISKS ]-----
Port Drive Model Serial # Size Status
0 SWELL003P2AS 9LS0BJ4Y 149.0GB Non-RAID Disk
1 ST3160812AS 9LS0F4HL 149.0GB Non-RAID Disk
2 ST3160812AS 3LS0JYL8 149.0GB Non-RAID Disk
3 ST3160812AS 9LS0BJ5H 149.0GB Non-RAID Disk

Select 2 to 6 disks to use in creating the volume.

[↑↓]-Prev/Next [SPACE]-SelectDisk [ENTER]-Done
```

5. Use the up/down arrow key to select a drive, and then press <Space> to select. A small triangle marks the selected drive. Press <Enter> after completing your selection.
6. Use the up/down arrow key to select the stripe size for the RAID array (for RAID 0, 10 and 5 only), and then press <Enter>. The available stripe size values range from 4KB to 128KB. The following are typical values:
RAID 0: 128KB
RAID 10: 64KB
RAID 5: 64KB



We recommend a lower stripe size for server systems, and a higher stripe size for multimedia computer systems used mainly for audio and video editing.

7. When the **Capacity** item is selected, enter the RAID volume capacity that you want and press <Enter>. The default value indicates the maximum allowed capacity.
8. When the **Create Volume** item is selected, press <Enter>. The following warning message appears:



9. Press <Y> to create the RAID volume and return to the main menu, or <N> to go back to the **CREATE VOLUME** menu.

Deleting a RAID set



Take caution when deleting a RAID set. You will lose all data on the hard disk drives when you delete a RAID set.

To delete a RAID set:

1. From the utility main menu, select **2. Delete RAID Volume** and press <Enter>. The following screen appears:

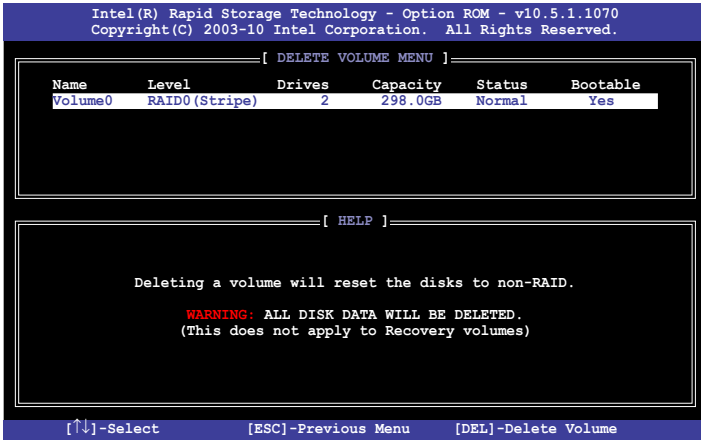

2. Use the up/down arrow key to select the RAID set you want to delete, and then press . The following warning message appears:

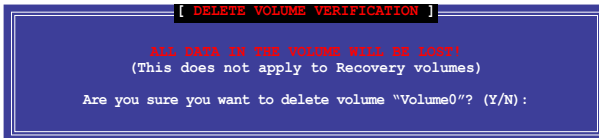

3. Press <Y> to delete the RAID set and return to the utility main menu, or press <N> to return to the **DELETE VOLUME** menu.

Exiting the Intel® Rapid Storage Technology Option ROM utility

To exit the utility:

1. From the utility main menu, select **5. Exit**, and then press <Enter>. The following warning message appears:

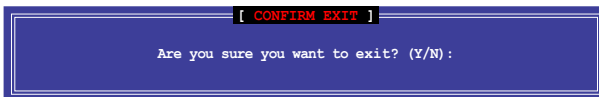

2. Press <Y> to exit or press <N> to return to the utility main menu.

4.6 Creating a RAID driver disk

A floppy disk with the RAID driver is required when installing a Windows® operating system on a hard disk drive that is included in a RAID set.



- **The motherboard does not provide a floppy drive connector.** You have to use a USB floppy disk drive when creating a **SATA RAID driver disk**.
- Windows® XP may not recognize the USB floppy disk drive due to Windows® XP limitation. To work around this OS limitation, refer to section **4.5.4 Using a USB floppy disk drive**.

4.6.1 Creating a RAID driver disk without entering the OS

To create a RAID driver disk without entering the OS:

1. Boot your computer.
2. Press during POST to enter the BIOS setup utility.
3. Set the optical drive as the primary boot device.
4. Insert the support DVD into the optical drive.
5. Save changes and exit BIOS.
6. When the **Make Disk** menu appears, press <1> to create a RAID driver disk.
7. Insert a formatted floppy disk into the USB floppy disk drive, then press <Enter>.
8. Follow the succeeding screen instructions to complete the process.

4.6.2 Creating a RAID driver disk in Windows®

To create a RAID driver disk in Windows®:

1. Start Windows®.
2. Plug the USB floppy disk drive and insert a floppy disk.
3. Place the motherboard support DVD into the optical drive.
4. Go to the **Make Disk** menu, and then click **Intel AHCI/RAID Driver Disk** to create a RAID driver disk.
5. Select USB floppy disk drive as the destination disk.
6. Follow the succeeding screen instructions to complete the process.



Write-protect the floppy disk to avoid a computer virus infection.

4.6.3 Installing the RAID driver during Windows® OS installation

To install the RAID driver in Windows® XP:

1. During the OS installation, the system prompts you to press the F6 key to install third-party SCSI or RAID driver.
2. Press <F6>, and then insert the floppy disk with RAID driver into the USB floppy disk drive.
3. When prompted to select the SCSI adapter to install, select the RAID driver for the corresponding OS version.
4. Follow the succeeding screen instructions to complete the installation.

To install the RAID driver for Windows® Vista or later OS:

1. During the OS installation, click **Load Driver** to allow you to select the installation media containing the RAID driver.
2. Insert the USB flash drive with RAID driver into the USB port or the support DVD into the optical drive, and then click **Browse**.
3. Click the name of the device you've inserted, go to **Drivers > RAID**, and then select the RAID driver for the corresponding OS version. Click **OK**.
4. Follow the succeeding screen instructions to complete the installation.



Before loading the RAID driver from a USB flash drive, you have to use another computer to copy the RAID driver from the support DVD to the USB flash drive.

4.6.4 Using a USB floppy disk drive

Due to OS limitation, Windows® XP cannot recognize the USB floppy disk drive when you install the RAID driver from a floppy disk during the OS installation.

To solve this issue, add the USB floppy disk drive's Vendor ID (VID) and Product ID (PID) to the floppy disk containing the RAID driver. Refer to the steps below:

1. Using another computer, plug the USB floppy disk drive, and insert the floppy disk containing the RAID driver.
2. Right-click **My Computer** on the Windows® desktop or **start** menu, and then select **Manage** from the pop-up window.

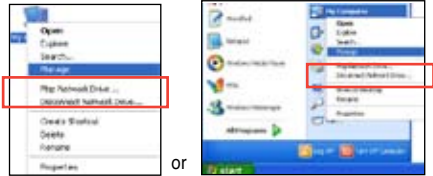

3. Select **Device Manager**. From the **Universal Serial Bus controllers**, right-click **xxxxxx USB Floppy**, and then select **Properties** from the pop-up window.



The name of the USB floppy disk drive varies with different vendors.

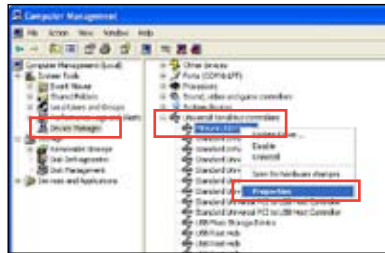

4. Click **Details** tab. The Vendor ID (VID) and Product ID (PID) are displayed.

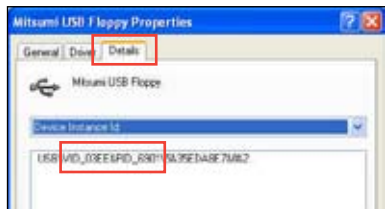

5. Browse the contents of the RAID driver disk to locate the file **txtsetup.oem**.
6. Double-click the file. A window appears, allowing you to select the program for opening the oem file.

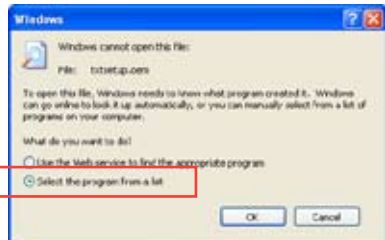

7. Use Notepad to open the file.



8. Find the [HardwareIds.scsi.iaAHCI_DesktopWorkstationServer] and [HardwareIds.scsi.iaStor_DesktopWorkstationServer] sections in the `txtsetup.oem` file.
9. Type the following line to the bottom of the two sections:
`id = "USB\VID_03EE&PID_6901", "usbstor"`

```
[HardwareIds.scsi.iaAHCI_DesktopWorkstationServer]
id= "PCI\VEN_8086&DEV_1C02&CC_0106", "iaStor"
id= "USB\VID_03EE&PID_6901", "usbstor"

[HardwareIds.scsi.iaStor_DesktopWorkstationServer]
id= "PCI\VEN_8086&DEV_2822&CC_0104", "iaStor"
id= "USB\VID_03EE&PID_6901", "usbstor"
```



Add the same line to both sections.



The VID and PID vary with different vendors.

10. Save and exit the file.

5.1 LucidLogix Virtu MVP

LucidLogix Virtu MVP allows your computer's VGA output and discrete graphic cards to perform better, respond faster and process media files smoother within a low power environment. Its GPU virtualization assigns tasks to the best available graphic source while the newly-designed Virtual Vsync gives you a smoother gaming experience.



-
- LucidLogix Virtu MVP supports Windows 7® operating systems.
 - Intel® Quick Sync Video feature is supported by the 3rd/2nd generation Intel® Core™ processor family.
 - iGPU Multi-Monitor support option must be enabled in BIOS and install both Intel® Graphics Accelerator, and graphics card driver before installing LucidLogix Virtu MVP from ASUS support DVD. Refer to **3.5.4 System Configuration** for details.
 - Hyperformance® and Virtual Sync are enabled when using more than one discrete GPU at the same time.
 - Supports NVIDIA® GF4xx/5xx series and AMD® HD5xxx/6xxx series graphic cards.
 - We do not recommended to use LucidLogix Virtu MVP under RAID mode.
-

Installing LucidLogix Virtu MVP

To install LucidLogix Virtu MVP:

1. Insert the support DVD in the optical drive. The **ASUS Support Wizard** appears if your computer has enabled the Autorun feature.
2. Click the **Utilites** tab, then click **LucidLogix Virtu MVP Software**.
3. Follow the succeeding onscreen instructions to complete the installation.



After you successfully installed the LucidLogix Virtu MVP, the LucidLogix Virtu MVP icon appears in the notification area.

Setting up your display

LucidLogix Virtu MVP solution comes with two distinct modes that allows you to enjoy better graphics either from your built-in video output (i-Mode) or from a discrete graphics card (d-Mode).

i-Mode

To use LucidLogix Virtu MVP in i-Mode, the display must be connected to the onboard video output.



Ensure to set the Primary Display to iGPU in BIOS to activate i-Mode support.

d-Mode

To use LucidLogix Virtu MVP in d-Mode, the display must be connected to the installed graphics card.



- Ensure to set the Primary Display to PCIE or PCIE/PCI in BIOS to enable d-Mode support.
 - d-Mode is recommended for an enhanced 3D gaming performance.
-

i-Mode (VGA output from motherboard)

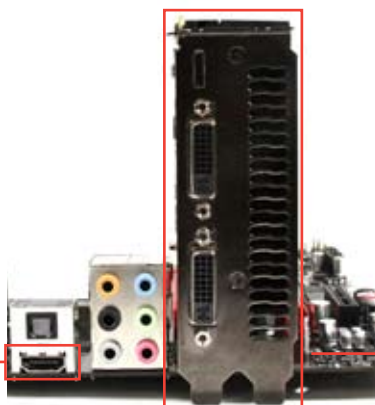

d-Mode (VGA output from discrete graphics card)



The motherboard's IO ports and discrete graphic card is for reference only and may vary in different models.

Configuring LucidLogix Virtu MVP

Launch the Virtu MVP Control Panel to allow you to configure the main features, adjust the performance settings and select applications for graphical virtualization.

To open the control panel, right-click LucidLogix Virtu MVP icon in the notification area and select **Open Virtu MVP Control Panel**.

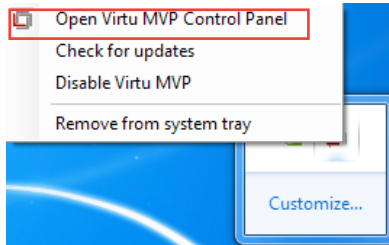

LucidLogix Virtu MVP is automatically activated when your system is powered on. Select **Remove from system tray** if you want to remove LucidLogix Virtu MVP icon from the notification area.

Main

Allows you to turn ON/OFF the GPU virtualization. Also from the Main tab, you can set to show or hide the In-Game icon.



Performance

Allows you to turn ON/OFF the Hyperformance® or Virtual Vsync function.

Click to turn
Hyperformance®
ON or OFF

Click to turn
Virtual Vsync
ON or OFF

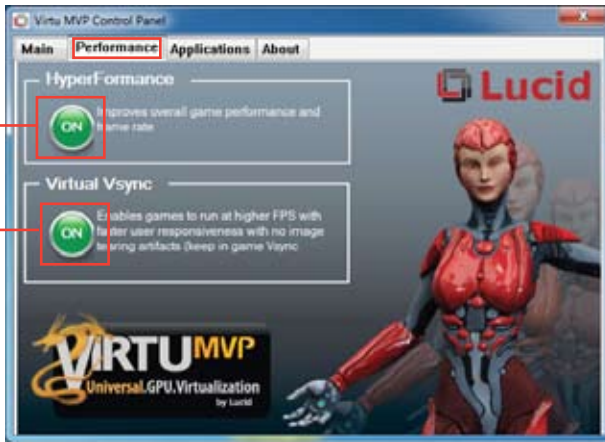

Applications

Allows you to select applications for graphic virtualization.

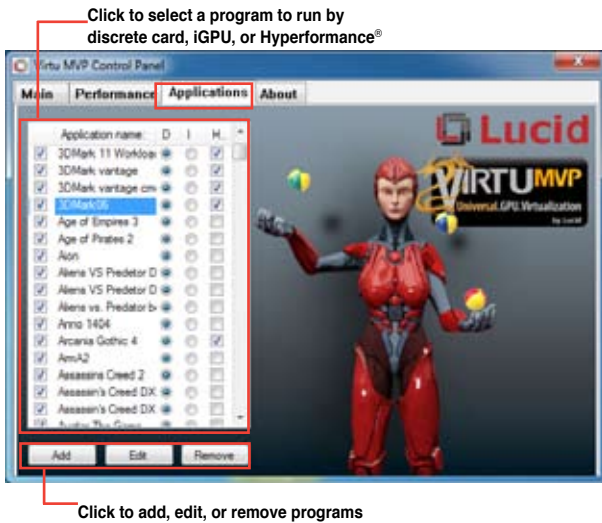

See the descriptions of these columns below:

- **D** column allows you to run applications with the discrete graphic card. Select **D** to enable 3D graphical performance for that application.
- **I** column allows to run applications with iGPU. Select **I** for applications with media extensive performance.
- **H** column allows you to run applications with Hyperformance®. Tick **H** to enhance graphical performance for that application.



Actual graphical performance varies with the application used and graphics card installed.



Appendices

Notices

Federal Communications Commission Statement

This device complies with Part 15 of the FCC Rules. Operation is subject to the following two conditions:

- This device may not cause harmful interference.
- This device must accept any interference received including interference that may cause undesired operation.

This equipment has been tested and found to comply with the limits for a Class B digital device, pursuant to Part 15 of the FCC Rules. These limits are designed to provide reasonable protection against harmful interference in a residential installation. This equipment generates, uses and can radiate radio frequency energy and, if not installed and used in accordance with manufacturer's instructions, may cause harmful interference to radio communications. However, there is no guarantee that interference will not occur in a particular installation. If this equipment does cause harmful interference to radio or television reception, which can be determined by turning the equipment off and on, the user is encouraged to try to correct the interference by one or more of the following measures:

- Reorient or relocate the receiving antenna.
- Increase the separation between the equipment and receiver.
- Connect the equipment to an outlet on a circuit different from that to which the receiver is connected.
- Consult the dealer or an experienced radio/TV technician for help.



The use of shielded cables for connection of the monitor to the graphics card is required to assure compliance with FCC regulations. Changes or modifications to this unit not expressly approved by the party responsible for compliance could void the user's authority to operate this equipment.

IC: Canadian Compliance Statement

Complies with the Canadian ICES-003 Class B specifications. This device complies with RSS 210 of Industry Canada. This Class B device meets all the requirements of the Canadian interference-causing equipment regulations.

This device complies with Industry Canada license exempt RSS standard(s). Operation is subject to the following two conditions: (1) this device may not cause interference, and (2) this device must accept any interference, including interference that may cause undesired operation of the device.

Cet appareil numérique de la Classe B est conforme à la norme NMB-003 du Canada. Cet appareil numérique de la Classe B respecte toutes les exigences du Règlement sur le matériel brouilleur du Canada.

Cet appareil est conforme aux normes CNR exemptes de licence d'Industrie Canada. Le fonctionnement est soumis aux deux conditions suivantes :

- (1) cet appareil ne doit pas provoquer d'interférences et
- (2) cet appareil doit accepter toute interférence, y compris celles susceptibles de provoquer un fonctionnement non souhaité de l'appareil.

Canadian Department of Communications Statement

This digital apparatus does not exceed the Class B limits for radio noise emissions from digital apparatus set out in the Radio Interference Regulations of the Canadian Department of Communications.

This class B digital apparatus complies with Canadian ICES-003.

VCCI: Japan Compliance Statement

VCCI Class B Statement

情報処理装置等電波障害自主規制について

この装置は、情報処理装置等電波障害自主規制協議会（VCCI）の基準に基づくクラスB情報技術装置です。この装置は家庭環境で使用されることを目的としています。この装置がラジオやテレビジョン受信機に近接して使用されると、受信障害を引き起こすことがあります。

取扱説明書に従って正しい取り扱いをして下さい。

KC: Korea Warning Statement

B급 기기 (가정용 방송통신기자재)

이 기기는 가정용(B급) 전자파적합기기로서 주로 가정에서 사용하는 것을 목적으로 하며, 모든 지역에서 사용할 수 있습니다.

*당해 무선설비는 전파혼신 가능성이 있으므로 인명안전과 관련된 서비스는 할 수 없습니다.

REACH

Complying with the REACH (Registration, Evaluation, Authorisation, and Restriction of Chemicals) regulatory framework, we published the chemical substances in our products at ASUS REACH website at <http://csr.asus.com/english/REACH.htm>.



DO NOT throw the motherboard in municipal waste. This product has been designed to enable proper reuse of parts and recycling. This symbol of the crossed out wheeled bin indicates that the product (electrical and electronic equipment) should not be placed in municipal waste. Check local regulations for disposal of electronic products.



DO NOT throw the mercury-containing button cell battery in municipal waste. This symbol of the crossed out wheeled bin indicates that the battery should not be placed in municipal waste.

ASUS Recycling/Takeback Services

ASUS recycling and takeback programs come from our commitment to the highest standards for protecting our environment. We believe in providing solutions for you to be able to responsibly recycle our products, batteries, other components as well as the packaging materials. Please go to <http://csr.asus.com/english/Takeback.htm> for detailed recycling information in different regions.

RF Equipment Notices

CE: European Community Compliance Statement

The equipment complies with the RF Exposure Requirement 1999/519/EC, Council Recommendation of 12 July 1999 on the limitation of exposure of the general public to electromagnetic fields (0–300 GHz). This wireless device complies with the R&TTE Directive.

Wireless Radio Use

This device is restricted to indoor use when operating in the 5.15 to 5.25 GHz frequency band.

Exposure to Radio Frequency Energy

The radiated output power of the Wi-Fi technology is below the FCC radio frequency exposure limits. Nevertheless, it is advised to use the wireless equipment in such a manner that the potential for human contact during normal operation is minimized.

FCC Bluetooth Wireless Compliance

The antenna used with this transmitter must not be colocated or operated in conjunction with any other antenna or transmitter subject to the conditions of the FCC Grant.

Bluetooth Industry Canada Statement

This Class B device meets all requirements of the Canadian interference-causing equipment regulations.

Cet appareil numérique de la Class B respecte toutes les exigences du Règlement sur le matériel brouilleur du Canada.

BSMI: Taiwan Wireless Statement

無線設備的警告聲明

經型式認證合格之低功率射頻電機，非經許可，公司、商號或使用者均不得擅自變更射頻，加大功率或變更原設計之特性及功能。低功率射頻電機之使用不得影響飛航安全及干擾合法通信；經發現有干擾現象時，應立即停用，並改善至無干擾時方得繼續使用。前項合法通信指依電信法規定作業之無線通信。低功率射頻電機須忍受合法通信或工業、科學及醫療用電波輻射性電機設備之干擾。

於 5.25GHz 至 5.35GHz 區域內操作之
無線設備的警告聲明

工作頻率 5.250 ~ 5.350GHz 該頻段限於室內使用。

Japan RF Equipment Statement

この製品は、周波数帯域5.15～5.35GHzで動作しているときは、室内においてのみ使用可能です。

KC (RF Equipment)

대한민국 규정 및 준수

방통위 고시에 따른 고지사항

해당 무선설비는 운용 중 전파혼신 가능성이 있음,

이 기기는 인명안전과 관련된 서비스에 사용할 수 없습니다.

ASUS contact information

ASUSTeK COMPUTER INC.

Address	15 Li-Te Road, Peitou, Taipei, Taiwan 11259
Telephone	+886-2-2894-3447
Fax	+886-2-2890-7798
E-mail	info@asus.com.tw
Web site	www.asus.com.tw

Technical Support

Telephone	+86-21-38429911
Online support	support.asus.com

ASUS COMPUTER INTERNATIONAL (America)

Address	800 Corporate Way, Fremont, CA 94539, USA
Telephone	+1-812-282-3777
Fax	+1-510-608-4555
Web site	usa.asus.com

Technical Support

Telephone	+1-812-282-2787
Support fax	+1-812-284-0883
Online support	support.asus.com

ASUS COMPUTER GmbH (Germany and Austria)

Address	Harkort Str. 21-23, D-40880 Ratingen, Germany
Fax	+49-2102-959911
Web site	www.asus.de
Online contact	www.asus.de/sales

Technical Support

Telephone	+49-1805-010923*
Support Fax	+49-2102-9599-11
Online support	support.asus.com

* EUR 0.14/minute from a German fixed landline; EUR 0.42/minute from a mobile phone.

DECLARATION OF CONFORMITY

Per FCC Part 2, Section 2.1077(a)



Responsible Party Name: **Asus Computer International**

Address: **800 Corporate Way, Fremont, CA 94539.**

Phone/Fax No: **(510)739-3777/(510)608-4555**

hereby declares that the product

Product Name : Motherboard

Model Number :P8277-1DELUXE

Conforms to the following specifications:

- FCC Part 15, Subpart B, Unintentional Radiators
- FCC Part 15, Subpart C, Intentional Radiators
- FCC Part 15, Subpart E, Intentional Radiators

Supplementary Information:

This device complies with part 15 of the FCC Rules. Operation is subject to the following two conditions: (1) This device may not cause harmful interference, and (2) this device must accept any interference received, including interference that may cause undesired operation.

Representative Person's Name : Steve Chang / President

Signature : 
Date : Feb. 10, 2012

Ver. 110101

EC Declaration of Conformity



We, the undersigned,

Manufacturer: **ASUSTEK COMPUTER INC.**
Address, City: **4F, No. 150-LI-TE Rd., PEITOU, TAIPEI 112, TAIWAN**
Country: **TAIWAN**
Authorized representative in Europe: **ASUS COMPUTER GmbH**
Address, City: **HARKORT STR. 2 | 23. 40880 RATINGEN**
Country: **GERMANY**

declare the following apparatus:

Product name : **Motherboard**
Model name : **P8277-1DELUXE**

conform with the essential requirements of the following directives:

- 2004/10/EC-EMC Directive**
 - EN 61000-3-2:2006+A2:2009
 - EN 55013:2011/A1:2003+A2:2005
- 2009/90/EC-R & TTE Directive**
 - EN 300 328 V1.7 (12/06/10)
 - EN 300 440-2 V1.4 (12/01/08)
 - EN 301 511 V9.0 (2/20/03/03)
 - EN 301 908-2 V5.2 (1/2011/07)
 - EN 301 888 V1.6 (12/01/11)
 - EN 300 623 V1.1 (12/09/01)
 - EN 300 335-1 V1.7 (12/01/02)
 - EN 300 335-2 V1.5 (12/01/02)
 - EN 50960:2001
 - EN 62479:2010
- 2006/95/EC-LVD Directive**
 - EN 60950-1/A:11/2009
 - EN 60950-1/A:12/2011
- 2009/12/EC-EP Directive**
 - Regulation (EC) No. 1275/2008
 - Regulation (EC) No. 642/2009
- 2011/65/EU-RoHS Directive**
 - Regulation (EC) No. 1907/2006
 - EN 62311:2008



(EC conformity marking)

Position : **CEO**
Name : **Jerry Shan**



Signature : _____

Declaration Date: **Dec. 10, 2012**
Year to begin affixing CE marking: **2012**

Ver. 121001



