

**P8Z77-V
PREMIUM**

ASUS®

Motherboard

E7356
First Edition
April 2012

Copyright © 2012 ASUSTeK COMPUTER INC. All Rights Reserved.

No part of this manual, including the products and software described in it, may be reproduced, transmitted, transcribed, stored in a retrieval system, or translated into any language in any form or by any means, except documentation kept by the purchaser for backup purposes, without the express written permission of ASUSTeK COMPUTER INC. ("ASUS").

Product warranty or service will not be extended if: (1) the product is repaired, modified or altered, unless such repair, modification of alteration is authorized in writing by ASUS; or (2) the serial number of the product is defaced or missing.

ASUS PROVIDES THIS MANUAL "AS IS" WITHOUT WARRANTY OF ANY KIND, EITHER EXPRESS OR IMPLIED, INCLUDING BUT NOT LIMITED TO THE IMPLIED WARRANTIES OR CONDITIONS OF MERCHANTABILITY OR FITNESS FOR A PARTICULAR PURPOSE. IN NO EVENT SHALL ASUS, ITS DIRECTORS, OFFICERS, EMPLOYEES OR AGENTS BE LIABLE FOR ANY INDIRECT, SPECIAL, INCIDENTAL, OR CONSEQUENTIAL DAMAGES (INCLUDING DAMAGES FOR LOSS OF PROFITS, LOSS OF BUSINESS, LOSS OF USE OR DATA, INTERRUPTION OF BUSINESS AND THE LIKE), EVEN IF ASUS HAS BEEN ADVISED OF THE POSSIBILITY OF SUCH DAMAGES ARISING FROM ANY DEFECT OR ERROR IN THIS MANUAL OR PRODUCT.

SPECIFICATIONS AND INFORMATION CONTAINED IN THIS MANUAL ARE FURNISHED FOR INFORMATIONAL USE ONLY, AND ARE SUBJECT TO CHANGE AT ANY TIME WITHOUT NOTICE, AND SHOULD NOT BE CONSTRUED AS A COMMITMENT BY ASUS. ASUS ASSUMES NO RESPONSIBILITY OR LIABILITY FOR ANY ERRORS OR INACCURACIES THAT MAY APPEAR IN THIS MANUAL, INCLUDING THE PRODUCTS AND SOFTWARE DESCRIBED IN IT.

Products and corporate names appearing in this manual may or may not be registered trademarks or copyrights of their respective companies, and are used only for identification or explanation and to the owners' benefit, without intent to infringe.

Offer to Provide Source Code of Certain Software

This product contains copyrighted software that is licensed under the General Public License ("GPL"), under the Lesser General Public License Version ("LGPL") and/or other Free Open Source Software Licenses. Such software in this product is distributed without any warranty to the extent permitted by the applicable law. Copies of these licenses are included in this product.

Where the applicable license entitles you to the source code of such software and/or other additional data, you may obtain it for a period of three years after our last shipment of the product, either

(1) for free by downloading it from <http://support.asus.com/download>

or

(2) for the cost of reproduction and shipment, which is dependent on the preferred carrier and the location where you want to have it shipped to, by sending a request to:

ASUSTeK Computer Inc.
Legal Compliance Dept.
15 Li Te Rd.,
Beitou, Taipei 112
Taiwan

In your request please provide the name, model number and version, as stated in the About Box of the product for which you wish to obtain the corresponding source code and your contact details so that we can coordinate the terms and cost of shipment with you.

The source code will be distributed WITHOUT ANY WARRANTY and licensed under the same license as the corresponding binary/object code.

This offer is valid to anyone in receipt of this information.

ASUSTeK is eager to duly provide complete source code as required under various Free Open Source Software licenses. If however you encounter any problems in obtaining the full corresponding source code we would be much obliged if you give us a notification to the email address gpl@asus.com, stating the product and describing the problem (please DO NOT send large attachments such as source code archives, etc. to this email address).

Contents

Safety information.....	vii
About this guide.....	viii
P8Z77-V PREMIUM Windows® OS restrictions.....	x
P8Z77-V PREMIUM specifications summary.....	xi
Package contents.....	xvi
Installation tools and components.....	xvii
Chapter 1: Product introduction	1-1
1.1 Special features.....	1-1
1.1.1 Product highlights.....	1-1
1.1.2 Dual Intelligent Processors 3 with SMART DIGI+ Power Control.....	1-2
1.1.3 ASUS Exclusive Features.....	1-3
1.1.4 ASUS Quiet Thermal Solution.....	1-4
1.1.5 ASUS EZ DIY.....	1-4
1.1.6 Other special features.....	1-5
1.2 Motherboard overview.....	1-6
1.2.1 Before you proceed.....	1-6
1.2.2 Motherboard layout.....	1-7
1.2.3 Central Processing Unit (CPU).....	1-9
1.2.4 System memory.....	1-10
1.2.5 Expansion slots.....	1-24
1.2.6 Onboard buttons and switches.....	1-26
1.2.7 Jumpers.....	1-31
1.2.8 Onboard LEDs.....	1-32
1.2.9 Internal connectors.....	1-39
Chapter 2: Basic Installation	2-1
2.1 Building your PC system.....	2-1
2.1.1 Motherboard installation.....	2-1
2.1.2 CPU installation.....	2-4
2.1.3 CPU heatsink and fan assembly installation.....	2-5
2.1.4 DIMM installation.....	2-7
2.1.5 ATX Power connection.....	2-8
2.1.6 SATA device connection.....	2-9
2.1.7 Front I/O Connector.....	2-10
2.1.8 Expansion Card installation.....	2-11
2.1.9 Wi-Fi GO! card installation.....	2-12

2.2	BIOS update utility	2-14
2.2.1	USB BIOS Flashback.....	2-14
2.3	Motherboard rear and audio connections	2-15
2.3.1	Rear I/O connection.....	2-15
2.3.2	Audio I/O connections.....	2-17
2.4	Starting up for the first time	2-19
2.5	Turning off the computer	2-20
Chapter 3:	BIOS setup	3-1
3.1	Knowing BIOS	3-1
3.2	BIOS setup program	3-2
3.2.1	EZ Mode.....	3-3
3.2.2	Advanced Mode.....	3-4
3.3	Main menu	3-6
3.4	Ai Tweaker menu	3-8
3.5	Advanced menu	3-20
3.5.1	CPU Configuration.....	3-21
3.5.2	PCH Configuration.....	3-23
3.5.3	SATA Configuration.....	3-24
3.5.4	System Agent Configuration.....	3-25
3.5.5	Intel® Thunderbolt.....	3-27
3.5.6	USB Configuration.....	3-28
3.5.7	Onboard Devices Configuration.....	3-29
3.5.8	APM.....	3-31
3.5.9	Network Stack.....	3-32
3.6	Monitor menu	3-33
3.7	Boot menu	3-36
3.8	Tools menu	3-38
3.8.1	ASUS EZ Flash 2 Utility.....	3-38
3.8.2	ASUS O.C. Profile.....	3-38
3.8.3	ASUS SPD Information.....	3-39
3.9	Exit menu	3-40
3.10	Updating BIOS	3-41
3.10.1	ASUS Update.....	3-41
3.10.2	ASUS EZ Flash 2.....	3-44
3.10.3	ASUS CrashFree BIOS 3.....	3-45
3.10.4	ASUS BIOS Updater.....	3-46

Chapter 4:	Software support	4-1
4.1	Installing an operating system	4-1
4.2	Support DVD information	4-1
4.2.1	Running the support DVD	4-1
4.2.2	Obtaining the software manuals	4-2
4.3	Software information	4-3
4.3.1	AI Suite II	4-3
4.3.2	TurboV EVO	4-4
4.3.3	DIGI+ Power Control	4-9
4.3.4	EPU	4-13
4.3.5	USB 3.0 Boost	4-14
4.3.6	USB BIOS Flashback Wizard	4-15
4.3.7	ASUS SSD Caching II	4-17
4.3.8	Ai Charger+	4-19
4.3.9	Probe II	4-20
4.3.10	Sensor Recorder	4-21
4.3.11	ASUS Update	4-23
4.3.12	MyLogo2	4-24
4.3.13	Audio configurations	4-25
Chapter 5:	RAID support	5-1
5.1	RAID configurations	5-1
5.1.1	RAID definitions	5-1
5.1.2	Installing Serial ATA hard disks	5-2
5.1.3	Setting the RAID item in BIOS	5-2
5.1.4	Intel® Rapid Storage Technology Option ROM utility	5-3
5.1.5	Marvell RAID utility	5-7
5.2	Creating a RAID driver disk	5-11
5.2.1	Creating a RAID driver disk without entering the OS	5-11
5.2.2	Creating a RAID driver disk in Windows®	5-11
5.2.3	Installing the RAID driver during Windows® OS installation	5-12
5.2.4	Using a USB floppy disk drive	5-13
Chapter 6:	Multiple GPU support	6-1
6.1	AMD® CrossFireX™ technology	6-1
6.1.1	Requirements	6-1
6.1.2	Before you begin	6-1
6.1.3	Installing two CrossFireX™ graphics cards	6-2

6.1.4	Installing three CrossFireX™ graphics cards.....	6-3
6.1.5	Installing four CrossFireX™ graphics cards.....	6-4
6.1.6	Installing the device drivers.....	6-5
6.1.7	Enabling the AMD® CrossFireX™ technology.....	6-5
6.2	NVIDIA® SLI™ technology.....	6-7
6.2.1	Requirements.....	6-7
6.2.2	Installing two SLI-ready graphics cards.....	6-7
6.2.3	Installing three SLI-ready graphics cards.....	6-8
6.2.4	Installing four SLI-ready graphics cards.....	6-9
6.2.5	Installing the device drivers.....	6-9
6.2.6	Enabling the NVIDIA® SLI™ technology.....	6-10
6.3	LucidLogix Virtu MVP.....	6-12
6.3.1	Installing LucidLogix Virtu MVP.....	6-12
6.3.2	Setting up your display.....	6-13
6.3.3	Configuring LucidLogix Virtu MVP.....	6-14
Chapter 7:	Intel® technologies	7-1
7.1	Intel® 2012 Desktop responsiveness technologies.....	7-1
7.1.1	Intel® Smart Response Technology.....	7-3
7.1.2	Intel® Rapid Start Technology.....	7-4
7.1.3	Intel® Smart Connect Technology.....	7-10
Appendices		A-1
Notices		A-1
ASUS contact information		A-5

Safety information

Electrical safety

- To prevent electrical shock hazard, disconnect the power cable from the electrical outlet before relocating the system.
- When adding or removing devices to or from the system, ensure that the power cables for the devices are unplugged before the signal cables are connected. If possible, disconnect all power cables from the existing system before you add a device.
- Before connecting or removing signal cables from the motherboard, ensure that all power cables are unplugged.
- Seek professional assistance before using an adapter or extension cord. These devices could interrupt the grounding circuit.
- Ensure that your power supply is set to the correct voltage in your area. If you are not sure about the voltage of the electrical outlet you are using, contact your local power company.
- If the power supply is broken, do not try to fix it by yourself. Contact a qualified service technician or your retailer.

Operation safety

- Before installing the motherboard and adding devices on it, carefully read all the manuals that came with the package.
- Before using the product, ensure all cables are correctly connected and the power cables are not damaged. If you detect any damage, contact your dealer immediately.
- To avoid short circuits, keep paper clips, screws, and staples away from connectors, slots, sockets and circuitry.
- Avoid dust, humidity, and temperature extremes. Do not place the product in any area where it may become wet.
- Place the product on a stable surface.
- If you encounter technical problems with the product, contact a qualified service technician or your retailer.

About this guide

This user guide contains the information you need when installing and configuring the motherboard.

How this guide is organized

This guide contains the following parts:

- **Chapter 1: Product introduction**
This chapter describes the features of the motherboard and the new technology it supports. It includes description of the switches, jumpers, and connectors on the motherboard.
- **Chapter 2: Basic Installation**
This chapter lists the hardware setup procedures that you have to perform when installing system components.
- **Chapter 3: BIOS setup**
This chapter tells how to change system settings through the BIOS Setup menus. Detailed descriptions of the BIOS parameters are also provided.
- **Chapter 4: Software support**
This chapter describes the contents of the support DVD that comes with the motherboard package and the software.
- **Chapter 5: RAID support**
This chapter describes the RAID configurations.
- **Chapter 6: Multiple GPU technology support**
This chapter describes how to install and configure multiple ATI® CrossFireX™ and NVIDIA® SLI™ graphics cards.
- **Chapter 7: Intel® technologies**
This chapter tells how to install the Intel® 2012 desktop responsiveness technologies.

Where to find more information

Refer to the following sources for additional information and for product and software updates.

1. **ASUS websites**
The ASUS website provides updated information on ASUS hardware and software products. Refer to the ASUS contact information.
2. **Optional documentation**
Your product package may include optional documentation, such as warranty flyers, that may have been added by your dealer. These documents are not part of the standard package.

Conventions used in this guide

To ensure that you perform certain tasks properly, take note of the following symbols used throughout this manual.



DANGER/WARNING: Information to prevent injury to yourself when trying to complete a task.



CAUTION: Information to prevent damage to the components when trying to complete a task.



IMPORTANT: Instructions that you **MUST** follow to complete a task..



NOTE: Tips and additional information to help you complete a task.

Typography

Bold text

Indicates a menu or an item to select.

Italics

Used to emphasize a word or a phrase.

<Key>

Keys enclosed in the less-than and greater-than sign means that you must press the enclosed key.

Example: <Enter> means that you must press the Enter or Return key.

<Key1> + <Key2> + <Key3>

If you must press two or more keys simultaneously, the key names are linked with a plus sign (+).

P8Z77-V PREMIUM Windows® OS restrictions

Type	Feature	Windows® 7	Windows® XP
Intel Features	Intel® Turbo Boost 2.0	•	•
	Intel® Extreme Memory Profile	•	•
	Intel® Quick Sync Video 2.0	•	•
	Intel® InTru 3D	•	•
	Intel® Clear Video HD Technology	•	•
	Intel® Insider	•	•
	Intel® Smart Response Technology	•	
	Intel® Rapid Start Technology	•	
	Intel® Smart Connect Technology	•	
	Intel® Native USB 3.0 ports	•	runs at USB 2.0 speed
ASUS Exclusive Features	DIGI+ Power Control (with SMART DIGI+)	•	•
	EPU	•	•
	TPU (TurboV, Auto Tuning, GPU Boost)	•	•
	Fan Xpert2	•	•
	USB BIOS Flashback (Wizard)	•	•
	USB Charger+	•	•
	Ai Charger+	•	•
	Disk Unlocker	•	•
	ASUS SSD Caching II	•	•
	AI Suite II	•	•
	MemOK!	•	•
	USB 3.0 Boost (for ASUS extra USB 3.0 ports)	•	•
	USB 3.0 Boost (for Intel® Native USB 3.0 ports)	•	
	Wi-Fi GO!	•	
	Network iControl	•	
	DTS UltraPC II	•	
	DTS Connect	•	
LucidLogix Virtu MVP	•		



- Due to Intel® limitations, Intel® USB 3.0 ports only run at USB 3.0 speed under Windows® 7 or later versions.
- Due to Intel® limitations, P8Z77-V PREMIUM does not support Windows® Vista.

P8Z77-V PREMIUM specifications summary

CPU	<p>LGA1155 socket for Intel® 3rd/2nd Generation Core™ i7 Core™ i5 / Core™ i3 / Pentium® / Celeron® Processors</p> <p>Supports 22/32nm CPU</p> <p>Supports Intel® Turbo Boost Technology 2.0</p> <p>* The Intel® Turbo Boost Technology 2.0 support depends on the CPU types.</p> <p>** Refer to www.asus.com for Intel CPU support list</p>
Chipset	<p>Intel® Z77 Express Chipset</p>
Memory	<p>4 x DIMM, max. 32GB, DDR3 2800 (O.C.)* / 2600 (O.C.)* / 2400 (O.C.)* / 2200(O.C.) / 2133(O.C.) / 1866(O.C.) / 1600 / 1333 / 1066 MHz, non-ECC, un-buffered memory</p> <p>Dual channel memory architecture</p> <p>Supports Intel® Extreme Memory Profile (XMP)</p> <p>* Hyper DIMM support is subject to the physical characteristics of individual CPUs. Please refer to Memory QVL (Qualified Vendors List) for details.</p>
Expansion slots	<p>4 x PCI Express 3.0*/2.0 x16 slots (support x16, x16/x16, x16/x8/x8, x8/x8/x8/x8 modes)</p> <p>2 x PCI Express 2.0 x1 slots</p> <p>* Intel® 3rd generation Core™ processors support PCIe 3.0.</p>
VGA	<p>Integrated Graphics Processor - Intel® HD Graphics support</p> <p>Multi-VGA output support: Thunderbolt/DisplayPort/HDMI port</p> <p>Supports Thunderbolt Interface with max. resolution of 2560 x 1600 @60Hz</p> <p>Supports DisplayPort 1.1a with max. resolution of 2560 x 1600 @60Hz</p> <p>Supports HDMI with max. resolution of 1920 x 1200 @60Hz</p> <p>Supports Intel® InTru™ 3D/Quick Sync Video/Clear Video HD Technology/Insider™</p> <p>Maximum shared memory 1696MB</p>
Multi-GPU support	<p>Supports NVIDIA® 4-WAY SLI™ Technology</p> <p>Supports AMD® 4-WAY CrossFireX™ Technology</p> <p>Supports Lucidlogix Virtu MVP Technology*</p> <p>*LucidLogix Virtu MVP supports Windows® 7 operating system.</p>
LAN	<p>Dual Intel® Gigabit LAN controllers—802.3az Energy Efficient Ethernet (EEE) appliance and dual interconnect between the integrated LAN controller and physical layer (PHY)</p> <p>Intel® 82579V Gigabit LAN controller</p> <p>Intel® 82583 Gigabit LAN controller</p>
Wireless Data Network	<p>Wi-Fi 802.11 a/b/g/n supports dual frequency band 2.4/5 GHz</p> <p>ASUS Wi-Fi GO! Utility</p>

(continued on the next page)

P8Z77-V PREMIUM specifications summary

Storage	<p>Intel® Z77 Express Chipset with RAID 0, 1, 5, 10 support</p> <ul style="list-style-type: none"> - 2 x SATA 6.0 Gb/s ports (gray) - 3 x SATA 3.0 Gb/s ports (blue) <ul style="list-style-type: none"> - 1 x mSATA 3.0 Gb/s port with onboard 32GB SSD - Supports Intel® Smart Response Technology, Intel® Rapid Start Technology, Intel® Smart Connect Technology* <p>Marvell® 9230 PCIe SATA 6Gb/s controller</p> <ul style="list-style-type: none"> - 4 x SATA 6Gb/s ports (navy blue) with RAID 0, 1, 10 support <p>ASMedia® SATA 6Gb/s controller**</p> <ul style="list-style-type: none"> - 2 x eSATA 6Gb/s ports with port multiplier support <p>* Supports Intel® Core™ processors on Windows® 7 operating system.</p> <p>** These SATA ports are for data hard drives only. ATAPI devices are not supported.</p>
Bluetooth	<p>Bluetooth v4.0 Bluetooth v3.0 + HS</p>
Audio	<p>Realtek® ALC898 8-channel high definition audio CODEC</p> <ul style="list-style-type: none"> - Absolute Pitch 192khz/24bit True BD Lossless Sound - BD audio layer content protection - DTS UltraPC II - DTS Connect - Supports jack-detection, multi-streaming and front panel jack-retasking - Optical S/PDIF out ports at back I/O
USB	<p>1 x ASMedia® USB 3.0 controller - supports ASUS USB 3.0 Boost UASP Mode</p> <ul style="list-style-type: none"> - 2 x USB 3.0/2.0 ports at back panel (blue) <p>Intel® Z77 Express Chipset - supports ASUS USB 3.0 Boost Turbo Mode*</p> <ul style="list-style-type: none"> - 2 x USB 3.0/2.0 ports at mid-board for front panel support - 2 x USB 3.0/2.0 ports at back panel (blue) <p>Intel® Z77 Express Chipset</p> <ul style="list-style-type: none"> - 6 x USB 2.0/1.1 ports (4 ports at mid-board, 2 ports at back panel) <p>* The USB 3.0 ports run at USB 3.0 speed rate under Windows® 7 or later versions.</p>
BIOS features	<p>64 Mb Flash ROM, UEFI AMI BIOS, PnP, DMI 2.0, WfM 2.0, SM BIOS 2.5, ACPI 2.0a, Multi-language BIOS, ASUS EZ Flash 2, ASUS CrashFree BIOS 3, F12 PrintScreen function, F3 Shortcut function, and ASUS DRAM SPD (Serial Presence Detect) memory information</p>
Manageability	<p>WfM 2.0, DMI 2.0, WOL by PME, PXE</p>

(continued on the next page)

P8Z77-V PREMIUM specifications summary

ASUS unique features

ASUS Dual Intelligent Processors 3 - SMART DIGI+ Power Control

SMART DIGI+

- SMART DIGI+ Key quickly delivers a higher VRM frequency, voltage, and current for superior CPU/GPU/ DRAM overclocking performance with one switch.
- Smart CPU Power Level (Intel® VRD 12.5 Future Power Design) provides the best digital power saving conditions.

CPU Power

- Industry leading digital 20-phase power design (16-phase for CPU, 4-phase for iGPU)
- ASUS CPU power utility

DRAM Power

- Industry leading digital 2-phase DRAM power design
- ASUS DRAM power utility

ASUS EPU

- EPU, EPU switch

ASUS TPU

- Auto Tuning, TurboV, GPU Boost, TPU switch

ASUS Wi-Fi GO!

- Wi-Fi GO! functions include DLNA Media Hub, Smart Motion Control, Remote Desktop, Remote Keyboard & Mouse, File Transfer, Capture & Send (available with V1.01.00 or later)
- Wi-Fi GO! Remote offers remote control functions using your mobile device running on iOS 4.0 or later, and Android 2.3 or later.
- Wi-Fi Engine's Client and AP modes for network sharing and connection.

ASUS Exclusive Features:

- Network iControl
- ASUS SSD Caching II
- USB 3.0 Boost
- USB Charger+
- AI Charger+
- Disk Unlocker
- AI Suite II
- Anti Surge
- MemOK!

ASUS Quiet Thermal Solution:

- ASUS Fan Xpert 2
- ASUS Fanless Design: Heat-pipe solution

(continued on the next page)

P8Z77-V PREMIUM specifications summary

ASUS unique features	ASUS EZ DIY <ul style="list-style-type: none">- ASUS USB BIOS Flashback- ASUS UEFI BIOS EZ Mode- ASUS O.C. Tuner- ASUS CrashFree BIOS 3- ASUS EZ Flash 2 ASUS Q-Design <ul style="list-style-type: none">- ASUS Q-Code- ASUS Q-Shield- ASUS Q-LED (CPU, DRAM, VGA, Boot Device LED)- ASUS Q-Slot- ASUS Q-DIMM- ASUS Q-Connector
ASUS exclusive overclocking features	Precision Tweaker 2 <ul style="list-style-type: none">- vCore: Adjustable CPU voltage at 0.005V increment- vCCIO: Adjustable I/O voltage at 0.00625V increment- vCCSA: 144-step system agent voltage control- vDRAM Bus: 160-step Memory voltage control- vPCH: 90-step Chipset voltage control- iGPU: 255-step iGPU voltage control- vCPU_PLL: 160-step CPU & PCH PLL voltage control SFS (Stepless Frequency Selection) <ul style="list-style-type: none">- BCLK/PCIE frequency tuning from 80MHz up to 300MHz at 0.1MHz increment Overclocking Protection <ul style="list-style-type: none">- ASUS C.P.R.(CPU Parameter Recall)
Back Panel I/O Ports	1 x Thunderbolt port 1 x DisplayPort 1 x HDMI port 1 x BT4 connector for ASUS Wi-Fi GO! card (Wi-Fi 802.11 a/b/g/n and Bluetooth v4.0/3.0+HS) 1 x Optical S/PDIF Out port 2 x eSATA ports 2 x Intel® LAN (RJ-45) ports 4 x USB 3.0/2.0 ports (blue, 1 supports USB BIOS Flashback) 2 x USB 2.0/1.1 ports 1 x USB BIOS Flashback button 8-channel Audio I/O ports

(continued on the next page)

P8Z77-V PREMIUM specifications summary









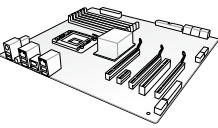

Internal I/O connectors	<ul style="list-style-type: none">1 x 19-pin USB 3.0/2.0 connector supports additional 2 USB ports2 x USB 2.0/1.1 connectors support additional 4 USB ports6 x SATA 6.0 Gb/s connectors (2 x gray; 4 x navy blue)3 x SATA 3.0 Gb/s connectors (blue)1 x mSATA connector with 32GB SSD onboard1 x 4-pin CPU Fan connector1 x 4-pin CPU Optional Fan connector4 x 4-pin Chassis Fan connectors1 x Front panel audio connector (AAFP)1 x S/PDIF out header1 x TPM connector1 x 24-pin EATX Power connector1 x 8-pin EATX 12V Power connector1 x System Panel (Q-Connector)1 x MemOK! button1 x Clear CMOS button1 x EPU switch1 x TPU switch1 x Power-on switch1 x Reset switch
Support DVD contents	<ul style="list-style-type: none">DriversASUS UtilitiesASUS UpdateAnti-virus software (OEM version)
Form factor	ATX form factor: 12 in. x 9.6 in. (30.5 cm x 24.4 cm)

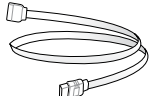

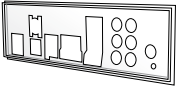
Specifications are subject to change without notice.

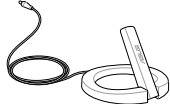
Package contents

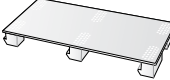

Check your motherboard package for the following items.

		
ASUS P8Z77-V PREMIUM motherboard	User manual	Support DVD
		
4 x Serial ATA 6.0 Gb/s cables 2 x Serial ATA 3.0 Gb/s cables	1 x ASUS SLI™ bridge connector	1 x ASUS Q-Shield
		
1 x ASUS Wi-Fi GO! card (Wi-Fi 802.11 a/b/g/n and Bluetooth v4.0/3.0+HS)	1 x 2-in-1 ASUS Q-Connector kit	2 x Wi-Fi Ring moving antennas
		
1 x 4-WAY SLI card	1 x 3-WAY SLI card	USB 3.0 front panel box

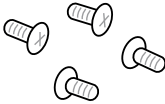

- If any of the above items is damaged or missing, contact your retailer.
- The illustrated items above are for reference only. Actual product specifications may vary with different models.

Installation tools and components

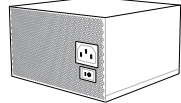
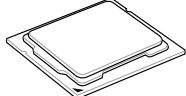
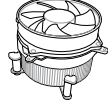
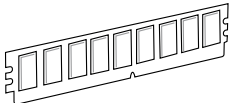
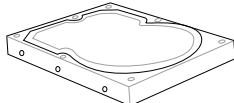
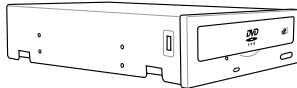
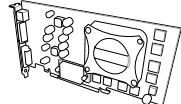
	
1 bag of screws	Phillips (cross) screwdriver
	
PC chassis	Power supply unit
	
Intel LGA 1155 CPU	Intel LGA 1155 compatible CPU Fan
	
DIMM	SATA hard disk drive
	
SATA optical disc drive (optional)	Graphics card (optional)



The tools and components in the table above are not included in the motherboard package.

Product introduction

1

1.1 Special features

1.1.1 Product highlights

LGA1155 socket for Intel® 2nd/3rd Generation Core™ i7 / Core™ i5 / Core™ i3, Pentium®, and Celeron® Processors

This motherboard supports Intel 2nd/3rd generation Core™ i7/i5/i3, Pentium, and Celeron processors in the LGA1155 package. It provides great graphics and system performance with its GPU, dual-channel DDR3 memory slots, and PCI Express 2.0/3.0 expansion slots.

Intel® Z77 Express Chipset

Intel® Z77 Express Chipset is a single-chipset that supports the 1155 socket Intel® 2nd/3rd generation Core™ i7/i5/ i3, Pentium®, and Celeron® processors. It utilizes the serial point-to-point links, which increases bandwidth and enhances the system's performance. It natively supports four USB 3.0 ports for up to ten times faster transfer rate than USB 2.0, and enables the iGPU function for Intel® integrated graphics performance.

PCI Express® 3.0

PCI Express® 3.0 (PCIe 3.0) is the PCI Express bus standard that provides twice the performance and speed of PCIe 2.0. It provides an optimal graphics performance, unprecedented data speed, and seamless transition with its complete backward compatibility to PCIe 1.0/2.0 devices.

* Intel® 3rd generation Core™ processors support PCIe 3.0.

Dual-Channel DDR3 2800(O.C.) / 2600(O.C.) / 2400(O.C.) / 2200(O.C.) / 2133(O.C.) / 1866(O.C.) / 1600 / 1333 / 1066 MHz Support

The motherboard supports the dual-channel DDR3 memory that features data transfer rates of DDR3 2800(O.C.) / 2600(O.C.) / 2400(O.C.) / 2200(O.C.) / 2133(O.C.) / 1866(O.C.) / 1600 / 1333 / 1066 MHz to boost the system's performance, and to meet the higher bandwidth requirements of 3D graphics, multimedia, and Internet applications.

* Due to Intel® 2nd generation processor's behavior, DDR3 2200 (and higher), and DDR3 2000/1800 MHz memory modules run at default rates of DDR3 2133/1866/1600 MHz.

4-WAY SLI and 3-WAY SLI CrossFireX™ Support

This motherboard features a unique PCIe 3.0 bridge chip to support 4-Way SL/CrossFireX graphics cards for an unrivaled gaming performance. With the Intel Z77 platform to optimize the PCIe allocation of multiple GPUs, it supports up to four graphic cards in both SLI or CrossFireX configuration.

Intel® Smart Response Technology

Intel® Smart Response Technology, an important part of Green ASUS eco-friendly computing, reduces load and wait time, eliminates unnecessary hard drive spin thus lowering power usage, and uses an installed SSD (requires 18.6 GB available space) as a cache for frequently accessed data or applications. It combines SSD performance and hard drive capacity, operating up to six times faster than a hard-drive-only system, to boost the system's overall performance.

* Intel® 2nd/3rd generation Core™ processors on Windows® 7™ operating systems support Intel® Smart Response Technology.

** An operating system must be installed on the HDD to launch Intel® Smart Response Technology.

*** The SSD is reserved for caching function.

Intel® Smart Connect Technology

Your computer can receive fresh updates for selected applications, even when the system is in sleep mode. This means less time waiting for applications to update and sync with the cloud, leading to a more efficient computing experience.

Intel® Rapid Start Technology

Intel® Rapid Start Technology allows your system to receive updates for your web applications in real-time even when your system is in sleep mode, saving wait time and power usage.

1.1.2 Dual Intelligent Processors 3 with SMART DIGI+ Power Control

Together with the ASUS pioneered twin onboard chips, TPU (TurboV Processing Unit) and EPU (Energy Processing Unit), ASUS Dual Intelligent Processors feature SMART DIGI+ Power Control, which includes multiple digital voltage controllers that allow ultra-precise auto-tuning for the CPU, iGPU and DRAM. It allows you to set the system to auto-tune the settings for fast/extreme performance or to manually adjust the voltage levels, offering easier power control and better power-saving solutions via the ASUS AI Suite II utility.

TPU with SMART DIGI+

SMART DIGI+ Technology works with TPU (TurboV Processing Unit) to ramp up the system's performance to its maximum. Enable the SMART DIGI+ key with a single click and adjust CPU ratios manually in the TPU to increase CPU frequency.

TPU (TurboV Processing Unit) offers precise voltage control and advanced monitoring mechanisms through the Auto Tuning and TurboV functions.

Auto Tuning provides a user-friendly solution to automatically optimize the system for fast, yet stable clock speeds, while TurboV enables unlimited freedom to adjust CPU frequencies and ratios for optimized performance in diverse situations.

CPU Power Wattage Cut in Half (With next generation Intel® VRD 12.5 future power technology)

SMART DIGI+ Technology also includes the Smart CPU Power Level profile, which reduces CPU power usage at the specified power level, thus creating a cooler and quieter system.

EPU

EPU (Energy Processing Unit), the world's first real-time system power-saving chip, automatically detects the current system load and intelligently moderates power usage. It offers a total system-wide energy optimization, reduces fan noise, and extends the component's lifespan.

1.1.3 ASUS Exclusive Features

Wi-Fi GO!

ASUS Wi-Fi GO! leads the way to a more enjoyable home entertainment. With ASUS Wi-Fi GO!, you can wirelessly stream media files to DLNA devices, remotely control and access your computer using your mobile device, and easily transfer files between your computer and mobile device.

Conveniently use and enjoy these ASUS Wi-Fi GO! functions:

- **DLNA Media Hub:** Provides support to the latest DLNA standard, and allows you to stream media files to a DLNA-supported device.
- **Remote Desktop:** Allows you to view your computer's desktop and remotely operate your computer in real-time from your mobile device.
- **Remote Keyboard and Mouse:** Allows you to use your mobile device's touch panel as a remote keyboard and mouse for your computer.
- **Smart Motion Control:** Allows you to remotely control your computer using your mobile device's customized gestures.
- **File Transfer:** Allows you to transfer files between your computer and mobile device.
- **Capture and Send:** Allows you to take screenshots and send them to a mobile device.

GPU Boost

GPU Boost accelerates the integrated GPU for extreme graphics performance, facilitates flexible frequency adjustments, and easily delivers stable system-level upgrades for every use.

USB 3.0 Boost

ASUS USB 3.0 Boost technology supports UASP (USB Attached SCSI Protocol), the latest USB 3.0 standard. With USB 3.0 Boost technology, a USB device's transmission speed is significantly increased up to 170%, adding to an already impressive fast USB 3.0 transfer speed. ASUS software automatically accelerates data speeds for compatible USB 3.0 peripherals without the need for any user interaction.

USB Charger+

With a dedicated onboard controller, quick-charge all your smart devices such as smartphones, tablets, and more, all up to three times faster, even when the system is powered off, in sleep, or hibernation mode.

ASUS SSD Caching II

ASUS SSD Caching II supports Marvell® HyperDuo Plus technology, allowing you to use SSDs (Solid State Drive) for multi-caching of frequently accessed programs and data. Install at least one HDD (Hard Disk Drive) and one or more SSDs to the Marvell SATA ports for an SSD-like transfer speed.

USB BIOS Flashback

USB BIOS Flashback offers a hassle-free updating solution for your ultimate convenience. Install a USB storage device containing the BIOS file, press the BIOS Flashback button for about three seconds, and the UEFI BIOS is automatically updated even without entering the existing BIOS or operating system. It also allows you to regularly check for UEFI BIOS updates, and download the latest BIOS automatically.

Network iControl

Network iControl is an intuitive one-step network control center that makes it easier for you to manage your bandwidth and allows you to set, monitor, and schedule the bandwidth priorities for your network programs. It allows you to automatically connect to a PPPoE network for a more convenient online experience.

1.1.4 ASUS Quiet Thermal Solution

ASUS Fan Xpert 2

ASUS Fan Xpert 2 provides customizable settings for a cooler and quieter computing environment. With its Fan Auto Tuning feature, ASUS Fan Xpert 2 automatically detects and tweaks all fan speeds, and provides you with optimized fan settings based on the fans' specifications and positions.

1.1.5 ASUS EZ DIY

ASUS UEFI BIOS (EZ Mode)

ASUS UEFI BIOS, a UEFI compliant architecture, offers the first mouse-controlled intuitive graphical BIOS interface that goes beyond the traditional keyboard-only BIOS controls, providing you with more flexibility, convenience, and easy to navigate EFI BIOS than the traditional BIOS versions. It offers you with dual selectable modes and native support for hard drives larger than 2.2 TB.

ASUS UEFI BIOS includes the following new features:

- F12 BIOS snapshot hotkey
- F3 Shortcut for most accessed information
- ASUS DRAM SPD (Serial Presence Detect) information detecting faulty DIMMs, and helping with difficult POST situations.

1.1.6 Other special features

LucidLogix® Virtu™ MVP

LucidLogix® Virtu™ MVP, with HyperFormance™ Technology, is designed for Intel® processor graphics chip on Windows® 7 and perfectly combines the performance of a discrete graphics card with fast computing iGPU (Integrated Graphics Processing Unit). The newly-designed Virtual Sync eliminates tearing artifacts allowing you to enjoy a smoother gaming experience.

LucidLogix® Virtu™ MVP can also dynamically assign tasks to the best available graphics resource based on power, performance, and system load. With Intel® Quick Sync Video 2.0 technology, it provides 3x faster video conversion of NVIDIA and AMD graphics cards while retaining the graphics cards' high-end 3D rendering and gaming performance. When the discrete graphics cards are not in use, it drastically reduces the power usage, making the system more environmentally friendly.

* LucidLogix Virtu MVP supports Windows® 7 operating system.

** Intel® 2nd/3rd generation Core™ processors support the Intel® Quick Sync Video feature.

ErP Ready

The motherboard is European Union's Energy-related Products (ErP) ready, and ErP requires products to meet certain energy efficiency requirement in regards to energy consumptions. This is in line with ASUS vision of creating environment-friendly and energy-efficient products through product design and innovation to reduce carbon footprint of the product and thus mitigate environmental impacts.

1.2 Motherboard overview

1.2.1 Before you proceed

Take note of the following precautions before you install motherboard components or change any motherboard settings.



-
- Unplug the power cord from the wall socket before touching any component.
 - Before handling components, use a grounded wrist strap or touch a safely grounded object or a metal object, such as the power supply case, to avoid damaging them due to static electricity.
 - Hold components by the edges to avoid touching the ICs on them.
 - Whenever you uninstall any component, place it on a grounded antistatic pad or in the bag that came with the component.
 - Before you install or remove any component, ensure that the ATX power supply is switched off or the power cord is detached from the power supply. Failure to do so may cause severe damage to the motherboard, peripherals, or components.
-

1.2.2 Motherboard layout

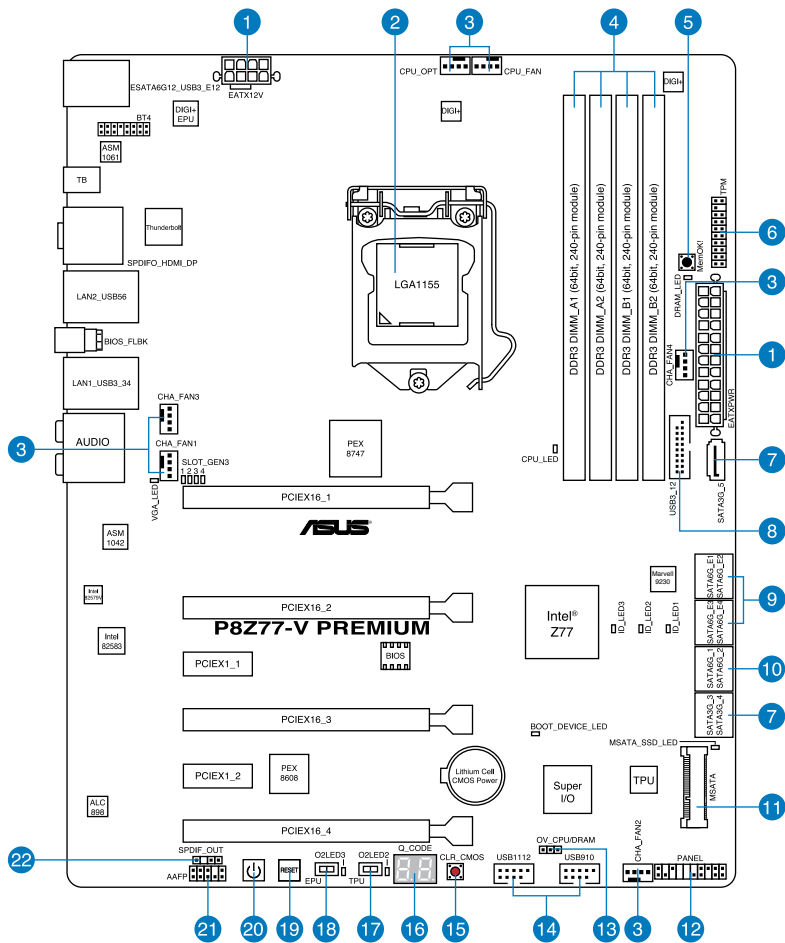

Refer to 1.2.9 Internal connectors and 2.3.1 Rear I/O connection for more information about rear panel connectors and internal connectors.

Layout contents

Connectors/Jumpers/Slots	Page
1. ATX power connectors (24-pin EATXPWR, 8-pin EATX12V)	1-46
2. LGA1155 CPU socket	1-9
3. CPU, chassis, and power fan connectors (4-pin CPU_FAN, 4-pin CPU_OPT, 4-pin CHA_FAN1-4)	1-44
4. DDR3 DIMM slots	1-10
5. MemOK! button	1-27
6. TPM connector (20-1 pin TPM)	1-48
7. Intel® Z77 Serial ATA 3.0 Gb/s connectors (7-pin SATA3G_34/5 [blue])	1-40
8. USB 3.0 connector (20-1 pin USB3_12)	1-42
9. Marvell® Serial ATA 6.0 Gb/s connectors (7-pin SATA6G_E12/E34 [navy blue])	1-41
10. Intel® Z77 Serial ATA 6.0 Gb/s connectors (7-pin SATA6G_1/2 [gray])	1-39
11. MSATA connector with 32GB SSD onboard (56-pin MSATA)	1-48
12. System panel connector (20-8 pin PANEL)	1-47
13. CPU/DRAM overvoltage setting (3-pin OV_CPU/DRAM)	1-31
14. USB 2.0 connectors (10-1 pin USB910, USB1112)	1-43
15. Clear CMOS button	1-30
16. Q-Code LEDs (LED1, LED2)	1-33
17. TPU switch	1-28
18. EPU switch	1-29
19. Reset button	1-26
20. Power on button	1-26
21. Front panel audio connector (10-1 pin AAFP)	1-45
22. Digital audio connector (4-1 pin SPDIF_OUT)	1-42

1.2.3 Central Processing Unit (CPU)

The motherboard comes with a surface mount LGA1155 socket designed for the Intel® 3rd/2nd Generation Core™ i7 / Core™ i5 / Core™ i3, Pentium™ and Celeron™ processors.

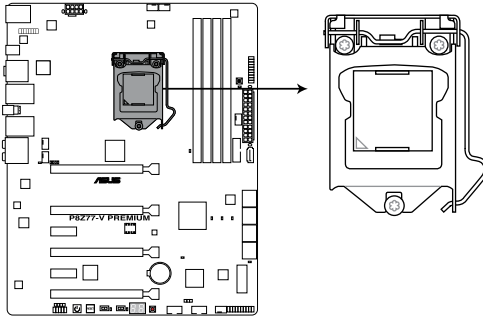

P8Z77-V PREMIUM CPU LGA1155



- Ensure that all power cables are unplugged before installing the CPU.
- The LGA1156 CPU is incompatible with the LGA1155 socket. DO NOT install a LGA1156 CPU on the LGA1155 socket.
- Upon purchase of the motherboard, ensure that the PnP cap is on the socket and the socket contacts are not bent. Contact your retailer immediately if the PnP cap is missing, or if you see any damage to the PnP cap/socket contacts/motherboard components. ASUS will shoulder the cost of repair only if the damage is shipment/transit-related.
- Keep the cap after installing the motherboard. ASUS will process Return Merchandise Authorization (RMA) requests only if the motherboard comes with the cap on the LGA1155 socket.
- The product warranty does not cover damage to the socket contacts resulting from incorrect CPU installation/removal, or misplacement/loss/incorrect removal of the PnP cap.

1.2.4 System memory

The motherboard comes with four Double Data Rate 3 (DDR3) Dual Inline Memory Modules (DIMM) slots.



A DDR3 module is notched differently from a DDR or DDR2 module. DO NOT install a DDR or DDR2 memory module to the DDR3 slot.

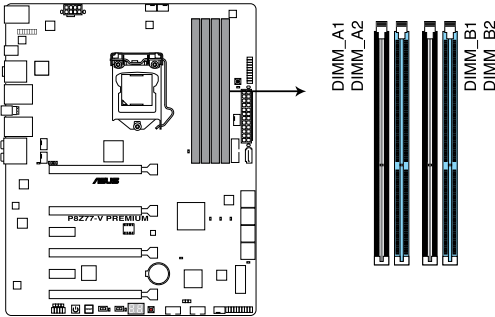

P8Z77-V PREMIUM 240-pin DDR3 DIMM socket

Recommended memory configurations

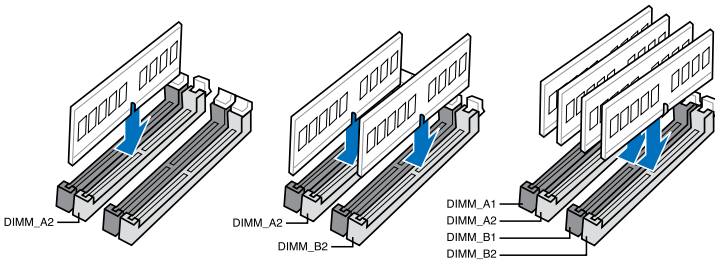

Memory configurations

You may install 1GB, 2GB, 4GB and 8GB unbuffered and non-ECC DDR3 DIMMs into the DIMM sockets.



-
- You may install varying memory sizes in Channel A and Channel B. The system maps the total size of the lower-sized channel for the dual-channel configuration. Any excess memory from the higher-sized channel is then mapped for single-channel operation.
 - Due to Intel® 2nd generation processors' behavior, DDR3 2200 and above, 2000/1800 MHz memory module will run at DDR3 2133/1866/1600 MHz frequency as default.
 - According to Intel CPU spec, DIMM voltage below 1.65V is recommended to protect the CPU.
 - Always install DIMMs with the same CAS latency. For optimum compatibility, we recommend that you obtain memory modules from the same vendor.
 - Due to the memory address limitation on 32-bit Windows OS, when you install 4GB or more memory on the motherboard, the actual usable memory for the OS can be about 3GB or less. For effective use of memory, we recommend that you do any of the following:
 - a) Use a maximum of 3GB system memory if you are using a 32-bit Windows OS.
 - b) Install a 64-bit Windows OS when you want to install 4GB or more on the motherboard.
 - c) For more details, refer to the Microsoft® support site at <http://support.microsoft.com/kb/929605/en-us>.
 - This motherboard does not support DIMMs made up of 512Mb (64MB) chips or less (Memory chip capacity counts in Megabit, 8 Megabit/Mb = 1 Megabyte/MB).
-



-
- The default memory operation frequency is dependent on its Serial Presence Detect (SPD), which is the standard way of accessing information from a memory module. Under the default state, some memory modules for overclocking may operate at a lower frequency than the vendor-marked value. To operate at the vendor-marked or at a higher frequency, refer to section 3.4 Ai Tweaker menu for manual memory frequency adjustment.
 - For system stability, use a more efficient memory cooling system to support a full memory load (4 DIMMs) or overclocking condition.
 - Memory modules with memory frequency higher than 2133MHz and their corresponding timing or the loaded XMP profile is not the JEDEC memory standard. The stability and compatibility of the memory modules depend on the CPU's capabilities and other installed devices.
 - Always install the DIMMs with the same CAS Latency. For an optimum compatibility, we recommend that you install memory modules of the same version or data code (D/C) from the same vendor. Check with the vendor to get the correct memory modules.
-

P8Z77-V PREMIUM Motherboard Qualified Vendors Lists (QVL)

DDR3 2800(O.C.) MHz capability

Vendors	Part No.	Size	SS/DS	Chip Brand	Chip NO.	Timing	Voltage	DIMM socket support (Optional)		
								1	2	4
G.skill	F3-2800CL11Q-16GBZHD	16GB (4x4GB)	DS	-	-	11-13-13-35	1.65	•	•	•

* The 2800MHz memory modules above are supported on Intel® 3rd generation processors by this motherboard; however, the actual frequency support varied depending on the O.C. margin of the installed CPU.

** Due to Intel 2nd generation processors' behavior, DDR3 2200 and above/2000/1800 MHz memory module runs as DDR3 2133/1866/1600 MHz frequency as default.

DDR3 2666(O.C.) MHz capability

Vendors	Part No.	Size	SS/DS	Chip Brand	Chip NO.	Timing	Voltage	DIMM socket support (Optional)		
								1	2	4
G.skill	F3-2666CL10Q-16GBZHD	16GB(4x4GB)	DS	-	-	10-12-12-31	1.65	•	•	•

* The 2666MHz memory modules above are supported on Intel® 3rd generation processors by this motherboard; however, the actual frequency support varied depending on the O.C. margin of the installed CPU.

** Due to Intel 2nd generation processors' behavior, DDR3 2200 and above/2000/1800 MHz memory module runs as DDR3 2133/1866/1600 MHz frequency as default.

DDR3 2600(O.C.) MHz capability

Vendors	Part No.	Size	SS/DS	Chip Brand	Chip NO.	Timing	Voltage	DIMM socket support (Optional)		
								1	2	4
G.skill	F3-2080CL10-16GBZMD(XMP)	16GB(4x4GB)	DS	-	-	10-12-12-28	1.65	•	•	•
G.skill	F3-2600CL11Q-32GBZHD	32GB(4x8GB)	DS	-	-	11-13-13-35	1.65	•	•	•

* The 2600MHz memory modules above are supported on Intel® 3rd generation processors by this motherboard; however, the actual frequency support varied depending on the O.C. margin of the installed CPU.

** Due to Intel 2nd generation processors' behavior, DDR3 2200 and above/2000/1800 MHz memory module runs as DDR3 2133/1866/1600 MHz frequency as default.

DDR3 2500(O.C.) MHz capability

Vendors	Part No.	Size	SS/DS	Chip Brand	Chip NO.	Timing	Voltage	DIMM socket support (Optional)		
								1	2	4
G.Skill	F3-2000CL10Q-16GBZHD(XMP)	16GB (4x4GB)	DS	-	-	10-11-11-31	1.65	•	•	•

* The 2500MHz memory modules above are supported on Intel® 3rd generation processors by this motherboard; however, the actual frequency support varied depending on the O.C. margin of the installed CPU.

** Due to Intel 2nd generation processors' behavior, DDR3 2200 and above/2000/1800 MHz memory module runs as DDR3 2133/1866/1600 MHz frequency as default.

DDR3 2400(O.C.) MHz capability

Vendors	Part No.	Size	SS/DS	Chip Brand	Chip NO.	Timing	Voltage	DIMM socket support (Optional)		
								1	2	4
CORSAIR	CMGTX3(XMP)	2GB	DS	-	-	9-11-9-27	1.65	•	•	
G.SKILL	F3-19200CL10Q-32GBZHDXMP)	32GB (4x8GB)	DS	-	-	10-12-12-31	1.65	•	•	•
G.SKILL	F3-19200CL11Q-16GBZHDXMP)	16GB (4x4GB)	DS	-	-	11-11-11-31	1.65		•	•
G.SKILL	F3-19200CL9D-4GBPIS(XMP)	4G (2x2G)	DS	-	-	9-11-9-28	1.65	•	•	
G.SKILL	F3-19200CL9Q-16GBZMD(XMP)	16GB (4x4GB)	DS	-	-	9-11-11-31	1.65	•	•	•
GEIL	GOC316GB2400C10QC(XMP)	16GB (4x4GB)	DS	-	-	10-11-11-30	1.65	•	•	•
GEIL	GOC316GB2400C11QC(XMP)	16GB (4x4GB)	DS	-	-	11-11-11-30	1.65	•		
Kingston	KHX2400C11D3K4/8GX(XMP)	8GB (4x2GB)	SS	-	-	11-13-11-30	1.65	•		
Patriot	PVV34G2400C9K(XMP)	4GB (2x2GB)	DS	-	-	9-11-9-27	1.66		•	•
Transcend	TX2400KLU-4GK (381850)(XMP)	2GB	DS	-	-	-	1.65	•		•

* The 2400MHz memory modules above are supported on Intel® 3rd generation processors by this motherboard; however, the actual frequency support varied depending on the O.C. margin of the installed CPU.

** Due to Intel 2nd generation processors' behavior, DDR3 2200 and above/2000/1800 MHz memory module runs at DDR3 2133/1866/1600 MHz frequency as default.

DDR3 2200(O.C.) MHz capability

Vendors	Part No.	Size	SS/DS	Chip Brand	Chip No.	Timing	Voltage	DIMM socket support (Optional)		
								1	2	4
G.SKILL	F3-17600CL7D-4GBFLS(XMP)	4G (2x 2G)	DS	-	-	7-10-10-28	1.65	•	•	
GEIL	GET34GB2200C9DC(XMP)	4GB (2x 2GB)	DS	-	-	9-10-9-28	1.65	•	•	
GEIL	GET38GB2200C9ADC(XMP)	8GB (2x 4GB)	DS	-	-	9-11-9-28	1.65	•	•	•
KINGMAX	FLKE85F-B8KJAA-FEIS(XMP)	4GB (2x 2GB)	DS	Kingmax	N/A	-	-	•	•	

* The 2200MHz memory modules above are supported on Intel® 3rd generation processors by this motherboard; however, the actual frequency support varied depending on the O.C. margin of the installed CPU.

** Due to Intel 2nd generation processors' behavior, DDR3 2200 and above/2000/1800 MHz memory module runs at DDR3 2133/1866/1600 MHz frequency as default.

DDR3 2133(O.C.) MHz capability

Vendors	Part No.	Size	SS/ DS	Chip Brand	Chip NO.	Timing	Voltage	DIMM socket support (Optional)		
								1	2	4
A-DATA	AX3U2133C2G9B(XMP)	2GB	SS	-	-	9-11-9-27	1.55-1.75	•	•	
A-DATA	AX3U2133GC2G9B(XMP)	2GB	SS	-	-	9-9-9-24	1.55-1.75	•	•	
A-DATA	AX3U2133GC4G9B(XMP)	16GB (4x4GB)	DS	-	-	9-11-9-27	1.65	•	•	•
Apacer	78.BAGE4.AFD0C(XMP)	8GB (2x4GB)	DS	-	-	9-9-9-24	-	•	•	•
CORSAIR	CMT4GX3M2A2133C9(XMP)	4GB (2x2GB)	DS	-	-	9-10-9-24	1.65	•	•	•
CORSAIR	CMT4GX3M2B2133C9(Ver 7.1)(XMP)	4GB (2x2GB)	DS	-	-	9-9-9-24	1.5		•	•
CORSAIR	CMT4GX3M2B2133C9(XMP)	4GB (2x2GB)	DS	-	-	9-10-9-27	1.5	•	•	
G.SKILL	F3-17000CL11Q2-64GBZLD(XMP)	64GB (8x8GB)	DS	-	-	11-11-11-30	1.5	•	•	•
G.SKILL	F3-17000CL9Q-16GBXLD(XMP)	16GB (4x4GB)	DS	-	-	9-11-9-28	1.65	•	•	•
G.SKILL	F3-17000CL9Q-16GBZH(XMP)	16GB (4x4GB)	DS	-	-	9-11-10-28	1.65	•	•	•
G.SKILL	F3-17066CL9D-8GBPID(XMP)	8GB (2x4GB)	DS	-	-	9-9-9-24	1.65	•	•	•
G.SKILL	F3-17066CL9Q-16GBTDD(XMP)	16GB (4x4GB)	DS	-	-	9-9-9-24	1.65	•		
KINGSTON	KHX2133C11D3K4/16GX(XMP)	16GB (4x4GB)	DS	-	-	11-12-11-30	1.65	•	•	
OCZ	OCZ3XTEP2133C9LV4GK	2GB	DS	-	-	7-7-7-20	1.65	•	•	
Patriot	PVV34G2133C9K(XMP)	4GB (2x2GB)	DS	-	-	9-11-9-27	1.66	•	•	•

DDR3 2000(O.C.) MHz capability

Vendors	Part No.	Size	SS/ DS	Chip Brand	Chip No.	Timing	Voltage	DIMM socket support (Optional)		
								1	2	4
A-DATA	AX3U2000GB2G9B (XMP)	2GB	DS	-	-	9-11-9-27	1.55-1.75	*		
A-DATA	AX3U2000GC4G9B (XMP)	4GB	DS	-	-	9-11-9-27	1.55~1.75	*	*	*
AEXEA	AXA3ES2G2000LG28V (XMP)	2GB	DS	-	-	-	1.65	*	*	*
AEXEA	AXA3ES4GK2000LG28V (XMP)	4GB (2x2GB)	DS	-	-	-	1.65	*	*	*
Apacer	78_AAAGD5.9KD (XMP)	6GB(3x2GB)	DS	-	-	9-9-9-27	-	*	*	
Asint	SLA302G08-ML2HB (XMP)	4GB	DS	Hynix	H5TQ2G83B FRH9C	9-9-9-27	-	*	*	*
CORSAIR	CMT6GX3M3A2000C8 (XMP)	6GB (3x2GB)	DS	-	-	8-9-8-24	1.65	*	*	
CORSAIR	CMZ4GX3M2A2000C10 (Ver 5.12)(XMP)	4GB (2x2GB)	SS	-	-	10-10- 10-27	1.5	*	*	
G.SKILL	F3-16000CL9D-4GBRH (XMP)	4GB(2x2GB)	DS	-	-	9-9-9-24	1.65	*	*	*
G.SKILL	F3-16000CL9D-4GBTD (XMP)	4GB(2x2GB)	DS	-	-	9-9-9-24	1.65	*	*	*
GEIL	GUP34GB2000C9DC (XMP)	4GB (2x2GB)	DS	-	-	9-9-9-28	1.65	*	*	
Gingle	FA3URSS673A801A	2GB	DS	-	-	9-9-9-24	-	*	*	
Patriot	PV736G2000ELK (XMP)	6GB (3x2GB)	DS	-	-	7-7-7-20	1.65	*	*	*
Patriot	PX7312G2000ELK (XMP)	12GB (3x4GB)	DS	-	-	9-11-9-27	1.65	*	*	*
Silicon Power	SP002GBLYU200S02 (XMP)	2GB	DS	-	-	-	-	*	*	*
Team	TXD32048M2000C9 (XMP)	2GB	DS	Team	T3D1288RT- 20	9-9-9-24	1.5	*		
Team	TXD32048M2000C9-L (XMP)	2GB	DS	Team	T3D1288RT- 20	9-9-9-24	1.6	*	*	*
Transcend	TX2000KLN-8GK (388375)(XMP)	4GB	DS	-	-	-	1.6	*	*	

DDR3 1866(O.C.) MHz capability

Vendors	Part No.	Size	SS/ DS	Chip Brand	Chip No.	Timing	Voltage	DIMM socket support (Optional)		
								1	2	4
A-DATA	AX3U1866GC2G9B(XMP)	2GB	SS	-	-	9-11-9-27	1.55~1.75	•	•	
A-DATA	AX3U1866GC4G9B(XMP)	4GB	DS	-	-	9-11-9-27	1.55~1.75	•	•	•
CORSAIR	CMT32GX3M4X1866C9 (Ver3.23)(XMP)	32GB (4x8GB)	DS	-	-	9-10-9-27	1.5	•	•	
CORSAIR	CMZ32GX3M4X1866C 10(Ver3.23)(XMP)	32GB (4x8GB)	DS	-	-	10-11- 10-27	1.5	•	•	•
CORSAIR	CMZ8GX3M2A1866C9 (XMP)	8GB (2x4GB)	DS	-	-	9-10-9-27	1.5	•	•	•
Crucial	BLE4G3D1869DE1XT0 .16FMD(XMP)	4GB	DS	-	-	9-9-9-27	1.5	•	•	•
G.SKILL	F3-14900CL10Q2-64GB ZLD(XMP)	64GB (8x8GB)	DS	-	-	10-11- 10-30	1.5	•	•	•
G.SKILL	F3-14900CL9D-8GBSR (XMP)	8GB (2x4GB)	DS	-	-	9-10-9-28	1.5	•	•	•
G.SKILL	F3-14900CL9Q-16GBXL (XMP)	16GB (4x4GB)	DS	-	-	9-10-9-28	1.5	•	•	•
G.SKILL	F3-14900CL9Q-16GBZL (XMP)	16GB (4x4GB)	DS	-	-	9-10-9-28	1.5	•	•	•
G.SKILL	F3-14900CL9Q-8GBFLD (XMP)	8GB (2x4GB)	DS	-	-	9-9-9-24	1.6	•	•	•
Patriot	PXD34G1866ELK(XMP)	4GB (2x2GB)	SS	-	-	9-9-9-24	1.65	•	•	•
Patriot	PXD38G1866ELK(XMP)	8GB (2x4GB)	DS	-	-	9-11-9-27	1.65	•	•	•
Team	TXD34096M1866HC9K-L (XMP)	4GB	DS	Hynix	H5TC2G8 3BRH9A	9-11-9-27	1.65	•	•	•

DDR3 1800(O.C.) MHz capability

Vendors	Part No.	Size	SS/ DS	Chip Brand	Chip NO.	Timing	Voltage	DIMM socket support (Optional)		
								1	2	4
G.SKILL	F3-14400CL9D-4GBRL(XMP)	4GB(2x2GB)	DS	-	-	9-9-9-24	1.6	•	•	•

DDR3 1600 MHz capability

Vendors	Part No.	Size	SS/ DS	Chip Brand	Chip NO.	Timing	Voltage	DIMM socket support (Optional)		
								1	2	4
A-DATA	AM2U16BC2P1	2GB	SS	A-DATA	3CCD-1509A	-	-	•	•	•
A-DATA	AM2U16BC4P2	4GB	DS	A-DATA	3CCD-1509A	-	-	•	•	•
A-DATA	AX3U1600PC4G8(XMP)	4GB	DS	-	-	8-8-8-24	1.55~ 1.75	•	•	•
AEXEA	AXA3PS2G1600S18V (XMP)	2GB	DS	-	-	-	1.65	•		
Asint	SLA302G08-EGG1C (XMP)	4GB	DS	Asint	302G08-GG1C	9-9-9-27	-	•	•	•
Asint	SLA302G08-EGJ1C (XMP)	4GB	DS	Asint	302G08-GJ1C	9-9-9-27	-	•	•	•
Asint	SLZ3128M8-EGJ1D (XMP)	2GB	DS	Asint	3128M8-GJ1D	-	-	•	•	•
ATP	AQ12M64B8BK0S	4GB	DS	SAMSUNG	K4B2G08460	-	NO	•	•	•
CORSAIR	CMG4GX3M2A1600C6	4GB (2x 2GB)	DS	-	-	6-6-6-18	1.65	•	•	•
CORSAIR	CML16GX3M4X1600C8 (Ver 2.12)(XMP)	16GB (4x 4GB)	DS	-	-	Heat-Sink Package	1.5	•	•	•
CORSAIR	CMP6GX3M3A1600C8 (XMP)	6GB (3x 2GB)	DS	-	-	8-8-8-24	1.65	•	•	•
CORSAIR	CMP6GX3M3A1600C8 (XMP)	6GB (3x 2GB)	DS	-	-	8-8-8-24	1.65	•	•	•
CORSAIR	CMX6GX3M3C1600C7 (XMP)	6GB (3x 2GB)	DS	-	-	7-8-7-20	1.65	•	•	•
CORSAIR	CMZ32GX3M4X1600C10 (Ver2.2)(XMP)	32GB (4x 8GB)	DS	-	-	10-10- 10-27	1.5	•	•	•
CORSAIR	CMZ8GX3M2A1600C8 (XMP)	8GB (2x 4GB)	DS	-	-	8-8-8-24	1.5	•	•	•
CORSAIR	CMZ8GX3M2A1600C9 (XMP)	8GB (2x 4GB)	DS	-	-	9-9-9-24	1.5	•	•	•
CORSAIR	HX3X12G1600C9(XMP)	12GB (6x 2GB)	DS	-	-	9-9-9-24	1.6	•	•	•
Crucial	BL12864BN1608.8FF (XMP)	2GB(2x 1GB)	SS	-	-	8-8-8-24	1.65	•	•	•
Crucial	BLT4G3D1608DT1TX0. 16FM (XMP)	4GB	DS	-	-	8-8-8-24	1.5	•	•	•
EK Memory	EKM324L28BP8- 116(XMP)	4GB(2x 2GB)	DS	-	-	9	-	•	•	•
Elixir	M2X4G64CB8HG5N-DG (XMP)	4GB	DS	Elixir	N2CB2G80GN- DG	9-9-9-28	-	•	•	•
G.SKILL	F3-12800CL7D-8GBRH (XMP)	8GB (2x 4GB)	DS	-	-	7-8-7-24	1.6	•	•	•
G.SKILL	F3-12800CL7Q-16GBXH (XMP)	16GB (4x 4GB)	DS	-	-	7-8-7-24	1.6	•	•	•
G.SKILL	F3-12800CL8D- 8GBECO (XMP)	8GB (2x4GB)	DS	-	-	8-8-8-24	1.35	•	•	•

(continued on the next page)

DDR3 1600 MHz capability

Vendors	Part No.	Size	SS/DS	Chip Brand	Chip No.	Timing	Voltage	DIMM socket support (Optional)		
								1	2	4
G.SKILL	F3-12800CL9D-8GBRL (XMP)	8GB (2x 4GB)	DS	-	-	9-9-9-24	1.5	*	*	*
G.SKILL	F3-12800CL9D-8GBSR2 (XMP)	8GB (2x 4GB)	DS	-	-	9-9-9-24	1.25	*	*	*
G.SKILL	F3-12800CL9Q-16GBXL (XMP)	16GB (4x 4GB)	DS	-	-	9-9-9-24	1.5	*	*	*
G.Skill	F3-12800CL9Q-16GBZL (XMP)	16GB (4x 4GB)	DS	-	-	9-9-9-24	1.5	*	*	*
GEIL	GET316GB1600C9QC (XMP)	16GB (4x 4GB)	DS	-	-	9-9-9-28	1.6	*	*	*
GEIL	GUP34GB1600C7DC (XMP)	4GB (2x 2GB)	DS	-	-	7-7-7-24	1.6	*	*	*
GoodRam	GR1600D364L9/2G	2GB	DS	GoodRam	GF1008KC-JN	-	-	*	*	*
KINGMAX	FLGE85F-C8KL9A (XMP)	2GB	SS	KINGMAX	N/A	9-9-9-28	-	*	*	*
KINGMAX	FLGF65F-C8KL9A (XMP)	4GB	DS	KINGMAX	N/A	9-9-9-28	-	*	*	*
KINGSTON	KHX1600C9D3K2/4GX (XMP)	4GB (2x 2GB)	DS	-	-	-	1.65	*	*	*
KINGSTON	KHX1600C9D3K3/12GX (XMP)	12GB (3x 4GB)	DS	-	-	9	1.65	*	*	*
KINGSTON	KHX1600C9D3K3/12GX (XMP)	12GB (3x 4GB)	DS	-	-	-	1.65	*	*	*
KINGSTON	KHX1600C9D3K3/6GX (XMP)	6GB (3x 2GB)	DS	-	-	9	1.65	*	*	*
KINGSTON	KHX1600C9D3K3/6GX (XMP)	6GB (3x 2GB)	DS	-	-	9	1.65	*	*	*
KINGSTON	KHX1600C9D3K6/24GX (XMP)	24GB (6x 4GB)	DS	-	-	9	1.65	*	*	*
Kingston	KHX1600C9D3K8/32GX (XMP)	32GB (8x 4GB)	DS	-	-	9-9-9-27	1.65	*	*	*
KINGSTON	KHX1600C9D3LK2/4GX (XMP)	4GB (2x 2GB)	DS	-	-	-	1.35	*	*	*
KINGSTON	KHX1600C9D3P1K2/8G	8GB (2x 4GB)	DS	-	-	9	1.5	*	*	*
KINGSTON	KHX1600C9D3T1BK3/12GX (XMP)	12GB (3x 4GB)	DS	-	-	9	1.65	*	*	*
KINGSTON	KHX1600C9D3T1K3/6GX (XMP)	6GB (3x 2GB)	DS	-	-	9	1.65	*	*	*
KINGSTON	KHX1600C9D3X2K2/4GX (XMP)	4GB (2x 2GB)	DS	-	-	9	1.65	*	*	*
KINGTIGER	KTG2G1600PG3(XMP)	2GB	DS	-	-	-	-	*	*	*

(continued on the next page)

DDR3 1600 MHz capability

Vendors	Part No.	Size	SS/ DS	Chip Brand	Chip No.	Timing	Voltage	DIMM socket support (Optional)		
								1	2	4
Mushkin	998805(XMP)	6GB (3x 2GB)	DS	-	-	6-8-6-24	1.65	•	•	•
OCZ	OCZ3BE1600C8LV 4GK	4GB (2x 2GB)	DS	-	-	8-8-8	1.65	•	•	
Patriot	AE32G1609U1-U	2GB	SS	AMD	23EY4587MB6H	-	1.5	•	•	•
Patriot	AE34G1609U2-U	4GB	DS	AMD	23EY4587MB6H	-	1.5	•	•	•
Patriot	PGS34G1600LLKA2	4GB (2x 2GB)	DS	-	-	8-8-8-24	1.7	•	•	•
Patriot	PVV38G1600LLK (XMP)	8GB (2x 4GB)	DS	-	-	8-9-8-24	1.65	•	•	•
Patriot	PX7312G1600LLK (XMP)	12GB (3x 4GB)	DS	-	-	8-9-8-24	1.65	•	•	•
SanMax	SMD-4G68NG-16KK	4GB	DS	ELPIDA	J2108BDBG- GN-F	-	-	•	•	•
Team	TXD31024M1600C 8-D(XMP)	1GB	SS	Team	T3D1288RT-16	8-8-8-24	1.65	•	•	•
Team	TXD32048M1600C7- L(XMP)	2GB	DS	Team	T3D1288LT-16	7-7-7-24	1.65	•	•	
Team	TXD32048M1600H C8-D(XMP)	2GB	DS	Team	T3D1288RT-16	8-8-8-24	1.65	•	•	•
Transcend	JM1600KLN-8GK	8GB (2x 4GB)	DS	Transcend	TK483PCW3	-	-	•	•	•
Transcend	TS256MLK64V6N	2GB	SS	Transcend	K4B2G0846C	-	-	•	•	•
Transcend	TS512MLK64V6N	4GB	DS	Transcend	K4B2G0846C	-	-	•	•	•

DDR3 1333 MHz capability

Vendors	Part No.	Size	SS/ DS	Chip Brand	Chip No.	Timing	Voltage	DIMM socket support (Optional)		
								1	2	4
A-DATA	AD6311B0823EV	2GB	SS	A-DATA	3CCA-1509A	-	-	*	*	*
A-DATA	AXDU1333GC2G9 (XMP)	2GB	SS	-	-	9-9-9-24	1.25- 1.35	*	*	*
A-DATA	AD6311C1624EV	4GB	DS	A-DATA	3CCA-1509A	-	-	*	*	*
A-DATA	SU3U1333W8G9 (XMP)	8GB	DS	ELPIDA	J4208BASE-DJ-F	-	-	*	*	*
Apacer	78.A1GC6.9L1	2GB	DS	Apacer	AM5D5808FEQSBG	9	-	*	*	*
Apacer	78.B1GDE.9L10C	4GB	DS	Apacer	AM5D5908CEHSBG	9	-	*	*	*
CORSAIR	TW3X4G1333C9A	4GB (2x 2GB)	DS	-	-	9-9-9-24	1.5	*	*	
CORSAIR	CMX8GX3M2A13 33C9(XMP)	8GB (2x 4GB)	DS	-	-	9-9-9-24	1.5	*	*	*
G.SKILL	F3-10600CL9D-4G BNT	4GB (2x 2GB)	DS	G.SKILL	D3 128M8CE9 2GB	9-9-9-24	1.5	*	*	*
G.SKILL	F3-10666CL9D-8G BRL	8GB (2x 4GB)	DS	-	-	9-9-9-24	1.5	*	*	*
G.SKILL	F3-10666CL9D-8G BRL	8GB (2x 4GB)	DS	-	-	9-9-9-24	1.5	*	*	*
G.SKILL	F3-10666CL9D-8G BXL	8GB (2x 4GB)	DS	-	-	9-9-9-24	1.5	*	*	*
GEIL	GET316GB1333C 9QC	16GB (4x 4GB)	DS	-	-	9-9-9-24	1.5	*	*	*
GEIL	GG34GB1333C9 DC	4GB (2x 2GB)	DS	GEIL	L1L128M88BA11 5FW	9-9-9-24	1.3	*	*	*
GEIL	GG34GB1333C9 DC	4GB (2x 2GB)	DS	GEIL	GL1L128M88BA15B	9-9-9-24	1.3	*	*	*
GEIL	GVP34GB1333C9 DC	4GB (2x 2GB)	DS	-	-	9-9-9-24	1.5	*	*	*
GEIL	GB34GB1333C7 DC	4GB(2 x 2GB)	DS	GEIL	GL1L128M88BA15FW	7-7-7-24	1.5	*	*	*
GEIL	GVP38GB1333C9 DC	8GB (2x 4GB)	DS	-	-	9-9-9-24	1.5	*	*	*
GEIL	GVP38GB1333C 7QC	8GB (4x 2GB)	DS	-	-	7-7-7-24	1.5	*	*	*
Hynix	HMT125U6TFR8 A-H9	2GB	DS	Hynix	H5TC1G83TFR	-	-	*	*	*
KINGMAX	FLFE85F-C8KL9	2GB	SS	KINGMAX	KFC8FNLF-BF-GXX- 12A	-	-	*	*	*
KINGMAX	FLFE85F-C8KL9	2GB	SS	KINGMAX	KFC8FNLF-BF-DXX- 15A	-	-	*	*	*
KINGMAX	FLFE85F-C8KM9	2GB	SS	Kingmax	KFC8FNMF-BF-BXX- 15A	-	-	*	*	*
KINGMAX	FLFE85F-B8KL9	2GB	DS	KINGMAX	KFB8FNLF-BF-BNF- 15A	-	-	*	*	*
KINGMAX	FLFF65F-C8KL9	4GB	DS	KINGMAX	KFC8FNLF-BF-GXX- 12A	-	-	*	*	*
KINGMAX	FLFF65F-C8KL9	4GB	DS	KINGMAX	KFC8FNLF-BF-DXX- 15A	-	-	*	*	*

(continued on the next page)

DDR3 1333 MHz capability

Vendors	Part No.	Size	SS/ DS	Chip Brand	Chip No.	Timing	Voltage	DIMM socket support (Optional)		
								1	2	4
KINGMAX	FLFF65F-C8KM9	4GB	DS	Kingmax	KFC8FNMXF-BXX-15A	-	-	*	*	*
KINGSTON	KVR1333D3S8N9/2G	2GB	SS	Micron	IFD77 D9LGK	-	1.5	*	*	*
KINGSTON	KVR1333D3N9/2G	2GB	DS	Kingston	D1288JPNPLD9U	9	1.5	*	*	*
KINGSTON	KVR1333D3N9K2/4G	4GB (2x 2GB)	DS	KINGSTON	D1288JEMFPGD9U	-	1.5	*	*	*
KINGSTON	KVR1333D3E9S/4G	4GB	DS	Elpida	J2108ECSE-DJ-F	9	1.5	*	*	*
MICRON	MT8JTF25664AZ-1 G4M1	2GB	SS	MICRON	D9PFI	-	-	*	*	*
OCZ	OCZ3G1333LV4GK	4GB (2x 2GB)	DS	-	-	9-9-9	1.65	*	*	
OCZ	OCZ3G1333LV8GK	8GB (2x 4GB)	DS	-	-	9-9-9	1.65	*	*	*
OCZ	OCZ3G1333LV8GK	8GB (2x 4GB)	DS	-	-	9-9-9	1.65	*	*	
OCZ	OCZ3RPR1333C9L V8GK	8GB (2x 4GB)	DS	-	-	9-9-9	1.65	*	*	*
SAMSUNG	M378B5673FH0-CH9	2GB	DS	SAMSUNG	K4B1G0846F	-	-	*	*	*
SAMSUNG	M378B5273CH0-CH9	4GB	DS	SAMSUNG	K4B2G0846C		K4B2G0 846C	*	*	*
SAMSUNG	M378B1G73AH0-CH9	8GB	DS	SAMSUNG	K4B4G0846A-HCH9	-	-	*	*	*
Transcend	JM1333KLN-2G (582670)	2GB	SS	Micron	ICD77 C9LGK	-	-	*	*	*
Transcend	JM1333KLN-2G	2GB	SS	Transcend	TK483PCW3	-	-	*	*	*
Transcend	TS256MLK64V3N (585 541)	2GB	SS	Micron	ICD77 D9LGK	9	-	*	*	*
Transcend	TS256MLK64V3N (566577)	2GB	SS	Hynix	H5TQ2G83BFR	9	-	*	*	*
Transcend	TS256MLK64V3N (574206)	2GB	SS	Micron	D9LGK	9	-	*	*	*
Transcend	JM1333KLN-4G (583782)	4GB	DS	Transcend	TK483PCW3	9	-	*	*	*
Transcend	JM1333KLN-4G	4GB	DS	Transcend	TK483PCW3	-	-	*	*	*
Transcend	TS512MLK64V3N (574831)	4GB	DS	Micron	D9LGK	9	-	*	*	*
Transcend	TS1GLK64V3H	8GB	DS	MICRON	D9PBC	-	-	*	*	*
ACTICA	ACT1GHU64B8F 1333S	1GB	SS	SAMSUNG	K4B1G0846F	-	-	*	*	*
ACTICA	ACT1GHU72C8G 1333S	1GB	SS	SAMSUNG	K4B1G0846F(ECC)	-	-	*	*	*

(continued on the next page)

DDR3 1333 MHz capability

Vendors	Part No.	Size	SS/DS	Chip Brand	Chip No.	Timing	Voltage	DIMM socket support (Optional)		
								1	2	4
ACTICA	ACT2GHU64B8G 1333M	2GB	DS	Micron	D9KPT	-	-	*	*	*
ACTICA	ACT2GHU64B8G 1333S	2GB	DS	SAMSUNG	K4B1G0846F	-	-	*	*	*
ACTICA	ACT2GHU72D8G 1333M	2GB	DS	Micron	D9KPT(ECC)	-	-	*	*	*
ACTICA	ACT2GHU72D8G 1333S	2GB	DS	SAMSUNG	K4B1G0846F(ECC)	-	-	*	*	*
ACTICA	ACT4GHU64B8H1 333H	4GB	DS	Hynix	H5TQ2G83AFR	-	-	*	*	*
ACTICA	ACT4GHU72D8H 1333H	4GB	DS	Hynix	H5TQ2G83AFR(ECC)	-	-	*	*	*
ATP	AQ56M72E8BJH 9S	2GB	DS	SAMSUNG	K4B1G0846F(ECC)	-	-	*	*	*
ATP	AQ12M72E8BKH 9S	4GB	DS	SAMSUNG	K4B2G0846C(ECC)	-	-	*	*	*
BUFFALO	D3U1333-1G	1GB	SS	Elpida	J1108BFBG-DJ-F	-	-	*	*	*
BUFFALO	D3U1333-2G	2GB	DS	Elpida	J1108BFBG-DJ-F	-	-	*	*	*
BUFFALO	D3U1333-4G	4GB	DS	NANYA	NT5CB256M8BN-CG	-	-	*	*	*
EK Memory	EKM324L28BP8-I 13	4GB(2x 2GB)	DS	-	-	9	-	*	*	*
Elixir	M2F2G64CB88B 7N-CG	2GB	SS	Elixir	N2CB2G808N-CG	-	-	*	*	*
Elixir	M2F2G64CB88D7 N-CG	2GB	SS	Elixir	M2CB2G8BDN-CG	-	-	*	*	*
Elixir	M2F4G64CB8HB5 N-CG	4GB	DS	Elixir	N2CB2G808N-CG	-	-	*	*	*
GoodRam	GR1333D364L9/2G	2GB	DS	Qimonda	IDS1H1G-03A1F1C -13H	-	-	*	*	*
KINGTIGER	F10DA2T1680	2GB	DS	KINGTIGER	KTG1333PS1208N ST-C9	-	-	*	*	*
KINGTIGER	KTG2G1333PG3	2GB	DS	-	-	-	-	*	*	*
Mach Xtreme	MXD3V13332GS	2GB	SS	Mach Xtreme	C2S46D30-D313	-	-	*	*	*
Mach Xtreme	MXD3U133316GQ	16GB (4x 4GB)	DS	-	-	-	-	*	*	*
Patriot	AE32G1339U1-U	2GB	SS	AMD	23EY4587MB3H	-	1.5	*	*	*
Patriot	PGD316G1333EL K(XMP)	16GB (2x 8GB)	DS	-	-	9-9-9- 24	1.5	*	*	*
Patriot	PSD32G13332	2GB	DS	Partriot	PM128M8D3BU-15	9	-	*	*	*
Patriot	PGS34G1333LLKA	4GB(2 x 2GB)	DS	-	-	7-7-7- 20	1.7	*	*	*

(continued on the next page)

DDR3 1333 MHz capability

Vendors	Part No.	Size	SS/ DS	Chip Brand	Chip No.	Timing	Voltage	DIMM socket support (Optional)		
								1	2	4
Patriot	AE34G1339U2-U	4GB	DS	AMD	23EY4587MB3H	-	1.5	*	*	*
Patriot	PG38G1333EL (XMP)	8GB	DS	-	-	-	1.5	*	*	*
RiDATA	C304627CB1AG2 2Fe	2GB	DS	RiDATA	C304627CB1AG22Fe	9	-	*	*	*
RiDATA	E304459CB1AG3 2Ci	4GB	DS	RiDATA	E304459CB1AG32Ci	9	-	*	*	*
Silicon Power	SP001GBLTE13 3S01	1GB	SS	NANYA	NT5CB128M8AN-CG	-	-	*	*	*
Silicon Power	SP001GBLTU13 3S02	1GB	SS	S-POWER	10YT3E5	9	-	*	*	*
Silicon Power	SP002GBLTE13 3S01	2GB	DS	NANYA	NT5CB128M8AN-CG	-	-	*	*	*
Team	TXD31024M1333 C7(XMP)	1GB	SS	Team	T3D1288LT-13	7-7-7-21	1.75	*	*	*
Team	TXD31048M1333C 7-D(XMP)	1GB	SS	Team	T3D1288LT-13	7-7-7-21	1.75	*	*	*
Team	TXD32048M1333C 7-D(XMP)	2GB	DS	Team	T3D1288LT-13	7-7-7-21	1.5-1.6	*	*	*
Team	TED34096M1333 HC9	4GB	DS	Team	T3D2568LT-13	-	-	*	*	*



Side(s): SS - Single-sided DS - Double-sided DIMM support:

- (1) Supports one (1) module inserted into any slot as Single-channel memory configuration. We suggest that you install the module into A2 slot.
- (2) Supports two (2) modules inserted into either the blue slots or the black slots as one pair of Dual-channel memory configuration. We suggest that you install the modules into slots A2 and B2 for better compatibility.
- (4) Supports four (4) modules inserted into both the blue and black slots as two pairs of Dual-channel memory configuration.



- ASUS exclusively provides hyper DIMM support function.
- Hyper DIMM support is subject to the physical characteristics of individual CPUs. Load the X.M.P. or D.O.C.P. settings in the BIOS for the hyper DIMM support.
- Visit the ASUS website for the latest QVL.

1.2.5 Expansion slots



Unplug the power cord before adding or removing expansion cards. Failure to do so may cause you physical injury and damage motherboard components.

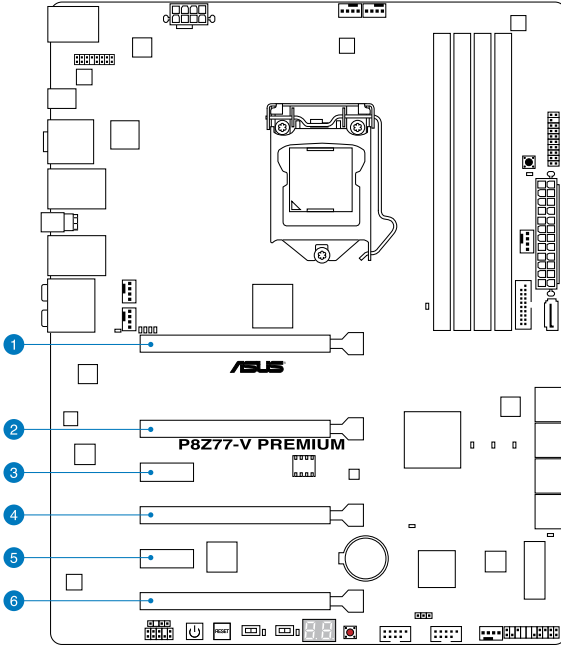

Slot No.	Slot Description
1	PCIe 3.0/2.0 x16_1 slot
2	PCIe 3.0/2.0 x16_2 slot
3	PCIe 2.0 x1_1 slot
4	PCIe 3.0/2.0 x16_3 slot
5	PCIe 2.0 x1_2 slot
6	PCIe 3.0/2.0 x16_4 slot

PCIe Express 3.0 operating mode					
Slot no.	Single VGA	SLI/CrossFireX	3-WAY SLI/ CrossFireX		4-WAY SLI/ CrossFireX
1	x 16 (single VGA recommended)	x16	x8	x16	x8
2			x8		x8
4		x16 (dual VGA recommended)	x16	x8	x8
6				x8	x8



- We recommend that you provide sufficient power when running CrossFire™ or SLI™ mode.
- Connect a chassis fan to the motherboard connector labeled CHA_FAN1-4 when using multiple graphics cards for better thermal environment.
- Intel® 3rd generation Core™ processors support PCIe 3.0 speed rate.

IRQ assignments for this motherboard

	A	B	C	D	E	F	G	H
Intel PCH SATA Controller #0	-	-	-	shared	-	-	-	-
Intel PCH SATA Controller #1	-	-	-	shared	-	-	-	-
SMBUS Controller		-	shared	-	-	-	-	-
EHCI #0	-	-	-	-	-	-	-	shared
EHCI #1	shared	-	-	-	-	-	-	-
PCIE x16_1	-	shared	-	-	-	-	-	-
PCIE x16_2	shared	-	-	-	-	-	-	-
PCIE x16_3	-	shared	-	-	-	-	-	-
PCIE x16_4	shared	-	-	-	-	-	-	-
ASMedia USB 3.0	-	shared	-	-	-	-	-	-
Intel 82579V LAN	-	-	-	-	shared	-	-	-
Intel 82583 LAN	shared	-	-	-	-	-	-	-
PEX 8608 PCIE Bridge	-	-	shared	-	-	-	-	-
ASMedia SATA Controller	-	-	-	shared	-	-	-	-
Marvell 9230 Hardware RAID Controller	shared	-	-	-	-	-	-	-

1.2.6 Onboard buttons and switches

Onboard switches and buttons allow you to fine-tune performance when working on a bare or open-case system. This is ideal for overclockers and gamers who continually change settings to enhance system performance.

1. Power-on button

The motherboard comes with a power-on button that allows you to power up or wake up the system. The button also lights up when the system is plugged to a power source indicating that you should shut down the system and unplug the power cable before removing or installing any motherboard component.

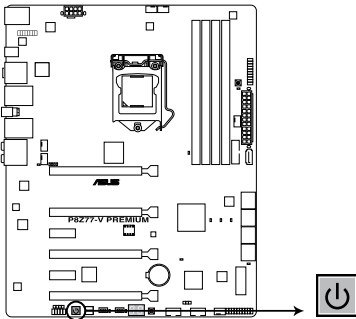

P8Z77-V PREMIUM Power on button

2. Reset button

Press the reset button to reboot the system.

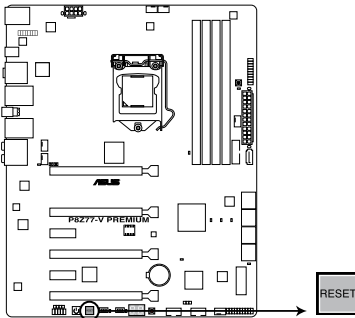

P8Z77-V PREMIUM Reset button

3. MemOK! button

Installing DIMMs that are not compatible with the motherboard may cause system boot failure, and the DRAM_LED near the MemOK! switch lights continuously. Press and hold the MemOK! button until the DRAM_LED starts blinking to begin automatic memory compatibility tuning for successful boot.

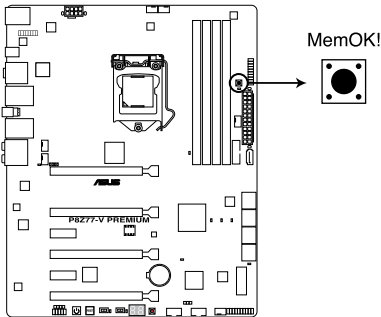

P8Z77-V PREMIUM MemOK! button



- Refer to section **1.2.8 Onboard LEDs** for the exact location of the DRAM_LED.
- The DRAM_LED also lights up when the DIMM is not properly installed. Turn off the system and reinstall the DIMM before using the MemOK! function.
- The MemOK! switch does not function under Windows™ OS environment.
- During the tuning process, the system loads and tests failsafe memory settings. It takes about 30 seconds for the system to test one set of failsafe settings. If the test fails, the system reboots and test the next set of failsafe settings. The blinking speed of the DRAM_LED increases, indicating different test processes.
- Due to memory tuning requirement, the system automatically reboots when each timing set is tested. If the installed DIMMs still fail to boot after the whole tuning process, the DRAM_LED lights continuously. Replace the DIMMs with ones recommended in the Memory QVL (Qualified Vendors Lists) in this user manual or on the ASUS website at www.asus.com.
- If you turn off the computer and replace DIMMs during the tuning process, the system continues memory tuning after turning on the computer. To stop memory tuning, turn off the computer and unplug the power cord for about 5–10 seconds.
- If your system fails to boot up due to BIOS overlocking, press the MemOK! switch to boot and load the BIOS default settings. A message will appear during POST reminding you that the BIOS has been restored to its default settings.
- We recommend that you download and update to the latest BIOS version from the ASUS website at www.asus.com after using the MemOK! function.

4. TPU switch

Enable this switch to automatically optimize the system for fast, yet stable clock speeds.



Enable this switch when the system is powered off.

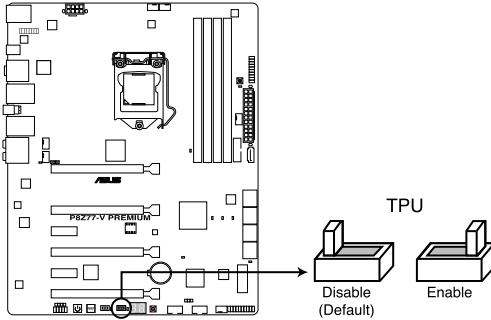

P8Z77-V PREMIUM TPU switch



- The TPU LED (O2LED2) near the TPU switch lights up when the TPU switch is enabled. Refer to section **1.2.8 Onboard LEDs** for the exact location of the TPU LED.
- If you enable this switch under Windows® OS environment, the TPU function will be activated after the next system bootup.
- You may use the TurboV and Auto Tuning feature in the TurboV EVO application, adjust the BIOS setup program, or enable the TPU switch at the same time. However, the system will use the last setting you have made.

5. EPU switch

Enable this switch to automatically detect the current PC loadings and intelligently moderate the power consumption.



Enable this switch when the system is powered off.

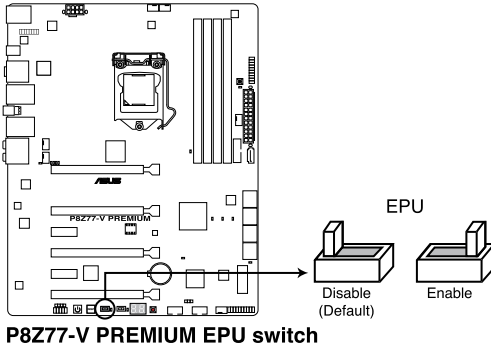

- The EPU LED (O2LED3) near the EPU switch lights up when the EPU switch is enabled.. Refer to section **1.2.8 Onboard LEDs** for the exact location of the EPU LED.
 - If you enable this switch under Windows® OS environment, the EPU function will be activated after the next system bootup.
 - You may change the EPU settings in the software application or BIOS setup program, and enable the EPU function at the same time. However, the system will use the last setting you have made.
-

6. Clear CMOS button

Press this button to clear the BIOS setup information only when the systems hangs due to overclocking.

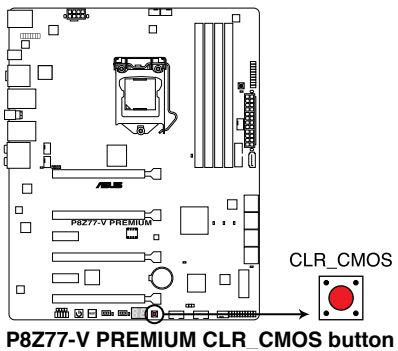

1.2.7 Jumpers

1. CPU / DRAM overvoltage setting (3-pin OV_CPU/DRAM)

This jumper allows you to enable or disable the advanced CPU and DRAM overvoltage settings in BIOS.

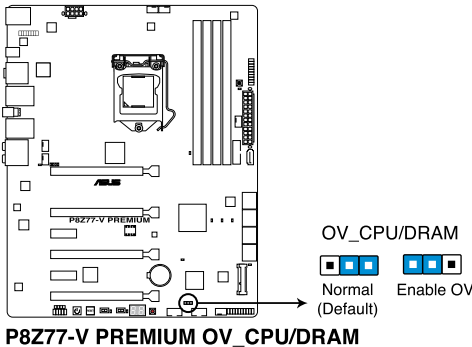

	OV_CPU	OV_DRAM
Pins 1-2 (Default)	0.8V - 1.92V	1.2V - 1.92V
Pins 2-3 (OV Enabled)	0.8V - 2.3V	1.2V - 2.3V



- Before you change the jumper settings for extra-high overvoltage ability, use the BIOS items first to adjust the desired CPU and DRAM performance. Ensure that your system functions well under the highest BIOS voltage settings before you change the settings.
- DO NOT set the OV_CPU/DRAM jumper to pins 2-3 when you install a new CPU and have not booted for the first time. Doing so may halt the system. For system failure due to wrong setting of the OV_CPU/DRAM jumper, shut down your computer and insert the jumper cap back to pins 1-2.
- According to Intel CPU specifications, DIMMs with voltage requirement over 1.65V may damage the CPU permanently. We recommend you to install the DIMMs with the voltage requirement below 1.65V.
- The system may need a better cooling system (for example, a water cooling system) to work efficiently under high voltage settings.

1.2.8 Onboard LEDs

1. POST State LEDs

The POST State LEDs provide the status of these key components during POST (Power-On-Self Test): CPU, memory modules, VGA card, and hard disk drive.s If an error is found, the critical component's LED stays lit up until the problem is solved.

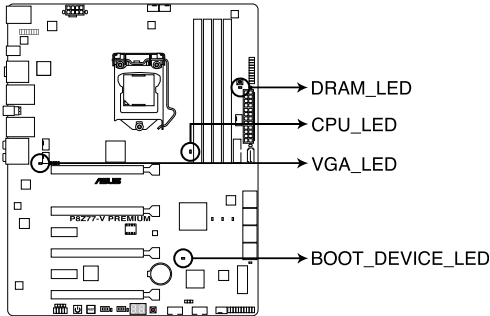

**P8Z77-V PREMIUM CPU/ DRAM/
BOOT_DEVICE/ VGA LED**

2. TPU LED

The TPU LED lights up when the TPU switch is enabled.

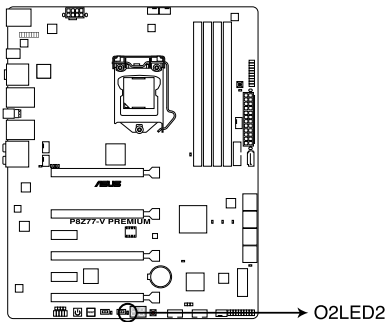

P8Z77-V PREMIUM TPU LED

3. EPU LED

The EPU LED lights up when the EPU switch is enabled.

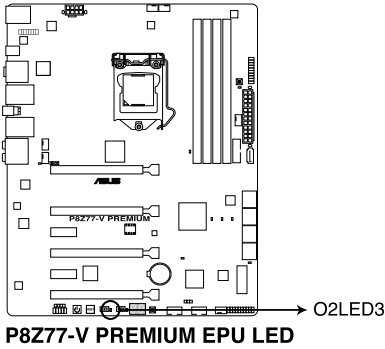

4. Q-Code LEDs

The Q-Code LED design provides you with a 2-digit error code that displays the system status. Refer to the Q-Code table on the next page for details.

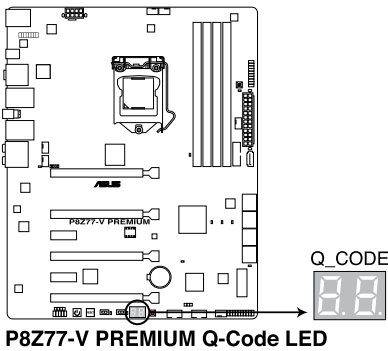

Q-Code table

Code	Description
00	Not used
01	Power on. Reset type detection (soft/hard).
02	AP initialization before microcode loading
03	System Agent initialization before microcode loading
04	PCH initialization before microcode loading
06	Microcode loading
07	AP initialization after microcode loading
08	System Agent initialization after microcode loading
09	PCH initialization after microcode loading
0B	Cache initialization
0C – 0D	Reserved for future AMI SEC error codes
0E	Microcode not found
0F	Microcode not loaded
10	PEI Core is started
11 – 14	Pre-memory CPU initialization is started
15 – 18	Pre-memory System Agent initialization is started
19 – 1C	Pre-memory PCH initialization is started
2B – 2F	Memory initialization
30	Reserved for ASL (see ASL Status Codes section below)
31	Memory Installed
32 – 36	CPU post-memory initialization
37 – 3A	Post-Memory System Agent initialization is started
3B – 3E	Post-Memory PCH initialization is started
4F	DXE IPL is started
50 – 53	Memory initialization error. Invalid memory type or incompatible memory speed
54	Unspecified memory initialization error
55	Memory not installed
56	Invalid CPU type or Speed
57	CPU mismatch
58	CPU self test failed or possible CPU cache error
59	CPU micro-code is not found or micro-code update is failed

(continued on the next page)

Code	Description
5A	Internal CPU error
5B	Reset PPI is not available
5C – 5F	Reserved for future AMI error codes
E0	S3 Resume is started (S3 Resume PPI is called by the DXE IPL)
E1	S3 Boot Script execution
E2	Video repost
E3	OS S3 wake vector call
E4 – E7	Reserved for future AMI progress codes
E8	S3 Resume Failed
E9	S3 Resume PPI not Found
EA	S3 Resume Boot Script Error
EB	S3 OS Wake Error
EC – EF	Reserved for future AMI error codes
F0	Recovery condition triggered by firmware (Auto recovery)
F1	Recovery condition triggered by user (Forced recovery)
F2	Recovery process started
F3	Recovery firmware image is found
F4	Recovery firmware image is loaded
F5 – F7	Reserved for future AMI progress codes
F8	Recovery PPI is not available
F9	Recovery capsule is not found
FA	Invalid recovery capsule
FB – FF	Reserved for future AMI error codes
60	DXE Core is started
61	NVRAM initialization
62	Installation of the PCH Runtime Services
63 – 67	CPU DXE initialization is started
68	PCI host bridge initialization
69	System Agent DXE initialization is started
6A	System Agent DXE SMM initialization is started
6B – 6F	System Agent DXE initialization (System Agent module specific)
70	PCH DXE initialization is started

(continued on the next page)

Code	Description
71	PCH DXE SMM initialization is started
72	PCH devices initialization
73 – 77	PCH DXE Initialization (PCH module specific)
78	ACPI module initialization
79	CSM initialization
7A – 7F	Reserved for future AMI DXE codes
90	Boot Device Selection (BDS) phase is started
91	Driver connecting is started
92	PCI Bus initialization is started
93	PCI Bus Hot Plug Controller Initialization
94	PCI Bus Enumeration
95	PCI Bus Request Resources
96	PCI Bus Assign Resources
97	Console Output devices connect
98	Console input devices connect
99	Super IO Initialization
9A	USB initialization is started
9B	USB Reset
9C	USB Detect
9D	USB Enable
9E – 9F	Reserved for future AMI codes
A0	IDE initialization is started
A1	IDE Reset
A2	IDE Detect
A3	IDE Enable
A4	SCSI initialization is started
A5	SCSI Reset
A6	SCSI Detect
A7	SCSI Enable
A8	Setup Verifying Password
A9	Start of Setup

(continued on the next page)

Code	Description
AA	Reserved for ASL (see ASL Status Codes section below)
AB	Setup Input Wait
AC	Reserved for ASL (see ASL Status Codes section below)
AD	Ready To Boot event
AE	Legacy Boot event
AF	Exit Boot Services event
B0	Runtime Set Virtual Address MAP Begin
B1	Runtime Set Virtual Address MAP End
B2	Legacy Option ROM Initialization
B3	System Reset
B4	USB hot plug
B5	PCI bus hot plug
B6	Clean-up of NVRAM
B7	Configuration Reset (reset of NVRAM settings)
B8– BF	Reserved for future AMI codes
D0	CPU initialization error
D1	System Agent initialization error
D2	PCH initialization error
D3	Some of the Architectural Protocols are not available
D4	PCI resource allocation error. Out of Resources
D5	No Space for Legacy Option ROM
D6	No Console Output Devices are found
D7	No Console Input Devices are found
D8	Invalid password
D9	Error loading Boot Option (LoadImage returned error)
DA	Boot Option is failed (StartImage returned error)
DB	Flash update is failed
DC	Reset protocol is not available

ACPI/ASL Checkpoints

Code	Description
0x01	System is entering S1 sleep state
0x02	System is entering S2 sleep state
0x03	System is entering S3 sleep state
0x04	System is entering S4 sleep state
0x05	System is entering S5 sleep state
0x10	System is waking up from the S1 sleep state
0x20	System is waking up from the S2 sleep state
0x30	System is waking up from the S3 sleep state
0x40	System is waking up from the S4 sleep state
0xAC	System has transitioned into ACPI mode. Interrupt controller is in PIC mode.
0xAA	System has transitioned into ACPI mode. Interrupt controller is in APIC mode.

1.2.9 Internal connectors

1. Intel® Z77 Serial ATA 6.0 Gb/s connectors (7-pin SATA6G_1/2 [gray])

These connectors connect to Serial ATA 6.0 Gb/s hard disk drives via Serial ATA 6.0 Gb/s signal cables.

If you installed Serial ATA hard disk drives, you can create a RAID 0, 1, 5, and 10 configuration with the Intel® Rapid Storage Technology through the onboard Intel® Z77 chipset.

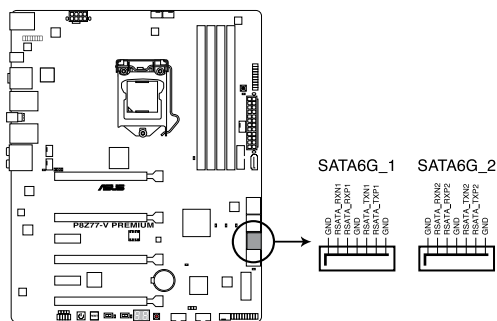

P8Z77-V PREMIUM Intel® SATA 6.0 Gb/s connectors

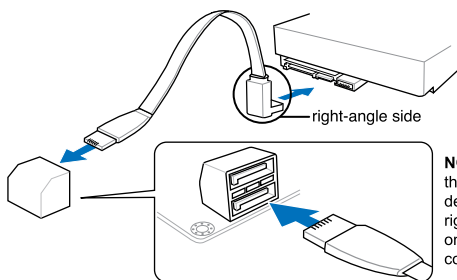

NOTE: Connect the right-angle side of the SATA signal cable to the SATA device. You may also connect the right-angle side of the SATA cable to the onboard SATA port to avoid mechanical conflict with huge graphics cards.



- These connectors are set to **[AHCI Mode]** by default. If you intend to create a Serial ATA RAID set using these connectors, set the SATA Mode item in the BIOS to **[RAID Mode]**. Refer to section **3.5.3 SATA Configuration** for details.
- Before creating a RAID set, refer to section **5.1 RAID configurations** or the manual bundled in the motherboard support DVD.
- When using NCQ, set the SATA Mode in the BIOS to **[AHCI Mode]**. Refer to section **3.5.3 SATA Configuration** for details.
- You must install Windows® XP Service Pack 3 or later versions before using Serial ATA hard disk drives. The Serial ATA RAID feature is available only if you are using Windows® XP SP3 or later versions.

2. Intel® Z77 Serial ATA 3.0 Gb/s connectors (7-pin SATA3G_3/4/5 [blue])

These connectors connect to Serial ATA 3.0 Gb/s hard disk drives and optical disc drives via Serial ATA 3.0 Gb/s signal cables.

If you installed Serial ATA hard disk drives, you can create a RAID 0, 1, 5, and 10 configuration with the Intel® Rapid Storage Technology through the onboard Intel® Z77 chipset.

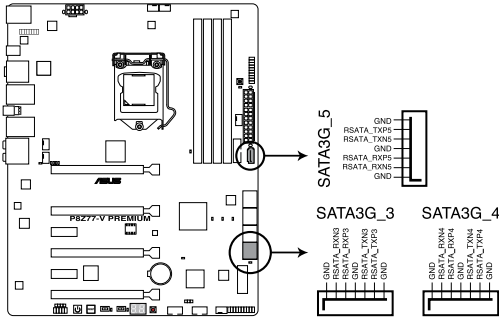

P8Z77-V PREMIUM Intel® SATA 3.0 Gb/s connector



- These connectors are set to **[AHCI Mode]** by default. If you intend to create a Serial ATA RAID set using these connectors, set the SATA Mode item in the BIOS to **[RAID Mode]**. Refer to section 3.5.3 **SATA Configuration** for details.
- Before creating a RAID set, refer to section 5.1 **RAID configurations** or the manual bundled in the motherboard support DVD.
- When using NCQ, set the SATA Mode in the BIOS to **[AHCI Mode]**. Refer to section 3.5.3 **SATA Configuration** for details.
- You must install Windows® XP Service Pack 3 or later versions before using Serial ATA hard disk drives. The Serial ATA RAID feature is available only if you are using Windows® XP SP3 or later versions.

3. Marvell® Serial ATA 6.0 Gb/s connectors (7-pin SATA6G_E12/E34 [navy blue])

These connectors connect to Serial ATA 6.0 Gb/s hard disk drives via Serial ATA 6.0 Gb/s signal cables.

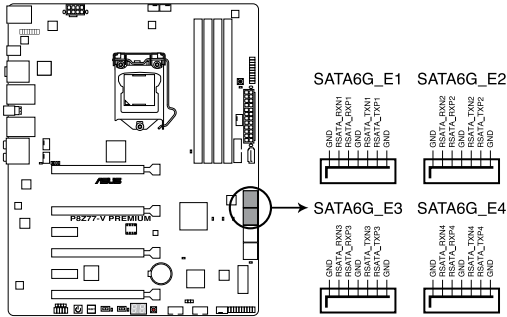

P8Z77-V PREMIUM Marvell® SATA 6.0 Gb/s connector



- You must install Windows® XP Service Pack 3 or later versions before using Serial ATA hard disk drives.
- When using NCQ, set the Marvell Storage Controller item in the BIOS to [**Enabled**]. Refer to section 3.5.6 **Onboard Devices Configuration** for details.
- Press <Ctrl> + <M> during POST to enter the Marvell RAID utility to create or delete a RAID configuration.
- If you want to install a Windows operating system to a RAID configuration created using the Marvell SATA controller, you have to create a RAID driver disk using the motherboard support DVD and load the driver during OS installation. For 32/64bit Windows XP OS, load first the Marvell shared library driver, and then load Marvell 91xx SATA Controller Driver. For Windows® 7 OS, load only the Marvell 91xx SATA Controller Driver.
- Connect one HDD and one SSD to Marvell® SATA6G_E12/E34 connectors for a high performance of ASUS SSD Caching II.
- The SATA6G_E12/E34 connectors are recommended for regular use.

4. USB 3.0 connector (20-1 pin USB3_12)

This connector is for the additional USB 3.0 ports, and complies with the USB 3.0 specification that supports up to 480 MBps connection speed. If the USB 3.0 front panel cable is available from your system chassis, with this USB 3.0 connector, you can have a front panel USB 3.0 solution.

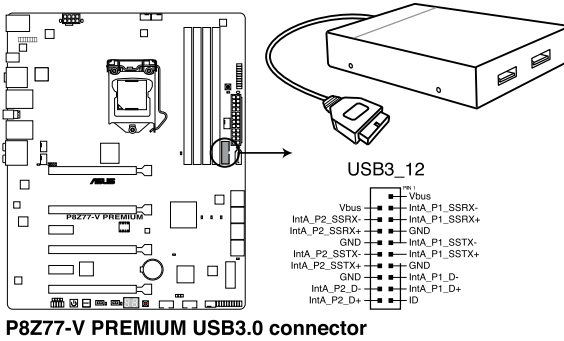

Due to Intel® limitations, USB3_12 connector ports run at USB 3.0 speed rate under Windows® 7 or later versions.

5. Digital audio connector (4-1 pin SPDIF_OUT)

This connector is for an additional Sony/Philips Digital Interface (S/PDIF) port. Connect the S/PDIF Out module cable to this connector, then install the module to a slot opening at the back of the system chassis.

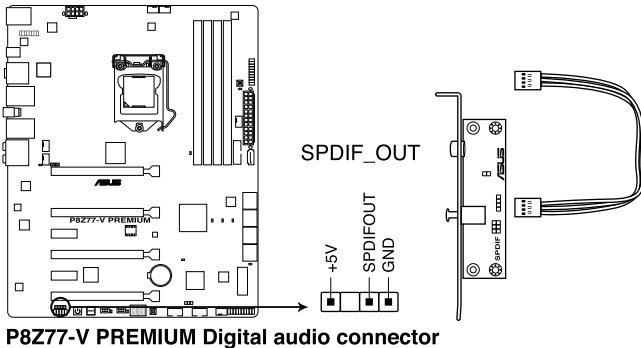

The S/PDIF module is purchased separately.

6. USB 2.0 connectors (10-1 pin USB1112; USB910)

These connectors are for USB 2.0 ports. Connect the USB module cable to any of these connectors, then install the module to a slot opening at the back of the system chassis. These USB connectors comply with USB 2.0 specification that supports up to 48 MBps connection speed.

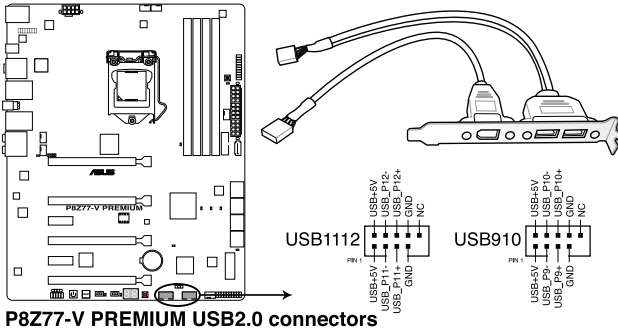

Never connect a 1394 cable to the USB connectors. Doing so will damage the motherboard!



You can connect the front panel USB cable to the ASUS Q-Connector (USB, blue) first, and then install the Q-Connector (USB) to the USB connector onboard if your chassis supports front panel USB ports.



The USB 2.0 module is purchased separately.

7. CPU, chassis, and power fan connectors
(4-pin CPU_FAN; 4-pin CPU_OPT; 4-pin CHA_FAN1-4)

Connect the fan cables to the fan connectors on the motherboard, ensuring that the black wire of each cable matches the ground pin of the connector.

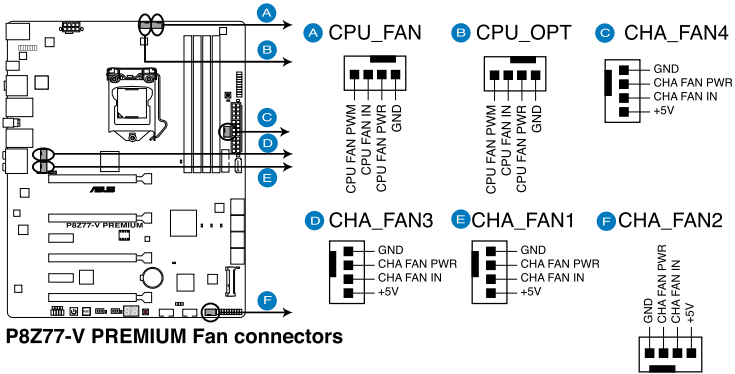

Do not forget to connect the fan cables to the fan connectors. Insufficient air flow inside the system may damage the motherboard components. These are not jumpers! Do not place jumper caps on the fan connectors!



- The CPU_FAN connector supports the CPU fan of maximum 1A (12 W) fan power.
- Only the CPU_FAN, CHA_FAN 1/2/3/4 connectors support the ASUS FAN Xpert 2 feature.

8. Front panel audio connector (10-1 pin AAFP)

This connector is for a chassis-mounted front panel audio I/O module that supports either HD Audio or legacy AC'97 audio standard. Connect one end of the front panel audio I/O module cable to this connector.

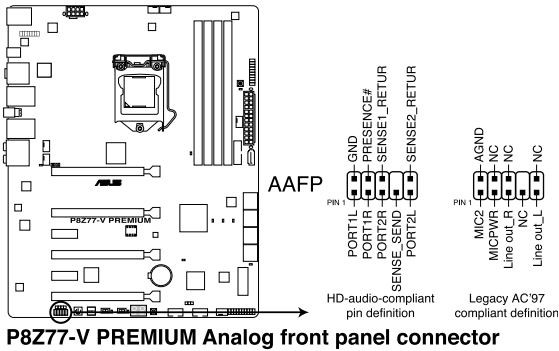

- We recommend that you connect a high-definition front panel audio module to this connector to avail of the motherboard's high-definition audio capability.
- If you want to connect a high-definition or an AC'97 front panel audio module to this connector, set the Front Panel Type item in the BIOS setup to **[HD]** or **[AC97]**.

9. ATX power connectors (24-pin EATXPWR; 8-pin EATX12V)

These connectors are for ATX power supply plugs. The power supply plugs are designed to fit these connectors in only one orientation. Find the proper orientation and push down firmly until the connectors completely fit.

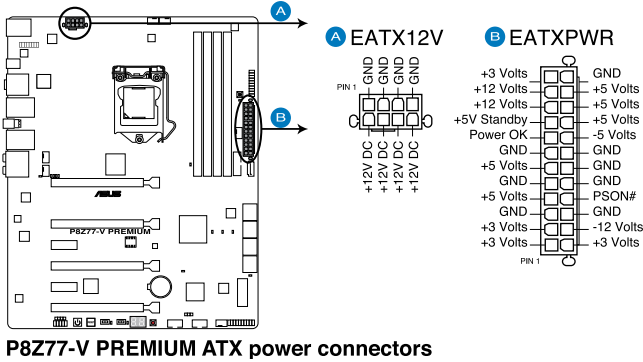

- For a fully configured system, we recommend that you use a power supply unit (PSU) that complies with ATX 12 V Specification 2.0 (or later version) and provides a minimum power of 350 W.
- Do not forget to connect the 4-pin/8-pin EATX12 V power plug. Otherwise, the system will not boot.
- We recommend that you use a PSU with a higher power output when configuring a system with more power-consuming devices. The system may become unstable or may not boot up if the power is inadequate.
- If you want to use two or more high-end PCI Express x16 cards, use a PSU with 1000W power or above to ensure the system stability.
- If you are uncertain about the minimum power supply requirement for your system, refer to the Recommended Power Supply Wattage Calculator at <http://support.asus.com/PowerSupplyCalculator/PSCalculator.aspx?SLanguage=en-us> for details.

10. System panel connector (20-8 pin PANEL)

This connector supports several chassis-mounted functions.

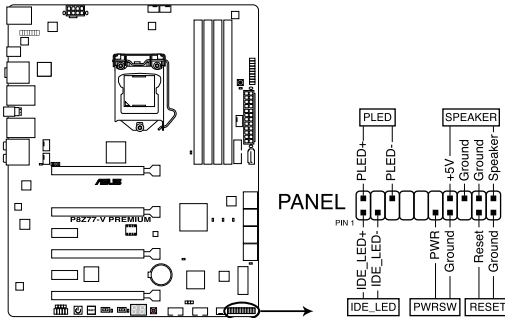

P8Z77-V PREMIUM System panel connector

- **System power LED (2-pin PLED)**

This 2-pin connector is for the system power LED. Connect the chassis power LED cable to this connector. The system power LED lights up when you turn on the system power, and blinks when the system is in sleep mode.

- **Hard disk drive activity LED (2-pin IDE_LED)**

This 2-pin connector is for the HDD Activity LED. Connect the HDD Activity LED cable to this connector. The IDE LED lights up or flashes when data is read from or written to the HDD.

- **System warning speaker (4-pin SPEAKER)**

This 4-pin connector is for the chassis-mounted system warning speaker. The speaker allows you to hear system beeps and warnings.

- **ATX power button/soft-off button (2-pin PWRSW)**

This connector is for the system power button. Pressing the power button turns the system on or puts the system in sleep or soft-off mode depending on the BIOS settings. Pressing the power switch for more than four seconds while the system is ON turns the system OFF.

- **Reset button (2-pin RESET)**

This 2-pin connector is for the chassis-mounted reset button for system reboot without turning off the system power.

11. TPM connector (20-1 pin TPM)

This connector supports a Trusted Platform Module (TPM) system, which securely store keys, digital certificates, passwords and data. A TPM system also helps enhance network security, protect digital identities, and ensures platform integrity.

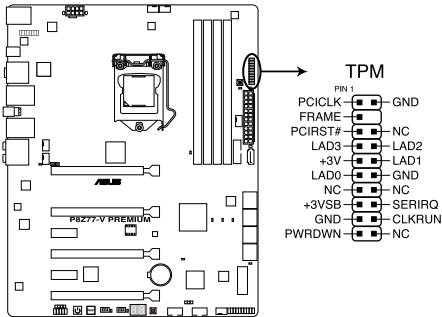

P8Z77-V PREMIUM TPM connector

12. MSATA 3.0 Gb/s connector (56-pin MSATA)

This connector is for a single SATA 3.0 Gb/s solid-state drive (SSD). Connect the SSD to the MSATA port.

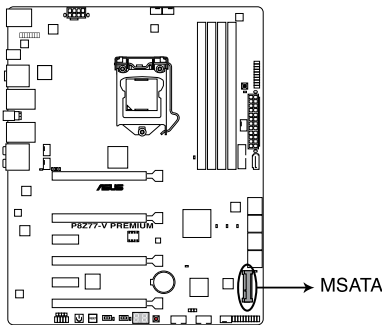

P8Z77-V PREMIUM MSATA

Basic Installation

2

2.1 Building your PC system

2.1.1 Motherboard installation



The diagrams in this section are for reference only. The motherboard layout may vary with models, but the installation steps are the same for all models.

1. Install the ASUS Q-Shield to the chassis rear I/O panel.

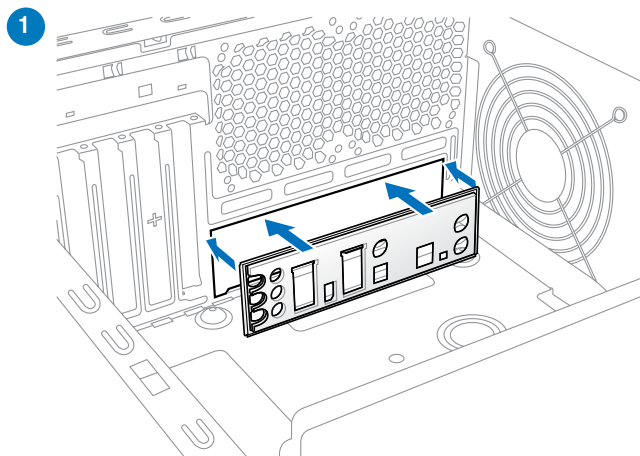

2. Place the motherboard into the chassis, ensuring that its rear I/O ports are aligned to the chassis' rear I/O panel.

2

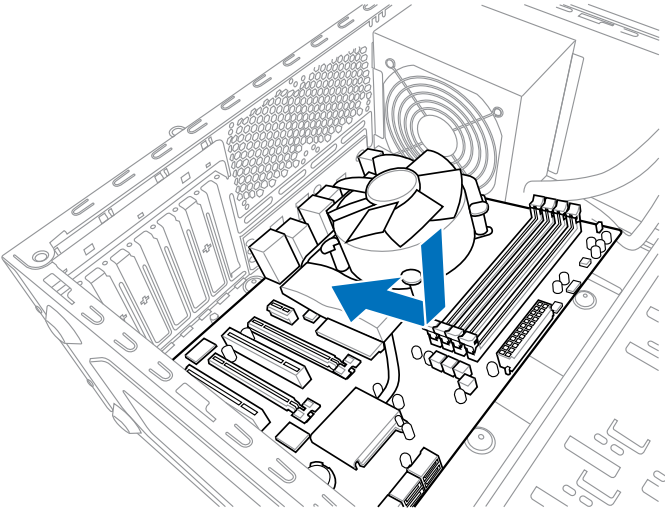

- Place nine screws into the holes indicated by circles to secure the motherboard to the chassis.

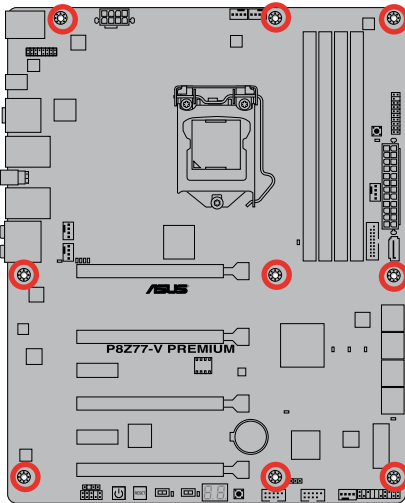
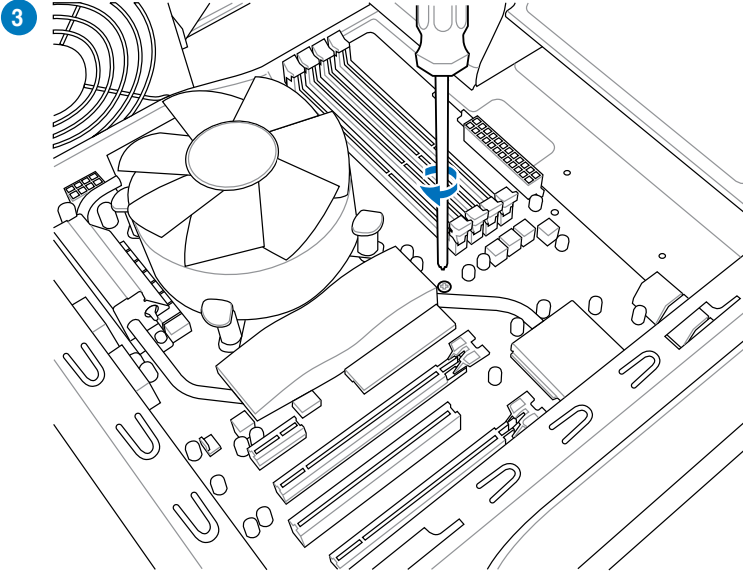

DO NOT overtighten the screws! Doing so can damage the motherboard.

2.1.2 CPU installation



The LGA1156 CPU is not compatible with the LGA1155 socket. DO NOT install a LGA1156 CPU on the LGA1155 socket.

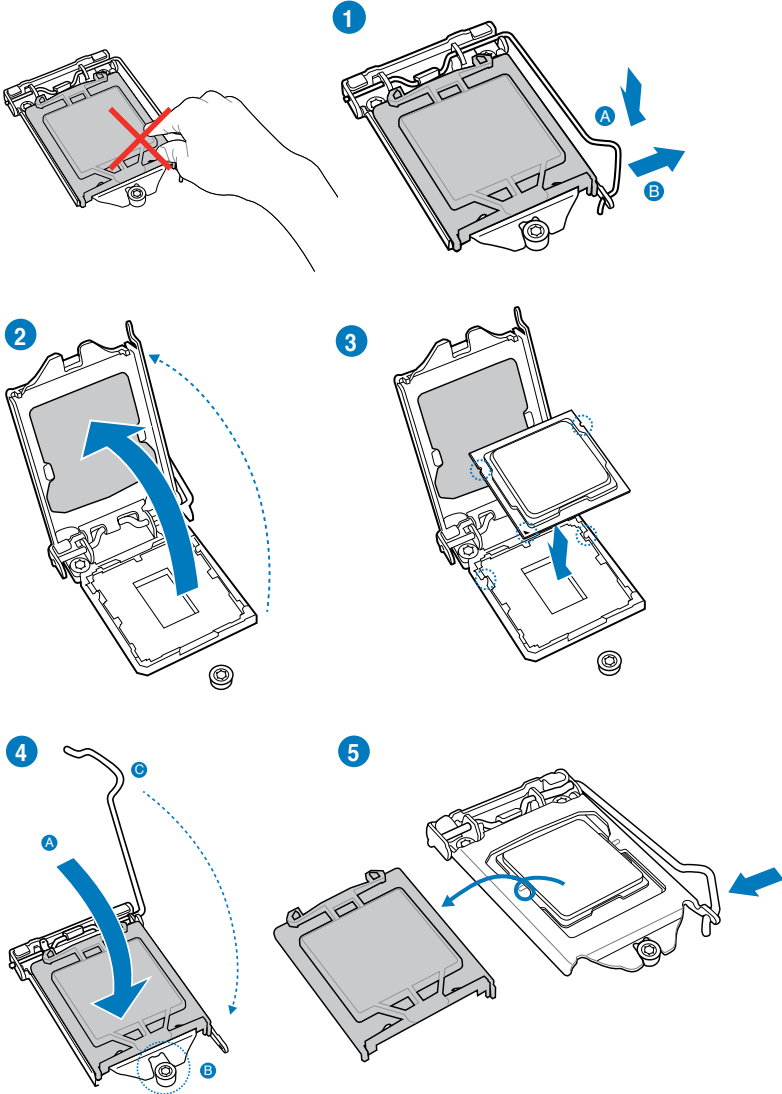

2.1.3 CPU heatsink and fan assembly installation

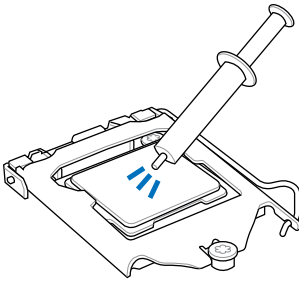

Apply the Thermal Interface Material to the CPU heatsink and CPU before you install the heatsink and fan if necessary.

To install the CPU heatsink and fan assembly

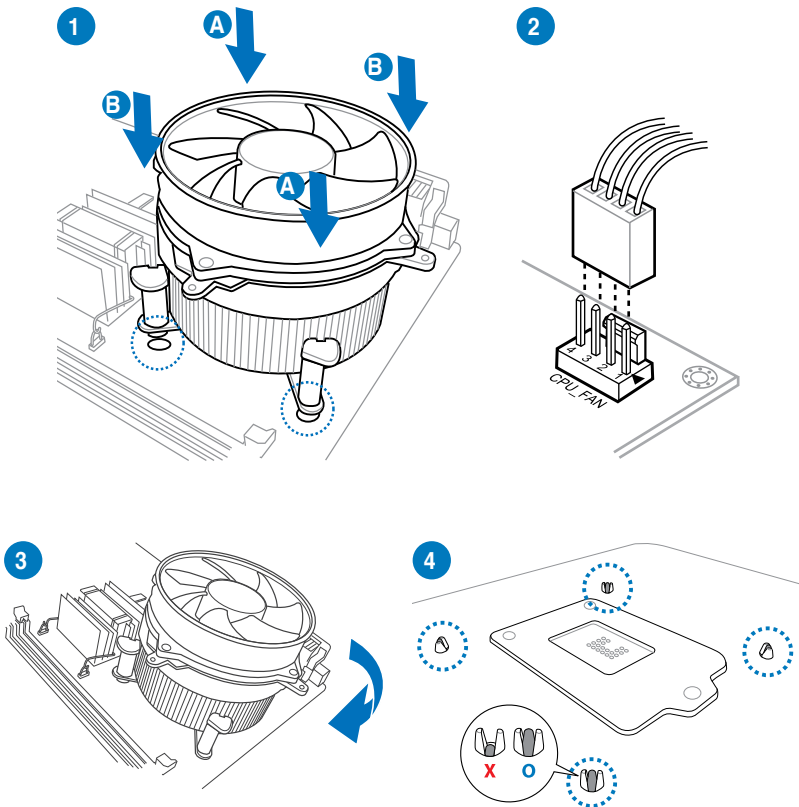

To uninstall the CPU heatsink and fan assembly

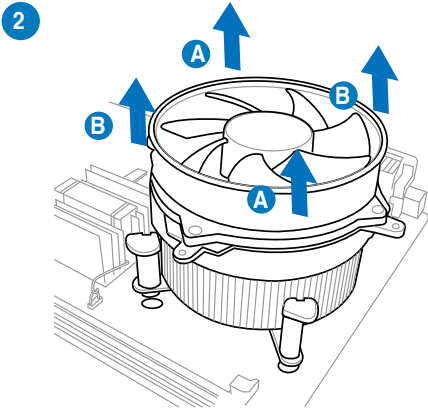
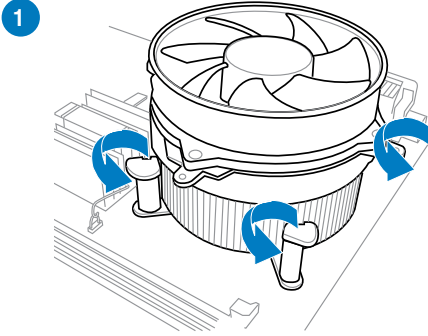

2.1.4 DIMM installation

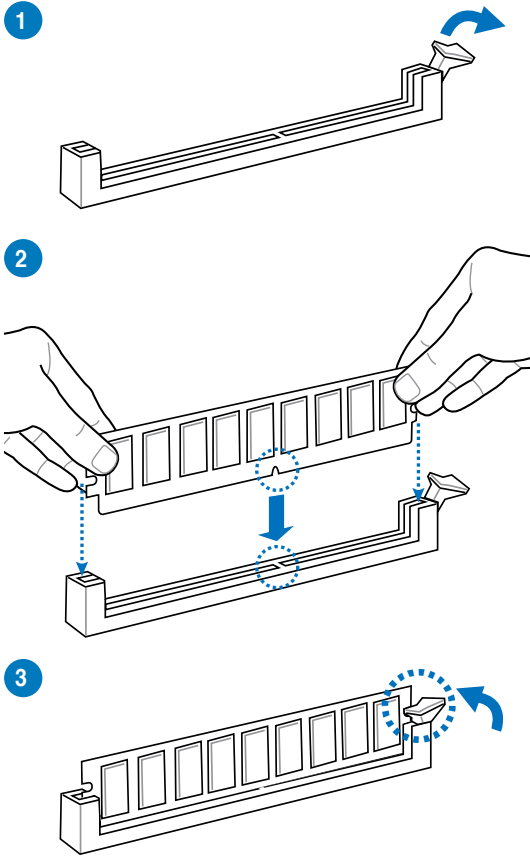

To remove a DIMM

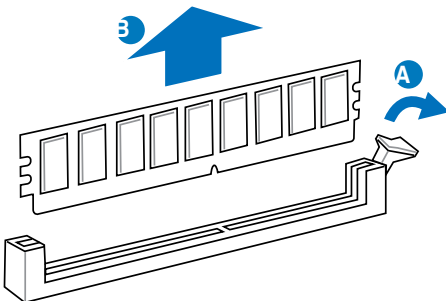

2.1.5 ATX Power connection

1

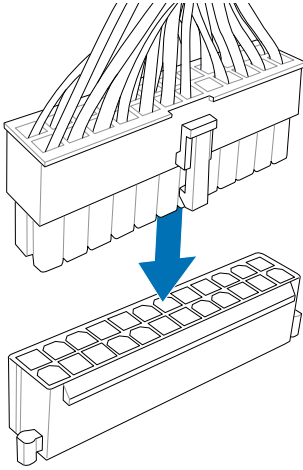

2

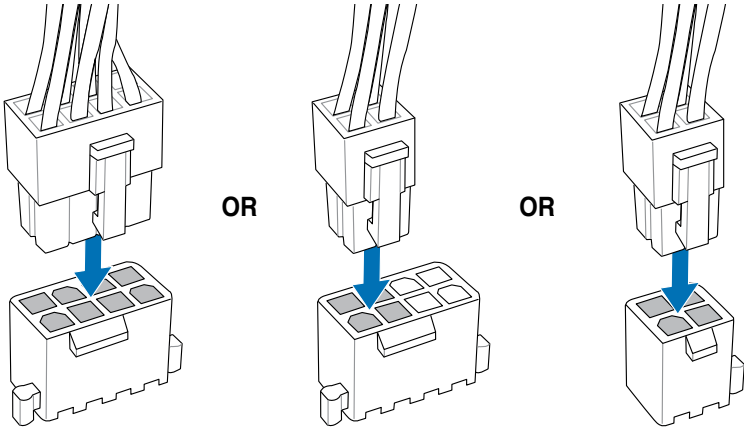

2.1.6 SATA device connection

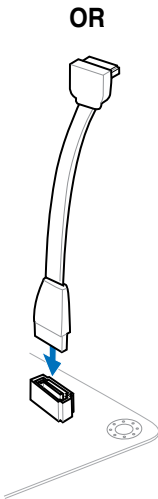
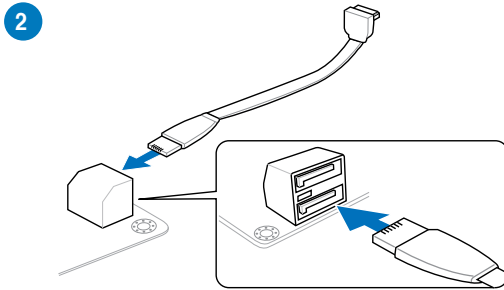
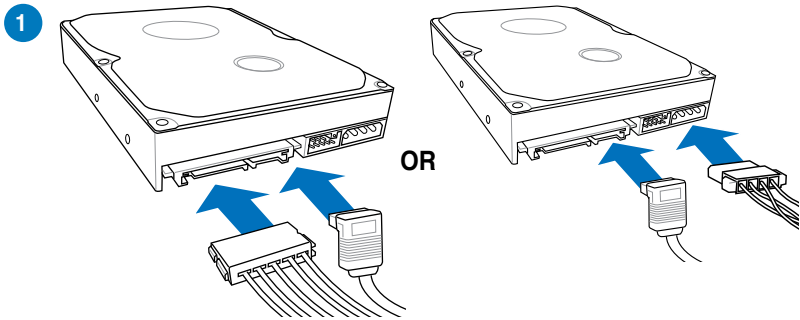

2.1.7 Front I/O Connector

To install ASUS Q-Connector

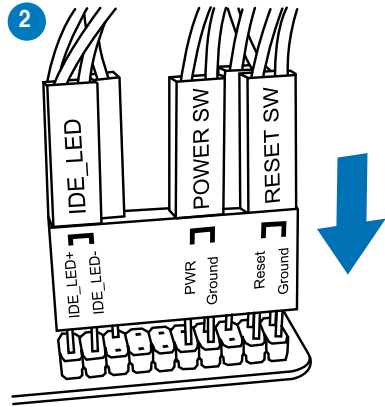
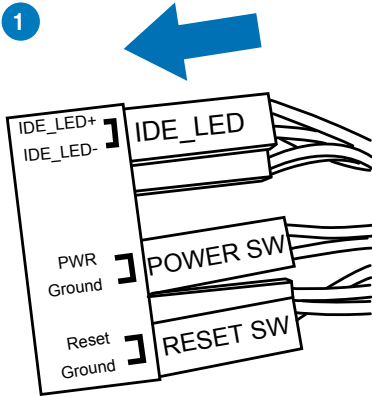

To install USB 2.0 connector

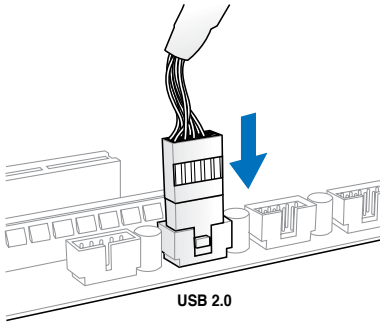

To install front panel audio connector

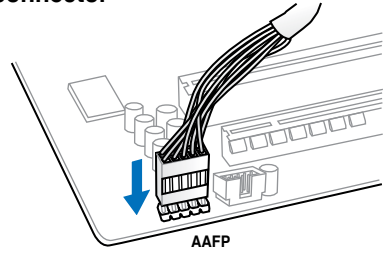

To install USB 3.0 connector

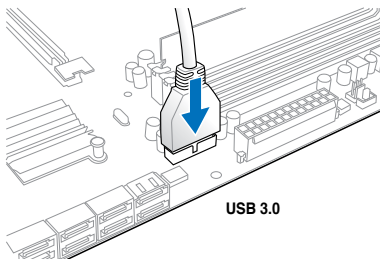

2.1.8 Expansion Card installation

To install PCIe x16 cards

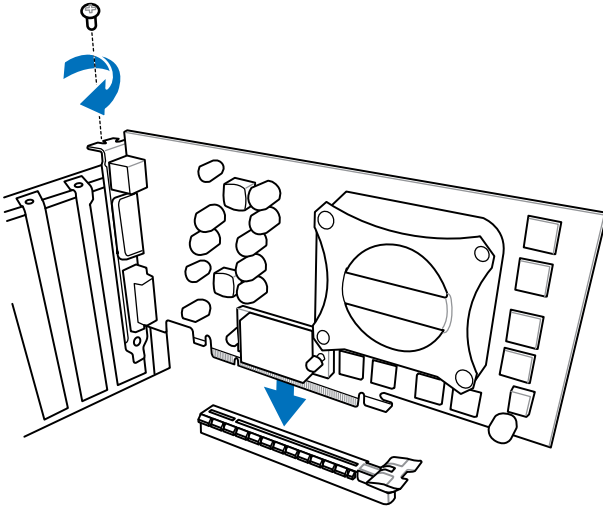

To install PCIe x1 cards

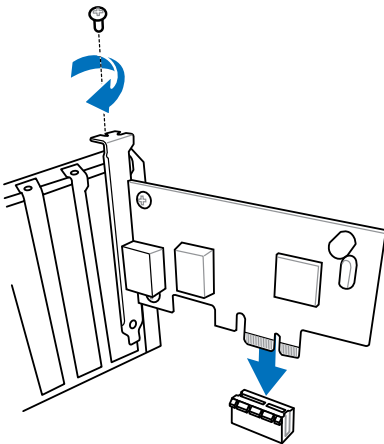

2.1.9 Wi-Fi GO! card installation

Wi-Fi 802.11a/b/g/n, Bluetooth v4.0/3.0 + HS



Disconnect the power supply unit from the motherboard before installing/uninstalling the Wireless and Bluetooth Module.

1. Remove the screw from the ASUS Wi-Fi GO! card.

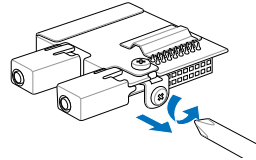

2. Locate the Wi-Fi GO! card connector at the motherboard's rear panel and connect the Wi-Fi GO! card to it.

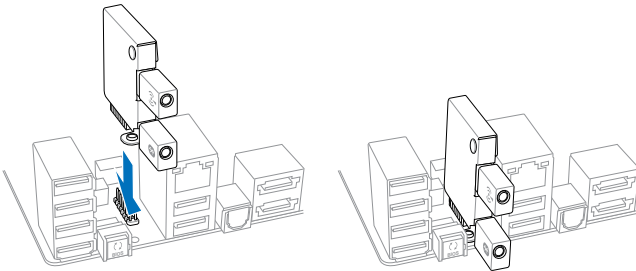

3. Secure the Wi-Fi GO! card to the motherboard with the screw you removed earlier.

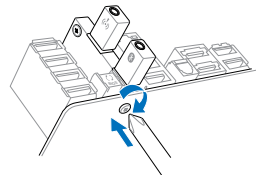

4. Attach the IO shield onto the computer chassis, and place the motherboard flatly into the chassis.
5. Fasten the screws onto the motherboard.
6. Connect the Wi-Fi Ring Moving antennas to the Wi-Fi ports at the back of the chassis. When you hear the clicking sound, the antenna connectors are properly inserted. Give a slight pull to determine that the installation is complete.

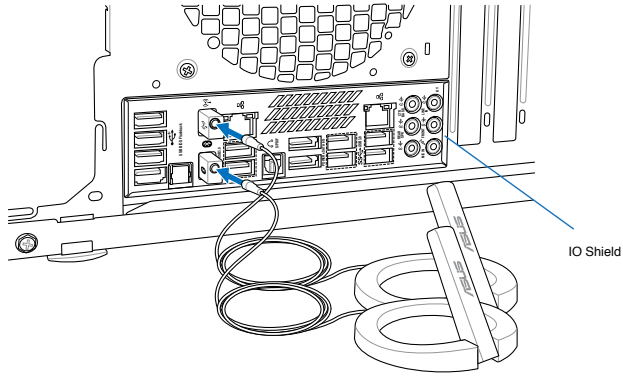

Be sure to install the Bluetooth driver before installing the Wi-Fi GO! software.

2.2 BIOS update utility

2.2.1 USB BIOS Flashback

USB BIOS Flashback allows you to easily update the BIOS without entering the existing BIOS or operating system. Simply insert a USB storage device to the USB port, press the USB BIOS Flashback button for three seconds, and the BIOS is updated automatically.

To use USB BIOS Flashback:

1. Place the bundled support DVD to the optical drive and install the USB BIOS Flashback Wizard. Follow the onscreen instructions to complete the installation.
2. Insert the USB storage device to the USB Flashback port.
3. Launch the USB BIOS Flashback Wizard to automatically download the latest BIOS version.
4. Press the BIOS Flashback button for three seconds until a flashing light appears, which indicates that the BIOS Flashback function is enabled.
5. Wait until the light goes out, indicating that the BIOS updating process is completed.

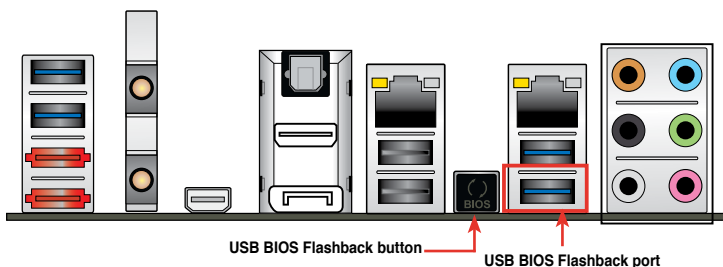

For more BIOS update utilities in BIOS setup, refer to the section **Updating BIOS** in Chapter 3.



- Do not unplug portable disk, power system, or press the CLR_CMOS button while BIOS update is ongoing, otherwise update will be interrupted. In case of interruption, please follow the steps again.
- If the light flashes for five seconds and turns into a solid light, this means that the BIOS Flashback is not operating properly. This may be caused by improper installation of the USB storage device and filename/file format error. If this scenario happens, please restart the system to turn off the light.
- Updating BIOS may have risks. If the BIOS program is damaged during the process and results to the system's failure to boot up, please contact your local ASUS Service Center.

2.3 Motherboard rear and audio connections

2.3.1 Rear I/O connection

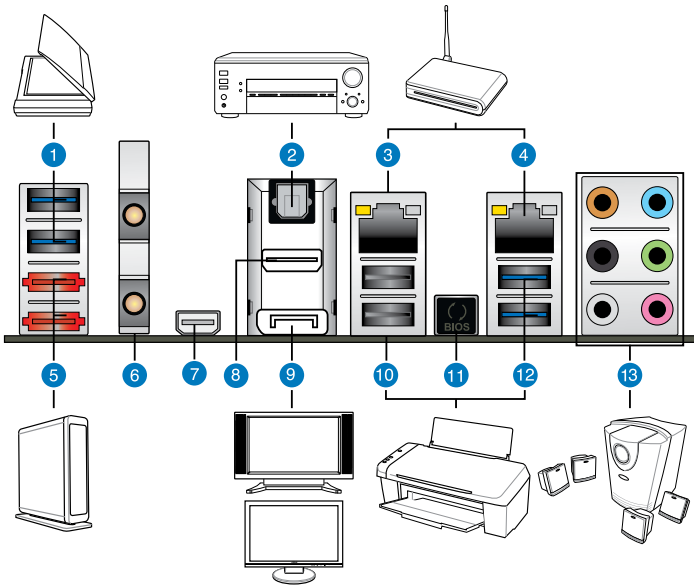

Rear panel connectors

1. ASMedia USB 3.0 ports 1 and 2 support ASUS USB 3.0 Boost UASP Mode	8. HDMI port
2. Optical S/PDIF Out port	9. DisplayPort
3. Intel® LAN (RJ-45) port**	10. USB 2.0 ports 5 and 6
4. Intel® LAN (RJ-45) port**	11. USB BIOS Flashback button
5. External SATA ports 1 and 2	12. Intel USB 3.0 ports 3 and 4, support ASUS USB 3.0 Boost Turbo Mode. Bottom port supports USB BIOS Flashback and USB Charger+
6. ASUS Wi-Fi GO! card (Wi-Fi 802.11 and Bluetooth v4.0/30.+HS)*	13. Audio I/O ports***
7. Thunderbolt port	

*, ** and ***: Refer to the tables on the next page for LAN port LEDs, and audio port definitions.



- Due to Intel® limitations, the USB3_3-34 ports run at USB 3.0 speed rate under Windows® 7 or later versions.
- Windows® 7 64-bit OS supports Thunderbolt.



- Press the Clear CMOS switch to clear BIOS setup information only when the system hangs due to overclocking.
- DO NOT insert a different connector to the external SATA port.
- Due to USB 3.0 controller limitation, USB 3.0 devices can only be used under Windows® OS environment and after the USB 3.0 driver installation.
- USB 3.0 devices can only be used as data storage only.
- We strongly recommend that you connect USB 3.0 devices to USB 3.0 ports for faster and better performance for your USB 3.0 devices.
- If you want to use the hot-plug function of the external SATA ports, you have to set the ASMedia® 1061 SATA controllers item in the BIOS setting to [Enabled] and install the ASMedia® 1061 SATA controllers from the motherboard support DVD. Refer to section 3.5.6 Onboard Devices Configuration for details.
- Ensure to install the Windows®-based driver before using the Thunderbolt device.

* Bluetooth module LED indications * Wi-Fi LED indications

Status	Description
Off	No link
Blue	Linked
Blinking	Data activity

Status	Description
Off	No link
Green	Linked



ASUS Wi-Fi GO! card automatically sets itself to the country's available Wi-Fi channels,

** LAN ports LED indications

Activity Link LED		Speed LED	
Status	Description	Status	Description
OFF	No link	OFF	10 Mbps connection
ORANGE	Linked	ORANGE	100 Mbps connection
BLINKING	Data activity	GREEN	1 Gbps connection

***** Audio 2, 4, 6, or 8-channel configuration**

Port	Headset 2-channel	4-channel	6-channel	8-channel
Light Blue	Line In	Line In	Line In	Line In
Lime	Line Out	Front Speaker Out	Front Speaker Out	Front Speaker Out
Pink	Mic In	Mic In	Mic In	Mic In
Orange	–	–	Center/Subwoofer	Center/Subwoofer
Black	–	Rear Speaker Out	Rear Speaker Out	Rear Speaker Out
Gray	–	–	–	Side Speaker Out

2.3.2 Audio I/O connections

Audio I/O ports

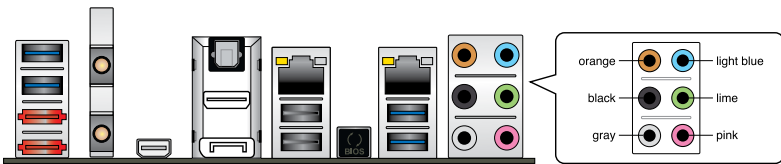

Connect to Headphone and Mic



Connect to Stereo Speakers

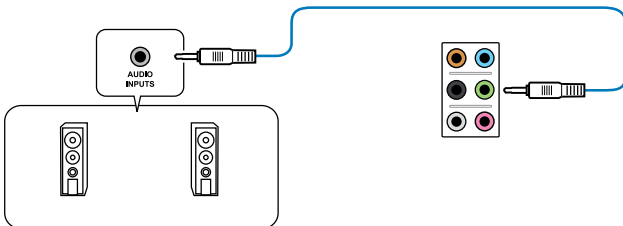

Connect to 2.1 channel Speakers

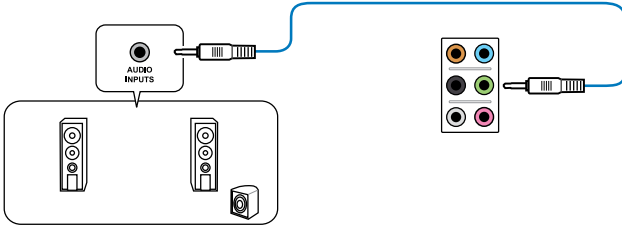

Connect to 4.1 channel Speakers

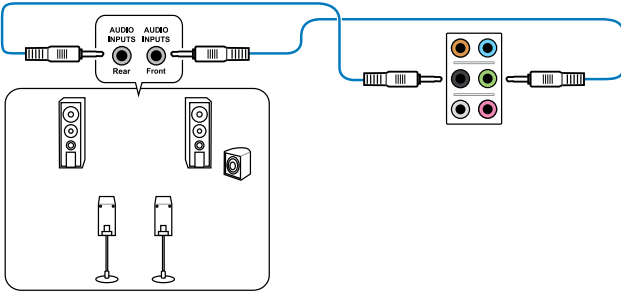

Connect to 5.1 channel Speakers

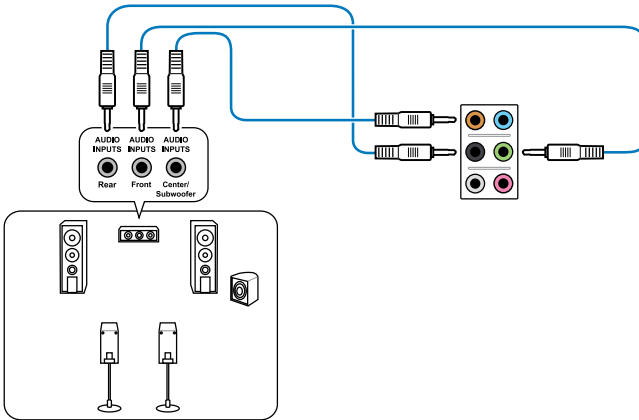

Connect to 7.1 channel Speakers

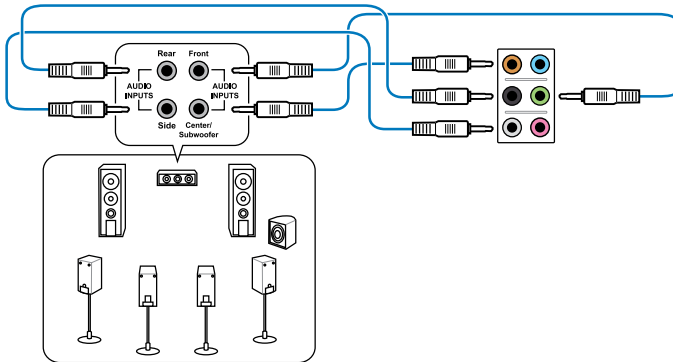

When the DTS UltraPC II function is enabled, ensure to connect the rear speaker to the gray port.

2.4 Starting up for the first time

1. After making all the connections, replace the system case cover.
2. Ensure that all switches are off.
3. Connect the power cord to the power connector at the back of the system chassis.
4. Connect the power cord to a power outlet that is equipped with a surge protector.
5. Turn on the devices in the following order:
 - a. Monitor
 - b. External SCSI devices (starting with the last device on the chain)
 - c. System power
6. After applying power, the system power LED on the system front panel case lights up. For systems with ATX power supplies, the system LED lights up when you press the ATX power button. If your monitor complies with the “green” standards or if it has a “power standby” feature, the monitor LED may light up or change from orange to green after the system LED turns on.

The system then runs the power-on self tests (POST). While the tests are running, the BIOS beeps (refer to the BIOS beep codes table) or additional messages appear on the screen. If you do not see anything within 30 seconds from the time you turned on the power, the system may have failed a power-on test. Check the jumper settings and connections or call your retailer for assistance.

BIOS Beep	Description
One short beep	VGA detected Quick boot set to disabled No keyboard detected
One continuous beep followed by two short beeps then a pause (repeated)	No memory detected
One continuous beep followed by three short beeps	No VGA detected
One continuous beep followed by four short beeps	Hardware component failure

7. At power on, hold down the <Delete> key to enter the BIOS Setup. Follow the instructions in Chapter 3.

2.5 Turning off the computer

While the system is ON, press the power button for less than four seconds to put the system on sleep mode or soft-off mode, depending on the BIOS setting. Press the power switch for more than four seconds to let the system enter the soft-off mode regardless of the BIOS setting.

BIOS setup

3

3.1 Knowing BIOS



The new ASUS UEFI BIOS is a Unified Extensible Interface that complies with UEFI architecture, offering a user-friendly interface that goes beyond the traditional keyboard-only BIOS controls to enable a more flexible and convenient mouse input. You can easily navigate the new UEFI BIOS with the same smoothness as your operating system. The term “BIOS” in this user manual refers to “UEFI BIOS” unless otherwise specified.

BIOS (Basic Input and Output System) stores system hardware settings such as storage device configuration, overclocking settings, advanced power management, and boot device configuration that are needed for system startup in the motherboard CMOS. In normal circumstances, the default BIOS settings apply to most conditions to ensure optimal performance. **DO NOT change the default BIOS settings** except in the following circumstances:

- An error message appears on the screen during the system bootup and requests you to run the BIOS Setup.
- You have installed a new system component that requires further BIOS settings or update.



Inappropriate BIOS settings may result to instability or boot failure. **We strongly recommend that you change the BIOS settings only with the help of a trained service personnel.**



When downloading or updating the BIOS file, rename it as **Z77VPR.CAP** for this motherboard.

3.2 BIOS setup program

Use the BIOS Setup to update the BIOS or configure its parameters. The BIOS screen include navigation keys and brief onscreen help to guide you in using the BIOS Setup program.

Entering BIOS at startup

To enter BIOS Setup at startup:

- Press <Delete> during the Power-On Self Test (POST). If you do not press <Delete>, POST continues with its routines.

Entering BIOS Setup after POST

To enter BIOS Setup after POST:

- Press <Ctrl>+<Alt>+<Delete> simultaneously.
- Press the reset button on the system chassis.
- Press the power button to turn the system off then back on. Do this option only if you failed to enter BIOS Setup using the first two options.



-
- The BIOS setup screens shown in this section are for reference purposes only, and may not exactly match what you see on your screen.
 - Ensure that a USB mouse is connected to your motherboard if you want to use the mouse to control the BIOS setup program.
 - If the system becomes unstable after changing any BIOS setting, load the default settings to ensure system compatibility and stability. Select the **Load Optimized Defaults** item under the **Exit** menu or press hotkey <F5>. See section 3.9 **Exit Menu** for details.
 - If the system fails to boot after changing any BIOS setting, try to clear the CMOS and reset the motherboard to the default value. See section 1.2.6 **Onboard buttons and switches** for information on how to erase the RTC RAM via the Clear CMOS button.
 - The BIOS setup program does not support the bluetooth devices.
-

BIOS menu screen

The BIOS Setup program can be used under two modes: **EZ Mode** and **Advanced Mode**. You can change modes from the **Exit** menu or from the **Exit/Advanced Mode** screen.

3.2.1 EZ Mode

By default, the EZ Mode screen appears when you enter the BIOS setup program. The EZ Mode provides you an overview of the basic system information, and allows you to select the display language, system performance mode and boot device priority. To access the Advanced Mode, click **Exit/Advanced Mode**, then select **Advanced Mode** or press <F7> hot key for the advanced BIOS settings.



The default screen for entering the BIOS setup program can be changed. Refer to the **Setup Mode** item in section 3.7 **Boot menu** for details.

Displays the CPU/motherboard temperature, CPU/5V/3.3V/12V voltage output, CPU/chassis/ power fan speed

Selects the display language of the BIOS setup program

Click to display all fan speeds if available

Exits the BIOS setup program without saving the changes, saves the changes and resets the system, or enters the Advanced Mode

Quiet
Performance Energy Saving

Normal

Power Saving mode

Normal mode

ASUS Optimal mode

Boot Priority

Selects the boot device priority

Displays the Advanced mode menus

Displays the system properties of the selected mode on the right hand side

Loads optimized default settings

Selects the boot device priority

Selects the Advanced mode functions

Selects the boot device priority



- The boot device options vary depending on the devices you installed to the system.
- The **Boot Menu(F8)** button is available only when the boot device is installed to the system.

3.2.2 Advanced Mode

The Advanced Mode provides advanced options for experienced end-users to configure the BIOS settings. The figure below shows an example of the Advanced Mode. Refer to the following sections for the detailed configurations.



To access the Advanced Mode, click **Exit**, then select **Advanced Mode** or press **F7** hotkey.

Back button **Menu items** **Menu bar** **Configuration fields** **General help**

Submenu item **Pop-up window** **Scroll bar** **Navigation keys**

Menu bar

The menu bar on top of the screen has the following main items:

Main	For changing the basic system configuration
Ai Tweaker	For changing the overclocking settings
Advanced	For changing the advanced system settings
Monitor	For displaying the system temperature, power status, and changing the fan settings.
Boot	For changing the system boot configuration
Tool	For configuring options for special functions
Exit	For selecting the exit options and loading default settings

Menu items

The highlighted item on the menu bar displays the specific items for that menu. For example, selecting **Main** shows the Main menu items.

The other items (Ai Tweaker, Advanced, Monitor, Boot, Tool, and Exit) on the menu bar have their respective menu items.

Back button

This button appears when entering a submenu. Press <Esc> or use the USB mouse to click this button to return to the previous menu screen.

Submenu items

A greater than sign (>) before each item on any menu screen means that the item has a submenu. To display the submenu, select the item and press <Enter>.

Pop-up window

Select a menu item and press <Enter> to display a pop-up window with the configuration options for that item.

Scroll bar

A scroll bar appears on the right side of a menu screen when there are items that do not fit on the screen. Press the Up/Down arrow keys or <Page Up> / <Page Down> keys to display the other items on the screen.

Navigation keys

At the bottom right corner of the menu screen are the navigation keys for the BIOS setup program. Use the navigation keys to select items in the menu and change the settings.

General help

At the top right corner of the menu screen is a brief description of the selected item. Use <F12> key to capture the BIOS screen and save it to the removable storage device.

Configuration fields

These fields show the values for the menu items. If an item is user-configurable, you can change the value of the field opposite the item. You cannot select an item that is not user-configurable.

A configurable field is highlighted when selected. To change the value of a field, select it and press <Enter> to display a list of options.

3.3 Main menu

The Main screen appears when you enter the Advanced Mode of the BIOS Setup program. The Main menu provides you an overview of the basic system information, and allows you to set the system date, time, language, and security settings.

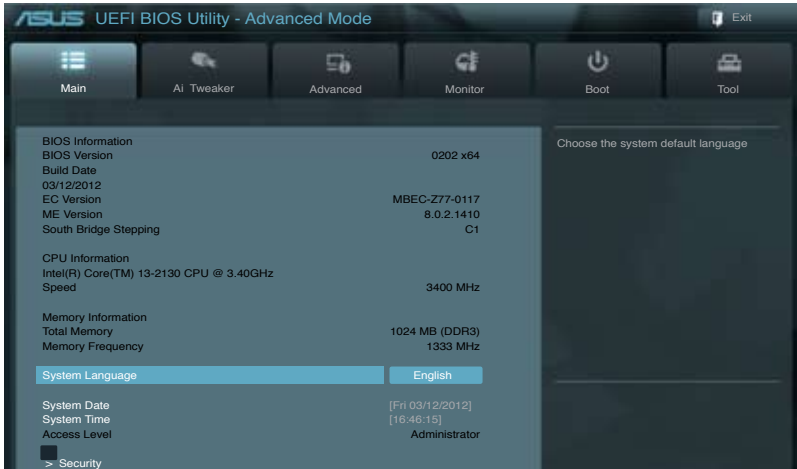

Security

The Security menu items allow you to change the system security settings.

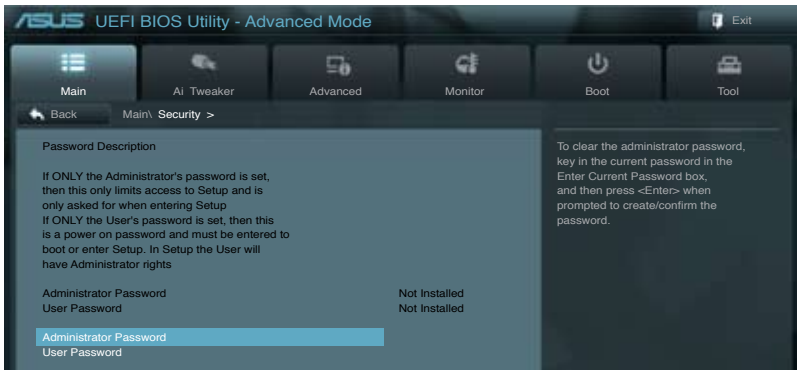

- If you have forgotten your BIOS password, erase the CMOS Real Time Clock (RTC) RAM to clear the BIOS password. See section 1.2.6 Onboard buttons and switches for information on how to erase the RTC RAM via the Clear CMOS button.
- The Administrator or User Password items on top of the screen show the default [Not Installed]. After you set a password, these items show [Installed].

Administrator Password

If you have set an administrator password, we recommend that you enter the administrator password for accessing the system. Otherwise, you might be able to see or change only selected fields in the BIOS setup program.

To set an administrator password:

1. Select the **Administrator Password** item and press <Enter>.
2. From the **Create New Password** box, key in a password, then press <Enter>.
3. Confirm the password when prompted.

To change an administrator password:

1. Select the **Administrator Password** item and press <Enter>.
2. From the **Enter Current Password** box, key in the current password, then press <Enter>.
3. From the **Create New Password** box, key in a new password, then press <Enter>.
4. Confirm the password when prompted.

To clear the administrator password, follow the same steps as in changing an administrator password, but press <Enter> when prompted to create/confirm the password. After you clear the password, the **Administrator Password** item on top of the screen shows **Not Installed**.

User Password

If you have set a user password, you must enter the user password for accessing the system. The User Password item on top of the screen shows the default Not Installed. After you set a password, this item shows Installed.

To set a user password:

1. Select the **User Password** item and press <Enter>.
2. From the **Create New Password** box, key in a password, then press <Enter>.
3. Confirm the password when prompted.

To change a user password:

1. Select the **User Password** item and press <Enter>.
2. From the **Enter Current Password** box, key in the current password, then press <Enter>.
3. From the **Create New Password** box, key in a new password, then press <Enter>.
4. Confirm the password when prompted.

To clear the user password, follow the same steps as in changing a user password, but press <Enter> when prompted to create/confirm the password. After you clear the password, the **User Password** item on top of the screen shows **Not Installed**.

3.4 Ai Tweaker menu

The Ai Tweaker menu items allow you to configure overclocking-related items.



Be cautious when changing the settings of the Ai Tweaker menu items. Incorrect field values can cause the system to malfunction.



The configuration options for this section vary depending on the CPU and DIMM model you installed on the motherboard.

Scroll down to display other BIOS items.

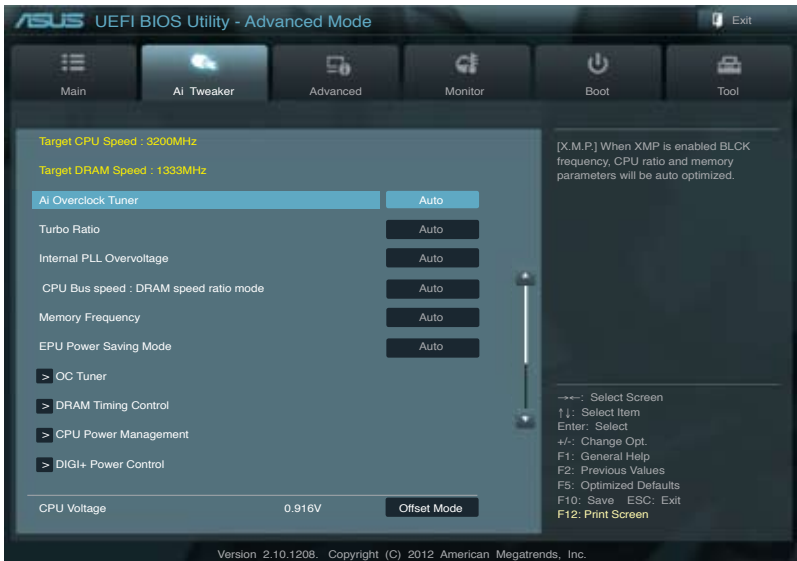

Ai Overclock Tuner [Auto]

Allows you to select the CPU overclocking options to achieve the desired CPU internal frequency. Select any of these preset overclocking configuration options:

- [Auto] Loads the optimal settings for the system.
- [Manual] Allows you to individually set overclocking parameters.
- [X.M.P.] If you install memory modules supporting the eXtreme Memory Profile (X.M.P.) Technology, choose this item to set the profiles supported by your memory modules for optimizing the system performance.



The following item appears only when you set the Ai Overclocking Tuner to [Manual].

ASUS MultiCore Enhancement [Enabled]

- [Enabled] Default set to [Enabled] for maximum performance under XMP/Manual/ User-defined memory frequency mode.
- [Disabled] Allows you to set to default core ratio settings.

BCLK/PCIE Frequency [XXX]

Allows you to adjust the CPU and VGA frequency to enhance the system performance. Use the <+> and <-> keys to adjust the value. You can also key in the desired value using the numeric keypad. The values range from 80.0MHz to 300.0MHz.

eXtreme Memory Profile

This item appears only when you set the Ai Overclocking Tuner item to [X.M.P.] and allows you to select the X.M.P. mode supported by your memory module.

Configuration options: [Profile #1] [Profile #2]

Turbo Ratio [Auto]

Allows you to set the CPU ratio automatically or manually.

- [Auto] Sets all Turbo Ratio to Intel® CPU default settings automatically.
- [Manual] Sets the Turbo Ratio for every core-activation condition of a full unlocked CPU manually.



When the Turbo Ratio is set to [Manual], the following item appears:

Ratio Synchronizing Control [Enabled]

- [Enabled] Allows you to set an individual Turbo Ratio for every core-activation condition
- [Disabled] Allows you to set one single Turbo Ratio for all core-activation conditions.

1-Core Ratio Limit [Auto]

Allows you to set the 1-Core Ratio Limit.

- [Auto] Select to apply the CPU default Turbo Ratio setting.
- [Manual] Select to manually assign a 1-Core Ratio Limit value that is higher than or equal to the 2-Core Ratio Limit.

2-Core Ratio Limit [Auto]

Allows you to set the 2-Core Ratio Limit.

- [Auto] Select to apply the CPU default Turbo Ratio setting.
- [Manual] Select to manually assign a 2-Core Ratio Limit value that is higher than or equal to the 3-Core Ratio Limit. 1-Core Limit must not be set to [Auto].

3-Core Ratio Limit [Auto]

Allows you to set the 3-Core Ratio Limit.

- [Auto] Select to apply the CPU default Turbo Ratio setting.
- [Manual] Select to manually assign a 3-Core Ratio Limit value that is higher than or equal to the 4-Core Ratio Limit. 1-Core/2-Core Ratio Limit must not be set to [Auto].

4-Core Ratio Limit [Auto]

Allows you to set the 4 Core Ratio Limit

- [Auto] Select to apply the CPU default Turbo Ratio setting
- [Manual] Select to manually assign a 4-Core Ratio Limit value that is higher than or equal to the 3-Core Ratio Limit. 1-Core/2-Core/3-Core Limit must not be set to [Auto]

Internal PLL Overvoltage [Auto]

Allows you to set the internal PLL voltage. Configuration options: [Auto] [Enabled] [Disabled]

CPU bus speed : DRAM speed ratio mode [Auto]

Allows you to set the CPU bus speed to DRAM speed ratio mode.

- [Auto] DRAM speed is set to the optimized settings.
- [100:133] The CPU bus speed to DRAM speed ratio is set to 100:133.
- [100:100] The CPU bus speed to DRAM speed ratio is set to 100:100.

Memory Frequency [Auto]

Allows you to set the memory operating frequency. The configuration options vary with the BCLK/PCIE Frequency item settings.

iGPU Max Frequency [Auto]

- [Auto] The iGPU frequency is set to its optimized settings.
- [Manual] Use the <+> or <-> to adjust the optimal iGPU frequency value. The frequency may vary depending on the system load.

EPU Power Saving Mode [Disabled]

Allows you to enable or disable the EPU power saving function.

Configuration options: [Disabled] [Enabled]

EPU Setting [Auto]

This item appears only when you set the **EPU Power Saving MODE** item to [Enabled] and allows you to select the EPU power saving mode.

Configuration options: [Auto] [Light Power Saving Mode] [Medium Power Saving Mode] [Max Power Saving Mode]

OC Tuner

OC Tuner automatically overlocks the frequency and voltage of CPU and DRAM for enhancing the system performance. Configuration options: [OK] [Cancel]

DRAM Timing Control

The subitems in this menu allow you to set the DRAM timing control features. Use the <+> and <-> keys to adjust the value. To restore the default setting, type [auto] using the keyboard and press the <Enter> key.



Changing the values in this menu may cause the system to become unstable! If this happens, revert to the default settings.

Primary Timings

DRAM CAS# Latency [Auto]

Configuration options: [Auto] [3 DRAM Clock] – [15 DRAM Clock]

DRAM RAS# to CAS# Delay [Auto]

Configuration options: [Auto] [4 DRAM Clock] – [15 DRAM Clock]

DRAM RAS# PRE Time [Auto]

Configuration options: [Auto] [4 DRAM Clock] – [15 DRAM Clock]

DRAM RAS# ACT Time [Auto]

Configuration options: [Auto] [4 DRAM Clock] – [40 DRAM Clock]

DRAM COMMAND Mode [Auto]

Configuration options: [Auto] [1 DRAM Clock] [2 DRAM Clock] [3 DRAM Clock]

Secondary Timings

DRAM RAS# to RAS# Delay [Auto]

Configuration options: [Auto] [4 DRAM Clock] – [7 DRAM Clock]

DRAM REF Cycle Time [Auto]

Configuration options: [Auto] [48 DRAM Clock] – [511 DRAM Clock]

DRAM Refresh Interval [Auto]

Configuration options: [Auto] [48 DRAM Clock] – [511 DRAM Clock]

DRAM WRITE Recovery Time [Auto]

Configuration options: [Auto] [5 DRAM Clock] – [31 DRAM Clock]

DRAM READ to PRE Time [Auto]

Configuration options: [Auto] [4 DRAM Clock] – [15 DRAM Clock]

DRAM FOUR ACT WIN Time [Auto]

Configuration options: [Auto] [16 DRAM Clock] – [63 DRAM Clock]

DRAM WRITE to READ Delay [Auto]

Configuration options: [Auto] [4 DRAM Clock] – [15 DRAM Clock]

DRAM CKE Minimum pulse width [Auto]

Configuration options: [Auto] [4 DRAM Clock] – [15 DRAM Clock]

DRAM CAS# Write to Latency [Auto]

Configuration options: [Auto] [1 DRAM Clock] – [15 DRAM Clock]

DRAM RTL (CHA) [Auto]

Configuration options: [Auto] [1 DRAM Clock] – [15 DRAM Clock]

DRAM RTL (CHB) [Auto]

Configuration options: [Auto] [1 DRAM Clock] – [15 DRAM Clock]

DRAM IO-L (CHA) [Auto]

Configuration options: [Auto] [Delay 1 Clock] - [Delay 15 Clock]

DRAM IO-L (CHB) [Auto]

Configuration options: [Auto] [Delay 1 Clock] - [Delay 15 Clock]

Third Timings**tWRDR (DD) [Auto]**

Configuration options: [Auto] [0 DRAM Clock] – [7 DRAM Clock]

tRWDR (DD) [Auto]

Configuration options: [Auto] [0 DRAM Clock] – [15 DRAM Clock]

tRWSR [Auto]

Configuration options: [Auto] [0 DRAM Clock] – [15 DRAM Clock]

tRR (DD) [Auto]

Configuration options: [Auto] [0 DRAM Clock] – [7 DRAM Clock]

tRR (DR) [Auto]

Configuration options: [Auto] [0 DRAM Clock] – [7 DRAM Clock]

tRRSR [Auto]

Configuration options: [Auto] [0 DRAM Clock] – [15 DRAM Clock]

tWW (DD) [Auto]

Configuration options: [Auto] [0 DRAM Clock] – [7 DRAM Clock]

tWW (DR) [Auto]

Configuration options: [Auto] [0 DRAM Clock] – [7 DRAM Clock]

tWWSR [Auto]

Configuration options: [Auto] [0 DRAM Clock] – [15 DRAM Clock]

MISC**MRC Fast Boot**

Allows you to enable or disable the MRC fast boot.

[Enabled] Enables the MRC fast boot.

[Disable] Disables the MRC fast boot.

DRAM CLK Period [Auto]

Configuration options: [Auto] [1] – [14]

Transmitter Slew (CHA) [Auto]

Configuration options: [Auto] [1] – [7]

Transmitter Slew (CHB) [Auto]

Configuration options: [Auto] [1] – [7]

Receiver Slew (CHA) [Auto]

Configuration options: [Auto] [1] – [7]

Receiver Slew (CHB) [Auto]

Configuration options: [Auto] [1] – [7]

MCH Duty Sense (CHA) [Auto]

Configuration options: [Auto] [1] – [31]

MCH Duty Sense (CHB) [Auto]

Configuration options: [Auto] [1] – [31]

Channel A DIMM Control [Enable Bot...]

Configuration options: [Enable Both DIMMS] [Disable DIMM0] [Disable DIMM1]
[Disable Both DIMMS]

Channel B DIMM Control [Enable Bot...]

Configuration options: [Enable Both DIMMS] [Disable DIMM0] [Disable DIMM1]
[Disable Both DIMMS]

DRAM Read Additional Swizzle [Auto]

Configuration options: [Auto] [Enabled] [Disabled]

DRAM Write Additional Swizzle [Auto]

Configuration options: [Auto] [Enabled] [Disabled]

CPU Power Management

The subitems in this menu allow you to set the CPU ratio and features.

CPU Ratio [Auto]

Allows you to manually adjust the maximum non-turbo CPU ratio. Use <+> and <-> keys to adjust the value. The valid value ranges vary according to your CPU model.

Enhanced Intel SpeedStep Technology [Enabled]

Allows you to enable or disable the Enhanced Intel® SpeedStep Technology (EIST).

[Disabled] Disables this function.

[Enabled] The operating system dynamically adjusts the processor voltage and core frequency which may result in decreased average consumption and decreased average heat production.

Turbo Mode [Enabled]

Allows you to enable your core processor's speed to run faster than the marked frequency in a specific condition. Configuration options: [Disabled] [Enabled]



The following items appear only when you set the Turbo Mode to **[Enabled]**.

Turbo Mode Parameters

Long Duration Power Limit [Auto]

Allows you to limit the turbo ratio's long duration power.

Use the <+> and <-> keys to adjust the value.

Long Duration Maintained [Auto]

Allows you to maintain the turbo ratio's long duration power.

Use the <+> and <-> keys to adjust the value.

Short Duration Power Limit [Auto]

Allows you to limit the turbo ratio's long duration power.

Use the <+> and <-> keys to adjust the value.

Primary Plane Current Limit [Auto]

Maximum instantaneous current allowed at any given time for CPU cores

Use <+> and <-> key to adjust the value at 0.125A increment.

Secondary Plane Current Limit [Auto]

Maximum instantaneous current allowed at any given time for Internal Graphics cores. Use <+> and <-> key to adjust the value at 0.125A increment.

DIGI+ Power Control

CPU Load-Line Calibration [Auto]

Load-line is defined by Intel VRM specification and affects CPU voltage. The CPU working voltage will decrease proportionally to CPU loading. Higher value gets a higher voltage and better overclocking performance, but increases the CPU and VRM thermal conditions. This item allows you to adjust the voltage range from the following percentages to boost the system performance: 0% (Regular), 25% (Medium), 50% (High), 75% (Ultra High) and 100% (Extreme).

Configuration options: [Auto] [Regular] [Medium] [High] [Ultra High] [Extreme]



The actual performance boost may vary depending on your CPU specification.

CPU Voltage Frequency [Auto]

Frequency switching affects the VRM transient response, and the thermal component. Higher frequency gets quicker transient response. Configuration options: [Auto] [Manual]



DO NOT remove the thermal module when switching to Manual Mode. The thermal conditions should be monitored.

VRM Spread Spectrum [Disabled]

This item appears only when you set the Frequency item to [Auto] and allows you to enable the spread spectrum to enhance system stability.

CPU Fixed Frequency [XXX]

This item appears only when you set the VRM Frequency item to [Manual] and allows you to set a fixed VRM frequency. Use the <+> or <-> keys to adjust the value. The values range from 300kHz with a 10kHz interval.

CPU Power Phase Control [Auto]

Allows you to control the power phase based on the CPU's demands.

Configuration options: [Auto] [Standard] [Optimized] [Extreme] [Manual Adjustment]



DO NOT remove the thermal module when switching to Extreme and Manual Mode. The thermal conditions should be monitored.

Manual Adjustment [Fast]

This item appears only when you set the CPU Power Phase Control item to [Manual Adjustment]. Configuration options: [Ultra Fast] [Fast] [Medium] [Regular]

CPU Power Duty Control [T.Probe]

DIGI + VRM Duty Control adjusts the current and thermal conditions of every component's phase.

[T. Probe] Select to maintain the VRM thermal balance.

[Extreme] Select to maintain the current VRM balance.

CPU Current Capability [100%]

Allows you to configure the total power range, and extends the overclocking frequency range simultaneously. Configuration options: [100%] [110%] [120%] [130%] [140%]



Choose a higher value when overclocking, or under a high CPU loading for extra power support.

CPU Power Thermal Control [130]

A higher temperature brings a wider CPU power thermal range and extends the overclocking tolerance to enlarge the O.C. potential. Use the <+> and <-> keys to adjust the value. The values range from 130 to 151.



DO NOT remove the thermal module. The thermal conditions should be monitored.

CPU Power Response Control [Auto]

The DIG+ VRM controller provides a faster, and precise power response rate for the CPU. Apply a higher value for an extreme overclocking.

Configuration options: [Auto] [Regular: 100%] [Medium: 150%] [Fast: 200%] [Ultra Fast: 250%]



The actual performance boost may vary depending on your CPU configuration.

iGPU Load-line Calibration [Auto]

Load-line is defined by Intel VRM specifications and affects the iGPU voltage. The iGPU working voltage decreases to integrate graphics loading. A higher value gets a higher CPU voltage and great performance but increases the CPU and thermal conditions.

Configuration options: [Auto] [Regular] [High] [Extreme]



The actual performance boost may vary depending on your CPU specification.

iGPU Current Capability [Auto]

A higher value brings a wider total iGPU power range and extends the overclocking frequency range to enhance iGPU performance. Configuration options: [100%] [110%] [120%] [130%] [140%]



DO NOT remove the thermal module. The thermal conditions must be monitored.

DRAM Current Capability [100%]

A higher value brings a wider total power range, and extends the overclocking range simultaneously. Configuration options: [100%] [110%] [120%] [130%]

DRAM Voltage Frequency [Auto]

Allows you to adjust the DRAM switching frequency. Assign a fixed high DRAM frequency to increase the O.C. range, or a low DRAM frequency for a better system stability.

Configuration options: [Auto] [Manual]

DRAM Fixed Frequency Mode [300]

This item only appears when you set the DRAM Frequency Mode item to **[Manual]**, and allows you to set a fixed DRAM frequency. Use the <+> and <-> keys to adjust the value. The values range from 300k Hz to 500k Hz with a 10k Hz interval.

DRAM Power Phase Control [Auto]

[Auto] Allows you to set the Auto mode.

[Optimized] Allows you to set the ASUS optimized phase tuning profile.

[Extreme] Allows you to set the full phase mode.

DRAM Power Thermal Control [110]

A higher temperature brings a wider DRAM power thermal range, and extends the overclocking tolerance to enlarge the O.C. potential. Use the <+> and <-> keys to adjust the value. The values range from 110 to 131.



DO NOT remove the thermal module. The thermal conditions must be monitored.

CPU Voltage [Offset Mode]

[Manual Mode] Allows you to set a fixed CPU voltage.

[Offset Mode] Allows you to set the Offset voltage.

Offset Mode Sign [+]

This item appears only when you set the **CPU Voltage** item to [Offset Mode].

[+] To offset the voltage by a positive value.

[-] To offset the voltage by a negative value.

CPU Offset Voltage [Auto]

This item appears only when you set the **CPU Voltage** item to [Offset Mode] and allows you to set the Offset voltage. The values range from 0.005V to 0.635V with a 0.005V interval.

CPU Manual Voltage [Auto]

This item appears only when you set the **CPU Voltage** item to [Manual Mode] and allows you to set a fixed CPU voltage. The values range from 0.800V to 1.92V with a 0.005V interval.



Refer to the CPU documentation before setting the CPU voltage. Setting a high voltage may damage the CPU permanently, and setting a low voltage may result in an unstable system.

iGPU Voltage [Offset Mode]

[Manual Mode] Allows you to set a fixed iGPU voltage.

[Offset Mode] Allows you to manually set the Offset voltage.

iGPU Offset Voltage [Auto]

This item appears only when you set the iGPU Voltage to [Offset Mode] and allows you to set the Offset voltage. The values range from 0.005V to 0.635V with 0.005V interval.

iGPU Manual Voltage [Auto]

This item appears only when you set the iGPU Voltage to [Manual Mode] and allows you to set a fixed iGPU voltage. The values range from 0.8V to 1.92V with a 0.005V interval.

DRAM Voltage [Auto]

Allows you to set the DRAM voltage. The values range from 1.20V to 1.92V with a 0.005V interval.



According to Intel CPU specifications, DIMMs with voltage requirement over 1.65V may damage the CPU permanently. We recommend that you install the DIMMs with the voltage requirement below 1.65V.

VCCSA Voltage [Auto]

Allows you to set the VCCSA voltage. The values range from 0.80V to 1.70V with a 0.00625V interval.

VCCIO Voltage [Auto]

Allows you to set the VCCIO voltage. The values range from 0.80V to 1.70V with a 0.00625V interval.

CPU PLL Voltage [Auto]

Allows you to set the CPU and PCH PLL voltage. The values range from 1.20V to 2.20V with a 0.00625V interval.

PCH Voltage [Auto]

Allows you to set the Platform Controller Hub voltage. The values range from 0.80V to 1.70V with a 0.01V interval.



- The values of the CPU PLL Voltage, CPU Manual Voltage, CPU Offset Voltage, iGPU Manual Voltage, iGPU Offset Voltage, DRAM Voltage, VCCSA Voltage, VCCIO Voltage, and PCH Voltage items are labeled in different color, indicating the risk levels of high voltage settings.
- The system may need better cooling system to work stably under high voltage settings.
- When you enable the OV_CPU/DRAM jumper, the CPU Manual Voltage and DRAM Voltage increases to a maximum 2.3V range.

DRAM DATA REF Voltage on CHA/B [Auto]

Allows you to set the DRAM DATA Reference Voltage on Channel A/B. The values range from 0.395x to 0.630x with a 0.005x interval. Different ratio might enhance DRAM overclocking ability.

DRAM CTRL REF Voltage on CHA/B [Auto]

Allows you to set the DRAM Control Reference Voltage on Channel A/B. The values range from 0.395x to 0.630x with a 0.005x interval. Different ratio might enhance DRAM overclocking ability.

CPU Spread Spectrum [Auto]

- [Auto] Automatic configuration.
- [Disabled] Enhances the BCLK overclocking ability.
- [Enabled] Sets to [Enabled] for EMI control.

BCLK Recovery

Allows you to recover the BCLK parameters.

Configuration options: [Auto] [Enabled] [Disabled]

3.5 Advanced menu

The Advanced menu items allow you to change the settings for the CPU and other system devices.



Be cautious when changing the settings of the Advanced menu items. Incorrect field values can cause the system to malfunction.



3.5.1 CPU Configuration

The items in this menu show the CPU-related information that the BIOS automatically detects.



The items in this menu may vary based on the CPU installed.



Intel Adaptive Thermal Monitor [Enabled]

[Enabled] Enables the overheated CPU to throttle its clock speed to cool down.

[Disabled] Disables the CPU thermal monitor function.

Active Processor Cores [All]

Allows you to choose the number of CPU cores to activate in each processor package.

Configuration options: [All] [1] [2] [3]

Limit CPUID Maximum [Disabled]

[Enabled] Allows legacy operating systems to boot even without support for CPUs with extended CPUID functions.

[Disabled] Disables this function.

Execute Disable Bit [Enabled]

- [Enabled] Enables the No-Execution Page Protection Technology.
- [Disabled] Forces the XD feature flag to always return to zero (0).

Intel® Virtualization Technology [Disabled]

- [Enabled] Allows a hardware platform to run multiple operating systems separately and simultaneously, enabling one system to virtually function as several systems.
- [Disabled] Disables this function.

Hardware Prefetcher [Enabled]

- [Enabled] Allows a hardware platform to automatically analyze the requirements and prefetch data and codes for the CPU.
- [Disabled] Disables this function.

Adjacent Cache Line Prefetch [Enabled]

- [Enabled] Allows a hardware platform to perform adjacent cache line prefetching.
- [Disabled] Disables this function.

CPU Power Management Configuration

This item allows you to manage and configure the CPU's power.

CPU Ratio [Auto]

Allows you to set the ratio between the CPU Core Clock and the BCLK Frequency. Use <+> and <-> keys to adjust the ratio. The valid value ranges vary according to your CPU model.

Enhanced Intel SpeedStep Technology [Enabled]

Allows you to enable or disable the Enhanced Intel® SpeedStep Technology (EIST).

- [Disabled] The CPU runs at its default speed.
- [Enabled] The operating system controls the CPU speed.

Turbo Mode [Enabled]

Allows you to set the processor cores to run faster than the marked frequency in a specific condition. Configuration options: [Enabled] [Disabled]

CPU C1E [Auto]

- [Enabled] Enables the C1E support function. This function must be enabled to enable or disable the Intel® Turbo Mode Technology.
- [Disabled] Disables the function.

CPU C3 Report [Auto]

Allows you to disable or enable the CPU C3 report to OS.

CPU C6 Report [Auto]

Allows you to disable or enable the CPU C6 report to OS.

Package C State Support [Auto]

Allows you to enable or disable the CPU C State support.

3.5.2 PCH Configuration

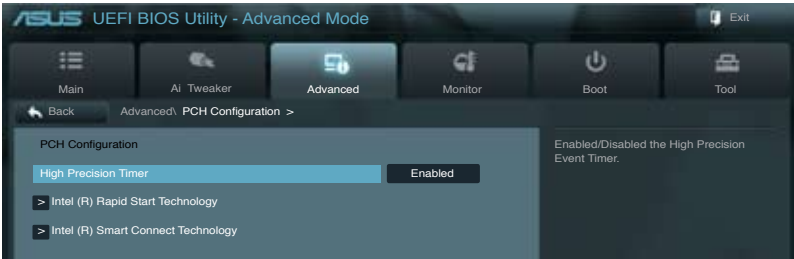

High Precision Timer [Enabled]

Allows you to enable or disable the High Precision Event Timer.

Configuration options: [Enabled] [Disabled]

Intel Smart Connect Technology [Disabled]

Allow you to enable or disable Intel Smart Connect Technology.

Configuration options: [Enabled] [Disabled]

Intel Rapid Start Technology [Disabled]

Allows you to enable or disable Intel Rapid Start Technology.

Configuration options: [Enabled] [Disabled]



The following items appear only when you set the Intel Rapid Start Technology to **[Enabled]**.

Entry on S3 RTC Wake [Enabled]

The system automatically wakes up and set to Rapid Start Technology S4 mode.

Configuration options: [Enabled] [Disabled]

Entry After [Immediately]

Allows you to set the wake-up time.

Configuration options: [Immediately] [1 minute] [2 minutes] [5 minutes] [10 minutes] [15 minutes] [30 minutes] [1 hour] [2 hours]

Active Page Threshold Support [Enabled]

The system automatically set itself to sleep when the partition size is not enough for Rapid Start Technology to work. Configuration options: [Enabled] [Disabled]

Active Memory Threshold [0]

Key in the value for the additional partition size for Rapid Start Technology to work.



Ensure that the caching partition size is larger than the total memory size.

3.5.3 SATA Configuration

While entering Setup, the BIOS automatically detects the presence of SATA devices. The SATA Port items show **Not Present** if no SATA device is installed to the corresponding SATA port.

Scroll down to display the other BIOS items.

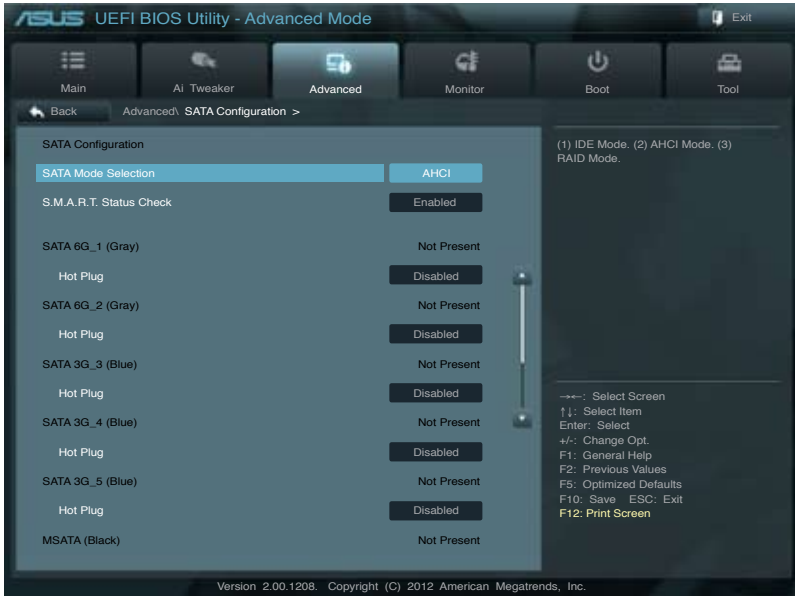

SATA Mode Selection [AHCI]

Allows you to set the SATA configuration.

- [Disabled] Disables the SATA function.
- [IDE] Set to [IDE Mode] when you want to use the Serial ATA hard disk drives as Parallel ATA physical storage devices.
- [AHCI] Set to [AHCI Mode] when you want the SATA hard disk drives to use the AHCI (Advanced Host Controller Interface). The AHCI allows the onboard storage driver to enable advanced Serial ATA features that increases storage performance on random workloads by allowing the drive to internally optimize the order of commands.
- [RAID] Set to [RAID Mode] when you want to create a RAID configuration from the SATA hard disk drives.

S.M.A.R.T. Status Check [Enabled]

S.M.A.R.T. (Self-Monitoring, Analysis and Reporting Technology) is a monitor system. When read/write of your hard disk errors occur, this feature allows the hard disk to report warning messages during the POST. Configuration options: [Enabled] [Disabled]

Hot Plug [Disabled]

These items appear only when you set the SATA Mode Selection item to [AHCI] or [RAID], and allow you to enable/disable SATA Hot Plug Support.

Configuration options: [Disabled] [Enabled]

3.5.4 System Agent Configuration

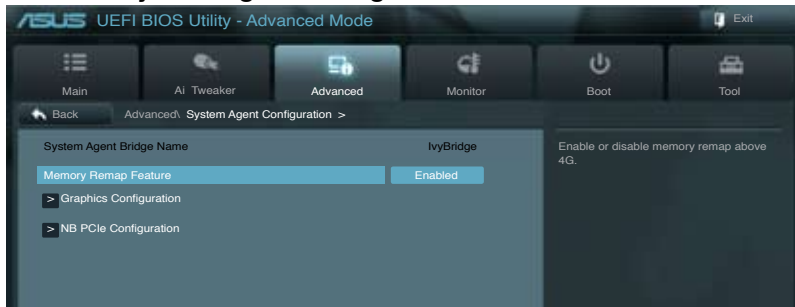

Memory Remap Feature [Enabled]

Allows you to enable remapping the memory above 4GB.

- [Enabled] Enables the function.
- [Disabled] Disables this function.

Graphics Configuration

Allows you to select a primary display from iGPU, and PCIe graphical devices.

Primary Display [Auto]

Allows you to select which of the iGPU/PCIe Graphics device should be the Primary Display. Configuration options: [Auto] [iGPU] [PCIe]

iGPU Memory [64M]

Allows you to select the amount of system memory allocated to DVMT 5.0 used by the iGPU. Configuration options: [32M] [64M] [96M] [128M] [160M] [192M] [224M] [256M] [288M][320M] [352M] [384M] [416M] [448M] [480M] [512M] [1024M]

Render Standby [Enabled]

Allows you to enable the Intel Graphics Render Standby support to reduce the iGPU power use when idle. Configuration options: [Disabled] [Enabled]

iGPU Multi-Monitor [Disabled]

Allows you to enable the iGPU Multi-Monitor. For Lucid Virtu MVP function supports, set this item to [Enabled] to empower both integrated and discrete graphics. iGPU shared system memory size is fixed in 64MB.
Configuration options: [Disabled] [Enabled]

NB PCIe Configuration

Allows you to configure the NB PCI Express settings.

PCIEx16 Link Speed [Auto]

Allows you to configure the PCIEx16 speed.
Configuration options: [Auto] [Gen1] [Gen2] [Gen3]

3.5.5 Intel® Thunderbolt

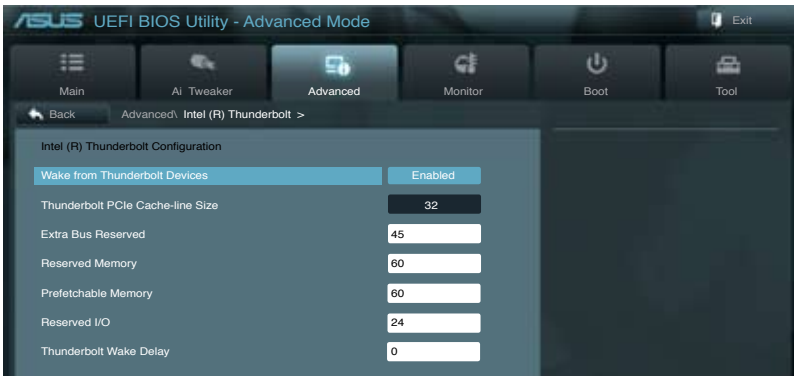

Wake From Thunderbolt Devices [Enabled]

Allows you to enable or disable the function to wake the system from Thunderbolt devices.

[Enabled] Enables the function.

[Disabled] Disables this function.

Thunderbolt PCIe Cache-line Size [32]

Allows you to configure a cache-line size.

Configuration options: [0] [1] [2] [4] [8] [16] [32] [62] [128]

Thunderbolt Wake Delay [0]

Allows you to configure a delay time to wake the system.

Per Thunderbolt device's requirement, an appropriate portion of the following system requirements will be allocated for Thunderbolt's full support functions:

Extra BUS Reserved [45]

Increase the value for multi-function monitors.

Reserved Memory [60]

Increase the value for storage/graphic devices.

Prefetchable memory [60]

Increase the value for storage/graphic devices.

Reserved I/O [24K]

Increase the value for storage devices.

3.5.6 USB Configuration

The items in this menu allow you to change the USB-related features.

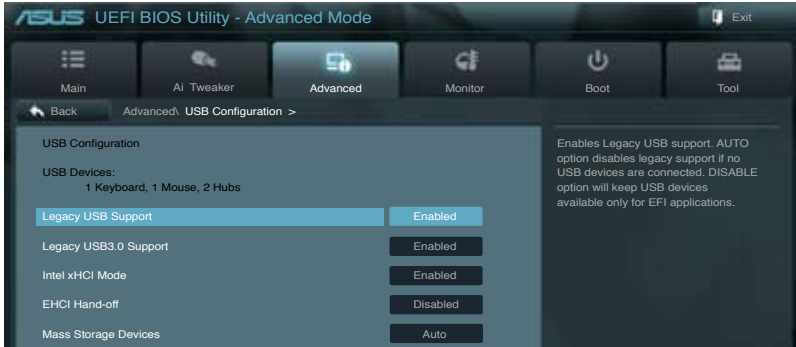

The **USB Devices** item shows the auto-detected values. If no USB device is detected, the item shows **None**.

Legacy USB Support [Enabled]

- [Enabled] Enables the support for USB devices on legacy operating systems (OS).
- [Disabled] The USB devices can be used only for the BIOS setup program.
- [Auto] Allows the system to detect the presence of USB devices at startup. If detected, the USB controller legacy mode is enabled. If no USB device is detected, the legacy USB support is disabled.

Legacy USB3.0 Support [Enabled]

- [Enabled] Enables the support for USB 3.0 devices on legacy operating systems (OS).
- [Disabled] Disables the function.

Intel xHCI Mode [Smart Auto]

- [Auto] Keeps the last operation of xHCI controller in OS during bootup.
- [Smart Auto] Enables the operation of xHCI controller.
- [Enabled] Enables the function.
- [Disabled] Disables the function.

EHCI Hand-off [Disabled]

- [Enabled] Enables the support for operating systems without an EHCI hand-off feature.
- [Disabled] Disables the function.

Mass Storage Devices [Auto]

Allows you to set the type of emulation for your USB storage devices.

Configuration options: [Auto] [Floppy] [Forced FDD] [Hard-disk] [CD-ROM]

3.5.7 Onboard Devices Configuration

Scroll down to view the other BIOS items.

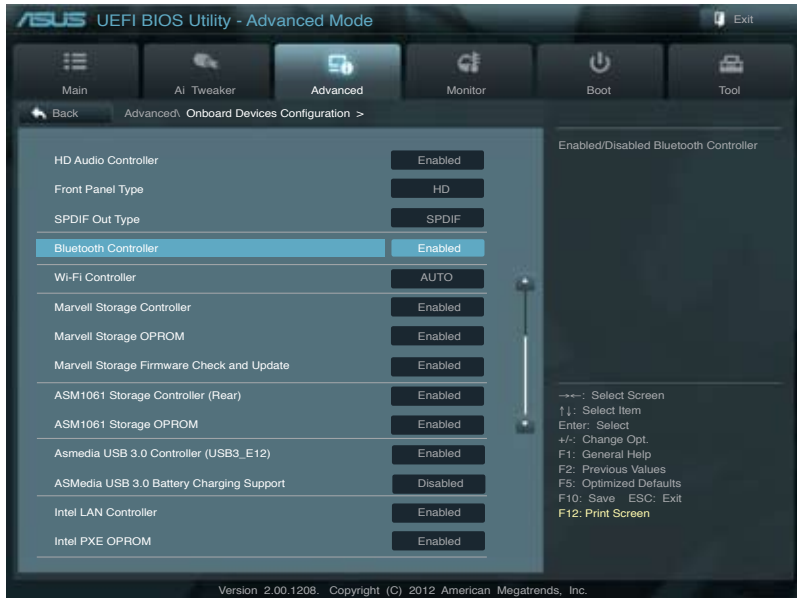

HD Audio Controller [Enabled]

[Enabled] Enables the High Definition Audio Controller.

[Disabled] Disables the controller.



The following two items appear only when you set the **Azalia HD Audio** item to [Enabled].

Front Panel Type [HD]

Allows you to set the front panel audio connector (AAFP) mode to legacy AC'97 or high-definition audio depending on the audio standard that the front panel audio module supports.

[HD] Sets the front panel audio connector (AAFP) mode to high definition audio.

[AC97] Sets the front panel audio connector (AAFP) mode to legacy AC'97

SPDIF Out Type [SPDIF]

[SPDIF] Sets to [SPDIF] for SPDIF audio output.

[HDMI] Sets to [HDMI] for HDMI audio output.

Bluetooth Controller [Enabled]

- [Enabled] Enables the onboard Bluetooth controller.
- [Disabled] Disables the onboard Bluetooth controller.

Wi-Fi Controller [Enabled]

- [Enabled] Enables the onboard Wi-Fi controller.
- [Disabled] Disables the onboard Wi-Fi controller.

Marvell Storage Controller [Enabled]

Allows you to select the Marvell® storage controller operating mode.

- [Disabled] Disables the Marvell® controller.
- [Enabled] Enables the Marvell® controller.

Marvell Storage OPROM [Enabled]

This item appears only when you set the previous item to [Enabled] and allows you to enable or disable the OptionRom of the Marvell® storage controller.

Configuration options: [Enabled] [Disabled]

Marvell Storage Firmware Check and Update [Disabled]

- [Disabled] Disables firmware check and update.
- [Enabled] Enables firmware check and update.

ASM1061 Storage Controller (Rear) [Enabled]

Allows you to select the ASM1061 storage controller operating mode.

- [Disabled] Disables the ASM1061 storage controller.
- [Enabled] Enables the ASM1061 storage controller.

ASM1061 Storage OPROM [Enabled]

This item appears only when you set the previous item to [Enabled] and allows you to enable or disable the OptionRom of the ASM1061 storage controller.

Configuration options: [Enabled] [Disabled]

ASmedia USB 3.0 Controller (USB3_E12) [Enabled]

- [Enabled] Enables the USB 3.0 controller.
- [Disabled] Disables the USB 3.0 controller.

ASmedia USB 3.0 Battery Charging Support [Disabled]

- [Enabled] Enables Asmedia USB 3.0 fast battery charging support for USB 3.0 devices complying with the BC 1.1 regulation.
- [Disabled] Disables battery charging support.

Intel LAN1 Controller [Enabled]

- [Enabled] Enables the Intel® LAN controller (LAN1_USB3_34).
- [Disabled] Disables the Intel® LAN controller.

Intel PXE OPROM [Disabled]

This item appears only when you set the previous item to [Enabled] and allows you to enable or disable the PXE OptionRom of the Intel LAN controller.

Configuration options: [Enabled] [Disabled]

Intel LAN2 Controller [Enabled]

[Enabled] Enables the Intel controller (LAN2_USB_56).

[Disabled] Disables the Intel controller (LAN2_USB_56).

Intel PXE OPROM [Disabled]

This item appears only when you set the previous item to [Enabled] and allows you to enable or disable the PXE OptionRom of the Intel 82583 LAN.

Configuration options: [Enabled] [Disabled]

3.5.8 APM

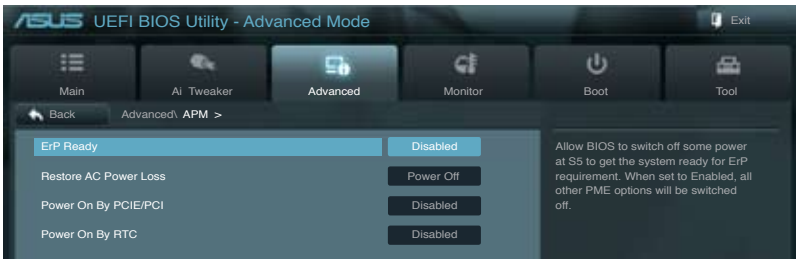

ErP Ready [Disabled]

This item allows user to switch off some power at S5 to get the system ready for ErP requirement. When set to [Enabled], all other PME options will be switched off.

Configuration options: [Disabled] [Enabled]

Restore AC Power Loss [Power Off]

[Power On] The system goes into on state after an AC power loss.

[Power Off] The system goes into off state after an AC power loss.

[Last State] The system goes into either off or on state, whatever the system state was before the AC power loss.

Power On By PCIE/PCI [Disabled]

[Disabled] Disables the PCIE/PCI devices to generate a wake-on-LAN feature of the Intel/Realtek LAN device.

[Enabled] Enables the PCIE/PCI devices to generate a wake-on-LAN feature of the Intel/Realtek LAN device.

Power On By RTC [Disabled]

[Disabled] Disables RTC to generate a wake event.

[Enabled] When set to [Enabled], the items **RTC Alarm Date (Days)** and **Hour/Minute/Second** will become user-configurable with set values.

3.5.9 Network Stack

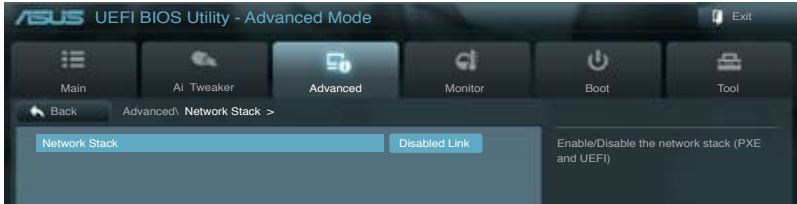

Network Stack [Disable Link]

This item allows user to disable or enable the UEFI network stack.

Configuration options: [Disable Link] [Enable]



The following item appears only when you set the Network Stack to [Enabled].

Ipv4/Ipv6 PXE Support [Enabled]

Allows you to enable or disable the Ipv4/Ipv6 PXE boot option.

Configuration options: [Disabled Link] [Enabled]

3.6 Monitor menu

The Monitor menu displays the system temperature/power status, and allows you to change the fan settings.

Scroll down to display the other BIOS items.

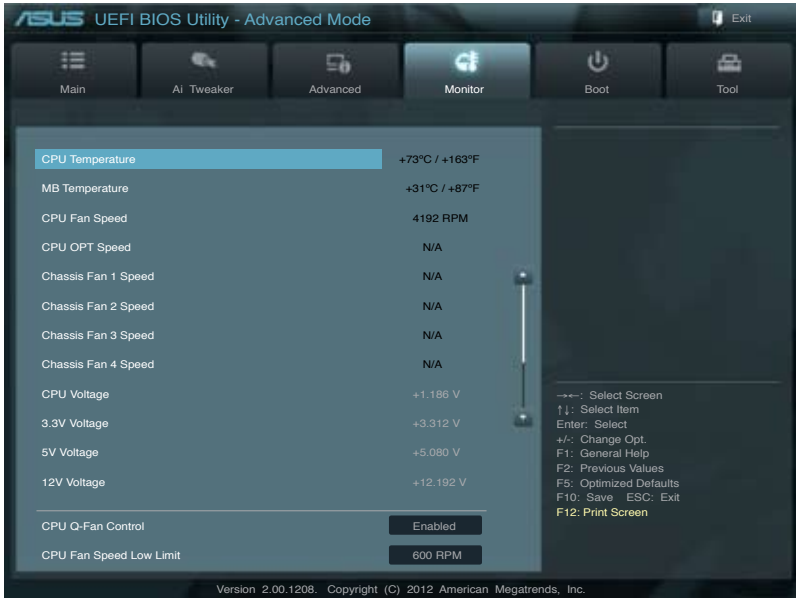

CPU Temperature / MB Temperature [xxx°C/xxx°F]

The onboard hardware monitor automatically detects and displays the CPU and motherboard temperatures. Select **Ignore** if you do not wish to display the detected temperatures.

CPU Fan Speed [xxxx RPM] or [Ignore] / [N/A], CPU OPT Speed [xxxx RPM] or [Ignore] / [N/A], Chassis Fan 1/4 Speed [xxxx RPM] or [Ignore] / [N/A]

The onboard hardware monitor automatically detects and displays the CPU, chassis, and power fan speed in rotations per minute (RPM). If the fan is not connected to the motherboard, the field shows N/A. Select **Ignore** if you do not wish to display the detected speed.

CPU Q-Fan Control [Enabled]

[Disabled] Disables the CPU Q-Fan control feature.

[Enabled] Enables the CPU Q-Fan control feature.

CPU Fan Speed Low Limit [600 RPM]

This item appears only when you enable the CPU Q-Fan Control feature and allows you to disable or set the CPU fan warning speed. Configuration options: [Ignore] [200 RPM] [300 RPM] [400 RPM] [500 RPM] [600 RPM]

CPU Fan Profile [Standard]

This item appears only when you enable the **CPU Q-Fan Control** feature and allows you to set the appropriate performance level of the CPU fan.

[Standard] Sets to [Standard] to make the CPU fan automatically adjust depending on the CPU temperature.

[Silent] Sets to [Silent] to minimize the fan speed for quiet CPU fan operation.

[Turbo] Sets to [Turbo] to achieve maximum CPU fan speed.

[Manual] Sets to [Manual] to assign detailed fan speed control parameters.



The following four items appear only when you set CPU Fan Profile to [Manual].

CPU Upper Temperature [70]

Use the <+> and <-> keys to adjust the upper limit of the CPU temperature. The values range from 40°C to 90°C.

CPU Fan Max. Duty Cycle(%) [100]

Use the <+> and <-> keys to adjust the maximum CPU fan duty cycle. The values range from 20% to 100%. When the CPU temperature reaches the upper limit, the CPU fan will operate at the maximum duty cycle.

CPU Lower Temperature [20]

Displays the lower limit of the CPU temperature.

CPU Fan Min. Duty Cycle(%) [20]

Use the <+> and <-> keys to adjust the minimum CPU fan duty cycle. The values range from 0% to 100%. When the CPU temperature is under 40°C, the CPU fan will operate at the minimum duty cycle.

Chassis Q-Fan Control 1/4 [Enabled]

[Disabled] Disables the Chassis Q-Fan control feature.

[Enabled] Enables the Chassis Q-Fan control feature.

Chassis Fan Speed Low Limit 1/4 [600 RPM]

This item appears only when you enable the Chassis Q-Fan Control feature and allows you to disable or set the chassis fan warning speed. Configuration options: [Ignore] [200 RPM] [300 RPM] [400 RPM] [500 RPM] [600 RPM]

Chassis Fan 1/4 Profile [Standard]

This item appears only when you enable the Chassis Q-Fan Control feature and allows you to set the appropriate performance level of the chassis fan.

[Standard] Sets to [Standard] to make the chassis fan automatically adjust depending on the chassis temperature.

[Silent] Sets to [Silent] to minimize the fan speed for quiet chassis fan operation.

[Turbo] Sets to [Turbo] to achieve maximum chassis fan speed.

[Manual] Sets to [Manual] to assign detailed fan speed control parameters.



The following four items appear only when you set **Chassis Fan Profile** to [Manual].

Chassis Upper Temperature [70]

Use the <+> and <-> keys to adjust the upper limit of the CPU temperature. The values range from 40°C to 90°C.

Chassis Fan Max. Duty Cycle(%) [100]

Use the <+> and <-> keys to adjust the maximum chassis fan duty cycle. The values range from 20% to 100%. When the chassis temperature reaches the upper limit, the chassis fan will operate at the maximum duty cycle.

Chassis Lower Temperature [40]

Displays the lower limit of the chassis temperature.

CPU Fan Min. Duty Cycle(%) [60]

Use the <+> and <-> keys to adjust the minimum chassis fan duty cycle. The values range from 0% to 100%. When the chassis temperature is under 40°C, the chassis fan will operate at the minimum duty cycle.

CPU Voltage, 3.3V Voltage, 5V Voltage, 12V Voltage

The onboard hardware monitor automatically detects the voltage output through the onboard voltage regulators. Select Ignore if you do not want to detect this item.

Anti Surge Support [Enabled]

This item allows you to enable or disable the Anti Surge function.

Configuration options: [Disabled] [Enabled]

3.7 Boot menu

The Boot menu items allow you to change the system boot options.

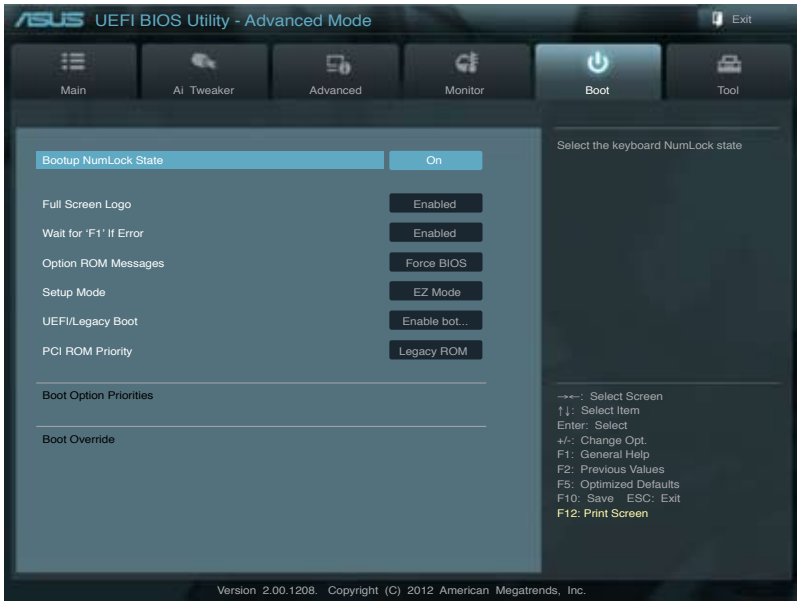

Bootup NumLock State [On]

[On] Sets the power-on state of the NumLock to [On].

[Off] Sets the power-on state of the NumLock to [Off].

Full Screen Logo [Enabled]

[Enabled] Enables the full screen logo display feature.

[Disabled] Disables the full screen logo display feature.



Set this item to [Enabled] to use the ASUS MyLogo 2™ feature.

Wait For 'F1' If Error [Enabled]

[Disabled] Disables this function.

[Enabled] The system waits for the <F1> key to be pressed when error occurs.

Option ROM Messages [Force BIOS]

- [Force BIOS] The third-party ROM messages will be forced to display during the boot sequence.
- [Keep Current] The third-party ROM messages will be displayed only if the third-party manufacturer had set the add-on device to do so.

Setup Mode [EZ Mode]

- [Advanced Mode] Sets Advanced Mode as the default screen for entering the BIOS setup program.
- [EZ Mode] Sets EZ Mode as the default screen for entering the BIOS setup program.

UEFI/Legacy Boot [Enable both UEFI and Legacy]

- [Enable both UEFI and Legacy] Enables both UEFI and Legacy boot.
- [Disable UEFI] Enables the Legacy boot, and disables the UEFI boot.
- [Disable Legacy] Enables the UEFI boot, and disables the Legacy boot.

PCI ROM Priority [Legacy ROM]

- [Legacy ROM] Launch Legacy ROM
- [EFI Compatible ROM] Launch UEFI Compatible ROM

Boot Option Priorities

These items specify the boot device priority sequence from the available devices. The number of device items that appears on the screen depends on the number of devices installed in the system.



-
- To access Windows OS in Safe Mode, do any of the following:
 - Press <F5> when ASUS Logo appears.
 - Press <F8> after POST.
 - To select the boot device during system startup, press <F8> when ASUS Logo appears.
-

Boot Override

These items displays the available devices. The number of device items that appears on the screen depends on the number of devices installed in the system. Click an item to start booting from the selected device.

3.8 Tools menu

The Tools menu items allow you to configure options for special functions. Select an item then press <Enter> to display the submenu.

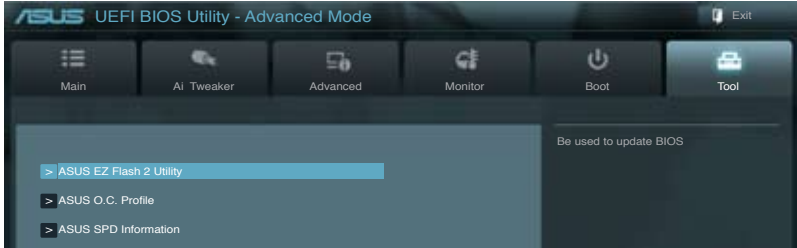

3.8.1 ASUS EZ Flash 2 Utility

Allows you to run ASUS EZ Flash 2. When you press <Enter>, a confirmation message appears. Use the left/right arrow key to select between [Yes] or [No], then press <Enter> to confirm your choice.



For more details, refer to section 3.10.2 ASUS EZ Flash 2 utility.

3.8.2 ASUS O.C. Profile

This item allows you to store or load multiple BIOS settings.

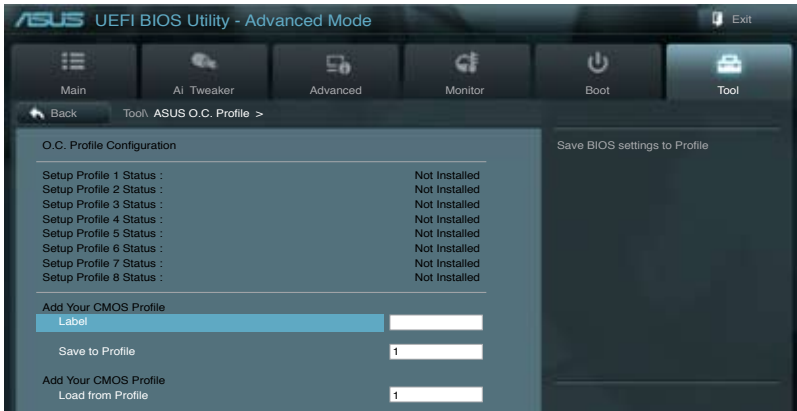

The Setup Profile Status items show Not Installed if no profile is created.

Save to Profile

Allows you to save the current BIOS settings to the BIOS Flash, and create a profile. Key in a profile number from one to eight, press <Enter>, and then select **Yes**.

Load from Profile

Allows you to load the previous BIOS settings saved in the BIOS Flash. Key in the profile number that saved your BIOS settings, press <Enter>, and then select **Yes**.



- DO NOT shut down or reset the system while updating the BIOS to prevent the system boot failure!
- We recommend that you update the BIOS file only coming from the same memory/CPU configuration and BIOS version.

3.8.3 ASUS SPD Information

Allows you to view the DRAM SPD information.

The screenshot shows the ASUS UEFI BIOS Utility in Advanced Mode. The 'Tool' menu is selected, displaying 'ASUS SPD Information'. The DIMM Slot # is DIMM_A2. The SPD information is as follows:

JEDEC ID	JEDEC	XMP #1	XMP #2
Frequency(Mhz)	1333	1333	
Voltage (V)	1.500	1.600	
CAS# Latency (ICL)	9	7	
RAS# to CAS# (tRCD)	9	7	
RAS# Precharge (tRP)	24	21	
tRAS	33	31	
tWR	10	10	
tRRD	4	5	
tRFC	74	1707	
tWTR	5	5	
tRTP	5	5	
tFAW	20	24	
tCWL		6	
Command Rate		2	

Manufacturer: Team Group Inc.
Module Size: 2048 MBytes
Maximum Bandwidth: 1333 Mhz
Part Number: Tri-Dark-1333
Serial Number: 06036919
Product Week/Year: 50/2012
SPD Ext.: XMP
XMP Rev.: 1.2

Legend:
←→: Select Screen
↑↓: Select Item
Enter: Select
+/: Change Opt.
F1: General Help
F2: Previous Values
F5: Optimized Defaults
F10: Save ESC: Exit
F12: Print Screen

Version 2.00.1208. Copyright (C) 2012 American Megatrends, Inc.

3.9 Exit menu

The Exit menu items allow you to load the optimal default values for the BIOS items, and save or discard your changes to the BIOS items. You can access the EZ Mode from the Exit menu.

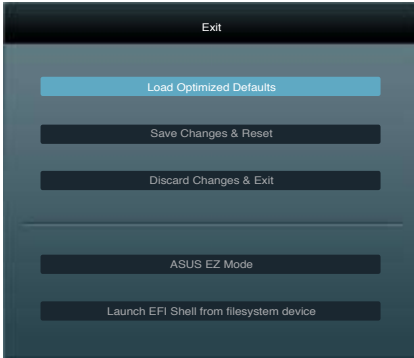

Load Optimized Defaults

This option allows you to load the default values for each of the parameters on the Setup menus. When you select this option or if you press <F5>, a confirmation window appears. Select **Yes** to load the default values.

Save Changes & Reset

Once you are finished making your selections, choose this option from the Exit menu to ensure the values you selected are saved. When you select this option or if you press <F10>, a confirmation window appears. Select **Yes** to save changes and exit.

Discard Changes & Exit

This option allows you to exit the Setup program without saving your changes. When you select this option or if you press <Esc>, a confirmation window appears. Select **Yes** to discard changes and exit.

ASUS EZ Mode

This option allows you to enter the EZ Mode screen.

Launch EFI Shell from filesystem device

This option allows you to attempt to launch the EFI Shell application (shellx64.efi) from one of the available filesystem devices.

3.10 Updating BIOS

The ASUS website publishes the latest BIOS versions to provide enhancements on system stability, compatibility, or performance. However, BIOS updating is potentially risky. If there is no problem using the current version of BIOS, DO NOT manually update the BIOS. Inappropriate BIOS updating may result in the system's failure to boot. Carefully follow the instructions of this chapter to update your BIOS if necessary.



Visit the ASUS website (www.asus.com) to download the latest BIOS file for this motherboard.

The following utilities allow you to manage and update the motherboard BIOS setup program.

1. **ASUS Update:** Updates the BIOS in Windows® environment.
2. **ASUS EZ Flash 2:** Updates the BIOS using a USB flash drive.
3. **ASUS CrashFree BIOS 3:** Restores the BIOS using the motherboard support DVD or a USB flash drive when the BIOS file fails or gets corrupted.
4. **ASUS BIOS Updater:** Updates and back ups the BIOS in DOS environment using the motherboard support DVD and a USB flash disk drive.



Save a copy of the original motherboard BIOS file to a USB flash disk in case you need to restore the BIOS in the future. Copy the original motherboard BIOS using the ASUS Update or BIOS Updater utilities.

3.10.1 ASUS Update

The ASUS Update is a utility that allows you to manage, save, and update the motherboard BIOS in Windows® environment.



-
- ASUS Update requires an Internet connection either through a network or an Internet Service Provider (ISP).
 - This utility is available in the support DVD that comes with the motherboard package.
-

Launching ASUS Update

To launch ASUS Update, click **Update > ASUS Update** on the AI Suite II main menu bar.



Quit all Windows® applications before you update the BIOS using this utility.

Updating the BIOS through the Internet

To update the BIOS through the Internet:

1. From the ASUS Update screen, select **Update BIOS from Internet**, and then click **Next**.



2. Select the ASUS FTP site nearest you to avoid network traffic.

If you want to enable the BIOS downgrade and auto backup functions, tick **Enable BIOS downgrade** and **Automatically backup my current BIOS**.



3. Select the BIOS version that you want to download. Click **Next**.



Updating the BIOS through a BIOS file

To update the BIOS through a BIOS file:

1. From the ASUS Update screen, select **Update BIOS from file**, and then click **Next**.



2. Locate the BIOS file and click **Next**.



3. You can decide whether to change the BIOS boot logo. Click **Yes** if you want to change the boot logo or **No** to continue.
4. Follow the onscreen instructions to complete the update process.



- The screenshots in this section are for reference only. The actual BIOS information vary by models.
- Refer to the software manual in the support DVD or visit the ASUS website at www.asus.com for detailed software configuration.

3.10.2 ASUS EZ Flash 2

ASUS EZ Flash 2 allows you to update the BIOS without having to use a bootable floppy disk or an OS-based utility.



Before you start using this utility, download the latest BIOS from the ASUS website at www.asus.com.

To update the BIOS using EZ Flash 2:

1. Insert the USB flash disk that contains the latest BIOS file to the USB port.
2. Enter the Advanced Mode of the BIOS setup program. Go to the Tool menu to select ASUS EZ Flash Utility and press <Enter> to enable it.

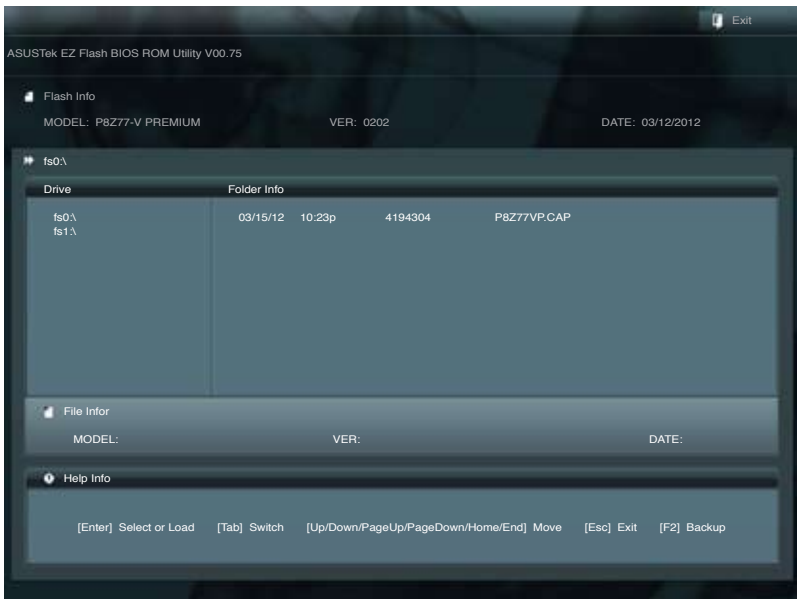

3. Press <Tab> to switch to the Drive field.
4. Press the Up/Down arrow keys to find the USB flash disk that contains the latest BIOS, and then press <Enter>.
5. Press <Tab> to switch to the Folder Info field.
6. Press the Up/Down arrow keys to find the BIOS file, and then press <Enter> to perform the BIOS update process. Reboot the system when the update process is done.



-
- This function can support devices such as a USB flash disk with FAT 32/16 format and single partition only.
 - DO NOT shut down or reset the system while updating the BIOS to prevent system boot failure!
-



Ensure to load the BIOS default settings to ensure system compatibility and stability. Select the Load Optimized Defaults item under the Exit menu. See section **3.9 Exit Menu** for details.

3.10.3 ASUS CrashFree BIOS 3

The ASUS CrashFree BIOS 3 utility is an auto recovery tool that allows you to restore the BIOS file when it fails or gets corrupted during the updating process. You can restore a corrupted BIOS file using the motherboard support DVD or a USB flash drive that contains the BIOS file.



The BIOS file in the motherboard support DVD may be older than the BIOS file published on the ASUS official website. If you want to use the newer BIOS file, download the file at support.asus.com and save it to a USB flash drive.

Recovering the BIOS

To recover the BIOS:

1. Turn on the system.
2. Insert the motherboard support DVD to the optical drive, or the USB flash drive containing the BIOS file to the USB port.
3. The utility automatically checks the devices for the BIOS file. When found, the utility reads the BIOS file and enters ASUS EZ Flash 2 automatically.
4. The system requires you to enter BIOS Setup to recover the BIOS setting. To ensure system compatibility and stability, we recommend that you press <F5> to load default BIOS values.



DO NOT shut down or reset the system while updating the BIOS! Doing so can cause system boot failure!

3.10.4 ASUS BIOS Updater

The ASUS BIOS Updater allows you to update the BIOS in DOS environment. This utility also allows you to copy the current BIOS file that you can use as a backup when the BIOS fails or gets corrupted during the updating process.



The succeeding utility screens are for reference only. The actual utility screen displays may not be same as shown.

Before updating BIOS

1. Prepare the motherboard support DVD and a USB flash drive in FAT32/16 format and single partition.
2. Download the latest BIOS file and BIOS Updater from the ASUS website at <http://support.asus.com> and save them on the USB flash drive.



- NTFS is not supported under DOS environment. Do not save the BIOS file and BIOS Updater to a hard disk drive or USB flash drive in NTFS format.
 - Do not save the BIOS file to a floppy disk due to low disk capacity.
-

3. Turn off the computer and disconnect all SATA hard disk drives (optional).

Booting the system in DOS environment

1. Insert the USB flash drive with the latest BIOS file and BIOS Updater to the USB port.
2. Boot your computer. When the ASUS Logo appears, press <F8> to show the BIOS Boot Device Select Menu. Insert the support DVD into the optical drive and select the optical drive as the boot device.

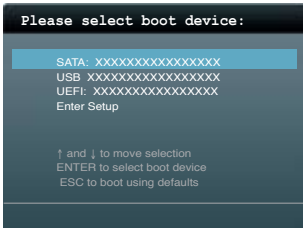

- When the Make Disk menu appears, select the FreeDOS command prompt item by pressing the item number.
- At the FreeDOS prompt, type d: and press <Enter> to switch the disk from Drive C (optical drive) to Drive D (USB flash drive).

```

Welcome to FreeDOS (http://www.freedos.org) !
C:\>d:
D:\>

```

Updating the BIOS file

To update the BIOS file using BIOS Updater:

- At the FreeDOS prompt, type bupdater /pc /g and press <Enter>.

```

D:\>bupdater /pc /g

```

- The BIOS Updater screen appears as below.

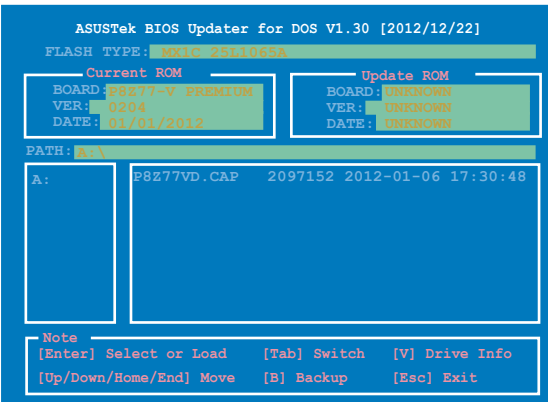

- Press <Tab> to switch between screen fields and use the <Up/Down/Home/End> keys to select the BIOS file and press <Enter>. BIOS Updater checks the selected BIOS file and prompts you to confirm BIOS update.



4. Select Yes and press <Enter>. When BIOS update is done, press <ESC> to exit BIOS Updater. Restart your computer.



DO NOT shut down or reset the system while updating the BIOS to prevent system boot failure!



- For BIOS Updater version 1.04 or later, the utility automatically exits to the DOS prompt after updating BIOS.
 - Ensure to load the BIOS default settings to ensure system compatibility and stability. Select the **Load Optimized Defaults** item under the **Exit** BIOS menu. See Chapter 3 of your motherboard user manual for details.
 - Ensure to connect all SATA hard disk drives after updating the BIOS file if you have disconnected them.
-

Software support

4

4.1 Installing an operating system



- This motherboard supports Windows® XP/ 64-bit XP/ 7 / 64-bit 7 operating systems (OS).
- Motherboard settings and hardware options vary. Use the setup procedures presented in this chapter for reference only. Refer to your OS documentation for detailed information.
- Ensure that you install the Windows® XP Service Pack 3 or later versions before installing the drivers for better compatibility and system stability.

4.2 Support DVD information



The contents of the support DVD are subject to change at any time without notice. Visit the ASUS website at www.asus.com for updates.

4.2.1 Running the support DVD

Place the support DVD into the optical drive. The DVD automatically displays the Drivers menu if Autorun is enabled in your computer. Click each menu tab and select the items you want to install.

The Drivers menu shows the available device drivers if the system detects installed devices. Install the necessary drivers to use the devices.

The Make Disk menu contains items to create the RAID/AHCI driver disk.

The Manual menu contains the list of supplementary user manuals. Click an item to open the folder of the user manual.

The Utilities menu shows the applications and other software that the motherboard supports.

Click an item to install



Click the Contact tab to display the ASUS contact information.

Click an icon to display DVD/motherboard information



If Autorun is NOT enabled in your computer, browse the contents of the support DVD to locate the file ASSETUP.EXE from the BIN folder. Double-click the ASSETUP.EXE to run the DVD.

4.2.2 Obtaining the software manuals

The software manuals are included in the support DVD. Follow the instructions below to get the necessary software manuals.



The software manual files are in Portable Document Format (PDF). Install the Adobe® Acrobat® Reader from the Utilities menu before opening the files.

1. Click the **Manual** tab. Click **ASUS Motherboard Utility Guide** from the manual list on the left.



2. The **Manual** folder of the support DVD appears. Double-click the folder of your selected software.

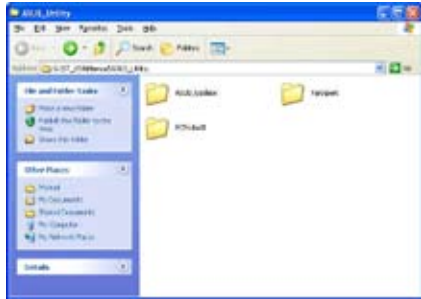

3. Some software manuals are provided in different languages. Double-click the language to show the software manual.

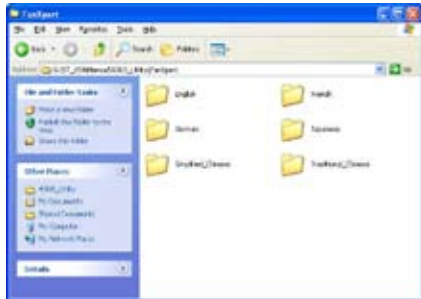

The screenshots in this section are for reference only. The actual software manuals containing in the support DVD vary by models.

4.3 Software information

Most of the applications in the support DVD have wizards that will conveniently guide you through the installation. View the online help or readme file that came with the software application for more information.

4.3.1 AI Suite II

AI Suite II is an all-in-one interface that integrates several ASUS utilities and allows users to launch and operate these utilities simultaneously.

Installing AI Suite II

To install AI Suite II on your computer:

1. Place the support DVD to the optical drive. The Drivers installation tab appears if your computer has enabled the Autorun feature.
2. Click **Utilities** tab > **AI Suite II**.
3. Follow the onscreen instructions to complete the installation.

Using AI Suite II

AI Suite II automatically starts when you enter the Windows® operating system (OS). The AI Suite II icon appears in the Windows® notification area. Click the icon to open the AI Suite II main menu bar.

Click each button to select and launch a utility, to monitor the system, to update the motherboard BIOS, to display the system information, and to customize the settings of AI Suite II.

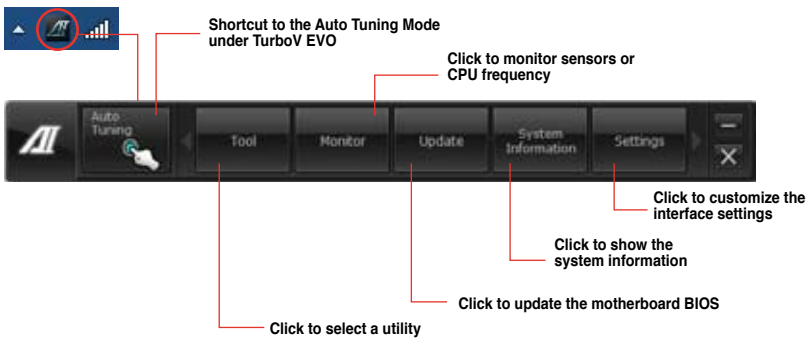

- The **Auto Tuning** button appears only on models with the TurboV EVO function.
- The applications in the **Tool** menu vary with motherboard models and CPUs installed.
- The screenshots of AI Suite II in this user manual are for reference only. The actual screenshots vary with models.
- Refer to the software manual in the support DVD or visit the ASUS website at www.asus.com for detailed software configuration.

4.3.2 TurboV EVO

ASUS TurboV EVO includes **TurboV** that allows you to manually adjust the CPU frequency and related voltages such as **Auto Tuning** that offers automatic and easy overclocking and system boost performance.

To launch AI Suite II, click **Tool > TurboV EVO** on the AI Suite II main menu bar..



Refer to the software manual in the support DVD or visit the ASUS website at www.asus.com for detailed software configuration.

TurboV

TurboV allows you to overclock the BCLK frequency, CPU voltage, and DRAM voltage in Windows® environment and in real-time without exiting and rebooting the OS.



Refer to the CPU documentation before adjusting CPU voltage settings. Setting a high voltage may damage the CPU permanently, and setting a low voltage may lead to an unstable system.



For system stability, all changes made in TurboV will not be saved to BIOS settings and will not be kept on the next system boot. Use the Save Profile function to save your customized overclocking settings and manually load the profile after Windows starts.

The screenshot shows the ASUS TurboV EVO interface with the following annotations:

- Click to select mode:** Points to the 'Manual Mode' button.
- Load profile:** Points to the 'Load Profile' button.
- Target values:** Points to the 'Target' column in the 'CPU Profile' table.
- Current values:** Points to the 'Current' column in the 'CPU Profile' table.
- Click to show settings:** Points to the 'Show Settings' button.
- Click to restore all startup settings:** Points to the 'Restore Startup Settings' button.
- Save the current settings as a new profile:** Points to the 'Save Profile' button.
- Voltage Adjustment bars:** Points to the voltage adjustment sliders for VCC3P0, CPU VLL, and CPU VDD.
- Undoes all the changes:** Points to the 'Undo' button.
- Applies all the changes immediately:** Points to the 'Apply' button.

Profile	Target	Current
SCM Pressure	100.0	100.0
CPU Voltage	1.000	1.000
DDR Voltage	1.500	1.500

Using Advanced Mode

Click on the **Advanced Mode** tab to adjust the advanced voltage settings.

The screenshot shows the ASUS TurboV EVO software interface. The 'Advanced Mode' tab is selected. The interface is divided into several sections:

- Manual Mode:** Shows profiles (Profile 1, Profile 2) and a 'Save Profile' button.
- Advanced Mode:** Contains a table of settings for CPU Voltage, CPU Freq., GPU Voltage, GPU Freq., and GPU Usage. The 'CPU Voltage' and 'CPU Freq.' columns are highlighted with a red box.
- GPU Section:** Shows GPU Frequency (0350.0 MHz) and GPU Usage (0%, 2%, 3%, 4%).
- Bottom Bar:** Contains buttons for 'Auto Tuning', 'Tool', 'Monitor', 'Update', 'System Information', and 'Settings'.

Annotations with red arrows point to specific elements:

- Advanced mode:** Points to the 'Advanced Mode' tab.
- Target values:** Points to the 'CPU Voltage' and 'CPU Freq.' columns.
- Current values:** Points to the 'CPU Voltage' and 'CPU Freq.' columns.
- Click to restore all startup settings:** Points to the 'Auto Tuning' button.
- Undoes all the changes:** Points to the 'Auto Tuning' button.
- Applies all the changes immediately:** Points to the 'Auto Tuning' button.
- Voltage Adjustment bars:** Points to the horizontal sliders for CPU Voltage and CPU Freq.

CPU Ratio

Allows you to manually adjust the CPU ratio.



- The first time you use CPU Ratio, go to **AI Tweaker > CPU Power Management** in BIOS and set the **Turbo Ratio** item to **[Maximum Turbo Ratio setting in OS]**.
- Set the CPU Ratio Setting item in BIOS to [Auto] before using the CPU Ratio function in TurboV. Refer to the BIOS chapter of your motherboard user manual for details.
- The CPU Ratio bars show the status of the CPU cores, which vary with your CPU model.

1. Click on the CPU Ratio tab.
2. Drag the adjustment bar upwards or downwards to the desired value.
3. Click Apply to save the changes made.



GPU Boost

GPU Boost overclocks the integrated iGPU for the best graphics performance.

1. Click **More Settings > GPU Boost** tab.
2. Adjust the iGPU Max Frequency and iGPU Voltage.
3. Click Yes to save the changes made.



Auto Tuning

ASUS TurboV EVO provides you with these two auto-tuning modes for the most flexible auto-tuning options.



- The overclocking result varies with the CPU model and the system configuration.
- We recommend that you set up a better thermal environment to prevent overheating from damaging the motherboard.

- **Fast Tuning:** fast CPU/iGPU overclocking
- **Extreme Tuning:** extreme overclocking for CPU/iGPU

Using Fast Tuning

1. Click **Auto Tuning** tab > **Fast**.
2. Read the warning messages and click OK to start the auto-overclocking process.

TurboV automatically overclocks the CPU, saves the BIOS settings, and restarts the system.



- After the system restarts, a message appears indicating that auto-tuning is successful. Click OK to exit.



Using Extreme Tuning

- Click **Auto Tuning** tab > **Extreme**.
- Read the warning messages and click OK to start the auto-overclocking process.

TurboV automatically overclocks the CPU and memory, and restarts the system.



- After the system has restarted, a message appears indicating the current overclocking result. To keep the result, click Stop.



- If you did not click Stop in the previous step, TurboV automatically starts further system overclocking and stability test. Click Stop if you want to cancel the overclocking process.

TurboV automatically adjusts and saves the BIOS settings and restarts the system.



- After the system has restarted, a message appears indicating that the auto-tuning process is successful. Click OK to exit.



4.3.3 DIGI+ Power Control

ASUS DIGI+ Power Control allows you to adjust VRM voltage and frequency modulation to enhance reliability and stability. It also provides the highest power efficiency, generating less heat to prolong the component lifespan and minimize power loss.

To launch DIGI+ Power Control, click **Tool > Power Control** on the AI Suite II main menu bar.

Smart DIGI+



1 Smart DIGI+ Key

Quickly delivers a higher VRM frequency, voltage, and current for superior CPU/iGPU/DRAM overlocking performance with one switch.

2 Smart CPU Power Level - 45W

CPU power usage is limited to 45W to achieve the best digital power saving conditions.

3 Smart CPU Power Level - 35W

CPU power usage is limited to 35W to achieve the best digital power saving mode.

4 OC Now!

Adjusts the CPU ratio in TurboV EVO.

5 Default (Smart DIGI+ Setting)

Sets your CPU/iGPU/DRAM power to default settings.

6 Default (Smart CPU Power Level)

Sets your power consumption to CPU default setting.



- Enabling the Smart CPU Power Level may decrease the total power delivery to the CPU, and affect the CPU performance under a heavy system load. The system restores to its default settings on the next startup.
 - Only Intel® 3rd generation processors support the Smart DIGI+ Technology feature.
-

CPU Power



1 CPU Load-line Calibration

It allows you to adjust the voltage settings and control the system temperature. Higher load-line calibration could get higher voltage and good overclocking performance but increases the CPU and VRM thermal conditions.

2 CPU Current Capability

CPU Current Capability provides wider total power range for overclocking. A higher value setting gets higher VRM power consumption delivery.

3 CPU Voltage Frequency

Switching frequency affects the VRM transient response and thermal components. Higher frequency gets quicker transient response.

4 iGPU Load-line Calibration

Higher value could get higher iGPU voltage and good performance but increase the CPU and VRM thermal conditions.

5 iGPU Current Capability

A higher value brings a wider total iGPU power and overclocking frequency range to enhance iGPU performance.

6 CPU Power Phase Control

Increase phase number under heavy system loading to get more transient and better thermal performance. Reduce phase number under light system loading to increase VRM efficiency.

*The system automatically sets the default to [Extreme] when using Intel® iGPU.

7 CPU Power Thermal Control

A higher temperature brings a wider CPU power thermal range, and extends the overclocking tolerance to enlarge overclocking potential.

8 CPU Power Response Control

The DIGI+ Power controller provides a faster and precise power response rate for CPU. Apply a higher value for an extreme overclocking.

9 CPU Power Duty Control

CPU Power Duty Control adjusts the current of every VRM phase and the thermal conditions of every phase component.

DRAM Power

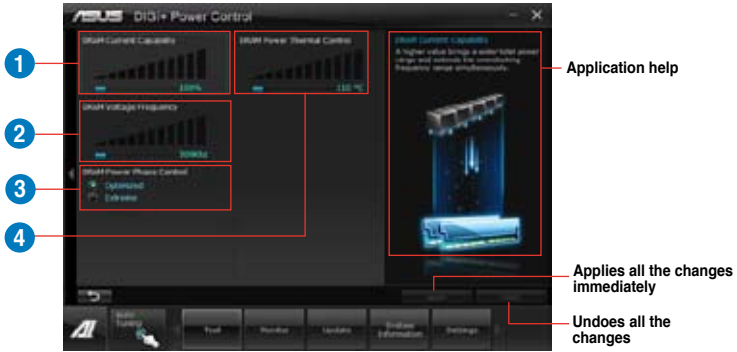

1 DRAM Current Capability

A higher value brings a wider total power range and extends the overclocking frequency range simultaneously.

2 DRAM Voltage Frequency

Allows you to adjust the DRAM switching frequency for system stability or to increase OC Range.

3 DRAM Power Phase Control

Select Extreme for full phase mode to increase system performance or select Optimized for ASUS optimized phase tuning profile to increase DRAM power efficiency.

4 DRAM Power Thermal Control

A higher temperature brings a wider DRAM power thermal range, and extends the overclocking tolerance to enlarge overclocking potential.



- The actual performance boost may vary depending on your CPU specification.
 - Do not remove the thermal module. The thermal conditions must be monitored. •
-

4.3.4 EPU

EPU is an energy-processing utility that provides several power-saving modes. When set to the Auto Mode, the system automatically changes its power-saving mode based on the current system condition.

You can also configure the system settings such as CPU frequency, GPU frequency, vCore Voltage, and Fan Control to customize a power-saving mode.

Launching EPU

To launch EPU, click **Tool > EPU** on the AI Suite II main menu bar.

The screenshot shows the ASUS EPU interface. At the top, there are three operating modes: **Auto** (selected), **High performance**, and **Max. power saving**. Below these are several performance metrics: **Transparency**, **Performance**, **Reliability**, **Connectivity**, and **Energy saved**. A central pentagonal gauge displays the current mode. On the right, an **EPU Status** window shows: **Reduced CO2 Emission: 0.000 mg**, **Time Started: since 2010/02/28 16:12**, and **Current CPU Power: 0.00 Watts**. A bottom navigation bar includes **Auto Tuning**, **Tool**, **Monitor**, **Update**, **System Information**, and **Settings**.

Callouts and their descriptions:

- Multiple system operating modes**: Points to the top mode selection area.
- Displays the following message if no VGA power saving engine is detected.**: Points to a small error dialog box.
- The items lighting up means power saving engine is activated**: Points to the glowing icons in the EPU Status window.
- Displays the amount of CO2 reduced**: Points to the 'Reduced CO2 Emission' value.
- *Shifts between the display of Total and Current CO2 reduced**: Points to the 'Time Started' section.
- Displays the current CPU power**: Points to the 'Current CPU Power' value.
- Advanced settings for each mode**: Points to the 'Settings' button in the bottom bar.
- Displays the system properties of each mode**: Points to the central pentagonal gauge.



- Select **From EPU Installation** to show the CO2 that has been reduced since you installed EPU.
- *Select **From the Last Reset** to show the total CO2 that has been reduced since you click the **Clear** button .
- Refer to the software manual in the support DVD or visit the ASUS website at www.asus.com for detailed software configuration.

4.3.5 USB 3.0 Boost

ASUS USB 3.0 Boost technology supports UASP (USB Attached SCSI Protocol) and automatically increases a USB 3.0 device's transfer speed up to 170%.

Launching USB 3.0 Boost

To launch USB 3.0 Boost, click **Tool > USB 3.0 Boost** on the AI Suite II main menu bar.

Configuring USB 3.0 Boost

1. Connect a USB 3.0 device to the USB 3.0 port.

USB 3.0 Boost automatically detects the property of the USB 3.0 device and switches to Turbo mode or UASP mode (if UASP is supported by the USB 3.0 device).

2. You can manually switch the USB 3.0 mode back to Normal mode at any time.



- Refer to the software manual in the support DVD or visit the ASUS website at www.asus.com for detailed software configuration.
- Due to Intel® chipset limitation, Intel® USB 3.0 ports do not support ASUS 3.0 Boost in Windows XP operating system.
- Use the USB 3.0 devices for high performance. The data transfer speed varies with USB devices.

4.3.6 USB BIOS Flashback Wizard

USB BIOS Flashback allows you to easily update the BIOS without entering the BIOS or operating system. Just connect the USB storage device containing the BIOS file to the USB port, press the BIOS Flashback button, and the BIOS is updated automatically.



Scheduling the latest BIOS download

1. In the Download Setting field, tick **Schedule (days)** and select the number of days for your download schedule.
2. Click **Apply** to save the BIOS download schedule. Click Cancel to cancel the changes made.

Downloading the updated BIOS



Before you start downloading, ensure that you have installed the USB storage device to your computer's USB port.

Scheduling the latest BIOS download

1. In the Download Setting field, tick **Schedule (days)** and select the number of days for your download schedule.
2. Click **Apply** to save the BIOS download schedule. Click Cancel to cancel the changes made.

Downloading the updated BIOS

1. Click **Check for New BIOS Update** to check for the latest BIOS version.

Wait for the system to check the latest BIOS firmware.

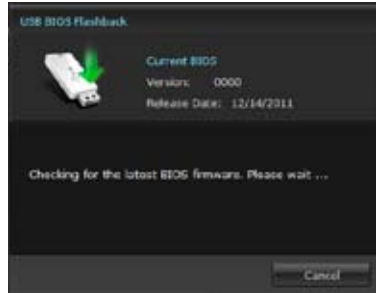

2. After the utility detects a new BIOS firmware, save the BIOS firmware by clicking  from the Save to field, select the USB flashdrive, and click Download.

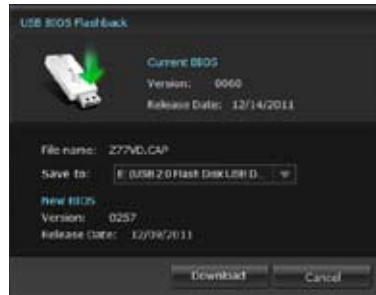

3. After the download is complete, click OK.



4.3.7 ASUS SSD Caching II

ASUS SSD Caching II uses installed SSDs for multi-caching of frequently accessed data or applications. It combines multiple SSDs' performance and hard-drive capacity to boost the system's overall performance.

Launching ASUS SSD Caching II

To launch ASUS SSD Caching, click **Tool > ASUS SSD Caching II** on the AI Suite II main menu bar.



Configuring ASUS SSD Caching II

1. Connect at least one HDD and one or more SSDs to the the Marvell® SATA ports. ASUS SSD Caching automatically detects the HDD and SSDs.
2. Tick one or more SSDs and click  parallel to the HDD you want to cache your SSD with. Wait while caching is in process.

You can also cache multiple SSDs to different HDDs at the same time.



3. To cancel caching, click .



-
- During initialization, you can proceed with doing any system operations. You can check the caching status later or wait for a pop-up message notifying that initialization is completed.
 - For regular usage, the SATA6G_E12/E34 connectors are recommended for data drives.
 - After disabling SSD Caching, the SSD will become a non-configurable disk in Windows OS. To use the SSD again for normal functions, go to Disk Management to reconfigure the SSD.
-

4.3.8 Ai Charger+

This utility allows you to fast-charge your portable BC 1.1* mobile devices on your computer's USB port three times faster than the standard USB devices**.



- * Check your manufacturer if your USB device is a Battery Charging Specification 1.1 (BC 1.1) compliant or compatible device.
- ** Actual charging speeds may vary depending on the charging rate and specifications of your USB device.
- To ensure normal charging function, disconnect and reconnect your USB device every time you enable or disable Ai Charger+.



4.3.9 Probe II

Probe II is a utility that monitors the computer's vital components, and detects and alerts you of any problem with these components. Probe II senses fan rotations, CPU temperature, and system voltages, among others. With this utility, you are assured that your computer is always at a healthy operating condition.

Launching Probe II

To launch Probe II, click **Tool > Probe II** on the AI Suite II main menu bar.

Configuring Probe II

Click the Voltage/Temperature/Fan Speed tabs to activate the sensors or to adjust the sensor threshold values. The Preference tab allows you to customize the time interval of sensor alerts, or change the temperature unit.



- Click **Monitor > Sensor** on the AI Suite II main menu bar and the system status will appear on the right panel.
- Refer to the software manual in the support DVD or visit the ASUS website at www.asus.com for detailed software configuration.

4.3.10 Sensor Recorder

Sensor Recorder monitors the changes in the system voltage, temperature, and fan speed on a timeline. The History Record function allows you to designate specific time spans on record to keep track of the three system statuses for certain purposes.

Launching Sensor Recorder

To launch Sensor Recorder, click Tool > Sensor Recorder on the AI Suite II main menu bar.

Using Sensor Recorder

Click on Voltage/ Temperature/ Fan Speed tabs for the status you want to monitor. Colored lines will automatically appear on the diagram to indicate the immediate changes in the system status.



Using History Record

1. Click the History Record tab and adjust the settings on the left for Record Interval and Record Duration according to need.
2. Click Start Recording to start measuring and recording each sensor.
3. To stop recording, click Recording again.
4. To track the recorded contents, set Type/ Date/ Select display items to display the history details.

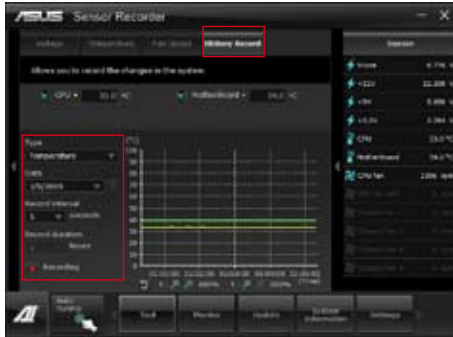

Click on Monitor > Sensor on the AI Suite II main menu bar and a highlight of the system statuses will appear on the right panel.

4.3.11 ASUS Update

ASUS Update is a utility that allows you to manage, save, and update the motherboard BIOS in Windows® environment.

Launching ASUS Update

To launch ASUS Update, click **Update > ASUS Update** on the AI Suite II main menu bar.

Using ASUS Update

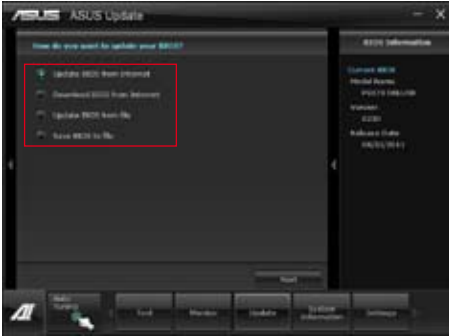

Select any of these options to update the BIOS:

- **Update BIOS from Internet**

Allows you to download the latest BIOS version from the ASUS website at www.asus.com and follow the onscreen instructions to update the BIOS.

- **Download BIOS from Internet**

Download the latest BIOS version from the ASUS website at www.asus.com and save it for later use.

- **Update BIOS from file**

Use the BIOS file that you had downloaded and saved to update the system BIOS.

- **Save BIOS to file**

Save the BIOS file to another file or a USB storage device for later use.

4.3.12 MyLogo2

MyLogo2 allows you to customize the boot logo, which is the image that appears on the screen during the Power On Self Tests (POST).

Launching ASUS Update

To launch MyLogo2, click **Update > MyLogo** on the AI Suite II main menu bar.

Using MyLogo



Select the option that you want to use to update your boot logo, click Next and follow the instructions below.

Change the boot logo of a downloaded BIOS file and update (or do not update) this BIOS to the motherboard

1. From the BIOS file field, click Browse to locate the BIOS file.
2. From the Picture File field, click Browse the image for your boot logo, then click Next.



3. Do any of the following:
 - Click Auto Tune to adjust the image size or the image resolution.
 - Click Booting Preview to preview the boot image.
4. Click Next.



5. Click Flash to update the boot logo.
6. When prompted, click Yes to reboot the system. You will see the new boot logo the next time you start up the system.



Ensure to enable the Full Screen Logo in BIOS to use this feature.

4.3.13 Audio configurations

The Realtek® audio CODEC provides 8-channel audio capability to deliver the ultimate audio experience on your computer. The software provides Jack-Sensing function, S/PDIF Out support, and interrupt capability. The CODEC also includes the Realtek® proprietary UAJ® (Universal Audio Jack) technology for all audio ports, eliminating cable connection errors, and giving users plug and play convenience.

Follow the installation wizard to install the Realtek® Audio Driver from the support DVD that came with the motherboard package.

If the Realtek® audio software is correctly installed, you will find the Realtek® HD Audio Manager icon on the taskbar. Double-click on the icon to display the Realtek HD Audio Manager.



Realtek® HD Audio Manager

A. Realtek HD Audio Manager with DTS UltraPC II for Windows® 7



B. Realtek HD Audio Manager for Windows® XP



- Refer to the software manual in the support DVD or visit the ASUS website at www.asus.com for detailed software configuration.
- Due to Intel® Z77 platform does not support Windows® Vista™, Realtek HD Audio driver is only supported by Windows® 7™/Windows® XP™.
- To play Blu-Ray disc, make sure to use an HDCP compliant monitor.

RAID support

5

5.1 RAID configurations

The motherboard supports the following SATA RAID solutions:

- Intel® Rapid Storage Technology with RAID 0, RAID 1, RAID 10 and RAID 5 support.
- Marvell® RAID utility with RAID 0 and RAID 1 support.



-
- You must install Windows® XP Service Pack 3 or later versions before using Serial ATA hard disk drives. The Serial ATA RAID feature is available only if you are using Windows® XP SP3 or later versions.
 - Due to Windows® XP limitation, a RAID array with the total capacity over 2TB cannot be set as a boot disk. A RAID array over 2TB can only be set as a data disk only.
 - If you want to install a Windows® operating system to a hard disk drive included in a RAID set, you have to create a RAID driver disk and load the RAID driver during OS installation. Refer to section 5.2 **Creating a RAID driver disk** for details.
-

5.1.1 RAID definitions

RAID 0 (Data striping) optimizes two identical hard disk drives to read and write data in parallel, interleaved stacks. Two hard disks perform the same work as a single drive but at a sustained data transfer rate, double that of a single disk alone, thus improving data access and storage. Use of two new identical hard disk drives is required for this setup.

RAID 1 (Data mirroring) copies and maintains an identical image of data from one drive to a second drive. If one drive fails, the disk array management software directs all applications to the surviving drive as it contains a complete copy of the data in the other drive. This RAID configuration provides data protection and increases fault tolerance to the entire system. Use two new drives or use an existing drive and a new drive for this setup. The new drive must be of the same size or larger than the existing drive.

RAID 5 stripes both data and parity information across three or more hard disk drives. Among the advantages of RAID 5 configuration include better HDD performance, fault tolerance, and higher storage capacity. The RAID 5 configuration is best suited for transaction processing, relational database applications, enterprise resource planning, and other business systems. Use a minimum of three identical hard disk drives for this setup.

RAID 10 is data striping and data mirroring combined without parity (redundancy data) having to be calculated and written. With the RAID 10 configuration you get all the benefits of both RAID 0 and RAID 1 configurations. Use four new hard disk drives or use an existing drive and three new drives for this setup.

5.1.2 Installing Serial ATA hard disks

The motherboard supports Serial ATA hard disk drives. For optimal performance, install identical drives of the same model and capacity when creating a disk array.

To install the SATA hard disks for a RAID configuration:

1. Install the SATA hard disks into the drive bays.
2. Connect the SATA signal cables.
3. Connect a SATA power cable to the power connector on each drive.

5.1.3 Setting the RAID item in BIOS

You must enable the RAID function in the BIOS Setup before creating RAID sets using SATA HDDs. To do this:

1. Enter the BIOS Setup during POST.
2. Go to the **Advanced** menu > **SATA Configuration**, and then press <Enter>.
3. Set the SATA Mode item to [RAID Mode].
4. Save your changes, and then exit the BIOS Setup.



Refer to Chapter 3 for details on entering and navigating through the BIOS Setup



Due to chipset limitation, when SATA ports are set to RAID mode, all SATA ports run at RAID mode together.

5.1.4 Intel® Rapid Storage Technology Option ROM utility

To enter the Intel® Rapid Storage Technology Option ROM utility:

1. Turn on the system.
2. During POST, press <Ctrl> + <I> to display the utility main menu.

```
Intel(R) Rapid Storage Technology - Option ROM - v10.5.1.1070
Copyright(C) 2003-10 Intel Corporation. All Rights Reserved.

[ MAIN MENU ]
1. Create RAID Volume      4. Recovery Volume Options
2. Delete RAID Volume     5. Acceleration Options
3. Reset Disks to Non-RAID 6. Exit

[ DISK/VOLUME INFORMATION ]

RAID Volumes:
None defined.

Physical Devices:
Port Device Model      Serial #      Size  Type/Status (Vol ID)
0  ST3160812AS         9LS0HJA4    149.0GB Non-RAID Disk
1  ST3160812AS         9LS0F4HL    149.0GB Non-RAID Disk
2  ST3160812AS         3LS0JYL8    149.0GB Non-RAID Disk
3  ST3160812AS         9LS0B75H    149.0GB Non-RAID Disk

[↑↓]-Select      [ESC]-Exit      [ENTER]-Select Menu
```

The navigation keys at the bottom of the screen allow you to move through the menus and select the menu options.



The RAID BIOS setup screens shown in this section are for reference only and may not exactly match the items on your screen.



The utility supports maximum four hard disk drives for RAID configuration.

Creating a RAID set

To create a RAID set:

1. From the utility main menu, select **1. Create RAID Volume** and press <Enter>. The following screen appears:



2. Enter a name for the RAID set and press <Enter>.
3. When the RAID Level item is selected, press the up/down arrow key to select a RAID level to create, and then press <Enter>.
4. When the Disks item is selected, press <Enter> to select the hard disk drives you want to include in the RAID set. The SELECT DISKS screen appears:

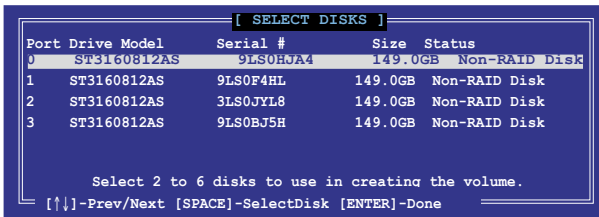

5. Use the up/down arrow key to select a drive, and then press <Space> to select. A small triangle marks the selected drive. Press <Enter> after completing your selection.
6. Use the up/down arrow key to select the stripe size for the RAID array (for RAID 0, 10 and 5 only), and then press <Enter>. The available stripe size values range from 4KB to 128KB. The following are typical values:
 - RAID 0: 128KB
 - RAID 10: 64KB
 - RAID 5: 64KB



We recommend a lower stripe size for server systems, and a higher stripe size for multimedia computer systems used mainly for audio and video editing.

7. When the **Capacity** item is selected, enter the RAID volume capacity that you want and press <Enter>. The default value indicates the maximum allowed capacity.
8. When the **Create Volume** item is selected, press <Enter>. The following warning message appears:

WARNING: ALL DATA ON SELECTED DISKS WILL BE LOST
Are you sure you want to create this volume? (Y/N):

9. Press <Y> to create the RAID volume and return to the main menu, or <N> to go back to the CREATE VOLUME menu.

Deleting a RAID set



Be cautious when deleting a RAID set. You will lose all data on the hard disk drives when you delete a RAID set.

To delete a RAID set:

1. From the utility main menu, select **2. Delete RAID Volume** and press <Enter>. The following screen appears:

```
[ DELETE VOLUME MENU ]
Name      Level      Drives  Capacity  Status  Bootable
Volume0   RAID0 (Stripe)  2       298.0GB  Normal  Yes

[ HELP ]

Deleting a volume will reset the disks to non-RAID.

WARNING: ALL DISK DATA WILL BE DELETED.
(This does not apply to Recovery volumes)

[↑]-Select      [ESC]-Previous Menu  [DEL]-Delete Volume
```

2. Use the up/down arrow key to select the RAID set you want to delete, and then press . The following warning message appears:

```
[ DELETE VOLUME VERIFICATION ]

ALL DATA IN THE VOLUME WILL BE LOST!
(This does not apply to Recovery volumes)

Are you sure you want to delete volume "Volume0"? (Y/N):
```

3. Press <Y> to delete the RAID set and return to the utility main menu, or press <N> to return to the DELETE VOLUME menu.

Exiting the Intel® Rapid Storage Technology Option ROM utility

To exit the utility:

1. From the utility main menu, select **5. Exit**, and then press <Enter>. The following warning message appears:

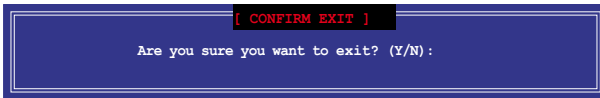

2. Press <Y> to exit or press <N> to return to the utility main menu.

5.1.5 Marvell RAID utility

The onboard Marvell SATA 6.0 Gb/s controller allows you to create a RAID 0 or RAID 1 array using two SATA hard disk drives. Refer to the section **1.2 Motherboard overview** in your motherboard user manual for the exact location of the Marvell SATA 6.0 Gb/s connector.

To enter the Marvell utility, press <Ctrl> + <M> during POST.



All existing data on the hard disk drives will be erased when creating or deleting a RAID array. Ensure that you have back up all your data in your hard disk drives before making any change to the drive status.

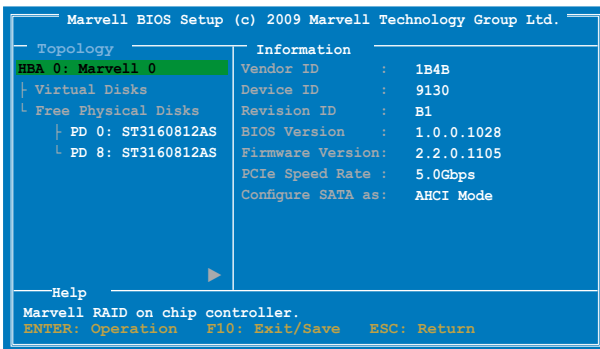

Create a RAID Array

1. Move the selection bar to HBA 0: Marvell 0 and press <Enter>.
2. Select **Configuration Wizard** and press <Enter>.

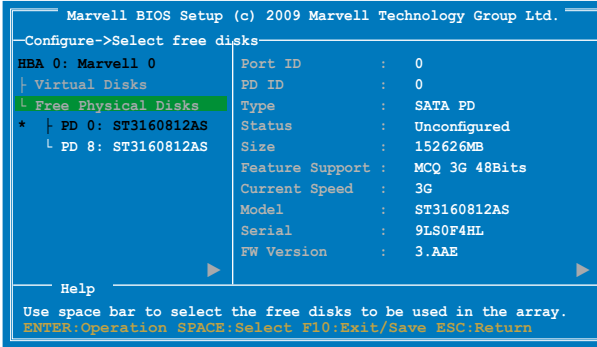

3. Press <Space> to select the hard drives to be included in the RAID array. An asterisk (*) appears in front of the selected hard drive. After selecting all the drives needed for the RAID array, press <Enter> to continue.

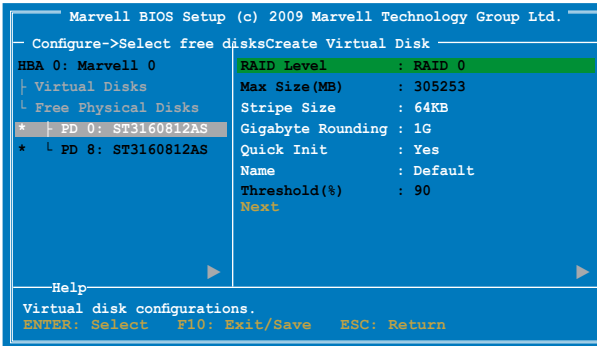

- Use the up or down arrow key to move the selection bar and press <Enter> to configure further RAID settings.

RAID Level: Select a RAID Level. Configuration options: [RAID 0] [RAID 1]

Stripe Size: Specifies the size of single data block on the virtual disk. In general, a larger stripe size is recommended for applications requiring large data transfers such as audio, video, and graphics. A smaller stripe size is better for applications with content in much smaller size, such as e-mails and documents.

Configuration options: [32K] [64K]

Gigabyte Rounding: In the event of a single physical disk failure in a RAID 1 virtual disk, Gigabyte Rounding allows the replacement physical disk to be of a size slightly smaller than the existing physical disk. The capacity of the rebuilt virtual disk equals to the size of the smaller physical disk included in the RAID 1 array. The configuration options represent the tolerance value of drive capacity difference.

Configuration options: [None] [1G] [10G]

Name: Enter a name with 1–10 letters (no special characters) for the RAID array.

- Move the selection bar to **Next** and press <Enter>. The following warning message appears:

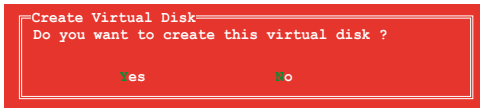

Press <Y> to create the RAID array, or press <N> to cancel. The new RAID array appears under Virtual Disks, as shown in the image below.

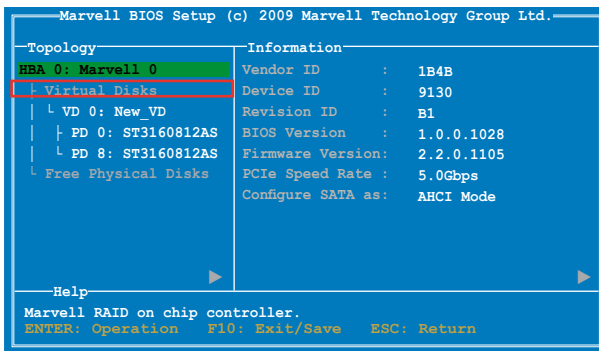

6. Press <F10>. The following warning message appears:



Press <Y> to save the RAID setting and exit the Marvell RAID utility.

Delete an existing RAID Array

1. Select the RAID array to delete and press <Enter>. Select **Delete** and press <Enter>.

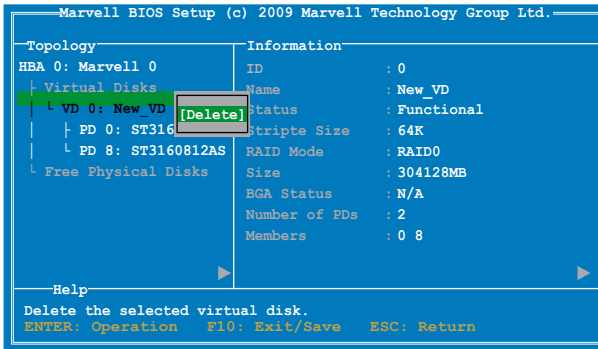

2. The following warning message appears:

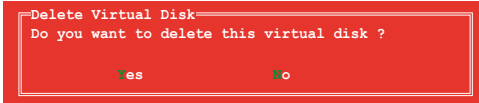

Press <Y> to delete the selected RAID array. The following warning message appears:



Press <Y> to delete the Master Boot Record (MBR) from the selected RAID array.

3. Press <F10>. The following warning message appears:



Press <Y> to save the RAID setting and exit the Marvell RAID utility.

5.2 Creating a RAID driver disk

A floppy disk with the RAID driver is required when installing a Windows® operating system on a hard disk drive that is included in a RAID set.



-
- The motherboard does not provide a floppy drive connector. You have to use a USB floppy disk drive when creating a SATA RAID driver disk.
 - Windows® XP may not recognize the USB floppy disk drive due to Windows® XP limitation. To work around this OS limitation, refer to section 5.2.4 Using a USB floppy disk drive.
-

5.2.1 Creating a RAID driver disk without entering the OS

To create a RAID driver disk without entering the OS:

1. Boot your computer.
2. Press during POST to enter the BIOS setup utility.
3. Set the optical drive as the primary boot device.
4. Insert the support DVD into the optical drive.
5. Save changes and exit BIOS.
6. When the Make Disk menu appears, press <1> to create a RAID driver disk.
7. Insert a formatted floppy disk into the USB floppy disk drive, then press <Enter>.
8. Follow the succeeding screen instructions to complete the process.

5.2.2 Creating a RAID driver disk in Windows®

To create a RAID driver disk in Windows®:

1. Start Windows®.
2. Plug the USB floppy disk drive and insert a floppy disk.
3. Place the motherboard support DVD into the optical drive.
4. Go to the **Make Disk** menu, and then click **Intel AHCI/RAID Driver Disk** to create a RAID driver disk.
5. Select **USB floppy disk drive** as the destination disk.
6. Follow the succeeding screen instructions to complete the process.



Write-protect the floppy disk to avoid a computer virus infection.

5.2.3 Installing the RAID driver during Windows® OS installation

To install the RAID driver in Windows® XP:

1. During the OS installation, the system prompts you to press the <F6> key to install third-party SCSI or RAID driver.
2. Press <F6>, and then insert the floppy disk with RAID driver into the USB floppy disk drive.
3. When prompted to select the SCSI adapter to install, select the RAID driver for the corresponding OS version.
4. Follow the succeeding screen instructions to complete the installation.

To install the RAID driver for Windows® 7 or later OS:

1. During the OS installation, click **Load Driver** to allow you to select the installation media containing the RAID driver.
2. Insert the USB flash drive with RAID driver into the USB port or the support DVD into the optical drive, and then click **Browse**.
3. Click the name of the device you've inserted, go to **Drivers > RAID**, and then select the RAID driver for the corresponding OS version. Click **OK**.
4. Follow the succeeding screen instructions to complete the installation.



Before loading the RAID driver from a USB flash drive, you have to use another computer to copy the RAID driver from the support DVD to the USB flash drive.

5.2.4 Using a USB floppy disk drive

Due to OS limitation, Windows® XP may not recognize the USB floppy disk drive when you install the RAID driver from a floppy disk during the OS installation.

To solve this issue, add the USB floppy disk drive's Vendor ID (VID) and Product ID (PID) to the floppy disk containing the RAID driver. Refer to the steps below:

1. Using another computer, plug the USB floppy disk drive, and insert the floppy disk containing the RAID driver.

2. Right-click **My Computer** on the Windows® desktop or start menu, and then select **Manage** from the pop-up window.

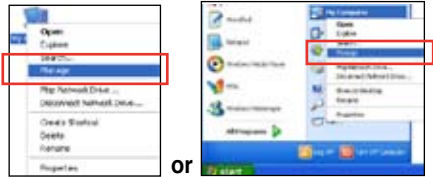

3. Select **Device Manager**. From the **Universal Serial Bus controllers**, right-click **xxxxxx USB Floppy**, and then select **Properties** from the pop-up window.



The name of the USB floppy disk drive varies with different vendors.

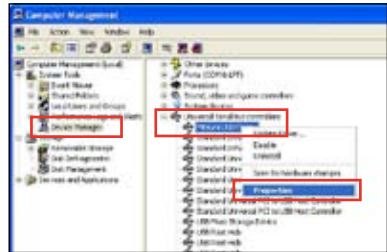

4. Click **Details** tab. The Vendor ID (VID) and Product ID (PID) are displayed.

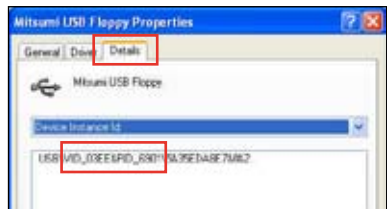

5. Browse the contents of the RAID driver disk to locate the file **txtsetup.oem**.
6. Double-click the file. A window appears, allowing you to select the program for opening the oem file.

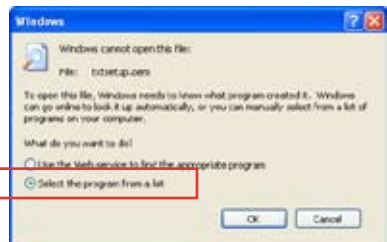

7. Use Notepad to open the file.



8. Find the **[HardwareIds.scsi.iaAHCI_DesktopWorkstationServer]** and **[HardwareIds.scsi.iaStor_DesktopWorkstationServer]** sections in the txtsetup.oem file.
9. Type the following line to the bottom of the two sections:

id = "USB\VID_xxxx&PID_xxxx", "usbstor"

```
[HardwareIds.scsi.iaAHCI
DesktopWorkstationServerT
id= "PCI\VEN_8086&DEV_1C02&CC_0106", "iaStor"
id= "USB\VID_03EE&PID_6901", "usbstor"

[HardwareIds.scsi.iaStor
DesktopWorkstationServerT
id= "PCI\VEN_8086&DEV_2822&CC_0104", "iaStor"
id= "USB\VID_03EE&PID_6901", "usbstor"
```



Add the same line to both sections.



The VID and PID vary with different vendors.

10. Save and exit the file.

Multiple GPU support

6

6.1 AMD® CrossFireX™ technology

The motherboard supports the AMD® CrossFireX™ technology that allows you to install multi-graphics processing units (GPU) graphics cards. Follow the installation procedures in this section.

6.1.1 Requirements

- In Dual CrossFireX mode, you should have two identical CrossFireX-ready graphics cards or one CrossFireX-ready dual-GPU graphics card that are AMD® certified.
- Ensure that your graphics card driver supports the AMD CrossFireX technology. Download the latest driver from the AMD website (www.amd.com).
- Ensure that your power supply unit (PSU) can provide at least the minimum power required by your system. See Chapter 1 for details.



-
- We recommend that you install additional chassis fans for better thermal environment.
 - Visit the AMD Game website (<http://game.amd.com>) for the latest certified graphics card and the supported 3D application list.
-

6.1.2 Before you begin

For AMD CrossFireX to work properly, you have to uninstall all existing graphics card drivers before installing AMD CrossFireX graphics cards to your system.

To uninstall existing graphics card drivers:

1. Close all current applications.
2. For Windows XP, go to **Control Panel > Add/Remove Programs**.
For Windows 7, go to **Control Panel > Programs and Features**.
3. Select your current graphics card driver/s.
4. For Windows XP, select **Add/Remove**.
For Windows 7, select **Uninstall**.
5. Turn off your computer.

6.1.3 Installing two CrossFireX™ graphics cards



The following pictures are for reference only. The graphics cards and the motherboard layout may vary with models, but the installation steps remain the same.

1. Prepare two CrossFireX-ready graphics cards.
2. Insert the two graphics card into the PCIEX16 slots. If your motherboard has more than two PCIEX16 slots, refer to Chapter 1 in this user manual for the locations of the PCIEX16 slots recommended for multi-graphics card installation.
3. Ensure that the cards are properly seated on the slots.
4. Align and firmly insert the CrossFireX bridge connector to the goldfingers on each graphics card. Ensure that the connector is firmly in place.

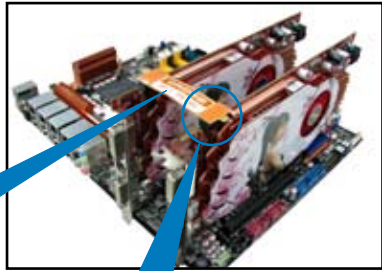
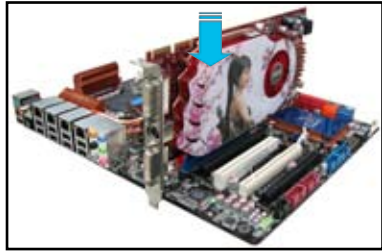

CrossFireX bridge
(bundled with
graphics cards)



Goldfingers

5. Connect two independent auxiliary power sources from the power supply to the two graphics cards separately.
6. Connect a VGA or a DVI cable to the graphics card.

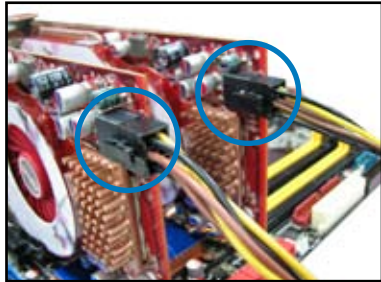

6.1.4 Installing three CrossFireX™ graphics cards

1. Prepare three CrossFireX-ready graphics cards.
2. Insert the three graphics card into the PCIEX16 slots. If your motherboard has more than three PCIEX16 slots, refer to Chapter 1 in this user manual for the locations of the PCIEX16 slots recommended for multi-graphics card installation.
3. Ensure that the cards are properly seated on the slots.
4. Align and firmly insert the two CrossFireX bridge connectors to the goldfingers on each graphics card. Ensure that the connectors are firmly in place.

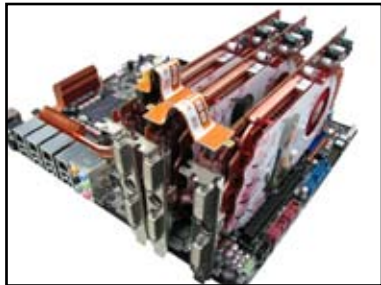

5. Connect three independent auxiliary power sources from the power supply to the three graphics cards separately.
6. Connect a VGA or a DVI cable to the graphics card.

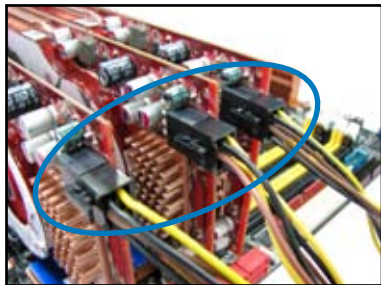

6.1.5 Installing four CrossFireX™ graphics cards

1. Prepare four CrossFireX-ready graphics cards.
2. Insert the four graphics card into the PCIEX16 slots. Refer to Chapter 1 in this user manual for the locations of the PCIEX16 slots recommended for multi-graphics card installation.
3. Ensure that the cards are properly seated on the slots.
4. Align and firmly insert the four CrossFireX bridge connectors to the goldfingers on each graphics card. Ensure that the connectors are firmly in place.



5. Connect four independent auxiliary power sources from the power supply to the four graphics cards separately.
6. Connect a VGA or a DVI cable to the graphics card.

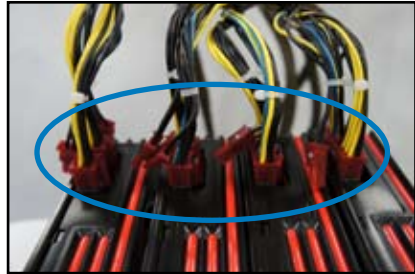

6.1.6 Installing the device drivers

Refer to the documentation that came with your graphics card package to install the device drivers.



Ensure that your PCI Express graphics card driver supports the AMD® CrossFireX™ technology. Download the latest driver from the AMD website (www.amd.com).

6.1.7 Enabling the AMD® CrossFireX™ technology

After installing your graphics cards and the device drivers, enable the CrossFireX™ feature through the AMD Catalyst™ Control Center in Windows environment.

Launching the AMD Catalyst Control Center

To launch the AMD Catalyst Control Center:

1. Right-click on the Windows® desktop and select **Catalyst Control Center**.
2. Click **Catalyst Control Center** to configure the displays and settings of your AMD graphic cards.

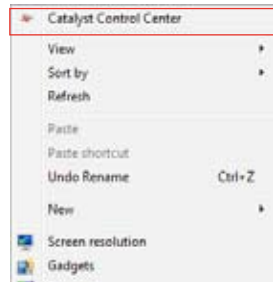

Enabling Dual CrossFireX technology

1. In the Catalyst Control Center window, click **Performance > AMD CrossFireX™**.
2. Select **Enable CrossFireX™**.
3. Select a GPU combination from the drop-down list.
4. Click **Apply** to save and activate the GPU settings made.

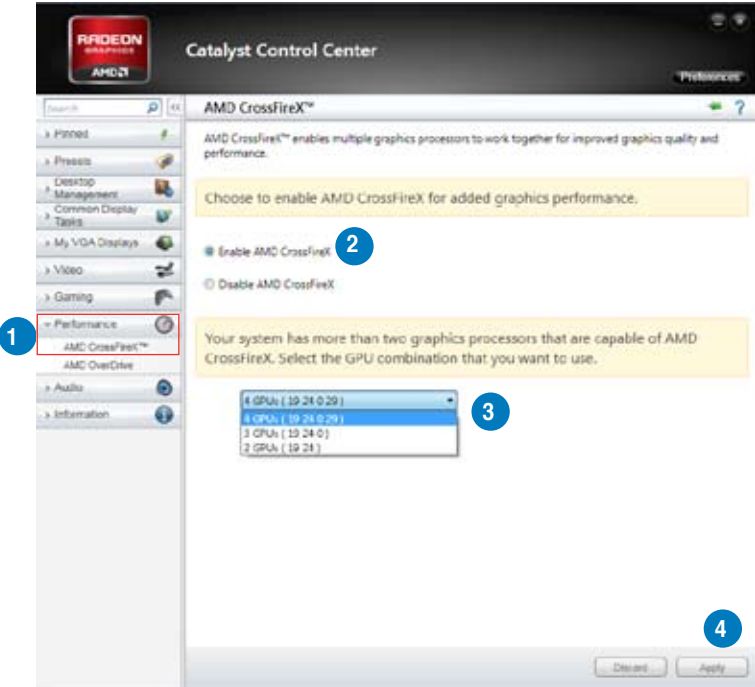

6.2 NVIDIA® SLI™ technology

The motherboard supports the NVIDIA® SLI™ (Scalable Link Interface) technology that allows you to install multi-graphics processing units (GPU) graphics cards. Follow the installation procedures in this section.

6.2.1 Requirements

- In SLI mode, you should have two identical SLI-ready graphics cards that are NVIDIA® certified.
- Ensure that your graphics card driver supports the NVIDIA SLI technology. Download the latest driver from the NVIDIA website at www.nvidia.com.
- Ensure that your power supply unit (PSU) can provide at least the minimum power required by your system.



- We recommend that you install additional chassis fans for better thermal environment.
- Visit the NVIDIA zone website (<http://www.nzone.com>) for the latest certified graphics card and supported 3D application list.

6.2.2 Installing two SLI-ready graphics cards



The following pictures are for reference only. The graphics cards and the motherboard layout may vary with models, but the installation steps remain the same.

1. Prepare two SLI-ready graphics cards.
2. Insert the two graphics card into the PCIEX16 slots. If your motherboard has more than two PCIEX16 slots, refer to Chapter 2 in this user manual for the locations of the PCIEX16 slots recommended for multi-graphics card installation.
3. Ensure that the cards are properly seated on the slots.

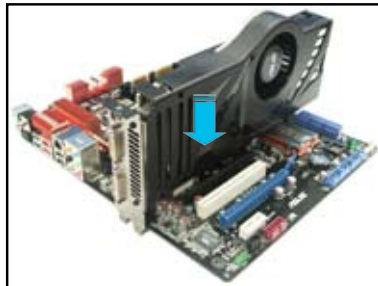

- Align and firmly insert the SLI bridge connector to the goldfingers on each graphics card. Ensure that the connector is firmly in place.
- Connect two independent auxiliary power sources from the power supply to the two graphics cards separately.
- Connect a VGA or a DVI cable to the graphics card.

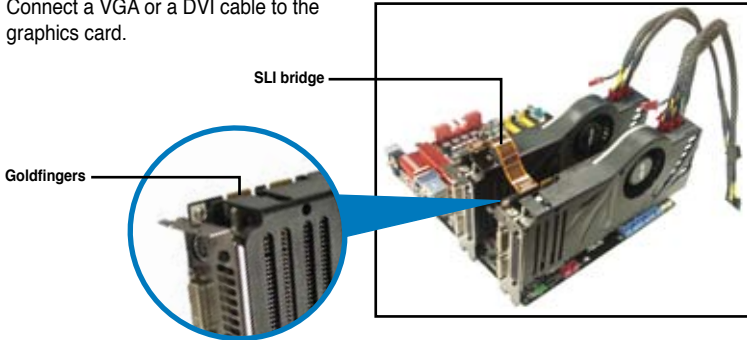

6.2.3 Installing three SLI-ready graphics cards

- Prepare three SLI-ready graphics cards.
- Insert the three graphics card into the PCIEX16 slots. If your motherboard has more than two PCIEX16 slots, refer to Chapter 1 in this user manual for the locations of the PCIEX16 slots recommended for multi-graphics card installation.
- Ensure that the cards are properly seated on the slots.
- Align and firmly insert the 3-Way SLI bridge connector to the goldfingers on each graphics card. Ensure that the connector is firmly in place.
- Connect three independent auxiliary power sources from the power supply to the three graphics cards separately.
- Connect a VGA or a DVI cable to the graphics card.

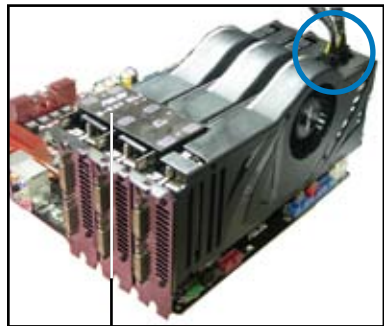
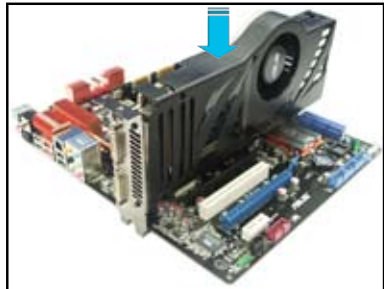

3-Way SLI bridge

6.2.4 Installing four SLI-ready graphics cards

1. Prepare four SLI-ready graphics cards.
2. Insert the four graphics card into the PCIEX16 slots. If your motherboard has more than two PCIEX16 slots, refer to Chapter 1 in this user manual for the locations of the PCIEX16 slots recommended for multi-graphics card installation.
3. Ensure that the cards are properly seated on the slots.

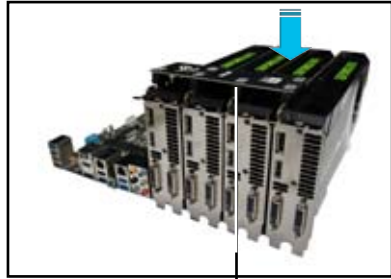

4-Way SLI bridge

4. Align and firmly insert the 4-Way SLI bridge connector to the goldfingers on each graphics card. Ensure that the connector is firmly in place.
5. Connect four independent auxiliary power sources from the power supply to the four graphics cards separately.

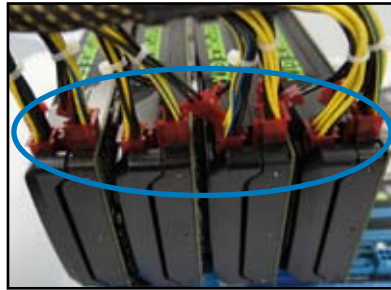

6.2.5 Installing the device drivers

Refer to the documentation that came with your graphics card package to install the device drivers.



Ensure that your PCI Express graphics card driver supports the NVIDIA® SLI™ technology. Download the latest driver from the NVIDIA website (www.nvidia.com).

6.2.6 Enabling the NVIDIA® SLI™ technology

After installing your graphics cards and the device drivers, enable the SLI feature in NVIDIA® Control Panel under the Windows® 7 operating system.

Launching the NVIDIA Control Panel

You can launch the NVIDIA Control Panel by the following two methods.

- A. Right click on the empty space of the Windows® desktop and select **NVIDIA Control Panel**.

The NVIDIA Control Panel window appears (See Step B3).

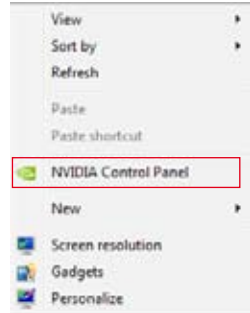

- B1. If you cannot see the NVIDIA Control Panel item in step (A), select **Screen Resolution**.

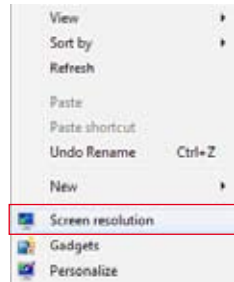

- B2. From the Screen Resolution window, click **Advanced settings**.

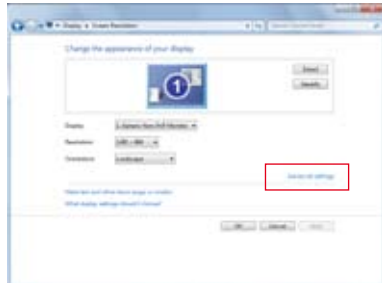

- B3. The NVIDIA Control Panel window appears.

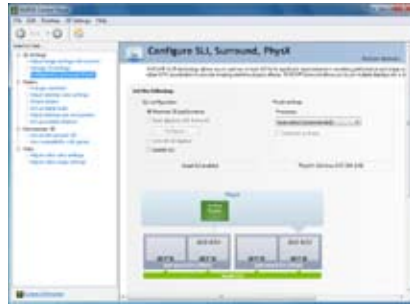

Enabling SLI settings

From the NVIDIA Control Panel window, select **Configure SLI, Surround, PhysX**. In the **Quad-SLI enabled**, click **Maximize 3D Performance SLI** to set the display for viewing SLI rendered content. When done, click **Apply**.

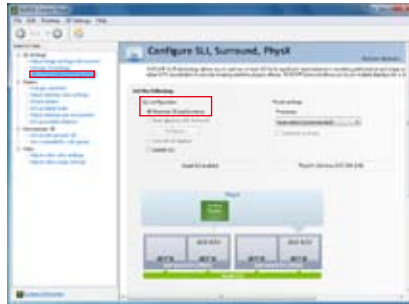

6.3 LucidLogix Virtu MVP

LucidLogix Virtu MVP allows your computer's VGA output and discrete graphic cards to perform better, respond faster and process media files smoother within a low power environment. Its GPU virtualization assigns tasks to the best available graphic source while the newly-designed Virtual Vsync gives you a smoother gaming experience.



-
- LucidLogix Virtu MVP supports Windows 7® operating systems.
 - Intel® Quick Sync Video feature is supported by the 3rd/2nd generation Intel® Core™ processor family.
 - iGPU Multi-Monitor support option must be enabled in BIOS and install both Intel® Graphics Accelerator, and graphics card driver before installing LucidLogix Virtu MVP from ASUS support DVD. Refer to **3.5.4 System Configuration** for details.
 - Hyperformance® and Virtual VSync are enabled when using more than one discrete GPU at the same time.
 - Supports NVIDIA® GF4xx/5xx series and AMD® HD5xxx/6xxx series graphic cards.
 - We do not recommended that you use LucidLogix Virtu MVP under RAID mode.
-

6.3.1 Installing LucidLogix Virtu MVP

To install LucidLogix Virtu MVP:

1. Insert the support DVD in the optical drive. The ASUS Support Wizard appears if your computer has enabled the Autorun feature.
2. Click the **Utilites** tab, then click **LucidLogix Virtu MVP Software**.
3. Follow the succeeding onscreen instructions to complete the installation.



After you successfully installed the LucidLogix Virtu MVP, the LucidLogix Virtu MVP icon appears in the notification area.

6.3.2 Setting up your display

LucidLogix Virtu MVP solution comes with two distinct modes that allows you to enjoy better graphics either from your built-in video output (i-Mode) or from a discrete graphics card (d-Mode).

i-Mode

To use LucidLogix Virtu MVP in i-Mode, the display must be connected to the onboard video output.



Ensure to set the Primary Display to iGPU in BIOS to activate i-Mode support.

d-Mode

To use LucidLogix Virtu MVP in d-Mode, the display must be connected to the installed graphics card.



- Ensure to set the Primary Display to PCIE or PCIE/PCI in BIOS to enable d-Mode support.
 - d-Mode is recommended for an enhanced 3D gaming performance.
-

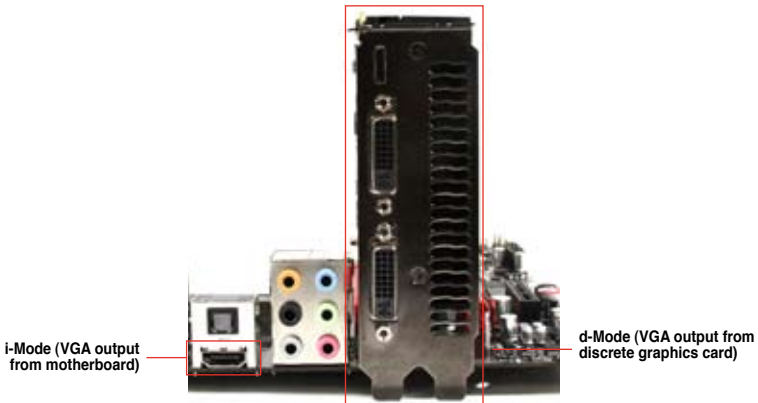

The motherboard's IO ports and discrete graphic card is for reference only and may vary in different models.

6.3.3 Configuring LucidLogix Virtu MVP

Launch the Virtu MVP Control Panel to allow you to configure the main features, adjust the performance settings and select applications for graphical virtualization.

To open the control panel, right-click **LucidLogix Virtu MVP** icon in the notification area and select **Open Virtu MVP Control Panel**.

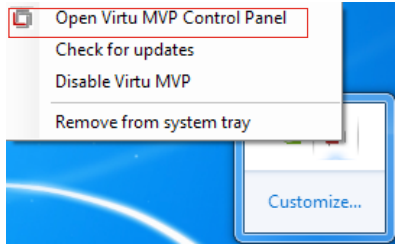

LucidLogix Virtu MVP is automatically activated when your system is powered on. Select **Remove from system tray** if you want to remove LucidLogix Virtu MVP icon from the notification area.

Main

Allows you to turn ON/OFF the GPU virtualization. Also from the Main tab, you can set to show or hide the In-Game icon.



Performance

Allows you to turn ON/OFF the Hyperformance® or Virtual Vsync function.

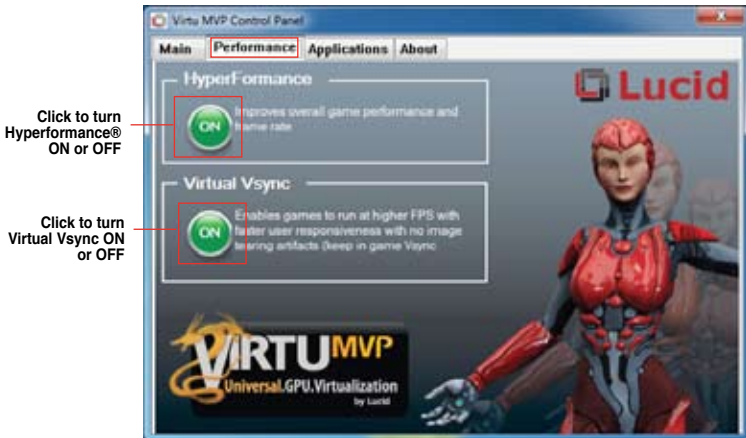

Applications

Allows you to select applications for graphic virtualization.



See the descriptions of these columns below:

- D column allows you to run applications with the discrete graphic card. Select D to enable 3D graphical performance for that application.
- I column allows to run applications with iGPU. Select I for applications with media extensive performance.
- H column allows you to run applications with Hyperformance®. Tick H to enhance graphical performance for that application.



Actual graphical performance varies with the application used and graphics card installed.

Intel® technologies

7

7.1 Intel® 2012 Desktop responsiveness technologies

This section details the overview of the installation and configuration procedures of the Intel® 2012 Desktop responsiveness technologies.

Intel® 2012 Desktop responsiveness technologies feature the three technologies:

- Intel® Smart Response Technology
- Intel® Rapid Start Technology
- Intel® Smart Connect Technology

System Requirements

In order for the system to run smoothly for the Intel® 2012 Desktop responsiveness, your system must meet the following requirements.

CPU: Intel® 3rd/2nd generation Core Processor family

OS: Windows® 7 operating systems

SSD: One dedicated SSD (Solid State Disk) to support Intel® Smart Response and Intel® Rapid Start Technology is necessary.



Refer to the **SSD Capacity Requirements** table for the information of SSD size, partition capacity, and system memory requirements.

HDD: At least one HDD (Hard Disk Drive) for the system OS drive.

DRAM: To enable Intel® Rapid Start Technology, DRAM size smaller than 8GB is required.



Ensure to enable the acceleration of Intel® Smart Response Technology before creating the partition for the Intel® Rapid Start Technology.

SSD Capacity Requirements

SSD Partition Capacity Requirements		System DRAM		
		2GB	4GB	8GB
Intel® storage combinations	Intel® Rapid Start	2GB	4GB	8GB
	Intel® Smart Response	20GB	20GB	20GB
	Intel® Smart Response and Intel® Rapid Start	Separate 20GB and 2GB partition (SSD size > 22GB)	Separate 20GB and 4GB partition (SSD size > 24GB)	Separate 20GB and 8GB partition (SSD size > 28GB)
	Intel® Smart Response, Intel® Rapid Start, and Intel® Smart Connect	Separate 20GB and 2GB partition (SSD size > 22GB)	Separate 20GB and 4GB partition (SSD size > 24GB)	Separate 20GB and 8GB partition (SSD size > 28GB)



- The SSD used for Intel® Rapid Start and Intel® Smart Response is not allowed for creating RAID.
- Due to OS behavior, Intel® Rapid Start Technology does not work efficiently with over 4GB system memory under Windows® 7 32-bit operating system.
- Only Intel® internal SATA ports (gray and blue) support Intel® 2012 Desktop responsiveness technologies.
- The performance of Intel® Smart Response Technology and Intel® Rapid Storage Technology vary with the installed SSD.

7.1.1 Intel® Smart Response Technology

Intel® Smart Response Technology boosts overall system performance. It uses an installed fast SSD (min. 20GB available) as a cache for frequently accessed operations, speeding up hard drive/main memory interaction. It accelerates the hard drive speeds, reduced load and wait time, and maximizes storage use. It also reduces hard drive spin thus reducing unnecessary hard drive spin.



Before applying Intel® Smart Response Technology, setting the SATA Mode BIOS item to [RAID mode] in BIOS setup is necessary. Refer to section 3.5.3 **SATA Configuration** for details.

Installing Intel® Smart Response Technology

1. Place the support DVD to the optical drive. If Autorun is enabled in your computer, the DVD automatically displays the installation wizard.
2. Click the **Drivers** tab, then click Intel® Rapid Storage Technology Driver software.
3. Follow the onscreen instructions to complete the installation.

Using the Intel® Smart Response Technology

1. Click **Accelerate** to launch Smart Response Technology settings.

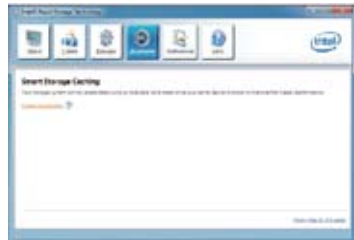

2. Do the following:
 - a. Select the SSD you want to use to accelerate your storage system.
 - b. Select the size allocated for SSD caching.
 - c. Select the hard drive to accelerate.
 - d. Select any of these enhanced modes:

Enhanced mode: WRITE THROUGH, write to SSD and HDD at the same time.

Maximized mode: WRITE BACK, write to SSD and write back to HDD in a later time.



3. Select **Disable Acceleration** to disable this function, and select **Change Mode** to switch acceleration mode to Enhanced/Maximized.



- To enable Intel® Smart Response Technology, you need at least one SSD ($\geq 20\text{GB}$) and an HDD, and only one SSD can be assigned for caching.
- If you want to restore the OS, go to **BIOS Option ROM > Acceleration Options** and remove the **Disks/Volume Acceleration** to disable Intel® Smart Response Technology.
- The maximum caching size on the SSD is 64GB. If it exceeds, the storage capacity left out for caching can still be identified by the system for normal storage.

7.1.2 Intel® Rapid Start Technology

Intel® Rapid Start Technology allows you to quickly resume your computer from sleeping mode. Saving your computer's system memory to the configured SSD provides a faster wake-up response time, but keeps the energy in a low profile.



- Before applying Intel® Rapid Start Technology, go to Advanced Mode > Advanced > PCH Configuration in BIOS item, and enable Intel® Rapid Start Technology.
- Ensure to follow the procedure **Creating a partition** precisely to enable the Intel Rapid Start function. Error message appears if you install the Intel® Rapid Start Utility before creating a partition.

Creating a partition



- Ensure to backup your data before using the Microsoft partition tool. Incorrect partitioning process will result to data loss.
- Adjusting the DRAM to a high frequency will result to unstable system performance.

1. Go to **Start**, right-click **Computer > Manage > Disk Management**.
2. Select the SSD that you want to create the partition.

3. Right click the New Volume that you want to shrink from, and select Shrink Volume.

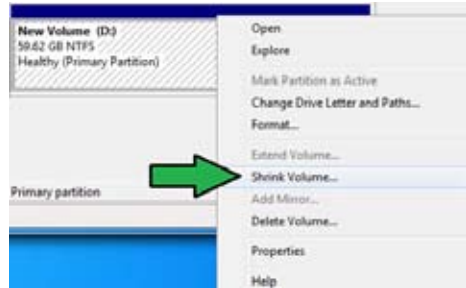

4. If your SSD is not initialized and unformatted:
 - a. Right click the disk that you want to create the partition, and select **Initialize**.
 - b. Right click the unallocated volume, select **New Simple Volume**, and follow the remaining steps.



If your SSD is smaller than 64GB, and is set to **Full disk capacity** caching option for Intel® Smart Response, you can not see any volume in the Disk Management. Ensure to set your cache memory value of **18.6GB** in Intel® Smart Response to allow enough capacity for the Intel® Rapid Start partition.

5. Key in the required partition size, and must be equal to the system DRAM memory (1GB = 1024MB). Click Shrink.

Go to **Start > Control Panel > System and Security > System**, and check the DRAM size information.



The unallocated volume is allocated to the selected disk.

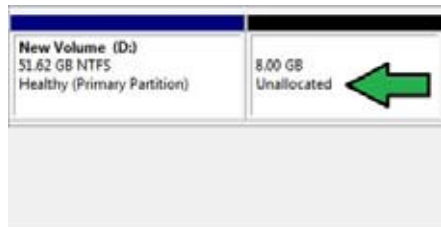

- To launch the disk partitioning tool, click **Start > Programs > Accessories > Command Prompt tool**.
- Type **diskpart** and press <Enter>.
- In the diskpart prompt, type **list disk** after **DISKPART**, and press <Enter>. Select the disk with the unallocated volume by typing **select disk x** (x = disk number), and press <Enter>.

```
DISKPART> list disk

Disk ###  Status             Size       Free       Dgn  Gpt
-----  -
Disk 0    Online             2794 GB    1824 MB
Disk 1    Online              59 GB      8 GB

DISKPART> select disk 1
Disk 1 is now the selected disk.
```



- The value "x" refers to a disk number where you created the unallocated partition.
- Refer to step 5 for details about the unallocated disk space in the SSD.

- Type **create partition primary**, and press <Enter>.

```
DISKPART> create partition primary
DiskPart succeeded in creating the specified partition.
DISKPART>
```

- After creating a primary partition, type **detail disk**, and press <Enter> to view the details of the partitioned disk.

```
DISKPART> detail disk

Disk ID: 2A42F274
Type: Primary
Status: Online
Path: \Device\Harddisk0\Partition1
Size: 59 GB
RAW 12: 0
Partition Disk 1: (C:\WINDOWS\SYSTEM32\DRIVERS\DISKPART)
Mountable: No
State: No
Bootable: No
Recovery Disk: No
Information File Disk: No
CrashDump Disk: No
Customized Disk: No

Volume ###  Ltr  Label  Fs  Type  Size  Status Info
-----  -
Volume 2    E  New Volume  NTFS  Partition  59 GB  Healthy
Volume 3    F  New Volume  RAW   Partition  8 GB   Healthy
```

- Select the RAW volume which has the same size as the shrunk volume, type **select volume x** (x = number), and press Enter to store the Intel® Rapid Start partition.

```
DISKPART> select volume 3
Volume 3 is the selected volume.
DISKPART>
```



- The value "x" refers to a disk number where you want to create the store partition.

12. Type **set id=84 override**, press <Enter>, and wait for the “shrinking process” until the Disk Management utility identifies a new partition called **Hibernation Partition**.

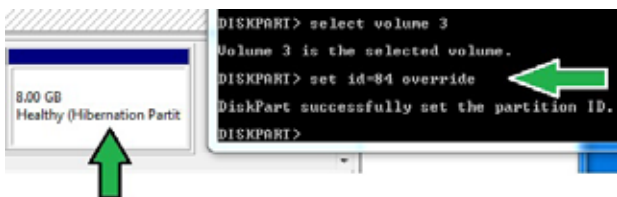

The **Hibernation Partition** does not appear when you choose “GPT (GUID Partition Table store type)”. Ensure the “Unallocated” disappears from the volume, and a new partition is identified.

13. Reboot the system after creating the partition.



The partition for Intel® Rapid Start Technology is incomplete if the computer is not rebooted, and this results to function failure of Intel® Rapid Start Technology.

Enabling and disabling the Intel® Rapid Start Technology under the OS



Install the Intel® Rapid Start Technology first from your support DVD in order to launch the Intel® Rapid Start Manager.

After creating the partition, launch the Intel® Rapid Start Manager to enable or disable the Intel® Rapid Start Technology.

1. Click the **Show hidden icons** arrow from the right side of the taskbar, and click **Intel® Rapid Start Technology Manager** icon.

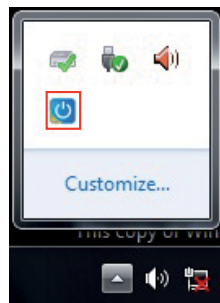

2. Tick **On** in the Status field to enable the function, and click **Save**.

Select and click to enable or disable the function

Click to enable or disable battery saving mode. This function only applies to notebooks.

Click to enable or disable the timer. When enabled, move the scroll bar to the desired time. When the system is idle for more than the time period you set, the system automatically goes into the Intel® Rapid Start mode. Default time is 10 minutes.

Click to save the settings made.

Click to cancel the settings made.

Recovering the partition

This procedure allows you to delete the Intel® Rapid Start Technology from your system, and recover the partition you made for the Intel Rapid® Start Technology installation.

1. Run the **Command Prompt** tool.
2. Type **diskpart** and press <Enter>.
3. At the diskpart prompt, type **list disk** after DISKPART, and press <Enter>.
4. Select the disk (SSD) where the Intel® Rapid Start Technology is installed for volume recovery, type **select disk x** (x = number), and press <Enter>.

```
DISKPART> list disk

Disk ###  Status             Size             Free             Dgn  Gpt
-----  -
Disk 0    Online             2794 GB          1024 KB
Disk 1    Online             59 GB            0 B
```

```
DISKPART> select disk 1

Disk 1 is now the selected disk.

DISKPART>
```



The value "x" refers to a disk number where you want to delete the store partition.

- Type **list partition**, press Enter, and select the partition where the Intel® Rapid Start Technology is installed by typing **select partition x** (x = number), and press <Enter>.

```
DISKPART> list partition
Partition ### Type              Size      Offset
-----
Partition 1   Primary          51 GB    1024 KB
Partition 2   OEM              8 GB     51 GB

DISKPART> select partition 2
Partition 2 is now the selected partition.
DISKPART>
```



The value “x” refers to a disk number where you want to delete the store partition.

- Type **delete partition override**, and press <Enter>. The diskpart utility deletes the selected partition.

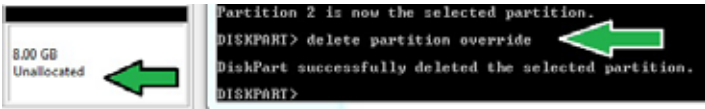

- In the desktop, click **Start**, right-click **Computer**, and click **Manage**.
- In the Computer Management window, click **Disk Management**, right click the shrunk new volume, and select **Extend Volume**.

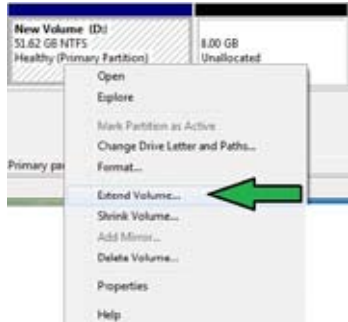

- As the Extend Volume Wizard appears, click **Next**.



10. Click **Next** after selecting the default selected disk.
11. Extend volume setup is completed. Click **Finish** to recover the Intel® Rapid Start Technology partition.
12. Reboot the system after deleting the partition.
13. Go to **Start > Control Panel > Programs > Programs and Features** to remove the Intel® Rapid Start Manager for the complete deletion of Intel® Rapid Start Technology.

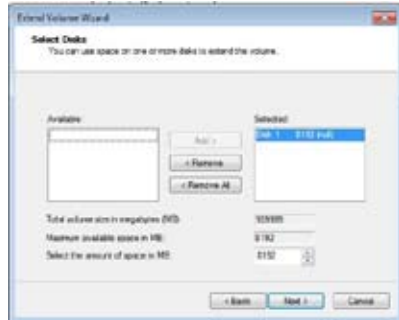

7.1.3 Intel® Smart Connect Technology

The Intel® Smart Connect Technology is a feature that provides the latest content updates and energy efficiency to your computer's platform.

Once installed and activated, the Intel® Smart Connect Technology periodically wakes up the system from sleeping mode, performs user state gathering, and initiates re-entry to sleeping mode to wake-up after a set time interval.



- Intel® Smart Connect Technology supports Windows® Live Mail, Microsoft Outlook, and Seismic applications.
- It is necessary to enable the items of the PCH Configuration in the BIOS before applying the Intel® Smart Connect Technology. Go to **Advanced Mode > Advanced > PCH Configuration**, and enable the Intel® Smart Connect Technology.

Installing the Intel® Smart Connect Technology

1. Place the support DVD to the optical drive.
2. Go to **Utilities**, and click Intel® Smart Connect Technology.
3. As the setup wizard appears, click **Next** to begin the setup.
4. Tick **I accept the terms in the License Agreement**, and click **Next**.
5. Select all and click **Next** for Custom Setup.
6. Click **Install** to proceed the installation.
7. Click **Yes** to restart your system, and for the newly installed Intel® Smart Connect Technology to take effect.

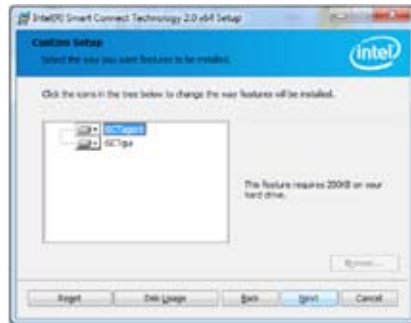

Using the Intel® Smart Connect Technology



- Before the system goes to sleep mode, ensure to keep your applications on the desktop, and enter the applications, passwords.
- Ensure that the internet is in connection when enabling the Intel® Smart Connect Technology.

1. Click **Start > All Programs > Intel > Intel® Smart Connect Technology**.
2. In the **Basic** tab, click **Enable Updating**. When enabled, the **Advanced** tab is available for advanced function settings.

The Advanced tab is activated when updating is enabled

Click to view version information and help topics

Click to configure the basic settings

Click to enable or disable the function

When the scroll bar is activated, adjust the waking up time period for Internet data update.

When updating is enabled, click to reset all settings to default.

The screenshot shows the Intel Smart Connect Technology Control Panel window. The 'Advanced' tab is selected. The 'Enable Updating' button is highlighted in blue. A scroll bar is visible on the 'More Frequent Updates' slider, which is set to 15 minutes. The 'Reset All to Defaults' button is also visible.

3. To disable the updating function, click **Disable Updating**. Clicking this button automatically disables the configuration in the **Advanced** tab. To reset to defaults, click **Reset All to Defaults**.

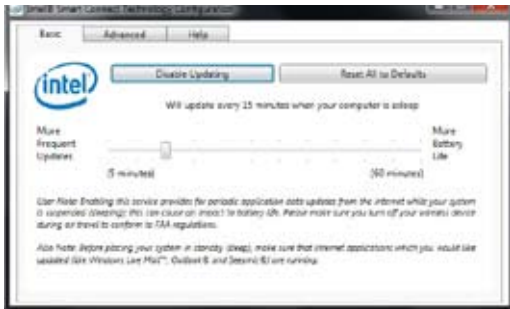

- In the **Advanced** tab, set up the schedule during low power usage time period for power saving. This setting only applies to the assigned time period.



- In the **Help** tab, click **About** to view the feature's version. Click **Topics** to learn more about the Intel® Smart Connect Technology and its configuration.

Appendices

Notices

Federal Communications Commission Statement

This device complies with Part 15 of the FCC Rules. Operation is subject to the following two conditions:

- This device may not cause harmful interference.
- This device must accept any interference received including interference that may cause undesired operation.

This equipment has been tested and found to comply with the limits for a Class B digital device, pursuant to Part 15 of the FCC Rules. These limits are designed to provide reasonable protection against harmful interference in a residential installation. This equipment generates, uses and can radiate radio frequency energy and, if not installed and used in accordance with manufacturer's instructions, may cause harmful interference to radio communications. However, there is no guarantee that interference will not occur in a particular installation. If this equipment does cause harmful interference to radio or television reception, which can be determined by turning the equipment off and on, the user is encouraged to try to correct the interference by one or more of the following measures:

- Reorient or relocate the receiving antenna.
- Increase the separation between the equipment and receiver.
- Connect the equipment to an outlet on a circuit different from that to which the receiver is connected.
- Consult the dealer or an experienced radio/TV technician for help.



The use of shielded cables for connection of the monitor to the graphics card is required to assure compliance with FCC regulations. Changes or modifications to this unit not expressly approved by the party responsible for compliance could void the user's authority to operate this equipment.

IC: Canadian Compliance Statement

Complies with the Canadian ICES-003 Class B specifications. This device complies with RSS 210 of Industry Canada. This Class B device meets all the requirements of the Canadian interference-causing equipment regulations.

This device complies with Industry Canada license exempt RSS standard(s). Operation is subject to the following two conditions: (1) this device may not cause interference, and (2) this device must accept any interference, including interference that may cause undesired operation of the device.

Cet appareil numérique de la Classe B est conforme à la norme NMB-003 du Canada. Cet appareil numérique de la Classe B respecte toutes les exigences du Règlement sur le matériel brouilleur du Canada.

Cet appareil est conforme aux normes CNR exemptes de licence d'Industrie Canada. Le fonctionnement est soumis aux deux conditions suivantes :

- (1) cet appareil ne doit pas provoquer d'interférences et
- (2) cet appareil doit accepter toute interférence, y compris celles susceptibles de provoquer un fonctionnement non souhaité de l'appareil.

Canadian Department of Communications Statement

This digital apparatus does not exceed the Class B limits for radio noise emissions from digital apparatus set out in the Radio Interference Regulations of the Canadian Department of Communications.

This class B digital apparatus complies with Canadian ICES-003.

VCCI: Japan Compliance Statement

VCCI Class B Statement

情報処理装置等電波障害自主規制について

この装置は、情報処理装置等電波障害自主規制協議会（VCCI）の基準に基づくクラスB情報技術装置です。この装置は家庭環境で使用することを目的としていますが、この装置がラジオやテレビジョン受信機に近接して使用されると、受信障害を引き起こすことがあります。

取扱説明書に従って正しい取り扱いをして下さい。

KC: Korea Warning Statement

B급 기기 (가정용 방송통신기자재)

이 기기는 가정용(B급) 전자파적합기기로서 주로 가정에서 사용하는 것을 목적으로 하며, 모든 지역에서 사용할 수 있습니다.

*당해 무선설비는 전파혼신 가능성이 있으므로 인명안전과 관련된 서비스는 할 수 없습니다.

REACH

Complying with the REACH (Registration, Evaluation, Authorisation, and Restriction of Chemicals) regulatory framework, we published the chemical substances in our products at ASUS REACH website at <http://csr.asus.com/english/REACH.htm>.



DO NOT throw the motherboard in municipal waste. This product has been designed to enable proper reuse of parts and recycling. This symbol of the crossed out wheeled bin indicates that the product (electrical and electronic equipment) should not be placed in municipal waste. Check local regulations for disposal of electronic products.



DO NOT throw the mercury-containing button cell battery in municipal waste. This symbol of the crossed out wheeled bin indicates that the battery should not be placed in municipal waste.

ASUS Recycling/Takeback Services

ASUS recycling and takeback programs come from our commitment to the highest standards for protecting our environment. We believe in providing solutions for you to be able to responsibly recycle our products, batteries, other components as well as the packaging materials. Please go to <http://csr.asus.com/english/Takeback.htm> for detailed recycling information in different regions.

RF Equipment Notices

CE: European Community Compliance Statement

The equipment complies with the RF Exposure Requirement 1999/519/EC, Council Recommendation of 12 July 1999 on the limitation of exposure of the general public to electromagnetic fields (0–300 GHz). This wireless device complies with the R&TTE Directive.

Wireless Radio Use

This device is restricted to indoor use when operating in the 5.15 to 5.25 GHz frequency band.

Exposure to Radio Frequency Energy

The radiated output power of the Wi-Fi technology is below the FCC radio frequency exposure limits. Nevertheless, it is advised to use the wireless equipment in such a manner that the potential for human contact during normal operation is minimized.

FCC Bluetooth Wireless Compliance

The antenna used with this transmitter must not be colocated or operated in conjunction with any other antenna or transmitter subject to the conditions of the FCC Grant.

Bluetooth Industry Canada Statement

This Class B device meets all requirements of the Canadian interference-causing equipment regulations.

Cet appareil numérique de la Class B respecte toutes les exigences du Règlement sur le matériel brouilleur du Canada.

BSMI: Taiwan Wireless Statement

無線設備的警告聲明

經型式認證合格之低功率射頻電機，非經許可，公司、商號或使用者均不得擅自變更射頻、加大功率或變更原設計之特性及功能。低功率射頻電機之使用不得影響飛航安全及干擾合法通信；經發現有干擾現象時，應立即停用，並改善至無干擾時方得繼續使用。前項合法通信指依電信法規定作業之無線通信。低功率射頻電機須忍受合法通信或工業、科學及醫療用電波輻射性電機設備之干擾。

於 5.25GHz 至 5.35GHz 區域內操作之
無線設備的警告聲明

工作頻率 5.250 ~ 5.350GHz 該頻段限於室內使用。

Japan RF Equipment Statement

この製品は、周波数帯域5.15~5.35GHzで動作しているときは、屋内においてのみ使用可能です。

KC (RF Equipment)

대한민국 규정 및 준수

방통위고시에 따른 고지사항

해당 무선설비는 운용 중 전파혼신 가능성이 있음.

이 기기는 인명안전과 관련된 서비스에 사용할 수 없습니다.

ASUS contact information

ASUSTeK COMPUTER INC.

Address 15 Li-Te Road, Peitou, Taipei, Taiwan 11259
Telephone +886-2-2894-3447
Fax +886-2-2890-7798
E-mail info@asus.com.tw
Web site www.asus.com.tw

Technical Support

Telephone +86-21-38429911
Online support support.asus.com

ASUS COMPUTER INTERNATIONAL (America)

Address 800 Corporate Way, Fremont, CA 94539, USA
Telephone +1-812-282-3777
Fax +1-510-608-4555
Web site usa.asus.com

Technical Support

Telephone +1-812-282-2787
Support fax +1-812-284-0883
Online support support.asus.com

ASUS COMPUTER GmbH (Germany and Austria)

Address Harkort Str. 21-23, D-40880 Ratingen, Germany
Fax +49-2102-959911
Web site www.asus.de
Online contact www.asus.de/sales

Technical Support

Telephone +49-1805-010923*
Support Fax +49-2102-9599-11
Online support support.asus.com

* EUR 0.14/minute from a German fixed landline; EUR 0.42/minute from a mobile phone.

DECLARATION OF CONFORMITY

Per FCC Part 2, Section 2.1077(a)



Responsible Party Name: **Asus Computer International**

Address: **800 Corporate Way, Fremont, CA 94539.**

Phone/Fax No: **(510)739-3777/(510)608-4555**

hereby declares that the product

Product Name : Motherboard

Model Number : P8Z77-V Premium

Conforms to the following specifications:

- FCC Part 15, Subpart B, Unintentional Radiators
- FCC Part 15, Subpart C, Intentional Radiators
- FCC Part 15, Subpart E, Intentional Radiators

Supplementary Information:

This device complies with part 15 of the FCC Rules. Operation is subject to the following two conditions: (1) This device may not cause harmful interference, and (2) this device must accept any interference received, including interference that may cause undesired operation.

Representative Person's Name : Steve Chang / President

Steve Chang

Signature :

Date : Apr. 13, 2012

Ver. 110101

EC Declaration of Conformity



We, the undersigned,

Manufacturer: **ASUSTeK COMPUTER INC.**
 Address, City: **No. 150, LITE RD., TPE101, TAIPEI 112, TAIWAN R.O.C.**
 Country: **TAIWAN**
 Authorized representative in Europe: **ASUS COMPUTER GmbH**
 Address, City: **HARKORT STR. 21-23, 40880 RATINGEN**
 Country: **GERMANY**

declare the following apparatus:

Product name : **Motherboard**
 Model name : **P8Z77-V Premium**

conform with the essential requirements of the following directives:

EN 55022:2006+A1:2007 **EN 55024:1998+A1:2001+A2:2003**
 EN 61000-3-2:2006+A2: 2009 **EN 61000-3-3:2008**
 EN 55013:2001+A1:2003+A2:2006 **EN 55020:2007**

EN 1999/5/EC-R & TTE Directive

EN 300 328 V1.7, 1(2006-10) **EN 301 488-1 V1.8, 1(2008-04)**
 EN 300 440-2 V1.2, 1(2008-03) **EN 301 488-4 V1.3, 1(2009-08)**
 EN 300 440-2 V1.2, 1(2008-03) **EN 301 488-7 V1.3, 1(2005-11)**
 EN 301 511 V9.0.2(2003-03) **EN 301 488-9 V1.4, 1(2007-11)**
 EN 300 908-1 V3.2, 1(2007-05) **EN 301 488-24 V1.4, 1(2007-11)**
 EN 300 908-1 V3.2, 1(2007-05) **EN 301 488-24 V1.4, 1(2007-09)**
 EN 301 833 V1.4, 1(2005-03) **EN 302 326-2 V1.2, 2(2007-06)**
 EN 302 544-2 V1.1, 1(2008-01) **EN 302 326-3 V1.3, 1(2007-06)**
 EN 55080:2001 **EN 55081:2001**
 EN 55082:2002 **EN 302 623 V1.1, 1(2009-01)**

EN 2006/95/EC-LVD Directive

EN 60950-1/A11:2009 **EN 60965:2005+A1:2006+A11:2008**
 EN 60950-1/A12:2011 **EN 60965:2002 / A12:2011**

EN 2009/125/EC-ERP Directive

Regulation (EC) No. 1275/2008
 EN 62301:2005 **EN 62301:2005**

Regulation (EC) No. 642/2009

Ver. 111(2)



(EC conformity marking)

Position : **CEO**
 Name : **Jerry Shen**

Jerry Shen

Signature : _____

Declaration Date: **Apr. 13, 2012**
 Year to begin affixing CE marking: **2012**