

**NCCH-DR**  
*Series*

**ASUS**<sup>®</sup>

**Motherboard**

**E1679**

**First Edition V1  
August 2004**

**Copyright © 2004 ASUSTeK COMPUTER INC. All Rights Reserved.**

No part of this manual, including the products and software described in it, may be reproduced, transmitted, transcribed, stored in a retrieval system, or translated into any language in any form or by any means, except documentation kept by the purchaser for backup purposes, without the express written permission of ASUSTeK COMPUTER INC. (“ASUS”).

Product warranty or service will not be extended if: (1) the product is repaired, modified or altered, unless such repair, modification or alteration is authorized in writing by ASUS; or (2) the serial number of the product is defaced or missing.

ASUS PROVIDES THIS MANUAL “AS IS” WITHOUT WARRANTY OF ANY KIND, EITHER EXPRESS OR IMPLIED, INCLUDING BUT NOT LIMITED TO THE IMPLIED WARRANTIES OR CONDITIONS OF MERCHANTABILITY OR FITNESS FOR A PARTICULAR PURPOSE. IN NO EVENT SHALL ASUS, ITS DIRECTORS, OFFICERS, EMPLOYEES OR AGENTS BE LIABLE FOR ANY INDIRECT, SPECIAL, INCIDENTAL, OR CONSEQUENTIAL DAMAGES (INCLUDING DAMAGES FOR LOSS OF PROFITS, LOSS OF BUSINESS, LOSS OF USE OR DATA, INTERRUPTION OF BUSINESS AND THE LIKE), EVEN IF ASUS HAS BEEN ADVISED OF THE POSSIBILITY OF SUCH DAMAGES ARISING FROM ANY DEFECT OR ERROR IN THIS MANUAL OR PRODUCT.

SPECIFICATIONS AND INFORMATION CONTAINED IN THIS MANUAL ARE FURNISHED FOR INFORMATIONAL USE ONLY, AND ARE SUBJECT TO CHANGE AT ANY TIME WITHOUT NOTICE, AND SHOULD NOT BE CONSTRUED AS A COMMITMENT BY ASUS. ASUS ASSUMES NO RESPONSIBILITY OR LIABILITY FOR ANY ERRORS OR INACCURACIES THAT MAY APPEAR IN THIS MANUAL, INCLUDING THE PRODUCTS AND SOFTWARE DESCRIBED IN IT.

Products and corporate names appearing in this manual may or may not be registered trademarks or copyrights of their respective companies, and are used only for identification or explanation and to the owners’ benefit, without intent to infringe.

# Contents

Notices .....	vi
Safety information .....	vii
About this guide .....	viii
Typography .....	ix
NCCH-DR Series specifications summary .....	x

## Chapter 1: Product introduction

1.1	Welcome! .....	1-1
1.2	Package contents .....	1-1
1.3	Special features .....	1-2
1.3.1	Product highlights .....	1-2
1.3.2	Innovative ASUS features .....	1-4

## Chapter 2: Hardware information

2.1	Before you proceed .....	2-1
2.2	Motherboard overview .....	2-2
2.2.1	Placement direction .....	2-2
2.2.2	Screw holes .....	2-2
2.2.3	CPU heatsink weight support .....	2-3
2.2.4	Motherboard layout .....	2-9
2.2.5	Layout contents .....	2-11
2.3	Central Processing Unit (CPU) .....	2-13
2.3.1	Installing the CPU .....	2-13
2.3.2	Installing the CPU heatsink(s) .....	2-15
2.4	System memory .....	2-16
2.4.1	Overview .....	2-16
2.4.2	Memory configurations .....	2-16
2.4.3	Installing a DIMM .....	2-18
2.4.4	Removing a DIMM .....	2-18
2.5	Expansion slots .....	2-19
2.5.1	Installing an expansion card .....	2-19
2.5.2	Configuring an expansion card .....	2-19
2.5.3	Interrupt assignments .....	2-20
2.5.4	PCI/PCI-X slots .....	2-20
2.6.	Jumpers .....	2-21
2.7	Connectors .....	2-26
2.7.1	Rear panel connectors .....	2-26
2.7.2	Internal connectors .....	2-27

# Contents

## Chapter 3: Powering up

- 3.1 Starting up for the first time ..... 3-1
- 3.2 Powering off the computer ..... 3-2
  - 3.2.1 Using the OS shut down function ..... 3-2
  - 3.2.2 Using the dual function power switch ..... 3-2

## Chapter 4: BIOS Setup

- 4.1 Managing and updating your BIOS ..... 4-1
  - 4.1.1 Creating a bootable floppy disk ..... 4-1
  - 4.1.2 AwardBIOS Flash Utility ..... 4-3
  - 4.1.3 ASUS CrashFree BIOS 2 utility ..... 4-7
  - 4.1.4 ASUS EZ Flash utility ..... 4-9
  - 4.1.5 ASUS Update utility ..... 4-10
- 4.2 BIOS Setup program ..... 4-13
  - 4.2.1 BIOS menu screen ..... 4-14
  - 4.2.2 Menu bar ..... 4-14
  - 4.2.3 Navigation keys ..... 4-14
  - 4.2.4 General help ..... 4-15
  - 4.2.5 Sub-menu ..... 4-15
  - 4.2.6 Scroll bar ..... 4-15
  - 4.2.7 Pop-up window ..... 4-15
- 4.3 Main menu ..... 4-16
  - 4.3.1 Primary IDE Master ..... 4-17
  - 4.3.2 Primary IDE Slave ..... 4-19
  - 4.3.3 Secondary IDE Master ..... 4-19
  - 4.3.4 Secondary IDE Slave ..... 4-19
- 4.4 Advanced menu ..... 4-20
  - 4.4.1 Advanced BIOS Features ..... 4-21
  - 4.4.2 CPU Configuration ..... 4-22
  - 4.4.3 Memory Configuration ..... 4-23
  - 4.4.4 Chipset ..... 4-24
  - 4.4.5 Onboard Device ..... 4-25
  - 4.4.6 PCIPnP ..... 4-29
  - 4.4.7 USB Configuration ..... 4-31
- 4.5 Power menu ..... 4-32
  - 4.5.1 APM Configuration ..... 4-33
  - 4.5.2 Hardware Monitor ..... 4-36

# Contents

4.6	Boot menu .....	4-38
4.6.1	Boot Device Priority .....	4-38
4.6.2	Hard Disk Boot Priority .....	4-39
4.6.3	Removable Device Priority .....	4-39
4.6.4	CD-ROM Boot Priority .....	4-40
4.6.5	Boot Settings Configuration .....	4-40
4.6.6	Security .....	4-42
4.7	Exit menu .....	4-44

## Appendix: Reference information

A.1	NCCH-DR block diagram .....	A-1
-----	-----------------------------	-----

# Notices

## Federal Communications Commission Statement

This device complies with Part 15 of the FCC Rules. Operation is subject to the following two conditions:

- This device may not cause harmful interference, and
- This device must accept any interference received including interference that may cause undesired operation.

This equipment has been tested and found to comply with the limits for a Class B digital device, pursuant to Part 15 of the FCC Rules. These limits are designed to provide reasonable protection against harmful interference in a residential installation. This equipment generates, uses and can radiate radio frequency energy and, if not installed and used in accordance with manufacturer's instructions, may cause harmful interference to radio communications. However, there is no guarantee that interference will not occur in a particular installation. If this equipment does cause harmful interference to radio or television reception, which can be determined by turning the equipment off and on, the user is encouraged to try to correct the interference by one or more of the following measures:

- Reorient or relocate the receiving antenna.
- Increase the separation between the equipment and receiver.
- Connect the equipment to an outlet on a circuit different from that to which the receiver is connected.
- Consult the dealer or an experienced radio/TV technician for help.



---

The use of shielded cables for connection of the monitor to the graphics card is required to assure compliance with FCC regulations. Changes or modifications to this unit not expressly approved by the party responsible for compliance could void the user's authority to operate this equipment.

---

## Canadian Department of Communications Statement

This digital apparatus does not exceed the Class B limits for radio noise emissions from digital apparatus set out in the Radio Interference Regulations of the Canadian Department of Communications.

**This class B digital apparatus complies with Canadian ICES-003.**

# Safety information

## Electrical safety

- To prevent electrical shock hazard, disconnect the power cable from the electrical outlet before relocating the system.
- When adding or removing devices to or from the system, ensure that the power cables for the devices are unplugged before the signal cables are connected. If possible, disconnect all power cables from the existing system before you add a device.
- Before connecting or removing signal cables from the motherboard, ensure that all power cables are unplugged.
- Seek professional assistance before using an adapter or extension cord. These devices could interrupt the grounding circuit.
- Make sure that your power supply is set to the correct voltage in your area. If you are not sure about the voltage of the electrical outlet you are using, contact your local power company.
- If the power supply is broken, do not try to fix it by yourself. Contact a qualified service technician or your retailer.

## Operation safety

- Before installing the motherboard and adding devices on it, carefully read all the manuals that came with the package.
- Before using the product, make sure all cables are correctly connected and the power cables are not damaged. If you detect any damage, contact your dealer immediately.
- To avoid short circuits, keep paper clips, screws, and staples away from connectors, slots, sockets and circuitry.
- Avoid dust, humidity, and temperature extremes. Do not place the product in any area where it may become wet.
- Place the product on a stable surface.
- If you encounter technical problems with the product, contact a qualified service technician or your retailer.

## About this guide

This user guide contains the information you need when installing and configuring the motherboard.

## How this guide is organized

This manual contains the following parts:

- **Chapter 1: Product introduction**  
This chapter describes the features of the motherboard and the new technology it supports.
- **Chapter 2: Hardware information**  
This chapter lists the hardware setup procedures that you have to perform when installing system components. It includes description of the switches, jumpers, and connectors on the motherboard.
- **Chapter 3: Powering up**  
This chapter describes the power up sequence, the vocal POST messages, and ways of shutting down the system.
- **Chapter 4: BIOS setup**  
This chapter tells how to change system settings through the BIOS Setup menus. Detailed descriptions of the BIOS parameters are also provided.
- **Appendix: Reference information**  
This appendix includes additional information that you may refer to when configuring the motherboard.

## Where to find more information

Refer to the following sources for additional information and for product and software updates.

### 1. ASUS websites

The ASUS website provides updated information on ASUS hardware and software products. Refer to the ASUS contact information.

### 2. Optional documentation

Your product package may include optional documentation, such as warranty flyers, that may have been added by your dealer. These documents are not part of the standard package.



## Conventions used in this guide

To make sure that you perform certain tasks properly, take note of the following symbols used throughout this manual.



**DANGER/WARNING:** Information to prevent injury to yourself when trying to complete a task.



**CAUTION:** Information to prevent damage to the components when trying to complete a task.



**IMPORTANT:** Instructions that you **MUST** follow to complete a task.



**NOTE:** Tips and additional information to help you complete a task.

## Typography

**Bold text**

Indicates a menu or an item to select.

*Italics*

Used to emphasize a word or a phrase.

<Key>

Keys enclosed in the less-than and greater-than sign means that you must press the enclosed key.

Example: <Enter> means that you must press the Enter or Return key.

<Key1+Key2+Key3>

If you must press two or more keys simultaneously, the key names are linked with a plus sign (+).

Example: <Ctrl+Alt+D>

**Command**

Means that you must type the command exactly as shown, then supply the required item or value enclosed in brackets.

Example: At the DOS prompt, type the command line:

```
afudos /i[filename]
```

```
afudos /iNCCH-SR.ROM
```

## NCCH-DR Series specifications summary

<b>CPU</b>	Support for dual Intel® Xeon™ Processors up to 4.4+ GHz with Hyper-Threading Technology Support for Extended Memory 64-bit Technology (EM64T) On-die 1MB L2 cache
<b>Chipset</b>	North bridge: Intel® E7210 Memory Controller Hub (MCH) South bridge: Intel® 6300ESB I/O Controller Hub (ICH)
<b>Front Side Bus</b>	800 MHz
<b>Memory</b>	Dual-channel memory architecture 4 x 184-pin DDR DIMM sockets for up to 4GB memory Supports PC3200/PC2700 unbuffered ECC or non-ECC DDR DIMMs
<b>Expansion slots</b>	1 x PCI-X 66 MHz/64-bit slot (supports ZCR, PCI-X 1.0) 1 x PCI-X 66 MHz/64-bit slot (PCI-X 1.0) 3 x PCI 33 MHz/32-bit slot (PCI 2.3)
<b>Storage</b>	<p><b>IDE model</b> Intel® 6300ESB South Bridge supports:</p> <ul style="list-style-type: none"> <li>- 2 x UltraDMA100/66/33</li> <li>- 2 x Serial ATA 150 connectors that support RAID 0, RAID 1 configurations, and the Intel® Matrix Storage Technology</li> </ul> <p><b>SATA model</b> IDE model storage + Adaptec® AIC-8130 PCI-X SATA-II controller that supports:</p> <ul style="list-style-type: none"> <li>- 4 x SATA-II connectors (300 Mbps)</li> <li>- RAID 0, RAID 1, or RAID 0+1 configurations</li> <li>- Zero-Channel RAID (optional)</li> </ul>
<b>LAN</b>	Intel® PRO/1000 CT Network Connection (82547GI) Intel® PRO/1000 MT Network Connection (82541GI)
<b>USB</b>	USB 2.0 (480 Mbps) / 1.1 (12 Mbps)
<b>BIOS features</b>	8Mb Flash ROM, Award BIOS, PnP, DMI, WfM2.0, SM BIOS2.3
<b>Rear panel</b>	1 x PS/2 keyboard port 1 x PS/2 mouse port 2 x USB 2.0 ports 1 x Serial port 1 x Video port 2 x Gigabit LAN (RJ-45) ports

*(continued on the next page)*

## NCCH-DR Series specifications summary

<b>Internal connectors</b>	<ul style="list-style-type: none"> <li>Floppy disk drive connector</li> <li>IDE connectors</li> <li>Serial ATA connectors</li> <li>Serial ATA RAID connectors (SATA models only)</li> <li>Hard disk activity LED connector</li> <li>CPU and system fan connectors</li> <li>USB port connector</li> <li>SSI power connectors</li> <li>Serial port connector</li> <li>Printer port connector</li> <li>Backplane SMBus connector</li> <li>Power supply SMBus connector</li> <li>BMC connector</li> <li>Auxiliary panel connector</li> <li>System panel connector</li> </ul>
<b>Industry standard</b>	PCI 2.3, PCI-X 1.0, USB 2.0
<b>Manageability</b>	WfM 2.0, DMI 2.0, WOL/WOR by PME, chassis intrusion
<b>Power Requirement</b>	SSI-type power supply (with 24-pin and 8-pin power plugs)
<b>Form Factor</b>	Extended ATX form factor: 12 in x 10.5 in (30.5 cm x 26.7 cm)
<b>Innovative ASUS features</b>	<ul style="list-style-type: none"> <li>ASUS CrashFree BIOS 2</li> <li>ASUS Q-Fan 2</li> <li>ASUS EZFlash</li> <li>ASUS MyLogo 2</li> </ul>
<b>Support CD contents</b>	<ul style="list-style-type: none"> <li>Device drivers</li> <li>ASUS Server Web-based Management (ASWM) software</li> <li>System utilities</li> <li>ASUS contact information</li> </ul>

*\*Specifications are subject to change without notice.*



This chapter describes the motherboard features and the new technologies it supports.

# Product introduction



# Chapter summary



1.1	Welcome! .....	1-1
1.2	Package contents .....	1-1
1.3	Special features .....	1-2

## 1.1 Welcome!

**Thank you for buying the ASUS® NCCH-DR motherboard!**

The ASUS NCCH-DR motherboard delivers a host of new features and latest technologies making it another standout in the long line of ASUS quality motherboards!

Before you start installing the motherboard, and hardware devices on it, check the items in your package with the list below.

## 1.2 Package contents

Check your motherboard package for the following items.

---

<b>Motherboard</b>	ASUS NCCH-DR motherboard
<b>Cables</b>	<b>IDE model:</b> 2 x Serial ATA signal cables 1 x Serial ATA power cables (dual-plug) 1 x Ultra DMA 100/66 IDE and floppy drive cable (3-in-1)  <b>SATA model:</b> 6 x Serial ATA signal cables 3 x Serial ATA power cables (dual-plug) 1 x Ultra DMA 100/66 IDE and floppy drive cable (3-in-1)
<b>I/O module</b>	Printer port module
<b>Accessories</b>	I/O shield X-PAD accessory kit 2 x CEK spring
<b>Application CDs</b>	ASUS motherboard support CD (includes ASWM)
<b>Documentation</b>	User guide

---



---

If any of the above items is damaged or missing, contact your retailer.

---

## 1.3 Special features

### 1.3.1 Product highlights

#### Latest processor technology

The motherboard comes with dual 604-pin surface mount ZIF sockets designed for the Intel® Xeon™ processor with 800 MHz Front Side Bus (FSB) and 1 MB L2 cache. The processor incorporates the Intel® Hyper-Threading Technology, the Intel® NetBurst™ micro-architecture that features hyper-pipelined technology, and Extended Memory 64-bit Technology (EM64T). The EM64T enables the support for 64-bit operation system, such as 64-bit Windows® and Linux. See page 2-13 for details.

#### Intel® E7210 and Intel® 6300 ESB chipset

The Intel® E7210 Memory Controller Hub (MCH) and the Intel® 6300ESB I/O controller hub (ICH) provide the vital interfaces for the motherboard.

The MCH provides the processor, dual-channel DDR400 memory, and CSA interfaces. The ICH is a new generation server class I/O controller hub that provides the interface for PCI-X 1.0a and other interfaces.

#### Dual-channel memory support

Employing the dual-channel DDR memory architecture, the motherboard provides a solution that doubles the system memory bandwidth to boost system performance. The motherboard supports up to 4 GB of system memory using PC3200/PC2700 ECC or non-ECC DDR DIMMs to deliver up to 6.4 GB/s data transfer rate for the latest 3D graphics, multimedia, and Internet applications. See page 2-16 for details.

#### Serial ATA technology

The motherboard supports the Serial ATA technology through the Serial ATA interfaces controlled by the Intel® 6300ESB and the Adaptec AIC-8130 PCI-X SATA-II controller (on SATA models only). The SATA specification allows for thinner, more flexible cables with lower pin count, reduced voltage requirement, and up to 150 MB/s data transfer rate for 6300ESB and 300 MB/s for AIC-8130. See page 2-28 to 2-29 for details.

#### Built-in SATA RAID solution

The Intel® 6300ESB allows RAID 0 and RAID 1 configuration for two SATA connectors and supports the Intel® Matrix Storage Technology. See page 2-28 for details.

For SATA models, the Adaptec AIC-8130 PCI-X SATA-II (300 Mbps) controller supports four additional SATA connectors, and allows RAID 0, RAID 1, and RAID 0+1 configuration. See page 2-29 for details.



## Dual Gigabit LAN solution

The Intel® PRO/1000 CT Network Connection allows full-duplex Gigabit performance on LAN on Motherboard (LOM) applications through the Communication Streaming Architecture (CSA). Instead of connecting to the PCI bus, the controller connects to the dedicated CSA bus on the Memory Controller Hub (MCH) thus reducing the PCI bottlenecks by freeing the PCI bus for other I/O operations.

The Intel® PRO/1000 MT Network Connection is also onboard to support 32-bit LAN through the PCI bus. See page 2-26 for details.

## Zero-Channel RAID (ZCR) solution (on SATA models only)

The Adaptec AIC-8130 PCI-X SATA-II controller also supports an optional Zero-Channel RAID card on the 64-bit PCI-X slot to create a RAID solution, including RAID 0 (striping), RAID 1 (mirroring), RAID 0+1, and RAID 5. The ZCR capability provides a cost-effective, high-performance RAID sets.

## Integrated graphics

The onboard ATI Rage™ XL graphics controller with 8MB memory provides a reliable graphics solution for server applications. See page 2-26 for details.

## USB 2.0 technology

The motherboard implements the Universal Serial Bus (USB) 2.0 specification, dramatically increasing the connection speed from the 12 Mbps bandwidth on USB 1.1 to a fast 480 Mbps on USB 2.0. USB 2.0 is backward compatible with USB 1.1. See page 2-26 and 2-30 for details.

## Temperature, fan, and voltage monitoring

The CPU temperature is monitored by the ASIC (integrated in the Winbond Super I/O) to prevent overheating and damage. The system fan rotations per minute (RPM) is monitored for timely failure detection. The ASIC monitors the voltage levels to ensure stable supply of current for critical components. See page 4-36 and 4-37 for details.

## 1.3.2 Innovative ASUS features

### ASUS CrashFree BIOS 2

This feature allows you to restore the original BIOS data from the support CD in case when the BIOS codes and data are corrupted. This protection eliminates the need to buy a replacement ROM chip. See page 4-7 for details.

### ASUS EZ Flash BIOS

With the ASUS EZ Flash, you can easily update the system BIOS even before loading the operating system. No need to use a DOS-based utility or boot from a floppy disk. See page 4-9 for details.

### ASUS Q-Fan 2 technology

The ASUS Q-Fan 2 technology smartly adjusts the fan speeds according to the system loading to ensure quiet, cool, and efficient operation. See page 4-37 for details.

### ASUS MyLogo2™

This new feature present in the motherboard allows you to personalize and add style to your system with customizable boot logos. See page 4-40 for details.

This chapter lists the hardware setup procedures that you have to perform when installing system components. It includes description of the jumpers and connectors on the motherboard.

# Hardware information



## Chapter summary



2.1	Before you proceed .....	2-1
2.2	Motherboard overview .....	2-2
2.3	Central Processing Unit (CPU) .....	2-13
2.4	System memory .....	2-16
2.5	Expansion slots .....	2-19
2.6.	Jumpers .....	2-21
2.7	Connectors .....	2-26

## 2.1 Before you proceed

Take note of the following precautions before you install motherboard components or change any motherboard settings.



- Unplug the power cord from the wall socket before touching any component.
- Use a grounded wrist strap or touch a safely grounded object or to a metal object, such as the power supply case, before handling components to avoid damaging them due to static electricity.
- Hold components by the edges to avoid touching the ICs on them.
- Whenever you uninstall any component, place it on a grounded antistatic pad or in the bag that came with the component.
- **Before you install or remove any component, ensure that the power supply is switched off or the power cord is detached from the power supply.** Failure to do so may cause severe damage to the motherboard, peripherals, and/or components.

### Onboard LED

The motherboard comes with a standby power LED. The green LED lights up to indicate that the system is ON, in sleep mode, or in soft-off mode. This is a reminder that you should shut down the system and unplug the power cable before removing or plugging in any motherboard component. The illustration below shows the location of the onboard LED.

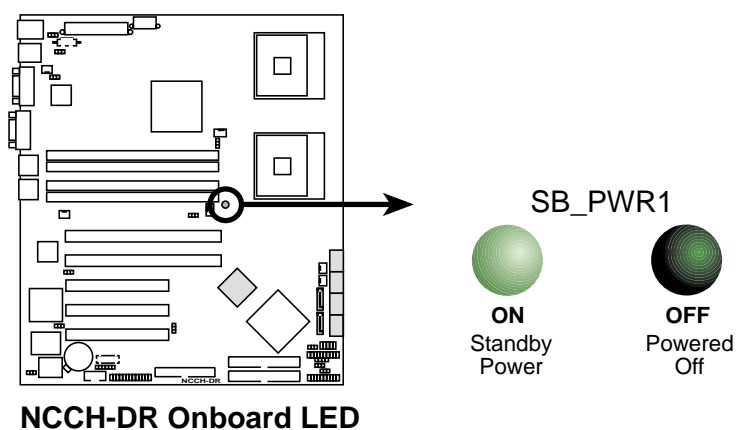

## 2.2 Motherboard overview

Before you install the motherboard, study the configuration of your chassis to ensure that the motherboard fits into it.



Make sure to unplug the chassis power cord before installing or removing the motherboard. Failure to do so can cause you physical injury and damage motherboard components.

### 2.2.1 Placement direction

When installing the motherboard, make sure that you place it into the chassis in the correct orientation. The edge with external ports goes to the rear part of the chassis as indicated in the image below.

### 2.2.2 Screw holes

Place nine (9) screws into the holes indicated by circles to secure the motherboard to the chassis.



Do not overtighten the screws! Doing so can damage the motherboard.

Place this side towards  
the rear of the chassis

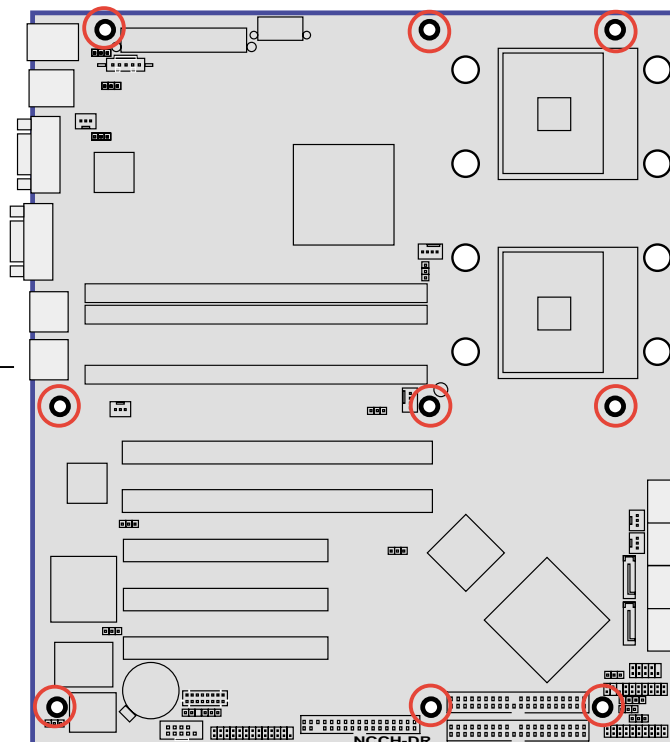

## 2.2.3 CPU heatsink weight support

For additional protection from motherboard breakage due to the weight of the CPU heatsinks, your motherboard package comes with two solution kits.

- X-PAD accessory kit containing:
  - 2 x metal support plates
  - 1 x contour sheet
  - 3 different sets of metal nuts and rubber pads for varied chassis standoffs (each set contains 8 metal nuts and 2 rubber pads)
- 2 x CEK spring

You can use any of the two solutions to protect the motherboard.

### Using the X-PAD accessory kit

To install the support plates:

1. Open and lay your system chassis on a stable surface, then locate the motherboard standoffs.

Standoff

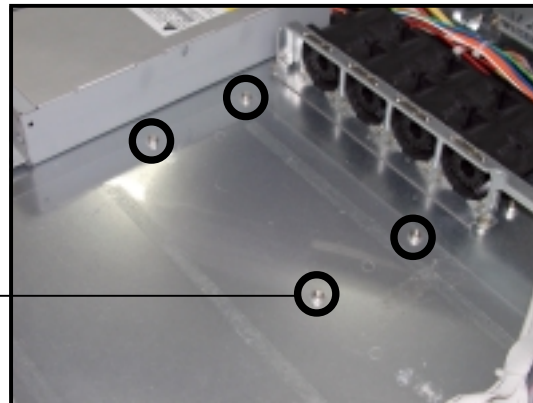

2. Align the holes of the contour sheet with the standoffs on the base of the chassis. Press the sheet flat making sure that it is completely pressed against to the chassis.

Standoff beside power supply

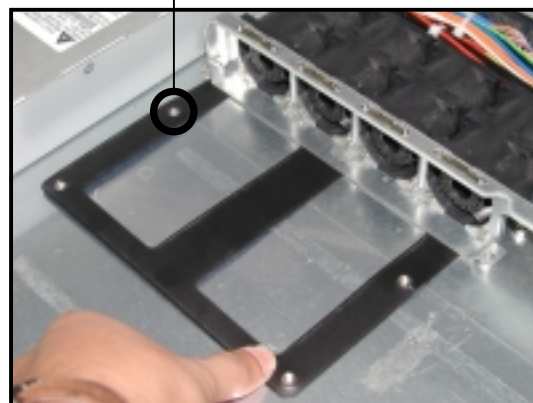

The contour sheet fits in only one orientation. Make sure that the hole located about 1 cm from the corner matches the standoff beside the power supply.

3. Determine the height of the standoffs on your chassis, and select the appropriate set of metal nuts and rubber pads from your package.



Use a nut size that is slightly lower than the standoffs on your chassis.

4. Use a plier to attach four nuts to the bolts on the metal support plate.



5. Align a rubber pad to the rectangular mark on the center of the plate, then press to attach.



6. Remove the adhesive label underneath a plate.





7. Carefully align and place the plate on a rectangular cut on the contour sheet.



---

Make sure that the metal support plates fit perfectly to the rectangular cuts on the contour sheet; otherwise, the CPU heatsink screws would not align to the metal nuts.

---

8. Repeat steps 4 and 7 to prepare and install the second plate.

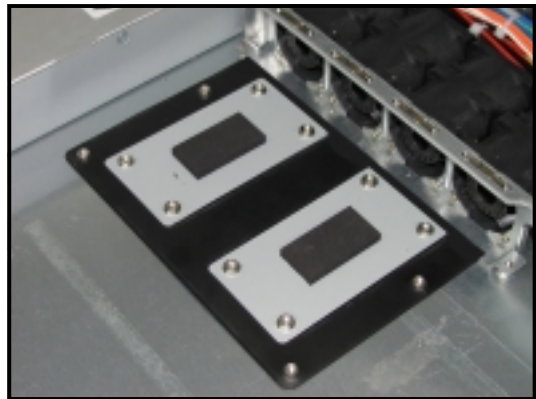

9. Remove the contour sheet from the chassis.

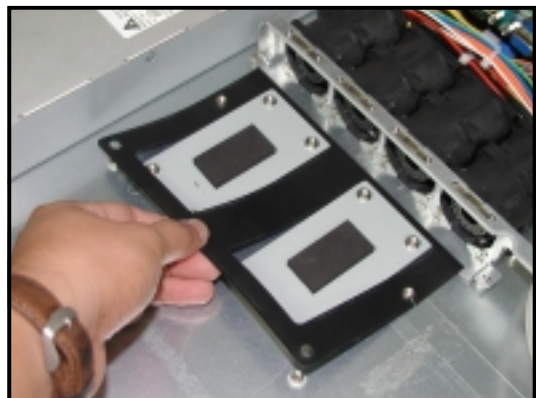

The support plates appear as shown when installed.

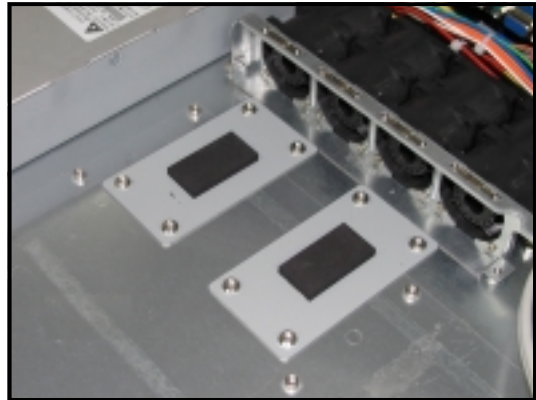

9. Install the motherboard with the external I/O ports toward the chassis rear panel. The CPU sockets should be right on top of the support plates.

**Heatsink hole matched to a nut on the support plate**

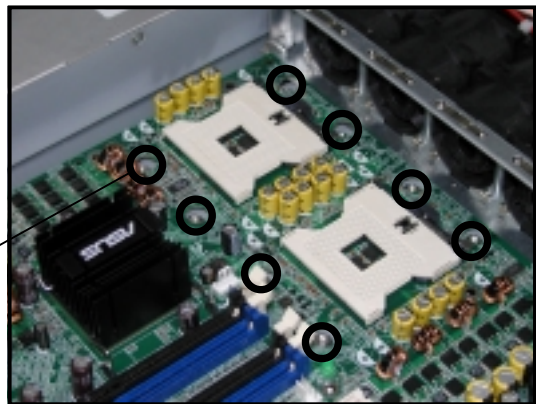

---

Make sure that the CPU heatsink holes on the motherboard perfectly match the metal nuts on the support plates; otherwise, you can not install the CPU heatsinks properly.

---

10. Secure the motherboard with 9 screws. Refer to section “2.2.2 Screw holes” for illustration.

## Using the CEK springs

Two CEK springs come with the motherboard package. You can also use these springs to support the weight of the CPU heatsinks. Take note of the four CEK spring hooks located beside the screw holes.

CEK spring hook



To install the CEK spring:

1. Locate the CPU heatsink holes on the motherboard.

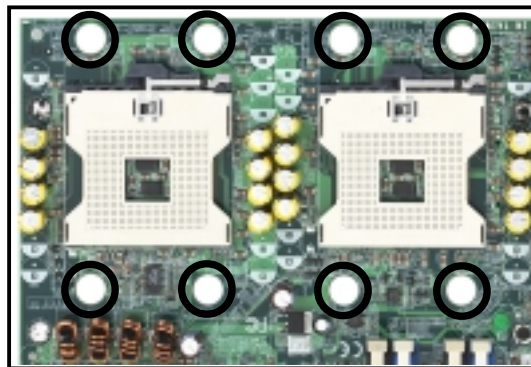

2. Position the CEK spring underneath the motherboard, then match the CEK spring hooks to the CPU1 heatsink holes.

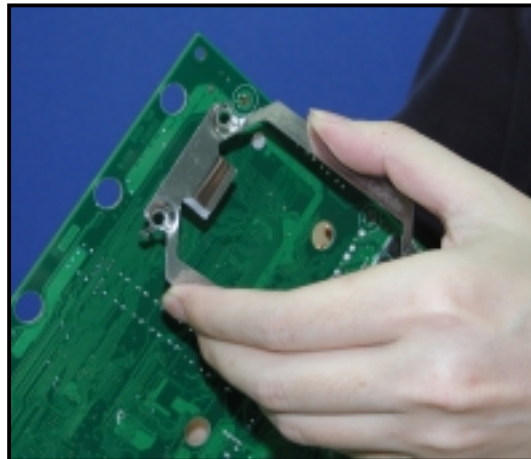

3. Press the upper spring hooks inward, then insert to the upper CPU heatsink holes until they snap in place.



4. Press the lower spring hooks inward, then insert to the lower CPU heatsink holes until they snap in place.
5. Repeat the process to install the second spring to the CPU2 heatsink holes.

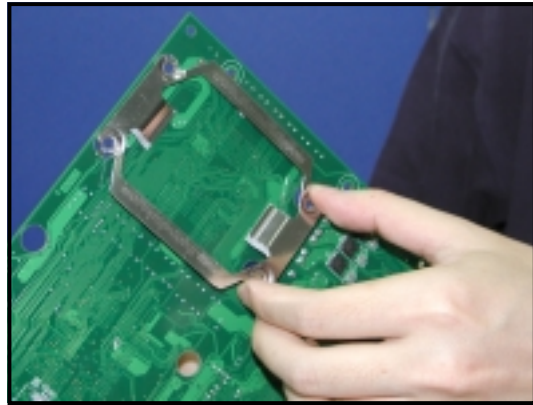

The support plates appear as shown when installed.

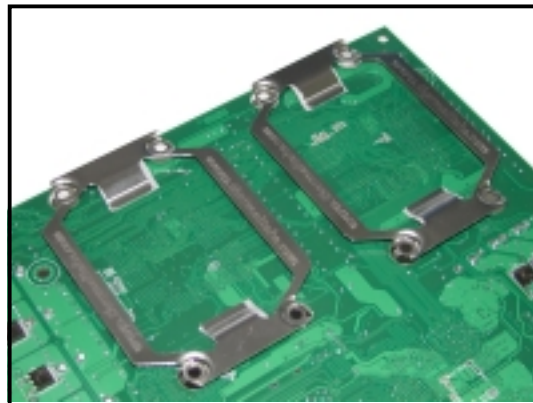

6. Install the motherboard with the external I/O ports toward the chassis rear panel. The CPU sockets should be right on top of the CEK springs.

**Heatsink hole matched to the hole on the CEK spring**

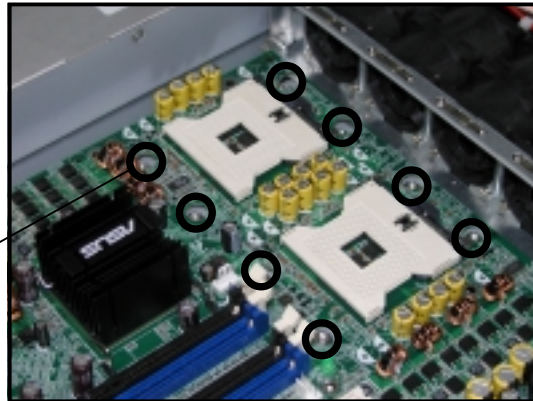

7. Secure the motherboard with 9 screws. Refer to section “2.2.2 Screw holes” for illustration.

## 2.2.4 Motherboard layout

### IDE model

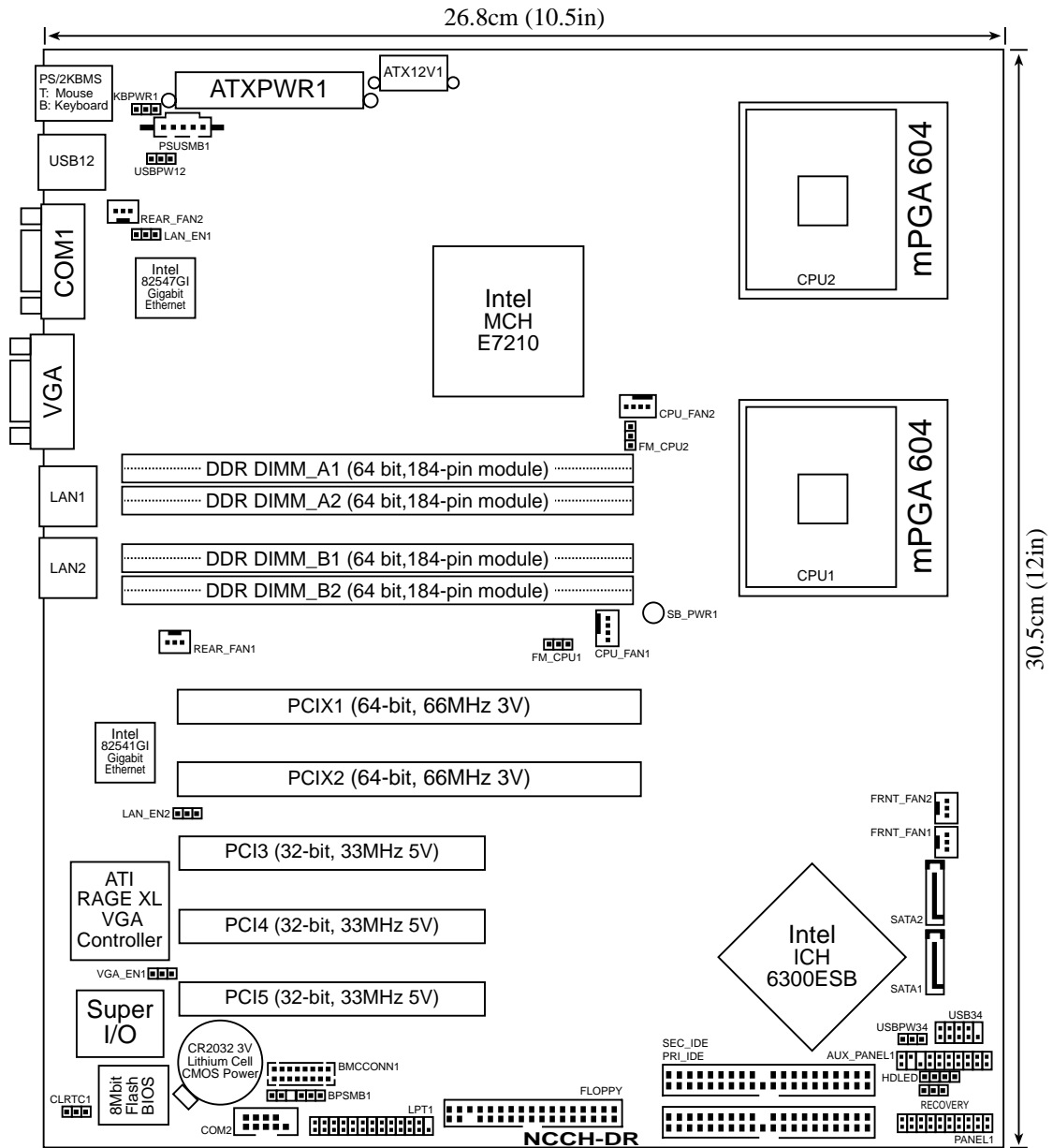



## 2.2.5 Layout contents

Slots	Page
1. CPU sockets	2-13
2. DDR DIMM sockets	2-16
3. PCI/PCI-X slots	2-20

Jumpers	Page
Clear RTC RAM (CLRRTC1)	2-21
CPU fan pin selection (3-pin FM_CPU1, FM_CPU2)	2-22
USB device wake-up (3-pin USBPW12, USBPW34)	2-22
Keyboard power (3-pin KBPWR1)	2-23
SATA controller setting (3-pin SATA_EN1) <i>SATA models only</i>	2-23
SATA controller LED setting (3-pin 8130LED1) <i>SATA models only</i>	2-24
Gigabit LAN controller setting (3-pin LAN_EN1; LAN_EN2)	2-24
Integrated graphics controller (3-pin VGA_EN1)	2-25
Force BIOS recovery (3-pin RECOVERY)	2-25

Rear panel connectors	Page
1. PS/2 mouse port (green)	2-26
2. PS/2 keyboard port (purple)	2-26
3. USB 2.0 ports 1 and 2	2-26
4. Serial (COM1) port	2-26
5. VGA port	2-26
6. LAN1 (RJ-45) port	2-26
7. LAN2 (RJ-45) port	2-26

Internal connectors	Page
Floppy disk drive connector (34-1 pin FLOPPY)	2-27
IDE connectors (40-1 pin PRI_IDE, SEC_IDE)	2-27
Serial ATA connectors (7-pin SATA1, SATA2)	2-28
Serial ATA RAID connectors (7-pin SATA_RAID1, SATA_RAID2, SATA_RAID3, SATA_RAID4) <i>SATA models only</i>	2-29
Hard disk activity LED connector (2-pin HDLED)	2-29
CPU and system fan connectors (4-pin CPU_FAN1/2, 3-pin REAR_FAN1/2, FRNT_FAN1/2)	2-30
USB port connector (10-1 pin USB34)	2-30
SSI power connectors (24-pin ATXPWR1, 8-pin ATX12V1)	2-31
Serial port connector (10-1 pin COM2)	2-32
Printer port connector (26-1 pin LPT1)	2-32
Backplane SMBus connector (6-1 pin BPSMB1)	2-33
Power supply SMBus connector (5-pin PSUSMB1)	2-33
BMC connector (16-pin BMCCONN1)	2-34
Auxiliary panel connector (20-2 pin AUX_PANEL1)	2-34
System panel connector (20-pin PANEL1)	2-35
System power LED (Green 3-pin PLED)	2-35
Message LED (Brown 2-pin MLED)	2-35
Hard disk drive activity LED (Red 2-pin HDD_LED)	2-35
System warning speaker (Orange 4-pin SPEAKER)	2-35
ATX power button/soft-off button (Yellow 2-pin PWRSW)	2-35
Reset button (Blue 2-pin RESET)	2-35



## 2.3 Central Processing Unit (CPU)

The motherboard comes with a surface mount 604-pin Zero Insertion Force (ZIF) sockets. The sockets are designed for the Intel® Xeon™ processor in the 604-pin package with 1 MB L2 cache. The new generation Xeon™ processor supports 800 MHz system bus and EM64T.

### 2.3.1 Installing the CPU

To install a CPU:

1. Locate the CPU sockets on the motherboard.

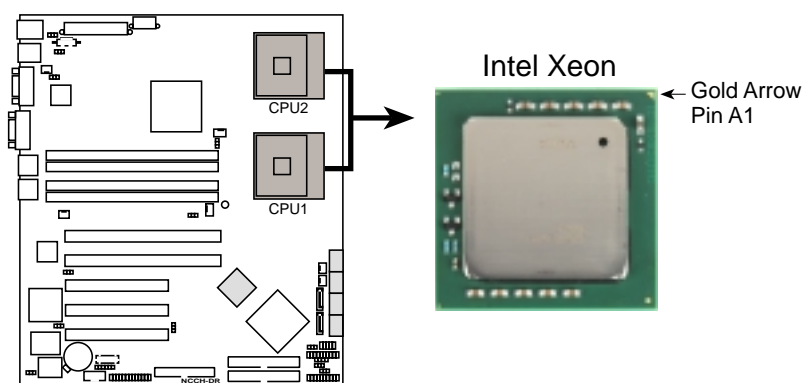

**NCCH-DR CPU Socket 604**



---

If installing only one CPU, use the socket CPU1.

---

2. Flip up the socket lever and push it all the way to the other side.



---

Make sure that the socket lever is pushed back all the way, otherwise the CPU does not fit in completely.

---

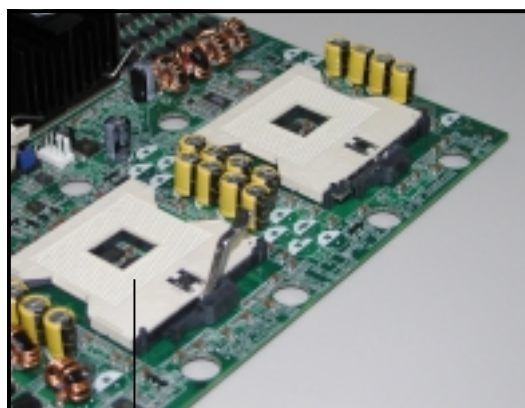

**Socket for CPU1**

3. Position the CPU above the socket as shown.
4. Carefully insert the CPU into the socket until it fits in place.



The CPU fits only in one correct orientation. DO NOT force the CPU into the socket to prevent bending the pins and damaging the CPU!

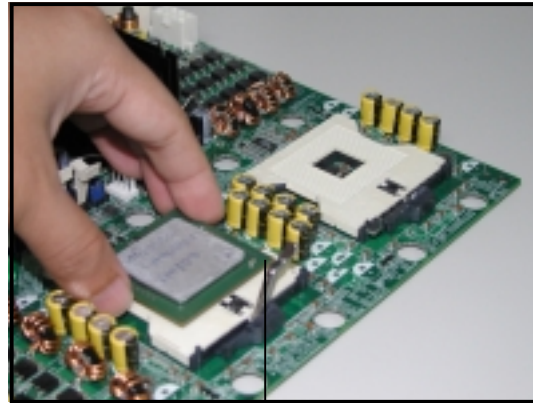

Marked corner  
(gold arrow)

5. Carefully push down the socket lever to secure the CPU. The lever clicks on the side tab to indicate that it is locked.
6. Apply the thermal interface material (thermal grease) to the top of the CPU. This thermal grease should come with the CPU package.
7. Repeat steps 1 to 6 if you wish to install a second CPU.

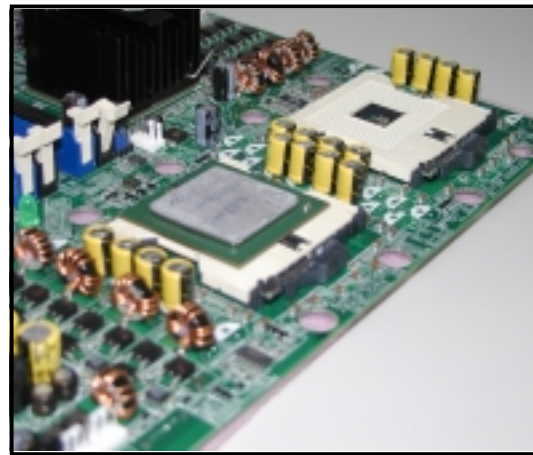

## 2.3.2 Installing the CPU heatsink(s)

The Intel® Xeon™ processors require specially-designed passive heatsinks to provide optimum thermal condition and performance. Visit the ASUS website ([www.asus.com](http://www.asus.com)) for an updated list of qualified heatsinks tested for use on this motherboard.



---

Make sure that you have applied the thermal grease to the top of the CPU before installing the heatsink.

---

To install the CPU heatsink and fan:

1. Place the heatsink on top of the installed CPU, making sure that the four screws on the heatsink align with the nuts on the support plate or with the holes of the CEK spring.

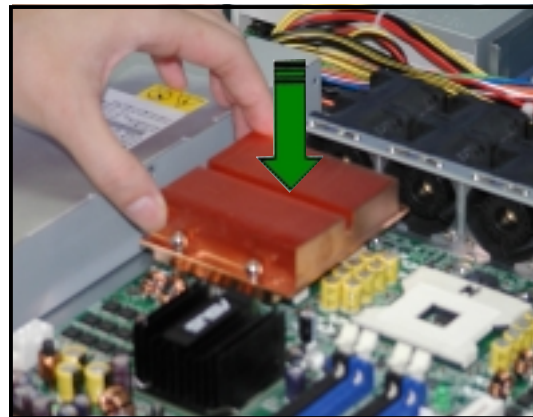

2. Use a Phillips screwdriver to tighten the four heatsink screws in a diagonal sequence.



3. Repeat the process to install the second heatsink on top of the second CPU, if any.



## 2.4 System memory

### 2.4.1 Overview

The motherboard comes with four Double Data Rate (DDR) Dual Inline Memory Modules (DIMM) sockets.

The following figure illustrates the location of the DDR DIMM sockets:

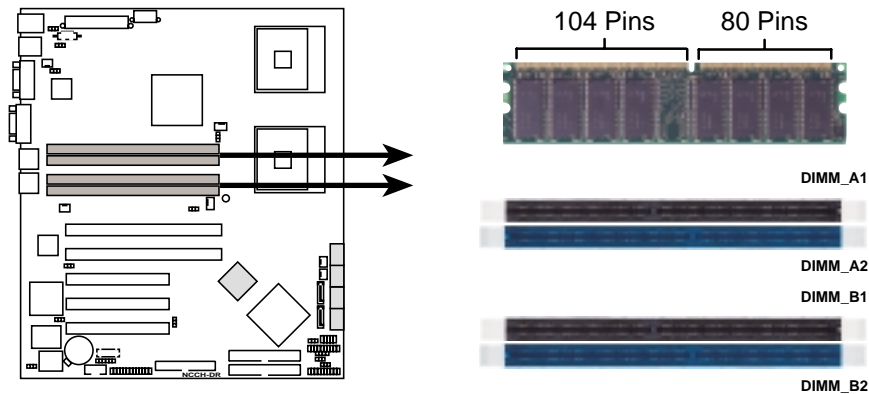

**NCCH-DR 184-Pin DDR DIMM sockets**

### 2.4.2 Memory configurations

You may install 128 MB, 256 MB, 512 MB and 1 GB unbuffered ECC or non-ECC DDR DIMMs into the DIMM sockets.



- Installing DDR DIMMs other than the recommended configurations may cause memory sizing error or system boot failure. Use any of the recommended configurations in Table 1.
- Always install DIMMs with the same CAS latency. For optimum compatibility, it is recommended that you obtain memory modules from the same vendor. Refer to the DDR Qualified Vendors List on the the ASUS website for details.
- In dual-channel configurations, install only identical (the same type and size) DDR DIMM pairs on each channel.
- Due to chipset resource allocation, the system may detect less than 4 GB system memory when you installed four 1 GB DDR memory modules.
- Three DDR DIMMs installed into any three memory sockets will function in single-channel mode.

**Table 1: Recommended memory configurations**

Mode		Sockets			
		DIMM_A1 (black)	DIMM_A2 (blue)	DIMM_B1 (black)	DIMM_B2 (blue)
Single-channel (DDR400/DDR333)	(1)	Populated	—	—	—
	(2)	—	Populated	—	—
	(3)	—	—	Populated	—
	(4)	—	—	—	Populated
Dual-channel (DDR400/DDR333)	(1)	Populated	—	Populated	—
	(2)	—	Populated	—	Populated
	(3)*	Populated	Populated	Populated	Populated

\* For dual-channel configuration (3), you may:

- install identical DIMMs in all four sockets, or
- install identical DIMMs in DIMM\_A1 and DIMM\_B1 (black sockets) and identical DIMMs in DIMM\_A2 and DIMM\_B2 (blue sockets)

## 2.4.3 Installing a DIMM



Unplug the power supply before adding or removing DIMMs or other system components. Failure to do so can cause severe damage to both the motherboard and the components.

To install a DIMM:

1. Unlock a DIMM socket by pressing the retaining clips outward.
2. Align a DIMM on the socket such that the notch on the DIMM matches the break on the socket.

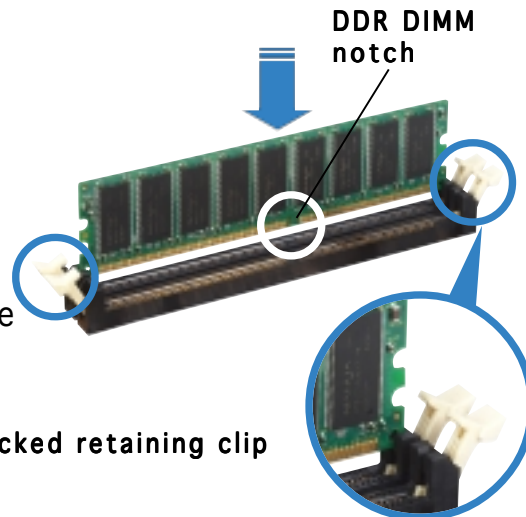

A DDR DIMM is keyed with a notch so that it fits in only one direction. DO NOT force a DIMM into a socket to avoid damaging the DIMM.

3. Firmly insert the DIMM into the socket until the retaining clips snap back in place and the DIMM is properly seated.

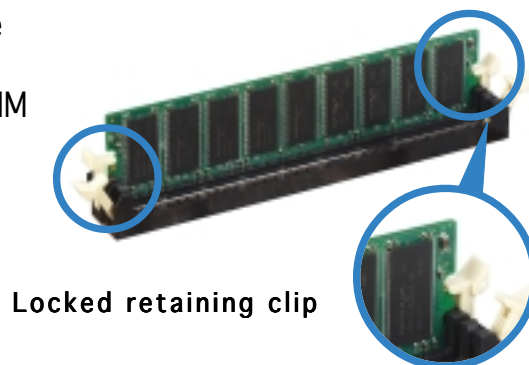

## 2.4.4 Removing a DIMM

Follow these steps to remove a DIMM.

1. Simultaneously press the retaining clips outward to unlock the DIMM.



Support the DIMM lightly with your fingers when pressing the retaining clips. The DIMM might get damaged when it flips out with extra force.

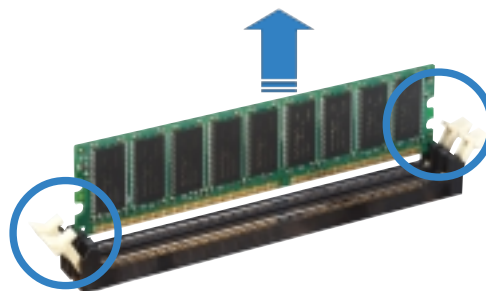

2. Remove the DIMM from the socket.

## 2.5 Expansion slots

In the future, you may need to install expansion cards. The following sub-sections describe the slots and the expansion cards that they support.



---

Make sure to unplug the power cord before adding or removing expansion cards. Failure to do so may cause you physical injury and damage motherboard components.

---

### 2.5.1 Installing an expansion card

To install an expansion card:

1. Before installing the expansion card, read the documentation that came with it and make the necessary hardware settings for the card.
2. Remove the system unit cover (if your motherboard is already installed in a chassis).
3. Remove the bracket opposite the slot that you intend to use. Keep the screw for later use.
4. Align the card connector with the slot and press firmly until the card is completely seated on the slot.
5. Secure the card to the chassis with the screw you removed earlier.
6. Replace the system cover.

### 2.5.2 Configuring an expansion card

After installing the expansion card, configure the it by adjusting the software settings.

1. Turn on the system and change the necessary BIOS settings, if any. See Chapter 4 for information on BIOS setup.
2. Assign an IRQ to the card. Refer to the tables on the next page.
3. Install the software drivers for the expansion card.



---

When using PCI cards on shared slots, ensure that the drivers support “Share IRQ” or that the cards do not need IRQ assignments. Otherwise, conflicts will arise between the two PCI groups, making the system unstable and the card inoperable.

---

## 2.5.3 Interrupt assignments

### Standard interrupt assignments

IRQ	Priority	Standard Function
0	1	System Timer
1	2	Keyboard Controller
2	—	Re-direct to IRQ#9
3	11	Communications Port (COM2)*
4	12	Communications Port (COM1)*
5	13	IRQ holder for PCI steering*
6	14	Floppy Disk Controller
7	15	Printer Port (LPT1)*
8	3	System CMOS/Real Time Clock
9	4	IRQ holder for PCI steering*
10	5	IRQ holder for PCI steering*
11	6	IRQ holder for PCI steering*
12	7	PS/2 Compatible Mouse Port*
13	8	Numeric Data Processor
14	9	Primary IDE Channel
15	10	Secondary IDE Channel

\* These IRQs are usually available for ISA or PCI devices.

### IRQ assignments for this motherboard

	A	B	C	D	E	F	G	H	PX IRQ1	PX IRQ2	PX IRQ3	PX IRQ4
PCI-X1 slot	—	—	—	—	—	—	—	—	shared	shared	shared	shared
PCI-X2 slot	—	—	—	—	—	—	—	—	shared	shared	shared	shared
PCI slot1	—	—	—	—	shared	shared	shared	shared	—	—	—	—
PCI slot2	—	—	—	—	shared	shared	shared	shared	—	—	—	—
PCI slot3	—	—	—	—	shared	shared	shared	shared	—	—	—	—
Onboard USB controller 1	shared	—	—	—	—	—	—	—	—	—	—	—
Onboard USB controller 2	—	—	—	shared	—	—	—	—	—	—	—	—
Onboard USB 2.0 controller	—	—	—	—	—	—	—	shared	—	—	—	—
Onboard SATA controller	—	—	—	—	—	—	—	—	—	shared	—	—
Onboard LAN2	shared	—	—	—	—	—	—	—	—	—	—	—

## 2.5.4 PCI/PCI-X slots

The PCI/PCI-X slots support cards such as a LAN card, SCSI card, USB card, and other cards that comply with PCI 2.3 and PCI-X 1.0 specifications. The figure shows a LAN card installed on a PCI slot.



The **PCI-X1 slot** on SATA models is colored **green**. When installing a Zero-Channel RAID card, it is recommended that you install it on the PCI-X1 slot for optimum compatibility and performance.



## 2.6. Jumpers

### 1. Clear RTC RAM (CLRTC1)

This jumper allows you to clear the Real Time Clock (RTC) RAM in CMOS. You can clear the CMOS memory of date, time, and system setup parameters by erasing the CMOS RTC RAM data. The onboard button cell battery powers the RAM data in CMOS, which include system setup information such as system passwords.

To erase the RTC RAM:

1. Turn OFF the computer and unplug the power cord.
2. Remove the onboard battery.
3. Move the jumper cap from pins 1-2 (default) to pins 2-3. Keep the cap on pins 2-3 for about 5~10 seconds, then move the cap back to pins 1-2.
4. Re-install the battery.
5. Plug the power cord and turn ON the computer.
6. Hold down the <Del> key during the boot process and enter BIOS setup to re-enter data.



Except when clearing the RTC RAM, never remove the cap on CLRTC1 jumper default position. Removing the cap will cause system boot failure!

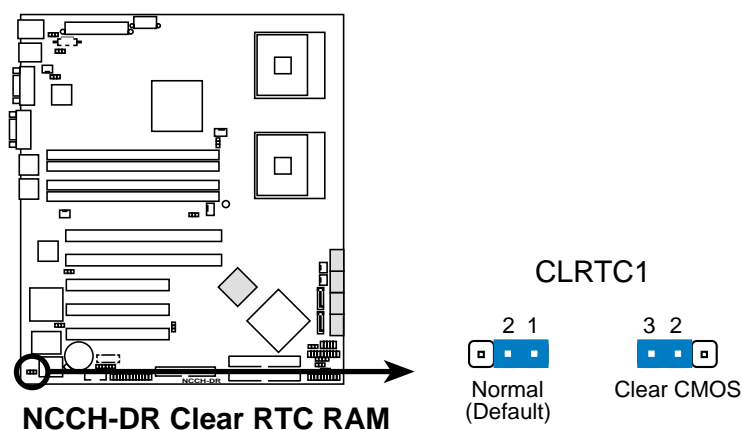

## 2. CPU fan pin selection (3-pin FM\_CPU1, FM\_CPU2)

These jumpers allow you to connect either a 3-pin or a 4-pin CPU fan cable plug to the CPU fan connectors (CPU\_FAN1, CPU\_FAN2). Set these jumpers to pins 1-2 if you are using a 3-pin fan cable plug, or to pins 2-3 if you are using a 4-pin plug.

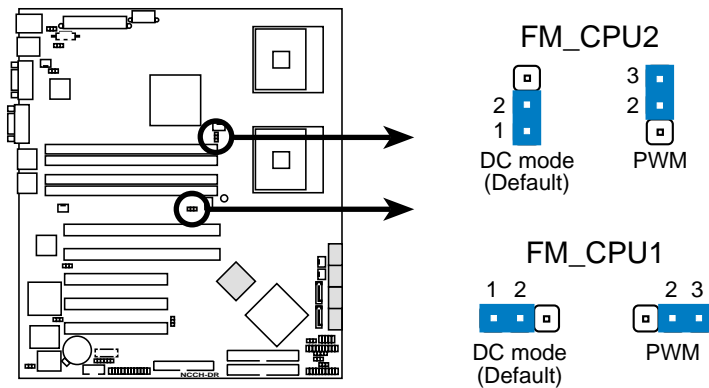

**NCCH-DR FM\_CPU Setting**

## 3. USB device wake-up (3-pin USBPW12, USBPW34)

Set these jumpers to +5V to wake up the computer from S1 sleep mode (CPU stopped, DRAM refreshed, system running in low power mode) using the connected USB devices. Set to +5VSB to wake up from S3 and S4 sleep modes (no power to CPU, DRAM in slow refresh, power supply in reduced power mode).

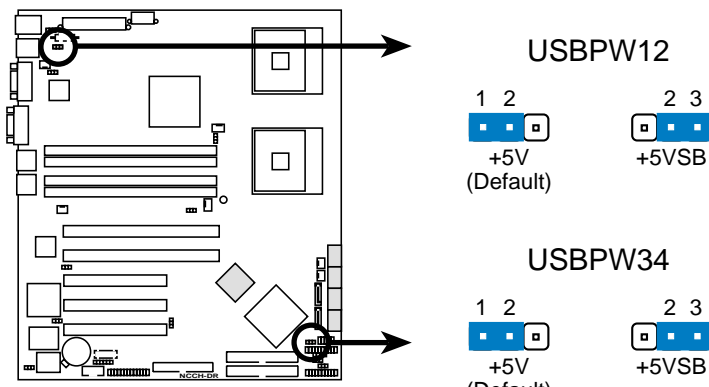

**NCCH-DR USB device wake-up**



- The USB device wake-up feature requires a power supply that can provide 500mA on the +5VSB lead for each USB port; otherwise, the system would not power up.
- The total current consumed must NOT exceed the power supply capability (+5VSB) whether under normal condition or in sleep mode.

#### 4. Keyboard power (3-pin KBPWR1)

This jumper allows you to enable or disable the keyboard wake-up feature. Set this jumper to pins 2-3 (+5VSB) to wake up the computer when you press a key on the keyboard (the default is the Space Bar). This feature requires an ATX power supply that can supply at least 1A on the +5VSB lead, and a corresponding setting in the BIOS.

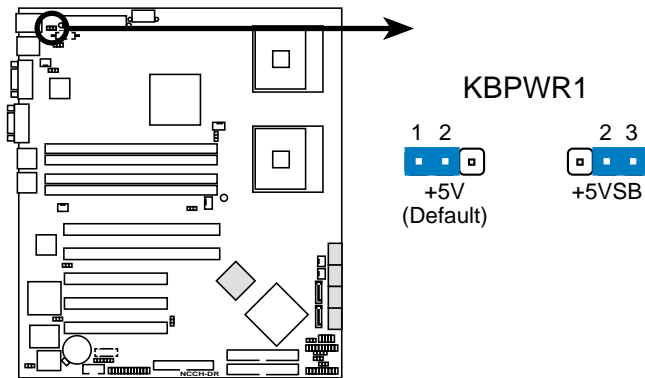

**NCCH-DR Keyboard power setting**

#### 5. SATA controller setting (3-pin SATA\_EN1) *On SATA models only*

These jumpers allow you to enable or disable the onboard Adaptec® AIC-8130 SATA RAID controller. Set to pins 1-2 to activate the SATA controller.

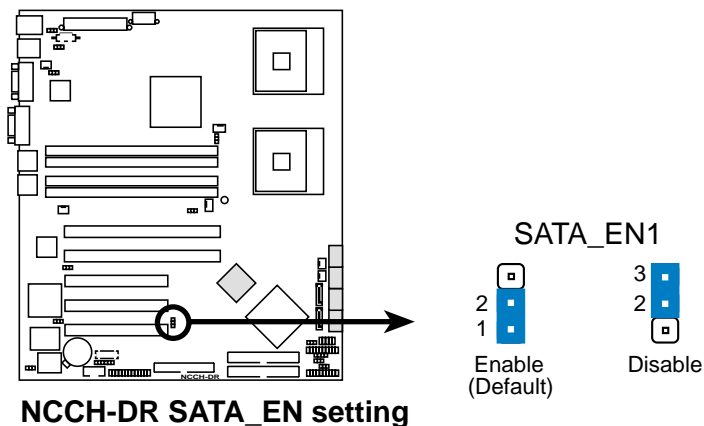

**NCCH-DR SATA\_EN setting**

## 6. SATA controller LED setting (3-pin 8130LED1)

This jumper allows you to enable or disable the SATA controller LED indicator in the chassis front panel.

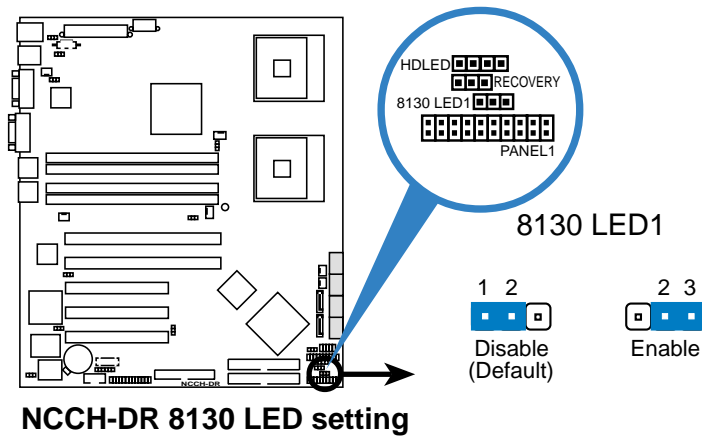

## 7. Gigabit LAN controller setting (3-pin LAN\_EN1; LAN\_EN2)

These jumpers allow you to enable or disable the onboard Gigabit LAN controllers. The LAN\_EN1 jumper is for the Intel® 82547GI Gigabit LAN controller (CSA) that controls the LAN1 port. The LAN\_EN2 jumper is for the Intel® 82541GI Gigabit LAN controller (32-bit) that controls the LAN2 port. Place the jumper caps on pins 1-2 to activate the Gigabit LAN controller.

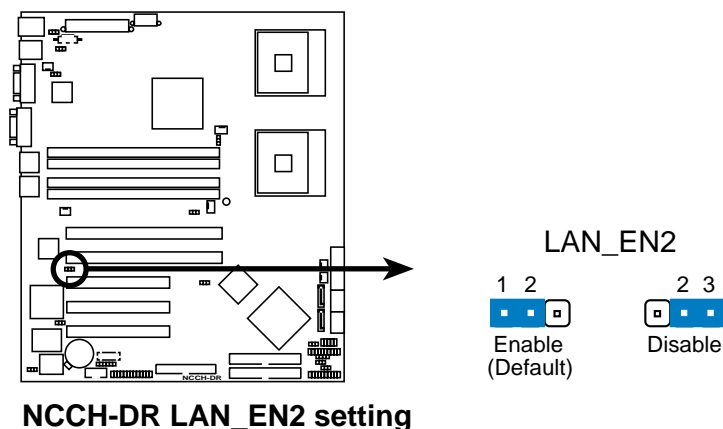
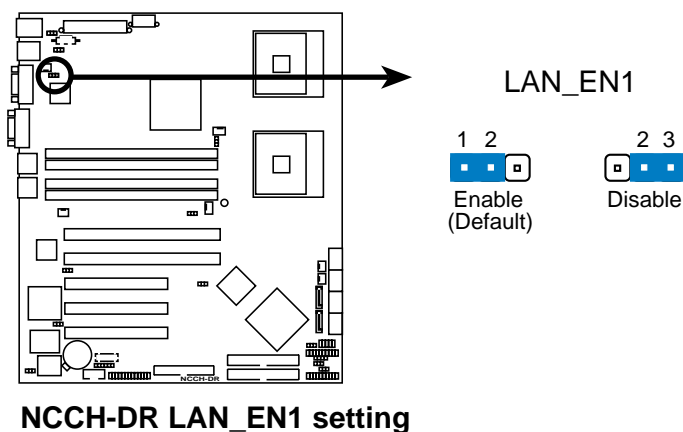

## 8. Integrated graphics controller (3-pin VGA\_EN1)

This jumper allows you enable or disable the onboard graphics controller.

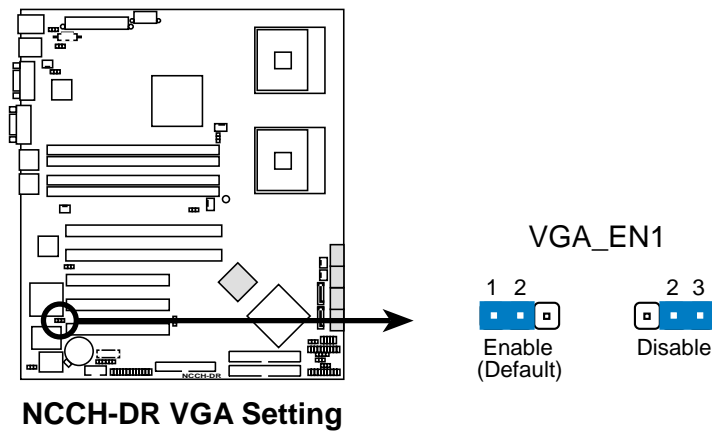

## 9. Force BIOS recovery (3-pin RECOVERY)

This jumper allows you to update or recover the BIOS settings when it gets corrupted or destroyed. This jumper allows you to update/recover the BIOS quickly.

To update the BIOS:

1. Prepare a floppy disk that contains the latest BIOS for the motherboard (xxx-xxx.BIN) and the AWDFLASH.EXE utility.
2. Set the jumper to pins 2-3.
3. Insert the floppy disk, then turn on the system to update the BIOS.
4. Shut down the system.
5. Set the jumper back to pins 1-2.
6. Turn on the system.

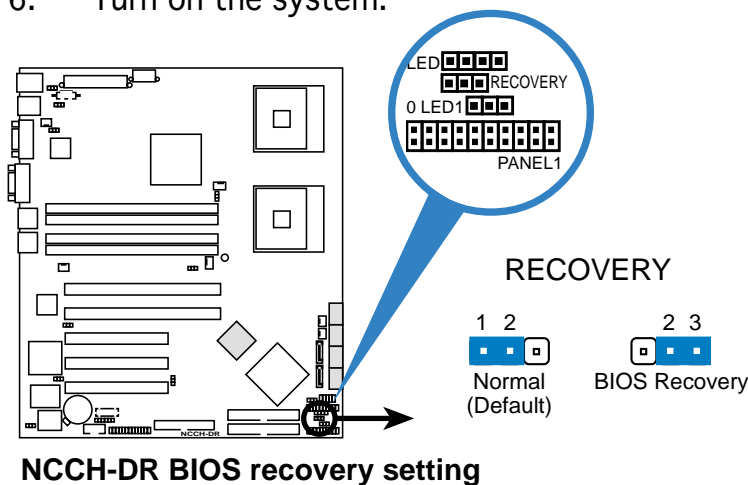

## 2.7 Connectors

### 2.7.1 Rear panel connectors

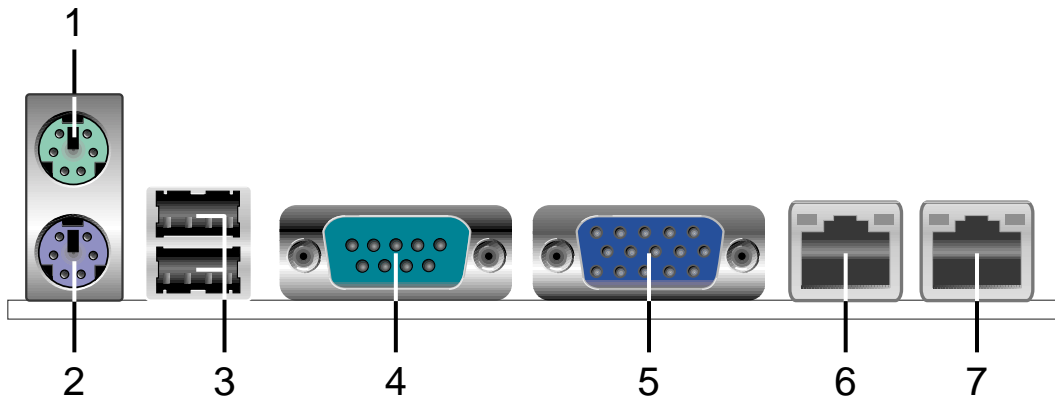

1. **PS/2 mouse port (green).** This port is for a PS/2 mouse.
2. **PS/2 keyboard port (purple).** This port is for a PS/2 keyboard.
3. **USB 2.0 ports 1 and 2.** These two 4-pin Universal Serial Bus (USB) ports are available for connecting USB 2.0 devices.
4. **Serial (COM1) port.** This 9-pin communication port is for pointing devices or other serial devices.
5. **VGA port.** This port is for a VGA monitor.
6. **LAN1 (RJ-45) port.** Controlled by the Intel® 82547GI Gigabit LAN controller (CSA), this port allows Gigabit connection to a Local Area Network (LAN) through a network hub. Refer to the table below for the LAN port LED indications.
7. **LAN2 (RJ-45) port.** Controlled by the Intel® 82541GI Gigabit LAN controller (32-bit), this port allows Gigabit connection to a Local Area Network (LAN) through a network hub. Refer to the table below for the LAN port LED indications.

### LAN port LED indications

ACT/LINK LED		SPEED LED	
Status	Description	Status	Description
OFF	No link	OFF	10 Mbps connection
GREEN	Linked	ORANGE	100 Mbps connection
BLINKING	Data activity	GREEN	1 Gbps connection

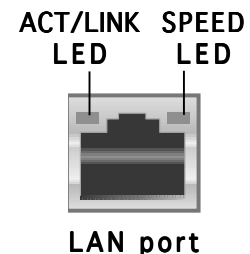

## 2.7.2 Internal connectors

### 1. Floppy disk drive connector (34-1 pin FLOPPY)

This connector is for the provided floppy disk drive (FDD) signal cable. Insert one end of the cable to this connector, then connect the other end to the signal connector at the back of the floppy disk drive.



Pin 5 on the connector is removed to prevent incorrect cable connection when using a FDD cable with a covered Pin 5.

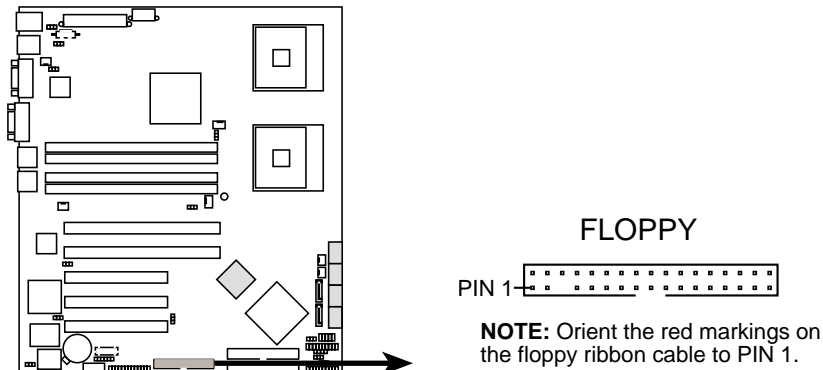

**NCCH-DR Floppy disk drive connector**

### 2. IDE connectors (40-1 pin PRI\_IDE, SEC\_IDE)

These connectors are for Ultra DMA 100/66/33 signal cables. The Ultra DMA 100/66/33 signal cable has three connectors: a blue connector for the primary IDE connector on the motherboard, a black connector for an Ultra DMA 100/66/33 IDE slave device (optical drive/hard disk drive), and a gray connector for an Ultra DMA 100/66/33 IDE master device (hard disk drive). If you install two hard disk drives, you must configure the second drive as a slave device by setting its jumper accordingly. Refer to the hard disk documentation for the jumper settings.



- Pin 20 on the IDE connectors are removed to match the covered hole on the Ultra DMA cable connector. This prevents incorrect insertion when you connect the IDE cable.
- Use the 80-conductor IDE cable for Ultra DMA 100/66/33 IDE devices.

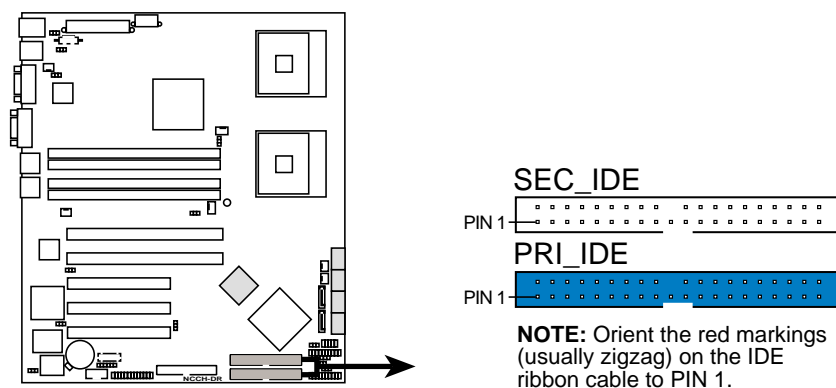

**NCCH-DR IDE connectors**

### 3. Serial ATA connectors (7-pin SATA1, SATA2)

These connectors are for the Serial ATA signal cables for Serial ATA hard disk drives.

If you installed Serial ATA hard disk drives, you can create a RAID 0 or RAID 1 configuration with the Intel® Matrix Storage Technology through the onboard Intel® 6300ESB integrated RAID controller.



These connectors are set to **Standard IDE** mode by default. In **Standard IDE** mode, you can connect Serial ATA boot/data hard disk drives to these connectors. If you intend to create a Serial ATA RAID set using these connectors, set the **SATA Mode** item in the BIOS to [RAID]. See page 4-27 and 4-28 for details.

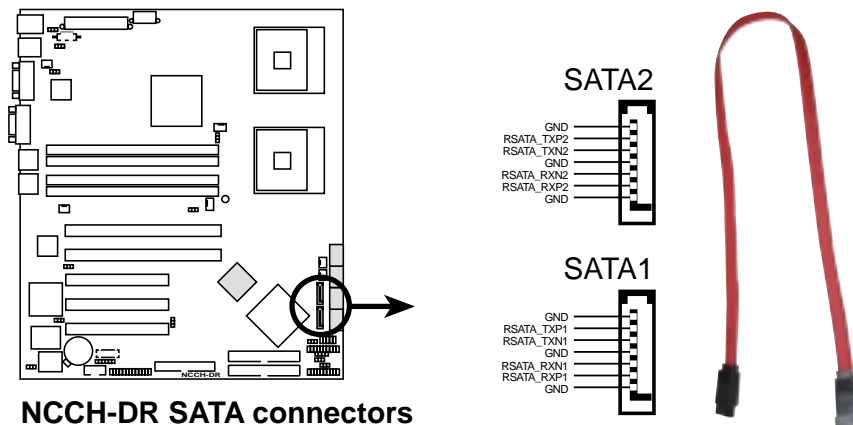

NCH-DR SATA connectors



#### Important notes on Serial ATA

- You must install Windows® 2000 Service Pack 4 or the Windows® XP Service Pack 1 before using Serial ATA hard disk drives. The Serial ATA RAID feature (RAID 0/RAID 1) is available only if you are using Windows® 2000/XP.
- Use only two Serial ATA RAID connectors for each RAID 0 or RAID 1 set.
- When using the connectors in **IDE** mode, connect the primary (boot) hard disk drive to the SATA1 or SATA2 connector. Refer to the table below for the recommended SATA hard disk drive connections.

#### Serial ATA hard disk drive connection

Connector	Setting	Use
SATA1	Master	Boot disk
SATA2	Slave	Data disk



**4. Serial ATA RAID connectors (7-pin SATA\_RAID1, SATA\_RAID2, SATA\_RAID3, SATA\_RAID4) *On SATA models only***

These connectors are for Serial ATA signal cables. These connectors support up to four Serial ATA hard disk drives that you can configure as a disk array through the Adaptec AIC-8130 SATA RAID controller.

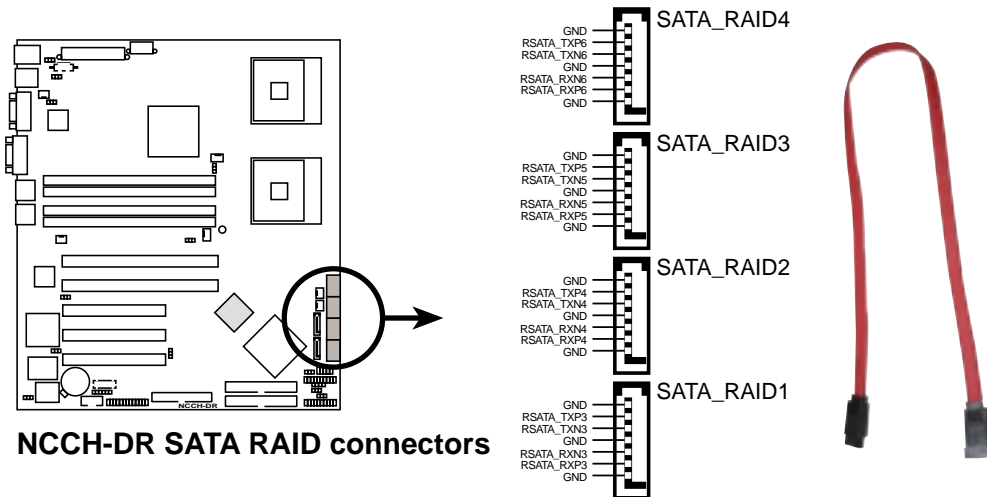

**NCCH-DR SATA RAID connectors**



Before creating a RAID set using Serial ATA hard disks, make sure that you have connected the Serial ATA signal cable and installed Serial ATA hard disk drives; otherwise, you cannot enter the RAID utility and SATA BIOS setup during POST.

**5. Hard disk activity LED connector (4-pin HDLED1)**

For some storage cards, such as SCSI card, with access signals for external LEDs, this connector allows the access signals to go through the front panel IDE\_LED lead.

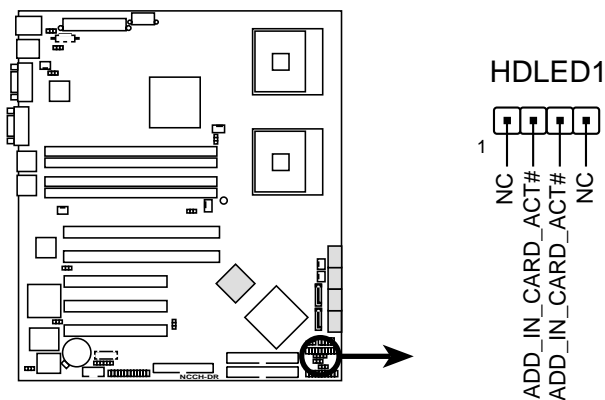

**NCCH-DR SCSI/SATA card activity LED connector**





## 9. Serial port connector (10-1 pin COM2)

This connector is for a serial (COM) port. Connect the serial port module cable to this connector, then install the module to a slot opening at the back of the system chassis.

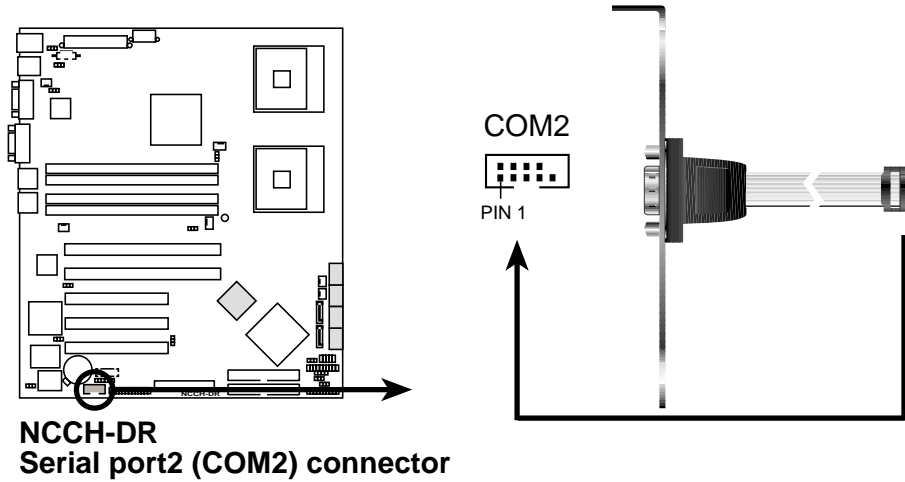

---

The serial port module is purchased separately.

---

## 10. Printer port connector (26-1 pin LPT1)

This connector is for a parallel printer port. Connect the parallel printer port module cable to this connector, then install the module to a slot opening at the back of the system chassis.

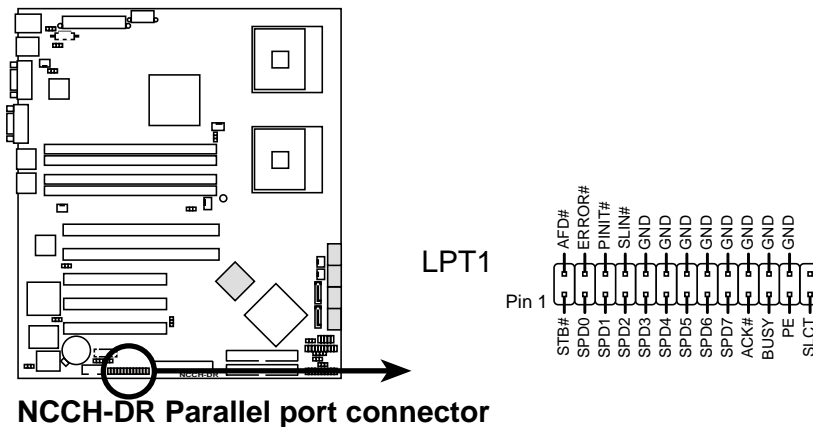

## 11. Backplane SMBus connector (6-1 pin BPSMB1)

This connector allows you to connect SMBus (System Management Bus) devices. Devices communicate with an SMBus host and/or other SMBus devices using the SMBus interface.

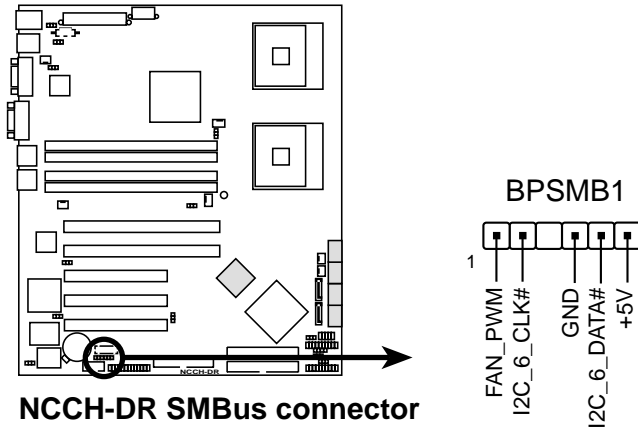

## 12. Power supply SMBus connector (5-pin PSUSMB1)

This connects SMBus (System Management Bus) devices to the power supply unit. Devices communicate with an SMBus host and/or other SMBus devices using the SMBus interface.

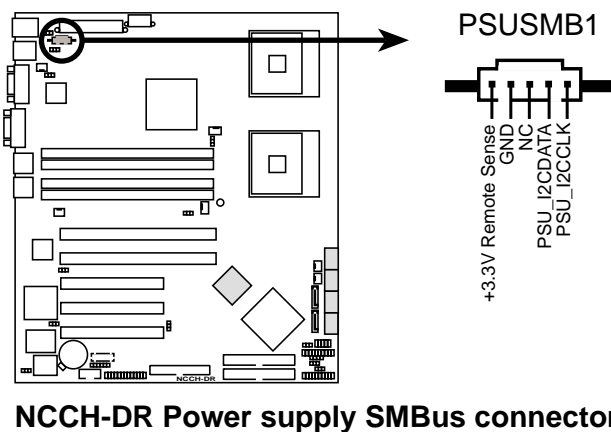

### 13. BMC connector (16-pin BMCCONN1)

This connector is for the optional ASUS server management card.

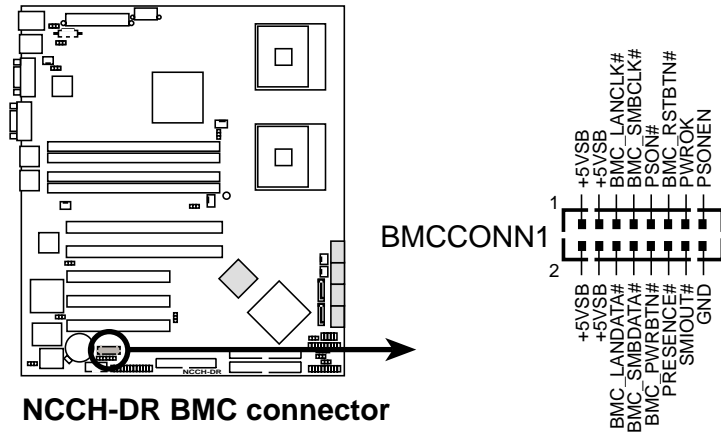

### 14. Auxilliary panel connector (20-2 pin AUX\_PANEL1)

This connector supports several front panel chassis-mounted functions including chassis intrusion, LAN1/LAN2 link and activity LEDs, Locator LED1/2, Locator switch, and front panel System Management bus (SMBus).

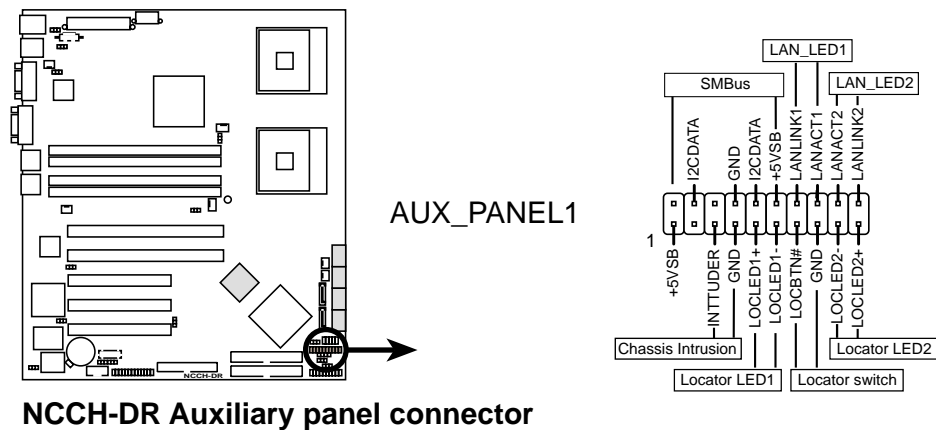

## 15. System panel connector (20-pin PANEL1)

This connector supports several chassis-mounted functions.

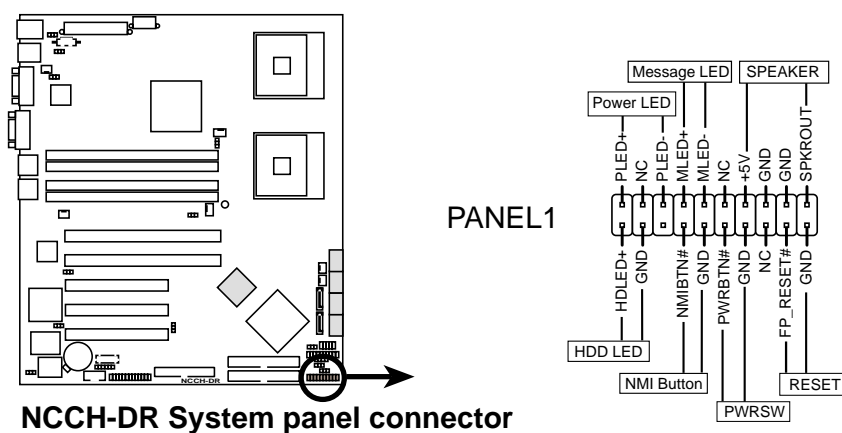

The system panel connector is color-coded for easy connection. Refer to the connector descriptions on the next page for details.

- **System power LED (Green 3-pin PLED)**  
This 3-pin connector is for the system power LED. Connect the chassis power LED cable to this connector. The system power LED lights up when you turn on the system power, and blinks when the system is in sleep mode.
- **Message LED (Brown 2-pin MLED)**  
This connector is for the message LED cable that connects to the front panel message LED. The message LED indicates the booting status. The LED blinks when the system is in the boot process until the operating system is loaded.
- **System warning speaker (Orange 4-pin SPEAKER)**  
This 4-pin connector is for the chassis-mounted system warning speaker. The speaker allows you to hear system beeps and warnings.
- **Hard disk drive activity LED (Red 2-pin HDD LED)**  
This 2-pin connector is for the HDD Activity LED. Connect the HDD Activity LED cable to this connector. The IDE LED lights up or flashes when data is read from or written to the HDD.
- **ATX power button/soft-off button (Yellow 2-pin PWRSW)**  
This connector is for the system power button. Pressing the power button turns the system on or puts the system in sleep or soft-off mode depending on the BIOS settings. Pressing the power switch for more than four seconds while the system is ON turns the system OFF.
- **Reset button (Blue 2-pin RESET)**  
This 2-pin connector is for the chassis-mounted reset button for system reboot without turning off the system power.





This chapter describes the power up sequence, the vocal POST messages, and ways of shutting down the system.

# Powering up

## Chapter summary

# 3

3.1	Starting up for the first time .....	3-1
3.2	Powering off the computer .....	3-2

## 3.1 Starting up for the first time

1. After making all the connections, replace the system case cover.
2. Be sure that all switches are off.
3. Connect the power cord to the power connector at the back of the system chassis.
4. Connect the power cord to a power outlet that is equipped with a surge protector.
5. Turn on the devices in the following order:
  - a. Monitor
  - b. External SCSI devices (starting with the last device on the chain)
  - c. System power
6. After applying power, the system power LED on the system front panel case lights up. For systems with ATX power supplies, the system LED lights up when you press the ATX power button. If your monitor complies with “green” standards or if it has a “power standby” feature, the monitor LED may light up or switch between orange and green after the system LED turns on.

The system then runs the power-on self tests or POST. While the tests are running, the BIOS beeps (see BIOS beep codes table below) or additional messages appear on the screen. If you do not see anything within 30 seconds from the time you turned on the power, the system may have failed a power-on test. Check the jumper settings and connections or call your retailer for assistance.

### Award BIOS beep codes

Beep Description	Error
One short beep when displaying logo	No error during POST
Long beeps in an endless loop	No DRAM installed or detected
High frequency beeps when system is working	CPU overheated; System running at a lower frequency

7. At power on, hold down the <Delete> key to enter the BIOS Setup. Follow the instructions in Chapter 4.

## 3.2 Powering off the computer

### 3.2.1 Using the OS shut down function

If you are using Windows® 2000:

1. Click the **Start** button then click **Shut Down...**
2. Make sure that the **Shut Down** option button is selected, then click the **OK** button to shut down the computer.
3. The power supply should turn off after Windows® shuts down.

If you are using Windows® XP:

1. Click the **Start** button then select **Turn Off Computer.**
2. Click the **Turn Off** button to shut down the computer.
3. The power supply should turn off after Windows® shuts down.

### 3.2.2 Using the dual function power switch

While the system is ON, pressing the power switch for less than four seconds puts the system to sleep mode or to soft-off mode, depending on the BIOS setting. Pressing the power switch for more than four seconds lets the system enter the soft-off mode regardless of the BIOS setting. Refer to section “4.5 Power Menu” in Chapter 4 for details.

This chapter tells how to change the system settings through the BIOS Setup menus. Detailed descriptions of the BIOS parameters are also provided.

# BIOS setup



4.1	Managing and updating your BIOS .....	4-1
4.2	BIOS Setup program .....	4-13
4.3	Main menu .....	4-16
4.4	Advanced menu .....	4-20
4.5	Power menu .....	4-32
4.6	Boot menu .....	4-38
4.7	Exit menu .....	4-44

## 4.1 Managing and updating your BIOS

The following utilities allow you to manage and update the motherboard Basic Input/Output System (BIOS) setup.

1. **Award BIOS** Flash Utility (Updates the BIOS in DOS mode using a floppy disk.)
2. **ASUS CrashFree BIOS 2** (Updates the BIOS using a bootable floppy disk or the motherboard support CD when the BIOS file fails or gets corrupted.)
3. **ASUS EZ Flash** (Updates the BIOS in DOS mode using a floppy disk or the motherboard support CD.)
4. **ASUS Update** (Updates the BIOS in Windows® environment.)

Refer to the corresponding sections for details on these utilities.



---

Save a copy of the original motherboard BIOS file to a bootable floppy disk in case you need to restore the BIOS in the future. Copy the original motherboard BIOS using the ASUS Update or Award BIOS Flash utilities.

---

### 4.1.1 Creating a bootable floppy disk

1. Do either one of the following to create a bootable floppy disk.

#### DOS environment

- a. Insert a 1.44MB floppy disk into the drive.
- b. At the DOS prompt, type **format A:/S** then press <Enter>.

#### Windows® XP environment

- a. Insert a 1.44 MB floppy disk to the floppy disk drive.
- b. Click **Start** from the Windows® desktop, then select **My Computer**.
- c. Select the 3 1/2 Floppy Drive icon.
- d. Click **File** from the menu, then select **Format**. A **Format 3 1/2 Floppy Disk** window appears.
- e. **Windows® XP users:** Select **Create an MS-DOS startup disk** from the format options field, then click **Start**.

### Windows® 2000 environment

To create a set of boot disks for Windows® 2000:

- a. Insert a formatted, high density 1.44 MB floppy disk into the drive.
  - b. Insert the Windows® 2000 CD to the optical drive.
  - c. Click **Start**, then select **Run**.
  - d. In the **Open** field, type `D:\bootdisk\makeboot a:` assuming that D is your optical drive letter.
  - e. Press <Enter>, then follow screen instructions to continue.
2. Copy the original or the latest motherboard BIOS file to the bootable floppy disk.



## 4.1.2 AwardBIOS Flash Utility

The Basic Input/Output System (BIOS) can be updated using the AwardBIOS Flash Utility. The following sections tell you how to update the BIOS or how to save the current BIOS file.

### Updating the current BIOS file

To update the current BIOS file:

1. Download the latest BIOS file from the ASUS web site. Extract the zipped file, then save it to a floppy disk as **\*.BIN**.



---

Save only the updated BIOS file in the floppy disk to avoid loading the wrong BIOS file.

---

2. Copy the AwardBIOS Flash Utility (awdfash.exe) from the Software folder of the support CD to the floppy disk with the latest BIOS file.
3. Boot the system in DOS mode using the bootable floppy disk you created earlier.
4. When the A:> appears, replace the bootable floppy disk with the floppy disk containing the new BIOS file and the Award BIOS Flash Utility.
5. At the prompt, type awdfash then press <Enter>. The Award BIOS Flash Utility screen appears.

```
AwardBIOS Flash Utility for ASUS V1.05
(C) Phoenix Technologies Ltd. All Rights Reserved
For Canterwood - NCCH-DRC-00      DATE: 07/14/2004
Flash Type - SST 49LF008A /3.3V
File Name to Program : 

Message: Please input File Name!
```

6. Type the BIOS file name in the File Name to Program field, then press <Enter>.

```
AwardBIOS Flash Utility for ASUS V1.05
(C) Phoenix Technologies Ltd. All Rights Reserved
For Canterwood - NCCH-DRC-00      DATE: 07/14/2004
Flash Type - SST 49LF008A /3.3V
File Name to Program : 1001.bin
Message: Do You Want To Save BIOS (Y/N)
```

7. The utility prompts you to save the current BIOS file. Press <Y> to save the current BIOS file to the floppy disk, or <N> to continue.



If you intend to save the current BIOS file, make sure that the floppy disk has enough disk space to save the file. See the next section for details on saving the current BIOS file.

8. The utility verifies the BIOS file in the floppy disk and starts flashing the BIOS file.



Do not turn off or reset the system during the flashing process!

```
AwardBIOS Flash Utility for ASUS V1.05
(C) Phoenix Technologies Ltd. All Rights Reserved
For Canterwood - NCCH-DRC-00      DATE: 07/14/2004
Flash Type - SST 49LF008A /3.3V
File Name to Program : 1001.bin
Program Flashing Memory - 0FE00 OK
Write OK           No Update           Write Fail
Warning: Don't Turn Off Power Or Reset System!
```

9. After the flashing process is completed, press <F1> to restart your computer.

## Copying the current BIOS file

You can use the AwardBIOS Flash Utility to save the current BIOS file. You can load the current BIOS file when the BIOS file gets corrupted during the flashing process.

To save the current BIOS file using the AwardBIOS Flash Utility:

1. Follow steps 1 to 6 of the previous section.
2. Press <Y> when the utility prompts you to save the current BIOS file. The following screen appears.

```
AwardBIOS Flash Utility for ASUS V1.05
(C) Phoenix Technologies Ltd. All Rights Reserved
For Canterwood - NCCH-DRC-00      DATE: 07/14/2004
Flash Type - SST 49LF008A /3.3V
File Name to Program : 1001.bin
Save current BIOS as :
Message:
```

3. Type a filename for the current BIOS file in the Save current BIOS as field, then press <Enter>.

```
AwardBIOS Flash Utility for ASUS V1.05
(C) Phoenix Technologies Ltd. All Rights Reserved
For Canterwood - NCCH-DRC-00      DATE: 07/14/2004
Flash Type - SST 49LF008A /3.3V
File Name to Program : 1001.bin
Checksum : 0E00
Save current BIOS as : old.bin
Message: Please Wait!
```

4. The utility saves the current BIOS file to the floppy disk, then returns to the BIOS flashing process.

```
AwardBIOS Flash Utility for ASUS V1.05
(C) Phoenix Technologies Ltd. All Rights Reserved
For Canterwood - NCCH-DRC-00      DATE: 07/14/2004
Flash Type - SST 49LF008A /3.3V
File Name to Program : 1001.bin
Now Backup System BIOS to
File!
Message: Please Wait!
```

### 4.1.3 ASUS CrashFree BIOS 2 utility

The ASUS CrashFree BIOS 2 is an auto recovery tool that allows you to restore the BIOS file when it fails or gets corrupted during the updating process. You can update a corrupted BIOS file using the motherboard support CD or the floppy disk that contains the updated BIOS file.



---

Prepare the motherboard support CD or the floppy disk containing the updated motherboard BIOS before using this utility.

---

### Recovering the BIOS from a floppy disk

To recover the BIOS from a floppy disk:

1. Turn on the system.
2. Insert the floppy disk with the AwardBIOS Flash Utility (awdf flash.exe) and the original or updated BIOS file to the floppy disk drive.
3. The utility displays the following message and automatically checks the floppy disk for the original or updated BIOS file.

```
Bad BIOS checksum. Starting BIOS recovery...  
Checking for floppy...
```

When found, the utility reads the BIOS file and automatically opens the AwardBIOS Flash Utility.

```
Bad BIOS checksum. Starting BIOS recovery...  
Checking for floppy...  
Floppy found!
```



---

DO NOT shut down or reset the system while updating the BIOS! Doing so can cause system boot failure!

---

4. Update the BIOS file following the instructions on the section “Award BIOS Flash Utility”.

## Recovering the BIOS from the support CD

To recover the BIOS from the support CD:

1. Remove any floppy disk from the floppy disk drive, then turn on the system.
2. Insert the support CD to the optical drive.
3. The utility displays the following message and automatically checks the floppy disk for the original or updated BIOS file.

```
Bad BIOS checksum. Starting BIOS recovery...  
Checking for floppy...
```

When no floppy disk is found, the utility automatically checks the optical drive for the original or updated BIOS file. After finding the updated BIOS file, the utility opens the AwardBIOS Flash Utility.

```
Bad BIOS checksum. Starting BIOS recovery...  
Checking for floppy...  
Floppy not found!  
Checking for CD-ROM...  
CD-ROM found!
```



---

DO NOT shut down or reset the system while updating the BIOS! Doing so can cause system boot failure!

---

4. Update the BIOS file following the instructions on the section “Award BIOS Flash Utility”.



---

The recovered BIOS may not be the latest BIOS version for this motherboard. Visit the ASUS website ([www.asus.com](http://www.asus.com)) to download the latest BIOS file.

---

## 4.1.4 ASUS EZ Flash utility

The ASUS EZ Flash feature allows you to update the BIOS without having to go through the long process of booting from a floppy disk and using a DOS-based utility. The EZ Flash utility is built-in the BIOS chip so it is accessible by pressing <Alt> + <F2> during the Power-On Self Tests (POST).

To update the BIOS using EZ Flash:

1. Visit the ASUS website ([www.asus.com](http://www.asus.com)) to download the latest BIOS file for the motherboard.
2. Save the BIOS file to a floppy disk, then restart the system.
3. Press <Alt> + <F2> during POST to display the following.

```
EZFlash starting BIOS update
Checking for floppy...
```

4. Insert the floppy disk that contains the BIOS file to the floppy disk drive. When the correct BIOS file is found, EZ Flash opens the AwardBIOS Flash Utility.

```
EZFlash starting BIOS update
Checking for floppy...
Floppy found!
```

5. Update the BIOS file following the instructions on the section “Award BIOS Flash Utility”.



- Do not shutdown or reset the system while updating the BIOS to prevent system boot failure!
- A “Floppy not found!” error message appears if there is no floppy disk in the drive. An error message also appears if the correct BIOS file is not found in the floppy disk.s

## 4.1.5 ASUS Update utility

The ASUS Update is a utility that allows you to manage, save, and update the motherboard BIOS in Windows® environment. The ASUS Update utility allows you to:

- Save the current BIOS file
- Download the latest BIOS file from the Internet
- Update the BIOS from an updated BIOS file
- Update the BIOS directly from the Internet, and
- View the BIOS version information.

This utility is available in the support CD that comes with the motherboard package.



---

ASUS Update requires an Internet connection either through a network or an Internet Service Provider (ISP).

---

## Installing ASUS Update

To install ASUS Update:

1. Place the support CD in the optical drive. The **Drivers** menu appears.
2. Click the **Utilities** tab, then click **Install ASUS Update VX.XX.XX**.
3. The ASUS Update utility is copied to your system.



---

Quit all Windows® applications before you update the BIOS using this utility.

---



## Updating the BIOS through the Internet

To update the BIOS through the Internet:

1. Launch the ASUS Update utility from the Windows® desktop by clicking **Start > Programs > ASUS > ASUSUpdate > ASUSUpdate**. The ASUS Update main window appears.

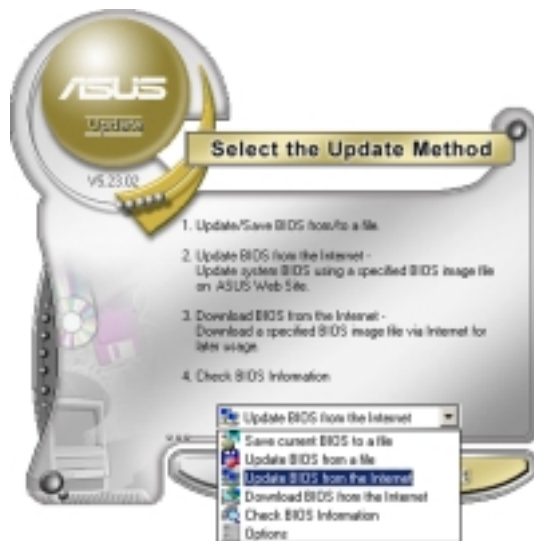
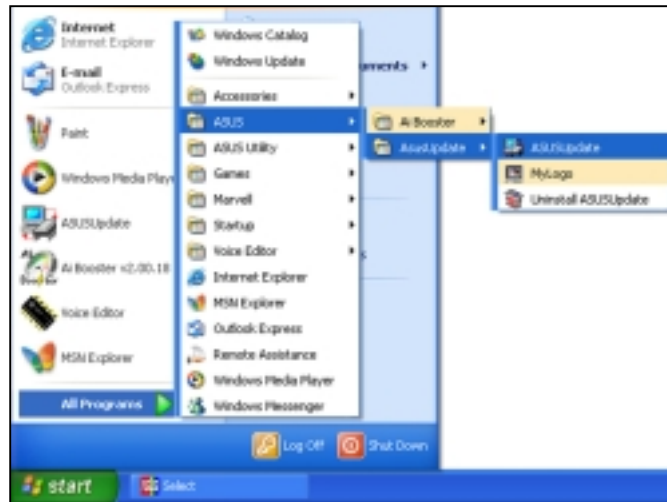

2. Select **Update BIOS from the Internet** option from the drop-down menu, then click **Next**.



3. Select the ASUS FTP site nearest you to avoid network traffic, or click **Auto Select**. Click **Next**.

- From the FTP site, select the BIOS version that you wish to download. Click Next.
- Follow the screen instructions to complete the update process.



The ASUS Update utility is capable of updating itself through the Internet. Always update the utility to avail all its features.



## Updating the BIOS through a BIOS file

To update the BIOS through a BIOS file:

- Launch the ASUS Update utility from the Windows® desktop by clicking **Start > Programs > ASUS > ASUSUpdate > ASUSUpdate**. The ASUS Update main window appears.
- Select **Update BIOS from a file** option from the drop-down menu, then click **Next**.



- Locate the BIOS file from the **Open** window, then click **Save**.
- Follow the screen instructions to complete the update process.

## 4.2 BIOS Setup program

This motherboard includes a Flash ROM that you can update using the provided utility described in section “4.1 Managing and updating your BIOS.”

Use the BIOS Setup program when you are installing a motherboard, reconfiguring your system, or prompted to “Run Setup”. This section explains how to configure your system using this utility.

Even if you are not prompted to use the Setup program, you may want to change the configuration of your computer in the future. For example, you may want to enable the security password feature or make changes to the power management settings. This requires you to reconfigure your system using the BIOS Setup program so that the computer can recognize these changes and record them in the CMOS RAM of the Flash ROM.

The Flash ROM on the motherboard stores the Setup utility. When you start up the computer, the system provides you with the opportunity to run this program. Press <Delete> during the Power-On Self Test (POST) to enter the Setup utility, otherwise, POST continues with its test routines.

If you wish to enter Setup after POST, restart the system by pressing <Ctrl> + <Alt> + <Delete>, or by pressing the reset button on the system chassis. You can also restart by turning the system off and then back on. Do this last option only if the first two failed.

The Setup program is designed to make it as easy to use as possible. It is a menu-driven program, which means you can scroll through the various sub-menus and make your selections among the predetermined choices.



---

Because the BIOS software is constantly being updated, the following BIOS setup screens and descriptions are for reference purposes only, and may not exactly match what you see on your screen.

---

## 4.2.1 BIOS menu screen

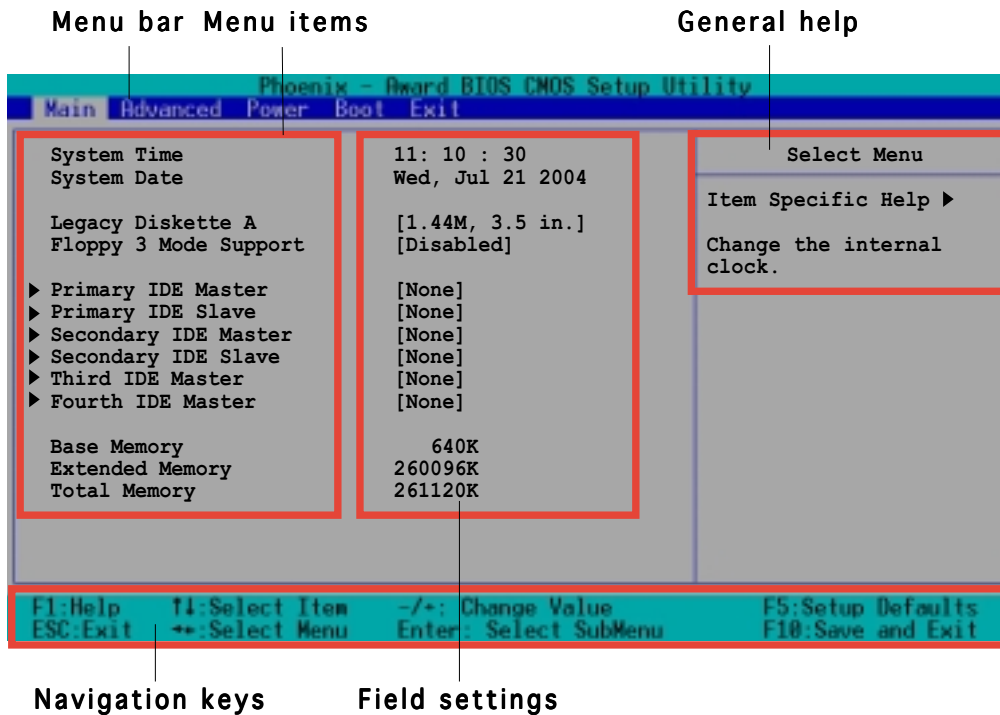

## 4.2.2 Menu bar

The menu bar on top of the screen has the following main items:

- Main** For changing the basic system configuration settings
- Advanced** For changing the advanced system settings
- Power** For changing the power configuration settings
- Boot** For changing the system boot configuration settings
- Exit** For selecting the exit options and loading default settings

To select the menu bar items, press the right or left arrow key on the keyboard until the desired item is highlighted.

## 4.2.3 Navigation keys

At the **bottom** of a menu screen are the navigation keys for that particular menu. Use the navigation keys to select items in the menu and change the settings.



The navigation keys differ from one screen to another.

#### **4.2.4 General help**

On the right side of the menu screen is a brief description of the selected item.

#### **4.2.5 Sub-menu**

An item with a sub-menu on any menu screen is distinguished by a solid triangle before the item. To display the sub-menu, select the item and press <Enter>.

#### **4.2.6 Scroll bar**

A scroll bar appears on the right side of a menu screen when there are items that do not fit on the screen. Press **Up/Down arrow keys** or **PageUp/PageDown keys** to display the other items on the screen.

#### **4.2.7 Pop-up window**

Select an item in the menu, then press <Enter> to display a pop-up window with the configuration options for that item.

## 4.3 Main menu

When you enter the BIOS Setup program, the Main menu screen appears giving you an overview of the basic system information.



Refer to section “4.2.1 BIOS menu screen” for information on the menu screen items and how to navigate through them.

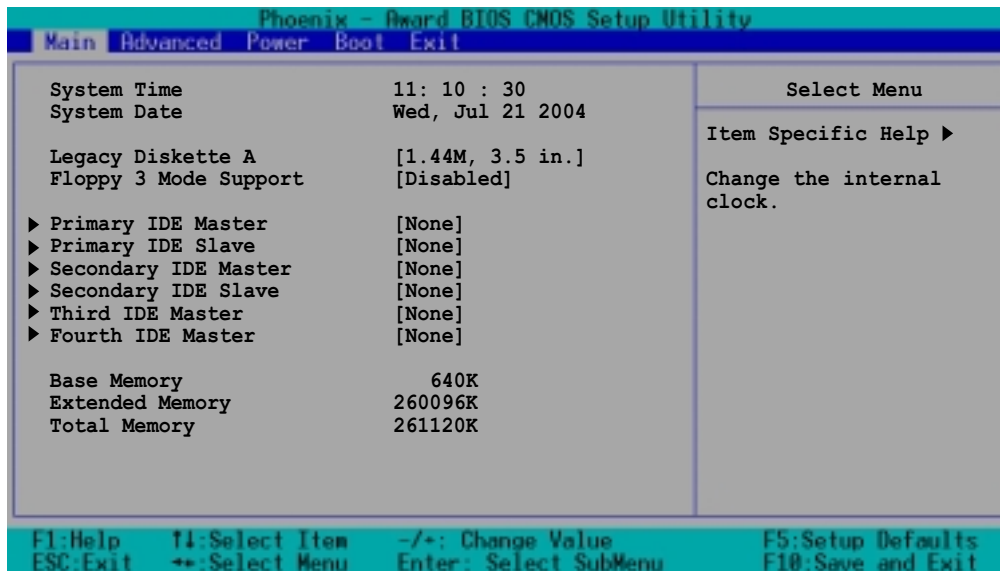

### System Time (hh:mm:ss)

Sets the system to the time that you specify (usually the current time). The format is hour:minute:second. Valid values for hour, minute, and second are Hour: (00 to 23), Minute: (00 to 59), Second: (00 to 59). Use the <Tab> key to move between the hour, minute, and second fields.

### System Date (mm:dd:yy)

Sets the system to the date that you specify (usually the current date). The format is month:day:year. Valid values for month, day, and year are Month: (1 to 12), Day: (1 to 31), Year: (1999 to 2099). Use the <Tab> key to move between the month, day, and year fields.

### Legacy Diskette A [1.44M, 3.5 in.]

Sets the type of floppy drive installed. Configuration options: [Disabled] [360K, 5.25 in.] [1.2M, 5.25 in.] [720K, 3.5 in.] [1.44M, 3.5 in.] [2.88M, 3.5 in.]

### Floppy 3 Mode Support [Disabled]

Enables support for older Japanese floppy drives. The Floppy 3 Mode feature allows reading and writing of 1.28 MB (as opposed to 1.44 MB) on a 3.5-inch floppy disk. Configuration options: [Disabled] [Drive A]

### Base/Extended/Total Memory [xxxK]

The base memory, extended memory, and total memory values are auto-detected. These fields are not user-configurable.

## 4.3.1 Primary IDE Master

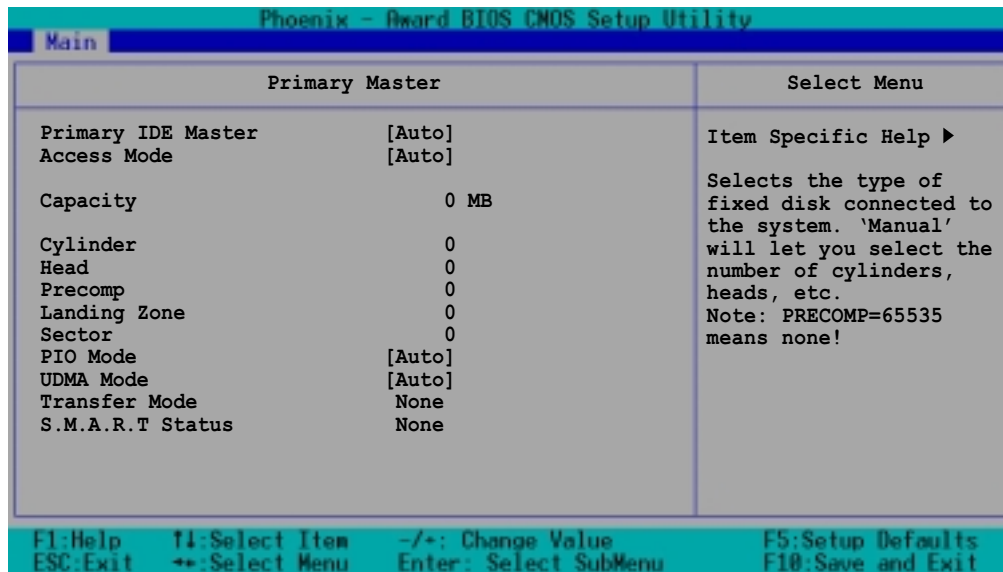

### Primary IDE Master [Auto]

Select [Auto] to automatically detect an IDE drive. If automatic detection is successful, the setup BIOS automatically fills in the correct values for the remaining fields on this sub-menu.

If automatic detection fails, this may be because the IDE drive is too old or too new. If the drive was already formatted on a previous system, the BIOS may detect incorrect parameters. In these cases, select [Manual] to manually enter the IDE drive parameters. Refer to the section “Manually detecting an IDE drive.”

If no drive is installed or if you are removing a drive and not replacing it, select [None]. Configuration options: [None] [Auto] [Manual]



---

The IDE drive information items are grayed out when this item is set to [Auto].

---

### Access Mode [Auto]

Allows selection of the sector addressing mode. The default [Auto] allows automatic detection of an IDE drive. Set this item to [CHS] if the **Primary IDE Master** item is set to [Manual] so you can manually enter the drive values. Configuration options: [CHS] [LBA] [Large] [Auto]

### PIO Mode [Auto]

Sets the PIO mode for the IDE drive. The settings Mode 0 to 4 allow successive increase in performance. Configuration options: [Auto] [Mode 0] [Mode 1] [Mode 2] [Mode 3] [Mode 4]

## UDMA Mode [Auto]

When this item is set to [Auto], the UDMA capability allows improved transfer speeds and data integrity for supported IDE drives. Configuration options: [Disabled] [Auto]

### *Manually detecting an IDE drive*

If you wish to manually enter the drive information, set the Primary IDE Master item to [Manual], and the Access Mode item to [CHS].

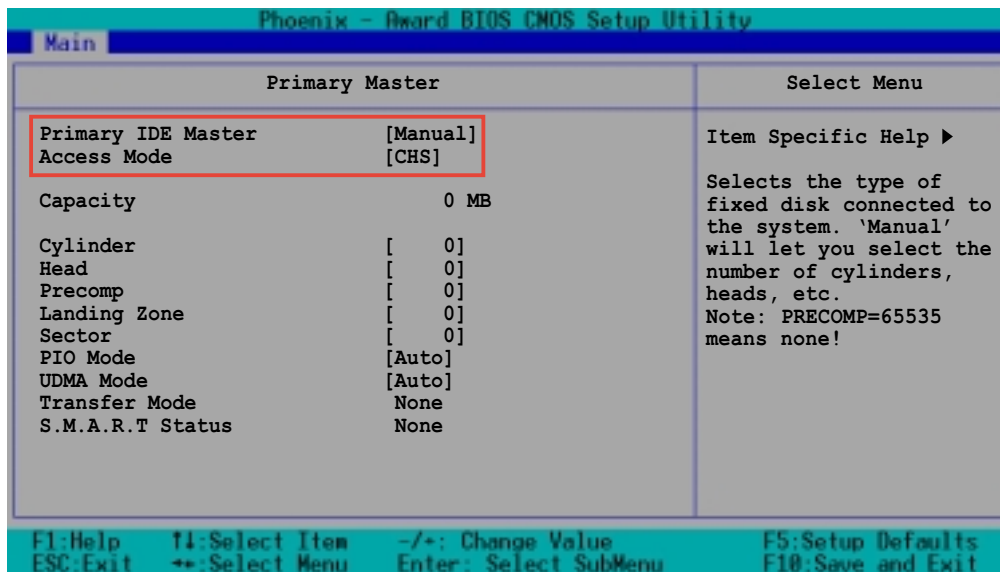

Before attempting to manually configure an IDE drive, make sure that you have the correct configuration information supplied by the drive manufacturer. Incorrect settings may cause the system to fail to recognize the installed IDE drive!

To manually enter the number of cylinder, head, precomp, landing zone, and sector per track for the drive, highlight an item, key-in the value that you obtained from the drive documentation, then press <Enter>. Refer to the drive documentation or the drive label for this information.

To enter a value, you may also highlight the item, then press <Enter> to display a pop-up menu. Type in the value from the drive documentation, then press <Enter>.

## Capacity [xxxxx MB]

Displays the auto-detected hard disk capacity. The value is not user-configurable.

## Cylinder

Shows the number of the hard disk cylinders.



## Head

Shows the number of the hard disk read/write heads.

## Precomp

Displays the precompressed volumes on the hard disk, if any, on the motherboard.

## Landing Zone

Displays the drive's maximum usable capacity as calculated by the BIOS based on the drive information you entered.

## Sector

Shows the number of sectors per track.

## Transfer Mode

Shows the data transfer mode if the IDE hard disk drive supports the feature. Otherwise, this item is grayed out and shows the value [None].

## S.M.A.R.T. Status

Shows the Smart Monitoring, Analysis, and Reporting Technology (S.M.A.R.T.) status if the IDE hard disk drive supports the feature. Otherwise, this item is grayed out and shows the value [None].



---

After entering the IDE hard disk drive information, use a disk utility, such as FDISK, to partition and format new IDE drives. This is necessary so that you can write or read data from the hard disk. Make sure to set the partition of the Primary IDE hard disk drive to "Active."

---

### 4.3.2 Primary IDE Slave

When configuring a drive as Primary IDE Slave, refer to section "4.3.1 Primary IDE Master" for the menu item descriptions.

### 4.3.3 Secondary IDE Master

When configuring a drive as Secondary IDE Master, refer to section "4.3.1 Primary IDE Master" for the menu item descriptions.

### 4.3.4 Secondary IDE Slave

When configuring a drive as Secondary IDE Slave, refer to section "4.3.1 Primary IDE Master" for the menu item descriptions.

## 4.4 Advanced menu

The Advanced menu items allow you to change the settings for the CPU, memory, chipset, and other system devices.



Take caution when changing the settings of the Advanced menu items. Incorrect field values may cause the system to malfunction!

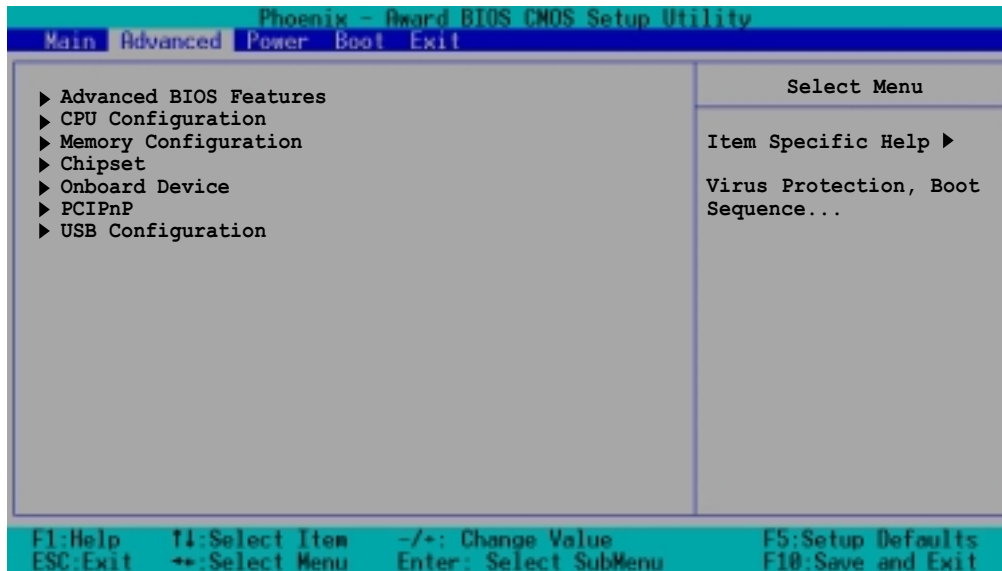

## 4.4.1 Advanced BIOS Features

This menu shows the console redirection and agent information. Select an item then press <Enter> to display a pop-up menu with the configuration options.

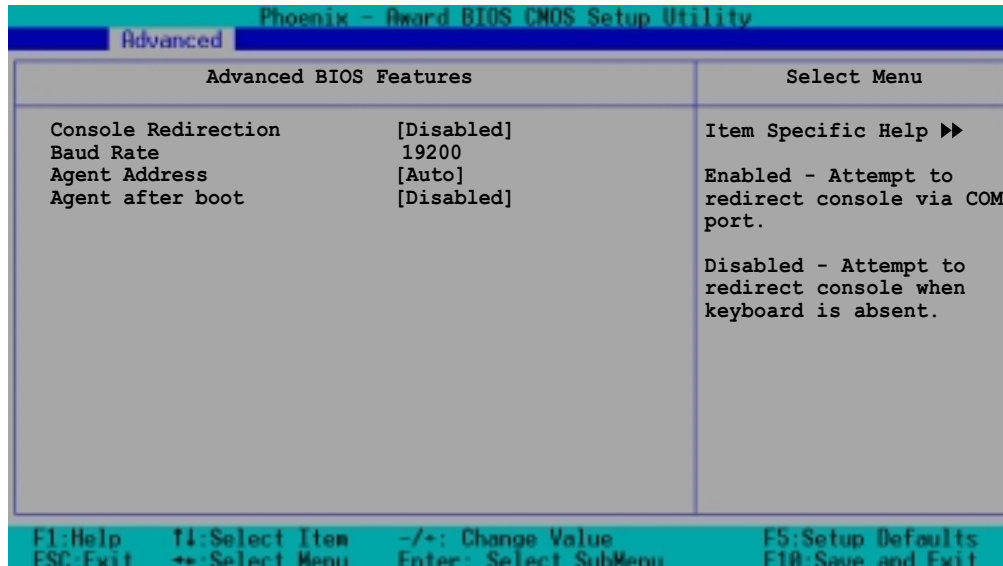

### Console Redirection [Disabled]

Allows you to redirect the console through the serial port. when set to [Enabled], the **Baud Rate** option is activated.  
Configuration options: [Disabled] [Enabled]

### Baud Rate [19200]

Allows you to set the console redirection Baud rate. This item is user-configurable only when the **Console Redirection** option is set to [Enabled]. Configuration options: [9600] [19200] [38400] [57600] [115200]

### Agent Address [Auto]

This option allows you to select the agent address.  
Configuration options: [3F8h] [2F8h] [3E8h] [2E8h] [Auto]

### Agent after boot [Disabled]

This option allows you to enable or disable the agent after boot-up.  
Configuration options: [Disabled] [Enabled]

## 4.4.2 CPU Configuration

This menu shows the CPU configuration settings. Select an item then press <Enter> to display a pop-up menu with the configuration options.

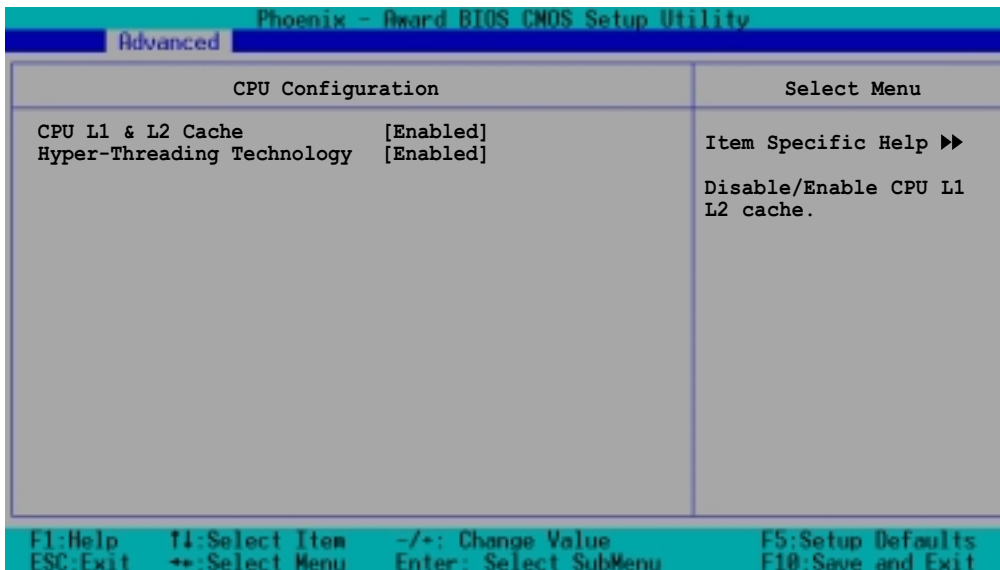

### CPU L1 & L2 Cache [Enabled]

Allows you to enable or disable the CPU L1 and L2 cache.

Configuration options: [Disabled] [Enabled]

### Hyper-Threading Technology [Enabled]

Allows you to enable or disable the Hyper-Threading Technology.

Configuration options: [Disabled] [Enabled]

### 4.4.3 Memory Configuration

This menu shows the memory configuration settings. Select an item then press <Enter> to display a pop-up menu with the configuration options.

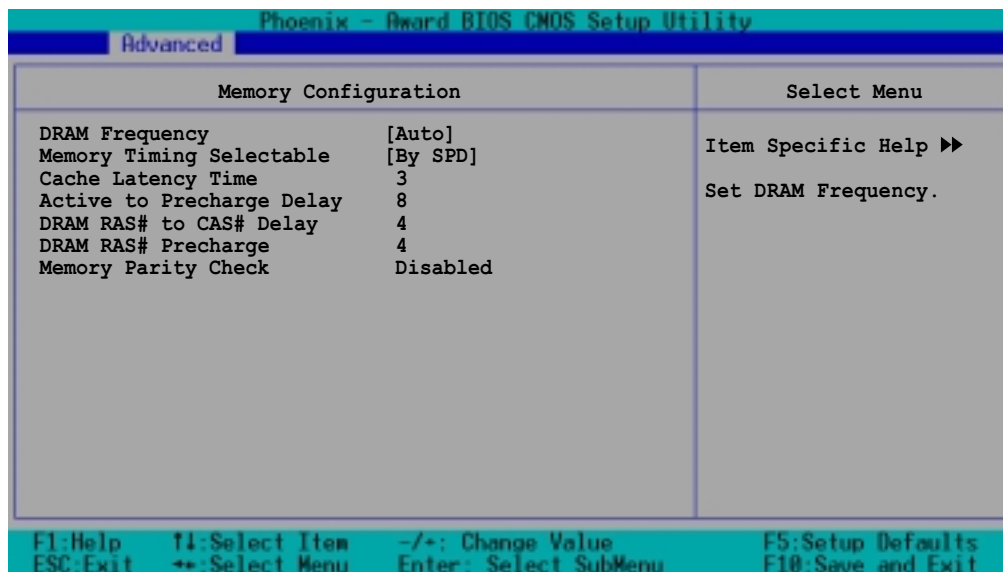

#### DRAM Frequency [Auto]

This item sets the DRAM operating frequency.

Configuration options: [DDR266] [DDR320] [DDR400] [Auto]

#### Memory Timing Selectable [By SPD]

The DRAM clock are set according to the DRAM SPD (Serial Presence Detect). Select [By SPD] for automatic DRAM clock detection. Select [Manual] to allow setting the succeeding memory items to optimal timings.

Configuration options: [Manual] [By SPD]



The items CAS Latency Time, Active to Precharge Delay, DRAM RAS# to CAS# Delay, and DRAM RAS# Precharge are configurable only when the Memory Timing Selectable item is set to [Manual].

#### CAS Latency Time [2.5]

This item sets the latency (in clocks) between the DRAM read command and the time the data actually becomes available.

Configuration options: [2] [2.5] [3]

#### Active to Precharge Delay [7]

This item controls the number of DRAM clocks used for DRAM parameters.

Configuration options: [8] [7] [6] [5]

#### DRAM RAS# to CAS# Delay [3]

Controls the latency between the DRAM active command and the read/write command. Configuration options: [4] [3] [2]

## DRAM RAS# Precharge [3]

This item controls the idle clocks after issuing a precharge command to the DDR SDRAM. Configuration options: [4] [3] [2]

## Memory Parity Check [Enabled]

Allows memory parity checking option. This item is not user-configurable and set to [Enabled] by default.

### 4.4.4 Chipset

This menu shows the chipset configuration settings. Select an item then press <Enter> to display a sub-menu with additional items, or show a pop-up menu with the configuration options.

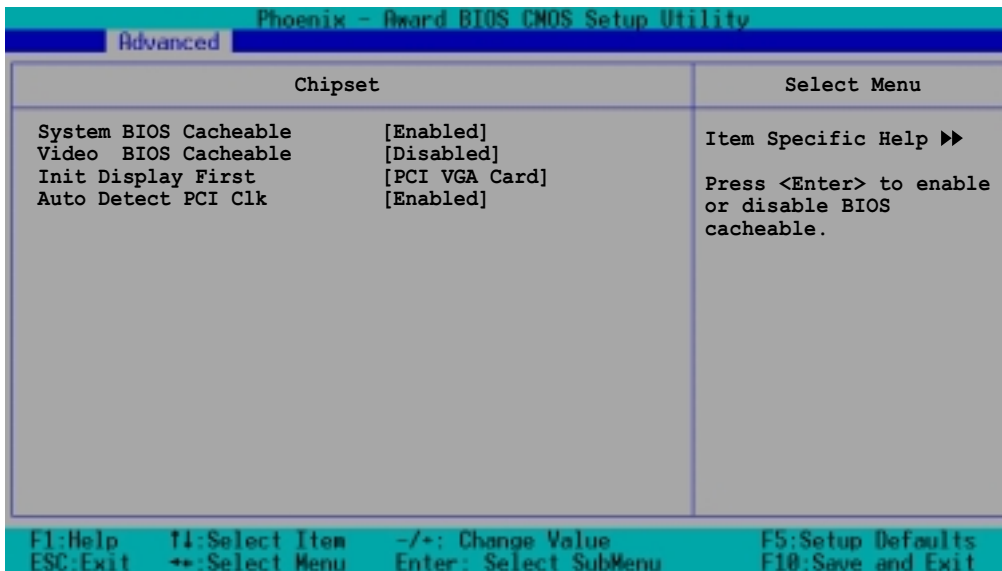

## System BIOS Cacheable [Enabled]

Allows you to enable or disable the cache function of the system BIOS. Configuration options: [Disabled] [Enabled]

## Video BIOS Cacheable [Disabled]

Allows you to enable or disable the cache function of the video BIOS. Setting to [Enabled] improves the display speed by caching the display data. Configuration options: [Disabled] [Enabled]

## Init Display First [PCI VGA Card]

Allows you to select the graphics controller to use as primary boot device. Configuration options: [PCI VGA Card] [Onboard VGA]

## Auto Detect PCI Clk [Enabled]

Allows you to select the maximum PCI bus speed to be programmed. Configuration options: [Enabled] [Disabled]

## 4.4.5 Onboard Device

This menu shows the onboard device configuration settings. Select an item then press <Enter> to display a sub-menu with additional items, or show a pop-up menu with the configuration options.

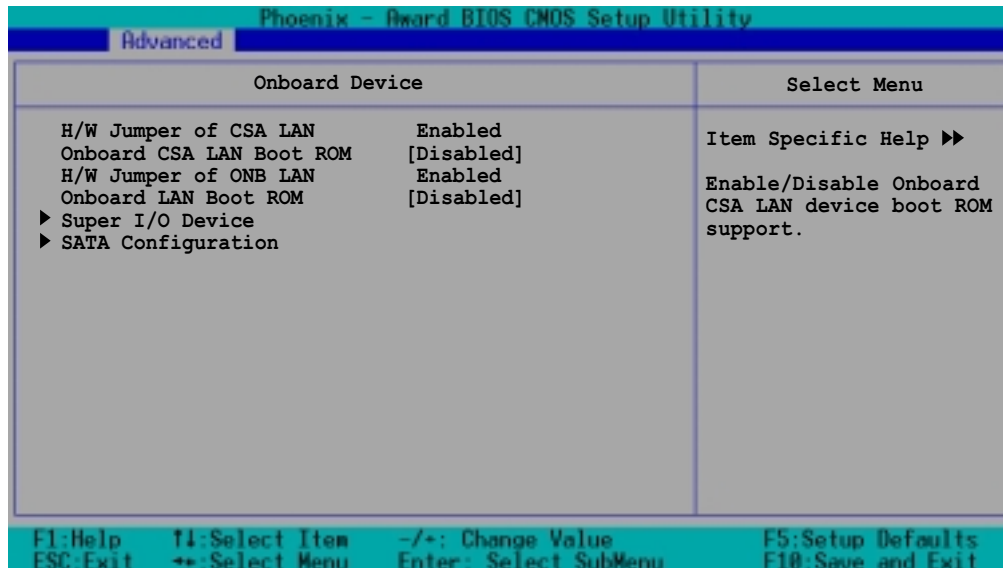

### H/W Jumper of CSA LAN [Enabled]

This option tells whether the CSA LAN jumper labeled LAN\_EN1 on the motherboard is enabled or disabled. See section “2.6 Jumpers” for details.

### Onboard CSA LAN Boot ROM [Disabled]

Allows you to enable or disable the onboard CSA LAN boot ROM.  
Configuration options: [Disabled] [Enabled]

### H/W Jumper of ONB LAN [Enabled]

This option tells whether the onboard LAN jumper labeled LAN\_EN2 on the motherboard is enabled or disabled. See section “2.6 Jumpers” for details.

### Onboard LAN Boot ROM [Disabled]

Allows you to enable or disable the onboard LAN boot ROM.  
Configuration options: [Disabled] [Enabled]

## Super I/O Device

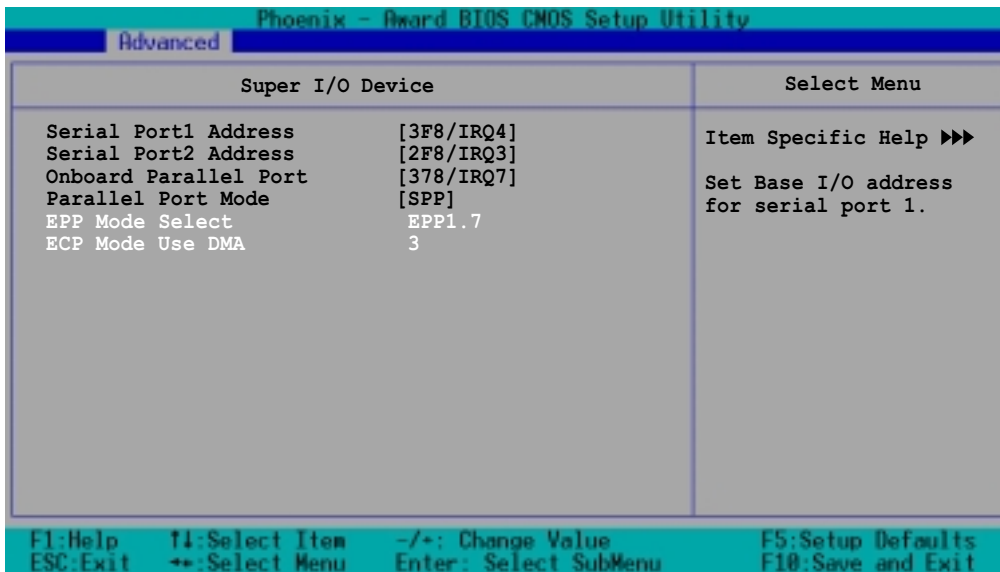

### **Serial Port 1 [3F8/IRQ4]**

### **Serial Port 2 [2F8/IRQ3]**

Allow you to select the serial port base addresses.

Configuration options: [Disabled] [3F8/IRQ4] [2F8/IRQ3] [3E8/IRQ4] [2E8/IRQ3] [Auto]

### **Onboard Parallel Port [378/IRQ7]**

Allows you to select the parallel port base address.

Configuration options: [Disabled] [378/IRQ7] [278/IRQ5] [3BC/IRQ7]

### **Parallel Port Mode [SPP]**

Allows you to select the parallel port mode.

Configuration options: [SPP] [EPP] [ECP] [ECP+EPP] [Normal]

### **EPP Mode Select [EPP1.7]**

Allows you to select the EPP mode. This item becomes configurable only if the **Parallel Port Mode** is set to [EPP] or [ECP+EPP].

Configuration options: [EPP 1.9] [EPP 1.7]

### **ECP Mode Use DMA [3]**

Allows you to select the ECP mode. This item becomes configurable only if the **Parallel Port Mode** is set to [ECP] or [ECP+EPP].

Configuration options: [1] [3]



## SATA Configuration

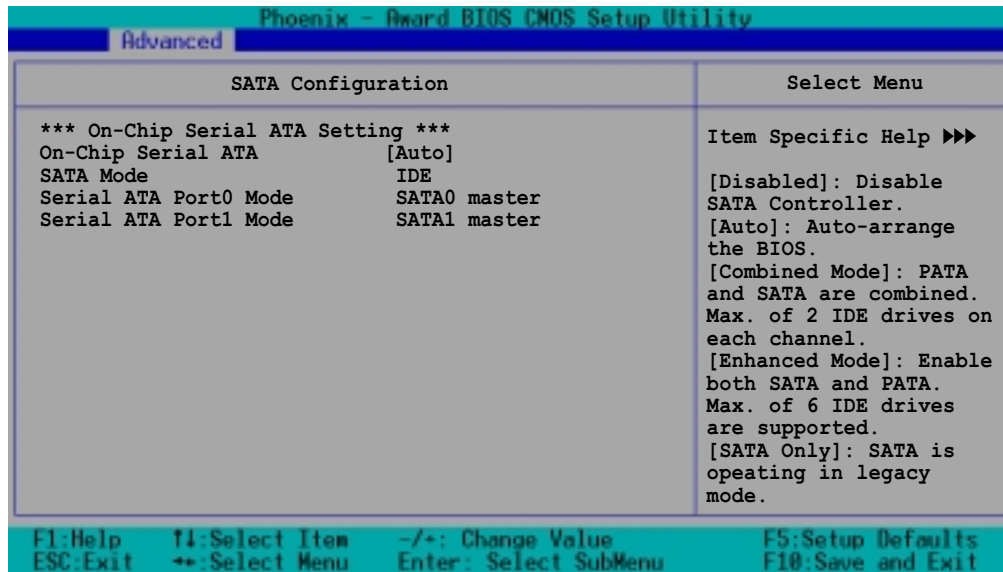

### \*\*\*On-Chip Serial ATA Setting\*\*\*



The SATA Mode and Serial ATA Port0 Mode items are configurable only when the On-Chip Serial ATA item is set to [ Combined Mode] [Enhanced Mode] or [SATA Only].

### On-chip Serial ATA [Auto]

This item allows you to configure your serial ATA devices, if present.  
Configuration options: [Disabled] [Auto] [Combined Mode]  
[Enhanced Mode] [SATA Only]

- Setting to **[Auto]** allows BIOS to automatically configure the SATA devices.
- Setting to **[Combined Mode]** allows you to install parallel ATA and serial ATA devices at the same time. You may install **two IDE devices on any of the parallel ATA channels**, and **one IDE device on each serial ATA channel** for a maximum of **four** devices. Use this option when you installed a legacy operating system like MS-DOS, Windows ME/98/NT4.0.
- Setting to **[Enhanced Mode]** allows you to install parallel ATA and serial ATA devices at the same time, with a maximum of **six** IDE devices on each channel. Use this option when you installed a native operating system like Windows 2000/XP.
- Setting to **[SATA Only]** allows you to install IDE devices on the Serial ATA channels only.
- Setting to **[Disabled]** disables the onboard SATA controller. The RAID feature is also disabled.

## **SATA Mode [IDE]**

When set to [RAID], this item allows configuration of the installed IDE devices into a disk array. Configuration options: [IDE] [RAID]

## **Serial ATA Port0 Mode [SATA0 master]**

## **Serial ATA Port1 Mode [SATA1 master]**

Allow you to set the SATA Port0 and Serial ATA Port1 modes. The options for these items vary depending on the setting of the **On-Chip Serial ATA** item. Configuration options: [Primary Master] [Primary Slave] [Secondary Master] [Secondary Slave] [SATA0 master] [SATA1 master]

## 4.4.6 PCIPnP

This menu shows the PCIPnP configuration settings. Select an item then press <Enter> to display a pop-up menu with the configuration options.

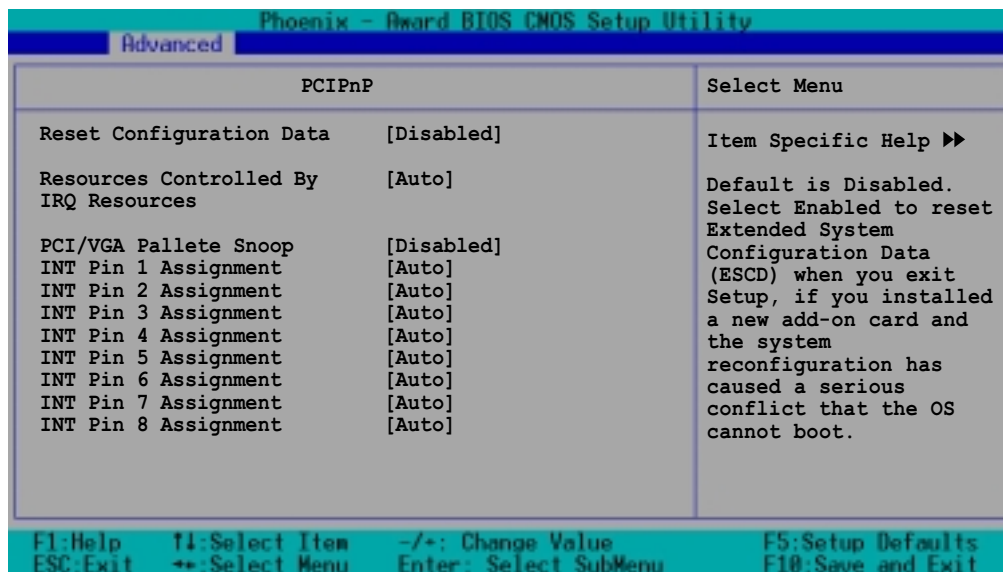

### Reset Configuration Data [Disabled]

Allows you to enable or disabled resetting of the Extended System Configuration Data (ESCD) when you exit the Setup. The ESCD includes information on non-PnP devices. Set this item to [Enabled] if you installed an expansion card that conflicts with other devices and cause system boot failure. Configuration options: [Disabled] [Enabled]

### Resources Controlled By [Auto]

When set to [Auto(ESCD)], allows BIOS to automatically configure of all boot and Plug and Play devices. When set to [Manual], you can assign the available IRQ Resources to the PCI devices. Configuration options: [Auto] [Manual]



When the item **Resources Controlled By** is set to [Auto], the item IRQ Resources is grayed out and not user-configurable. Refer to the section "IRQ Resources" for information on how to enable this item.

### PCI/VGA Pallete Snoop [Disabled]

Some non-standard VGA cards, like graphics accelerators or MPEG video cards, may not show colors properly. Setting this field to [Enabled] corrects this problem. If you are using a standard VGA card, leave this field to the default setting [Disabled]. Configuration options: [Disabled] [Enabled]

### INT Pin 1~8 Assignment [Auto]

Allows you to select the appropriate interrupt to the specific devices to avoid conflict. Configuration options: [Auto] [3] [4] [5] [7] [9] [10] [11] [12] [14] [15]

## IRQ Resources



Set the item **Resources Controlled By** is set to [Manual] to enable the item **IRQ Resources** and assign the interrupts depending on the type of installed PCI device.

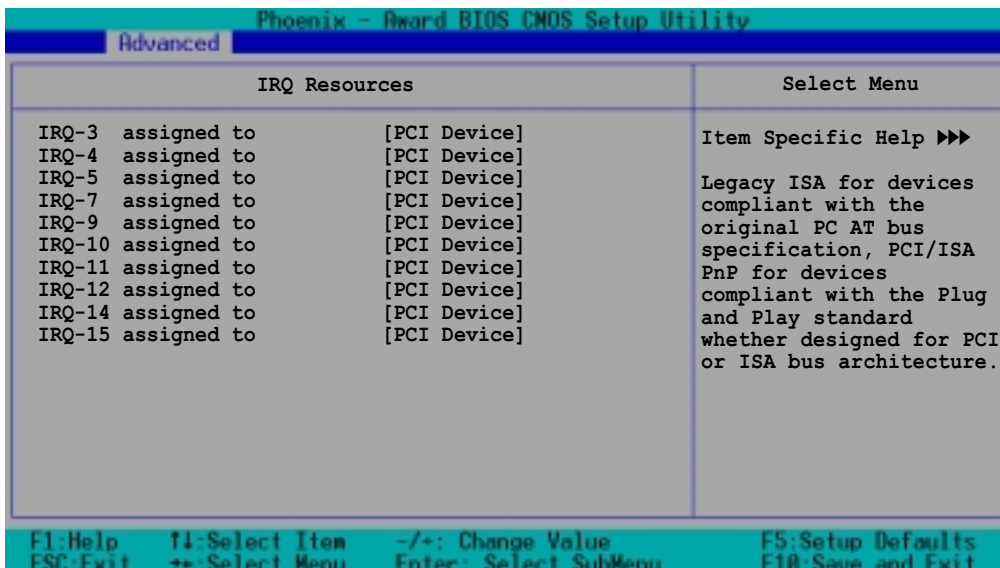
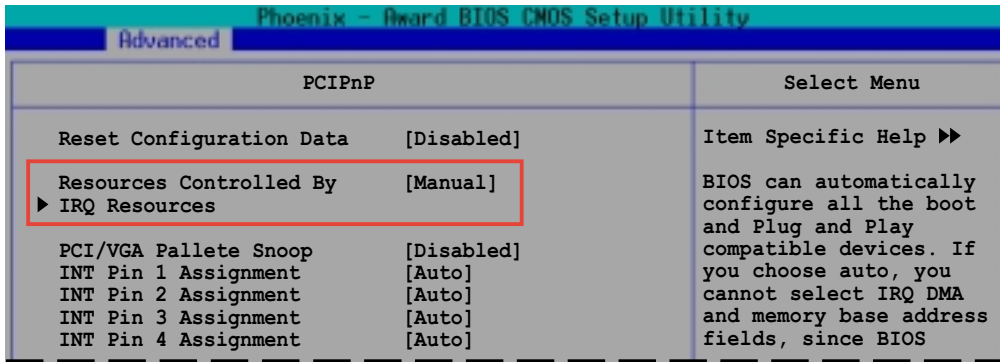

### **IRQ-xx assigned to [PCI device]**

The IRQ Resources sub-menu is activated when the Resources Controlled by parameter is set to [Manual]. Select [PCI Device] to assign an IRQ address to a Plug and Play device. Setting to [Reserved] reserves the IRQ address. Configuration options: [PCI Device] [Reserved]

## 4.4.7 USB Configuration

This menu shows the USB configuration settings. Select an item then press <Enter> to display a pop-up menu with the configuration options.

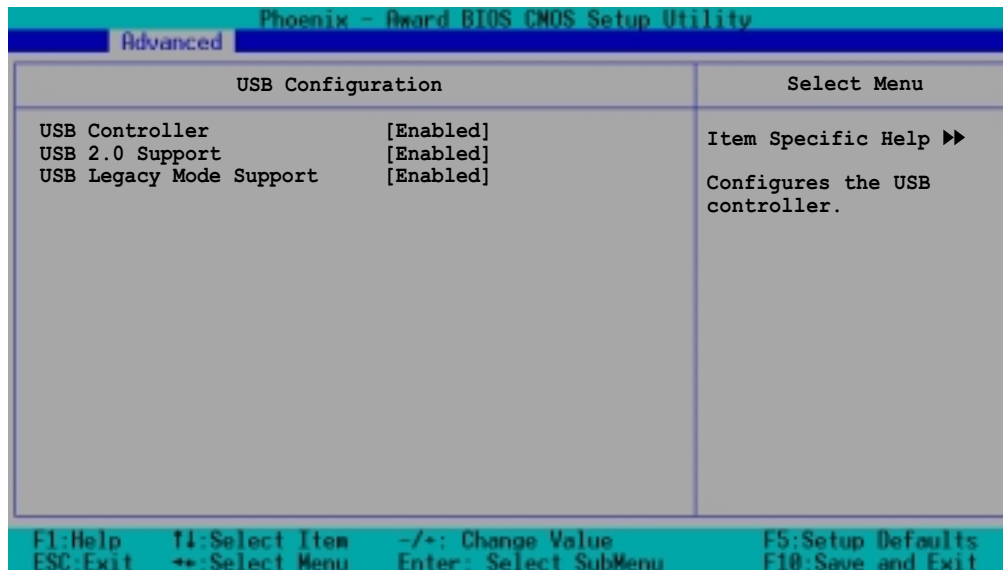

### USB Controller [Enabled]

Allows you enable or disable the USB controller.

Configuration options: [Enabled] [Disabled]

### USB 2.0 Support [Enabled]

Allows you to enable or disable the EHCI controller. Setting this item to [Enabled] allows the built-in high speed USB support in the BIOS to turn on automatically when you install high speed USB devices.

Configuration options: [Enabled] [Disabled]

### USB Legacy Mode Support [Enabled]

Allows you enable or disable support for the legacy USB devices.

Configuration options: [Disabled] [Enabled]

## 4.5 Power menu

The Power menu items allow you to change the settings for the Advanced Power Management (APM). Select an item then press <Enter> to display the configuration options.

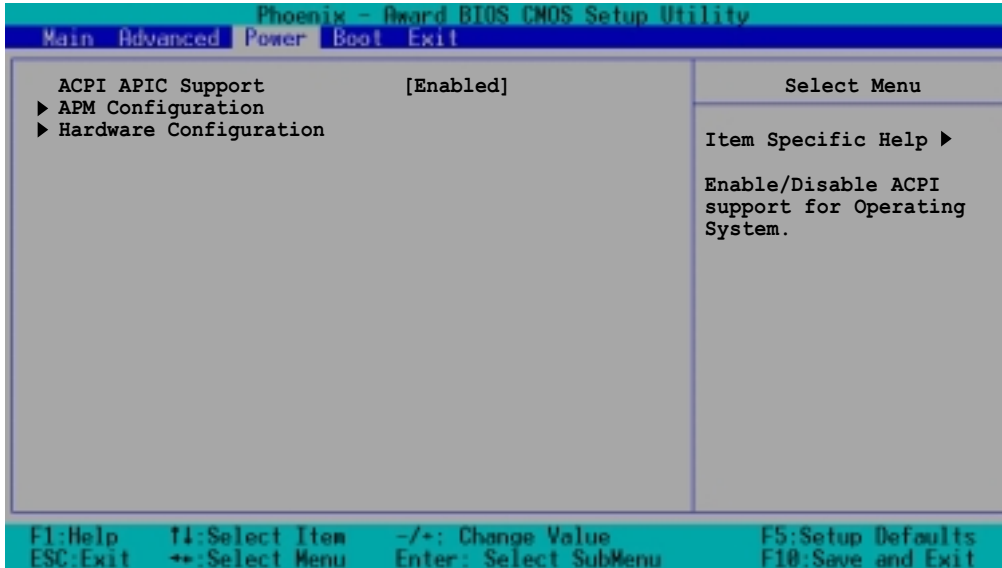

### ACPI APIC Support [Enabled]

Allows you to enable or disable the ACPI feature on the operating system.  
Configuration options: [Disabled] [Enabled]

## 4.5.1 APM Configuration

This menu shows the Advanced Power Management (APM) configuration settings. Select an item then press <Enter> to display a pop-up menu with the configuration options.

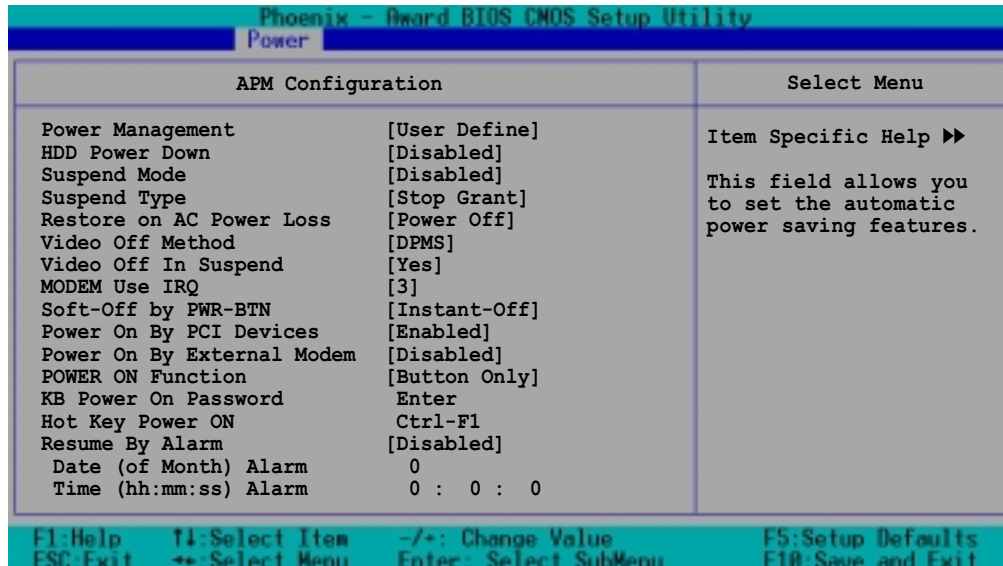

### Power Management [User Define]

Allows you to set the automatic power saving features.

Configuration options: [User Define] [Min. Saving] [Max. Saving]

### HDD Power Down [Disabled]

Shuts down any IDE hard disk drives in the system after a period of inactivity as set in this user-configurable field. This feature does not affect SCSI hard drives. Configuration options: [Disabled] [1 Min] ... [15 Min]

### Suspend Mode [Disabled]

Sets the time period before the system goes into suspend mode.

Configuration options: [Disabled] [1 Min] [2 Min] [4 Min] [8 Min] [12 Min] [20 Min] [30 Min] [40 Min] [1 Hr]

### Suspend Type [Stop Grant]

Allows you to select the suspend type.

Configuration options: [Stop Grant] [PwrOn Suspend]

### Restore on AC Power Loss [Power Off]

When set to [Power Off], the system goes into "off state" after an AC power interruption. When set to [Power On], the system turns on automatically after an power interruption. When set to [Last State], the system goes into whatever was the system state (on or off) before the power interruption. Configuration options: [Power Off] [Power On] [Last State]

## Video Off Method [DPMS]

This item determines the video off features. The Display Power Management System (DPMS) feature allows the BIOS to control the video display card if it supports the DPMS feature. [Blank Screen] only blanks the screen. Use this for monitors without power management or “green” features. Configuration options: [Blank Screen] [V/H SYNC+Blank] [DPMS]

## Video Off In Suspend [Yes]

This item determines when to activate the video off feature for monitor power management. Configuration options: [No] [Yes]

## MODEM Use IRQ [3]

Allows you to select the IRQ assignment for the modem. Configuration options: [NA] [3] [4] [5] [7] [9] [10] [11]

## Soft-Off by PWR-BTN [Instant-Off]

When set to [Instant-Off], the system goes to soft off when you press the power button for **less** than 4 seconds. When set to [Delay 4 Sec], press the power button for **more** than 4 seconds to power off the system. Configuration options: [Instant-Off] [Delay 4 Sec.]

## Power On By PCI Devices [Enabled]

Allows you to enable or disable the PME to generate a wake-up event. Configuration options: [Disabled] [Enabled]

## Power On By External Modem [Disabled]

Allows you to enable or disable system power up when the external modem receives a call while in soft-off mode. Configuration options: [Disabled] [Enabled]

## Power On Function [BUTTON ONLY]

Allows you to select a device to turn the system power on. Configuration options: [Password] [Hot Key] [Any KEY] [BUTTON ONLY] [PS/2 Mouse]

## KB Power On Password [Enter]

Allows you to set a password to turn the system power on. Highlight this item then press enter to set a password.



---

To configure this item, you should set the **Power On Function** item to [Password].

---



## Hot Key Power On [Ctrl-F1]

Allows you to set a hot key combination to turn the system power on.

Configuration options: [Ctrl-F1] ... [Ctrl-F12]



---

To configure this item, you should set the **Power On Function** item to [Hot Key].

---

## Resume by Alarm [Disabled]

Allows you to enable or disable RTC to generate a wake event. When this item is enabled, you can set the date and time of alarm using the two following items. Configuration options: [Disabled] [Enabled]

### Date (of Month) Alarm [0]

To set the date of alarm, highlight this item and press <Enter> to display a pop-up menu. Key-in a value within the specified range then press <Enter>.

Configuration options: [Min=0] [Max=31]

### Time (hh:mm:ss) Alarm [0 : 0 : 0]

To set the time of alarm:

1. Highlight this item and press <Enter> to display a pop-up menu for the hour field.
2. Key-in a value (Min=0, Max=23), then press <Enter>.
3. Press tab to move to the minutes field, then press <Enter>.
4. Key-in a minute value (Min=0, Max=59), then press <Enter>.
5. Press tab to move to the seconds field, then press <Enter>.
6. Key-in a value (Min=0, Max=59), then press <Enter>.

## 4.5.2 Hardware Monitor

This menu shows the hardware monitoring status. Select a sub-menu then press <Enter> to display the configuration options.

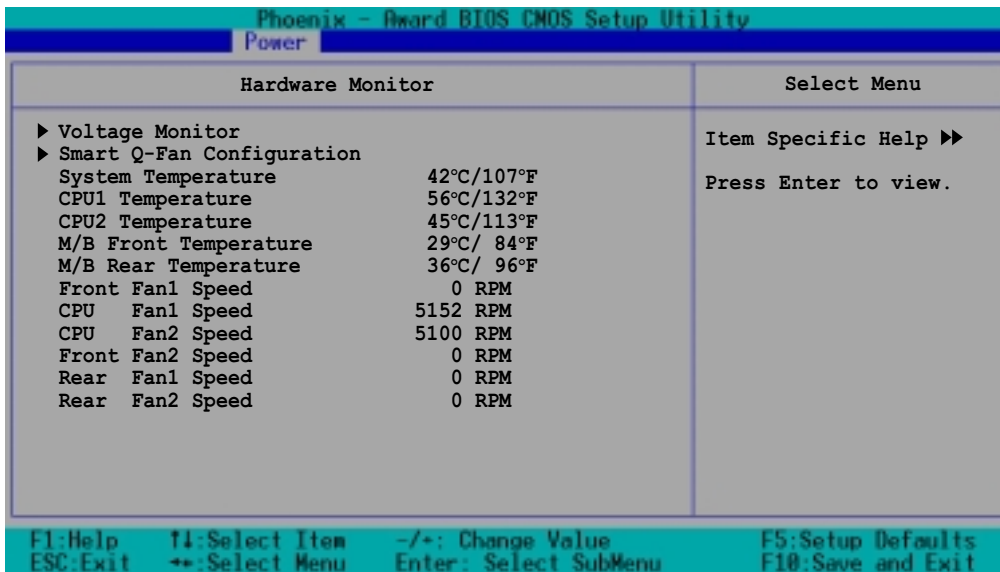

### Voltage Monitor

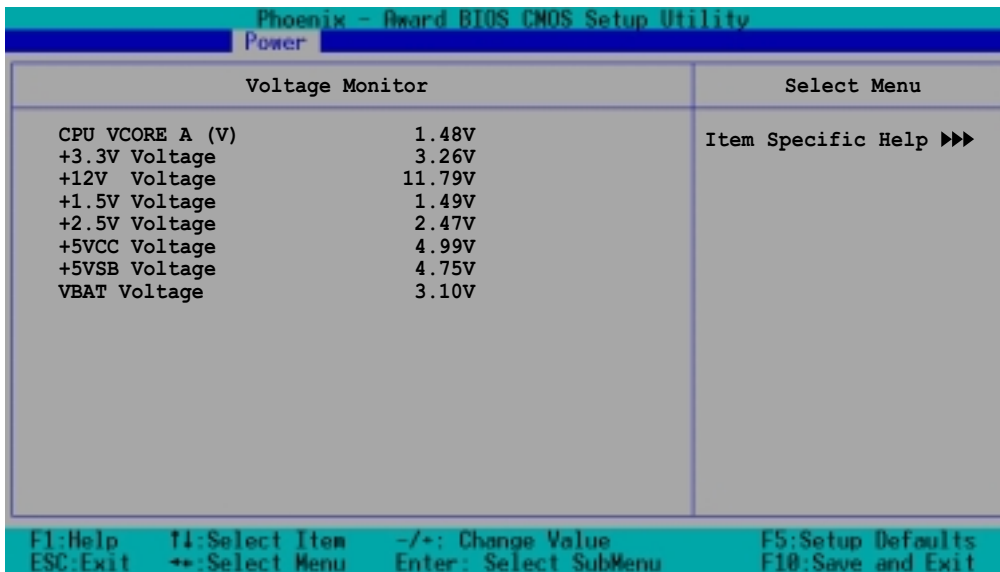

**CPU VCORE A, +3.3V Voltage, +12V Voltage, +1.5V Voltage, +2.5V Voltage, +5VCC Voltage, +5VSB Voltage, VBAT Voltage,**

These fields show the auto-detected voltages through the onboard voltage regulators.

## Smart Q-Fan Configuration

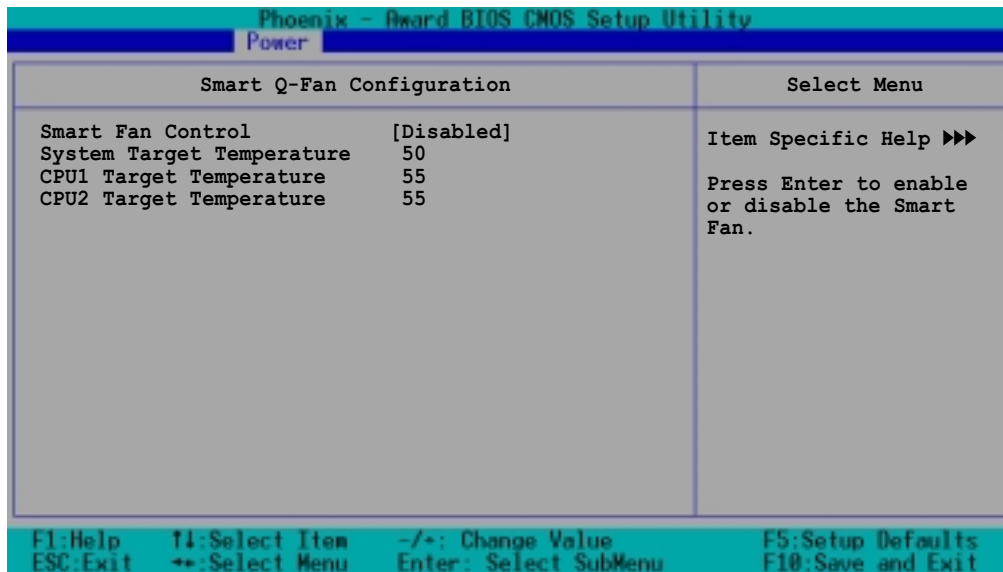

### **Smart Fan Control [Disabled]**

Allows you to enable or disable the Smart Fan feature. This feature smartly adjusts the CPU/system fan rotations based on the user-assigned threshold temperature. Configuration options: [Disabled] [Enabled]

### **System Target Temperature [50]**

### **CPU1 Target Temperature [55]**

### **CPU2 Target Temperature [55]**

Allows you to set the threshold temperature at which the Smart Fan Control feature is disabled.

## 4.6 Boot menu

The Boot menu items allow you to change the system boot settings. Select an item then press <Enter> to display a sub-menu with additional items, or show a pop-up menu with the configuration options.

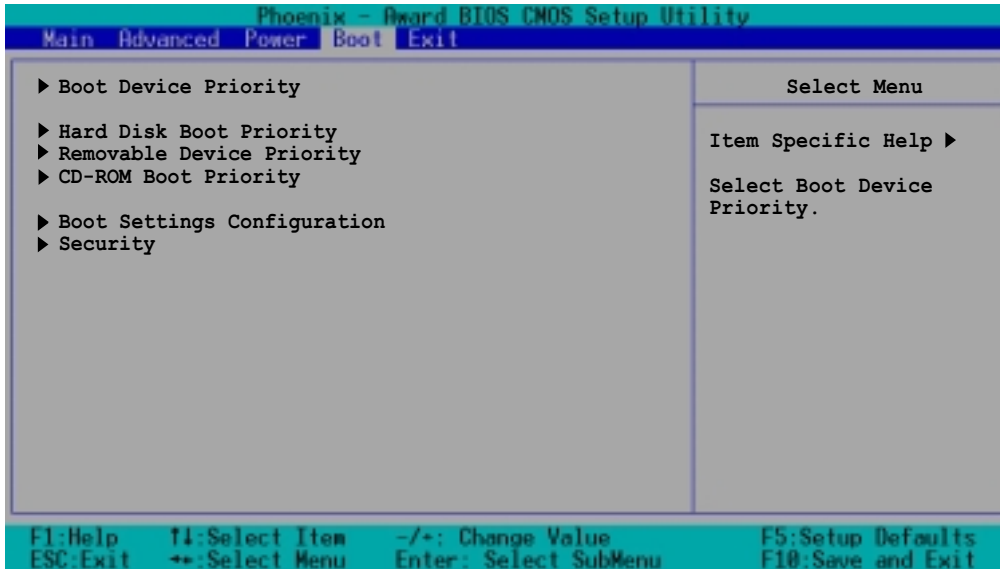

### 4.6.1 Boot Device Priority

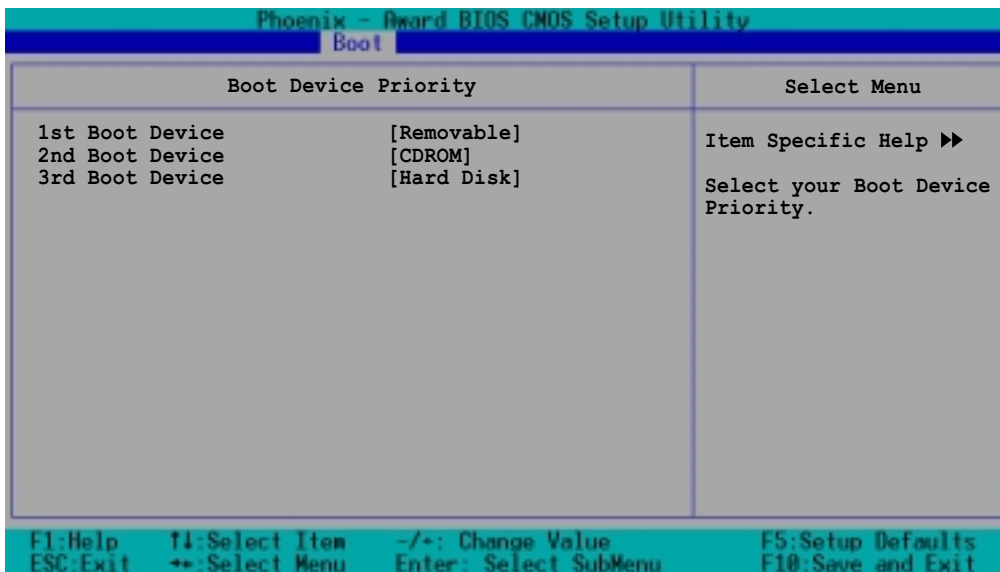

**1st Boot Device [Removable]**

**2nd Boot Device [CDROM]**

**3rd Boot Device [Hard Disk]**

Allows you to select your boot device priority.

Configuration options: [Removable] [Hard Disk] [CDROM] [Legacy LAN] [Disabled]

## 4.6.2 Hard Disk Boot Priority

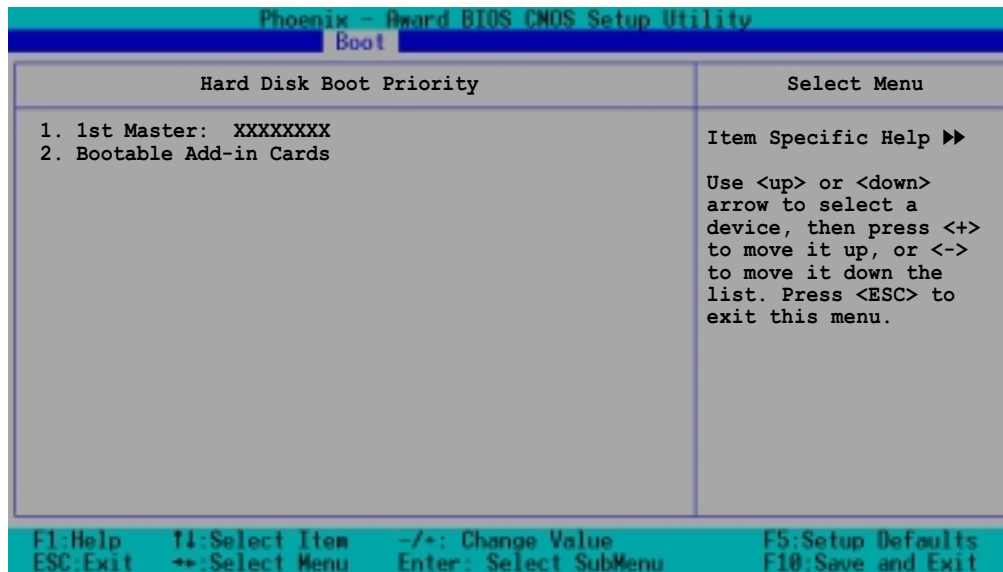

## 4.6.3 Removable Device Priority

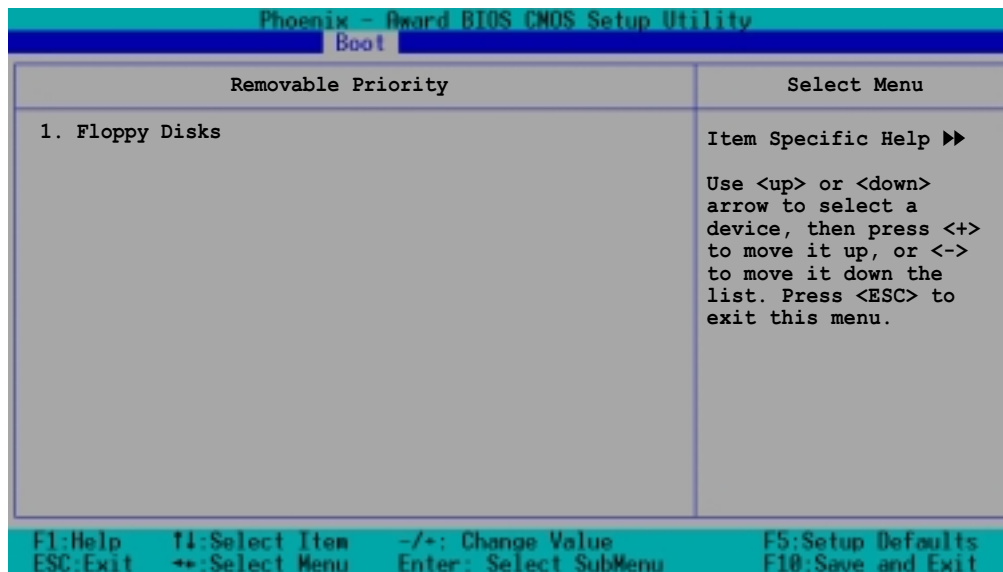

## 4.6.4 CD-ROM Boot Priority

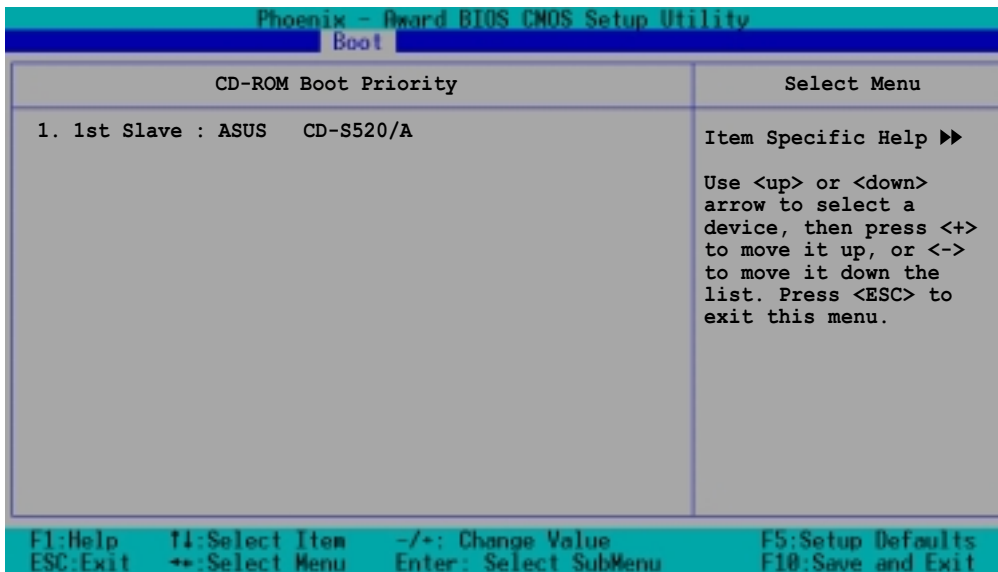

## 4.6.5 Boot Settings Configuration

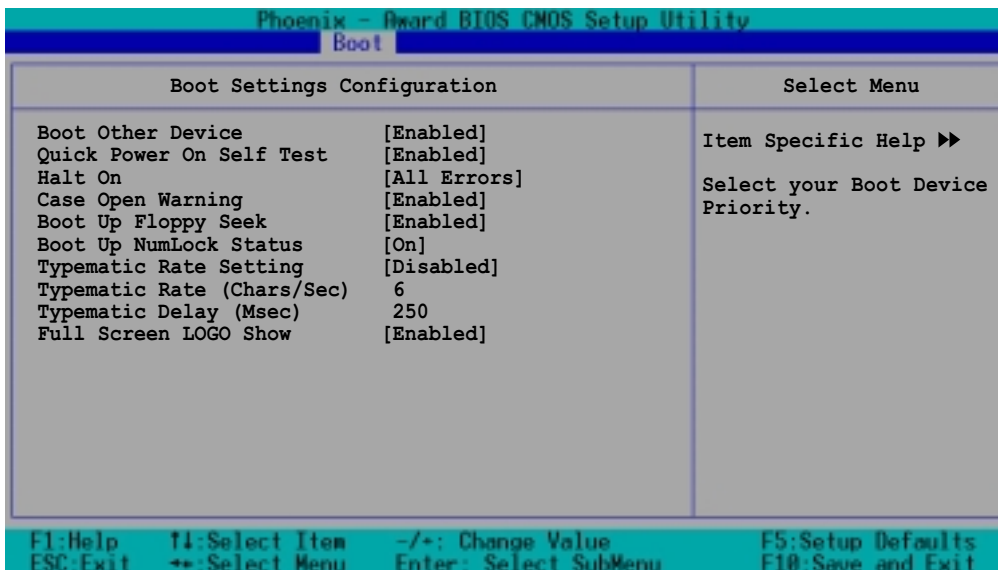

### Boot Other Device [Enabled]

Allows you to enable or disable selection of other boot device.  
Configuration options: [Disabled] [Enabled]

### Quick Power On Self Test [Enabled]

This field speeds up the Power-On-Self Test (POST) routine by skipping retesting a second, third, and fourth time. Configuration options: [Disabled] [Enabled]

## **Halt On [All Errors]**

Sets the system to halt on errors according to the system functions specified in each option. Configuration options: [All Errors] [No Errors] [All, But Keyboard] [All , But Diskette] [All, But Disk/Key]

## **Case Open Warning [Enabled]**

Allows you to enable or disable the case open status feature. Setting to [Enabled] clear the case open status. Configuration options: [Disabled] [Enabled]

## **Boot Up Floppy Seek [Enabled]**

When enabled, the BIOS will seek the floppy disk drive to determine whether the drive has 40 or 80 tracks. Configuration options: [Disabled] [Enabled]

## **Boot Up NumLock Status [On]**

Allows you to select the power-on state for the NumLock. Configuration options: [Off] [On]

## **Typematic Rate Setting [Disabled]**

Allows you to enable or disable the keyboard typematic rate setting. Set to [Enabled] to configure the Type Rate and Type Delay items. Configuration options: [Disabled] [Enabled]



---

The items **Typematic Rate (Chars/Sec)** and **Typematic Delay** become configurable only when the item Typematic Setting is enabled.

---

## **Typematic Rate (Chars/Sec) [6]**

Allows you to select the rate at which character repeats when you hold a key. Configuration options: [6] [8] [10] [12] [15] [20] [24] [30]

## **Typematic Delay (Msec) [250]**

Allows you to set the delay before key strokes begin to repeat. Configuration options: [250] [500] [750] [1000]

## **Full Screen LOGO Show [Enabled]**

Setting to [Enabled] displays the logo instead of the POST messages. Setting to [Disabled] displays the normal POST messages. Configuration options: [Disabled] [Enabled]

## 4.6.6 Security

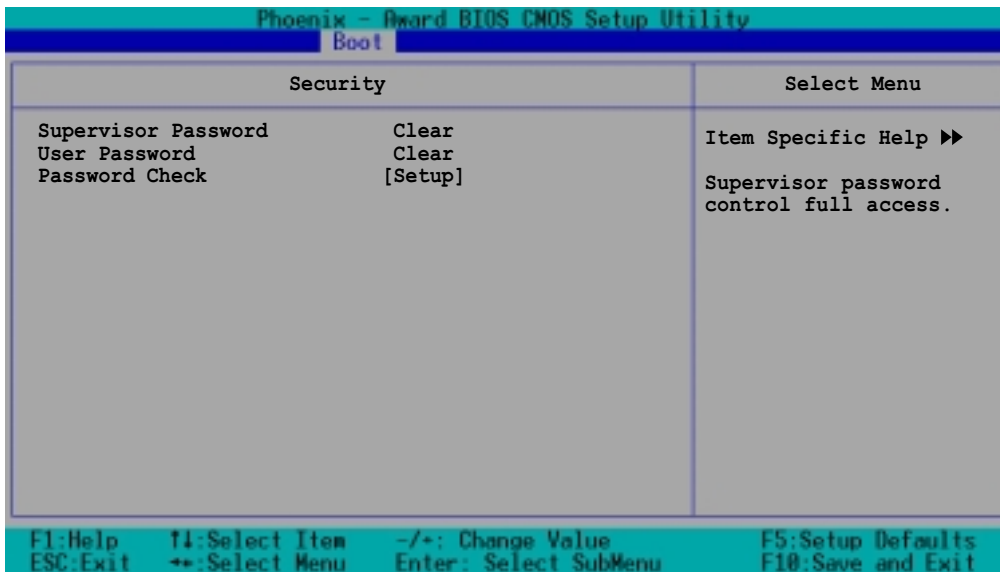

### Supervisor Password [Clear] User Password [Clear]

These fields allow you to set passwords.

To set a password:

1. Highlight an item then press <Enter>.
2. Type in a password using eight (8) alphanumeric characters, then press <Enter>.
3. When prompted, confirm the password by typing the exact characters again, then press <Enter>. The password field setting is changed to [Set].

To clear the password:

1. Highlight the password field, and press <Enter> twice. The following message appears:  
"PASSWORD DISABLED!!! Press any key to continue..."
2. Press any key to return to the menu.

#### *A note about passwords*

The Supervisor password is required to enter the BIOS Setup program preventing unauthorized access. The User password is required to boot the system preventing unauthorized use.



### Forgot the password?

If you forget your password, you can clear it by erasing the CMOS Real Time Clock (RTC) RAM. The RAM data containing the password information is powered by the onboard button cell battery. If you need to erase the CMOS RAM, refer to section “2.6 Jumpers” for instructions.

### **Password Check [Setup]**

This field requires you to enter the password before entering the BIOS setup or the system. Select [Setup] to require the password before entering the BIOS Setup. Select [System] to require the password before entering the system. Configuration options: [Setup] [System]

## 4.7 Exit menu

The Exit menu items allow you to load the BIOS setup default settings, save or discard any changes you made, or exit the Setup utility.

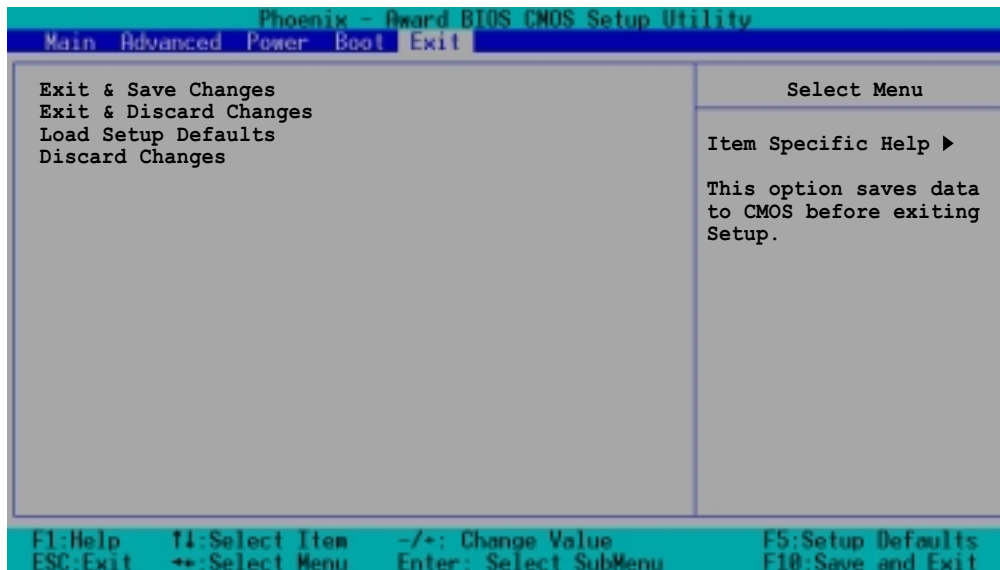

### Exit & Save Changes

Select this option then press Enter, or simply press <F10>, to save your changes to CMOS before exiting the Setup utility. When a confirmation window appears, type [Y] to save and exit, or [N] to cancel and return to the menu.

### Exit & Discard Changes

Select this option then press Enter if you wish to exit the Setup utility without saving your changes. When a confirmation window appears, type [Y] to exit and discard your changes, or [N] to cancel and return to the menu.

### Load Setup Defaults

Select this option then press Enter, or simply press <F5>, to load the optimized values for each of the Setup menu items. When a confirmation window appears, type [Y] to load the default values, or [N] to cancel and return to the menu.

### Discard Changes

Select this option to discard the changes that you made, and restore the previously saved values. When a confirmation appears, type [Y] to discard any changes and load the previously saved values, or [N] to cancel and return to the menu.

This chapter describes the power up sequence, the vocal POST messages, and ways of shutting down the system.

# Reference information



# Appendix summary



A.1 NCCH-DR block diagram .....A-1

# A.1 NCCH-DR block diagram

