

**NCT-D (A)**

**ASUS<sup>®</sup>**

**Motherboard**

**E1768**

**Revised Edition V3  
September 2004**

**Copyright © 2004 ASUSTeK COMPUTER INC. All Rights Reserved.**

No part of this manual, including the products and software described in it, may be reproduced, transmitted, transcribed, stored in a retrieval system, or translated into any language in any form or by any means, except documentation kept by the purchaser for backup purposes, without the express written permission of ASUSTeK COMPUTER INC. (“ASUS”).

Product warranty or service will not be extended if: (1) the product is repaired, modified or altered, unless such repair, modification or alteration is authorized in writing by ASUS; or (2) the serial number of the product is defaced or missing.

ASUS PROVIDES THIS MANUAL “AS IS” WITHOUT WARRANTY OF ANY KIND, EITHER EXPRESS OR IMPLIED, INCLUDING BUT NOT LIMITED TO THE IMPLIED WARRANTIES OR CONDITIONS OF MERCHANTABILITY OR FITNESS FOR A PARTICULAR PURPOSE. IN NO EVENT SHALL ASUS, ITS DIRECTORS, OFFICERS, EMPLOYEES OR AGENTS BE LIABLE FOR ANY INDIRECT, SPECIAL, INCIDENTAL, OR CONSEQUENTIAL DAMAGES (INCLUDING DAMAGES FOR LOSS OF PROFITS, LOSS OF BUSINESS, LOSS OF USE OR DATA, INTERRUPTION OF BUSINESS AND THE LIKE), EVEN IF ASUS HAS BEEN ADVISED OF THE POSSIBILITY OF SUCH DAMAGES ARISING FROM ANY DEFECT OR ERROR IN THIS MANUAL OR PRODUCT.

SPECIFICATIONS AND INFORMATION CONTAINED IN THIS MANUAL ARE FURNISHED FOR INFORMATIONAL USE ONLY, AND ARE SUBJECT TO CHANGE AT ANY TIME WITHOUT NOTICE, AND SHOULD NOT BE CONSTRUED AS A COMMITMENT BY ASUS. ASUS ASSUMES NO RESPONSIBILITY OR LIABILITY FOR ANY ERRORS OR INACCURACIES THAT MAY APPEAR IN THIS MANUAL, INCLUDING THE PRODUCTS AND SOFTWARE DESCRIBED IN IT.

Products and corporate names appearing in this manual may or may not be registered trademarks or copyrights of their respective companies, and are used only for identification or explanation and to the owners’ benefit, without intent to infringe.

# Contents

Notices .....	vi
Safety information .....	vii
About this guide .....	viii
Typography .....	ix
NCT-D (A) specifications summary .....	x

## Chapter 1: Product introduction

1.1	Welcome! .....	1-1
1.2	Package contents .....	1-1
1.3	Special features .....	1-2
1.3.1	Product highlights .....	1-2
1.3.2	Innovative ASUS features .....	1-4

## Chapter 2: Hardware information

2.1	Before you proceed .....	2-1
2.2	Motherboard overview .....	2-2
2.2.1	Placement direction .....	2-2
2.2.2	Screw holes .....	2-2
2.2.3	Support plates for motherboard .....	2-3
2.2.4	Motherboard layout .....	2-7
2.2.5	Layout contents .....	2-8
2.3	Central Processing Unit (CPU) .....	2-10
2.3.1	Installing the CPU .....	2-10
2.3.2	Installing the CPU heatsink and fan .....	2-12
2.4	System memory .....	2-14
2.4.1	Overview .....	2-14
2.4.2	Memory configurations .....	2-14
2.4.3	Installing a DIMM .....	2-15
2.4.4	Removing a DIMM .....	2-15
2.5	Expansion slots .....	2-16
2.5.1	Installing an expansion card .....	2-16
2.5.2	Configuring an expansion card .....	2-16
2.5.3	Interrupt assignments .....	2-17
2.5.4	PCI/PCI-X slots .....	2-18
2.5.5	PCI Express x8/x16 slots .....	2-18
2.5.6	Wi-Fi slot .....	2-18
2.6	Jumpers .....	2-19
2.7	Connectors .....	2-24
2.7.1	Rear panel connectors .....	2-24
2.7.2	Internal connectors .....	2-26

# Contents

## Chapter 3: Powering up

3.1	Starting up for the first time .....	3-1
3.2	Powering off the computer .....	3-2
3.2.1	Using the OS shut down function .....	3-2
3.2.2	Using the dual function power switch .....	3-2
3.3	ASUS POST Reporter™ .....	3-3
3.3.1	Vocal POST messages .....	3-3
3.3.2	Winbond Voice Editor .....	3-5

## Chapter 4: BIOS setup

4.1	Managing and updating your BIOS .....	4-1
4.1.1	Creating a bootable floppy disk .....	4-1
4.1.2	AFUDOS utility .....	4-2
4.1.3	ASUS CrashFree BIOS 2 utility .....	4-5
4.1.4	ASUS EZ Flash utility .....	4-7
4.1.5	ASUS Update utility .....	4-8
4.2	BIOS setup program .....	4-11
4.2.1	BIOS menu screen .....	4-12
4.2.2	Menu bar .....	4-12
4.2.3	Navigation keys .....	4-12
4.2.4	Menu items .....	4-13
4.2.5	Sub-menu items .....	4-13
4.2.6	Configuration fields .....	4-13
4.2.7	Pop-up window .....	4-13
4.2.8	Scroll bar .....	4-13
4.2.9	General help .....	4-13
4.3	Main menu .....	4-14
4.3.1	System Time .....	4-14
4.3.2	System Date .....	4-14
4.3.3	Legacy Diskette A .....	4-14
4.3.4	Primary, Third and Fourth IDE Master/Slave .....	4-15
4.3.5	IDE Configuration .....	4-16
4.3.6	System Information .....	4-17
4.4	Advanced menu .....	4-18
4.4.1	Instant Music Configuration .....	4-18
4.4.2	Speech Configuration .....	4-19
4.4.3	PCI Express Configuration .....	4-19
4.4.4	USB Configuration .....	4-20
4.4.5	MPS Configuration .....	4-21
4.4.6	CPU Configuration .....	4-21

# Contents

4.4.7	Chipset .....	4-22
4.4.8	Onboard Devices Configuration .....	4-24
4.4.9	PCI PnP .....	4-25
4.5	Power menu .....	4-27
4.5.1	Suspend Mode .....	4-27
4.5.2	Repost Video on S3 Resume .....	4-27
4.5.3	ACPI 2.0 Support .....	4-27
4.5.4	ACPI APIC Support .....	4-27
4.5.5	APM Configuration .....	4-28
4.5.6	Hardware Monitor .....	4-30
4.6	Boot menu .....	4-32
4.6.1	Boot Device Priority .....	4-32
4.6.2	Boot Settings Configuration .....	4-33
4.6.3	Security .....	4-34
4.7	Exit menu .....	4-37
<b>Appendix: Block diagram</b>		
	NCT-D (A) Block diagram .....	A-1

# Notices

## Federal Communications Commission Statement

This device complies with Part 15 of the FCC Rules. Operation is subject to the following two conditions:

- This device may not cause harmful interference, and
- This device must accept any interference received including interference that may cause undesired operation.

This equipment has been tested and found to comply with the limits for a Class B digital device, pursuant to Part 15 of the FCC Rules. These limits are designed to provide reasonable protection against harmful interference in a residential installation. This equipment generates, uses and can radiate radio frequency energy and, if not installed and used in accordance with manufacturer's instructions, may cause harmful interference to radio communications. However, there is no guarantee that interference will not occur in a particular installation. If this equipment does cause harmful interference to radio or television reception, which can be determined by turning the equipment off and on, the user is encouraged to try to correct the interference by one or more of the following measures:

- Reorient or relocate the receiving antenna.
- Increase the separation between the equipment and receiver.
- Connect the equipment to an outlet on a circuit different from that to which the receiver is connected.
- Consult the dealer or an experienced radio/TV technician for help.



---

The use of shielded cables for connection of the monitor to the graphics card is required to assure compliance with FCC regulations. Changes or modifications to this unit not expressly approved by the party responsible for compliance could void the user's authority to operate this equipment.

---

## Canadian Department of Communications Statement

This digital apparatus does not exceed the Class B limits for radio noise emissions from digital apparatus set out in the Radio Interference Regulations of the Canadian Department of Communications.

**This class B digital apparatus complies with Canadian ICES-003.**

# Safety information

## Electrical safety

- To prevent electrical shock hazard, disconnect the power cable from the electrical outlet before relocating the system.
- When adding or removing devices to or from the system, ensure that the power cables for the devices are unplugged before the signal cables are connected. If possible, disconnect all power cables from the existing system before you add a device.
- Before connecting or removing signal cables from the motherboard, ensure that all power cables are unplugged.
- Seek professional assistance before using an adapter or extension cord. These devices could interrupt the grounding circuit.
- Make sure that your power supply is set to the correct voltage in your area. If you are not sure about the voltage of the electrical outlet you are using, contact your local power company.
- If the power supply is broken, do not try to fix it by yourself. Contact a qualified service technician or your retailer.

## Operation safety

- Before installing the motherboard and adding devices on it, carefully read all the manuals that came with the package.
- Before using the product, make sure all cables are correctly connected and the power cables are not damaged. If you detect any damage, contact your dealer immediately.
- To avoid short circuits, keep paper clips, screws, and staples away from connectors, slots, sockets and circuitry.
- Avoid dust, humidity, and temperature extremes. Do not place the product in any area where it may become wet.
- Place the product on a stable surface.
- If you encounter technical problems with the product, contact a qualified service technician or your retailer.

# About this guide

This user guide contains the information you need when installing and configuring the motherboard.

## How this guide is organized

This manual contains the following parts:

- **Chapter 1: Product introduction**  
This chapter describes the features of the motherboard and the new technology it supports.
- **Chapter 2: Hardware information**  
This chapter lists the hardware setup procedures that you have to perform when installing system components. It includes description of the switches, jumpers, and connectors on the motherboard.
- **Chapter 3: Powering up**  
This chapter describes the power up sequence, the vocal POST messages, and ways of shutting down the system.
- **Chapter 4: BIOS setup**  
This chapter tells how to change system settings through the BIOS Setup menus. Detailed descriptions of the BIOS parameters are also provided.
- **Appendix: Reference information**  
This appendix includes additional information that you may refer to when configuring the motherboard.

## Where to find more information

Refer to the following sources for additional information and for product and software updates.

### 1. ASUS websites

The ASUS website provides updated information on ASUS hardware and software products. Refer to the ASUS contact information.

### 2. Optional documentation

Your product package may include optional documentation, such as warranty flyers, that may have been added by your dealer. These documents are not part of the standard package.



## Conventions used in this guide

To make sure that you perform certain tasks properly, take note of the following symbols used throughout this manual.



**DANGER/WARNING:** Information to prevent injury to yourself when trying to complete a task.



**CAUTION:** Information to prevent damage to the components when trying to complete a task.



**IMPORTANT:** Instructions that you **MUST** follow to complete a task.



**NOTE:** Tips and additional information to help you complete a task.

## Typography

**Bold text**

Indicates a menu or an item to select.

*Italics*

Used to emphasize a word or a phrase.

<Key>

Keys enclosed in the less-than and greater-than sign means that you must press the enclosed key.

Example: <Enter> means that you must press the Enter or Return key.

<Key1+Key2+Key3>

If you must press two or more keys simultaneously, the key names are linked with a plus sign (+).

Example: <Ctrl+Alt+D>

**Command**

Means that you must type the command exactly as shown, then supply the required item or value enclosed in brackets.

Example: At the DOS prompt, type the command line:

**afudos /i[filename]**

**afudos /iP5GD2.ROM**

## NCT-D (A) specifications summary

<b>CPU</b>	Dual 604-pin sockets for Intel® Xeon™ processors with Extended Memory 64-bit Technology (EM64T) Supports Intel® Hyper-Threading Technology
<b>Chipset</b>	Northbridge : Intel® E7525 Memory Controller Hub (MCH) Southbridge : Intel® 6300ESB
<b>Front Side Bus</b>	800 MHz
<b>Memory</b>	Dual-channel memory architecture 4 x 240-pin DIMM sockets support registered ECC 400 MHz DDR2 memory modules Supports 256 MB up to 8 GB system memory
<b>Expansion slots</b>	1 x PCI Express x8 slot (x4 link, PCI Express 1.0a) 1 x PCI Express x16 slots (Graphic card, PCI Express 1.0a) 1 x PCI-X 66 MHz/64-bit slot (PCI-X 1.0a) 1 x PCI-X 66 MHz/64-bit slot (supports ZCR, PCI-X 1.0a) 1 x PCI 33 MHz/32-bit/5V (PCI 2.3) 1 x WiFi slot (ASUS proprietary)
<b>Storage</b>	Intel® 6300ESB South Bridge supports: <ul style="list-style-type: none"> <li>- 2 x Ultra DMA 100/66/33</li> <li>- 2 x Serial ATA with RAID 0, RAID 1 configuration and the Adaptec® HostRAID™ technology</li> </ul> Optional: Adaptec AIC-8130 PCI-X SATA-II controller supports: <ul style="list-style-type: none"> <li>- 4 x SATAII 300 with RAID 0, RAID 1, and RAID 0+1 configuration</li> <li>- Zero-Channel RAID card (optional)</li> </ul>
<b>Wi-Fi solution (optional)</b>	ASUS WiFi-b/g Wi-Fi slot/PCI solution provides: <ul style="list-style-type: none"> <li>- support for IEEE 802.11g/b wireless standards</li> <li>- up to 11 Mbps /54 Mbps wireless data transmission</li> <li>- Software Access Point (Soft AP) feature on Windows® XP/2003 Server OS</li> </ul>
<b>Audio</b>	ADI AD1980 6-channel audio CODEC
<b>LAN</b>	Broadcom BMC5751 PCI Express Gigabit LAN controller Supports PCI Express 1.0a interface
<b>USB</b>	Intel® 6300ESB South Bridge supports: <ul style="list-style-type: none"> <li>- 4 USB 2.0 ports (on the rear panel)</li> </ul> VIA VT6212 PCI USB2.0 controller supports: <ul style="list-style-type: none"> <li>- 4 USB 2.0 ports (on the front panel)</li> </ul>
<b>IEEE 1394</b>	TI TBS43AB22A PCI IEEE 1394a controller 2 x IEEE 1394a ports

*(continued on the next page)*

## NCT-D (A) specifications summary

<b>Special features</b>	ASUS Post Reporter™ ASUS Q-Fan2 ASUS EZ Flash ASUS CrashFree BIOS 2 ASUS MyLogo2 ASUS Instant Music
<b>BIOS features</b>	AMI BIOS, 8 MB Flash ROM, Green, PnP, DMI2.0a, SMBIOS 2.3, WfM2.0
<b>Rear panel</b>	1 x PS/2 keyboard port (purple) 1 x PS/2 mouse port (green) 1 x Parallel port 1 x Serial port 1 x Coaxial S/PDIF Out port 1 x IEEE 1394a port 1 x LAN (RJ-45) port 4 x USB 2.0 ports 6-channel audio ports
<b>Internal connectors</b>	Floppy disk drive connector Primary and secondary IDE connectors Serial ATA connectors Serial ATA RAID connectors Hard disk activity LED connector Internal audio connectors Chassis intrusion connector Front panel audio connector CPU, Chassis, and Power Fan connectors IEEE 1394a port connector USB connectors SSI 24-pin and 8-pin PSU connector Serial port connector GAME/MIDI port connector Backplane SMBus connector System panel connector
<b>Power Requirement</b>	SSI power supply (with 24-pin and 8-pin 12 V plugs) ATX 12V 2.0 compliant
<b>Form Factor</b>	ATX form factor: 12 in x 9.8 in (30.5 cm x 24.9 cm)
<b>Support CD contents</b>	Device drivers ASUS Server Web-based Management (ASWM) ASUS PC Probe ASUS Live Update Utility Anti-virus software

*\*Specifications are subject to change without notice.*



This chapter describes the motherboard features and the new technologies it supports.

# Product introduction



# Chapter summary



1.1	Welcome! .....	1-1
1.2	Package contents .....	1-1
1.3	Special features .....	1-2

## 1.1 Welcome!

Thank you for buying an ASUS® NCT-D (A) motherboard!

The motherboard delivers a host of new features and latest technologies, making it another standout in the long line of ASUS quality motherboards!

Before you start installing the motherboard, and hardware devices on it, check the items in your package with the list below.

## 1.2 Package contents

Check your motherboard package for the following items.

<b>Motherboard</b>	ASUS NCT-D motherboard
<b>I/O modules</b>	Serial port module USB 2.0 (2 ports) and GAME (1 port) module IEEE 1394 module (1-port)
<b>Cables</b>	6 x Serial ATA signal cables 3 x Serial ATA power cables (dual-plug) 2 x Ultra DMA/133 cables 80-conductor IDE cable 3-in-1 floppy disk drive cable
<b>Accessories</b>	I/O shield X-PAD accessory kit
<b>Application CDs</b>	ASUS motherboard support CD (includes ASWM)
<b>Documentation</b>	User guide
<b>Optional items</b>	ASUS WiFi-g card (PCI) with dipolar antenna ASUS WiFi-b card (Wi-Fi slot) with dipolar antenna



If any of the above items is damaged or missing, contact your retailer.

## 1.3 Special features

### 1.3.1 Product highlights

#### Latest processor technology

The motherboard comes with dual 604-pin surface mount ZIF sockets designed for the Intel® Xeon™ processor with 800 MHz Front Side Bus (FSB) and 1 MB L2 cache. The processor incorporates the Intel® Hyper-Threading Technology, the Intel® NetBurst™ micro-architecture that features hyper-pipelined technology, and Extended Memory 64-bit Technology (EM64T). The EM64T enables support for 64-bit operating systems, such as 64-bit Windows® and Linux. See page 2-10 for details.

#### Intel® E7525 and Intel® 6300 ESB chipset

The Intel® E7525 Memory Controller Hub (MCH) and the Intel® 6300ESB I/O controller hub (ICH) provide the vital interfaces for the motherboard.

The MCH provides the processor, dual-channel DDR2-400 memory, and PCI Express™ interfaces. The ICH is a new generation server class I/O controller hub that provides the interface for PCI-X 1.0a.

#### DDR2 memory support

The motherboard supports DDR2 memory which features data transfer rates of 400 MHz to meet the higher bandwidth requirements of the latest 3D graphics, multimedia, and Internet applications. The dual-channel DDR2 architecture doubles the bandwidth of your system memory to boost system performance, eliminating bottlenecks with peak bandwidths of up to 8.5 GB/s.

#### Serial ATA technology

The motherboard supports the Serial ATA technology through the Serial ATA interfaces controlled by the Intel® 6300ESB and the Adaptec AIC-8130 (optional). The SATA specification allows for thinner, more flexible cables with lower pin count, reduced voltage requirement, and up to 150 MB/s data transfer rate for Intel® 6300ESB and 300 MB/s for AIC-8130. See page 2-27 and 2-28 for details.

#### PCI Express™ interface

The motherboard fully supports PCI Express, the latest I/O interconnect technology that speeds up the PCI bus. PCI Express™ features point-to-point serial interconnections between devices and allows higher clocks speeds by carrying data in packets. This high speed interface is software compatible with existing PCI or PCI-X specifications. See page 2-18 for details.



## Gigabit and wireless LAN solutions



The motherboard comes with an onboard Gigabit LAN controller to provide a total solution for your wired networking needs. The onboard Broadcom BCM5751 Gigabit LAN controller uses the PCI Express interface and has network throughput close to Gigabit bandwidth. The motherboard also comes with the ASUS proprietary Wi-Fi slot that supports an optional WiFi-b/g card for your wireless Internet, LAN, and file sharing requirements. See page 2-18 for details.

## Built-in SATA RAID solution



The Intel® 6300ESB allows RAID 0 and RAID 1 configuration for four SATA connectors and supports the Adaptec® HostRAID™ technology. See page 2-27 for details.

The optional Adaptec AIC-8130 PCI-X SATA-II controller supports four additional SATA connectors, and allows RAID 0, RAID 1, and RAID 0+1. See page 2-28 for details.

## Zero-Channel RAID (ZCR) support (on SATA models only)

The Adaptec AIC-8130 PCI-X SATA-II controller supports an optional Zero-Channel RAID card on the 64-bit PCI-X slot to create a RAID solution, including RAID 0 (striping), RAID 1 (mirroring), RAID 0+1, and RAID 5. The ZCR capability provides a high-performance, cost effective and reliable storage solution to the server system.

## 6-channel audio

Onboard is the ADI AD1980 AC '97 audio CODEC that supports 6-channel 5.1 surround sound output, stereo microphone input, variable Sample Rate Conversion (SRC), professional quality 103-dB output with 94-dB SNR, and analog enumeration capability. The SoundMAX 4 XL software features the AudioESP™ (Audio Enumeration and Sensing Process) that allows intelligent detection of the peripherals plugged into the audio ports and identifies the incompatible devices, if any. See page 2-25 for details.

## S/PDIF digital sound ready



The motherboard supports the S/PDIF Out function through the S/PDIF interfaces on the rear panel and at midboard. The S/PDIF technology turns your computer into a high-end entertainment system with digital connectivity to powerful audio and speaker systems. See page 2-25 for details.

## IEEE 1394a support

The motherboard supports the IEEE 1394a interface that provides high-speed and flexible PC connectivity to a wide range of peripherals and devices compliant to IEEE 1394a standards. The IEEE 1394a interface allows up to 400 Mbps transfer rates through simple, low-cost, high-bandwidth asynchronous (real-time) data interfacing between computers, peripherals, and consumer electronic devices such as camcorders, VCRs, printers, TVs, and digital cameras. See page 2-31 for details.

## USB 2.0 technology

The motherboard implements the Universal Serial Bus (USB) 2.0 specification, dramatically increasing the connection speed from the 12 Mbps bandwidth on USB 1.1 to a fast 480 Mbps on USB 2.0. USB 2.0 is backward compatible with USB 1.1. See page 2-25 and 2-31 for details.

## Temperature, fan, and voltage monitoring

The CPU temperature is monitored by the ASIC (integrated in the Winbond Super I/O) to prevent overheating and damage. The system fan rotations per minute (RPM) is monitored for timely failure detection. The ASIC monitors the voltage levels to ensure stable supply of current for critical components. See page 4-30 and 4-31 for details.

## 1.3.2 Innovative ASUS features

### CrashFree BIOS 2

This feature allows you to restore the original BIOS data from the support CD in case when the BIOS codes and data are corrupted. This protection eliminates the need to buy a replacement ROM chip. See page 4-5 for details.

### ASUS Smart Fan technology

The ASUS Smart Fan technology smartly adjusts the fan speeds according to the system loading to ensure quiet, cool, and efficient operation. See page 4-30 for details.

## ASUS POST Reporter™



The motherboard offers a new exciting feature called the ASUS POST Reporter™ to provide friendly voice messages and alerts during the Power-On Self-Tests (POST) informing you of the system boot status and causes of boot errors, if any. The bundled Winbond Voice Editor software lets you to customize the voice messages in different languages. See page 3-3 for details.

## ASUS MyLogo2™



This new feature present in the motherboard allows you to personalize and add style to your system with customizable boot logos. See page 4-33 for details.

## ASUS Instant Music



This unique feature allows you to playback audio files even before entering the operating system. Just press the ASUS Instant Music special function keys and enjoy the music! See page 4-18 for details.

## ASUS EZ Flash BIOS



With the ASUS EZ Flash, you can easily update the system BIOS even before loading the operating system. No need to use a DOS-based utility or boot from a floppy disk. See page 4-7 for details.



This chapter lists the hardware setup procedures that you have to perform when installing system components. It includes description of the jumpers and connectors on the motherboard.

# Hardware information



## Chapter summary



2.1	Before you proceed .....	2-1
2.2	Motherboard overview .....	2-2
2.3	Central Processing Unit (CPU) .....	2-10
2.4	System memory .....	2-14
2.5	Expansion slots .....	2-16
2.6	Jumpers .....	2-19
2.7	Connectors .....	2-24

## 2.1 Before you proceed

Take note of the following precautions before you install motherboard components or change any motherboard settings.



- Unplug the power cord from the wall socket before touching any component.
- Use a grounded wrist strap or touch a safely grounded object or to a metal object, such as the power supply case, before handling components to avoid damaging them due to static electricity.
- Hold components by the edges to avoid touching the ICs on them.
- Whenever you uninstall any component, place it on a grounded antistatic pad or in the bag that came with the component.
- **Before you install or remove any component, ensure that the power supply is switched off or the power cord is detached from the power supply.** Failure to do so may cause severe damage to the motherboard, peripherals, and/or components.

### Onboard LED

The motherboard comes with a standby power LED. The green LED lights up to indicate that the system is ON, in sleep mode, or in soft-off mode. This is a reminder that you should shut down the system and unplug the power cable before removing or plugging in any motherboard component. The illustration below shows the location of the onboard LED.

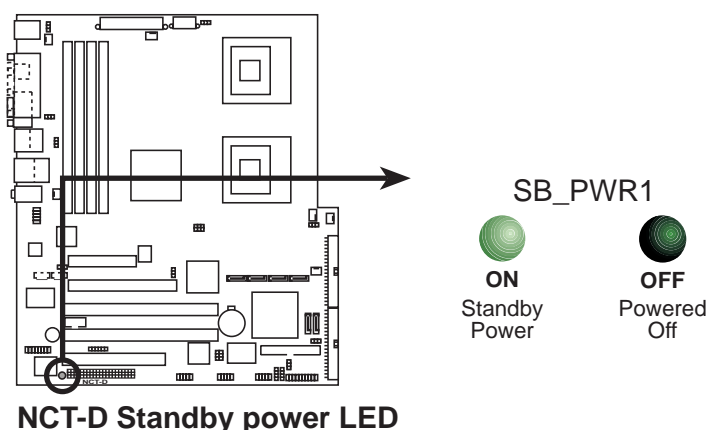

## 2.2 Motherboard overview

Before you install the motherboard, study the configuration of your chassis to ensure that the motherboard fits into it.



Make sure to unplug the chassis power cord before installing or removing the motherboard. Failure to do so can cause you physical injury and damage motherboard components.

### 2.2.1 Placement direction

When installing the motherboard, make sure that you place it into the chassis in the correct orientation. The edge with external ports goes to the rear part of the chassis as indicated in the image below.

### 2.2.2 Screw holes

Place ten (10) screws into the holes indicated by circles to secure the motherboard to the chassis.



Do not overtighten the screws! Doing so can damage the motherboard.

Place this side towards  
the rear of the chassis

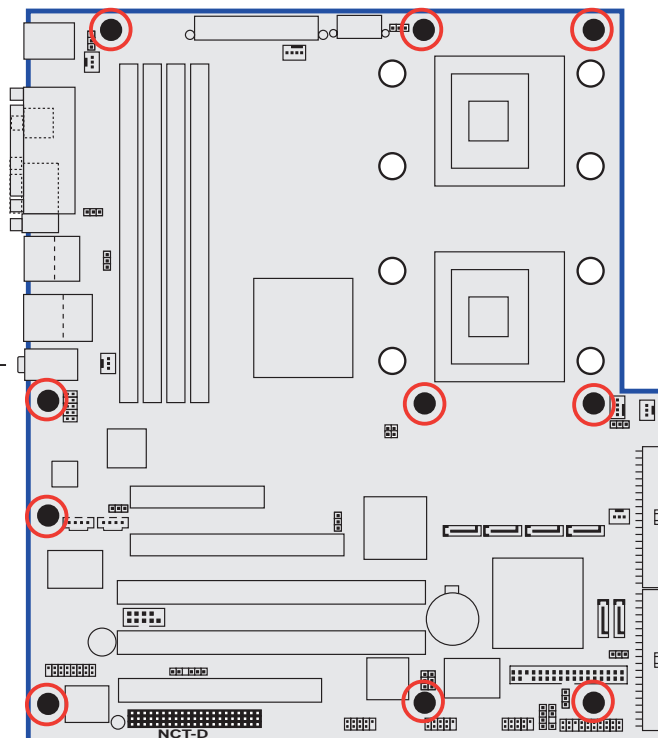



## 2.2.3 Support plates for motherboard

For additional protection from motherboard breakage due to the weight of the CPU heatsinks, your motherboard package comes with a solution kit that consists of:

- 2 x metal support plates
- 1 x contour sheet
- 3 different sets of metal nuts and rubber pads for varied chassis standoffs (each set contains 8 metal nuts and 2 rubber pads)

To install the support plates:

1. Open and lay your system chassis flat on a stable surface, then locate the motherboard standoffs as shown.

Standoff

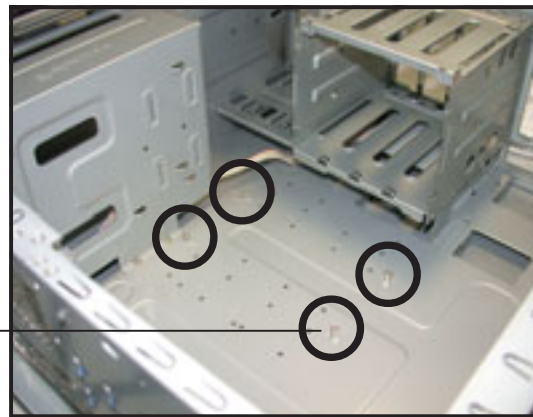

2. Align the holes of the contour sheet with the standoffs on the base of the chassis. Press the sheet flat making sure that it is completely affixed to the chassis.

Standoff beside power supply cage



The contour sheet fits in only one orientation. Make sure that the hole located about 1 cm from the corner matches the standoff beside the power supply cage.

3. Determine the height of the standoffs on your chassis, and select the appropriate set of metal nuts and rubber pads from your package.



Use a nut size that is slightly lower than the standoffs on your chassis.

4. Use a plier to attach four nuts to the bolts on the metal support plate.



5. Align a rubber pad to the rectangular mark on the center of the plate, then press to attach.



6. Remove the adhesive label underneath a plate.



7. Carefully align and place the plate on a rectangular cut on the contour sheet.



---

Make sure that the metal support plates fit perfectly to the rectangular cuts on the contour sheet; otherwise, the CPU heatsink screws would not align to the metal nuts.

---

8. Repeat steps 4 and 7 to prepare and install the second plate.

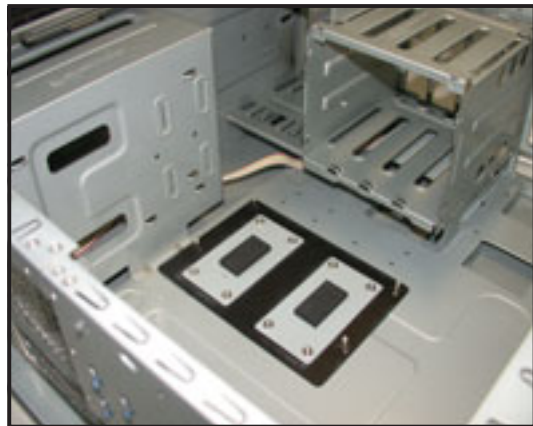

9. Remove the contour sheet from the chassis.



The support plates appear as shown when installed.



10. Install the motherboard with the external I/O ports toward the chassis rear panel. The CPU sockets should be right on top of the support plates.

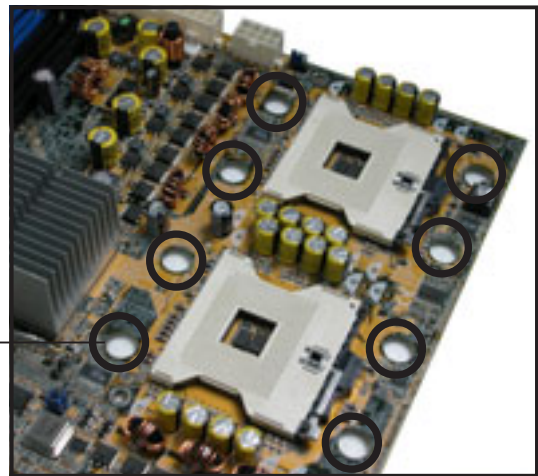

**Heatsink hole matched to a nut on the support plate**



---

Make sure that the CPU heatsink holes on the motherboard perfectly match the metal nuts on the support plates; otherwise, you can not install the CPU heatsinks properly.

---

11. Secure the motherboard with 10 screws. Refer to section “2.2.2 Screw holes” for illustration.

## 2.2.4 Motherboard layout

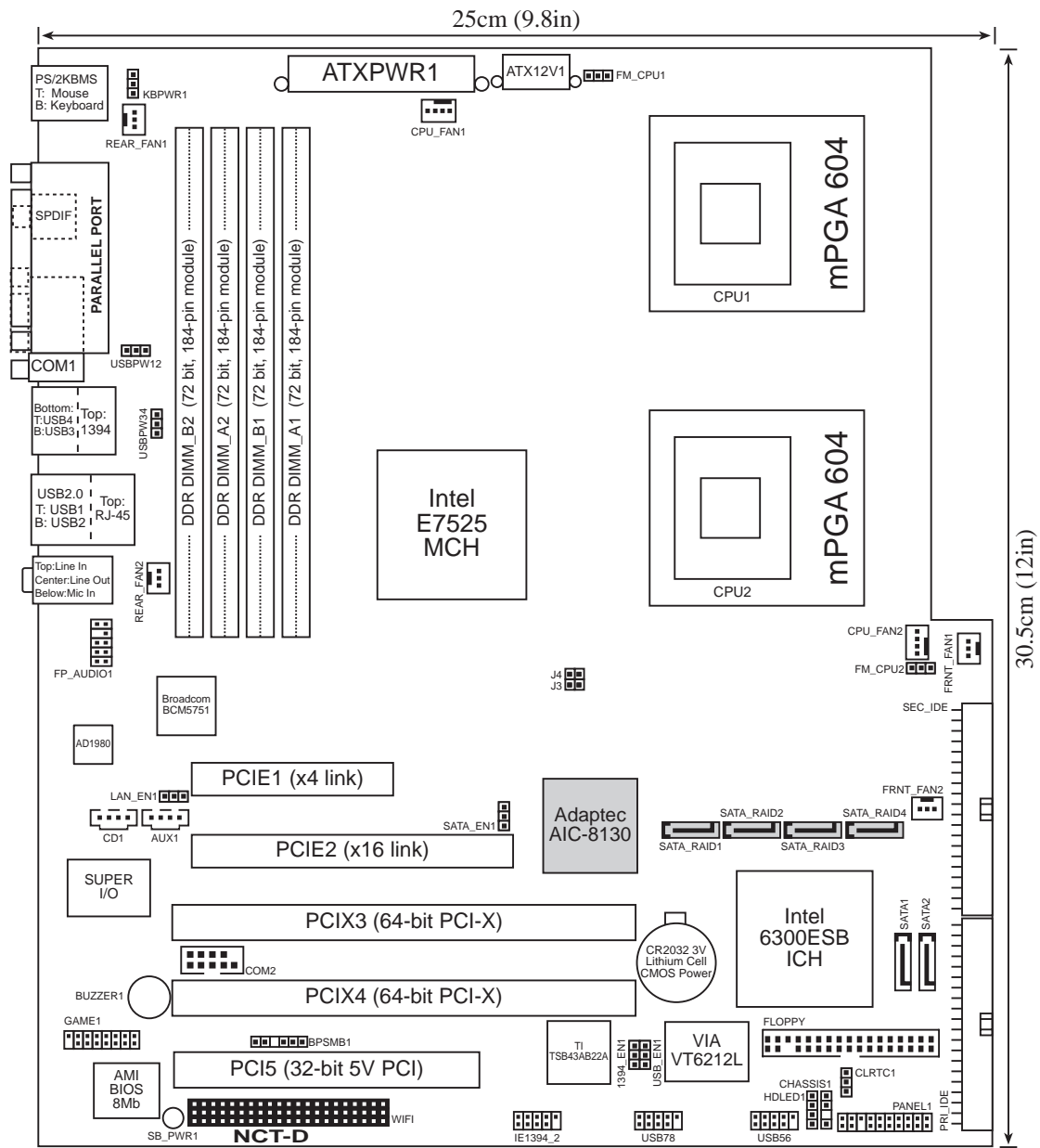

## 2.2.5 Layout contents

Slots	Page
1. CPU sockets	2-10
2. DDR2 DIMM sockets	2-14
3. PCI/PCI-X/PCI Express slots	2-18
4. Wi-Fi slot	2-18

Jumpers	Page
1. Clear RTC RAM (CLRTC1)	2-19
2. CPU fan pin selection (3-pin FM_CPU1, FM_CPU2)	2-20
3. USB device wake-up (3-pin USBPW12, USBPW34)	2-20
5. Keyboard power (3-pin KBPWR1)	2-21
6. IEEE 1394 controller setting (3-pin 1394_EN1)	2-21
7. Gigabit LAN controller setting (3-pin LAN_EN1)	2-22
8. SATA controller setting (3-pin SATA_EN1)	2-22
9. USB controller setting (3-pin USB_EN1)	2-23

Rear panel connectors	Page
1. PS/2 mouse port (green)	2-24
2. Parallel port	2-24
3. IEEE 1394a port	2-24
4. LAN (RJ-45) port	2-24
5. Line In port (light blue)	2-24
6. Line Out port (lime)	2-24
7. Microphone port (pink)	2-24
8. USB 2.0 ports 3 and 4	2-25
9. USB 2.0 ports 1 and 2	2-25
10. Serial (COM1) port	2-25
11. Coaxial S/PDIF Out port	2-25
12. PS/2 keyboard port (purple)	2-25

<b>Internal connectors</b>	<b>Page</b>
1. Floppy disk drive connector (34-1 pin FLOPPY)	2-26
2. Primary IDE connector (40-1 pin PRI_IDE, SEC_IDE)	2-26
3. Serial ATA connectors (7-pin SATA1, SATA2)	2-27
4. Serial ATA RAID connectors (7-pin SATA_RAID1, SATA_RAID2, SATA_RAID3, SATA_RAID4)	2-28
5. Hard disk activity LED connector (2-pin HDLED1)	2-28
6. Internal audio connectors (4-pin CD1, AUX1)	2-29
7. Chassis intrusion connector (4-1 pin CHASSIS1)	2-29
8. Front panel audio connector (10-1 pin FP_AUDIO1)	2-30
9. CPU, Chassis, and Power Fan connectors (3-pin CPU_FAN1/2, REAR_FAN1/2, FRNT_FAN1/2)	2-30
10. IEEE 1394a port connector (10-1 pin IE1394_2)	2-31
11. USB connectors (10-1 pin USB56, USB78)	2-31
12. SSI power connectors (24-pin EATXPWR1, 8-pin ATX12V1)	2-32
13. Serial port connector (10-1 pin COM2)	2-33
14. GAME/MIDI port connector (16-1 pin GAME1)	2-33
15. Backplane SMBus connector (6-1 pin BPSMB1)	2-34
16. System panel connector (20-pin PANEL1)	2-34
System power LED (Green 3-pin PLED)	2-34
Hard disk drive activity LED (Red 2-pin IDE_LED)	2-35
System warning speaker (Orange 4-pin SPEAKER)	2-35
ATX power button/soft-off button (Yellow 2-pin PWRSW)	2-35
Reset button (Blue 2-pin RESET)	2-35



## 2.3 Central Processing Unit (CPU)

The motherboard comes with surface mount 604-pin Zero Insertion Force (ZIF) sockets. The sockets are designed for the Intel® Xeon™ processor in the 604-pin package with 1 MB L2 cache. The new generation Intel® Xeon™ processor supports 800 MHz system bus and Extended Memory 64-bit Technology (EM64T).

### 2.3.1 Installing the CPU

To install a CPU:

1. Locate the CPU sockets on the motherboard.

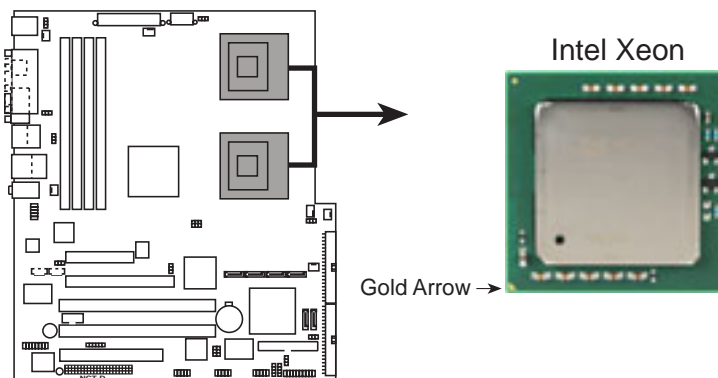

**NCT-D Socket 604**



---

If installing only one CPU, use the socket CPU1.

---

2. Flip up the socket lever and push it all the way to the other side.



---

Make sure that the socket lever is pushed back all the way, otherwise the CPU does not fit in completely.

---

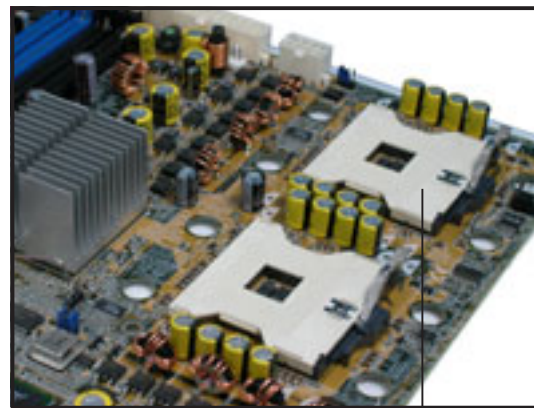

**Socket for CPU1**



3. Position the CPU above the socket as shown.
4. Carefully insert the CPU into the socket until it fits in place.



---

The CPU fits only in one correct orientation. DO NOT force the CPU into the socket to prevent bending the pins and damaging the CPU!

---

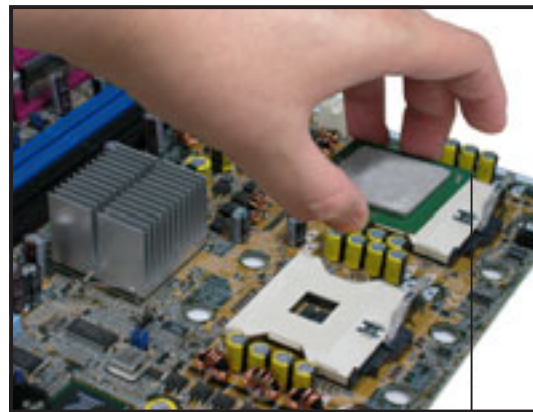

Marked corner  
(gold arrow)

5. Carefully push down the socket lever to secure the CPU. The lever clicks on the side tab to indicate that it is locked.
6. Apply the thermal interface material (thermal grease) to the top of the CPU. This thermal grease should come with the CPU package.
7. Repeat steps 1 to 6 if you wish to install a second CPU.

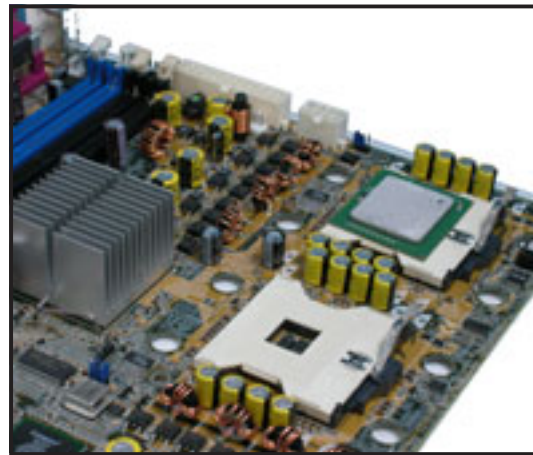

## 2.3.2 Installing the CPU heatsink and fan

The Intel® Xeon™ processors require an Intel® certified heatsink and fan assembly to ensure optimum thermal condition and performance.

When you buy a boxed Intel® CPU, the package includes the heatsink, fan, retention brackets, screws, thermal grease, installation manual, and other items that are necessary for CPU installation.



- Make sure that you have applied the thermal grease to the top of the CPU before installing the heatsink and fan.
- Refer to the installation manual that came with the CPU package for details on heatsink/fan assembly and installation.

**CPU heatsink (top view)**

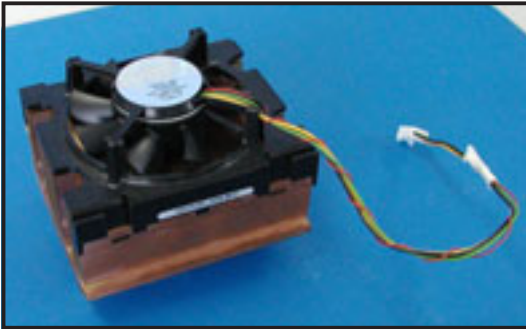

**CPU heatsink (bottom view)**

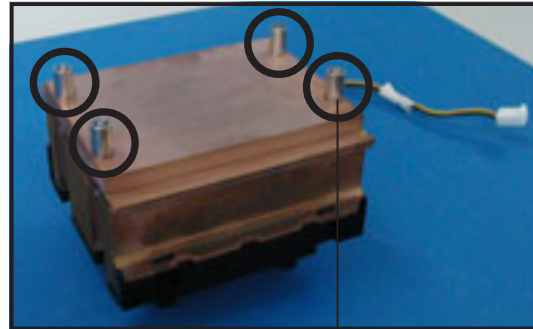

**Heatsink screw**



Before installing the CPU heatsinks, ensure that the jumpers FM\_CPU1 and FM\_CPU2 are set correctly depending on the pin definition of your CPU fan cables. Refer to page 2-19 for information on these jumpers.

To install the CPU heatsink and fan:

1. Place the heatsink on top of the installed CPU, making sure that the four screws on the heatsink align with the nuts on the support plate.

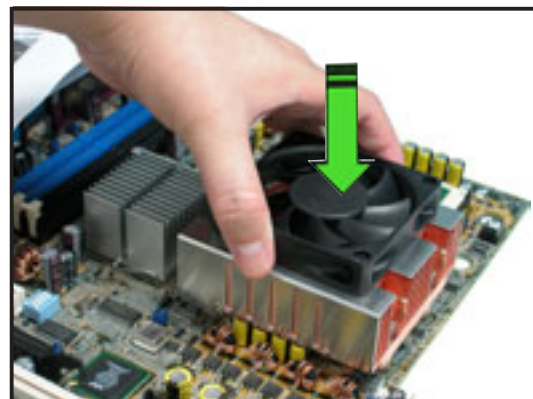

2. Use a Phillips screwdriver to tighten the four heatsink screws in a diagonal sequence.

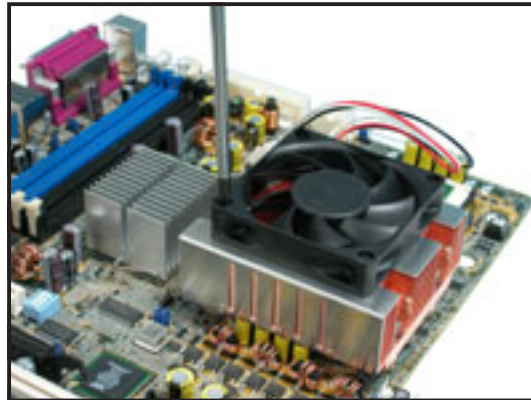

3. Connect the fan cable to the 4-pin connector labeled CPU\_FAN1.



Do not forget to connect the CPU fan connector! Hardware monitoring errors may occur if you fail to plug this connector.

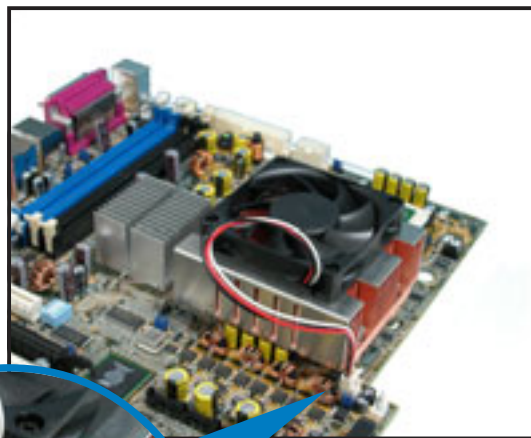

4. Repeat steps 1 to 3 to install the other heatsink if you have installed a second CPU, then connect the fan cable to the 4-pin connector labeled CPU\_FAN2.  
The heatsinks appear as shown when installed.

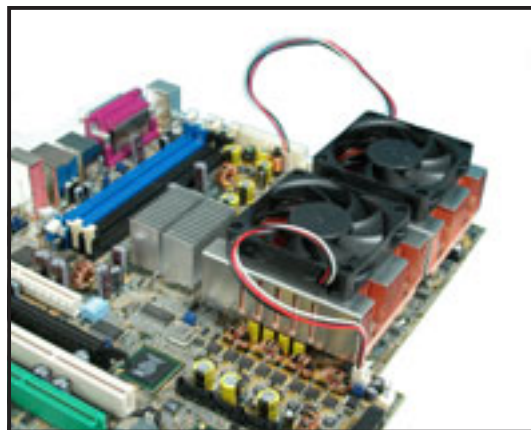

## 2.4 System memory

### 2.4.1 Overview

The motherboard comes with four Double Data Rate 2 (DDR2) Dual Inline Memory Modules (DIMM) sockets.

A DDR2 module has the same physical dimensions as a DDR DIMM but has a 240-pin footprint. DDR2 DIMMs are notched to match the break on the socket and ensure correct installation.

The figure illustrates the location of the DDR2 DIMM sockets:

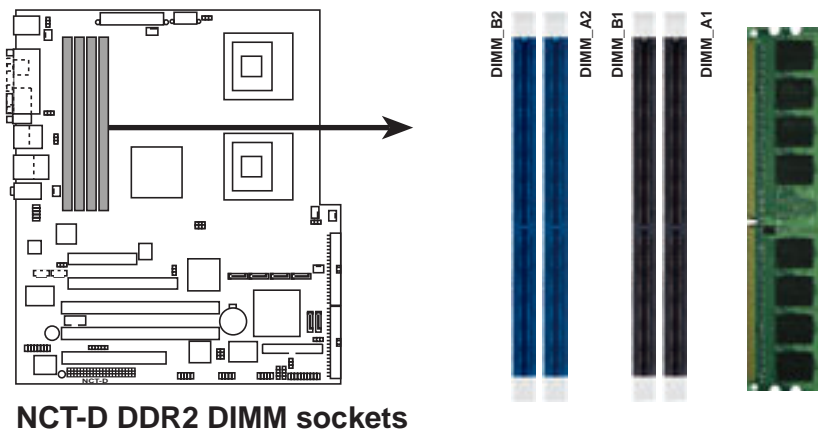

### 2.4.2 Memory configurations

You may install 256 MB, 512 MB and 1 GB registered ECC DDR2 DIMMs into the DIMM sockets.



- Always install DIMMs with the same CAS latency. For optimum compatibility, it is recommended that you obtain memory modules from the same vendor. Refer to the DDR2 Qualified Vendors List on the ASUS website ([www.asus.com](http://www.asus.com)) for details.
- This motherboard does not support memory modules made up of 128 Mb chips or double sided x16 memory modules.

## 2.4.3 Installing a DIMM



Unplug the power supply before adding or removing DIMMs or other system components. Failure to do so can cause severe damage to both the motherboard and the components.

To install a DIMM:

1. Unlock a DIMM socket by pressing the retaining clips outward.
2. Align a DIMM on the socket such that the notch on the DIMM matches the break on the socket.
3. Firmly insert the DIMM into the socket until the retaining clips snap back in place and the DIMM is properly seated.

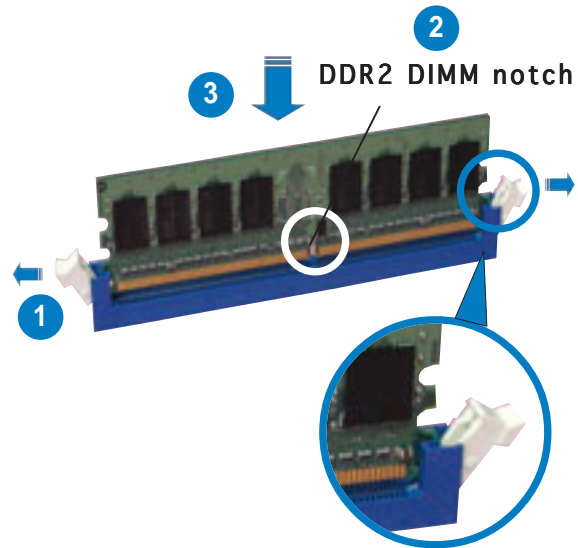

Unlocked retaining clip



- A DDR2 DIMM is keyed with a notch so that it fits in only one direction. Do not force a DIMM into a socket to avoid damaging the DIMM.
- The DDR2 DIMM sockets do not support DDR DIMMs. DO NOT install DDR DIMMs to the DDR2 DIMM sockets.

## 2.4.4 Removing a DIMM

Follow these steps to remove a DIMM.

1. Simultaneously press the retaining clips outward to unlock the DIMM.



Support the DIMM lightly with your fingers when pressing the retaining clips. The DIMM might get damaged when it flips out with extra force.

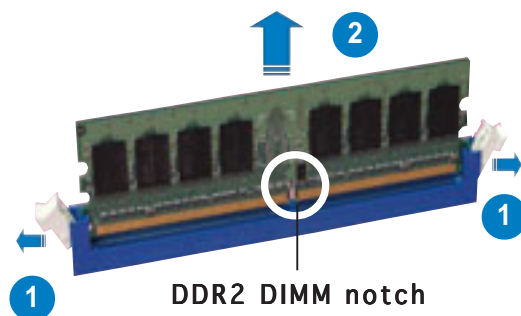

2. Remove the DIMM from the socket.



## 2.5 Expansion slots

In the future, you may need to install expansion cards. The following sub-sections describe the slots and the expansion cards that they support.



---

Make sure to unplug the power cord before adding or removing expansion cards. Failure to do so may cause you physical injury and damage motherboard components.

---

### 2.5.1 Installing an expansion card

To install an expansion card:

1. Before installing the expansion card, read the documentation that came with it and make the necessary hardware settings for the card.
2. Remove the system unit cover (if your motherboard is already installed in a chassis).
3. Remove the bracket opposite the slot that you intend to use. Keep the screw for later use.
4. Align the card connector with the slot and press firmly until the card is completely seated on the slot.
5. Secure the card to the chassis with the screw you removed earlier.
6. Replace the system cover.

### 2.5.2 Configuring an expansion card

After installing the expansion card, configure the it by adjusting the software settings.

1. Turn on the system and change the necessary BIOS settings, if any. See Chapter 4 for information on BIOS setup.
2. Assign an IRQ to the card. Refer to the tables on the next page.
3. Install the software drivers for the expansion card.



---

When using PCI cards on shared slots, ensure that the drivers support “Share IRQ” or that the cards do not need IRQ assignments. Otherwise, conflicts will arise between the two PCI groups, making the system unstable and the card inoperable.

---

## 2.5.3 Interrupt assignments

### Standard interrupt assignments

IRQ	Priority	Standard Function
0	1	System Timer
1	2	Keyboard Controller
2	—	Re-direct to IRQ#9
3	11	Communications Port (COM2)*
4	12	Communications Port (COM1)*
5	13	IRQ holder for PCI steering*
6	14	Floppy Disk Controller
7	15	Printer Port (LPT1)*
8	3	System CMOS/Real Time Clock
9	4	IRQ holder for PCI steering*
10	5	IRQ holder for PCI steering*
11	6	IRQ holder for PCI steering*
12	7	PS/2 Compatible Mouse Port*
13	8	Numeric Data Processor
14	9	Primary IDE Channel
15	10	Secondary IDE Channel

\* These IRQs are usually available for ISA or PCI devices.

## 2.5.4 PCI/PCI-X slots

The PCI/PCI-X slots support cards such as a LAN card, SCSI card, USB card, and other cards that comply with PCI 2.3 and PCI-X 1.0a specifications. The figure shows a LAN card installed on a PCI slot.

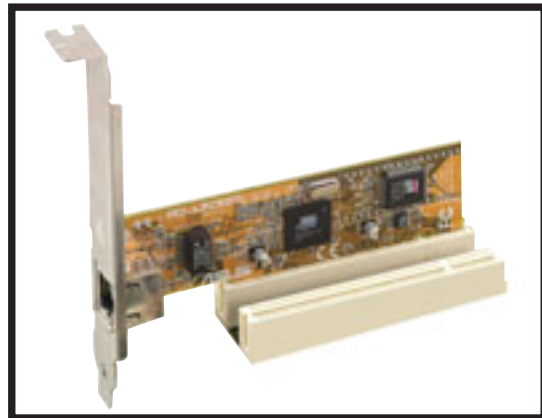

## 2.5.5 PCI Express™ x8/x16 slots

This motherboard supports PCI Express™ x16 graphic cards that comply with the PCI Express™ specifications. The following figure shows a graphics card installed on the PCI Express™ x16 slot.

The onboard PCI Express™ x8 slot provides x4 link to the MCH. This slot is designed for various server class high performance add-on cards like SCSI RAID card, fiber-channel card, etc.

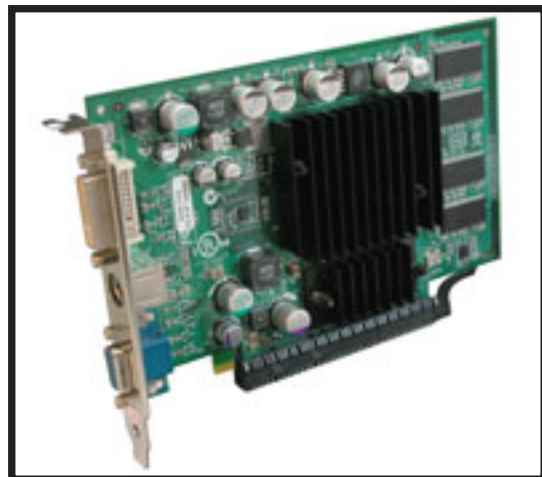

## 2.5.6 Wi-Fi slot

The Wi-Fi (Wireless Fidelity) slot supports the ASUS WiFi-b module. Visit the ASUS website ([www.asus.com](http://www.asus.com)) for product details.

The Wi-Fi slot conforms to the Institute of Electrical and Electronics Engineers (IEEE) 802.11b standard for wireless devices operating in the 2.4 GHz frequency band.

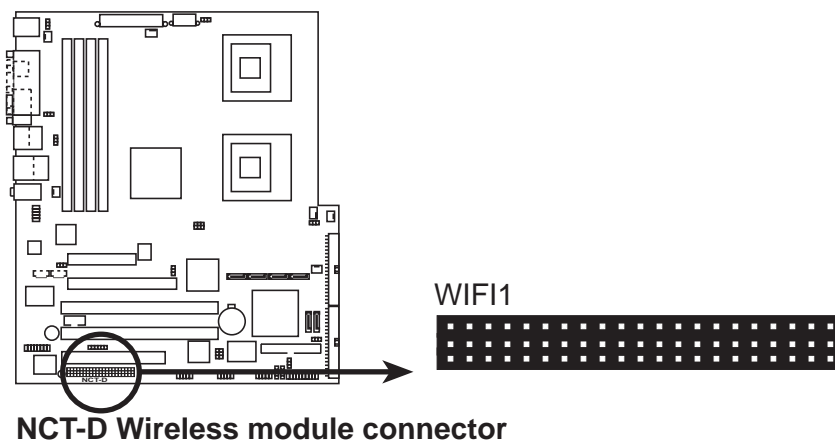



## 2.6 Jumpers

### 1. Clear RTC RAM (CLRTC1)

This jumper allows you to clear the Real Time Clock (RTC) RAM in CMOS. You can clear the CMOS memory of date, time, and system setup parameters by erasing the CMOS RTC RAM data. The onboard button cell battery powers the RAM data in CMOS, which include system setup information such as system passwords.

To erase the RTC RAM:

1. Turn OFF the computer and unplug the power cord.
2. Remove the onboard battery.
3. Move the jumper cap from pins 1-2 (default) to pins 2-3. Keep the cap on pins 2-3 for about 5~10 seconds, then move the cap back to pins 1-2.
4. Re-install the battery.
5. Plug the power cord and turn ON the computer.
6. Hold down the <Del> key during the boot process and enter BIOS setup to re-enter data.



---

Except when clearing the RTC RAM, never remove the cap on CLRTC1 jumper default position. Removing the cap will cause system boot failure!

---

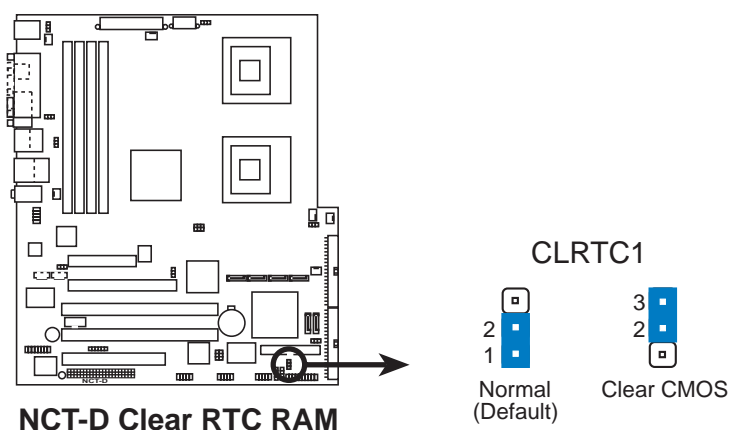

---

You do not need to clear the RTC when the system hangs due to overclocking. For system failure due to overclocking, use the C.P.R. (CPU Parameter Recall) feature. Shut down and reboot the system so the BIOS can automatically reset parameter settings to default values.

---

## 2. CPU fan pin selection (3-pin FM\_CPU1, FM\_CPU2)

These jumpers allow you to connect either a 3-pin or a 4-pin fan cable plug to the CPU fan connectors (CPU\_FAN1, CPU\_FAN2). Set these jumpers to pins 1-2 if you are using a 3-pin fan cable plug, or to pins 2-3 if you are using a 4-pin plug.

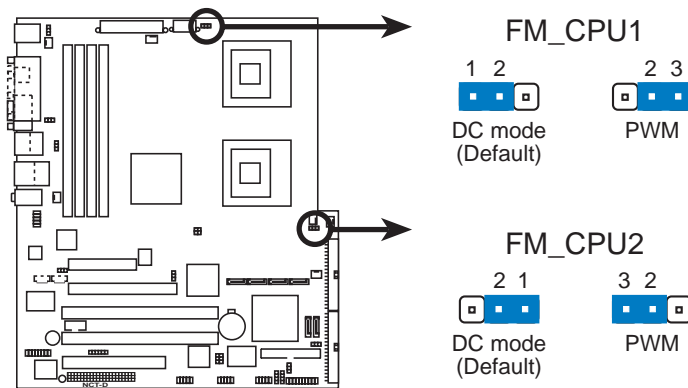

NCT-D FM\_CPU Setting

## 3. USB device wake-up (3-pin USBPW12, USBPW34)

Set these jumpers to +5V to wake up the computer from S1 sleep mode (CPU stopped, DRAM refreshed, system running in low power mode) using the connected USB devices. Set to +5VSB to wake up from S3 and S4 sleep modes (no power to CPU, DRAM in slow refresh, power supply in reduced power mode).

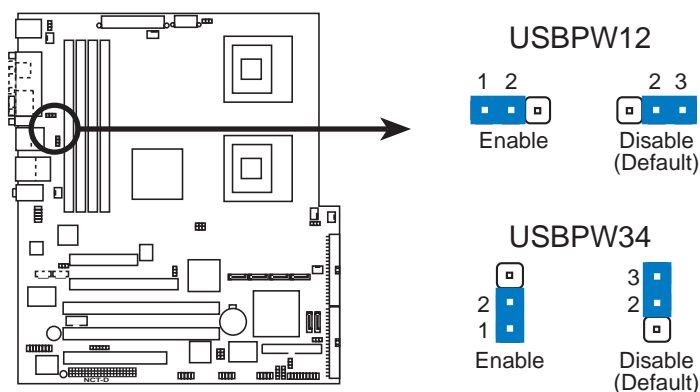

NCT-D USB device wake up



- The USB device wake-up feature requires a power supply that can provide 500mA on the +5VSB lead for each USB port; otherwise, the system would not power up.
- The total current consumed must NOT exceed the power supply capability (+5VSB) whether under normal condition or in sleep mode.

#### 4. Keyboard power (3-pin KBPWR1)

This jumper allows you to enable or disable the keyboard wake-up feature. Set this jumper to pins 2-3 (+5VSB) to wake up the computer when you press a key on the keyboard (the default is the Space Bar). This feature requires an ATX power supply that can supply at least 1A on the +5VSB lead, and a corresponding setting in the BIOS.

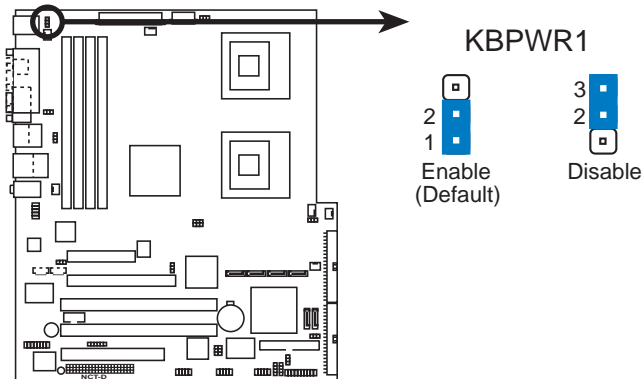

**NCT-D Keyboard power setting**

#### 5. IEEE 1394 controller setting (3-pin 1394\_EN1)

These jumpers allow you to enable or disable the onboard TI TBS43AB22A PCI IEEE 1394a controller. Set to pins 1-2 to activate the 1394 feature.

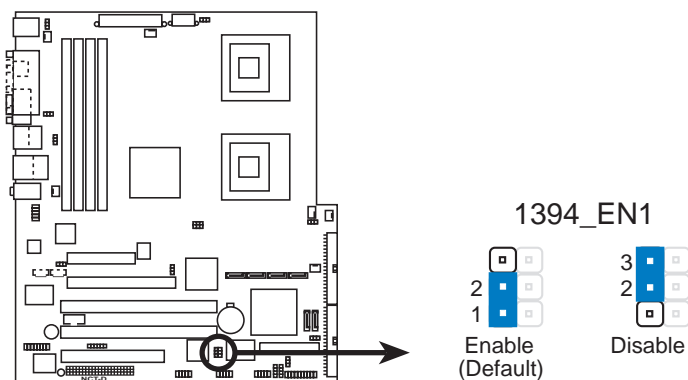

**NCT-D 1394 Function setting**

## 6. Gigabit LAN controller setting (3-pin LAN\_EN1)

These jumpers allow you to enable or disable the onboard Broadcom BCM5751 Gigabit LAN controller. Set to pins 1-2 to activate the Gigabit LAN feature.

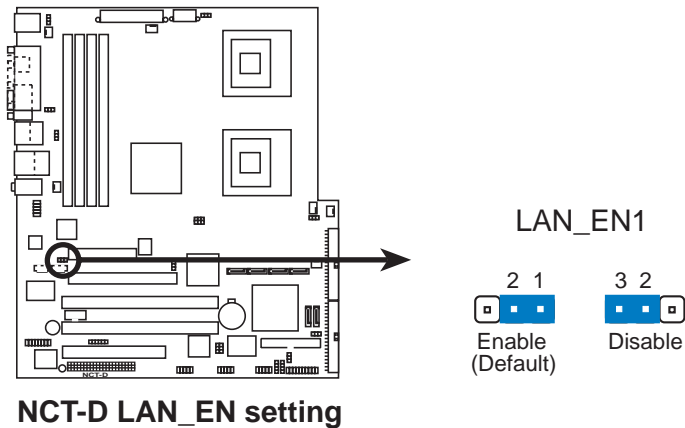

## 7. SATA controller setting (3-pin SATA\_EN1)

These jumpers allow you to enable or disable the onboard Adaptec AIC-8130 SATA RAID controller. Set to pins 1-2 to activate the SATA RAID feature.

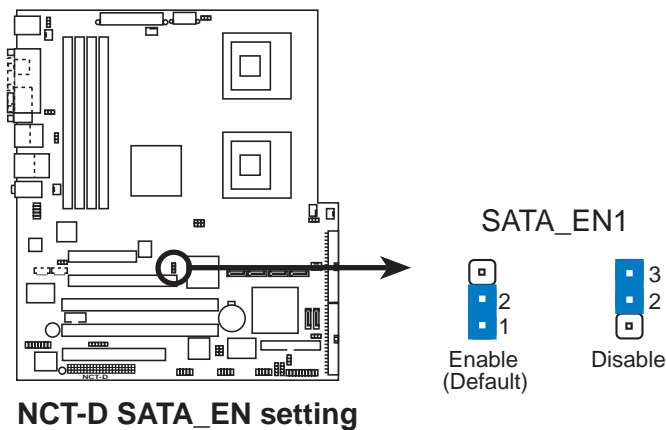

## 8. USB controller setting (3-pin USB\_EN1)

These jumpers allow you to enable or disable the onboard VIA VT6212 PCI USB 2.0 controller. Set to pins 1-2 to activate the USB feature.

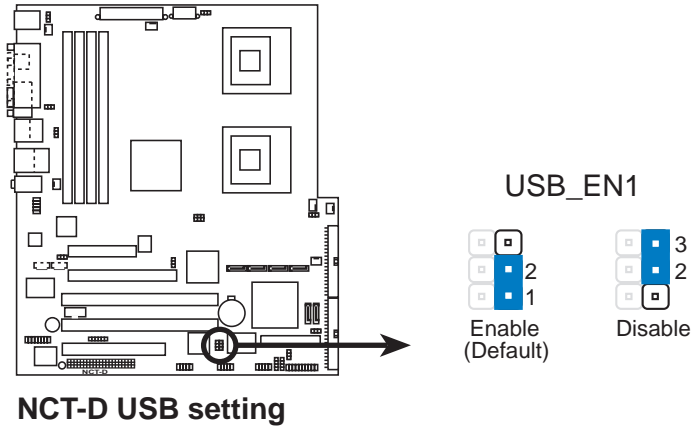

## 2.7 Connectors

### 2.7.1 Rear panel connectors

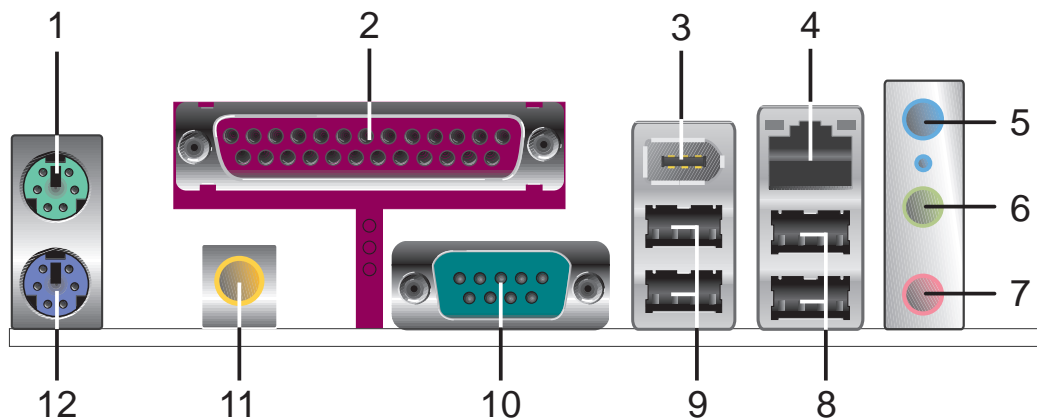

1. **PS/2 mouse port (green).** This port is for a PS/2 mouse.
2. **Parallel port.** This 25-pin port connects a parallel printer, a scanner, or other devices.
3. **IEEE 1394a port.** This 6-pin IEEE 1394a port provides high-speed connectivity for audio/video devices, storage peripherals, PCs, or portable devices.
4. **LAN (RJ-45) port.** This port allows Gigabit connection to a Local Area Network (LAN) through a network hub. Refer to the table below for the LAN port LED indications.

#### LAN port LED indications

ACT/LINK LED		SPEED LED	
Status	Description	Status	Description
OFF	No link	OFF	10 Mbps connection
GREEN	Linked	ORANGE	100 Mbps connection
BLINKING	Data activity	GREEN	1 Gbps connection

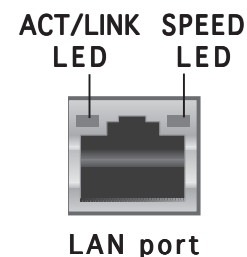

5. **Line In port (light blue).** This port connects a tape, CD, DVD player, or other audio sources.
6. **Line Out port (lime).** This port connects a headphone or a speaker. In 4-channel, 6-channel, and 8-channel configuration, the function of this port becomes Front Speaker Out.
7. **Microphone port (pink).** This port connects a microphone.



Refer to the audio configuration table on the next page for the function of the audio ports in 2/4/6-channel configurations.

## Audio 2/4/6-channel configurations

Port	2-channel (Headset)	4-channel	6-channel
Light Blue	Line In	Line In	Bass/Center
Lime	Line Out	Front Speaker Out	Front Speaker Out
Pink	Mic In	Rear Speaker Out	Rear Speaker Out

8. **USB 2.0 ports 3 and 4.** These two 4-pin Universal Serial Bus (USB) ports are available for connecting USB 2.0 devices.
9. **USB 2.0 ports 1 and 2.** These two 4-pin Universal Serial Bus (USB) ports are available for connecting USB 2.0 devices.
10. **Serial (COM1) port.** This 9-pin communication port is for pointing devices or other serial devices.
11. **Coaxial S/PDIF Out port.** This port connects an external audio output device via a coaxial S/PDIF cable.
12. **PS/2 keyboard port (purple).** This port is for a PS/2 keyboard.

## 2.7.2 Internal connectors

### 1. Floppy disk drive connector (34-1 pin FLOPPY)

This connector is for the provided floppy disk drive (FDD) signal cable. Insert one end of the cable to this connector, then connect the other end to the signal connector at the back of the floppy disk drive.



Pin 5 on the connector is removed to prevent incorrect cable connection when using a FDD cable with a covered Pin 5.

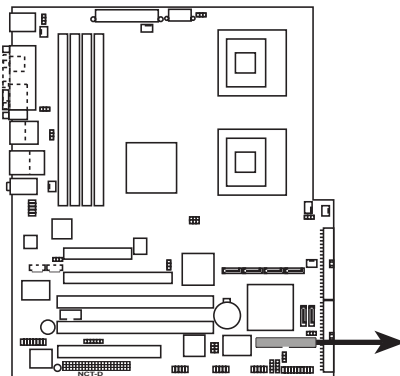

FLOPPY

PIN 1

**NOTE:** Orient the red markings on the floppy ribbon cable to PIN 1.

NCT-D Floppy disk drive connector

### 2. Primary IDE connector (40-1 pin PRI\_IDE, SEC\_IDE)

This connector is for an Ultra DMA 100/66 signal cable. The Ultra DMA 100/66 signal cable has three connectors: a blue connector for the primary IDE connector on the motherboard, a black connector for an Ultra DMA 100/66 IDE slave device (optical drive/hard disk drive), and a gray connector for an Ultra DMA 100/66 IDE master device (hard disk drive). If you install two hard disk drives, you must configure the second drive as a slave device by setting its jumper accordingly. Refer to the hard disk documentation for the jumper settings.



- Pin 20 on the IDE connector is removed to match the covered hole on the Ultra DMA cable connector. This prevents incorrect insertion when you connect the IDE cable.
- Use the 80-conductor IDE cable for Ultra DMA 100/66 IDE devices.

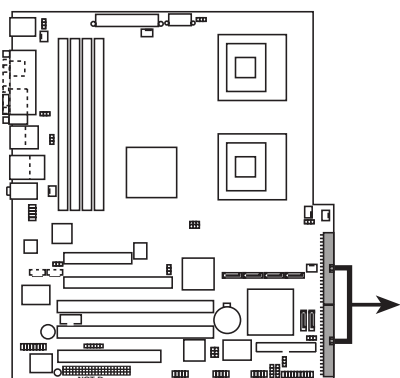

NCT-D IDE connectors

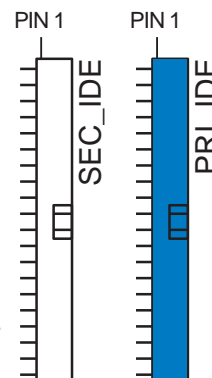

**NOTE:** Orient the red markings (usually zigzag) on the IDE ribbon cable to PIN 1.



### 3. Serial ATA connectors (7-pin SATA1, SATA2)

These connectors are for the Serial ATA signal cables for Serial ATA hard disk drives.

If you installed Serial ATA hard disk drives, you can create a RAID 0 or RAID 1 configuration using the Adaptec® HostRAID™ technology embedded in the Intel® 6300ESB chip.



These connectors are set to **Standard IDE** mode by default. In **Standard IDE** mode, you can connect Serial ATA boot/data hard disk drives to these connectors. If you intend to create a Serial ATA RAID set using these connectors, set the **Configure SATA As** item in the BIOS to [RAID]. See section “4.3.6 IDE Configuration” on page 4-16 for details.

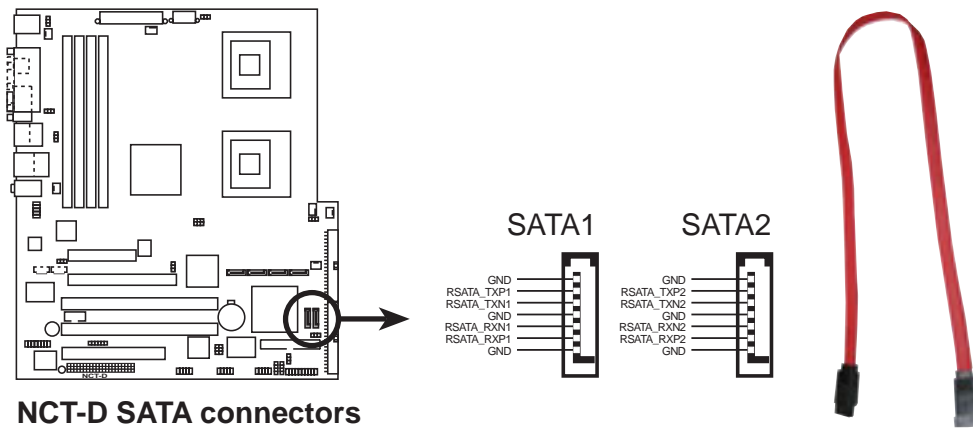

**NCT-D SATA connectors**



#### Important notes on Serial ATA

- You must install Windows® 2000 Service Pack 4 or the Windows® XP Service Pack 1 before using Serial ATA hard disk drives. The Serial ATA RAID feature (RAID 0/RAID 1) is available only if you are using Windows® 2000/XP.
- Use only two Serial ATA RAID connectors for each RAID 0 or RAID 1 set.
- When using the connectors in **Standard IDE** mode, connect the primary (boot) hard disk drive to the SATA1 or SATA2 connector. Refer to the table below for the recommended SATA hard disk drive connections.

#### Serial ATA hard disk drive connection

Connector	Setting	Use
SATA1	Master	Boot disk
SATA2	Slave	Data disk

#### 4. Serial ATA RAID connectors (7-pin SATA\_RAID1, SATA\_RAID2, SATA\_RAID3, SATA\_RAID4)

These connectors are for Serial ATA signal cables. These connectors support up to four Serial ATA hard disk drives that you can configure as a disk array through the optional SATA RAID controller.

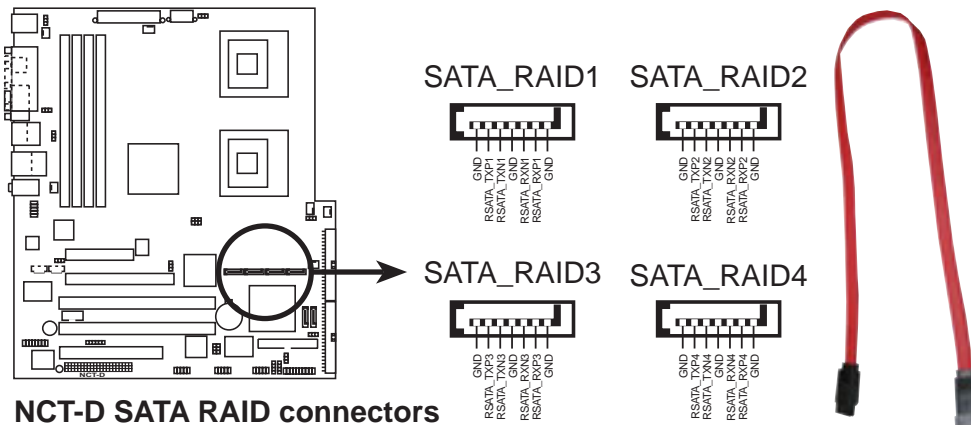

**NCT-D SATA RAID connectors**



Before creating a RAID set using Serial ATA hard disks, make sure that you have connected the Serial ATA signal cable and installed Serial ATA hard disk drives; otherwise, you cannot enter the RAID utility and SATA BIOS setup during POST.

#### 5. Hard disk activity LED connector (2-pin HDLED)

This connector supplies power to the hard disk activity LED. The read or write activities of any device connected to the primary/secondary IDE connectors or the SATA connectors cause this LED to light up.

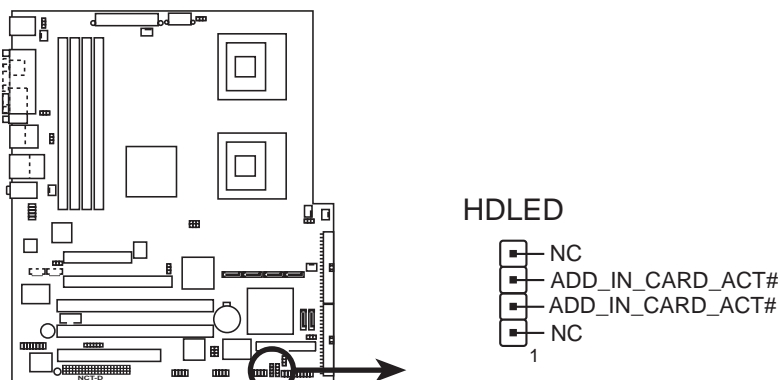

**NCT-D SCSI/SATA card activity LED connector**

## 6. Internal audio connectors (4-pin CD1, AUX1)

These connectors allow you to receive stereo audio input from sound sources such as CD-ROM, TV tuner, or MPEG card.

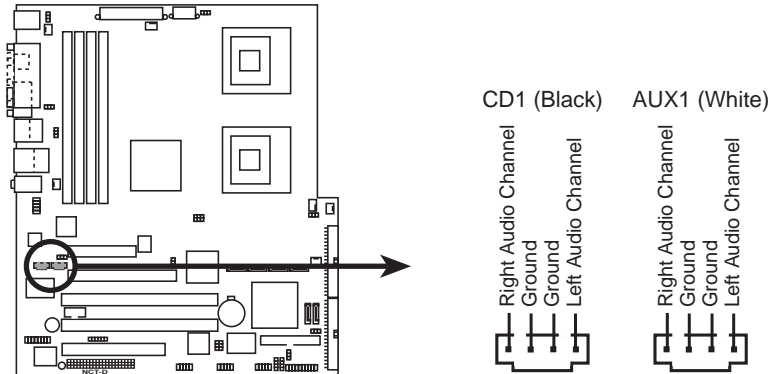

**NCT-D Internal audio connectors**

## 7. Chassis intrusion connector (4-1 pin CHASSIS1)

This connector is for a chassis-mounted intrusion detection sensor or switch. Connect one end of the chassis intrusion sensor or switch cable to this connector. The chassis intrusion sensor or switch sends a high-level signal to this connector when a chassis component is removed or replaced. The signal is then generated as a chassis intrusion event.

By default, the pins labeled “Chassis Signal” and “Ground” are shorted with a jumper cap. Remove the jumper caps only when you intend to use the chassis intrusion detection feature.

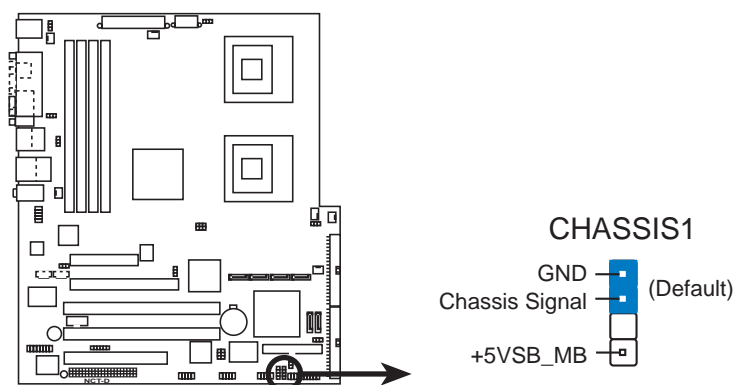

**NCT-D Chassis intrusion connector**

## 8. Front panel audio connector (10-1 pin FP\_AUDIO1)

This connector is for a chassis-mounted front panel audio I/O module that supports AC'97 audio specifications.

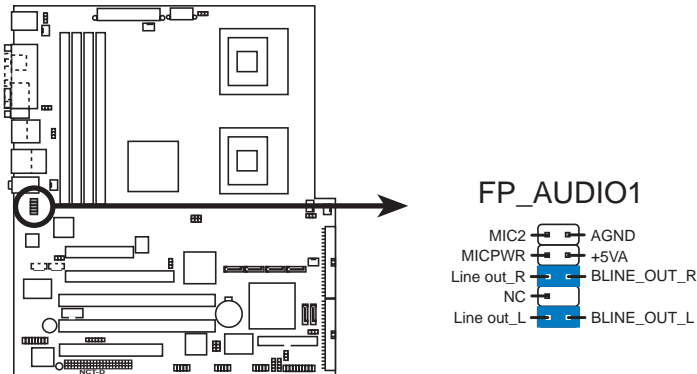

**NCT-D Front panel audio connector**

## 9. CPU and system fan connectors (3-pin CPU\_FAN1/2, REAR\_FAN1/2, FRNT\_FAN1/2)

The fan connectors support cooling fans of 350 mA ~ 740 mA (8.88 W max.) or a total of 2.1 A ~ 4.44 A (53.28 W max.) at +12V. Connect the fan cables to the fan connectors on the motherboard, making sure that the black wire of each cable matches the ground pin of the connector.



Do not forget to connect the fan cables to the fan connectors. Insufficient air flow inside the system may damage the motherboard components. These are not jumpers! Do not place jumper caps on the fan connectors!

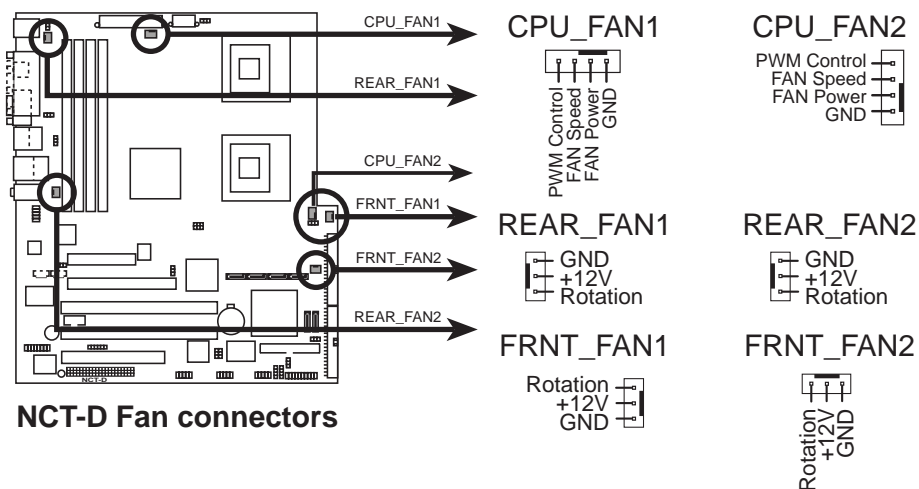

**NCT-D Fan connectors**

## 10. IEEE 1394a port connector (10-1 pin IE1394\_2)

This connector is for an IEEE 1394 port. Connect the IEEE 1394 module cable to this connector, then install the module to a slot opening at the back of the system chassis.

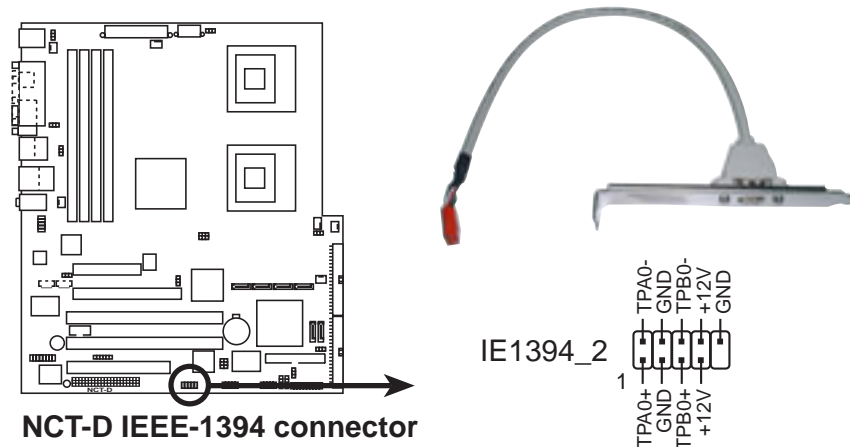

Never connect a **USB cable** to the IEEE 1394a connectors. Doing so will damage the motherboard!

## 11. USB connectors (10-1 pin USB56, USB78)

These connectors are for USB 2.0 ports. Connect the USB/GAME module cable to any of these connectors, then install the module to a slot opening at the back of the system chassis. These USB connectors comply with USB 2.0 specification that supports up to 480 Mbps connection speed.

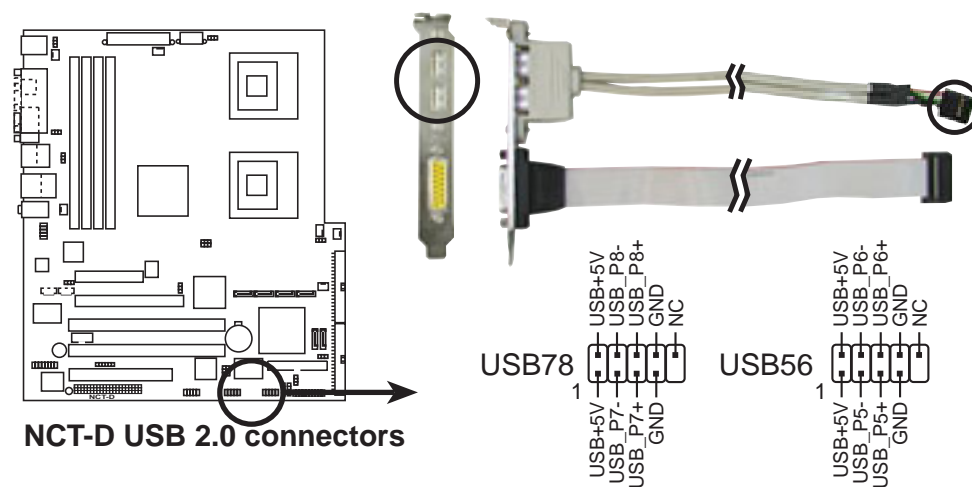

Never connect a **1394 cable** to the USB connectors. Doing so will damage the motherboard!

## 12. SSI power connectors (24-pin EATXPWR1, 8-pin SSI+12V\_1, SSI+12V\_2 )

These connectors are for SSI power supply plugs. The power supply plugs are designed to fit these connectors in only one orientation. Find the proper orientation and push down firmly until the connectors completely fit.



- Use of an SSI 12 V Specification 2.0-compliant power supply unit (PSU) that provides a minimum power of 450 W is recommended for a fully-configured system.
- Do not forget to connect the 8-pin ATX +12 V power plug; otherwise, the system will not boot up.
- Use of a PSU with a higher power output is recommended when configuring a system with more power consuming devices. The system may become unstable or may not boot up if the power is inadequate.
- You must install a PSU with a higher power rating if you intend to install additional devices.

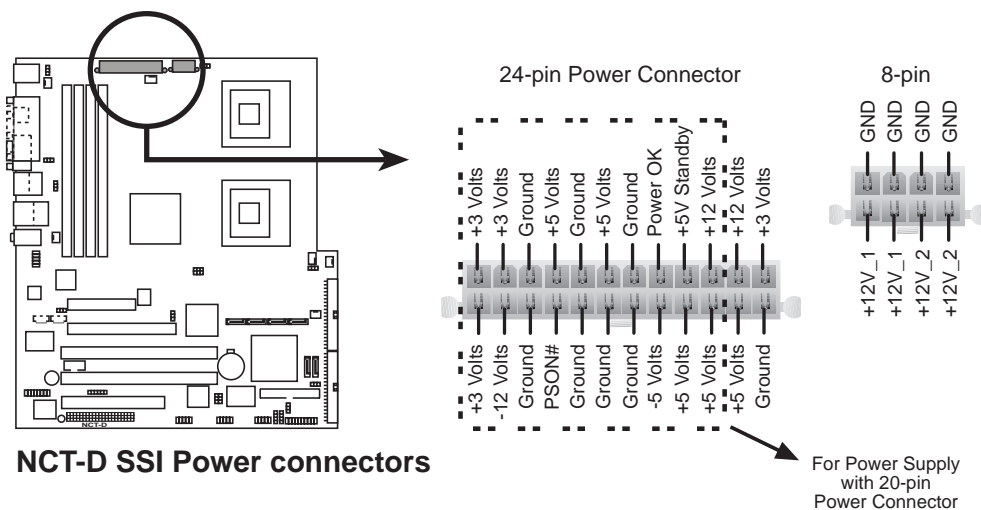

### 13. Serial port connector (10-1 pin COM2)

This connector is for a serial (COM) port. Connect the serial port module cable to this connector, then install the module to a slot opening at the back of the system chassis.

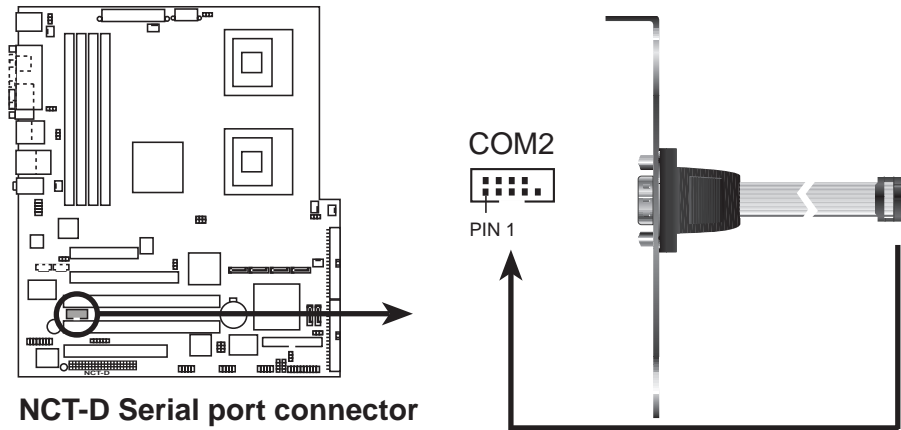

### 14. GAME/MIDI port connector (16-1 pin GAME1)

This connector is for a GAME/MIDI port. Connect the USB/GAME module cable to this connector, then install the module to a slot opening at the back of the system chassis. The GAME/MIDI port connects a joystick or game pad for playing games, and MIDI devices for playing or editing audio files.

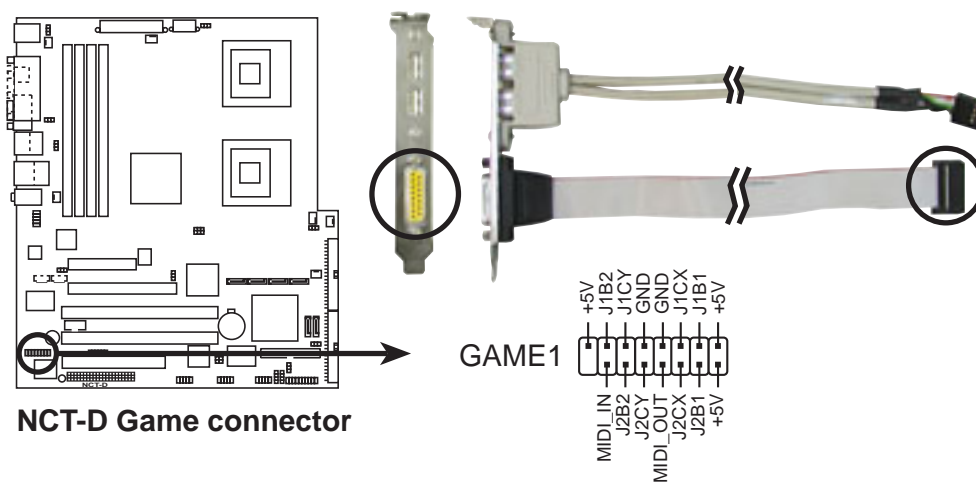

## 15. Backplane SMBus connector (6-1 pin BPSMB1)

This connector allows you to connect SMBus (System Management Bus) devices. Devices communicate with an SMBus host and/or other SMBus devices using the SMBus interface.

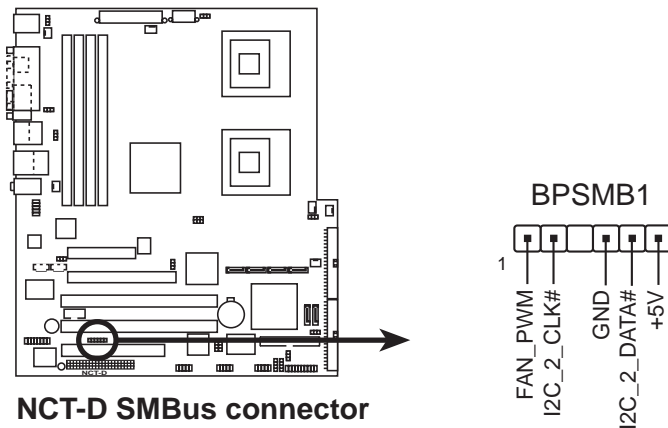

## 16. System panel connector (20-pin PANEL1)

This connector supports several chassis-mounted functions.

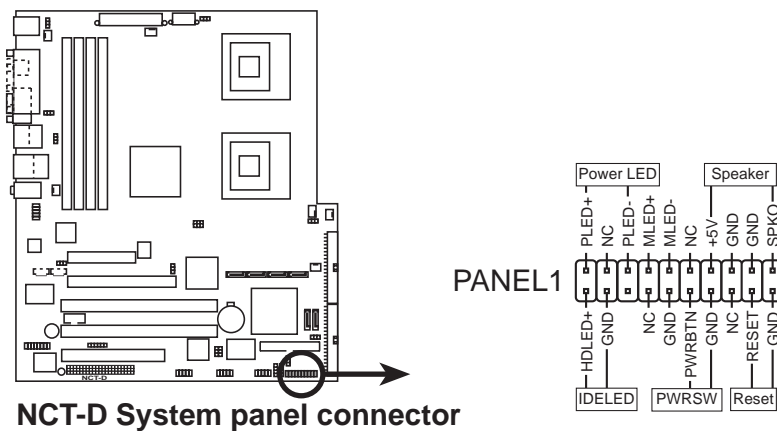

The system panel connector is color-coded for easy connection. Refer to the connector descriptions on the next page for details.

- **System power LED (Green 3-pin PLED)**  
This 3-pin connector is for the system power LED. Connect the chassis power LED cable to this connector. The system power LED lights up when you turn on the system power, and blinks when the system is in sleep mode.



- **Hard disk drive activity LED (Red 2-pin IDE\_LED)**  
This 2-pin connector is for the HDD Activity LED. Connect the HDD Activity LED cable to this connector. The IDE LED lights up or flashes when data is read from or written to the HDD.
- **System warning speaker (Orange 4-pin SPEAKER)**  
This 4-pin connector is for the chassis-mounted system warning speaker. The speaker allows you to hear system beeps and warnings.
- **ATX power button/soft-off button (Yellow 2-pin PWRSW)**  
This connector is for the system power button. Pressing the power button turns the system on or puts the system in sleep or soft-off mode depending on the BIOS settings. Pressing the power switch for more than four seconds while the system is ON turns the system OFF.
- **Reset button (Blue 2-pin RESET)**  
This 2-pin connector is for the chassis-mounted reset button for system reboot without turning off the system power.



This chapter describes the power up sequence, the vocal POST messages, and ways of shutting down the system.

# Powering up

## Chapter summary

# 3

3.1	Starting up for the first time .....	3-1
3.2	Powering off the computer .....	3-2
3.3	ASUS POST Reporter™ .....	3-3

## 3.1 Starting up for the first time

1. After making all the connections, replace the system case cover.
2. Be sure that all switches are off.
3. Connect the power cord to the power connector at the back of the system chassis.
4. Connect the power cord to a power outlet that is equipped with a surge protector.
5. Turn on the devices in the following order:
  - a. Monitor
  - b. External SCSI devices (starting with the last device on the chain)
  - c. System power
6. After applying power, the system power LED on the system front panel case lights up. For systems with ATX power supplies, the system LED lights up when you press the ATX power button. If your monitor complies with “green” standards or if it has a “power standby” feature, the monitor LED may light up or switch between orange and green after the system LED turns on.

The system then runs the power-on self tests or POST. While the tests are running, the BIOS beeps (see BIOS beep codes table below) or additional messages appear on the screen. If you do not see anything within 30 seconds from the time you turned on the power, the system may have failed a power-on test. Check the jumper settings and connections or call your retailer for assistance.

### AMI BIOS beep codes

Beep Description	Error
One beep	Keyboard controller error Refresh Time error No master drive detected
Two continuous beeps followed by two short beeps	Floppy controller failure
Two continuous beeps followed by four short beeps	Hardware component failure

7. At power on, hold down the <Delete> key to enter the BIOS Setup. Follow the instructions in Chapter 4.

## 3.2 Powering off the computer

### 3.2.1 Using the OS shut down function

If you are using Windows® 2000:

1. Click the **Start** button then click **Shut Down...**
2. Make sure that the **Shut Down** option button is selected, then click the **OK** button to shut down the computer.
3. The power supply should turn off after Windows® shuts down.

If you are using Windows® XP:

1. Click the **Start** button then select **Turn Off Computer.**
2. Click the **Turn Off** button to shut down the computer.
3. The power supply should turn off after Windows® shuts down.

### 3.2.2 Using the dual function power switch

While the system is ON, pressing the power switch for less than four seconds puts the system to sleep mode or to soft-off mode, depending on the BIOS setting. Pressing the power switch for more than four seconds lets the system enter the soft-off mode regardless of the BIOS setting. Refer to section “4.5 Power Menu” in Chapter 4 for details.

## 3.3 ASUS POST Reporter™

This motherboard includes the Winbond speech controller to support a special feature called the ASUS POST Reporter™. This feature lets you hear vocal messages during POST that alerts you of system events and boot status. In case of a boot failure, you will hear the specific cause of the problem.

These POST messages are customizable using the Winbond Voice Editor software that came with your package. You can record your own messages to replace the default messages.

### 3.3.1 Vocal POST messages

Following is a list of the default POST messages and the corresponding actions you can take:

POST Message	Action
System failed CPU test	<ul style="list-style-type: none"><li>• Check the CPU if properly installed.</li><li>• Call ASUS technical support for assistance. See the ASUS contact information on the inside front cover of this user guide.</li></ul>
System failed memory test	<ul style="list-style-type: none"><li>• Install supported DDR2 DIMMs into the memory sockets.</li><li>• Check if the DIMMs on the DIMM sockets are properly installed.</li><li>• Make sure that your DIMMs are not defective.</li><li>• Refer to section “2.4 System memory” for instructions on installing a DIMM.</li></ul>
System failed VGA test	<ul style="list-style-type: none"><li>• Install a PCI graphics card into one of the PCI slots, or a PCI Express AGP card into the PCI Express x16 slot.</li><li>• Make sure that your graphics card is not defective.</li></ul>
System failed due to CPU	<ul style="list-style-type: none"><li>• Check your CPU overclocking settings in the BIOS setup and restore the default CPU parameters.</li></ul>
No keyboard detected	<ul style="list-style-type: none"><li>• Check if your keyboard is properly connected to the purple PS/2 connector on the rear panel.</li><li>• See section “2.7.1 Rear panel connectors” for the location of the connector.</li></ul>
No IDE hard disk detected	<ul style="list-style-type: none"><li>• Make sure you have connected an IDE hard disk drive to one of the IDE connectors on the motherboard.</li></ul>

POST Message	Action
CPU temperature too high	<ul style="list-style-type: none"> <li>• Check if the CPU fan is working properly.</li> </ul>
CPU fan failed	<ul style="list-style-type: none"> <li>• Check the CPU fan and make sure it turns on after you apply power to the system.</li> <li>• Make sure that your CPU fan supports the fan speed detection function.</li> </ul>
CPU voltage out of range	<ul style="list-style-type: none"> <li>• Check your power supply and make sure it is not defective.</li> <li>• Call ASUS technical support for assistance. See the “ASUS contact information” on the inside front cover of this user guide.</li> </ul>
Computer now booting from operating system	<ul style="list-style-type: none"> <li>• No action required</li> </ul>



---

You can enable or disable the ASUS POST Reporter™ in the **Speech Configuration** option in the BIOS setup. See section 4.4.2 for details.

---



### 3.3.2 Winbond Voice Editor

The Winbond Voice Editor software allows you to customize the vocal POST messages. You can install this application from the support CD.



---

To avoid conflicts, do not run the Winbond Voice Editor while running the ASUS PC Probe application.

---

#### Launching the Voice Editor

You can launch the program from the Windows® desktop by clicking **Start > All Programs > Winbond Voice Editor > Voice Editor**.

The Winbond Voice Editor screen appears.

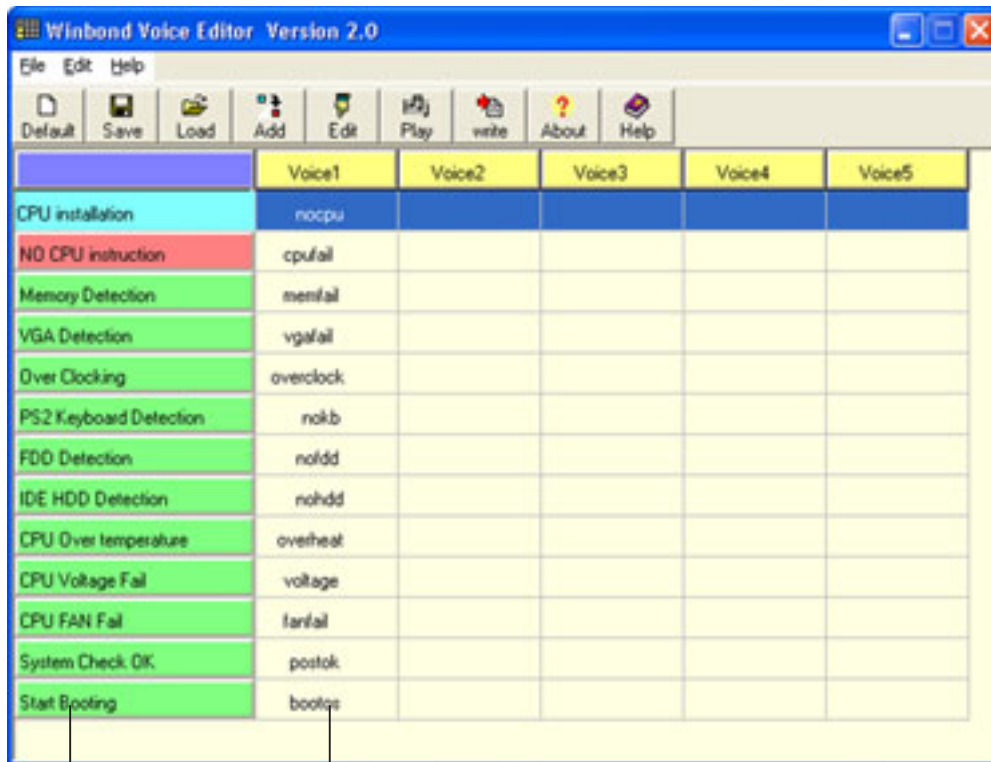

POST Events    Default Messages

#### Playing the default wave files

To play the default wave files, simply click on a POST event on the left side of the screen, then click the Play button.



---

The default language setting is English.

---

## Changing the default language

To change the default language:

1. Click the **Load** button from the Voice Editor main window. A window with the available languages appears.

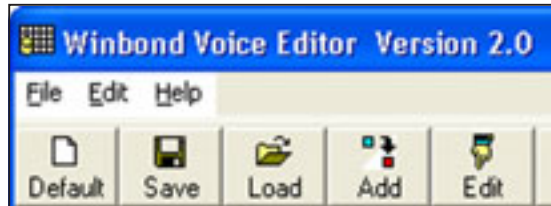

2. Select your desired language, then click **Open**.

The event messages for the language you selected appear on the Voice Editor main window.

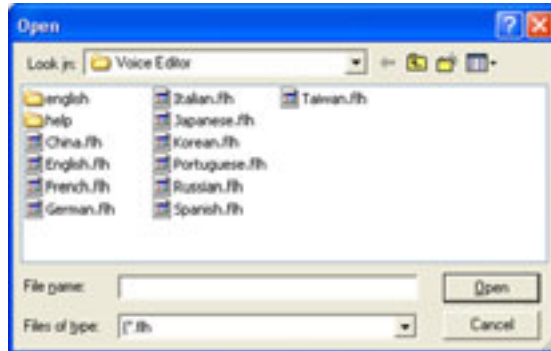

Not all events on some languages have a corresponding message due to file size constraints.

3. Click the **Write** button from the Voice Editor main window to update the EEPROM.
4. Click **Yes** to confirm.

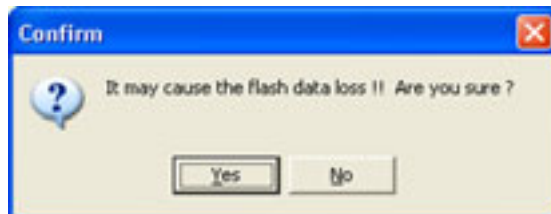

The next time you boot your computer, the ASUS Post Reporter announces the messages in the selected language.

## Customizing your POST messages

The Voice Editor application allows you to record your own POST messages if your language is not supported or if you wish to replace the pre-installed wave files.

To customize your POST messages.

1. Launch the Voice Editor application and note the list of POST events on the leftmost column of the screen.
2. Prepare your message for each event.
3. Use a recording software (e.g. Windows® Recorder) to record your messages, then save the messages as wave files (.WAV).



- The total compressed size for all the wave files must not exceed 1Mbit, so keep your messages as short as possible.
- To keep file sizes small, save your files at a low quality. For example, use 8-bit, mono quality at 22Khz sampling rate.
- Create a separate folder for your wave files so you can locate them easily.

4. From the Voice Editor screen, click the **Add** button to display the **Add Wave File** window.
5. Copy the wave files that you recorded to the database, then close the window when done.

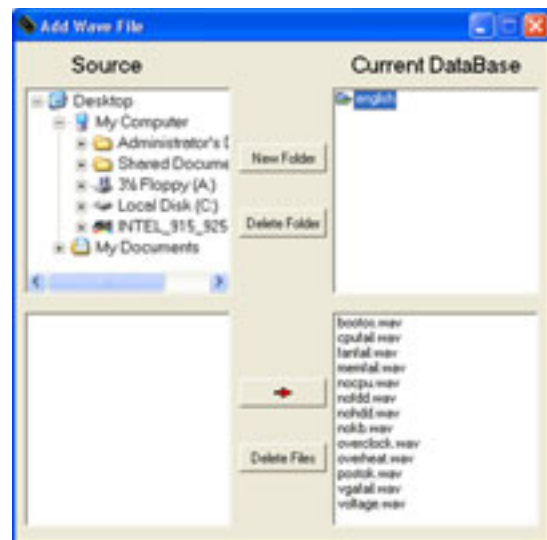

6. Select a POST event on the Voice Editor main window, then click the **Edit** button. The **Event Sound Editor** window appears.
7. Locate and select your wave file for the event, then click on the arrow opposite Voice1. The file you select appears on the space next to it.
8. Click **OK** to return to the Voice Editor main window.
9. Do steps 6 to 8 for the other events.



10. When done, click **Save**. A window appears prompting you to save your configuration.
11. Type a file name with an **.flh** extension, then click Save.

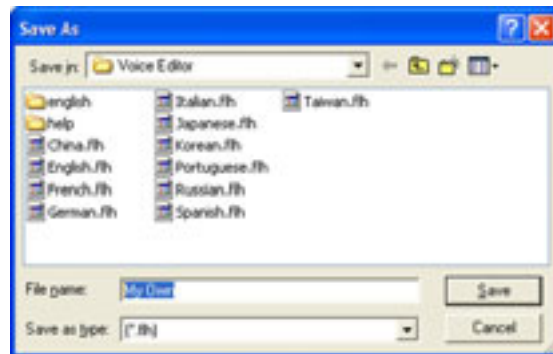

12. Click the **Write** button to compress the file and copy into the EEPROM.
13. Click **Yes** on the confirmation window that appears.

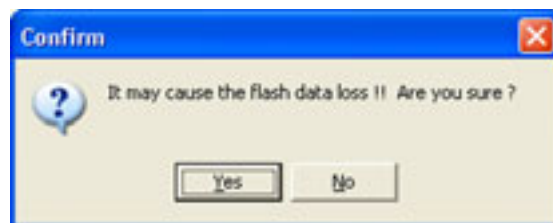

If you receive an error message telling you that the files exceed the total allowable size, do any or all of the following:

- Shorten your messages.
- Save the wave files at a lower quality
- Do not include seldom-used events like FDD Detection, IDE HDD Detection, etc.

This chapter tells how to change the system settings through the BIOS Setup menus. Detailed descriptions of the BIOS parameters are also provided.

# BIOS setup

4.1	Managing and updating your BIOS .....	4-1
4.2	BIOS setup program .....	4-11
4.3	Main menu .....	4-14
4.4	Advanced menu .....	4-18
4.5	Power menu .....	4-27
4.6	Boot menu .....	4-32
4.7	Exit menu .....	4-37

## 4.1 Managing and updating your BIOS

The following utilities allow you to manage and update the motherboard Basic Input/Output System (BIOS) setup.

1. **ASUS AFUDOS** (Updates the BIOS in DOS mode using a bootable floppy disk.)
2. **ASUS CrashFree BIOS 2** (Updates the BIOS using a bootable floppy disk or the motherboard support CD when the BIOS file fails or gets corrupted.)
3. **ASUS EZ Flash** (Updates the BIOS in DOS mode using a floppy disk or the motherboard support CD.)
4. **ASUS Update** (Updates the BIOS in Windows® environment.)

Refer to the corresponding sections for details on these utilities.



---

Save a copy of the original motherboard BIOS file to a bootable floppy disk in case you need to restore the BIOS in the future. Copy the original motherboard BIOS using the ASUS Update or AFUDOS utilities.

---

### 4.1.1 Creating a bootable floppy disk

1. Do either one of the following to create a bootable floppy disk.

#### DOS environment

- a. Insert a 1.44MB floppy disk into the drive.
- b. At the DOS prompt, type **format A:/S** then press <Enter>.

#### Windows® XP environment

- a. Insert a 1.44 MB floppy disk to the floppy disk drive.
- b. Click **Start** from the Windows® desktop, then select **My Computer**.
- c. Select the 3 1/2 Floppy Drive icon.
- d. Click **File** from the menu, then select **Format**. A **Format 3 1/2 Floppy Disk** window appears.
- e. **Windows® XP users:** Select **Create an MS-DOS startup disk** from the format options field, then click **Start**.

### Windows® 2000 environment

To create a set of boot disks for Windows® 2000:

- a. Insert a formatted, high density 1.44 MB floppy disk into the drive.
  - b. Insert the Windows® 2000 CD to the optical drive.
  - c. Click **Start**, then select **Run**.
  - d. In the **Open** field, type `D:\bootdisk\makeboot a:` assuming that D is your optical drive letter.
  - e. Press <Enter>, then follow screen instructions to continue.
2. Copy the original or the latest motherboard BIOS file to the bootable floppy disk.

## 4.1.2 AFUDOS utility

The AFUDOS utility allows you to update the BIOS file in DOS environment using a bootable floppy disk with the updated BIOS file. This utility also allows you to copy the current BIOS file that you can use as backup when the BIOS fails or gets corrupted during the updating process.

### Copying the current BIOS

To copy the current BIOS file using the AFUDOS utility:



- 
- Make sure that the floppy disk is not write-protected and has at least 600 KB free space to save the file.
  - The succeeding BIOS screens are for reference only. The actual BIOS screen displays may not be same as shown.
- 

1. Copy the AFUDOS utility (afudos.exe) from the motherboard support CD to the bootable floppy disk you created earlier.
2. Boot the system in DOS mode, then at the prompt type:

```
afudos /o[filename]
```

where the [filename] is any user-assigned filename not more than eight alphanumeric characters for the main filename and three alphanumeric characters for the extension name.

```
A:\>afudos /oOLDBIOS1 .rom
```

Main filename      Extension name



3. Press <Enter>. The utility copies the current BIOS file to the floppy disk.

```
A:\>afudos /oOLDBIOS1.rom
AMI Firmware Update Utility - Version 1.19(ASUS V2.07(03.11.24BB))
Copyright (C) 2002 American Megatrends, Inc. All rights reserved.
  Reading flash ..... done
  Write to file..... ok
A:\>
```

The utility returns to the DOS prompt after copying the current BIOS file.

## Updating the BIOS file

To update the BIOS file using the AFUDOS utility:

1. Visit the ASUS website ([www.asus.com](http://www.asus.com)) and download the latest BIOS file for the motherboard. Save the BIOS file to a bootable floppy disk.



---

Write the BIOS filename on a piece of paper. You need to type the exact BIOS filename at the DOS prompt.

---

2. Copy the AFUDOS utility (afudos.exe) from the motherboard support CD to the bootable floppy disk you created earlier.
3. Boot the system in DOS mode, then at the prompt type:

```
afudos /i[filename] /pbnc
```

where [filename] is the latest or the original BIOS file on the bootable floppy disk.

```
A:\>afudos /iNCTD.rom /pbnc
```

4. The utility verifies the file and starts updating the BIOS.

```
A:\>afudos /iNCTD.ROM /pbnc
AMI Firmware Update Utility - Version 1.19(ASUS V2.07(03.11.24BB))
Copyright (C) 2002 American Megatrends, Inc. All rights reserved.

WARNING!! Do not turn off power during flash BIOS
Reading file ..... done
Reading flash ..... done

Advance Check .....
Erasing flash ..... done
Writing flash ..... 0x0008CC00 (9%)
```



---

Do not shut down or reset the system while updating the BIOS to prevent system boot failure!

---

5. The utility returns to the DOS prompt after the BIOS update process is completed. Reboot the system from the hard disk drive.

```
A:\>afudos /iNCTD.ROM /pbnc
AMI Firmware Update Utility - Version 1.19(ASUS V2.07(03.11.24BB))
Copyright (C) 2002 American Megatrends, Inc. All rights reserved.

WARNING!! Do not turn off power during flash BIOS
Reading file ..... done
Reading flash ..... done

Advance Check .....
Erasing flash ..... done
Writing flash ..... done
Verifying flash .... done

Please restart your computer

A:\>
```

### 4.1.3 ASUS CrashFree BIOS 2 utility

The ASUS CrashFree BIOS 2 is an auto recovery tool that allows you to restore the BIOS file when it fails or gets corrupted during the updating process. You can update a corrupted BIOS file using the motherboard support CD or the floppy disk that contains the updated BIOS file.



- Prepare the motherboard support CD or the floppy disk containing the updated motherboard BIOS before using this utility.
- Make sure that you rename the original or updated BIOS file in the floppy disk to **NCTD.ROM**.

### Recovering the BIOS from a floppy disk

To recover the BIOS from a floppy disk:

1. Turn on the system.
2. Insert the floppy disk with the original or updated BIOS file to the floppy disk drive.
3. The utility displays the following message and automatically checks the floppy disk for the original or updated BIOS file.

```
Bad BIOS checksum. Starting BIOS recovery...  
Checking for floppy...
```

When found, the utility reads the BIOS file and starts flashing the corrupted BIOS file.

```
Bad BIOS checksum. Starting BIOS recovery...  
Checking for floppy...  
Floppy found!  
Reading file "NCTD.ROM". Completed.  
Start flashing...
```



DO NOT shut down or reset the system while updating the BIOS! Doing so can cause system boot failure!

4. Restart the system after the utility completes the updating process.

## Recovering the BIOS from the support CD

To recover the BIOS from the support CD:

1. Remove any floppy disk from the floppy disk drive, then turn on the system.
2. Insert the support CD to the optical drive.
3. The utility displays the following message and automatically checks the floppy disk for the original or updated BIOS file.

```
Bad BIOS checksum. Starting BIOS recovery...
Checking for floppy...
```

When no floppy disk is found, the utility automatically checks the optical drive for the original or updated BIOS file. The utility then updates the corrupted BIOS file.

```
Bad BIOS checksum. Starting BIOS recovery...
Checking for floppy...
Floppy not found!
Checking for CD-ROM...
CD-ROM found!
Reading file "NCTD.ROM". Completed.
Start flashing...
```



---

DO NOT shut down or reset the system while updating the BIOS! Doing so can cause system boot failure!

---

4. Restart the system after the utility completes the updating process.



---

The recovered BIOS may not be the latest BIOS version for this motherboard. Visit the ASUS website ([www.asus.com](http://www.asus.com)) to download the latest BIOS file.

---

## 4.1.4 ASUS EZ Flash utility

The ASUS EZ Flash feature allows you to update the BIOS without having to go through the long process of booting from a floppy disk and using a DOS-based utility. The EZ Flash utility is built-in the BIOS chip so it is accessible by pressing <Alt> + <F2> during the Power-On Self Tests (POST).

To update the BIOS using EZ Flash:

1. Visit the ASUS website ([www.asus.com](http://www.asus.com)) to download the latest BIOS file for the motherboard and rename the same to **NCTD.ROM**.
2. Save the BIOS file to a floppy disk, then restart the system.
3. Press <Alt> + <F2> during POST to display the following.

```
EZFlash starting BIOS update
Checking for floppy...
```

4. Insert the floppy disk that contains the BIOS file to the floppy disk drive. When the correct BIOS file is found, EZ Flash performs the BIOS update process and automatically reboots the system when done.

```
EZFlash starting BIOS update
Checking for floppy...
Floppy found!
Reading file "NCTD.rom". Completed.
Start erasing.....|
Start programming...|
Flashed successfully. Rebooting.
```



- Do not shutdown or reset the system while updating the BIOS to prevent system boot failure!
- A “Floppy not found!” error message appears if there is no floppy disk in the drive. A “NCTD.ROM not found!” error message appears if the correct BIOS file is not found in the floppy disk. Make sure that you rename the BIOS file to NCTD.ROM.

## 4.1.5 ASUS Update utility

The ASUS Update is a utility that allows you to manage, save, and update the motherboard BIOS in Windows® environment. The ASUS Update utility allows you to:

- Save the current BIOS file
- Download the latest BIOS file from the Internet
- Update the BIOS from an updated BIOS file
- Update the BIOS directly from the Internet, and
- View the BIOS version information.

This utility is available in the support CD that comes with the motherboard package.



---

ASUS Update requires an Internet connection either through a network or an Internet Service Provider (ISP).

---

## Installing ASUS Update

To install ASUS Update:

1. Place the support CD in the optical drive. The **Drivers** menu appears.
2. Click the **Utilities** tab, then click **Install ASUS Update VX.XX.XX**.
3. The ASUS Update utility is copied to your system.



---

Quit all Windows® applications before you update the BIOS using this utility.

---

## Updating the BIOS through the Internet

To update the BIOS through the Internet:

1. Launch the ASUS Update utility from the Windows® desktop by clicking **Start > Programs > ASUS > ASUSUpdate > ASUSUpdate**. The ASUS Update main window appears.

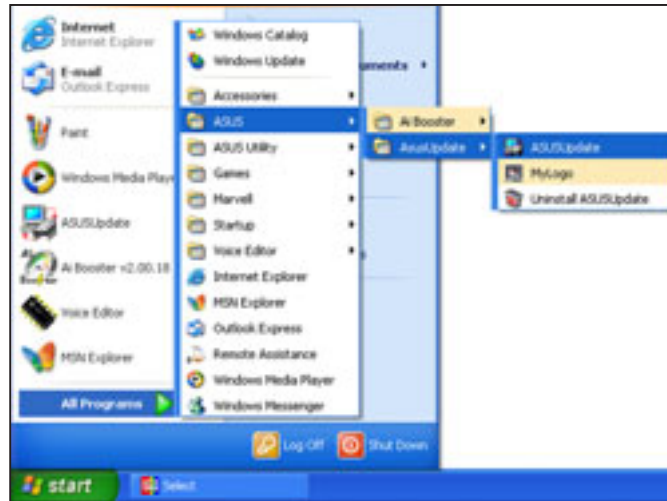

2. Select **Update BIOS from the Internet** option from the drop-down menu, then click **Next**.



3. Select the ASUS FTP site nearest you to avoid network traffic, or click **Auto Select**. Click **Next**.

- From the FTP site, select the BIOS version that you wish to download. Click Next.
- Follow the screen instructions to complete the update process.



The ASUS Update utility is capable of updating itself through the Internet. Always update the utility to avail all its features.



## Updating the BIOS through a BIOS file

To update the BIOS through a BIOS file:

- Launch the ASUS Update utility from the Windows® desktop by clicking **Start > Programs > ASUS > ASUSUpdate > ASUSUpdate**. The ASUS Update main window appears.
- Select **Update BIOS from a file** option from the drop-down menu, then click **Next**.



- Locate the BIOS file from the **Open** window, then click **Save**.
- Follow the screen instructions to complete the update process.



## 4.2 BIOS setup program

This motherboard supports a programmable firmware chip that you can update using the provided utility described in section “4.1 Managing and updating your BIOS.”

Use the BIOS Setup program when you are installing a motherboard, reconfiguring your system, or prompted to “Run Setup”. This section explains how to configure your system using this utility.

Even if you are not prompted to use the Setup program, you can change the configuration of your computer in the future. For example, you can enable the security password feature or change the power management settings. This requires you to reconfigure your system using the BIOS Setup program so that the computer can recognize these changes and record them in the CMOS RAM of the firmware hub.

The firmware hub on the motherboard stores the Setup utility. When you start up the computer, the system provides you with the opportunity to run this program. Press <Del> during the Power-On-Self-Test (POST) to enter the Setup utility; otherwise, POST continues with its test routines.

If you wish to enter Setup after POST, restart the system by pressing <Ctrl+Alt+Delete>, or by pressing the reset button on the system chassis. You can also restart by turning the system off and then back on. Do this last option only if the first two failed.

The Setup program is designed to make it as easy to use as possible. Being a menu-driven program, it lets you scroll through the various sub-menus and make your selections from the available options using the navigation keys.



- 
- The default BIOS settings for this motherboard apply for most conditions to ensure optimum performance. If the system becomes unstable after changing any BIOS settings, load the default settings to ensure system compatibility and stability. Select the **Load Setup Defaults** item under the Exit Menu. See section “4.7 Exit Menu.”
  - The BIOS setup screens shown in this section are for reference purposes only, and may not exactly match what you see on your screen.
  - Visit the ASUS website ([www.asus.com](http://www.asus.com)) to download the latest BIOS file for this motherboard.
-

## 4.2.1 BIOS menu screen

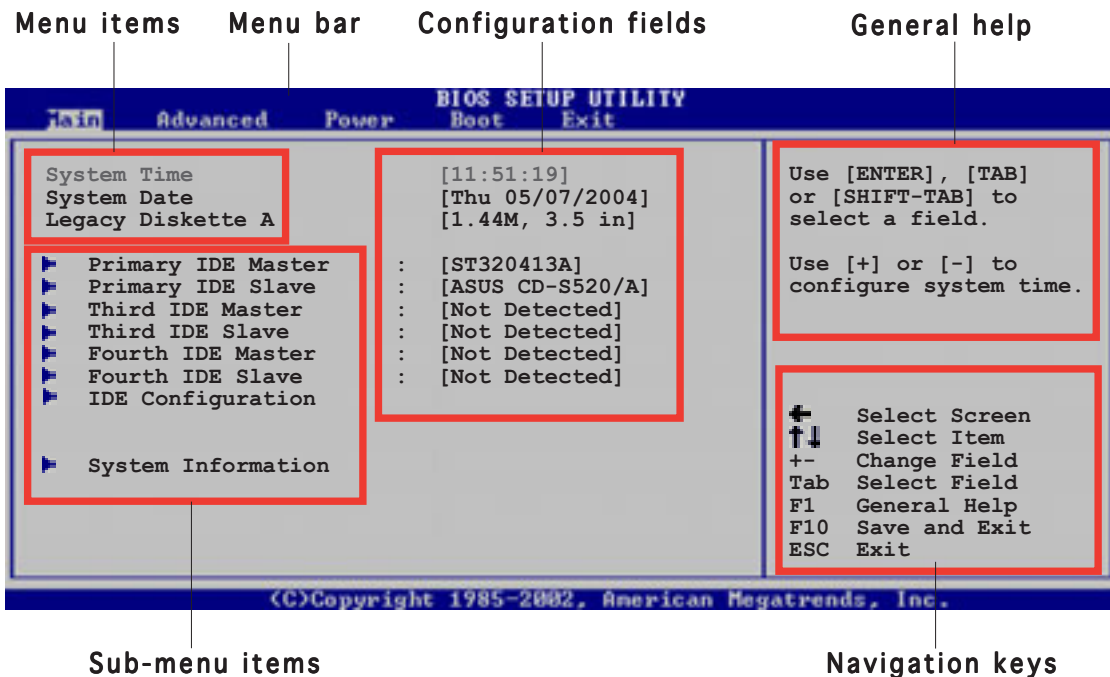

## 4.2.2 Menu bar

The menu bar on top of the screen has the following main items:

- Main** For changing the basic system configuration
- Advanced** For changing the advanced system settings
- Power** For changing the advanced power management (APM) configuration
- Boot** For changing the system boot configuration
- Exit** For selecting the exit options and loading default settings

To select an item on the menu bar, press the right or left arrow key on the keyboard until the desired item is highlighted.

## 4.2.3 Navigation keys

At the bottom right corner of a menu screen are the navigation keys for that particular menu. Use the navigation keys to select items in the menu and change the settings.



Some of the navigation keys differ from one screen to another.

## 4.2.4 Menu items

The highlighted item on the menu bar displays the specific items for that menu. For example, selecting **Main** shows the Main menu items.

The other items (Advanced, Power, Boot, and Exit) on the menu bar have their respective menu items.

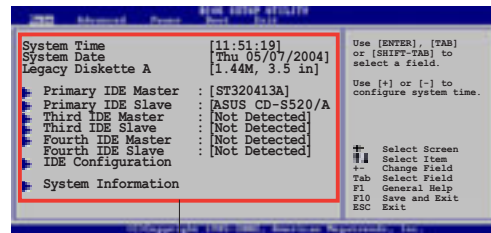

Main menu items

## 4.2.5 Sub-menu items

A solid triangle before each item on any menu screen means that the item has a sub-menu. To display the sub-menu, select the item and press <Enter>.

## 4.2.6 Configuration fields

These fields show the values for the menu items. If an item is user-configurable, you can change the value of the field opposite the item. You cannot select an item that is not user-configurable.

A configurable field is enclosed in brackets, and is highlighted when selected. To change the value of a field, select it then press <Enter> to display a list of options. Refer to “4.2.7 Pop-up window.”

## 4.2.7 Pop-up window

Select a menu item then press <Enter> to display a pop-up window with the configuration options for that item.

## 4.2.8 Scroll bar

A scroll bar appears on the right side of a menu screen when there are items that do not fit on the screen. Press the Up/Down arrow keys or <Page Up> / <Page Down> keys to display the other items on the screen.

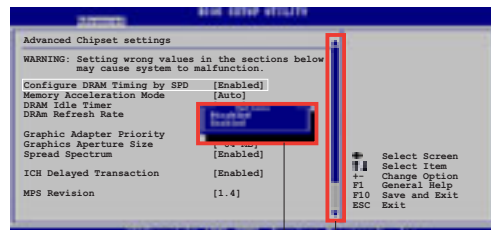

Pop-up window

Scroll bar

## 4.2.9 General help

At the top right corner of the menu screen is a brief description of the selected item.

## 4.3 Main menu

When you enter the BIOS Setup program, the **Main** menu screen appears, giving you an overview of the basic system information.



Refer to section “4.2.1 BIOS menu screen” for information on the menu screen items and how to navigate through them.

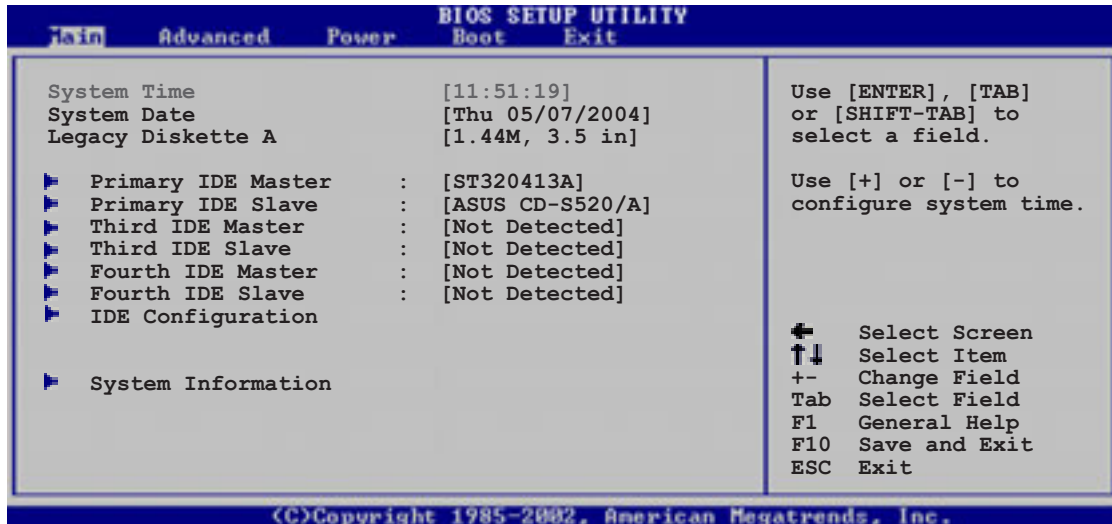

### 4.3.1 System Time [xx:xx:xxxx]

Allows you to set the system time.

### 4.3.2 System Date [Day xx/xx/xxxx]

Allows you to set the system date.

### 4.3.3 Legacy Diskette A [1.44M, 3.5 in.]

Sets the type of floppy drive installed. Configuration options: [Disabled] [360K, 5.25 in.] [1.2M , 5.25 in.] [720K , 3.5 in.] [1.44M, 3.5 in.] [2.88M, 3.5 in.]

### 4.3.4 Primary, Third and Fourth IDE Master/Slave

The BIOS automatically detects the connected IDE devices. There is a separate sub-menu for each IDE device. Select a device item, then press <Enter> to display the IDE device information.

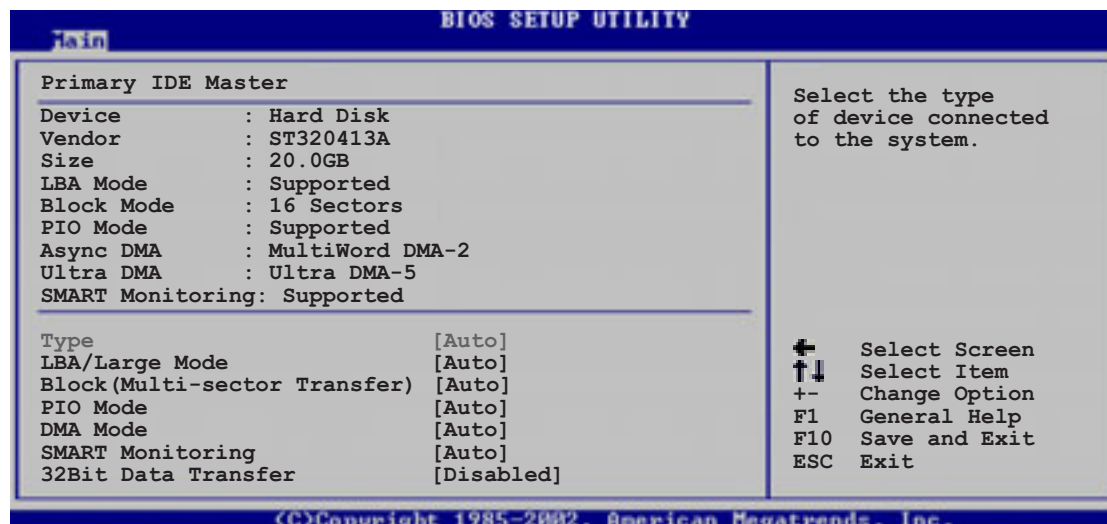

The BIOS automatically detects the values opposite the dimmed items (Device, Vendor, Size, LBA Mode, Block Mode, PIO Mode, Async DMA, Ultra DMA, and SMART monitoring). These values are not user-configurable. These items show N/A if no IDE device is installed in the system.

#### Type [Auto]

Selects the type of IDE drive. Setting to [Auto] allows automatic selection of the appropriate IDE device type. Select [CDROM] if you are specifically configuring a CD-ROM drive. Select [ARMD] (ATAPI Removable Media Device) if your device is either a ZIP, LS-120, or MO drive. Configuration options: [Not Installed] [Auto] [CDROM] [ARMD]

#### LBA/Large Mode [Auto]

Enables or disables the LBA mode. Setting to [Auto] enables the LBA mode if the device supports this mode, and if the device was not previously formatted with LBA mode disabled. Configuration options: [Disabled] [Auto]

#### Block (Multi-sector Transfer) [Auto]

Enables or disables data multi-sectors transfers. When set to [Auto], the data transfer from and to the device occurs multiple sectors at a time if the device supports multi-sector transfer feature. When set to [Disabled], the data transfer from and to the device occurs one sector at a time. Configuration options: [Disabled] [Auto]

## PIO Mode [Auto]

Selects the PIO mode.

Configuration options: [Auto] [0] [1] [2] [3] [4]

## SMART Monitoring [Auto]

Sets the Smart Monitoring, Analysis, and Reporting Technology.

Configuration options: [Auto] [Disabled] [Enabled]

## 32Bit Data Transfer [Disabled]

Enables or disables 32-bit data transfer.

Configuration options: [Disabled] [Enabled]

### 4.3.5 IDE Configuration

The items in this menu allow you to set or change the configurations for the IDE devices installed in the system. Select an item then press <Enter> if you wish to configure the item.

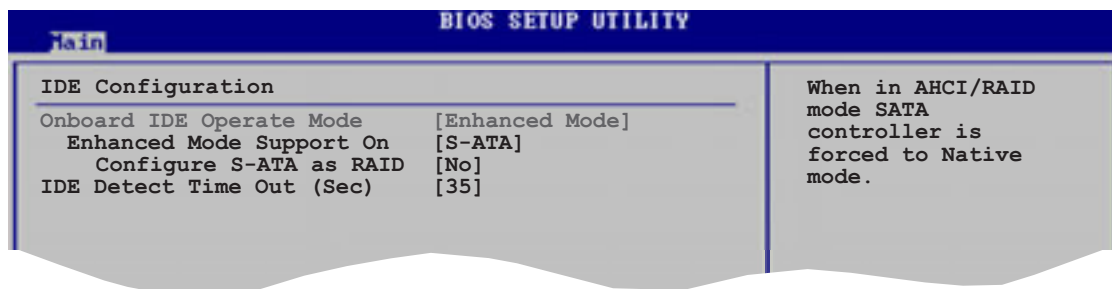

## Onboard IDE Operate Mode [Enhanced Mode]

Allows selection of the IDE operation mode depending on the installed operating system (OS). Set to [Enhanced Mode] if you are using native OS including Windows® 2000/XP. Configuration options: [Compatible Mode] [Enhanced Mode]

### Enhanced Mode Support On [S-ATA]

Allows you to use native OS on Serial ATA and Parallel ATA ports. It is recommended that you do not change the default setting for better OS compatibility. In this setting, you may use legacy OS on the Parallel ATA ports only if you do not install any Serial ATA device.

### Configure S-ATA as RAID [No]

Allows you to set the Serial ATA devices connected to the Serial ATA connectors as RAID sets. Configuration options: [No] [Yes]



The following item appears only when you set the **Onboard IDE Operate Mode** to [Compatible Mode]

#### Compatible Mode Option [Primary P-ATA+S-ATA]

Allows you to select the combined mode for the installed IDE and SATA devices.

The Secondary **P-ATA+S-ATA** and **P-ATA Ports Only** options are for advanced users only. If you set to any of these options and encountered problems, revert to the default setting **Primary P-ATA+S-ATA**. Configuration options: [Primary P-ATA+S-ATA] [Secondary P-ATA+S-ATA] [P-ATA Ports Only]

### IDE Detect Time Out [35]

Selects the time out value for detecting ATA/ATAPI devices.  
Configuration options: [0] [5] [10] [15] [20] [25] [30] [35]

## 4.3.6 System Information

This menu gives you an overview of the general system specifications. The BIOS automatically detects the items in this menu.

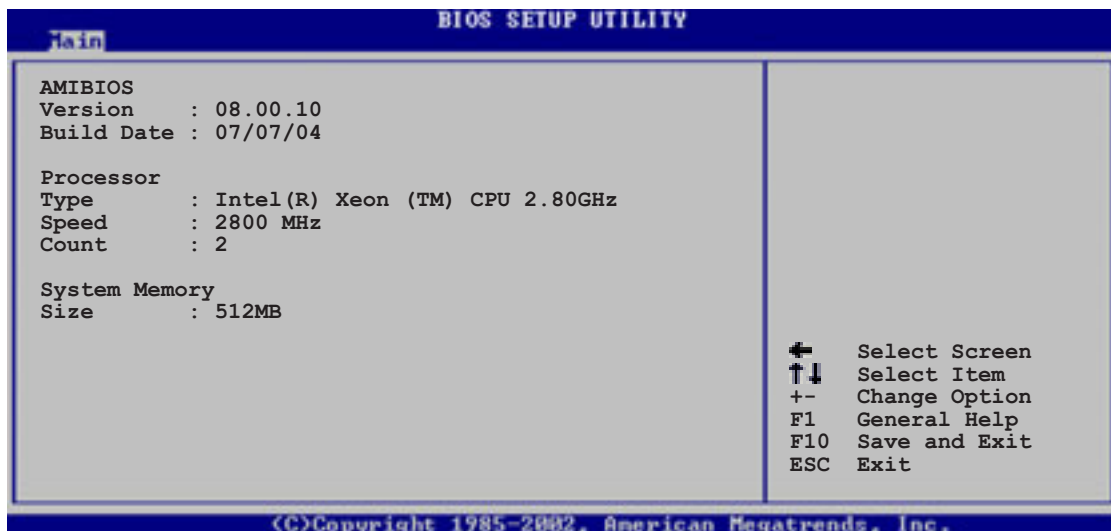

### AMI BIOS

Displays the auto-detected BIOS information

### Processor

Displays the auto-detected CPU specification

### System Memory

Displays the auto-detected system memory

## 4.4 Advanced menu

The Advanced menu items allow you to change the settings for the CPU and other system devices.



Take caution when changing the settings of the Advanced menu items. Incorrect field values can cause the system to malfunction.

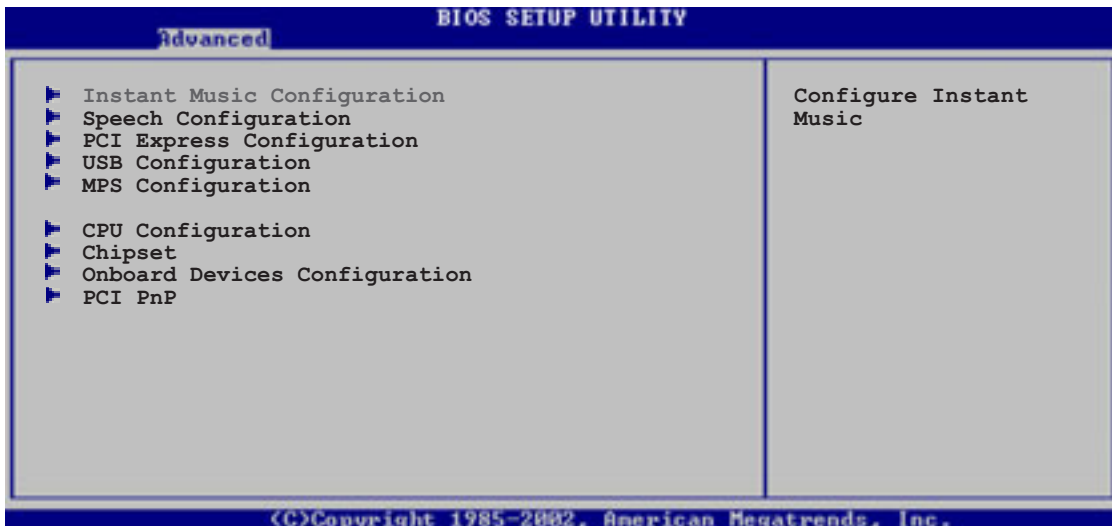

### 4.4.1 Instant Music Configuration

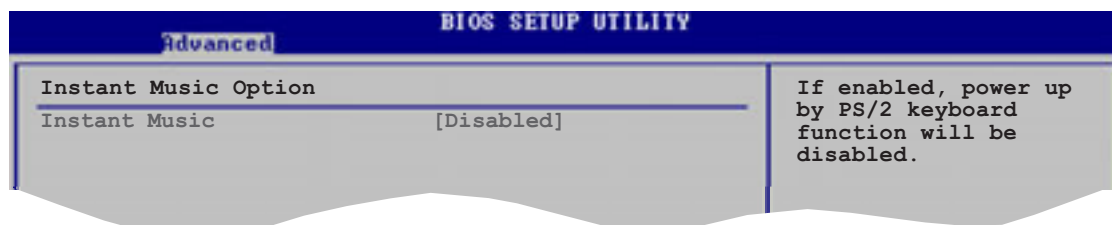

#### Instant Music [Disabled]

Allows you to enable or disable the Instant Music feature in BIOS.  
Configuration options: [Disabled] [Enabled]



Enabling Instant Music automatically disables the PS/2 keyboard power up feature. See page 4-29 for details.

#### Instant Music CD-ROM Drive [IDE Secondary Master]

Allows you to select the CD-ROM drive that you wish to use for the Instant Music playback. Configuration options: [IDE Primary Master] [IDE Primary Slave] [IDE Secondary Master] [IDE Secondary Slave]



The **Instant Music CD-ROM Drive** option appears only when you enable the **Instant Music** item.



## 4.4.2 Speech Configuration

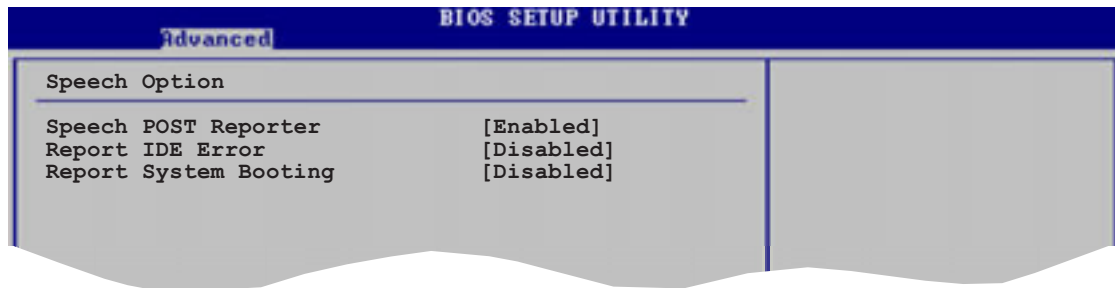

### Speech POST Reporter [Enabled]

Allows you to enable or disable the ASUS Speech POST Reporter™ feature.  
Configuration options: [Disabled] [Enabled]



The following items appear only when Speech POST Reporter is set to Enabled.

### Report IDE Error [Disabled]

Enables or disables the report feature in the event of an IDE error.  
Configuration options: [Disabled] [Enabled]

### Report System Booting [Disabled]

Enables or disables the report after booting the system.  
Configuration options: [Disabled] [Enabled]

## 4.4.3 PCI Express Configuration

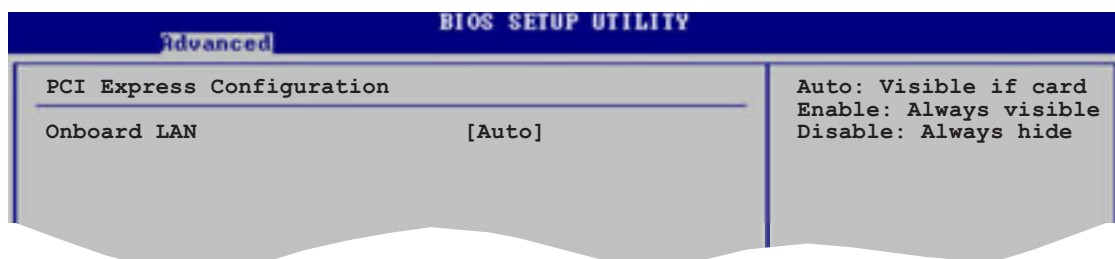

### Onboard LAN [Auto]

Allows you to show or hide the onboard LAN configuration during POST.  
Configuration options: [Auto] [Enable] [Disable]

## 4.4.4 USB Configuration

The items in this menu allows you to change the USB-related features. Select an item then press <Enter> to display the configuration options.

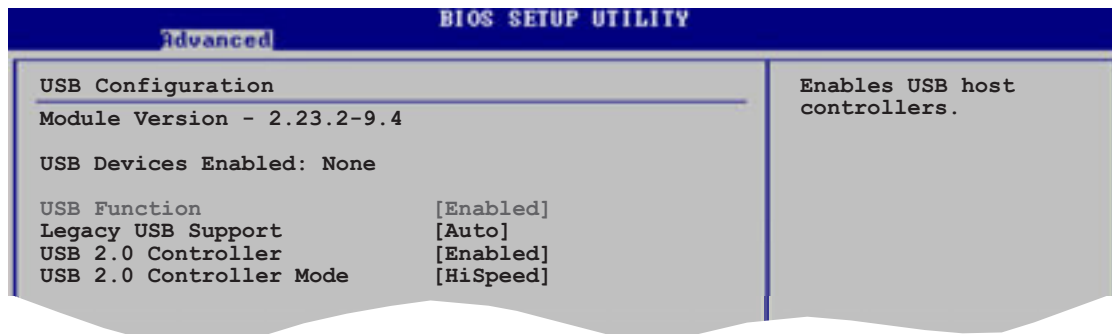

The **Module Version** and **USB Devices Enabled** items show the auto-detected values. If no USB device is detected, the **USB Devices Enabled** item shows **None**.

### USB Function [Enabled]

Allows you to enable or disable the USB function.  
Configuration options: [Disabled] [Enabled]

### Legacy USB Support [Auto]

Allows you to enable or disable support for legacy USB devices. Setting to [Auto] allows the system to detect the presence of USB devices at startup. If detected, the USB controller legacy mode is enabled. If no USB device is detected, the legacy USB support is disabled.  
Configuration options: [Disabled] [Enabled] [Auto]

### USB 2.0 Controller [Enabled]

Allows you to enable or disable the USB 2.0 controller.  
Configuration options: [Enabled] [Disabled]

### USB 2.0 Controller Mode [HiSpeed]

Allows you to set the USB 2.0 controller mode to HiSpeed (480 Mbps) or FullSpeed (12 Mbps). Configuration options: [HiSpeed ] [FullSpeed ]

## 4.4.5 MPS Configuration

The items in this menu allows you to configure the Multi-Processor Table. Select an item then press <Enter> to display the configuration options.

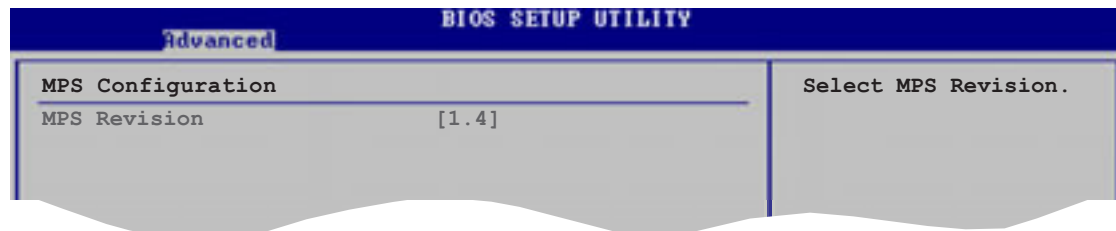

### MPS Revision [1.4]

Allows you to select the multi-processor system revision.  
Configuration options: [1.1] [1.4]

## 4.4.6 CPU Configuration

The items in this menu show the CPU-related information that the BIOS automatically detects.

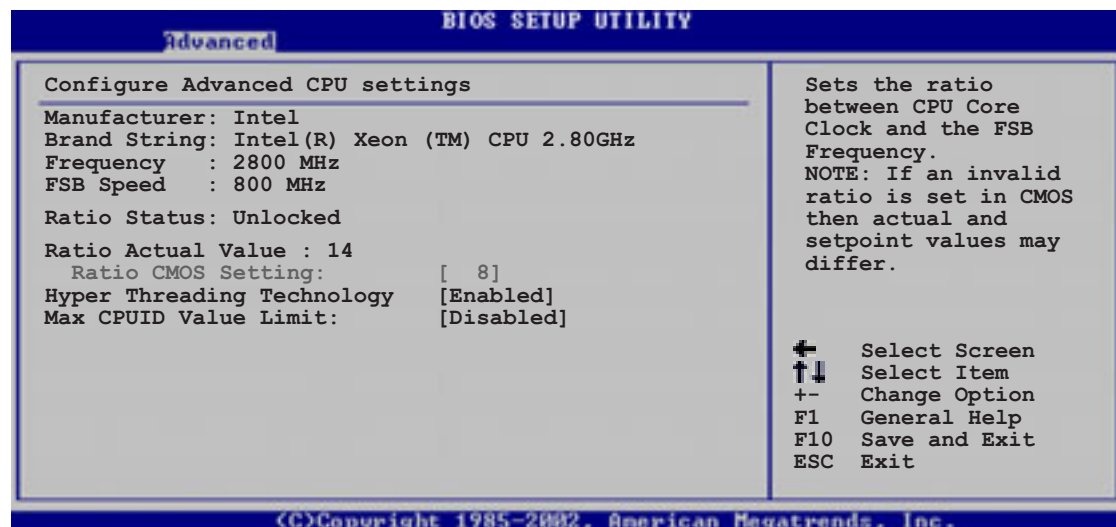

### Ratio CMOS Setting [ 8]

Sets the ratio between the CPU core clock and the Front Side Bus frequency. The BIOS auto-detects the default value of this item. Use the <+> or <-> keys to adjust the values. Configuration options: [ 8]...[28]



You can only adjust the **Ratio CMOS** settings if you installed an unlocked CPU. Refer to the CPU documentation for details.

## Hyper-Threading Technology [Enabled]

Allows you to enable or disable the processor Hyper-Threading Technology.  
Configuration options: [Disabled] [Enabled]

## Max CPUID Value Limit [Disabled]

Setting this item to [Enabled] allows legacy operating systems to boot even without support for CPUs with extended CPUID functions.  
Configuration options: [Disabled] [Enabled]

## 4.4.7 Chipset

The Chipset menu allows you to change the advanced chipset settings. Select an item then press <Enter> to display the sub-menu.

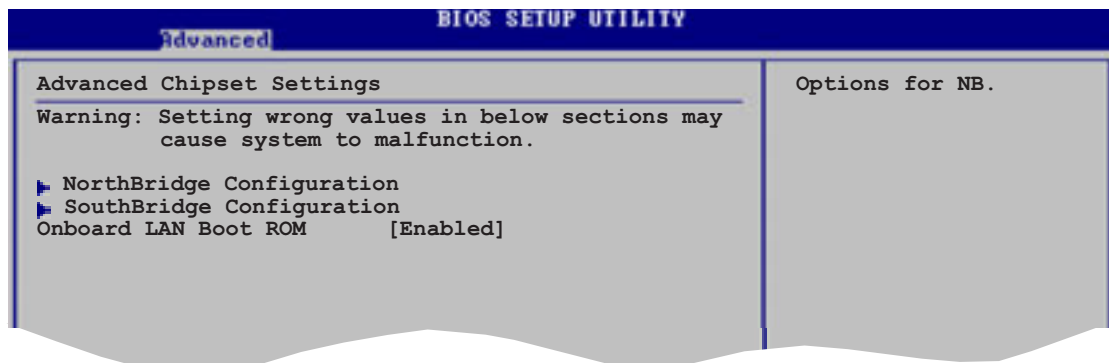

## Onboard LAN Boot ROM [Enabled]

Allows you to enable or disable the option ROM in the onboard LAN controller. Configuration options: [Disabled] [Enabled]

## NorthBridge Configuration

The NorthBridge Configuration menu allows you to change the Northbridge settings.

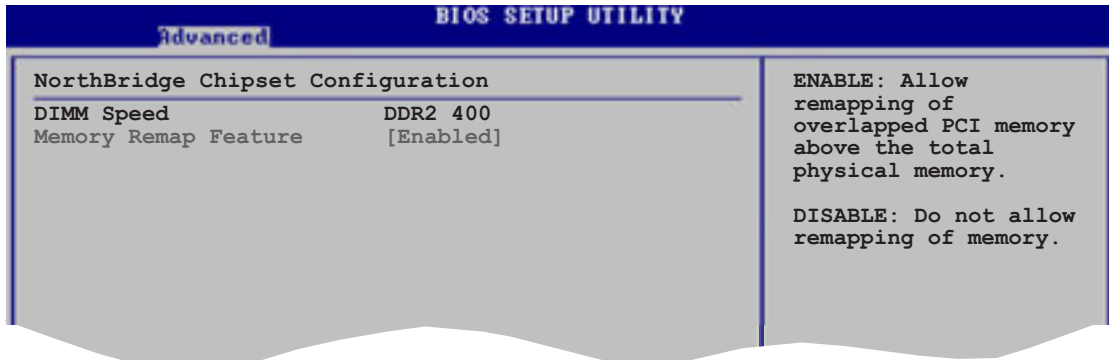

### DIMM Speed

Displays the installed DIMM type and speed. This item is auto-detected and is not configurable.

### Memory Remap Feature [Enabled]

Allows you to remap the overlap PCI memory over the total physical memory. Configuration options: [Disabled] [Enabled]

## SouthBridge Configuration

The SouthBridge Configuration menu allows you to change the Southbridge settings.

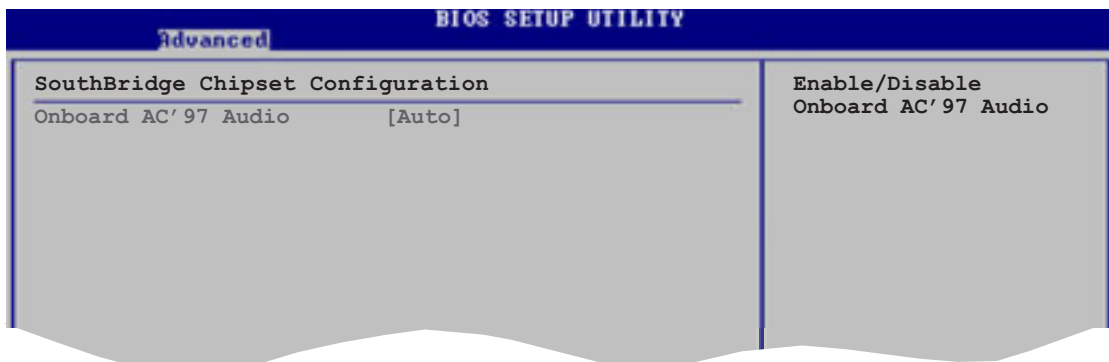

### Onboard AC'97 Audio [Auto]

Setting to [Auto] allows the BIOS to auto-detect any audio device connected to your system. If an audio device is detected, the onboard audio controller is enabled; if no audio device is detected, the onboard audio controller is disabled. Configuration options: [Auto] [Disabled]

## 4.4.8 Onboard Devices Configuration

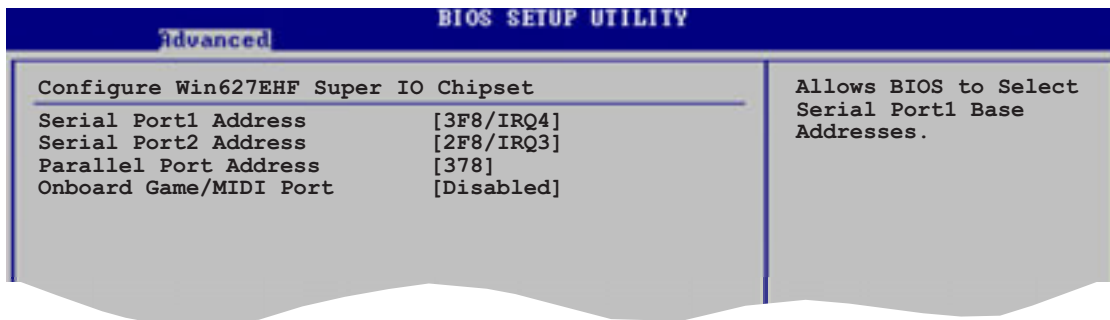

### Serial Port1 Address [3F8/IRQ4]

Allows you to select the Serial Port1 base address.

Configuration options: [Disabled] [3F8/IRQ4] [3E8/IRQ4] [2E8/IRQ3]

### Serial Port1 Address [2F8/IRQ3]

Allows you to select the Serial Port2 base address.

Configuration options: [Disabled] [2F8/IRQ3] [3E8/IRQ4] [2E8/IRQ3]

### Parallel Port Address [378]

Allows you to select the Parallel Port base addresses.

Configuration options: [Disabled] [378] [278] [3BC]

### Onboard Game/MIDI Port [Disabled]

Allows you to select the Game Port address or to disable the port.

Configuration options: [Disabled] [200/300] [200/330] [208/300]  
[208/330]

## 4.4.9 PCI PnP

The PCI PnP menu items allow you to change the advanced settings for PCI/PnP devices. The menu includes setting IRQ and DMA channel resources for either PCI/PnP or legacy ISA devices, and setting the memory size block for legacy ISA devices.



Take caution when changing the settings of the PCI PnP menu items. Incorrect field values can cause the system to malfunction.

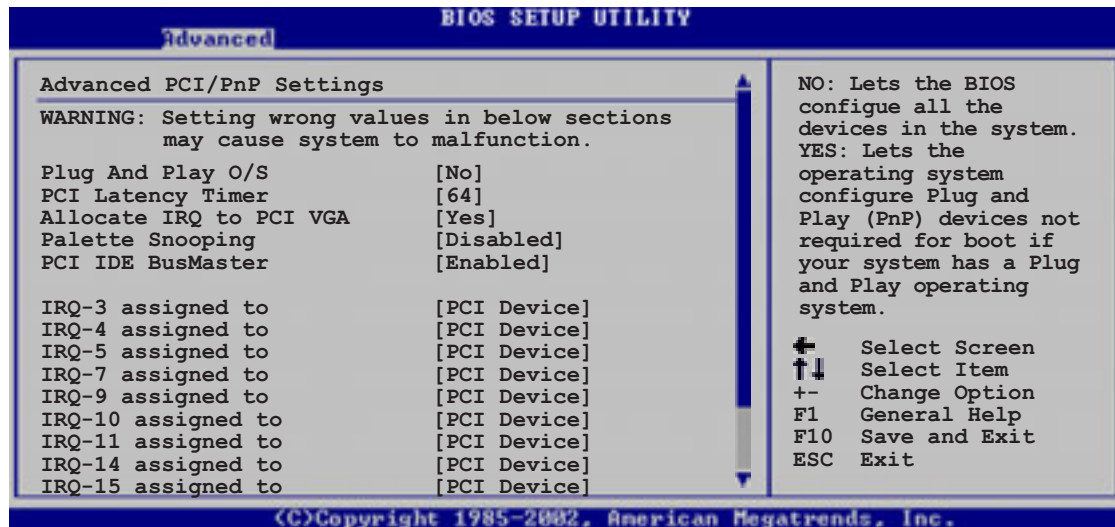

### Plug And Play O/S [No]

When set to [No], BIOS configures all the devices in the system. When set to [Yes] and if you install a Plug and Play operating system, the operating system configures the Plug and Play devices not required for boot.

Configuration options: [No] [Yes]

### PCI Latency Timer [64]

Allows you to select the value in units of PCI clocks for the PCI device latency timer register. Configuration options: [32] [64] [96] [128] [160] [192] [224] [248]

### Allocate IRQ to PCI VGA [Yes]

When set to [Yes], BIOS assigns an IRQ to PCI VGA card if the card requests for an IRQ. When set to [No], BIOS does not assign an IRQ to the PCI VGA card even if requested. Configuration options: [No] [Yes]

### Palette Snooping [Disabled]

When set to [Enabled], the palette snooping feature informs the PCI devices that an ISA graphics device is installed in the system so that the latter can function correctly. Configuration options: [Disabled] [Enabled]

## PCI IDE BusMaster [Enabled]

Allows BIOS to use PCI bus mastering when reading/writing to IDE devices.  
Configuration options: [Disabled] [Enabled]

## Offboard PCI/ISA IDE Card [Auto]

Allows you to assign a PCI slot to a PCI IDE card, when required.  
Configuration options: [Auto] [PCI Slot1] [PCI Slot2] [PCI Slot3] [PCI Slot4]  
[PCI Slot5] [PCI Slot6]

## IRQ-xx assigned to [PCI Device]

When set to [PCI Device], the specific IRQ is free for use of PCI/PnP devices. When set to [Reserved], the IRQ is reserved for legacy ISA devices. Configuration options: [PCI Device] [Reserved]

Use the arrow down key to scroll down the menu.

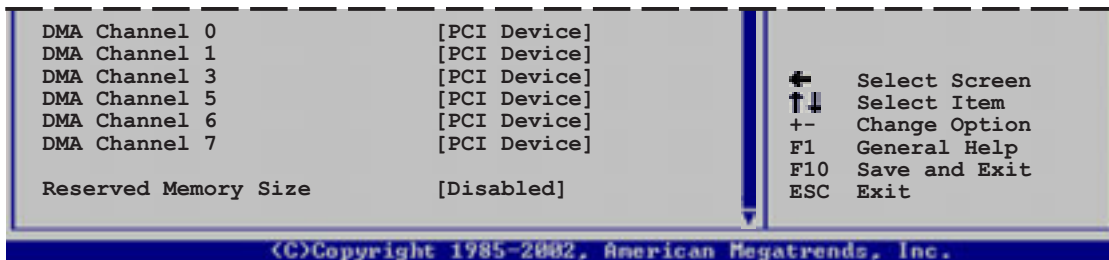

## DMA Channel X [PCI Device]

When set to [PCI Device], the specific DMA channel is free for use of PCI/PnP devices. When set to [Reserved], the DMA channel is reserved for legacy ISA devices. Configuration options: [PCI Device] [Reserved]

## Reserved Memory Size [Disabled]

Allows you to set the reserved memory size.  
Configuration options: [Disabled] [16k] [32k] [64k]



## 4.5 Power menu

The Power menu items allow you to change the settings for the ACPI and Advanced Power Management (APM) features. Select an item then press <Enter> to display the configuration options.

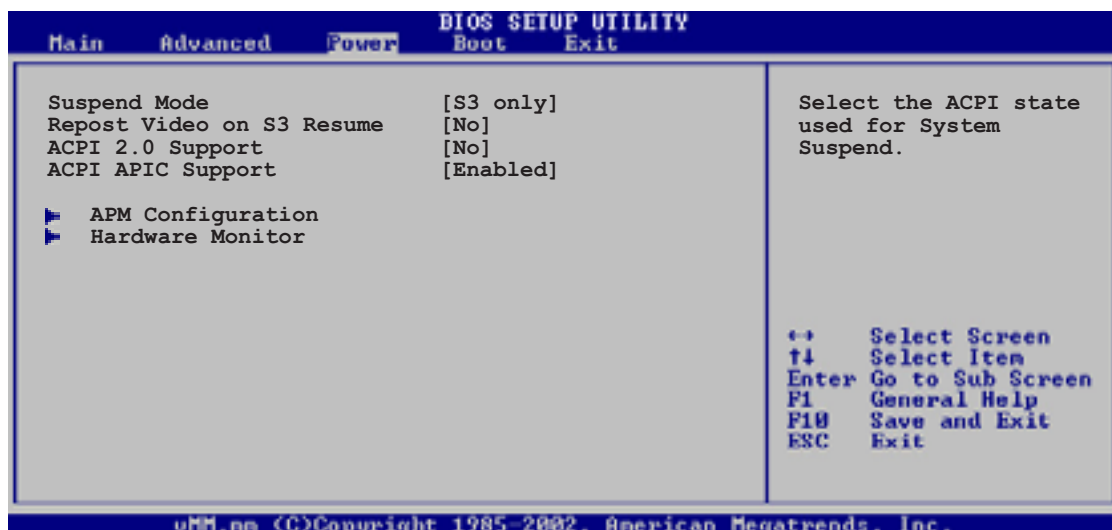

### 4.5.1 Suspend Mode [S3 only]

Allows you to select the Advanced Configuration and Power Interface (ACPI) state to be used for system suspend.

Configuration options: [S1 (POS) Only] [S3 Only]

### 4.5.2 Repost Video on S3 Resume [No]

Determines whether to invoke VGA BIOS POST on S3/STR resume.

Configuration options: [Yes] [No]

### 4.5.3 ACPI 2.0 Support [No]

Allows you to add more tables for Advanced Configuration and Power Interface (ACPI) 2.0 specifications. Configuration options: [No] [Yes]

### 4.5.4 ACPI APIC Support [Enabled]

Allows you to enable or disable the Advanced Configuration and Power Interface (ACPI) support in the Application-Specific Integrated Circuit (ASIC). When set to Enabled, the ACPI APIC table pointer is included in the RSDT pointer list. Configuration options: [Disabled] [Enabled]

## 4.5.5 APM Configuration

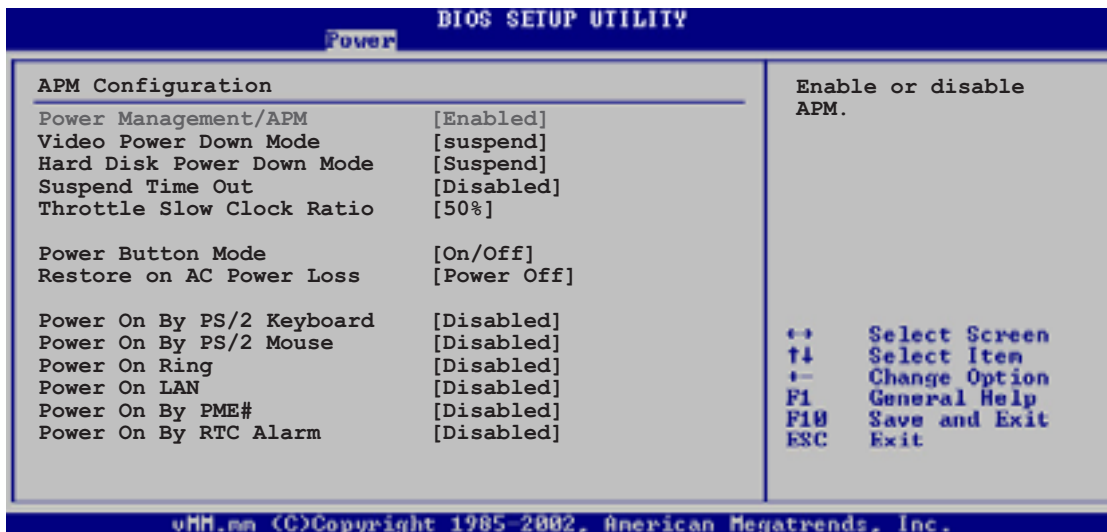

### Power Management [Enabled]

Allows you to enable or disable the motherboard Advance Power Management (APM) feature. Configuration options: [Enabled] [Disabled]

### Video Power Down Mode [Suspend]

Allows you to select the video power down mode  
Configuration options: [Disabled] [Standby] [Suspend]

### Hard Disk Power Down Mode [Suspend]

Allows you to select the hard disk power down mode  
Configuration options: [Disabled] [Standby] [Suspend]

### Suspend Time Out [Disabled]

Allows you to select the specified time at which the system goes on suspend mode. Configuration options: [Disabled] [1 Min] [2 Min] [4 Min] [8 Min] [10 Min] [20 Min] [30 Min] [40 Min] [50 Min] [60 Min]

### Throttle Slow Clock Ratio [50%]

Allows you to select duty cycle in throttle mode.  
Configuration options: [87.5%] [75.0%] [62.5%] [50.0%] [37.5%] [25.0%] [12.5%]

### Power Button Mode [On/Off]

Allows the system to go into On/Off mode or suspend mode when the power button is pressed. Configuration options: [On/Off] [Suspend]

### **Restore on AC Power Loss [Power Off]**

When set to Power Off, the system goes into off state after an AC power loss. When set to Power On, the system goes on after an AC power loss. When set to Last State, the system goes into either off or on state, whatever the system state was before the AC power loss.  
Configuration options: [Power Off] [Power On] [Last State]

### **Power On By PS/2 Keyboard [Disabled]**

Allows you to use specific keys on the keyboard to turn on the system. This feature requires an ATX power supply that provides at least 1A on the +5VSB lead. Configuration options: [Disabled] [Enabled]

### **Power On By PS/2 Mouse [Disabled]**

When set to [Enabled], this parameter allows you to use the PS/2 mouse to turn on the system. This feature requires an ATX power supply that provides at least 1A on the +5VSB lead. Configuration options: [Disabled] [Enabled]

### **Power On Ring [Disabled]**

When set to [Enabled], the system enables the RI to generate a wake event while the computer is in Soft-off mode.  
Configuration options: [Disabled] [Enabled]

### **Power On LAN [Disabled]**

When set to [Enabled], this parameter allows you to turn on the system through a PCI LAN or modem card. This feature requires an ATX power supply that provides at least 1A on the +5VSB lead.  
Configuration options: [Disabled] [Enabled]

### **Power On By PME# [Disabled]**

When set to [Enabled], the system enables the PME to generate a wake event while the computer is in Soft-off mode.  
Configuration options: [Disabled] [Enabled]

### **Power On By RTC Alarm [Disabled]**

Allows you to enable or disable RTC to generate a wake event. When this item is set to [Enabled], the items RTC Alarm Date, RTC Alarm Hour, RTC Alarm Minute, and RTC Alarm Second appear with set values.  
Configuration options: [Disabled] [Enabled]

## 4.5.6 Hardware Monitor

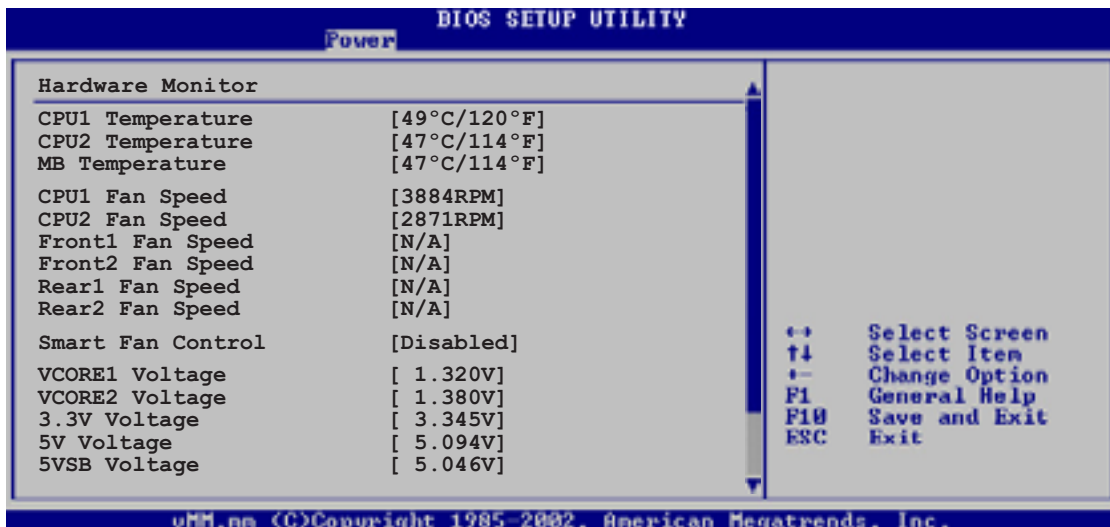

### CPU1/CPU2 Temperature [xxx°C/xxx°F]

### MB Temperature [xxx°C/xxx°F]

The onboard hardware monitor automatically detects and displays the motherboard and CPU temperatures. Select [Disabled] if you do not wish to display the detected temperatures.

### CPU1/CPU2 Fan Speed [xxxxRPM] or [N/A]

### Front1/Front2 Fan Speed [xxxxRPM] or [N/A]

### Rear1/Rear2 Fan Speed [xxxxRPM] or [N/A]

The onboard hardware monitor automatically detects and displays the CPU, front, and rear fan speed in rotations per minute (RPM). If the fan is not connected to the motherboard, the field shows N/A.

### Smart Fan Control [Disabled]

Allows you to enable or disable the ASUS Q-Fan feature that smartly adjusts the fan speeds for more efficient system operation. Configuration options: [Disabled] [Enabled]



The **CPU1 Temperature**, **CPU2 Temperature**, and **Front1 Temperature** items appear when you enable the **Smart Fan Control** feature.

### CPU1/CPU2 Temperature [XXX]

### Front1 Temperature [XXX]

Allows you to set the CPU and system threshold temperature before the Smart Fan Control is disabled.

Use the arrow down key to display additional items.



## **VCORE1 Voltage, VCORE1 Voltage, 3.3V Voltage, 5V Voltage, 5VSB Voltage, VBAT Voltage, 12V Voltage**

The onboard hardware monitor automatically detects the voltage output through the onboard voltage regulators.

## 4.6 Boot menu

The Boot menu items allow you to change the system boot options. Select an item then press <Enter> to display the sub-menu.

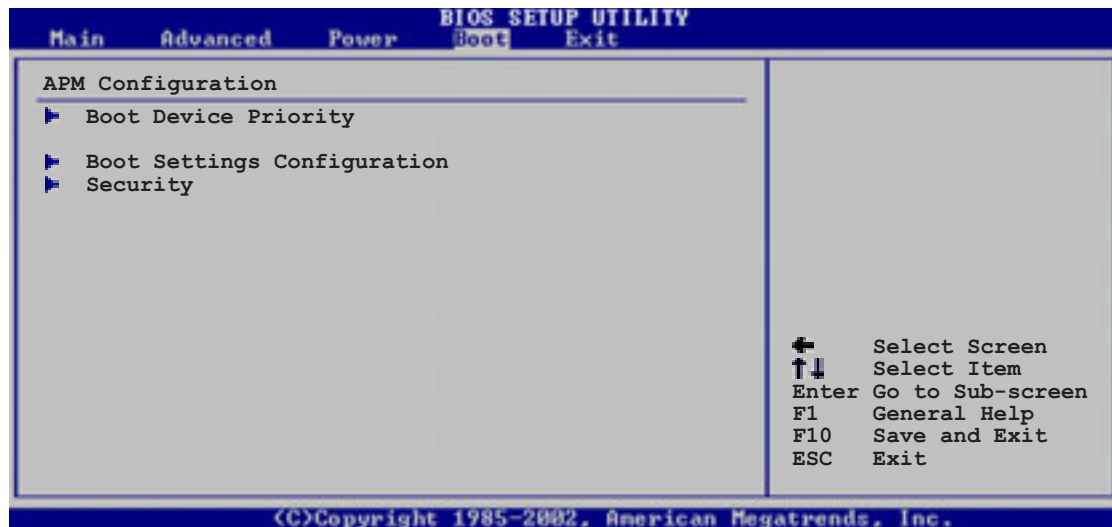

### 4.6.1 Boot Device Priority

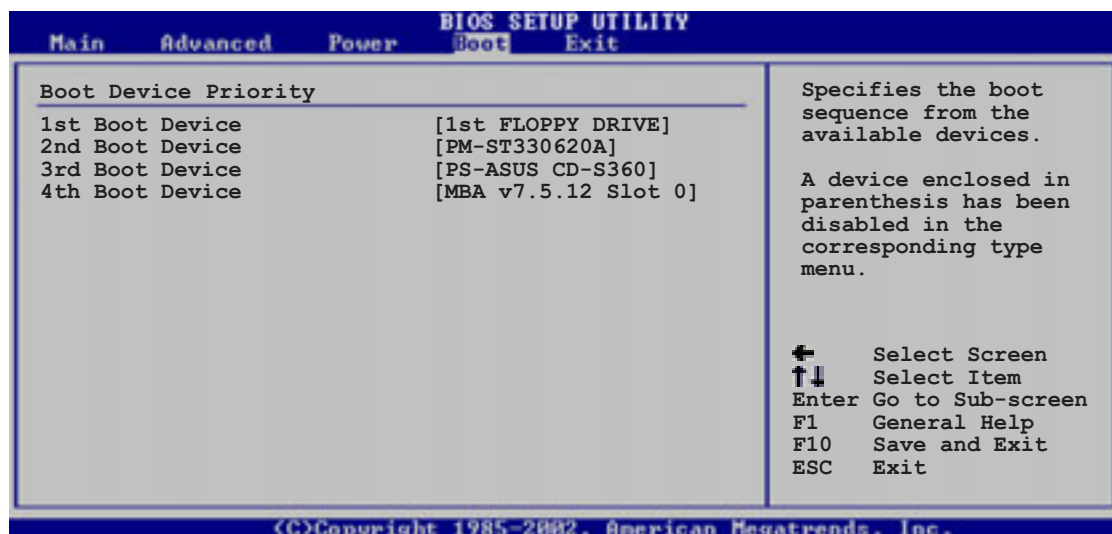

#### 1st ~ xxth Boot Device [1st Floppy Drive]

These items specify the boot device priority sequence from the available devices. The number of device items that appears on the screen depends on the number of devices installed in the system.

Configuration options: [xxxxx Drive] [Disabled]

## 4.6.2 Boot Settings Configuration

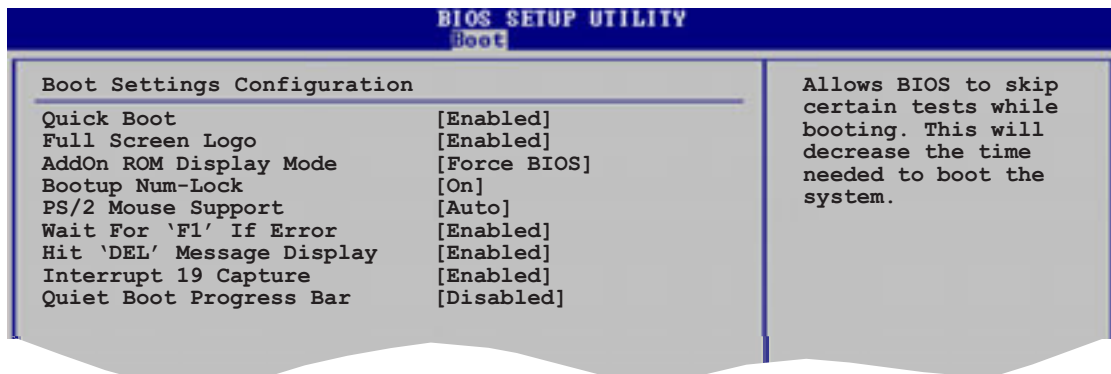

### Quick Boot [Enabled]

Enabling this item allows the BIOS to skip some power on self tests (POST) while booting to decrease the time needed to boot the system. When set to [Disabled], BIOS performs all the POST items.

Configuration options: [Disabled] [Enabled]

### Full Screen Logo [Enabled]

Allows you to enable or disable the full screen logo display feature.

Configuration options: [Disabled] [Enabled]



---

Set this item to [Enabled] to use the ASUS MyLogo2™ feature.

---

### Add On ROM Display Mode [Force BIOS]

Sets the display mode for option ROM.

Configuration options: [Force BIOS] [Keep Current]

### Bootup Num-Lock [On]

Allows you to select the power-on state for the NumLock.

Configuration options: [Off] [On]

### PS/2 Mouse Support [Auto]

Allows you to enable or disable support for PS/2 mouse.

Configuration options: [Disabled] [Enabled] [Auto]

### Wait for 'F1' If Error [Enabled]

When set to Enabled, the system waits for the F1 key to be pressed when error occurs. Configuration options: [Disabled] [Enabled]

### Hit 'DEL' Message Display [Enabled]

When set to Enabled, the system displays the message "Press DEL to run Setup" during POST. Configuration options: [Disabled] [Enabled]

## Interrupt 19 Capture [Enabled]

When set to [Enabled], this function allows the option ROMs to trap Interrupt 19. Configuration options: [Disabled] [Enabled]

## Quiet Boot Progress Bar [Disabled]

When set to [Enabled], a bar shows the progress of the POST instead of boot logos, or POST texts. Configuration options: [Disabled] [Enabled]

### 4.6.3 Security

The Security menu items allow you to change the system security settings. Select an item then press <Enter> to display the configuration options.

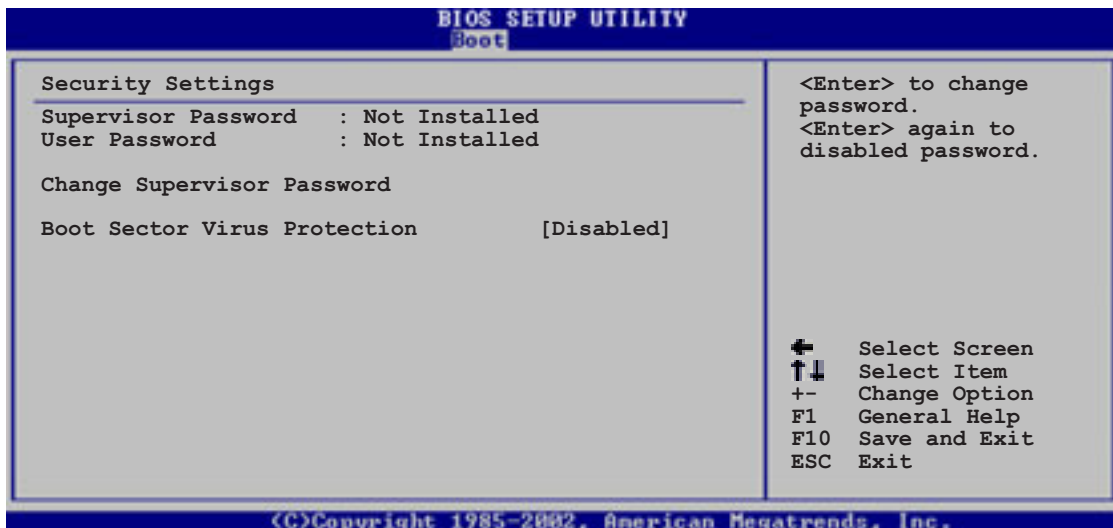

### Change Supervisor Password

Select this item to set or change the supervisor password. The Supervisor Password item on top of the screen shows the default **Not Installed**. After you set a password, this item shows **Installed**.

To set a Supervisor Password:

1. Select the **Change Supervisor Password** item, then press <Enter>.
2. From the password box, type a password composed of at least six letters and/or numbers, then press <Enter>.
3. Confirm the password when prompted.

The message "Password Installed" appears after you successfully set your password.

To change the supervisor password, follow the same steps as in setting a user password.



To clear the supervisor password, select the **Change Supervisor Password** then press <Enter>. The message “Password Uninstalled” appears.



If you forget your BIOS password, you can clear it by erasing the CMOS Real Time Clock (RTC) RAM. See section “2.6 Jumpers” for information on how to erase the RTC RAM.

After you have set a supervisor password, the other items appear to allow you to change other security settings.

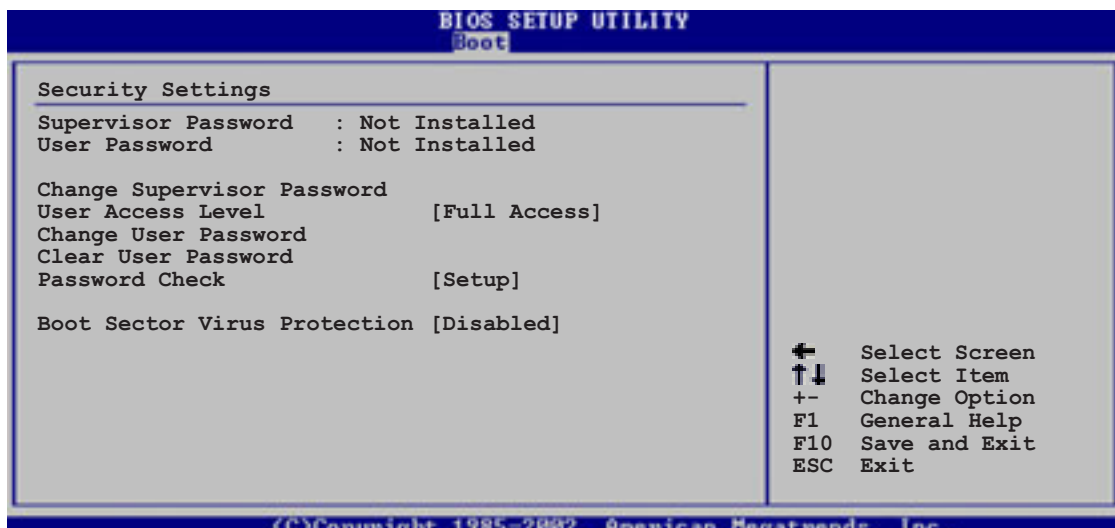

### User Access Level [Full Access]

This item allows you to select the access restriction to the Setup items. Configuration options: [No Access] [View Only] [Limited] [Full Access]

**No Access** prevents user access to the Setup utility.

**View Only** allows access but does not allow change to any field.

**Limited** allows changes only to selected fields, such as Date and Time.

**Full Access** allows viewing and changing all the fields in the Setup utility.

### Change User Password

Select this item to set or change the user password. The **User Password** item on top of the screen shows the default **Not Installed**. After you set a password, this item shows **Installed**.

To set a User Password:

1. Select the Change User Password item and press <Enter>.
2. On the password box that appears, type a password composed of at least six letters and/or numbers, then press <Enter>.
3. Confirm the password when prompted.

The message “Password Installed” appears after you set your password successfully.

To change the user password, follow the same steps as in setting a user password.

### **Clear User Password**

Select this item to clear the user password.

### **Password Check [Setup]**

When set to [Setup], BIOS checks for user password when accessing the Setup utility. When set to [Always], BIOS checks for user password both when accessing Setup and booting the system.

Configuration options: [Setup] [Always]

### **Boot Sector Virus Protection [Disabled]**

Allows you to enable or disable the boot sector virus protection.

Configuration options: [Disabled] [Enabled]

## 4.7 Exit menu

The Exit menu items allow you to load the optimal or failsafe default values for the BIOS items, and save or discard your changes to the BIOS items.



Pressing <Esc> does not immediately exit this menu. Select one of the options from this menu or <F10> from the legend bar to exit.

### Exit & Save Changes

Once you are finished making your selections, choose this option from the Exit menu to ensure the values you selected are saved to the CMOS RAM. An onboard backup battery sustains the CMOS RAM so it stays on even when the computer is turned off. When you select this option, a confirmation window appears. Select **Yes** to save the changes and exit.



If you attempt to exit the Setup program without saving your changes, the program prompts you with a message asking if you want to save your changes before exiting. Press <Enter> to save the changes while exiting.

### Exit & Discard Changes

Select this option only if you do not want to save the changes that you made to the Setup program. If you made changes to fields other than System Date, System Time, and Password, the BIOS asks for a confirmation before exiting.

### Discard Changes

Allows you to discard the selections you made and restore the previously saved values. After selecting this option, a confirmation appears. Select **Yes** to discard any changes and load the previously saved values.

## Load Setup Defaults

Allows you to load the default values for each of the parameters on the Setup menus. When you select this option or if you press <F5>, a confirmation window appears. Select **Yes** to load default values. Select **Exit & Save Changes** or make other changes before saving the values to the non-volatile RAM.

This chapter describes the power up sequence, the vocal POST messages, and ways of shutting down the system.

# Reference information



# Appendix summary



A.1 NCT-D block diagram ..... A-1

# A.1 NCT-D block diagram

