



PSCH-L

User Guide

Motherboard

E1410

First edition V1

February 2004

Copyright © 2004 ASUSTeK COMPUTER INC. All Rights Reserved.

No part of this manual, including the products and software described in it, may be reproduced, transmitted, transcribed, stored in a retrieval system, or translated into any language in any form or by any means, except documentation kept by the purchaser for backup purposes, without the express written permission of ASUSTeK COMPUTER INC. ("ASUS").

Product warranty or service will not be extended if: (1) the product is repaired, modified or altered, unless such repair, modification or alteration is authorized in writing by ASUS; or (2) the serial number of the product is defaced or missing.

ASUS PROVIDES THIS MANUAL "AS IS" WITHOUT WARRANTY OF ANY KIND, EITHER EXPRESS OR IMPLIED, INCLUDING BUT NOT LIMITED TO THE IMPLIED WARRANTIES OR CONDITIONS OF MERCHANTABILITY OR FITNESS FOR A PARTICULAR PURPOSE. IN NO EVENT SHALL ASUS, ITS DIRECTORS, OFFICERS, EMPLOYEES OR AGENTS BE LIABLE FOR ANY INDIRECT, SPECIAL, INCIDENTAL, OR CONSEQUENTIAL DAMAGES (INCLUDING DAMAGES FOR LOSS OF PROFITS, LOSS OF BUSINESS, LOSS OF USE OR DATA, INTERRUPTION OF BUSINESS AND THE LIKE), EVEN IF ASUS HAS BEEN ADVISED OF THE POSSIBILITY OF SUCH DAMAGES ARISING FROM ANY DEFECT OR ERROR IN THIS MANUAL OR PRODUCT.

SPECIFICATIONS AND INFORMATION CONTAINED IN THIS MANUAL ARE FURNISHED FOR INFORMATIONAL USE ONLY, AND ARE SUBJECT TO CHANGE AT ANY TIME WITHOUT NOTICE, AND SHOULD NOT BE CONSTRUED AS A COMMITMENT BY ASUS. ASUS ASSUMES NO RESPONSIBILITY OR LIABILITY FOR ANY ERRORS OR INACCURACIES THAT MAY APPEAR IN THIS MANUAL, INCLUDING THE PRODUCTS AND SOFTWARE DESCRIBED IN IT.

Products and corporate names appearing in this manual may or may not be registered trademarks or copyrights of their respective companies, and are used only for identification or explanation and to the owners' benefit, without intent to infringe.

Contents

Notices	vi
Safety information	vii
About this guide	viii
ASUS contact information	x
PSCH-L specifications summary	xi
Chapter 1: Product introduction	
1.1 Welcome!	1-1
1.2 Package contents	1-1
1.3 Special features	1-2
Chapter 2: Hardware information	
2.1 Before you proceed	2-1
2.2 Motherboard installation	2-2
2.2.1 Placement direction	2-2
2.2.2 Screw holes	2-2
2.2.3 Motherboard layout	2-3
2.2.4 Layout Contents	2-4
2.3 Central Processing Unit (CPU)	2-5
2.3.1 Overview	2-5
2.3.2 Installing the CPU	2-6
2.3.3 Installing the heatsink and fan	2-8
2.3.4 Connecting the CPU fan cable	2-10
2.4 System memory	2-11
2.4.1 Overview	2-11
2.4.2 Memory configurations	2-11
2.4.3 Installing a DIMM	2-13
2.4.4 Removing a DIMM	2-13
2.5 Expansion slots	2-14
2.5.1 Installing an expansion card	2-14
2.5.2 Configuring an expansion card	2-14
2.5.3 PCI slots	2-16
2.6 Jumpers	2-17
2.7 Connectors	2-19

Contents

Chapter 3: Powering up

- 3.1 Starting up for the first time 3-1
- 3.2 Powering off the computer 3-2

Chapter 4: BIOS setup

- 4.1 Managing and updating your BIOS 4-1
 - 4.1.1 Creating a bootable floppy disk 4-1
 - 4.1.2 Using AFUDOS to update the BIOS 4-2
 - 4.1.3 Using AFUDOS to copy BIOS from PC 4-3
 - 4.1.4 Recovering the BIOS with CrashFree BIOS 2 4-4
 - 4.1.5 ASUS Update 4-6
- 4.2 BIOS Setup program 4-8
 - 4.2.1 BIOS menu screen 4-9
 - 4.2.2 Menu bar 4-9
 - 4.2.3 Navigation keys 4-9
 - 4.2.4 Menu items 4-10
 - 4.2.5 Sub-menu items 4-10
 - 4.2.6 Configuration fields 4-10
 - 4.2.7 Pop-up window 4-10
 - 4.2.8 Scroll bar 4-10
 - 4.2.9 General help 4-10
- 4.3 Main menu 4-11
 - 4.3.1 System Information 4-11
 - 4.3.2 System Time 4-12
 - 4.3.3 System Date 4-12
 - 4.3.4 Floppy A 4-12
 - 4.3.5 Primary and Secondary IDE Master/Slave,
Third IDE/SATA, Fourth IDE/SATA 4-12
 - 4.3.6 Boot Options 4-14
 - 4.3.7 System Memory 4-17
- 4.4 Advanced menu 4-18
 - 4.4.1 CPU Configuration 4-18
 - 4.4.2 Chipset Configuration 4-20
 - 4.4.3 Super IO Configuration 4-21
 - 4.4.4 IDE Configuration 4-22
 - 4.4.5 USB Configuration 4-23
 - 4.4.6 ACPI Configuration 4-24
 - 4.4.7 PCI PnP Configuration 4-26

Contents

4.4.8	Hardware Health Configuration	4-28
4.4.9	Remote Access Configuration	4-29
4.5	Security menu	4-30
4.5.1	Set Setup/System Password Clear System Password	4-30
4.5.2	Setup Password Lock	4-31
4.5.3	System Password Mode	4-31
4.5.4	Boot Sector Virus Protection	4-31
4.5.5	Diskette Write	4-31
4.5.6	Flash Write	4-31
4.5.7	System Load	4-32
4.5.8	Setup Prompt	4-32
4.6	Power menu	4-33
4.6.1	Power Failure Recovery	4-33
4.6.2	Resume On Ring	4-33
4.6.2	Resume On LAN	4-33
4.6.3	Resume On RTC Alarm	4-33
4.7	Exit menu	4-34
4.7.1	Save Changes and Exit	4-34
4.7.2	Load Previous Values and Exit	4-34
4.7.3	Load Previous Values	4-34
4.7.4	Load Optimal Defaults	4-34

Appendix: Reference information

A.1	PSCH-L block diagram	A-1
-----	----------------------------	-----

Notices

Federal Communications Commission Statement

This device complies with Part 15 of the FCC Rules. Operation is subject to the following two conditions:

- This device may not cause harmful interference, and
- This device must accept any interference received including interference that may cause undesired operation.

This equipment has been tested and found to comply with the limits for a Class B digital device, pursuant to Part 15 of the FCC Rules. These limits are designed to provide reasonable protection against harmful interference in a residential installation. This equipment generates, uses and can radiate radio frequency energy and, if not installed and used in accordance with manufacturer's instructions, may cause harmful interference to radio communications. However, there is no guarantee that interference will not occur in a particular installation. If this equipment does cause harmful interference to radio or television reception, which can be determined by turning the equipment off and on, the user is encouraged to try to correct the interference by one or more of the following measures:

- Reorient or relocate the receiving antenna.
- Increase the separation between the equipment and receiver.
- Connect the equipment to an outlet on a circuit different from that to which the receiver is connected.
- Consult the dealer or an experienced radio/TV technician for help.



The use of shielded cables for connection of the monitor to the graphics card is required to assure compliance with FCC regulations. Changes or modifications to this unit not expressly approved by the party responsible for compliance could void the user's authority to operate this equipment.

Canadian Department of Communications Statement

This digital apparatus does not exceed the Class B limits for radio noise emissions from digital apparatus set out in the Radio Interference Regulations of the Canadian Department of Communications.

This class B digital apparatus complies with Canadian ICES-003.

Safety information

Electrical safety

- To prevent electrical shock hazard, disconnect the power cable from the electrical outlet before relocating the system.
- When adding or removing devices to or from the system, ensure that the power cables for the devices are unplugged before the signal cables are connected. If possible, disconnect all power cables from the existing system before you add a device.
- Before connecting or removing signal cables from the motherboard, ensure that all power cables are unplugged.
- Seek professional assistance before using an adapter or extension cord. These devices could interrupt the grounding circuit.
- Make sure that your power supply is set to the correct voltage in your area. If you are not sure about the voltage of the electrical outlet you are using, contact your local power company.
- If the power supply is broken, do not try to fix it by yourself. Contact a qualified service technician or your retailer.

Operation safety

- Before installing the motherboard and adding devices on it, carefully read all the manuals that came with the package.
- Before using the product, make sure all cables are correctly connected and the power cables are not damaged. If you detect any damage, contact your dealer immediately.
- To avoid short circuits, keep paper clips, screws, and staples away from connectors, slots, sockets and circuitry.
- Avoid dust, humidity, and temperature extremes. Do not place the product in any area where it may become wet.
- Place the product on a stable surface.
- If you encounter technical problems with the product, contact a qualified service technician or your retailer.

About this guide

This user guide contains the information you need when installing and configuring the motherboard.

How this guide is organized

This manual contains the following parts:

- **Chapter 1: Product introduction**
This chapter describes the features of the PSCH-L motherboard. It includes brief descriptions of the special attributes of the motherboard and the new technology it supports.
- **Chapter 2: Hardware installation**
This chapter lists the hardware setup procedures that you have to perform when installing system components. It includes description of the switches, jumpers, and connectors on the motherboard.
- **Chapter 3: Powering up**
This chapter describes the power up sequence and gives information on the BIOS beep codes.
- **Chapter 4: BIOS setup**
This chapter tells how to change system settings through the BIOS Setup menus. Detailed descriptions of the BIOS parameters are also provided.
- **Appendix: Reference information**
This appendix includes additional information that you may refer to when configuring the motherboard.

Conventions used in this guide

To make sure that you perform certain tasks properly, take note of the following symbols used throughout this manual.



WARNING: Information to prevent injury to yourself when trying to complete a task.



CAUTION: Information to prevent damage to the components when trying to complete a task.



IMPORTANT: Information that you **MUST** follow to complete a task.



NOTE: Tips and additional information to aid in completing a task.

Where to find more information

Refer to the following sources for additional information and for product and software updates.

1. ASUS Websites

The ASUS websites worldwide provide updated information on ASUS hardware and software products. Refer to the ASUS contact information.

2. Optional Documentation

Your product package may include optional documentation, such as warranty flyers, that may have been added by your dealer. These documents are not part of the standard package.

PSCH-L specifications summary

CPU	Socket 478 for Intel® Pentium® 4 Processor with Hyper-Threading Technology On-die 1MB/512KB L2 cache with full speed
Chipset	Intel E7210 MCH Intel 6300ESB ICH
Front Side Bus (FSB)	800/533 MHz
Memory	Dual-channel memory architecture 4 x 184-pin DDR DIMM sockets for up to 4GB memory Supports PC3200/2700/2100 unbuffered ECC or non-ECC DDR DIMMs
Expansion slots	2 x 3.3V/64-bit/66MHz PCI 3 x 5V/32-bit/33MHz PCI
Storage	Supported by South Bridge (6300ESB ICH) - 2 x UltraDMA100 connectors - 2 x Serial ATA connectors Supported by Promise® PDC20319 controller - 4 x Serial ATA connectors - RAID0, RAID1, RAID0+1, Multi-RAID configurations
LAN	Intel 82547GI Gigabit LAN controller
VGA	ATI RAGE-XL PCI-based VGA controller
Rear panel I/O	1 x Parallel port 1 x Serial port 1 x VGA port 1 x PS/2 keyboard port 1 x PS/2 mouse port 2 x USB 2.0 ports 1 x RJ-45 port
Internal I/O	1 x USB 2.0 connectors for 2 additional USB ports CPU/SYSTEM/AUX fan connectors 20-pin/4-pin ATX 12V power connectors HD LED/Power LED connectors Chassis intrusion connector Serial port 2 (COM2) connector
BIOS features	4Mb Flash ROM, AMI BIOS, PnP, DMI2.0, WfM2.0, SM BIOS2.3
Industry standard	PCI 2.2, PCI 2.3, USB 2.0

(continued on the next page)

Manageability	WfM 2.0, DMI 2.0, WOL/WOR by PME, chassis intrusion
Power requirement	ATX power supply (with 4-pin 12V plug)
Form Factor	ATX form factor: 12 in x 9.6 in (30.5 cm x 24.5 cm)
Support CD contents	Device drivers Management software System utilities ASUS contact information

**Specifications are subject to change without notice.*

Chapter 1

This chapter describes the features of the motherboard. It includes brief explanations of the special attributes of the motherboard and the new technology it supports.

Product introduction

Chapter summary

1.1	Welcome!	1-1
1.2	Package contents	1-1
1.3	Special features	1-2

1.1 Welcome!

Thank you for buying the ASUS® PSCH-L motherboard!

The ASUS PSCH-L motherboard delivers a host of new features and latest technologies making it another standout in the long line of ASUS quality motherboards!

The motherboard incorporates the Intel® Pentium® 4 (Northwood/Prescott) processor in 478-pin package coupled with the Intel® E7210/6300ESB chipset to provide a powerful entry server platform.

Supporting 800MHz FSB, up to 4GB of system memory with PC3200/2700/2100 DDR SDRAM, onboard high-resolution graphics, Serial ATA support, and USB 2.0, the PSCH-L is your perfect vehicle to get ahead in the world of power computing!

Before you start installing the motherboard, and hardware devices on it, check the items in your package with the list below.

1.2 Package contents

Check your PSCH-L package for the following items.

- ✓ ASUS PSCH-L motherboard
- ✓ ASUS support CD
- ✓ 6 x SATA cables
- ✓ SATA power cable
- ✓ 2 x 80-conductor ribbon cables for UltraDMA/133 IDE drives
- ✓ 40-conductor IDE cable
- ✓ Ribbon cable for a 3.5-inch floppy drive
- ✓ I/O shield
- ✓ Bag of extra jumper caps
- ✓ User Guide



If any of the above items is damaged or missing, contact your retailer.

1.3 Special features

Latest processor technology

The motherboard supports the latest Intel® Pentium® 4 processor via a 478-pin surface mount ZIF socket. The processor with 1MB/512KB L2 cache includes a 800/533 MHz system bus and features the Intel Hyper-Threading Technology and new power design that allow up to 3.4+GHz core frequencies.

Dual-channel DDR400 memory support

Employing the dual-channel DDR memory architecture, the motherboard provides a solution that doubles the system memory bandwidth to boost system performance. The motherboard supports up to 4GB of system memory using PC3200/2700/2100 ECC or non-ECC DDR DIMMs to deliver up to 6.4GB/s data transfer rate for the latest 3D graphics, multimedia, and Internet applications.

Serial ATA technology

The motherboard supports the new Serial ATA technology through the SATA interfaces and the Intel® 6300ESB ICH and Promise® PDC20319 controllers onboard. The SATA specification allows for thinner, more flexible cables with lower pin count, reduced voltage requirement, and up to 150MB/s data transfer rate.

Multi-RAID solution

The motherboard has the Promise® PDC20319 controller to support multi-RAID solution using Serial ATA/150 hard disks. The RAID0 (striping), RAID1 (mirroring), and RAID 0+1 provide a cost-effective high-performance solution for added system performance and reliability.

Gigabit LAN solution

The Intel® 82547GI Gigabit Ethernet controller allows full-duplex Gigabit performance on LAN on Motherboard (LOM) applications through the Communication Streaming Architecture (CSA). Instead of connecting to the PCI bus, the controller connects to the dedicated CSA bus on the Memory Controller Hub (MCH) thus reducing the PCI bottlenecks by freeing the PCI bus for other I/O operations.

USB 2.0 technology

The motherboard implements the Universal Serial Bus (USB) 2.0 specification, dramatically increasing the connection speed from the 12 Mbps bandwidth on USB 1.1 to a fast 480 Mbps on USB 2.0. USB 2.0 is backward compatible with USB 1.1.

Chapter 2

This chapter describes the hardware setup procedures that you have to perform when installing system components. It includes details on the switches, jumpers, and connectors on the motherboard.

Hardware information

Chapter summary

2.1	Before you proceed	2-1
2.2	Motherboard installation	2-2
2.3	Central Processing Unit (CPU)	2-5
2.4	System memory	2-11
2.5	Expansion slots	2-14
2.6	Jumpers	2-17
2.7	Connectors	2-19

2.1 Before you proceed

Take note of the following precautions before you install motherboard components or change any motherboard settings.



1. Unplug the power cord from the wall socket before touching any component.
2. Use a grounded wrist strap or touch a safely grounded object or to a metal object, such as the power supply case, before handling components to avoid damaging them due to static electricity.
3. Hold components by the edges to avoid touching the ICs on them.
4. Whenever you uninstall any component, place it on a grounded antistatic pad or in the bag that came with the component.
5. **Before you install or remove any component, ensure that the ATX power supply is switched off or the power cord is detached from the power supply.** Failure to do so may cause severe damage to the motherboard, peripherals, and/or components.



When lighted, the green LED (SB_PWR1) indicates that the system is ON, in sleep mode, or in soft-off mode, a reminder that you should shut down the system and unplug the power cable before removing or plugging in any motherboard component.

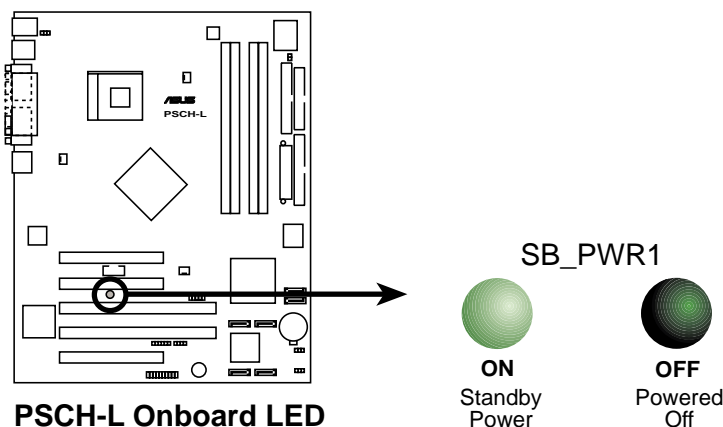

2.2 Motherboard installation

Before you install the motherboard, study the configuration of your chassis to ensure that the motherboard fits into it.



Make sure to unplug the power cord before installing or removing the motherboard. Failure to do so may cause you physical injury and damage motherboard components.

2.2.1 Placement direction

When installing the motherboard, make sure that you place it into the chassis in the correct orientation. The edge with external ports goes to the rear part of the chassis as indicated in the image below.

2.2.2 Screw holes

Place nine (9) screws into the holes indicated by circles to secure the motherboard to the chassis.



Do not overtighten the screws! Doing so may damage the motherboard.

Place this side towards the rear of the chassis

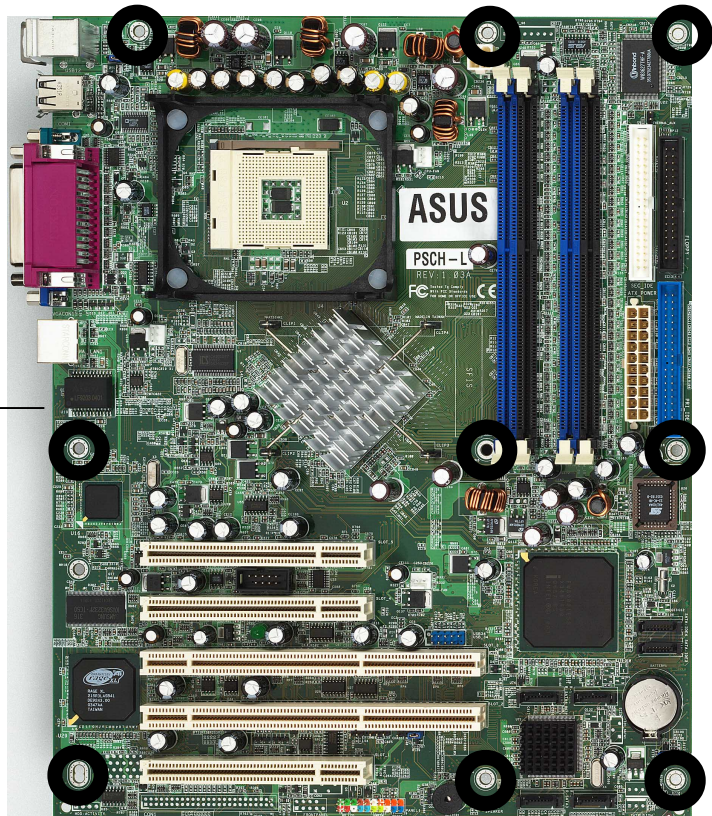

2.2.3 Motherboard layout

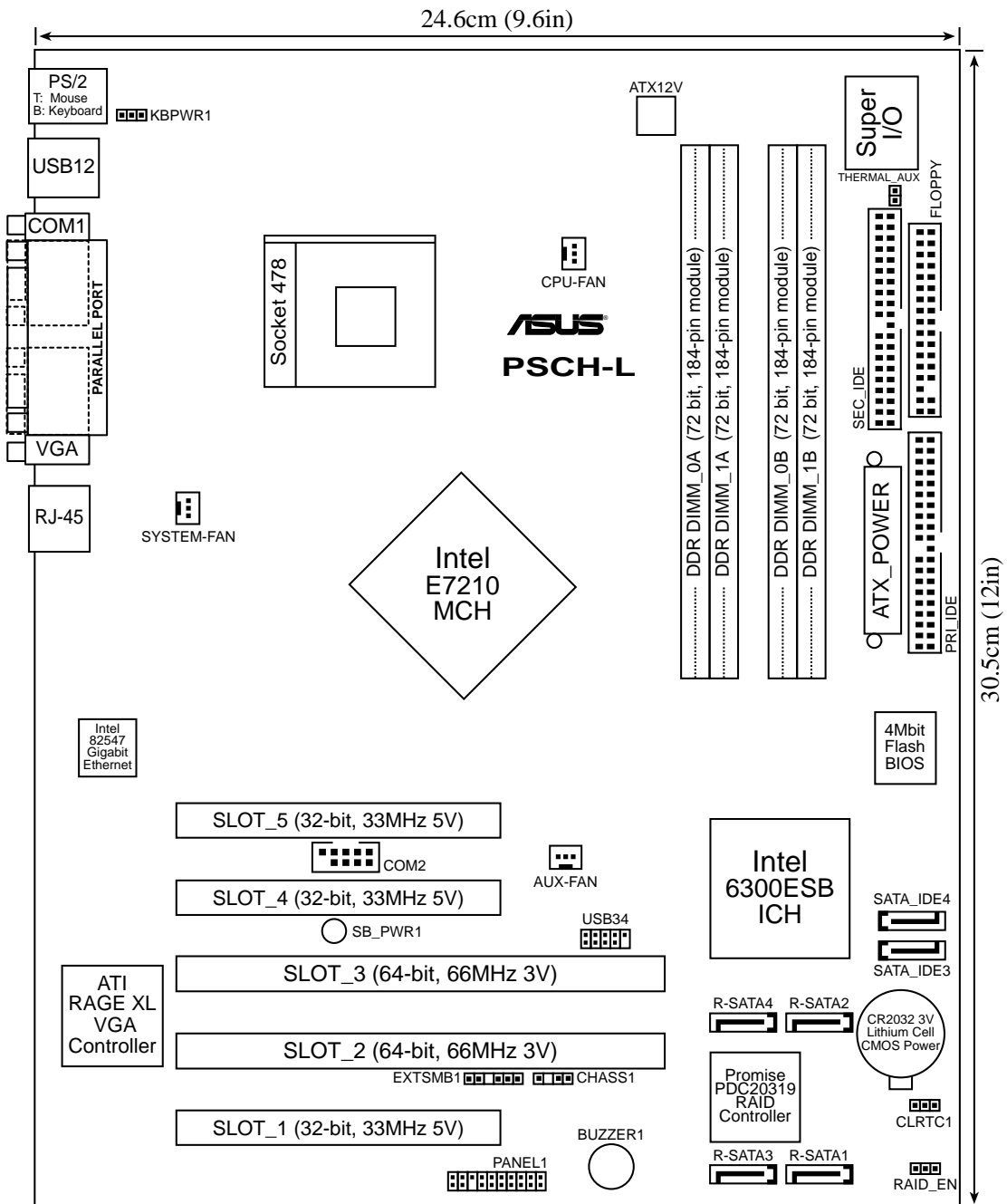

2.2.4 Layout Contents

Slots	Page
1. DDR DIMM	2-11
2. PCI	2-16
Jumpers	
1. Keyboard power (3-pin KBPWR)	2-17
2. RAID enable (3-pin RAID_EN)	2-17
3. Clear RTC RAM (3-pin CLRRTC)	2-18
Rear panel connectors	
1. PS/2 mouse port	2-19
2. Parallel port	2-19
3. PS/2 keyboard port	2-19
4. USB 2.0 ports 1 and 2	2-19
5. Serial port	2-19
6. Video port	2-19
7. RJ-45 port	2-19
Internal connectors	
1. Floppy disk drive connector (34-1 pin FLOPPY)	2-20
2. SMBus connector (6-1 pin EXTSMB1)	2-20
3. IDE connectors (40-1 pin PRI_IDE, SEC_IDE)	2-21
4. Serial ATA connectors (7-pin SATA-IDE3, SATA-IDE4)	2-22
5. Serial ATA RAID connectors (7-pin R-SATA1, R-SATA2, R-SATA3, R-SATA4)	2-22
6. Chassis intrusion connector (4-1 pin CHASS1)	2-23
7. Power supply thermal connector (2-pin THERMAL_AUX)	2-23
8. CPU, System, and Auxiliary fan connectors (3-pin CPU-FAN, SYSTEM-FAN, AUX-FAN)	2-24
9. Serial port 2 connector (10-2 pin COM2)	2-24
10. ATX power connectors (20-pin ATXPWR, 4-pin ATX12V)	2-25
11. USB header (10-1 pin USB34)	2-26
12. System panel connector (20-pin PANEL)	2-26
- System power LED (3-1 pin PLED)	
- Message LED (2-pin MLED)	
- System warning speaker (4-pin SPEAKER)	
- Hard disk activity LED (2-pin HD_LED)	
- System management interrupt (2-pin SMI)	
- ATX power switch/Soft-off switch (2-pin PWRSW)	
- Reset switch (2-pin RESET)	

2.3 Central Processing Unit (CPU)

2.3.1 Overview

The motherboard comes with a surface mount 478-pin Zero Insertion Force (ZIF) socket designed for the Intel® Pentium® 4 processor.

Take note of the marked corner (with gold triangle) on the CPU. This mark should match a specific corner on the socket to ensure correct installation.

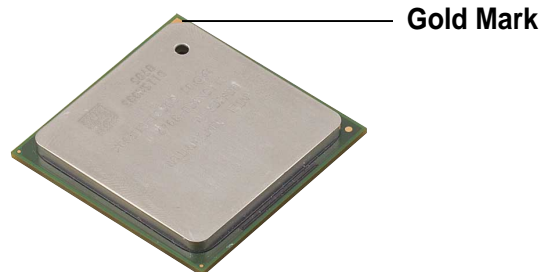

Notes on Intel® Hyper-Threading Technology



1. This motherboard supports Intel Pentium 4 CPUs with Hyper-Threading Technology.
2. Hyper-Threading Technology is supported under **Windows XP** and **Linux 2.4.x (kernel)** and later versions only. Under Linux, use the Hyper-Threading compiler to compile the code. If you are using any other operating systems, disable the Hyper-Threading Technology item in BIOS to ensure system stability and performance.
3. It is recommended that you install WinXP Service Pack 1.
4. Make sure to enable the Hyper-Threading Technology item in BIOS before installing a supported operating system.
5. For more information on Hyper-Threading Technology, visit www.intel.com/info/hyperthreading.

To use the Hyper-Threading Technology on this motherboard:

1. Buy an Intel Pentium 4 CPU that supports Hyper-Threading Technology. Install the CPU.
2. Power up the system and enter BIOS Setup (see Chapter 4). Under the Advanced Menu, make sure that the item **Hyper-Threading Technology** is set to Enabled. The item appears only if you installed a CPU that supports Hyper-Threading Technology.
3. Reboot the computer.

2.3.2 Installing the CPU

Follow these steps to install a CPU.

1. Locate the 478-pin ZIF socket on the motherboard.

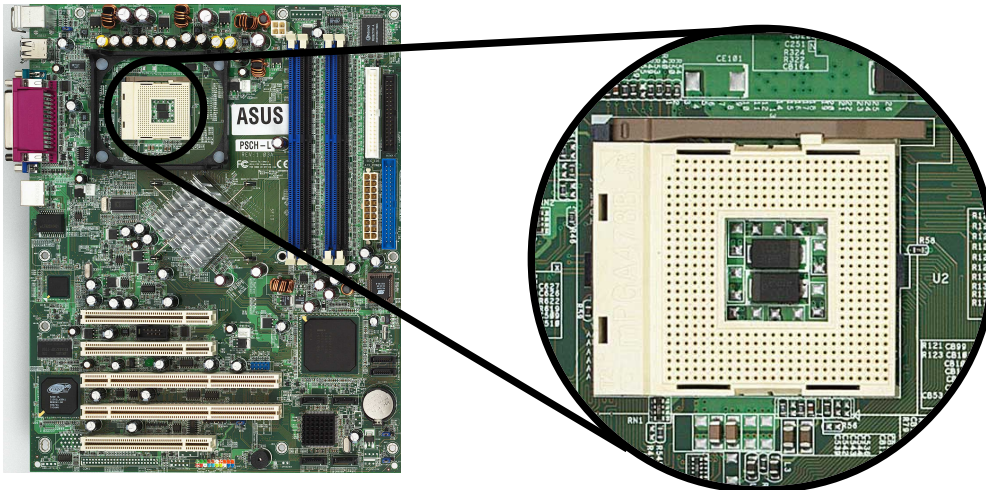

2. Unlock the socket by pressing the lever sideways, then lift it up to a 90°-100° angle.

Socket Lever

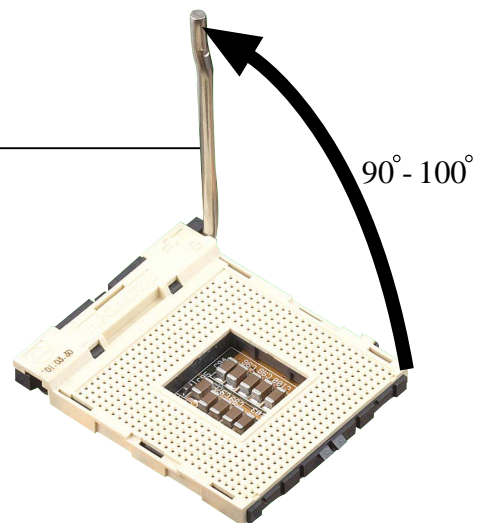

Make sure that the socket lever is lifted up to 90°-100° angle, otherwise the CPU does not fit in completely.

3. Position the CPU above the socket such that its marked corner matches the base of the socket lever.
4. Carefully insert the CPU into the socket until it fits in place.

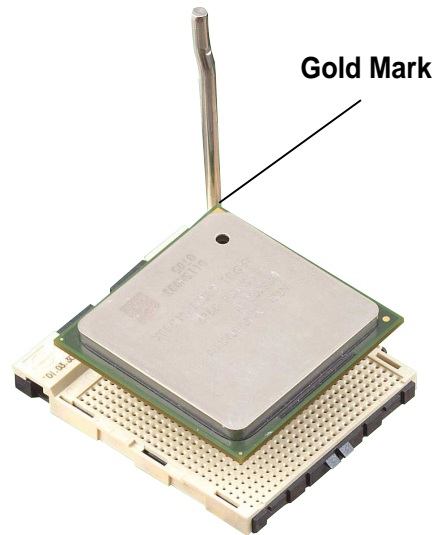

The CPU fits only in one correct orientation. **DO NOT** force the CPU into the socket to prevent bending the pins and damaging the CPU!

5. When the CPU is in place, push down the socket lever to secure the CPU. The lever clicks on the side tab to indicate that it is locked.

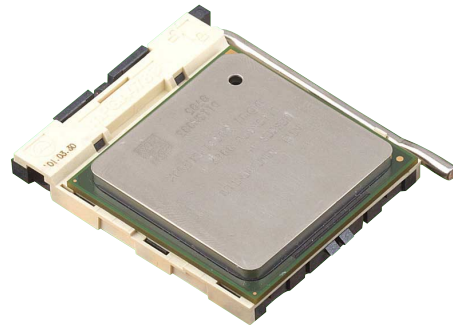

2.3.3 Installing the heatsink and fan

The Intel® Pentium® 4 Processor requires a specially designed heatsink and fan assembly to ensure optimum thermal condition and performance.



When you buy a boxed Intel Pentium 4 Processor, the package includes the heatsink, fan, and retention mechanism.

In case you buy a CPU separately, make sure that you use only Intel certified heatsink and fan.

Follow these steps to install the CPU heatsink and fan.

1. Place the heatsink on top of the installed CPU, making sure that the heatsink fits properly on the retention module base.



The retention module base is already installed on the motherboard upon purchase.

You do not have to remove the retention module base when installing the CPU or installing other motherboard components.

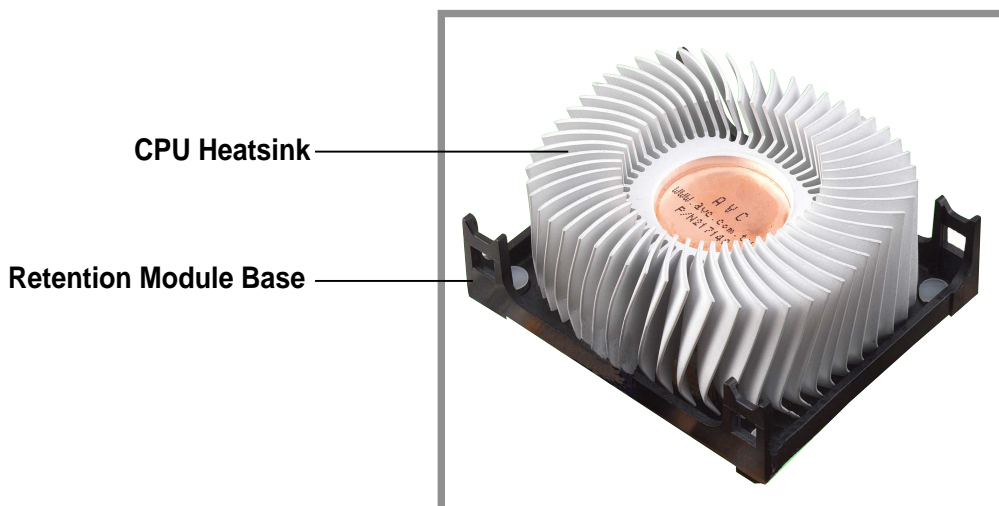

Your boxed Intel Pentium 4 Processor package should come with installation instructions for the CPU, heatsink, and the retention mechanism. If the instructions in this section do not match the CPU documentation, follow the latter.

2. Position the fan with the retention mechanism on top of the heatsink. Align and snap the four hooks of the retention mechanism to the holes on each corner of the module base.



Make sure that the fan and retention mechanism assembly perfectly fits the heatsink and module base, otherwise you cannot snap the hooks into the holes.

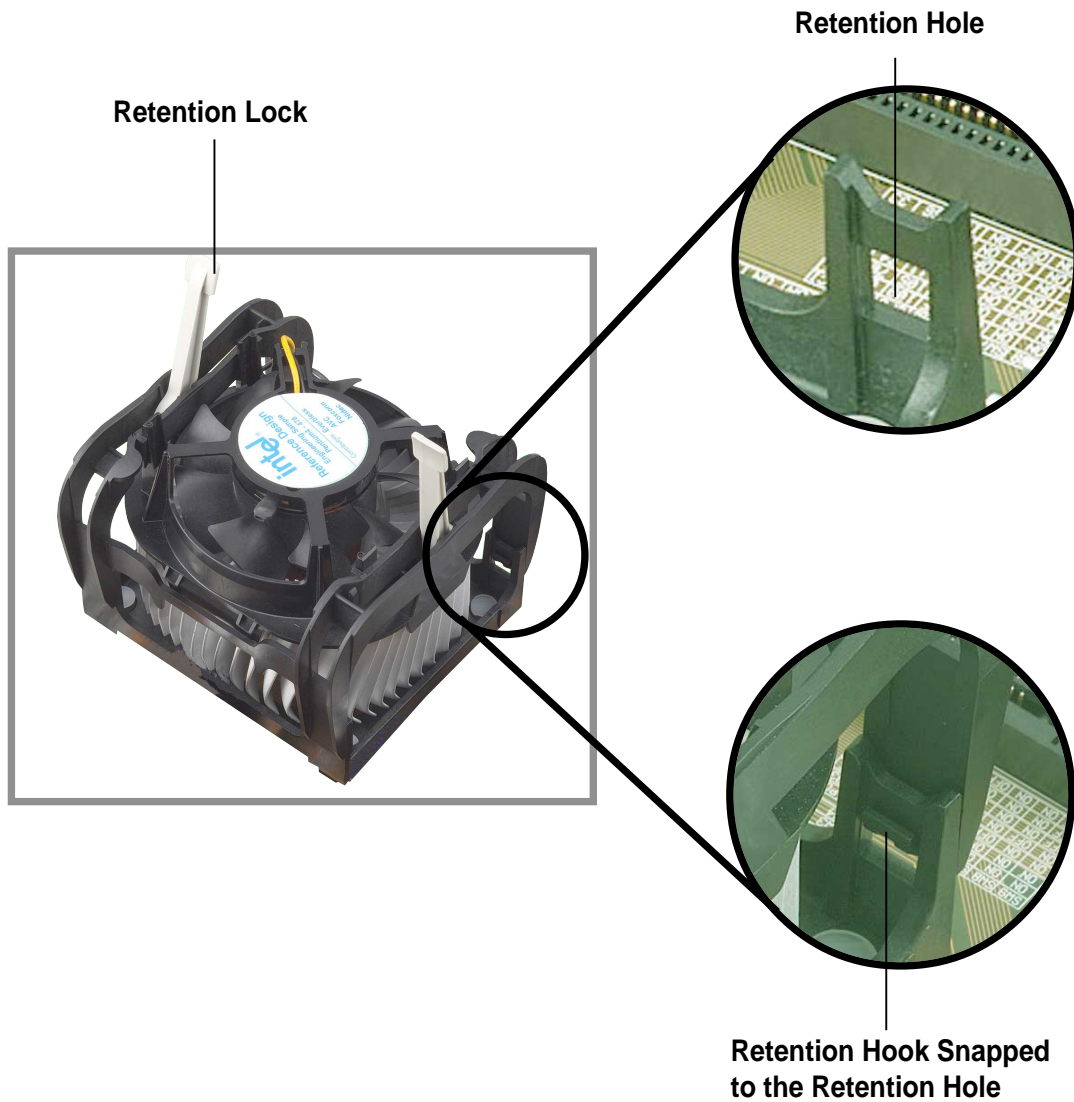

Keep the retention locks lifted upward while fitting the retention mechanism to the module base.

3. Push down the locks on the retention mechanism to secure the heatsink and fan to the module base.



When secure, the retention locks should point to opposite directions.



2.3.4 Connecting the CPU fan cable

When the fan, heatsink, and the retention mechanism are in place, connect the CPU fan cable to the connector on the motherboard labeled CPU_FAN.

CPU Fan Connector
(CPU_FAN)

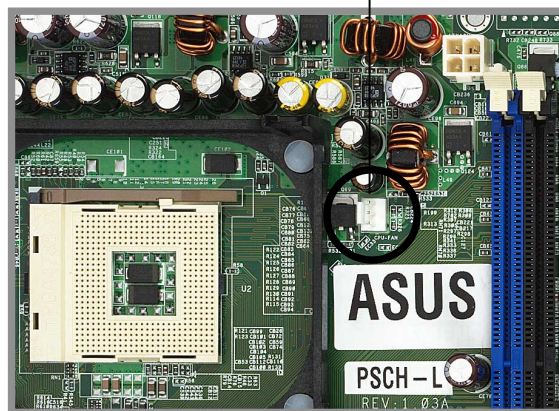

Don't forget to connect the CPU fan connector! Hardware monitoring errors may occur if you fail to plug this connector.

2.4 System memory

2.4.1 Overview

The motherboard comes with four Double Data Rate (DDR) Dual Inline Memory Module (DIMM) sockets.

The following figure illustrates the location of the DDR DIMM sockets.

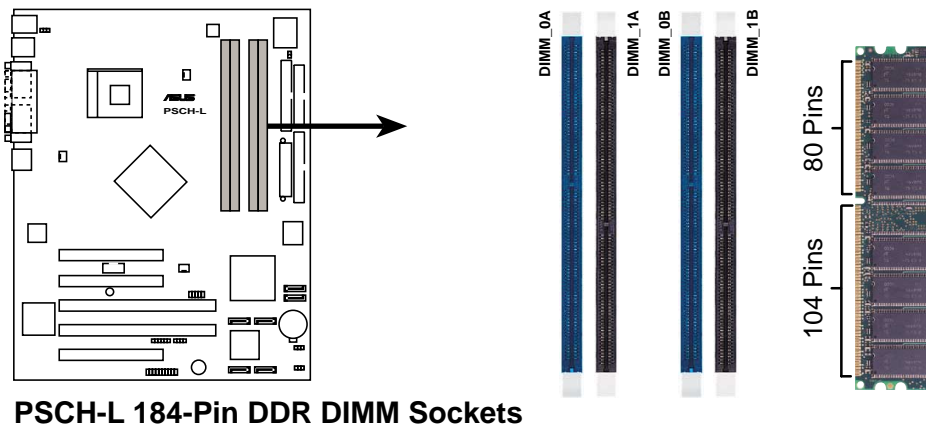

PSCH-L 184-Pin DDR DIMM Sockets

2.4.2 Memory configurations

You may install 64MB, 128MB, 256MB, 512MB, and 1GB DDR DIMMs into the DIMM sockets using the memory configurations in this section.

Important notes



1. Installing DDR DIMMs other than the recommended configurations may cause memory sizing error or system boot failure. Use any of the recommended configurations in Table 1.
2. In dual-channel configurations, install only **identical** (the same type and size) DDR DIMM pairs for each channel.
3. Always install DIMMs with the same CAS latency. For optimum compatibility, it is recommended that you obtain memory modules from the same vendor.
4. Make sure that the memory frequency matches the CPU FSB (Front Side Bus). Refer to Table 2.
5. DIMMs installed into **any three** sockets will function in single-channel mode.

Table 1 Recommended memory configurations

Mode		Sockets			
		DIMM_0A (blue)	DIMM_1A (black)	DIMM_0B (blue)	DIMM_1B (black)
Single-channel	(1)	Populated	—	—	—
	(2)	—	Populated	—	—
	(3)	—	—	Populated	—
	(4)	—	—	—	Populated
Dual-channel	(1)	Populated	—	Populated	—
	(2)	—	Populated	—	Populated
	(3)*	Populated	Populated	Populated	Populated

* For dual-channel configuration (3), you may:

- install identical DIMMs in all four sockets
- or
- install identical DIMM pair in DIMM_0A and DIMM_0B (blue sockets) and identical DIMM pair in DIMM_1A and DIMM_1B (black sockets)

Table 2 Memory frequency/CPU FSB synchronization

CPU FSB	DDR DIMM Type	Memory Frequency
800 MHz	PC3200/PC2700*/PC2100	400/333*/266 MHz
533 MHz	PC2700/PC2100	333/266 MHz



Obtain DDR DIMMs only from ASUS qualified vendors for better system performance. Visit the ASUS website (www.asus.com) for the latest QVL.

2.4.3 Installing a DIMM



Make sure to unplug the power supply before adding or removing DIMMs or other system components. Failure to do so may cause severe damage to both the motherboard and the components.

Follow these steps to install a DIMM.

1. Unlock a DIMM socket by pressing the retaining clips outward.
2. Align a DIMM on the socket such that the notch on the DIMM matches the break on the socket.

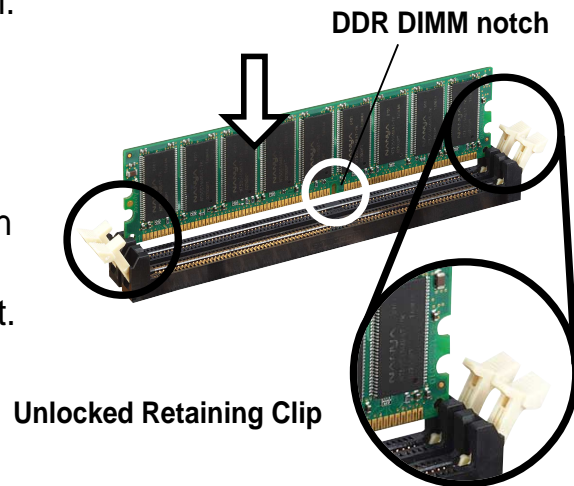

A DDR DIMM is keyed with a notch so that it fits in only one direction. DO NOT force a DIMM into a socket to avoid damaging the DIMM.

3. Firmly insert the DIMM into the socket until the retaining clips snap back in place and the DIMM is properly seated.

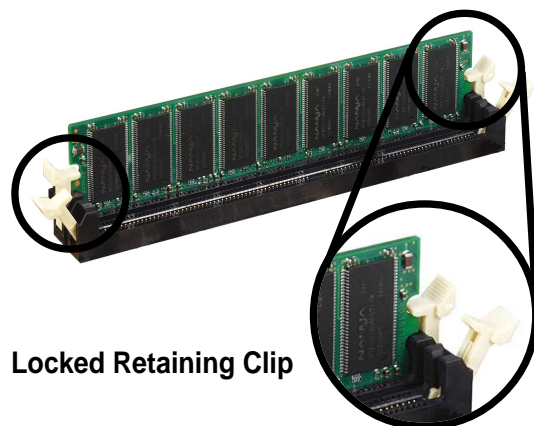

2.4.4 Removing a DIMM

Follow these steps to remove a DIMM.

1. Simultaneously press the retaining clips outward to unlock the DIMM.

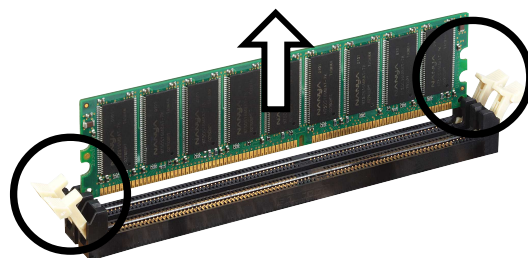

Support the DIMM lightly with your fingers when pressing the retaining clips. The DIMM might get damaged when it flips out with extra force.

2. Remove the DIMM from the socket.

2.5 Expansion slots

In the future, you may need to install expansion cards. The motherboard has two 64-bit and three 32-bit PCI slots. The following sub-sections describe the slots and the expansion cards that they support.



Make sure to unplug the power cord before adding or removing expansion cards. Failure to do so may cause you physical injury and damage motherboard components.

2.5.1 Installing an expansion card

Follow these steps to install an expansion card.

1. Before installing the expansion card, read the documentation that came with it and make the necessary hardware settings for the card.
2. Remove the system unit cover (if your motherboard is already installed in a chassis).
3. Remove the bracket opposite the slot that you intend to use. Keep the screw for later use.
4. Align the card connector with the slot and press firmly until the card is completely seated on the slot.
5. Secure the card to the chassis with the screw you removed earlier.
6. Replace the system cover.

2.5.2 Configuring an expansion card

After installing the expansion card, configure the it by adjusting the software settings.

1. Turn on the system and change the necessary BIOS settings, if any. See Chapter 4 for information on BIOS setup.
2. Assign an IRQ to the card. Refer to the tables on the next page.
3. Install the software drivers for the expansion card.

Standard Interrupt Assignments

IRQ	Priority	Standard Function
0	1	System Timer
1	2	Keyboard Controller
2	N/A	Programmable Interrupt
3*	11	Communications Port (COM2)
4*	12	Communications Port (COM1)
5*	13	Sound Card (sometimes LPT2)
6	14	Floppy Disk Controller
7*	15	Printer Port (LPT1)
8	3	System CMOS/Real Time Clock
9*	4	ACPI Mode when used
10*	5	IRQ Holder for PCI Steering
11*	6	IRQ Holder for PCI Steering
12*	7	PS/2 Compatible Mouse Port
13	8	Numeric Data Processor
14*	9	Primary IDE Channel
15*	10	Secondary IDE Channel

* These IRQs are usually available for ISA or PCI devices.

IRQ assignments for this motherboard

	A	B	C	D	E	F	G	H	PXIRQ0	PXIRQ1	PXIRQ2	PXIRQ3
PCI slot 1	—	—	—	—	shared	shared	shared	shared	—	—	—	—
PCI slot 2	—	—	—	—	shared	shared	shared	shared	—	—	—	—
PCI slot 3	—	—	—	—	—	—	—	—	shared	shared	shared	shared
PCI slot 4	—	—	—	—	—	—	—	—	shared	shared	shared	shared
PCI slot 5	—	—	—	—	shared	shared	shared	shared	—	—	—	—
Onbd. USB contr. HC0	shared	—	—	—	—	—	—	—	—	—	—	—
Onbd. USB contr. HC1	—	—	—	used	—	—	—	—	—	—	—	—
Onbd. USB contr. HC2	—	—	used	—	—	—	—	—	—	—	—	—
Onbd. USB contr. HC3	shared	—	—	—	—	—	—	—	—	—	—	—
Onbd. USB 2.0 contr.	—	—	—	—	—	—	—	shared	—	—	—	—
Onbd. LAN	—	—	—	—	—	—	shared	—	—	—	—	—
Onbd. VGA controller	shared	—	—	—	—	—	—	—	—	—	—	—
Onbd. RAID controller	—	—	—	—	—	—	—	—	—	—	—	shared



When using PCI cards on shared slots, ensure that the drivers support “Share IRQ” or that the cards do not need IRQ assignments. Otherwise, conflicts will arise between the two PCI groups, making the system unstable and the card inoperable.

2.5.3 PCI slots

The PCI slots support PCI cards such as a LAN card, SCSI card, USB card, and other cards that comply with PCI specifications.



When installing long PCI cards, it is recommended that you install them in PCI slots 1, 4, or 5. Long PCI cards installed in PCI slots 2 and 3 may interfere with the SATA connectors.

2.6 Jumpers

1. Keyboard power (3-pin KBPWR)

This jumper allows you to enable or disable the keyboard wake-up feature. Set this jumper to pins 2-3 (+5VSB) if you wish to wake up the computer when you press a key on the keyboard (the default is the Space Bar). This feature requires an ATX power supply that can supply at least 1A on the +5VSB lead, and a corresponding setting in the BIOS (see section 4.5.1 Power Up Control).

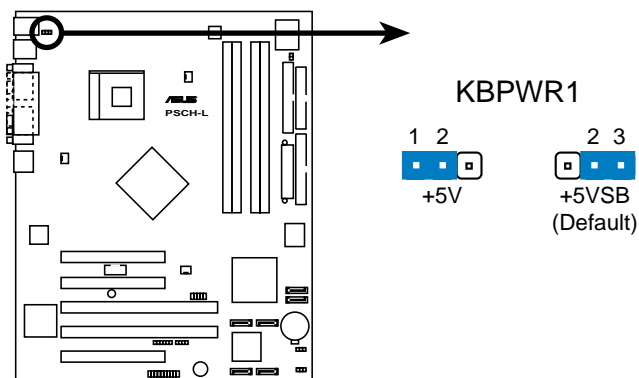

PSCH-L Keyboard Power Setting

2. RAID enable (3-pin RAID_EN)

This jumper allows you enable or disable the onboard RAID feature.

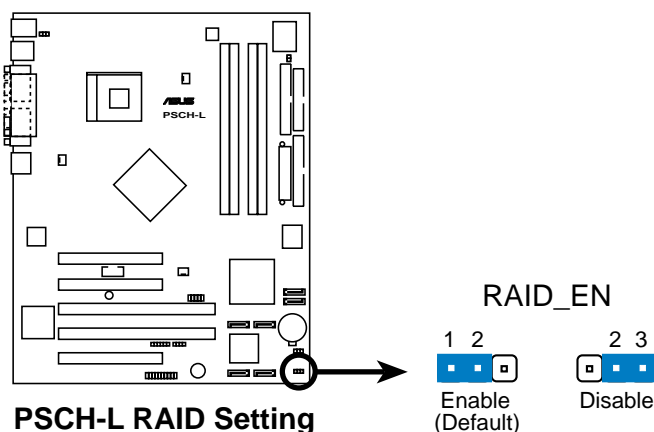

PSCH-L RAID Setting

3. Clear RTC RAM (3-pin CLRTC1)

This jumper allows you to clear the Real Time Clock (RTC) RAM in CMOS. You can clear the CMOS memory of date, time, and system setup parameters by erasing the CMOS RTC RAM data. The RAM data in CMOS, that include system setup information such as system passwords, is powered by the onboard button cell battery.

To erase the RTC RAM:

1. Turn OFF the computer and unplug the power cord.
2. Move the jumper cap from pins 1-2 (default) to pins 2-3. Keep the cap on pins 2-3 for about 5~10 seconds, then move the cap back to pins 1-2.
3. Plug the power cord and turn ON the computer.
4. Hold down the key during the boot process and enter BIOS setup to re-enter data.

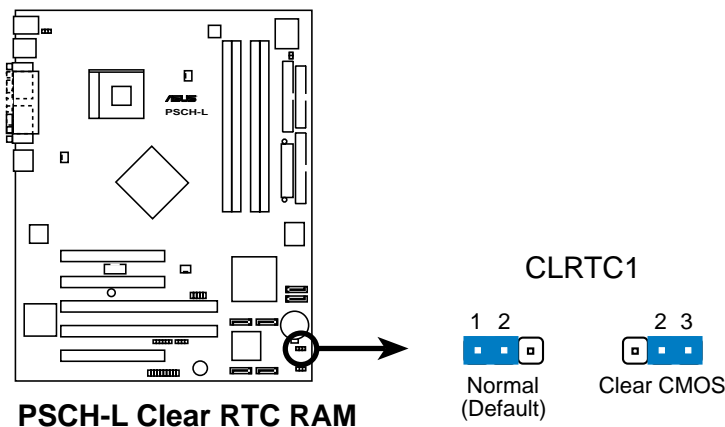

Except when clearing the RTC RAM, never remove the cap on CLRTC jumper default position. Removing the cap will cause system boot failure!

2.7 Connectors

2.7.1 Rear panel connectors

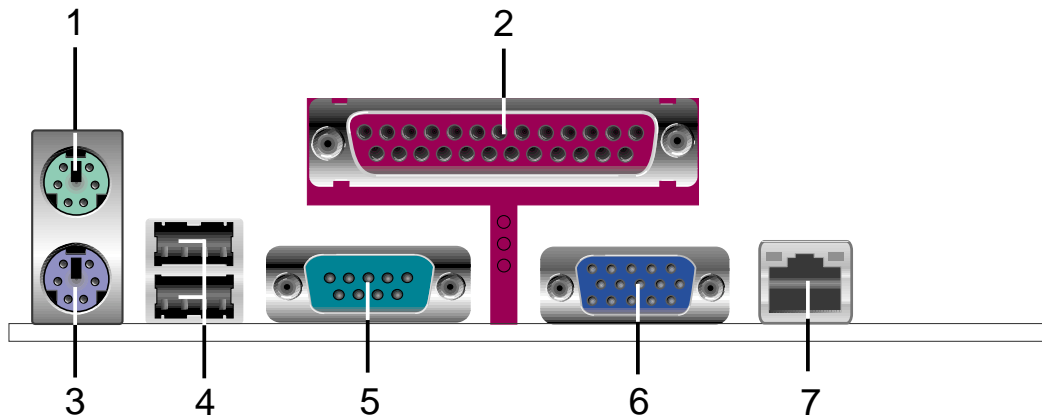

1. **PS/2 mouse port.** This green 6-pin connector is for a PS/2 mouse.
2. **Parallel port.** This 25-pin port connects a parallel printer, a scanner, or other devices.
3. **PS/2 keyboard port.** This purple connector is for a PS/2 keyboard.
4. **USB 2.0 ports 1 and 2.** These two 4-pin Universal Serial Bus (USB) ports are available for connecting USB 2.0 devices.
5. **Serial port .** This 9-pin COM1 port is for serial devices.
6. **Video port.** This port is for a VGA monitor or other VGA-compatible devices.
7. **RJ-45 port.** This port allows connection to a Local Area Network (LAN) through a network hub.

2.7.2 Internal connectors

1. Floppy disk drive connector (34-1 pin FLOPPY)

This connector supports the provided floppy drive ribbon cable. After connecting one end to the motherboard, connect the other end to the floppy drive. (Pin 5 is removed to prevent incorrect insertion when using ribbon cables with pin 5 plug).

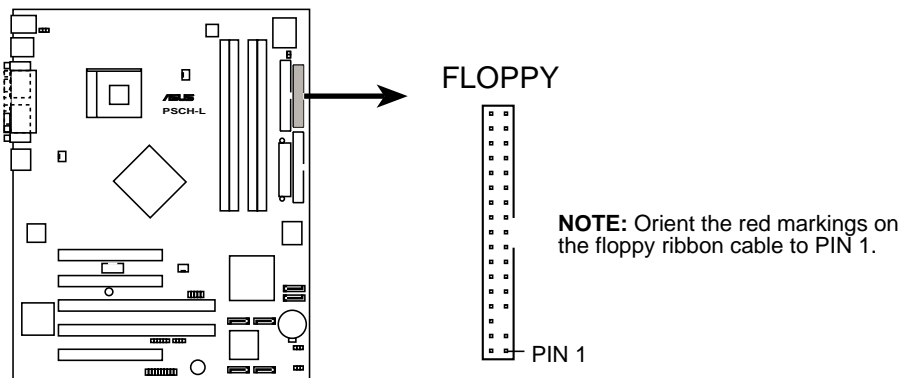

PSCH-L Floppy Disk Drive Connector

2. SMBus connector (6-1 pin EXTSMB1)

This connector allows you to connect SMBus (System Management Bus) devices. Devices communicate with an SMBus host and/or other SMBus devices using the SMBus interface.

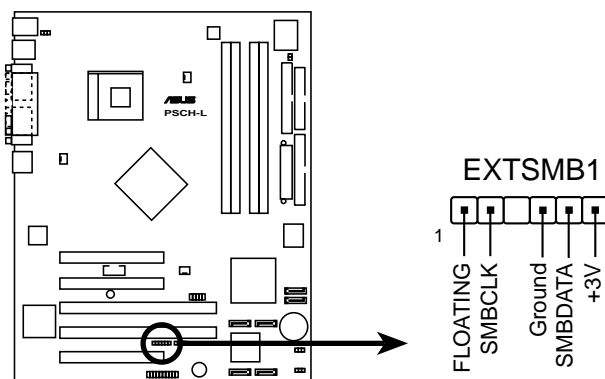

PSCH-L SMBus Connector

3. IDE connectors (40-pin PRI_IDE[blue], SEC_IDE [black])

This connector supports the provided UltraDMA/100/66 IDE hard disk ribbon cable. Connect the cable's blue connector to the primary (recommended) or secondary IDE connector, then connect the gray connector to the UltraDMA/100/66 slave device (hard disk drive) and the black connector to the UltraDMA/100/66 master device. It is recommended that you connect non-UltraDMA/100/66 devices to the secondary IDE connector. If you install two hard disks, you must configure the second drive as a slave device by setting its jumper accordingly. Refer to the hard disk documentation for the jumper settings. BIOS supports specific device bootup. You may configure two hard disks to be both master devices with two ribbon cables – one for the primary IDE connector and another for the secondary IDE connector.



1. Pin 20 on each IDE connector is removed to match the covered hole on the UltraDMA cable connector. This prevents incorrect orientation when you connect the cables.
2. The hole near the blue connector on the UltraDMA/100/66 cable is intentional.
3. For UltraDMA/100/66 IDE devices, use the 80-conductor IDE cable.

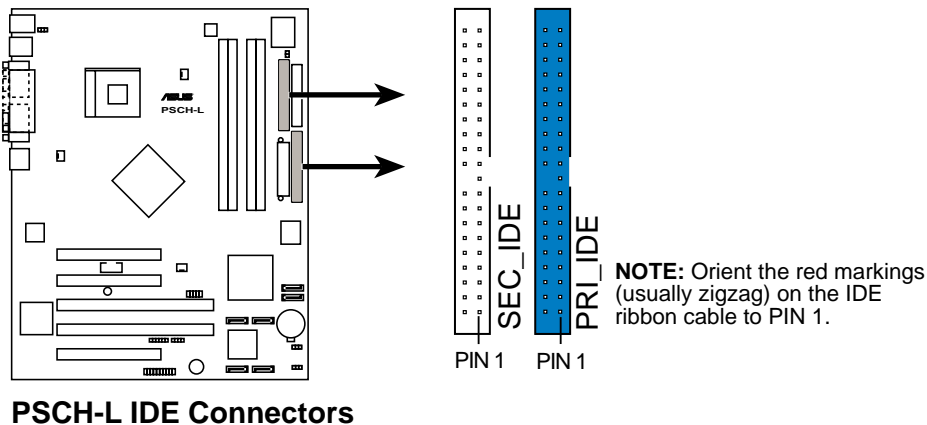

4. Serial ATA connectors (7-pin SATA-IDE3, SATA-IDE4)

These next generation connectors support the thin Serial ATA cables for Serial ATA hard disks. The current Serial ATA interface allows up to 150 MB/s data transfer rate, faster than the standard parallel ATA with 133 MB/s (Ultra ATA/133).

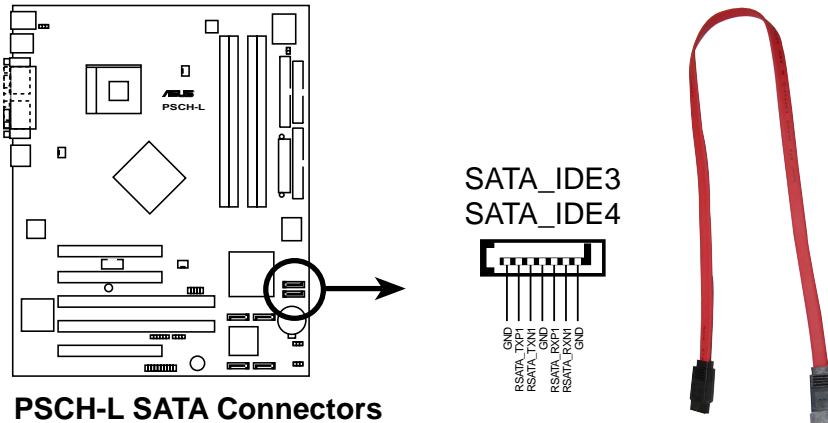

5. Serial ATA RAID connectors (7-pin R-SATA1, R-SATA2, R-SATA3, R-SATA4)

These Serial ATA connectors support SATA hard disks that you may configure as a RAID set. Through the onboard Promise® PDC20319 RAID controller, you may create a RAID0, RAID1, RAID0+1, or multi-RAID configuration.

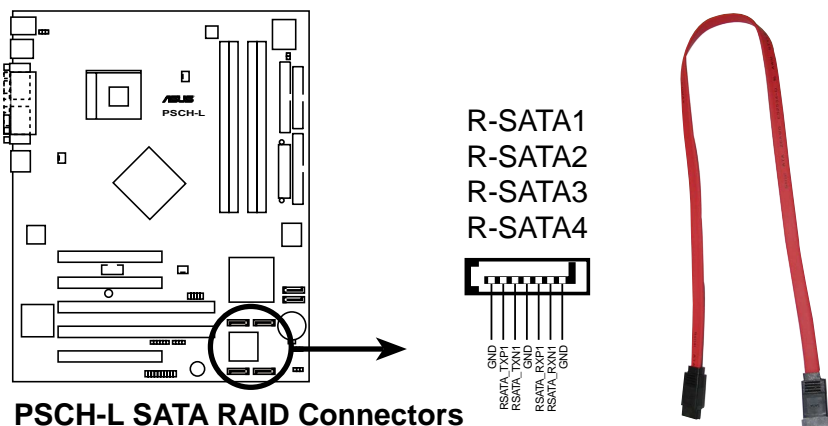

1. If you wish to create a RAID set, make sure that you have connected the SATA cable and installed Serial ATA devices. You cannot enter the SATA RAID™ utility and SATA BIOS setup during POST if there are no connected Serial ATA devices.
2. The Promise® PDC20319 RAID controller does not support ATAPI devices such as CD-ROMs, DVD-ROMs, etc.

6. Chassis intrusion connector (4-1 pin CHASS1)

This lead is for a chassis designed with intrusion detection feature. This requires an external detection mechanism such as a chassis intrusion sensor or microswitch. When you remove any chassis component, the sensor triggers and sends a high-level signal to this lead to record a chassis intrusion event.

By default, the pins labeled “Chassis Signal” and “Ground” are shorted with a jumper cap. If you wish to use the chassis intrusion detection feature, remove the jumper cap from the pins.

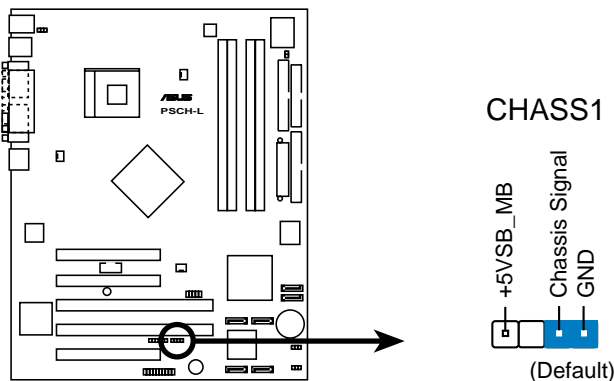

PSCH-L Chassis Intrusion Connector

7. Power supply thermal connector (2-pin THERMAL_AUX)

If your power supply has a thermal monitoring feature, connect its thermal sensor cable to this connector.

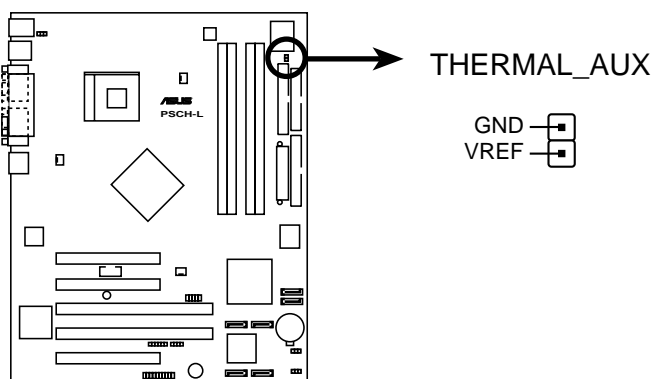

PSCH-L Thermal Connector

8. CPU, System, and Auxiliary fan connectors (3-pin CPU-FAN, SYSTEM-FAN, AUX-FAN)

The fan connectors support cooling fans of 350mA~740mA (8.88W max.) or a total of 1A~2.22A (26.64W max.) at +12V. Connect the fan cables to the fan connectors on the motherboard, making sure that the black wire of each cable matches the ground pin of the connector.

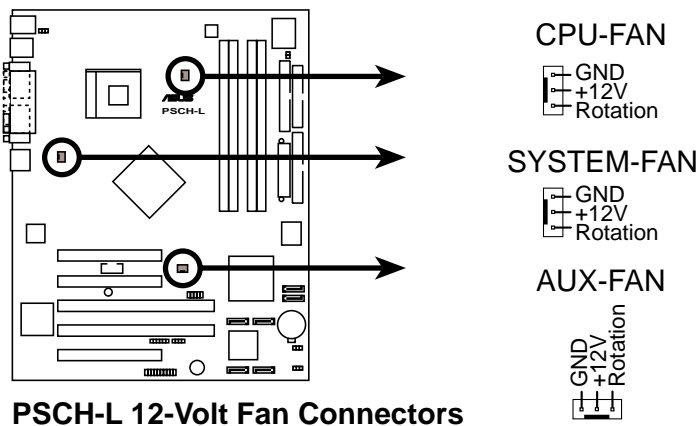

Do not forget to connect the fan cables to the fan connectors. Lack of sufficient air flow within the system may damage the motherboard components. These are not jumpers! DO NOT place jumper caps on the fan connectors!

9. Serial port 2 connector (10-1 pin COM2)

This connector accommodates a second serial port using an optional serial port bracket. Connect the bracket cable to this connector then install the bracket into a slot opening at the back of the system chassis.



The serial port bracket (COM2) is purchased separately.

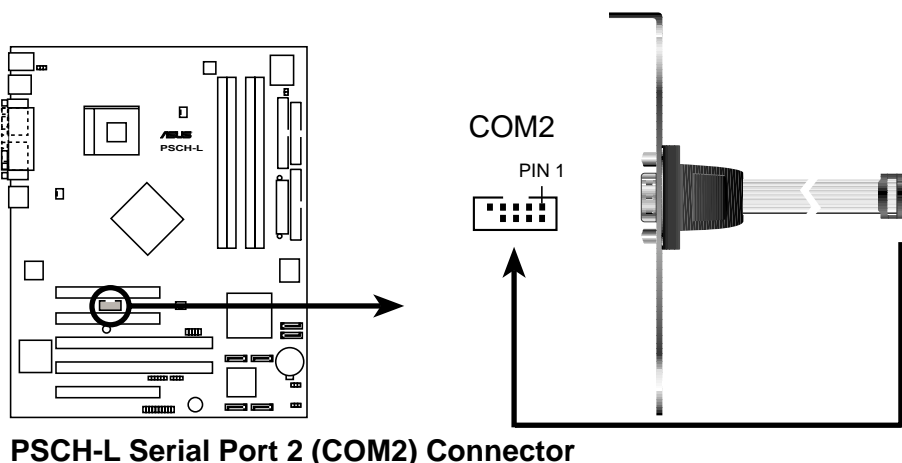

10. ATX power connectors (20-pin ATXPWR, 4-pin ATX12V)

These connectors connect to an ATX 12V power supply. The plugs from the power supply are designed to fit these connectors in only one orientation. Find the proper orientation and push down firmly until the connectors completely fit.

In addition to the 20-pin ATXPWR connector, this motherboard requires that you connect the 4-pin ATX +12V power plug to provide sufficient power to the CPU.



1. Do not forget to connect the 4-pin ATX +12V power plug. Otherwise, the system does not boot up.
2. Make sure that your ATX 12V power supply can provide 8A on the +12V lead and at least 1A on the +5-volt standby lead (+5VSB). The minimum recommended wattage is 300W. The system may become unstable or may not boot up if the power is inadequate.

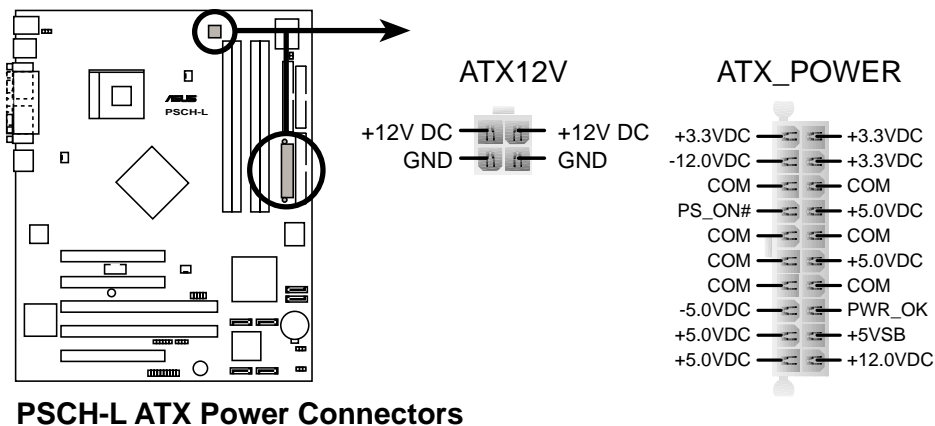

11. USB header (10-1 pin USB34)

If the USB ports on the rear panel are inadequate, a USB header is available for two additional USB ports. The USB header complies with USB 2.0 specification that supports up to 480 Mbps connection speed. This speed advantage over the conventional 12 Mbps on USB 1.1 allows faster Internet connection, interactive gaming, and simultaneous running of high-speed peripherals.

Connect an to this header. The module has two USB 2.0 ports that support the next generation USB peripherals such as high resolution cameras, scanners, printers, and mobile storage devices.

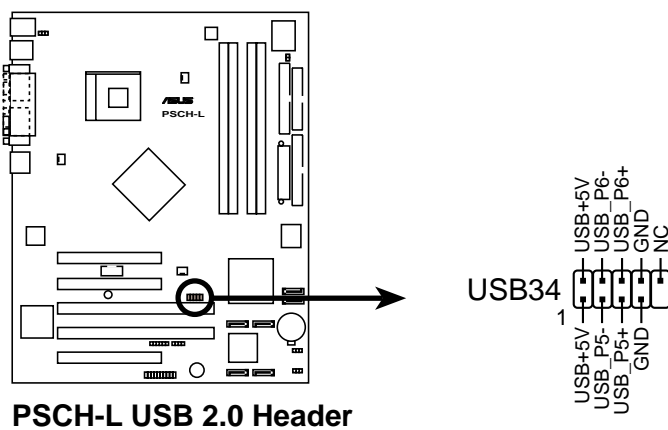

PSCH-L USB 2.0 Header

12. System panel connector (20-pin PANEL)

This connector accommodates several system front panel functions.

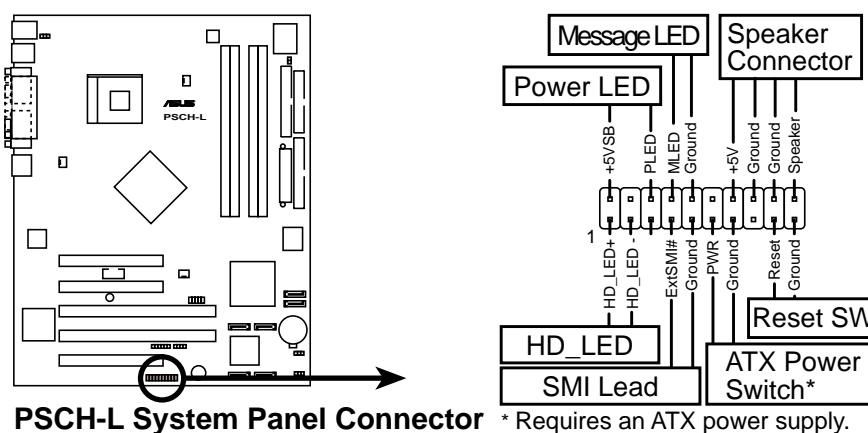

PSCH-L System Panel Connector

* Requires an ATX power supply.

- **System Power LED Lead (3-1 pin PLED)**

This lead connects to the system power LED. The LED lights up when you turn on the system power, and blinks when the system is in sleep mode.
- **Message LED Lead (2-pin MLED)**

This lead connects to the message LED cable on the front panel. The LED indicates receipt of messages from a fax/modem. The normal status of this LED is OFF when there is no incoming data signal. The LED blinks when data is received. The system message LED feature requires an ACPI operating system and driver.
- **System Warning Speaker Lead (4-pin SPEAKER)**

This lead connects to the case-mounted speaker and allows you to hear system beeps and warnings.
- **Hard Disk Activity Lead (2-pin HD_LED)**

This lead connects the HDD LED cable. The read or write activities of the device connected to the any of IDE connectors cause the IDE LED to light up.
- **System Management Interrupt Lead (2-pin SMI)**

This lead connects the case-mounted suspend switch, and allows you to manually place the system into a suspend mode, or “green” mode, where system activity is instantly decreased to save power and to expand the life of certain system components.
- **ATX Power Switch / Soft-Off Switch Lead (2-pin PWRSW)**

This lead connects a switch that controls the system power. Pressing the power switch turns the system between ON and SLEEP, or ON and SOFT OFF, depending on the BIOS or OS settings. Pressing the power switch while in the ON mode for more than 4 seconds turns the system OFF.
- **Reset Switch Lead (2-pin RESET)**

This lead connects to the case-mounted reset switch for rebooting the system without turning off the system power.

Chapter 3

This chapter describes the power up sequence and gives information on the BIOS beep codes.

Powering up

Chapter summary

- 3.1 Starting up for the first time 3-1**
- 3.2 Powering off the computer 3-2**

3.1 Starting up for the first time

1. After making all the connections, replace the system case cover.
2. Be sure that all switches are off.
3. Connect the power cord to the power connector at the back of the system chassis.
4. Connect the power cord to a power outlet that is equipped with a surge protector.
5. Turn on the devices in the following order:
 - a. Monitor
 - b. External SCSI devices (starting with the last device on the chain)
 - c. System power
6. After applying power, the power LED on the system front panel case lights up. For ATX power supplies, the system LED lights up when you press the ATX power switch. If your monitor complies with “green” standards or if it has a “power standby” feature, the monitor LED may light up or switch between orange and green after the system LED turns on. The system then runs the power-on tests. While the tests are running, the BIOS beeps (see BIOS beep codes table below) or additional messages appear on the screen. If you do not see anything within 30 seconds from the time you turned on the power, the system may have failed a power-on test. Check the jumper settings and connections or call your retailer for assistance.

AMI BIOS beep codes

No. of Beeps	Description
2	Parity error
3	Main memory read/write test error
4	Motherboard timer not operational
6	Keyboard controller BAT test error
7	General exception error
8	Display memory error
10	CMOS shutdown register read/write error

7. At power on, hold down <Delete> to enter BIOS Setup. Follow the instructions in Chapter 4.

3.2 Powering off the computer

3.2.1 Using the OS shut down function

If you are using Windows® 2000 Professional or Windows® 2000 Server:

1. Click the **Start** button then click **Shut Down...**
2. Make sure that the **Shut down** option button is selected, then click the **OK** button to shut down the computer.
3. The power supply should turn off after Windows® shuts down.

If you are using Windows® XP or Windows® Server 2003:

1. Click the **Start** button then select **Turn Off Computer**.
2. Click the **Turn Off** button to shut down the computer.
3. The power supply should turn off after Windows® shuts down.

3.2.2 Using the dual function power switch

While the system is ON, pressing the power switch for less than 4 seconds puts the system to sleep mode or to soft-off mode, depending on the BIOS setting. Pressing the power switch for more than 4 seconds lets the system enter the soft-off mode regardless of the BIOS setting. See section “4.5 Power Menu” in Chapter 4.

Chapter 4

This chapter tells how to change system settings through the BIOS Setup menus. Detailed descriptions of the BIOS parameters are also provided.

BIOS setup

Chapter summary

4.1	Managing and updating your BIOS	4-1
4.2	BIOS Setup program	4-8
4.3	Main menu	4-11
4.4	Advanced menu	4-18
4.5	Security menu	4-30
4.6	Power menu	4-33
4.7	Exit menu	4-34

4.1 Managing and updating your BIOS

The following utilities allow you to manage and update the motherboard Basic Input/Output System (BIOS) setup.

1. ASUS AFUDOS - updates the BIOS using a bootable floppy disk in DOS mode.
2. ASUS CrashFree BIOS 2 - updates the BIOS using a floppy disk or the motherboard support CD.
3. ASUS Update - updates the BIOS in a Windows® environment.

Refer to the following sections for details on these utilities.

Important notes



Save a copy of the original motherboard BIOS file to a bootable floppy disk in case you need to restore the BIOS in the future. Copy the original motherboard BIOS using the ASUS Update or AFUDOS utilities.

Visit the ASUS website and download the latest BIOS file for this motherboard using the ASUS Update utility.

4.1.1 Creating a bootable floppy disk

1. Do either one of the following to create a bootable floppy disk.

DOS environment

Insert a 1.44 MB floppy disk into the drive. At the DOS prompt, type:

```
format A: /S then press <Enter>.
```

Windows® 98SE/ME/2000/XP environment

- a. Insert a 1.44 MB floppy disk into the floppy disk drive.
- b. From your Windows desktop, click on **Start**, then select **My Computer**.
- c. Select the **3 1/2 Floppy Drive** icon.
- d. Click **File** from the menu, then select **Format**. A **Format 3 1/2 Floppy Disk** window appears.
- e. If you are using Windows® XP, select **Create an MS-DOS startup disk** from the format options field, then click **Start**.

OR

If you are using Windows® 98SE/ME/2000, select **Full** option button from the format type, then click **Start**.

2. Copy the original (or the latest) motherboard BIOS to the bootable floppy disk.

4.1.2 Using AFUDOS to update the BIOS

Update the BIOS using the AFUDOS.EXE utility in DOS environment.

1. Visit the ASUS website (www.asus.com) to download the latest BIOS file for your motherboard. Save the BIOS file to a bootable floppy disk.



Write the BIOS file name on a piece of paper. You need to type the exact BIOS file name at the prompt.

2. Copy the AFUDOS.EXE utility from the support CD to the bootable floppy disk that contains the BIOS file.
3. Boot the system from the floppy disk.
4. At the DOS prompt, type the command line:

```
afudos /i[filename]
```

where **[filename]** means the latest (or original) BIOS file that you copied to the bootable floppy disk.

5. Press **<Enter>**. The succeeding screen displays the status of the update process.



The BIOS information on the screen is for reference only. What you see on your screen may not be exactly the same as shown.

```
A:\>afudos /iPSCHL.rom
AMI Firmware Update Utility - Version 1.10
Copyright (C) 2002 American Megatrends, Inc. All rights reserved.

Reading file ..... done
Erasing flash .... done
Writing flash .... 0x0008CC00 (9%)
```



DO NOT shutdown or reset the system while updating the BIOS! Doing so may cause system boot failure!

When the BIOS update process is complete, the utility returns to the DOS prompt.

```
A:\>afudos /iPSCHL.rom
AMI Firmware Update Utility - Version 1.10
Copyright (C) 2002 American Megatrends, Inc. All rights reserved.

Reading file ..... done
Erasing flash .... done
Writing flash .... 0x0008CC00 (9%)
Verifying flash .. done

A:\>
```

5. Reboot the system from the hard disk.

4.1.3 Using AFUDOS to copy BIOS from PC

The AFUDOS.EXE utility can also be used to copy the current system BIOS settings to a floppy or hard disk. The copy can be used as a backup in case the system BIOS fails or gets corrupted.

1. At the DOS prompt, type the command line:

```
afudos /o[filename]
```

where **[filename]** can be any user provided filename of not more than eight (8) alpha-numeric characters for the main filename and three (3) alpha-numeric characters for the extension name.

2. Press <Enter>.



The BIOS information on the screen is for reference only. What you see on your screen may not be exactly the same as shown.

Main filename
Extension name

```
A:\>afudos /oMYBIOS03.rom
AMI Firmware Update Utility - Version 1.10
Copyright (C) 2002 American Megatrends, Inc. All rights reserved.

Reading flash ..... 0x0008CC00 (9%)
```

3. The utility will copy the current system BIOS by default to the floppy disk. Make sure that the floppy disk is not write-protected and have enough space (at least 600KB) to store the file.

```
A:\>afudos /oMYBIOS03.rom
AMI Firmware Update Utility - Version 1.10
Copyright (C) 2002 American Megatrends, Inc. All rights reserved.

Reading flash ..... done

A:\>
```

When the BIOS copy process is complete, the utility returns to the DOS prompt.

4.1.4 Recovering the BIOS with CrashFree BIOS 2

The CrashFree BIOS 2 auto recovery tool allows you to restore BIOS from the motherboard support CD, or from a floppy disk that contains the BIOS file, in case the current BIOS on the motherboard fails or gets corrupted.



1. Prepare the support CD that came with the motherboard or a floppy disk that contains the motherboard BIOS before proceeding with the BIOS update process.
2. If you have saved a copy of the original motherboard BIOS to a bootable floppy disk, you may also use this disk to restore the BIOS. See section “4.1.1 Creating a bootable floppy disk.”

To recover the BIOS from a floppy disk:

1. Boot the system.
2. When a corrupted BIOS is detected, the following screen message appears.

```
Bad BIOS checksum. Starting BIOS recovery...
Checking for floppy...
```

3. Insert a floppy disk that contains the original or the latest BIOS file for this motherboard. If all the necessary files are found in the floppy disk, the BIOS update process continues.



Make sure that the BIOS file in the floppy disk is renamed as **"PSCHL.ROM"**.

```
Bad BIOS checksum. Starting BIOS recovery...
Checking for floppy...
Floppy found!
Reading file "PSCHL.ROM". Completed.
Start flashing...
```



DO NOT shutdown or reset the system while updating the BIOS! Doing so may cause system boot failure!

4. When the BIOS update process is complete, reboot the system.

To recover the BIOS from the support CD:

1. Boot the system.
2. When a corrupted BIOS is detected, the following screen message appears.

```
Bad BIOS checksum. Starting BIOS recovery...
Checking for floppy...
```



If there is no floppy disk found in the drive, the system automatically checks the CD-ROM.

3. Place the support CD in the CD-ROM. The support CD contains the original BIOS for this motherboard.

```
Bad BIOS checksum. Starting BIOS recovery...
Checking for floppy...
Floppy not found!
Checking for CD-ROM...
CD-ROM found.
Reading file "PSCHL.ROM". Completed.
Start flashing...
```



DO NOT shutdown or reset the system while updating the BIOS! Doing so may cause system boot failure!

4. When the BIOS update process is complete, reboot the system.



The recovered BIOS may not be the latest BIOS version for this motherboard. Visit ASUS website (www.asus.com) to download the latest BIOS file.

4.1.5 ASUS Update

The ASUS Update is a utility that allows you to update the motherboard BIOS in Windows® environment. This utility is available in the support CD that comes with the motherboard package. ASUS Update requires an Internet connection either through a network or an Internet Service Provider (ISP).

To install ASUS Update:

1. Insert the support CD into the CD-ROM drive. The **Drivers** menu appears.
2. Click the **Utilities** tab, then click **Install ASUS Update VX.XX.XX**. See page 5-3 for the **Utilities** menu screen.
3. The ASUS Update utility is copied into your system.

To update the BIOS using the ASUS Update:

1. Launch the utility from the Windows desktop by clicking **Start > Programs > ASUS > ASUSUpdate > ASUSUpdate**. The ASUS Update initial screen appears.
2. Select your desired update method, then click **Next**.

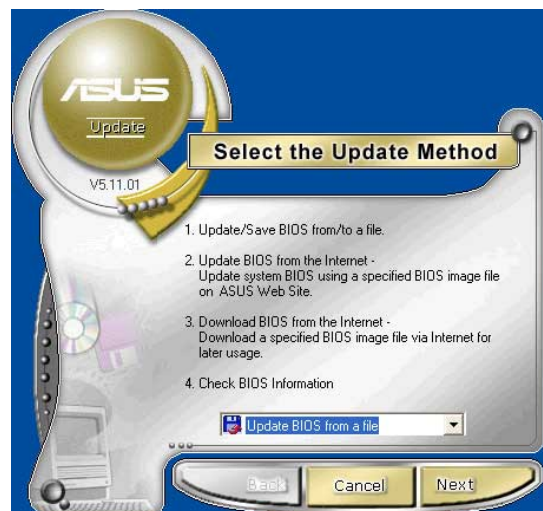

3. If you selected updating/ downloading from the Internet, select the ASUS FTP site nearest you to avoid network traffic, or choose **Auto Select**. Click **Next**.

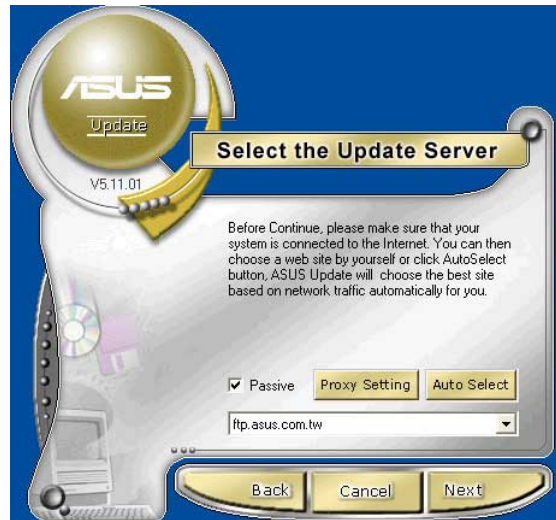

4. From the FTP site, select the BIOS version that you wish to download. Click **Next**.
5. Follow the instructions on the succeeding screens to complete the update process.

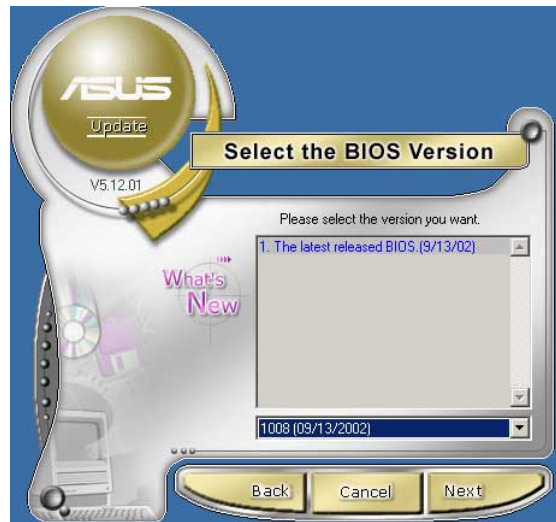

If you selected the option to update the BIOS from a file, a window prompts you to locate the file. Select the file, click **Save**, then follow the screen instructions to complete the update process.

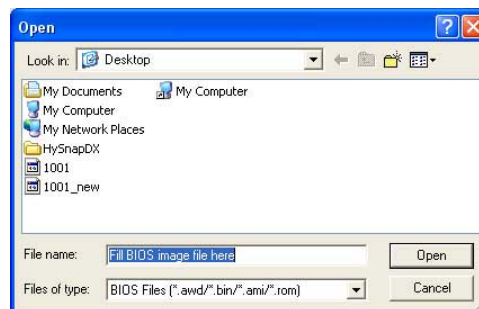

4.2 BIOS Setup program

This motherboard supports a programmable firmware chip that you can update using the provided utility described in section “4.1 Managing and updating your BIOS.”

Use the BIOS Setup program when you are installing a motherboard, reconfiguring your system, or prompted to “Run Setup”. This section explains how to configure your system using this utility.

Even if you are not prompted to use the Setup program, you may want to change the configuration of your computer in the future. For example, you may want to enable the security password feature or change the power management settings. This requires you to reconfigure your system using the BIOS Setup program so that the computer can recognize these changes and record them in the CMOS RAM of the firmware hub.

The firmware hub on the motherboard stores the Setup utility. When you start up the computer, the system provides you with the opportunity to run this program. Press **** during the Power-On Self Test (POST) to enter the Setup utility. Otherwise, POST continues with its test routines.

If you wish to enter Setup after POST, restart the system by pressing **<Ctrl+Alt+Delete>**, or by pressing the reset button on the system chassis. You can also restart by turning the system off and then back on. Do this last option only if the first two failed.

The Setup program is designed to make it as easy to use as possible. It is a menu-driven program, which means you can scroll through the various sub-menus and make your selections from the available options using the navigation keys.



The default BIOS settings for this motherboard apply for most conditions to ensure optimum performance. If the system becomes unstable after changing any BIOS settings, load the default settings to ensure system compatibility and stability. Select the **Load Default Settings** item under the Exit Menu. See section “4.7 Exit Menu.”



1. The BIOS setup screens shown in this chapter are for reference purposes only, and may not exactly match what you see on your screen.
 2. Visit the ASUS website (www.asus.com) to download the latest product and BIOS information.
-

4.2.1 BIOS menu screen

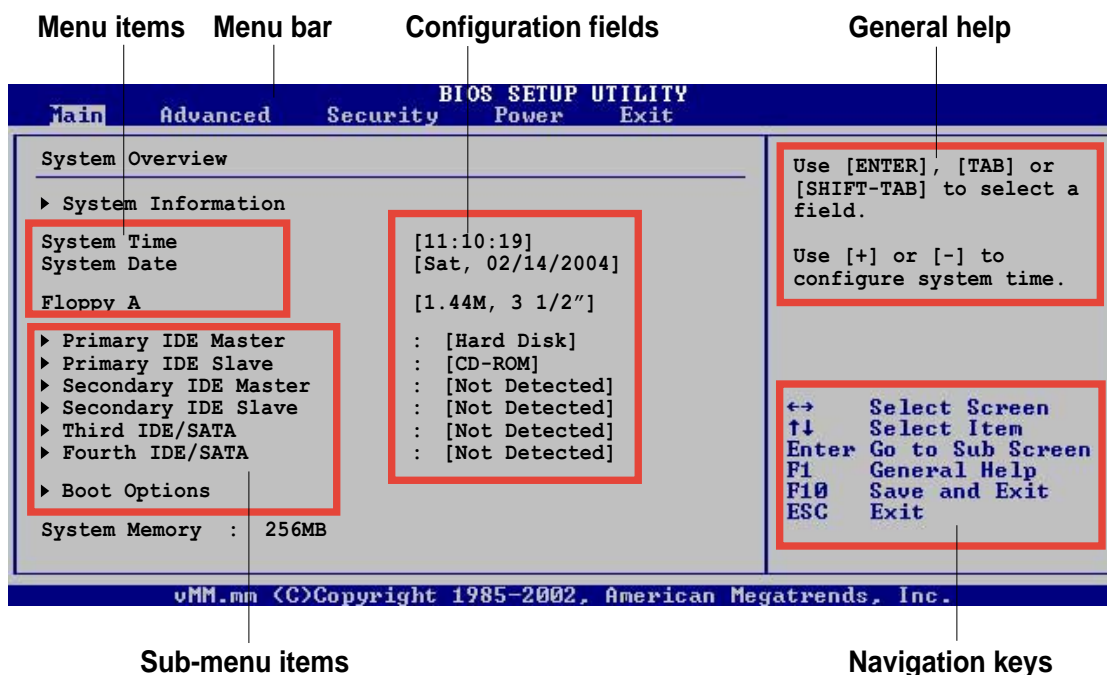

4.2.2 Menu bar

The menu bar on top of the screen has the following main items:

- Main** For changing the basic system configuration
- Advanced** For changing the advanced system settings
- Power** For changing the advanced power management (APM) configuration
- Boot** For changing the system boot configuration
- Exit** For selecting the exit options and loading default settings

To select an item on the menu bar, press the right or left arrow key on the keyboard until the desired item is highlighted.

4.2.3 Navigation keys

At the **bottom right corner** of a menu screen are the navigation keys for that particular menu. Use the navigation keys to select items in the menu and change the settings.



Some of the navigation keys differ from one screen to another.

4.2.4 Menu items

The highlighted item on the menu bar displays the specific items for that menu. For example, selecting **Main** shows the Main menu items.

The other items (Advanced, Power, Boot, and Exit) on the menu bar have their respective menu items.

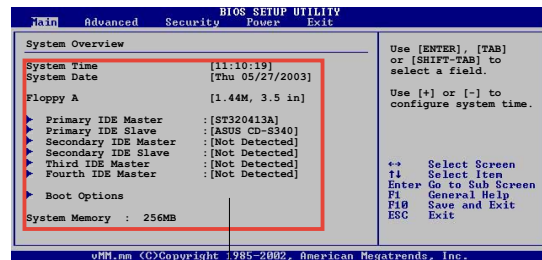

Main menu items

4.2.5 Sub-menu items

An item with a sub-menu on any menu screen is distinguished by a solid triangle before the item. To display the sub-menu, select the item and press Enter.

4.2.6 Configuration fields

These fields show the values for the menu items. If an item is user-configurable, you may change the value of the field opposite the item. You can not select an item that is not user-configurable.

A configurable field is enclosed in brackets, and is highlighted when selected. To change the value of a field, select it then press Enter to display a list of options. Refer to “4.2.7 Pop-up window.”

4.2.7 Pop-up window

Select a menu item then press Enter to display a pop-up window with the configuration options for that item.

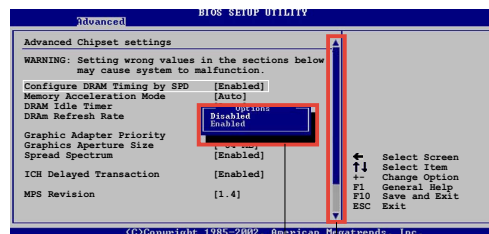

Pop-up window

Scroll bar

4.2.8 Scroll bar

A scroll bar appears on the right side of a menu screen when there are items that do not fit on the screen. Press **Up/Down arrow keys** or **PageUp/ PageDown keys** to display the other items on the screen.

4.2.9 General help

At the top right corner of the menu screen is a brief description of the selected item.

4.3 Main menu

When you enter the BIOS Setup program, the Main menu screen appears, giving you an overview of the basic system information.



Refer to section “4.2.1 BIOS menu screen” for information on the menu screen items and how to navigate through them.

```

BIOS SETUP UTILITY
Main  Advanced  Security  Power  Exit

System Overview
-----
▶ System Information
System Time           [11:10:19]
System Date           [Sat, 02/14/2004]
Floppy A               [1.44M, 3 1/2"]

▶ Primary IDE Master   : [Hard Disk]
▶ Primary IDE Slave    : [CD-ROM]
▶ Secondary IDE Master : [Not Detected]
▶ Secondary IDE Slave  : [Not Detected]
▶ Third IDE/SATA       : [Not Detected]
▶ Fourth IDE/SATA      : [Not Detected]

▶ Boot Options
System Memory        : 256MB

Use [ENTER], [TAB] or [SHIFT-TAB] to select a field.
Use [+] or [-] to configure system time.

↔ Select Screen
↑↓ Select Item
Enter Go to Sub Screen
F1 General Help
F10 Save and Exit
ESC Exit

vMM.mm (C)Copyright 1985-2002, American Megatrends, Inc.

```

4.3.1 System Information

This menu gives you an overview of the general system specifications. The items in this menu are auto-detected by BIOS.

```

BIOS SETUP UTILITY
Main

System Overview
-----
AMIBIOS ID           : PSCHL
Version              : 08.09.005
Build Date           : 02/16/04

CPU Type             : Intel(R) Pentium(R) 4 Family CPU 2
CPU Speed            : 2400MHz
CPU FSB Speed        : 533MHz
CPU Cache L1         : 8 KB
CPU Cache L2         : 512 KB
CPU Cache L3         : 512 KB
CPU ID Number        : 0F24

LAN Address          : 00.E0.18.62.57.08

↔ Select Screen
↑↓ Select Item
Enter Go to Sub Screen
F1 General Help
F10 Save and Exit
ESC Exit

vMM.mm (C)Copyright 1985-2002, American Megatrends, Inc.

```

4.3.2 System Time [xx:xx:xxxx]

Allows you to set the system time

4.3.3 System Date [Day xx/xx/xxxx]

Allows you to set the system date

4.3.4 Floppy A [1.44M, 3 1/2"]

Sets the type of floppy drive installed. Configuration options: [Disabled] [360K, 5.25 in.] [1.2M , 5.25 in.] [720K , 3.5 in.] [1.44M, 3.5 in.] [2.88M, 3.5 in.]

4.3.5 Primary and Secondary IDE Master/Slave, Third IDE/SATA, Fourth IDE/SATA

While entering Setup, BIOS auto-detects the presence of IDE devices. There is a separate sub-menu for each IDE device. Select a device item then press Enter to display the IDE device information.

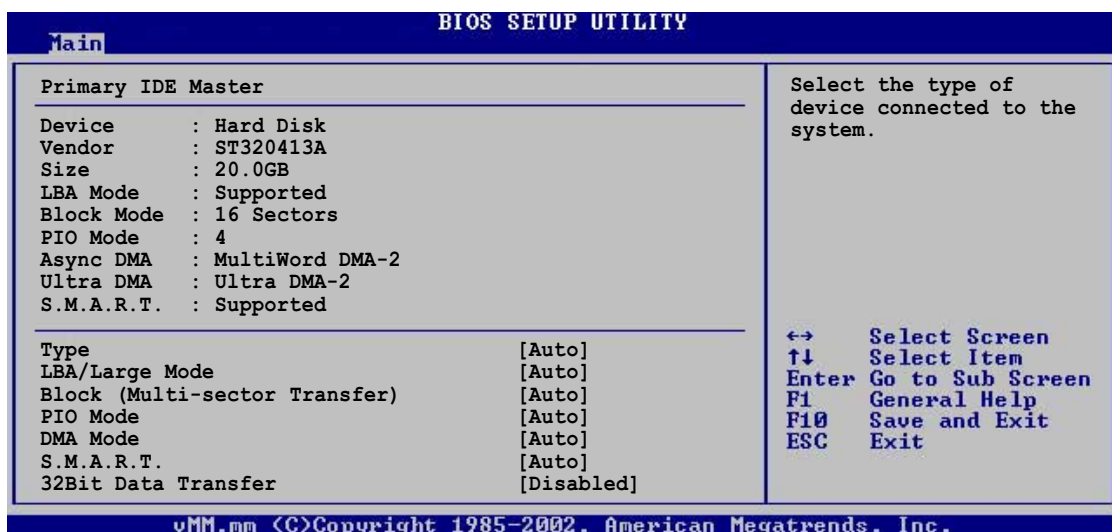

The values opposite the dimmed items (Device, Vendor, Size, LBA Mode, Block Mode, PIO Mode, Async DMA, Ultra DMA, and SMART monitoring) are auto-detected by BIOS and are not user-configurable. These items show N/A if no IDE device is installed in the system.

Type [Auto]

Selects the type of IDE drive. Setting to Auto allows automatic selection of the appropriate IDE device type. Select CDROM if you are specifically configuring a CD-ROM drive. Select ARMD (ATAPI Removable Media Device) if your device is either a ZIP, LS-120, or MO drive. Configuration options: [Not Installed] [Auto] [CDROM] [ARMD]

LBA/Large Mode [Auto]

Enables or disables the LBA mode. Setting to Auto enables the LBA mode if the device supports this mode, and if the device was not previously formatted with LBA mode disabled. Configuration options: [Disabled] [Auto]

Block (Multi-sector Transfer) [Auto]

Enables or disables data multi-sectors transfers. When set to Auto, the data transfer from and to the device occurs multiple sectors at a time if the device supports multi-sector transfer feature. When set to Disabled, the data transfer from and to the device occurs one sector at a time. Configuration options: [Disabled] [Auto]

PIO Mode [Auto]

Selects the PIO mode. Configuration options: [Auto] [0] [1] [2] [3] [4]

DMA Mode [Auto]

Selects the DMA mode. Configuration options: [Auto] [SWDMA0] [SWDMA1] [SWDMA2] [MWDMA0] [MWDMA1] [MWDMA2] [UDMA0] [UDMA1] [UDMA2]

S.M.A.R.T. [Auto]

Sets the Smart Monitoring, Analysis, and Reporting Technology. Configuration options: [Auto] [Disabled] [Enabled]

32Bit Data Transfer [Disabled]

Enables or disables 32-bit data transfer. Configuration options: [Disabled] [Enabled]

4.3.6 Boot Options

This menu allows you to change the system boot settings. Select an item then press Enter to display the sub-menu.

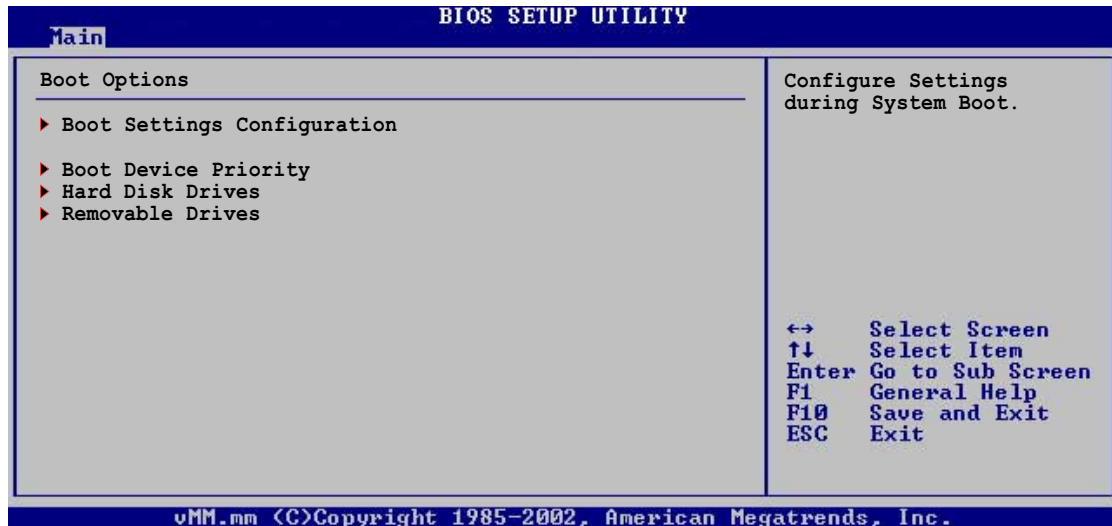

Boot Settings Configuration

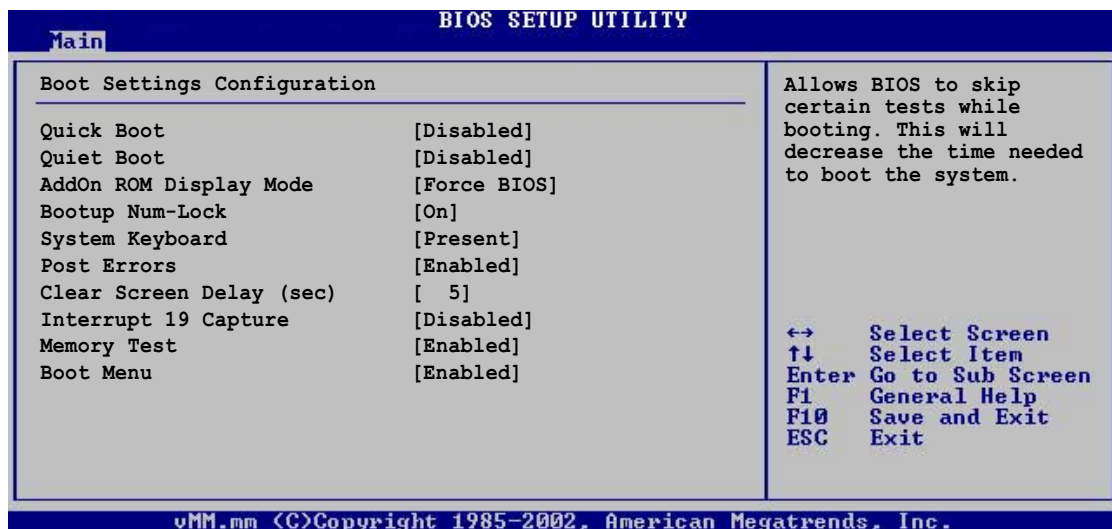

Quick Boot [Disabled]

Enabling this item allows the BIOS to skip some power on self tests (POST) while booting to decrease the time needed to boot the system. When set to [Disabled], BIOS performs all the POST items. Configuration options: [Disabled] [Enabled]

Quiet Boot [Disabled]

Setting to [Disabled] displays the normal POST messages. Setting to [Enabled] displays the OEM logo instead of the POST messages. Configuration options: [Disabled] [Enabled]

Add On ROM Display Mode [Force BIOS]

Sets the display mode for option ROM. Configuration options: [Force BIOS] [Keep Current]

Bootup Num-Lock [On]

Allows you to select the power-on state for the NumLock. Configuration options: [Off] [On]

System Keyboard [Present]

Allows you to enable or disable the keyboard/s connected to the system [Absent] [Present]

Post Errors [Enabled]

When set to Enabled, the system pauses and displays the Setup entry if an boot error occurs. When set to Disabled, the system continues to boot or attempts to boot even if a boot error occurs.

Configuration options: [Disabled] [Enabled]

Clear Screen Delay (sec) [5]

Allows you to set the delay time in seconds before clearing the screen to boot. The value zero (0) means no delay.

Interrupt 19 Capture [Disabled]

When set to [Enabled], this function allows the option ROMs to trap Interrupt 19. Configuration options: [Disabled] [Enabled]

Memory Test [Enabled]

Enables or disables the memory test during POST. Configuration options: [Disabled] [Enabled]

Boot Menu [Enabled]

Allows you to bypass the normal sequence of boot devices. Press F8 before loading the operating system to select an alternate boot device.

Configuration options: [Disabled] [Enabled]

Boot Device Priority

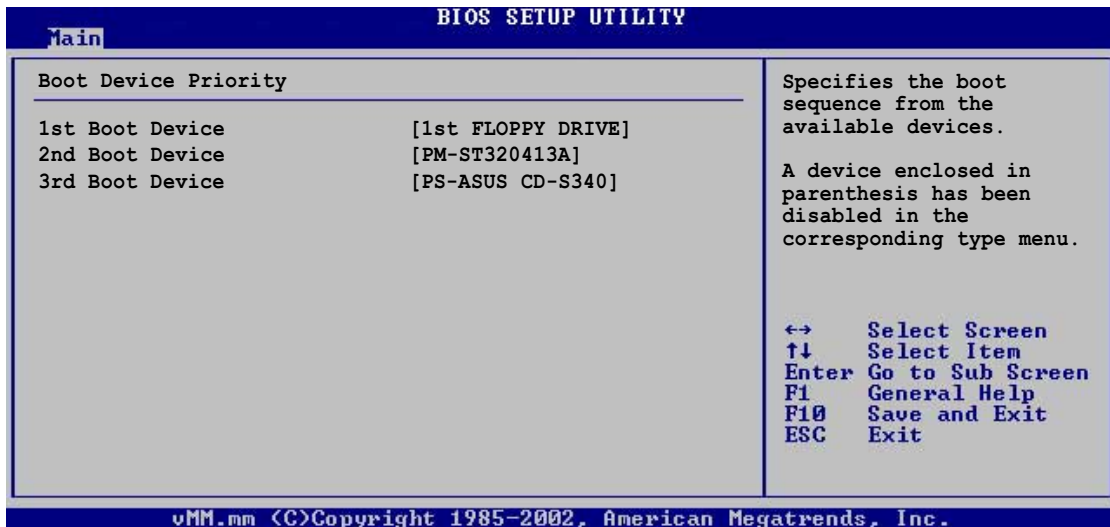

1st ~ xxth Boot Device [1st Floppy Drive]

These items specify the boot device priority sequence from the available devices. The number of device items that appear on the screen depends on the the number of devices installed in the system. Configuration options: [xxxxx Drive] [Disabled]

Hard Disk Drives

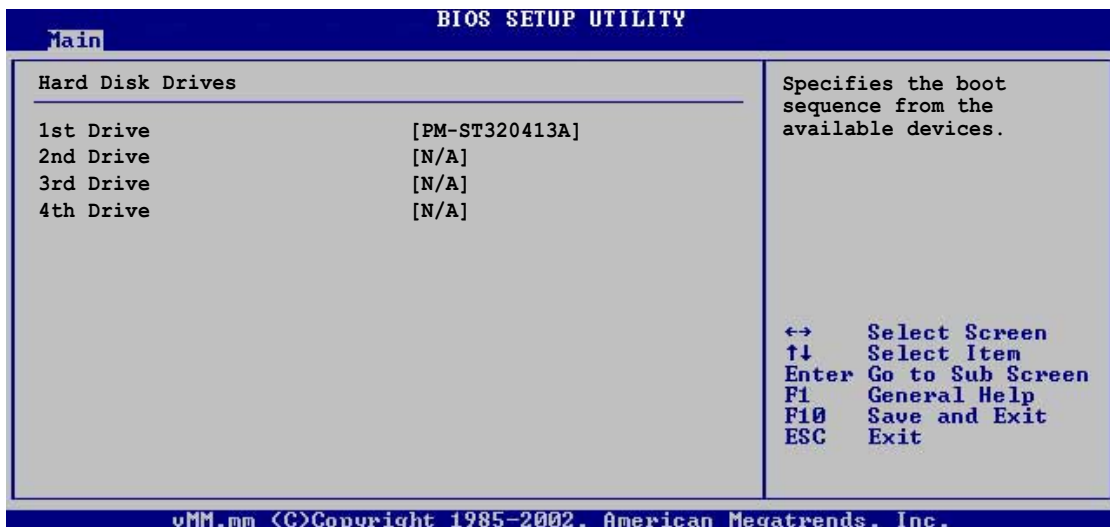

1st ~ 4th Drive

These items specify the boot priority sequence from the available hard disk drives. The number of device items that appear on the screen depends on the the number of devices installed in the system. Configuration options: [xxxxx Drive] [Disabled]

Removable Drives

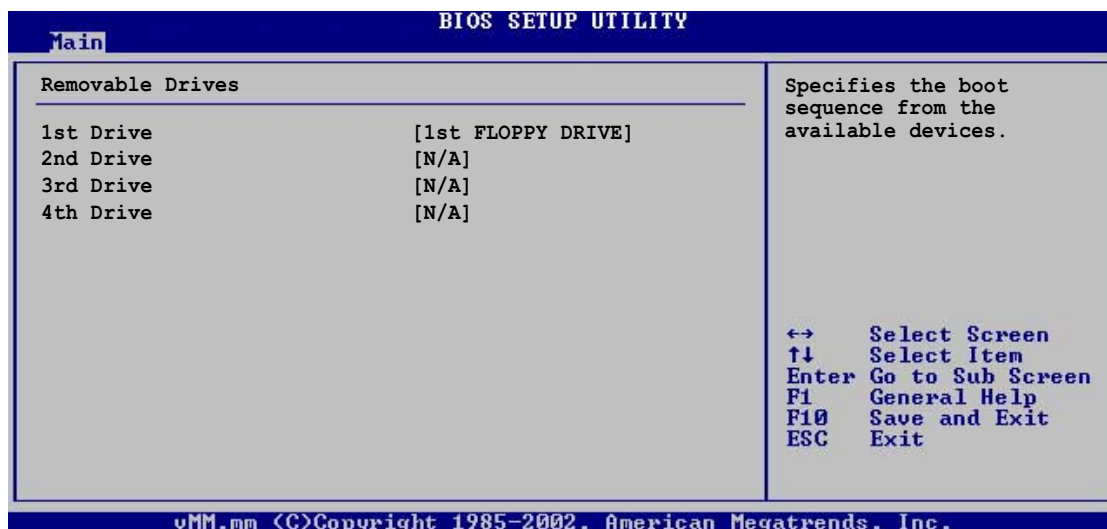

1st ~ 4th Drive

These items specify the boot priority sequence from the available removable drives. The number of device items that appear on the screen depends on the the number of devices installed in the system.

Configuration options: [xxxxx Drive] [Disabled]

4.3.7 System Memory

Displays the auto-detected system memory.

4.4 Advanced menu

The Advanced menu items allow you to change the settings for the CPU and other system devices.



Take caution when changing the settings of the Advanced menu items. Incorrect field values may cause the system to malfunction.

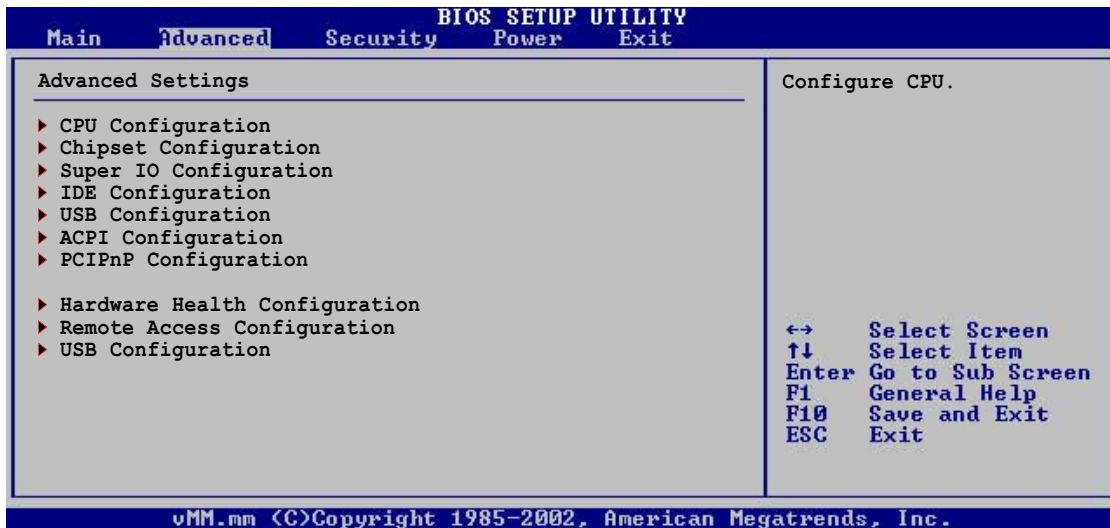

4.4.1 CPU Configuration

The items in this menu allow you to change CPU-related settings. Select the item then press Enter to display the sub-menu.

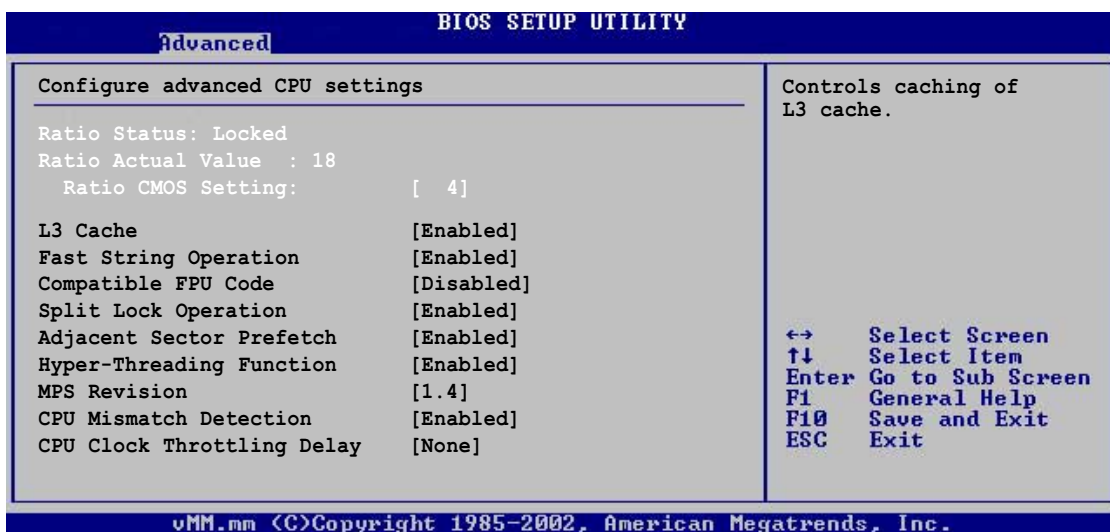

L3 Cache [Enabled]

Allows you to enable or disable the caching of L3 cache. Configuration options: [Disabled] [Enabled]

Fast String Operation [Enabled]

Allows you to enable or disable the CPU Fast String feature. Configuration options: [Disabled] [Enabled]

Compatible FPU Code [Disabled]

Allows you to enable or disable the P6-Compatible FPU-OPCODE register usage model. Configuration options: [Disabled] [Enabled]

Split Lock Operation [Enabled]

Allows you to enable or disable the split lock feature. Configuration options: [Disabled] [Enabled]

Adjacent Sector Prefetch [Enabled]

Allows you to enable or disable the adjacent sector prefetch feature. Configuration options: [Disabled] [Enabled]

Hyper-Threading Function [Disabled]

Allows you to enable or disable the CPU Hyper-Threading Technology feature. Configuration options: [Disabled] [Enabled]

MPS Revision [1.4]

Configuration options: [1.1] [1.4]

CPU Mismatch Detection [Enabled]

When set to Enabled, allows detection of CPU frequency change and front side bus (FSB) frequency mismatch. Configuration options: [Disabled] [Enabled]

CPU Clock Throttling Delay [None]

Allows you to set the CPU clock throttling delay. Configuration options: [None] [1 Min] [5 Min] [10 Min] [20 Min] [30 Min] [60 Min]

4.4.2 Chipset Configuration

The items in this menu allow you to change the advanced chipset settings. Select an item then press Enter to display the sub-menu.



DRAM Frequency [Auto]

Allows you to select a specific DRAM frequency. Select Auto for automatic adjustment of the DRAM operating frequency.

Configuration options: [266 MHz] [333 MHz] [400 MHz] [Auto]

Configure DRAM timing by SPD [Enabled]

When set to Enabled, the DRAM SPD (Serial Presence Detect) function automatically configures the DRAM clock timing. Configuration options: [Disabled] [Enabled]

DRAM Integrity Mode [ECC]

Allows you to set the DRAM integrity mode. Configuration options: [Disabled] [ECC]

4.4.3 Super IO Configuration

The items in this menu allow you to configure the Super I/O chipset. Select an item then press Enter to display the configuration options.

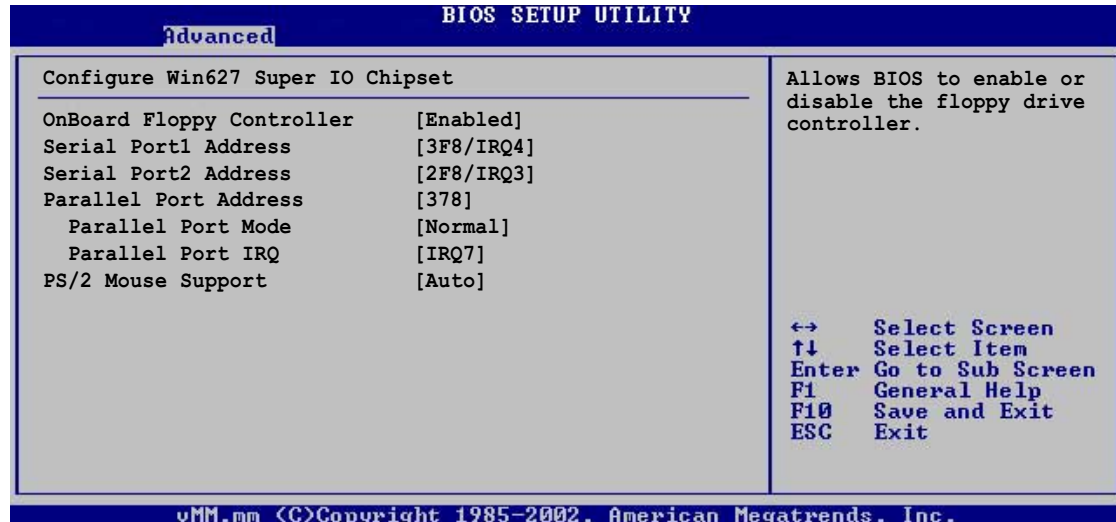

OnBoard Floppy Controller [Enabled]

Allows you to enable or disable the onboard floppy disk controller.

Configuration options: [Disabled] [Enabled]

Serial Port1 Address [3F8/IRQ4]

Allows you to select the Serial Port1 base address.

Configuration options: [Disabled] [3F8/IRQ4] [3E8/IRQ4] [2E8/IRQ3]

Serial Port2 Address [2F8/IRQ3]

Allows you to select the Serial Port2 base address.

Configuration options: [Disabled] [2F8/IRQ3] [3E8/IRQ4] [2E8/IRQ3]

Parallel Port Address [378]

Allows you to select the Parallel Port base addresses.

Configuration options: [Disabled] [378] [278] [3BC]

Parallel Port Mode [ECP]

Allows you to select the Parallel Port mode. Configuration options: [Normal] [Bi-directional] [EPP] [ECP]

ECP Mode DMA Channel [DMA3]

Configuration options: [DMA0] [DMA1] [DMA3]

EPP Version [1.9]

Allows selection of the Parallel Port EPP version. This item appears only when the **Parallel Port Mode** is set to **EPP**. Configuration options: [1.9] [1.7]

Parallel Port IRQ [IRQ7]

Configuration options: [IRQ5] [IRQ7]

PS/2 Mouse Support [Enabled]

Allows you to enable or disable support for PS/2 mouse. Configuration options: [Disabled] [Enabled] [Auto]

4.4.4 IDE Configuration

The items in this menu allow you to set or change the configurations for the IDE devices installed in the system. Select an item then press Enter if you wish to configure the item.

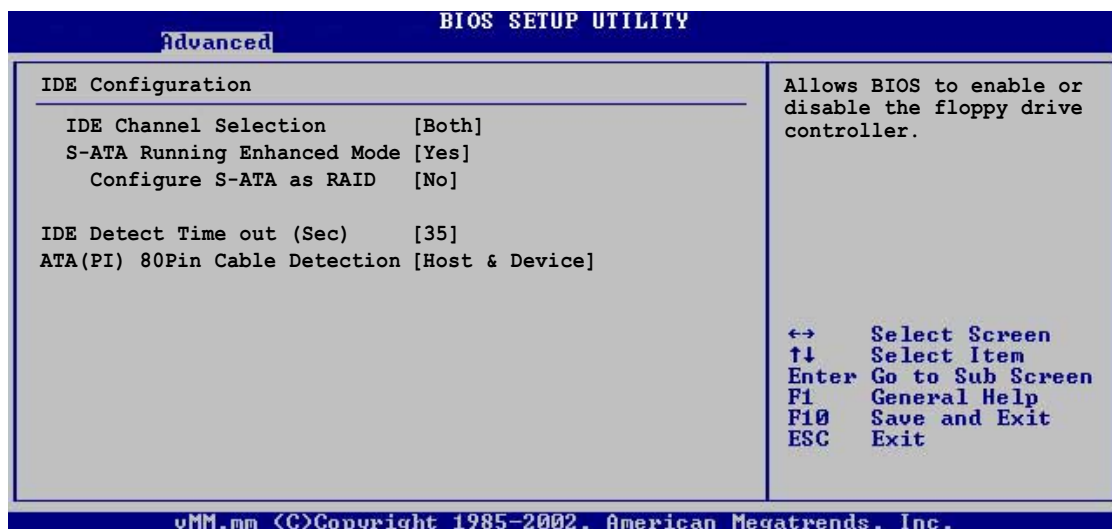

IDE Channel Selection [Both]

Allows you to select the IDE channel that you wish to enable. Configuration options: [Disabled] [Primary] [Secondary] [Both]

S-ATA Running Enhanced Mode [Yes]

When set to Yes, allows you to configure the Serial ATA channel as a tertiary IDE channel. Configuration options: [Yes] [No]

Configure S-ATA as RAID [No]

When set to Yes, allows you to configure the Serial ATA devices into a disk array. Configuration options: [No] [Yes]

IDE Detect Time Out (Sec) [35]

Selects the time out value for detecting ATA/ATAPI devices. Configuration options: [0] [5] [10] [15] [20] [25] [30] [35]

ATA(PI) 80Pin Cable Detection [Host & Device]

Selects the mechanism for detecting 80-pin ATA/ATAPI cable. Configuration options: [Host & Device] [Host] [Device]

4.4.5 USB Configuration

The items in this menu allows you to change the USB-related features. Select an item then press Enter to display the configuration options.

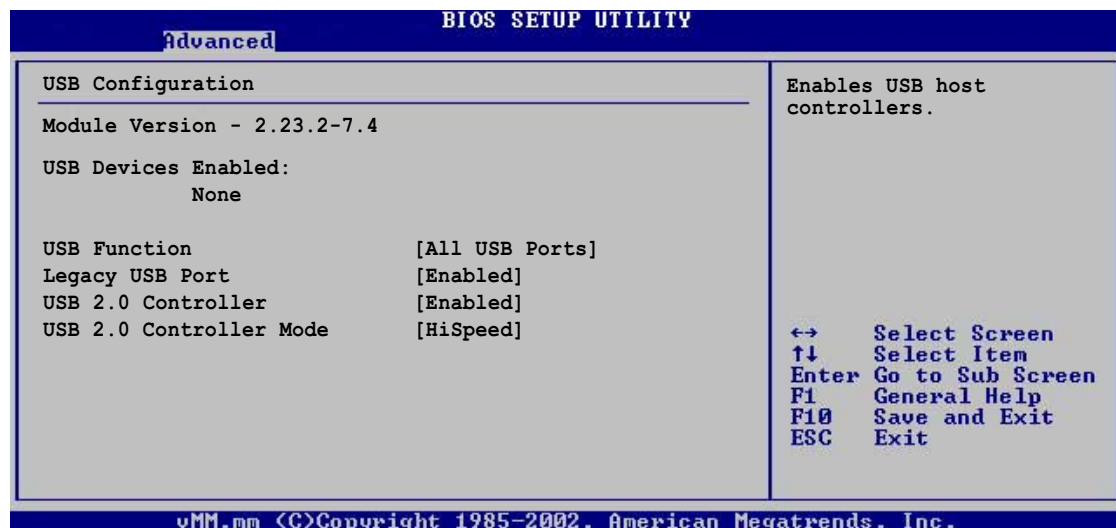

The Module Version and USB Devices Enabled items show the auto-detected values. If no USB device is detected, the item shows None.

USB Function [All USB Ports]

Allows you to set the number of USB ports to activate. Configuration options: [Disabled] [2 USB Ports] [All USB Ports]

Legacy USB Support [Enabled]

Allows you to enable or disable support for legacy USB devices. Setting to Auto disables the legacy support if no USB devices are connected. Configuration options: [Disabled] [Enabled] [Auto]

USB 2.0 Controller [Enabled]

Allows you to enable or disable the USB controller. Configuration options: [Enabled] [Disabled]

USB 2.0 Controller Mode [HiSpeed]

Allows you to configure the USB 2.0 controller in HiSpeed (480 Mbps) or Full Speed (12 Mbps). Configuration options: [HiSpeed] [Full Speed]

4.4.6 ACPI Configuration

The items in this menu allow you to change the ACPI (Advanced Configuration and Power Interface) settings. Select an item then press Enter to display the configuration options. For the second item, a sub-menu appears when you press Enter.

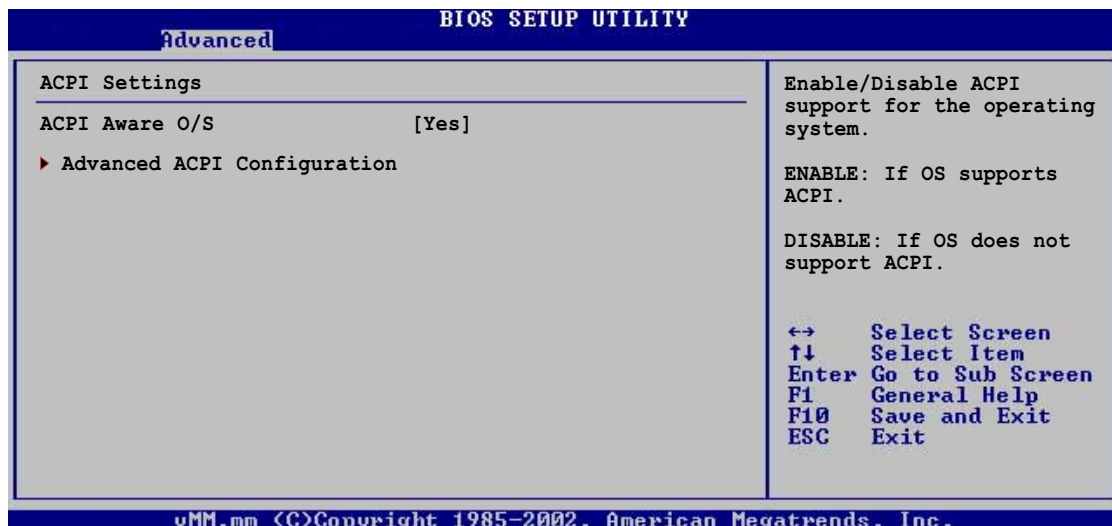

ACPI Aware O/S [Yes]

Allows you to enable or disable ACPI support for your operating system. Select No if your operating system does not support ACPI. Select Yes if your operating system supports ACPI. Configuration options: [No] [Yes]

Advanced ACPI Configuration

Allows you to change the advanced ACPI settings.

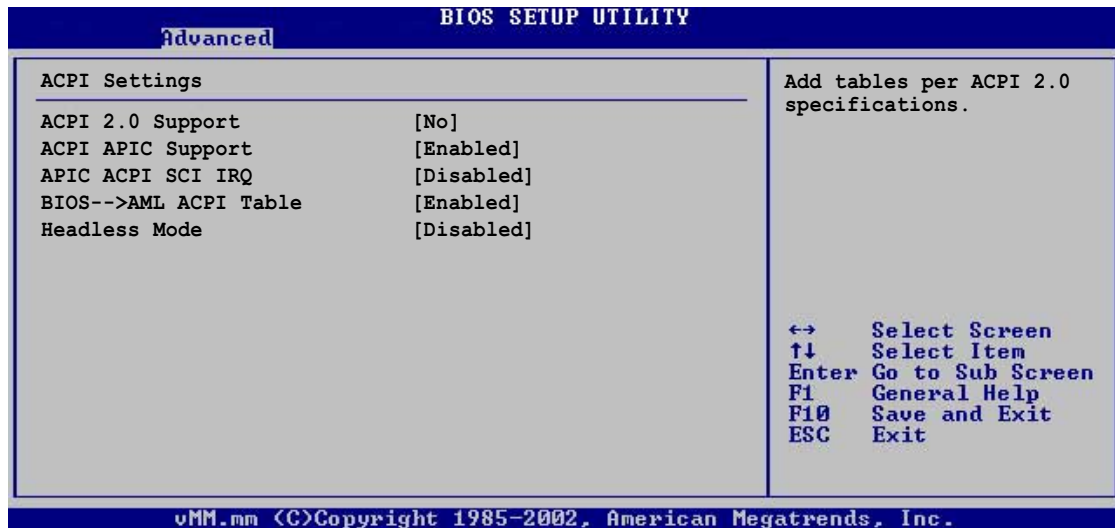

ACPI 2.0 Support [No]

When set to Yes, allows adding tables according to the ACPI 2.0 specifications. Configuration options: [No] [Yes]

ACPI APIC Support [Enabled]

Allows you to enable or disable the inclusion of ACPI APIC table pointer to RSDT pointer list. Configuration options: [Disabled] [Enabled]

APIC ACPI SCI IRQ [Disabled]

Allows you to enable or disable the APIC ACPI SCI interrupt. Configuration options: [Disabled] [Enabled]

BIOS -> AML ACPI Table [Enabled]

Allows you to enable or disable the inclusion of the BIOS -> AML exchange pointer to (X)RSDT pointer list. Configuration options: [Disabled] [Enabled]

Headless Mode [Disabled]

Allows you to enable or disable the Headless operation mode though ACPI. Configuration options: [Disabled] [Enabled]

4.4.7 PCI PnP Configuration

The items in this menu allow you to change the advanced settings for PCI/PnP devices.



Take caution when changing the settings of the PCI PnP menu items. Incorrect field values may cause the system to malfunction.

Advanced		BIOS SETUP UTILITY
Advanced PCI/PnP Settings		NO: Lets the BIOS configure all the devices in the system. YES: Lets the operating system configure Plug and Play (PnP) devices not required for boot if your system has a Plug and Play operating system. ←→ Select Screen ↑↓ Select Item Enter Go to Sub Screen F1 General Help F10 Save and Exit ESC Exit
Plug & Play O/S	[No]	
OffBoard PCI/ISA IDE Card	[Auto]	
C.S.A. Gigabit Ethernet		
Device	[Enabled]	
Option ROM Scan	[Enabled]	
Bus Master	[Enabled]	
Promise RAID		
Device	[Enabled]	
Option ROM Scan	[Enabled]	
Bus Master	[Enabled]	
Latency Timer	[Default]	

PCI Slot 1 Configuration		←→ Select Screen ↑↓ Select Item Enter Go to Sub Screen F1 General Help F10 Save and Exit ESC Exit
Option ROM Scan	[Enabled]	
Bus Master	[Enabled]	
Latency Timer	[Default]	
PCI Slot 2 Configuration		
Option ROM Scan	[Enabled]	
Bus Master	[Enabled]	
Latency Timer	[Default]	
PCI Slot 1 Configuration		
Option ROM Scan	[Enabled]	
Bus Master	[Enabled]	
Latency Timer	[Default]	
PCI Slot 2 Configuration		
Option ROM Scan	[Enabled]	
Bus Master	[Enabled]	
Latency Timer	[Default]	

vMM.mn (C)Copyright 1985-2002, American Megatrends, Inc.

Plug & Play O/S [No]

When set to [No], BIOS configures all the devices in the system. When set to [Yes] and if you installed a Plug & Play operating system, the operating system configures the Plug & Play devices not required for boot.

Configuration options: [No] [Yes]

OffBoard PCI/ISA IDE Card [Auto]

Allows you to select the appropriate PCI slot number as required by some PCI IDE cards. Configuration options: [Auto] [PCI Slot1] [PCI Slot2] [PCI Slot3] [PCI Slot4] [PCI Slot5]

C.S. A. Gigabit Ethernet

Device

Allows you to enable or disable the PCI device. Configuration options: [Disabled] [Enabled]

Option ROM Scan

Allows you to enable or disable the initialization of the expansion ROM. Configuration options: [Disabled] [Enabled]

Bus Master

Allows you to enable or disable the selected device as a PCI bus master. Configuration options: [Disabled] [Enabled]

Promise RAID

Device

Allows you to enable or disable the PCI device. Configuration options: [Disabled] [Enabled]

Option ROM Scan

Allows you to enable or disable the initialization of the expansion ROM. Configuration options: [Disabled] [Enabled]

Bus Master

Allows you to enable or disable the selected device as a PCI bus master. Configuration options: [Disabled] [Enabled]

Latency Timer

Allows you to select a value in units of PCI clocks for the PCI device latency timer register. Configuration options: [Default] [32] [64] [96] [128] [160] [192] [224]

PCI Slot 1/2/3/4/5 Configuration

Option ROM Scan

Allows you to enable or disable the initialization of the expansion ROM. Configuration options: [Disabled] [Enabled]

Bus Master

Allows you to enable or disable the selected device as a PCI bus master. Configuration options: [Disabled] [Enabled]

Latency Timer

Allows you to select a value in units of PCI clocks for the PCI device latency timer register. Configuration options: [Default] [32] [64] [96] [128] [160] [192] [224]

4.4.8 Hardware Health Configuration

The items in this menu allow you to configure and monitor the hardware health items.

BIOS SETUP UTILITY	
Advanced	
Hardware Health Configuration	
H/W Health Function	[Enabled]
Hardware Health Event Monitoring	
System Temperature	: 33°C/91°F
CPU Temperature	: 28°C/82°F
Temperature Sensor #1	: N/A
CPU Fan Speed	: 5232 RPM
VcoreA	: 1.48 V
+3.3Vin	: 3.435 V
+5Vin	: 5.094 V
+12Vin	: 11.951 V
Battery	: 3.112 V
↔ Select Screen ↑↓ Select Item Enter Go to Sub Screen F1 General Help F10 Save and Exit ESC Exit	
vMM.mm (C)Copyright 1985-2002, American Megatrends, Inc.	

H/W Health Function [Enabled]

Allows you to enable or disable the System Health Configuration feature. When this feature is enabled, the items in the menu displays the auto-detected fan speeds, system temperatures, and output voltages. When disabled, the items show [N/A]. Configuration options: [Disabled] [Enabled]

4.4.9 Remote Access Configuration

The item in this menu allows you to configure the remote access type and parameters.



4.5 Security menu

The Security menu items allow you to change the system security settings. Select an item then press Enter to display the configuration options.



4.5.1 Set Setup/System Password Clear System Password

Select this item to set or change the supervisor password. The Setup Password item on top of the screen shows the default **Not Installed**. After you have set a password, this item shows **Installed**.

To set a Setup Password:

1. Select the **Set Setup Password** item and press Enter.
2. On the password box that appears, type a password composed of letters and/or numbers, then press Enter. Your password should have at least six characters.
3. Confirm the password when prompted.
The message "Password Installed" appears after you have successfully set your password.

The Setup Password item now shows **Installed**.



The item **Set System Password** appears after you installed a Setup password. To install a System password, follow the same procedure as in setting a Setup password.

To change the Setup/System password:

Follow the same steps as in setting the password.

To clear the Setup/System password:

- Select Set Setup Password/Set System Password, then press Enter. The message “Password Uninstalled” appears.

OR

- Select Clear System Password, then press Enter. When prompted with the message “Clear System Password?” select **OK**, then press Enter.

4.5.2 Setup Password Lock [Standard]

When set to Extended, allows you to lock the keyboard when installing adapter cards. Configuration options: [Standard] [Extended]

4.5.3 System Password Mode [System]

When set to System, BIOS requires you to enter the System Password to continue the boot process. **When set to Keyboard, the system is secured at boot to prevent tampering during network operation.**

Configuration options: [System] [Keyboard]

4.5.4 Boot Sector Virus Protection [Disabled]

Allows you to enable or disable the boot sector virus protection.

Configuration options: [Disabled] [Enabled]

4.5.5 Diskette Write [Enabled]

Allows you to enable or disable the write function on a floppy disk.

Configuration options: [Disabled] [Enabled]

4.5.6 Flash Write [Enabled]

Allows you to enable or disable the write function to the BIOS Flash memory. Setting to Disabled write-protects the BIOS Flash memory.

Configuration options: [Disabled] [Enabled]

4.5.7 System Load [Standard]

Set to Standard to allow booting from a floppy disk or an ATAPI-CD-ROM.

Set to Diskette/CDROM Lock to prevent booting from these drives.

Configuration options: [Standard] [Diskette/CDROM Lock]

4.5.8 Setup Prompt [Enabled]

When set to Enabled, displays the message "Press DEL to run Setup"

during POST. Configuration options: [Disabled] [Enabled]

4.6 Power menu

The Power menu items allow you to change the settings for the Advanced Power Management (APM). Select an item then press Enter to display the configuration options.

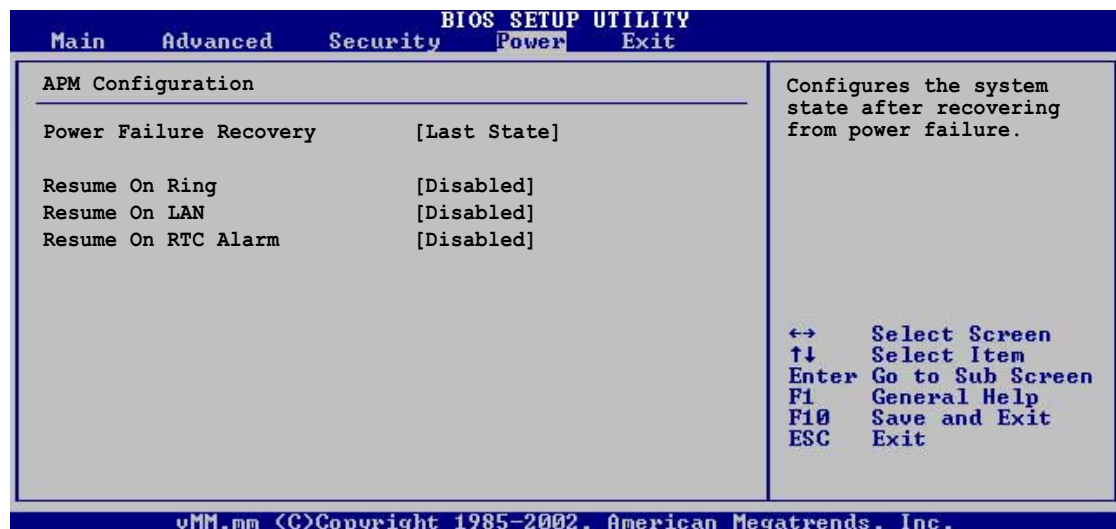

4.6.1 Power Failure Recovery [Last State]

When set to Power Off, the system goes into off state after an AC power loss. When set to Power On, the system goes on after an AC power loss. When set to Last State, the system goes into either off or on state whatever was the system state before the AC power loss. Configuration options: [Power Off] [Power On] [Last State]

4.6.2 Resume On Ring [Disabled]

Allows you to enable or disable RI to generate a wake event. Configuration options: [Disabled] [Enabled]

4.6.2 Resume On LAN [Disabled]

Allows you to enable or disable LAN GPI to generate a wake event. Configuration options: [Disabled] [Enabled]

4.6.3 Resume On RTC Alarm [Disabled]

Allows you to enable or disable RTC to generate a wake event. When this item is set to Enabled, the items RTC Alarm Date, RTC Alarm Hour, RTC Alarm Minute, and RTC Alarm Second appear with set values. Configuration options: [Disabled] [Enabled]

4.7 Exit menu

The Exit menu items allow you to load the optimal or failsafe default values for the BIOS items, and save or discard your changes to the BIOS items.

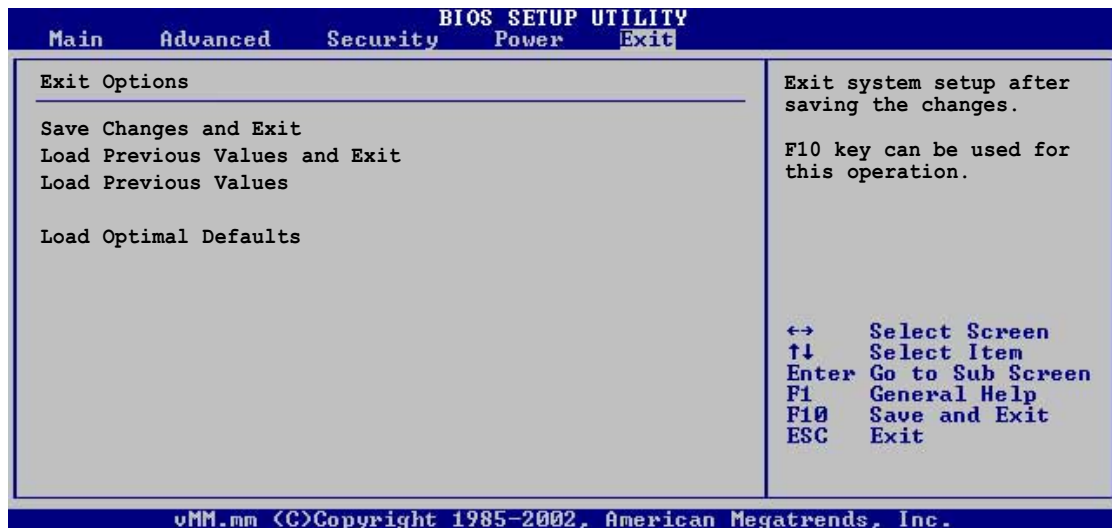

4.7.1 Save Changes and Exit

Saves the changes that you made before exiting Setup.

4.7.2 Load Previous Values and Exit

Exits setup without saving your changes. You may also use the ESC key for this operation.

4.7.3 Load Previous Values

Discards the changes that you made and restores the previously saved values. You may also use the F7 key for this operation.

4.7.4 Load Optimal Defaults

Loads the optimal values for the best system performance. You may also use the F9 key to load the optimal defaults.

Appendix

This appendix includes additional information that you may refer to when configuring the motherboard.

Reference information

Appnedix summary

A-1 Block diagram A-1

A.1 PSCH-L block diagram

