

P4GD1



Motherboard

E1675

**First Edition
July 2004**

Copyright © 2004 ASUSTeK COMPUTER INC. All Rights Reserved.

No part of this manual, including the products and software described in it, may be reproduced, transmitted, transcribed, stored in a retrieval system, or translated into any language in any form or by any means, except documentation kept by the purchaser for backup purposes, without the express written permission of ASUSTeK COMPUTER INC. ("ASUS").

Product warranty or service will not be extended if: (1) the product is repaired, modified or altered, unless such repair, modification or alteration is authorized in writing by ASUS; or (2) the serial number of the product is defaced or missing.

ASUS PROVIDES THIS MANUAL "AS IS" WITHOUT WARRANTY OF ANY KIND, EITHER EXPRESS OR IMPLIED, INCLUDING BUT NOT LIMITED TO THE IMPLIED WARRANTIES OR CONDITIONS OF MERCHANTABILITY OR FITNESS FOR A PARTICULAR PURPOSE. IN NO EVENT SHALL ASUS, ITS DIRECTORS, OFFICERS, EMPLOYEES OR AGENTS BE LIABLE FOR ANY INDIRECT, SPECIAL, INCIDENTAL, OR CONSEQUENTIAL DAMAGES (INCLUDING DAMAGES FOR LOSS OF PROFITS, LOSS OF BUSINESS, LOSS OF USE OR DATA, INTERRUPTION OF BUSINESS AND THE LIKE), EVEN IF ASUS HAS BEEN ADVISED OF THE POSSIBILITY OF SUCH DAMAGES ARISING FROM ANY DEFECT OR ERROR IN THIS MANUAL OR PRODUCT.

SPECIFICATIONS AND INFORMATION CONTAINED IN THIS MANUAL ARE FURNISHED FOR INFORMATIONAL USE ONLY, AND ARE SUBJECT TO CHANGE AT ANY TIME WITHOUT NOTICE, AND SHOULD NOT BE CONSTRUED AS A COMMITMENT BY ASUS. ASUS ASSUMES NO RESPONSIBILITY OR LIABILITY FOR ANY ERRORS OR INACCURACIES THAT MAY APPEAR IN THIS MANUAL, INCLUDING THE PRODUCTS AND SOFTWARE DESCRIBED IN IT.

Products and corporate names appearing in this manual may or may not be registered trademarks or copyrights of their respective companies, and are used only for identification or explanation and to the owners' benefit, without intent to infringe.

Contents

| | |
|------------------------------------|------|
| Contents | iii |
| Notices | vii |
| Safety information | viii |
| About this guide | ix |
| Typography | x |
| P4GD1 specifications summary | xi |

Chapter 1: Product introduction

| | | |
|-------|--------------------------------|-----|
| 1.1 | Welcome! | 1-1 |
| 1.2 | Package contents | 1-1 |
| 1.3 | Special features | 1-2 |
| 1.3.1 | Product highlights | 1-2 |
| 1.3.2 | ASUS Proactive features | 1-4 |
| 1.3.3 | Innovative ASUS features | 1-4 |

Chapter 2: Hardware information

| | | |
|-------|---------------------------------------|------|
| 2.1 | Before you proceed | 2-1 |
| 2.2 | Motherboard overview | 2-2 |
| 2.2.1 | Placement direction | 2-2 |
| 2.2.2 | Screw holes | 2-2 |
| 2.2.3 | Motherboard layout | 2-3 |
| 2.2.4 | Layout Contents | 2-4 |
| 2.3 | Central Processing Unit (CPU) | 2-6 |
| 2.3.1 | Overview | 2-6 |
| 2.3.2 | Installing the CPU | 2-7 |
| 2.3.3 | Installing the heatsink and fan | 2-9 |
| 2.4 | System memory | 2-12 |
| 2.4.1 | Overview | 2-12 |
| 2.4.2 | Memory Configurations | 2-12 |
| 2.4.3 | Installing a DIMM | 2-15 |
| 2.4.4 | Removing a DIMM | 2-15 |
| 2.5 | Expansion slots | 2-16 |
| 2.5.1 | Installing an expansion card | 2-16 |
| 2.5.2 | Configuring an expansion card | 2-16 |
| 2.5.3 | Interrupt assignments | 2-17 |
| 2.5.4 | PCI slots | 2-18 |

Contents

| | | |
|-------|-----------------------------|------|
| 2.5.5 | PCI Express x16 slot | 2-18 |
| 2.5.6 | PCI Express x1 slot | 2-18 |
| 2.6 | Jumpers | 2-19 |
| 2.7 | Connectors | 2-22 |
| 2.7.1 | Rear panel connectors | 2-22 |
| 2.7.2 | Internal connectors | 2-24 |

Chapter 3: Powering up

| | | |
|-------|--|-----|
| 3.1 | Starting up for the first time | 3-1 |
| 3.2 | Powering off the computer | 3-2 |
| 3.2.1 | Using the OS shut down function | 3-2 |
| 3.2.2 | Using the dual function power switch | 3-2 |

Chapter 4: BIOS setup

| | | |
|-------|---------------------------------------|------|
| 4.1 | Managing and updating your BIOS | 4-1 |
| 4.1.1 | Creating a bootable floppy disk | 4-1 |
| 4.1.2 | ASUS EZ Flash utility | 4-2 |
| 4.1.3 | AFUDOS utility | 4-3 |
| 4.1.4 | ASUS CrashFree BIOS 2 utility | 4-5 |
| 4.1.5 | ASUS Update utility | 4-7 |
| 4.2 | BIOS setup program | 4-10 |
| 4.2.1 | BIOS menu screen | 4-11 |
| 4.2.2 | Menu bar | 4-11 |
| 4.2.3 | Navigation keys | 4-11 |
| 4.2.4 | Menu items | 4-12 |
| 4.2.5 | Sub-menu items | 4-12 |
| 4.2.6 | Configuration fields | 4-12 |
| 4.2.7 | Pop-up window | 4-12 |
| 4.2.8 | Scroll bar | 4-12 |
| 4.2.9 | General help | 4-12 |
| 4.3 | Main menu | 4-13 |
| 4.3.1 | System Time | 4-13 |
| 4.3.2 | System Date | 4-13 |
| 4.3.3 | Legacy Diskette A | 4-13 |
| 4.3.4 | Language | 4-13 |

Contents

| | | |
|-------|--|------|
| 4.3.5 | Primary, Third and Fourth IDE Master/Slave | 4-14 |
| 4.3.6 | IDE Configuration | 4-15 |
| 4.3.7 | System Information | 4-16 |
| 4.4 | Advanced menu | 4-17 |
| 4.4.1 | JumperFree Configuration | 4-17 |
| 4.4.2 | LAN Cable Status | 4-20 |
| 4.4.3 | USB Configuration | 4-21 |
| 4.4.4 | CPU Configuration | 4-22 |
| 4.4.5 | Chipset | 4-23 |
| 4.4.6 | Onboard Devices Configuration | 4-25 |
| 4.4.7 | PCI PnP | 4-27 |
| 4.5 | Power menu | 4-28 |
| 4.5.1 | Suspend Mode | 4-28 |
| 4.5.2 | Repost Video on S3 Resume | 4-28 |
| 4.5.3 | ACPI 2.0 Support | 4-28 |
| 4.5.4 | ACPI APIC Support | 4-28 |
| 4.5.5 | APM Configuration | 4-29 |
| 4.5.6 | Hardware Monitor | 4-31 |
| 4.6 | Boot menu | 4-33 |
| 4.6.1 | Boot Device Priority | 4-33 |
| 4.6.2 | Boot Settings Configuration | 4-34 |
| 4.6.3 | Security | 4-35 |
| 4.7 | Exit menu | 4-37 |

Chapter 5: Software support

| | | |
|-------|--------------------------------------|-----|
| 5.1 | Installing an operating system | 5-1 |
| 5.2 | Support CD information | 5-1 |
| 5.2.1 | Running the support CD | 5-1 |
| 5.2.2 | Drivers menu | 5-2 |
| 5.2.3 | Utilities menu | 5-3 |
| 5.2.4 | Manuals menu | 5-5 |
| 5.2.5 | ASUS Contact information | 5-6 |
| 5.2.6 | Other information | 5-6 |
| 5.3 | Software information | 5-8 |
| 5.3.1 | ASUS MyLogo™ | 5-8 |

Contents

| | | |
|-------|---------------------------------------|------|
| 5.3.2 | AI NET 2 | 5-10 |
| | Using the Virtual Cable Tester™ | 5-10 |
| 5.3.3 | Audio configurations | 5-11 |
| 5.4 | RAID configurations | 5-16 |
| 5.4.1 | Installing hard disks | 5-17 |
| 5.4.2 | ITE® 8212F RAID configurations | 5-18 |
| 5.5 | Creating a RAID driver disk | 5-24 |

Notices

Federal Communications Commission Statement

This device complies with Part 15 of the FCC Rules. Operation is subject to the following two conditions:

- This device may not cause harmful interference, and
- This device must accept any interference received including interference that may cause undesired operation.

This equipment has been tested and found to comply with the limits for a Class B digital device, pursuant to Part 15 of the FCC Rules. These limits are designed to provide reasonable protection against harmful interference in a residential installation. This equipment generates, uses and can radiate radio frequency energy and, if not installed and used in accordance with manufacturer's instructions, may cause harmful interference to radio communications. However, there is no guarantee that interference will not occur in a particular installation. If this equipment does cause harmful interference to radio or television reception, which can be determined by turning the equipment off and on, the user is encouraged to try to correct the interference by one or more of the following measures:

- Reorient or relocate the receiving antenna.
- Increase the separation between the equipment and receiver.
- Connect the equipment to an outlet on a circuit different from that to which the receiver is connected.
- Consult the dealer or an experienced radio/TV technician for help.



The use of shielded cables for connection of the monitor to the graphics card is required to assure compliance with FCC regulations. Changes or modifications to this unit not expressly approved by the party responsible for compliance could void the user's authority to operate this equipment.

Canadian Department of Communications Statement

This digital apparatus does not exceed the Class B limits for radio noise emissions from digital apparatus set out in the Radio Interference Regulations of the Canadian Department of Communications.

This class B digital apparatus complies with Canadian ICES-003.

Safety information

Electrical safety

- To prevent electrical shock hazard, disconnect the power cable from the electrical outlet before relocating the system.
- When adding or removing devices to or from the system, ensure that the power cables for the devices are unplugged before the signal cables are connected. If possible, disconnect all power cables from the existing system before you add a device.
- Before connecting or removing signal cables from the motherboard, ensure that all power cables are unplugged.
- Seek professional assistance before using an adapter or extension cord. These devices could interrupt the grounding circuit.
- Make sure that your power supply is set to the correct voltage in your area. If you are not sure about the voltage of the electrical outlet you are using, contact your local power company.
- If the power supply is broken, do not try to fix it by yourself. Contact a qualified service technician or your retailer.

Operation safety

- Before installing the motherboard and adding devices on it, carefully read all the manuals that came with the package.
- Before using the product, make sure all cables are correctly connected and the power cables are not damaged. If you detect any damage, contact your dealer immediately.
- To avoid short circuits, keep paper clips, screws, and staples away from connectors, slots, sockets and circuitry.
- Avoid dust, humidity, and temperature extremes. Do not place the product in any area where it may become wet.
- Place the product on a stable surface.
- If you encounter technical problems with the product, contact a qualified service technician or your retailer.

About this guide

This user guide contains the information you need when installing and configuring the motherboard.

How this guide is organized

This manual contains the following parts:

- **Chapter 1: Product introduction**
This chapter describes the features of the motherboard and the new technology it supports.
- **Chapter 2: Hardware information**
This chapter lists the hardware setup procedures that you have to perform when installing system components. It includes description of the switches, jumpers, and connectors on the motherboard.
- **Chapter 3: Powering up**
This chapter describes the power up sequence, the vocal POST messages, and ways of shutting down the system.
- **Chapter 4: BIOS setup**
This chapter tells how to change system settings through the BIOS Setup menus. Detailed descriptions of the BIOS parameters are also provided.
- **Chapter 5: Software support**
This chapter describes the contents of the support CD that comes with the motherboard package.

Where to find more information

Refer to the following sources for additional information and for product and software updates.

1. ASUS websites

The ASUS website provides updated information on ASUS hardware and software products. Refer to the ASUS contact information.

2. Optional documentation

Your product package may include optional documentation, such as warranty flyers, that may have been added by your dealer. These documents are not part of the standard package.

Conventions used in this guide

To make sure that you perform certain tasks properly, take note of the following symbols used throughout this manual.



DANGER/WARNING: Information to prevent injury to yourself when trying to complete a task.



CAUTION: Information to prevent damage to the components when trying to complete a task.



IMPORTANT: Instructions that you **MUST** follow to complete a task.



NOTE: Tips and additional information to help you complete a task.

Typography

Bold text

Indicates a menu or an item to select

Italics

Used to emphasize a word or a phrase

<Key>

Keys enclosed in the less-than and greater-than sign means that you must press the enclosed key

Example: <Enter> means that you must press the Enter or Return key

<Key1+Key2+Key3>

If you must press two or more keys simultaneously, the key names are linked with a plus sign (+)

Example: <Ctrl+Alt+D>

Command

Means that you must type the command exactly as shown, then supply the required item or value enclosed in brackets

Example: At the DOS prompt, type the command line:

```
afudos /i[filename]
```

```
afudos /iP4GD1.ROM
```

P4GD1 specifications summary

| | |
|------------------------------|--|
| CPU | Socket 478 for Intel® Pentium® 4 / Celeron processors Supports Intel® Hyper-Threading Technology |
| Chipset | Northbridge: Intel® 915P Memory Controller Hub (MCH) Southbridge: Intel® ICH6 |
| Front Side Bus | 800/533/400 MHz |
| Memory | Dual-channel memory architecture 4 x 184-pin DIMM sockets support unbuffered non-ECC 400/333 MHz DDR memory modules Supports up to 4 GB of system memory |
| Expansion slots | 1 x PCI Express x16 slot for discrete graphics card 3 x PCI Express x1 slots 3 x PCI slots |
| Storage | Intel® ICH6 Southbridge supports: - 1 x Ultra DMA 100/66/33 drives - 4 x Serial ATA drives ITE 8212F IDE RAID controller supports: - 2 x Ultra DMA 133/100/66 drives - RAID 0, RAID 1, RAID 0+1, JBOD configuration |
| High Definition Audio | Intel® High Definition Audio Realtek® ALC861 8-channel CODEC with Jack-sensing and Universal Audio Jack (UAJ®) technology S/PDIF out interface support |
| LAN | Marvell® 88E8053 PCI Express™ Gigabit LAN controller Supports Marvell® Virtual Cable Tester Technology Supports POST Network-diagnostic program |
| Overclocking | ASUS AI NOS (Non-delay Overclocking System) feature ASUS AI Overclocking (Intelligent CPU frequency tuner) ASUS C.P.R. (CPU Parameter Recall) CPU, Memory, and PCI Express voltage adjustable Stepless Frequency Selection(SFS) from 100 MHz up to 400 MHz at 1 MHz increment Adjustable FSB/DDR ratio with fixed PCI/PCI-Express frequencies |
| USB | Supports up to 8 USB 2.0 ports |
| Special features | ASUS Q-Fan ASUS CrashFree BIOS 2 ASUS Multi-language BIOS ASUS MyLogo |

(continued on the next page)

P4GD1 specifications summary

| | |
|----------------------------|---|
| BIOS features | 4 MB Flash ROM, AMI BIOS, PnP, DMI2.0, SM BIOS 2.3, WfM2.0 |
| Rear panel | 1 x Parallel port 1 x LAN (RJ-45) port 1 x Rear speaker out port 1 x Side speaker out port 1 x Line In port 1 x Line Out port 1 x Microphone port 1 x Center/Subwoofer port 4 x USB 2.0 ports 1 x Serial port (COM) 1 x Coaxial S/PDIF out port 1 x PS/2 keyboard port 1 x PS/2 mouse port |
| Internal connectors | 1 x CPU fan connector 1 x Power fan connector 1 x Chassis fan connector 1 x Serial port connector (COM2 port) 1 x 24-pin ATX power connector 1 x 4-pin ATX 12 V power connector 2 x USB 2.0 connectors for 4 additional USB 2.0 ports 1 x Optical drive audio connector 1 x GAME/MIDI connector 1 x Chassis intrusion connector 1 x Front panel audio connector System panel connector |
| Power Requirement | ATX power supply (with 24-pin and 4-pin 12 V plugs) ATX 12 V 2.0 compliant |
| Form Factor | ATX form factor: 12 in x 9.6 in (30.5 cm x 24.4 cm) |
| Support CD contents | Device drivers ASUS PC Probe ASUS Live Update utility Anti-virus software (OEM version) |

**Specifications are subject to change without notice.*

This chapter describes the motherboard features and the new technologies it supports.

Product introduction



Chapter summary

| | | |
|-----|------------------------|-----|
| 1.1 | Welcome! | 1-1 |
| 1.2 | Package contents | 1-1 |
| 1.3 | Special features | 1-2 |

1.1 Welcome!

Thank you for buying an ASUS® P4GD1 motherboard!

The motherboard delivers a host of new features and latest technologies, making it another standout in the long line of ASUS quality motherboards!

Before you start installing the motherboard, and hardware devices on it, check the items in your package with the list below.

1.2 Package contents

Check your motherboard package for the following items.

| | |
|------------------------|---|
| Motherboard | ASUS P4GD1 motherboard |
| I/O modules | USB 2.0 (2 ports) and GAME (1 port) module |
| Cables | 2 x Serial ATA signal cables 1 x Serial ATA power cables 1 x Ultra DMA/133 cables 1 x IDE cable Floppy disk drive cable |
| Accessories | I/O shield |
| Application CDs | ASUS motherboard support CD |
| Documentation | User guide |



If any of the above items is damaged or missing, contact your retailer.

1.3 Special features

1.3.1 Product highlights

Latest processor technology

The motherboard comes with a 478-pin surface mount, Zero Insertion Force (ZIF) socket for the Intel® Pentium® 4 processor in the 478-pin package with 512/256KB L2 cache on 0.13 micron process. This motherboard supports 800/533/400 MHz system front side bus that allows 6.4GB/s, 4.3GB/s and 3.2GB/s data transfer rates, respectively. The motherboard also supports Intel® Pentium® 4 processors with Hyper-Threading Technology.

Intel® 915P

The Intel® 915P chipset provides the interface for a processor in the 478-pin package with 400/533/800MHz front side bus (FSB), dual channel DDR at speeds of up to 400MHz, and PCI Express x16-lane port for graphics card. The Intel® 915P GMCH platform is compliant to the Direct Media Interface (DMI) and supports the sixth generation I/O Controller Hub (ICH6).

Dual-channel DDR memory support

Employing the Double Data Rate (DDR) memory technology, the motherboard supports up to 4GB of system memory using DDR400/333 DIMMs. The ultra-fast 400MHz memory bus delivers the required bandwidth for the latest 3D graphics, multimedia, and Internet applications. See page 2-12 for details.

PCI Express™ interface

The motherboard fully supports PCI Express, the latest I/O interconnect technology that speeds up the PCI bus. PCI Express features point-to-point serial interconnections between devices and allows higher clockspeeds by carrying data in packets. This high speed interface is software compatible with existing PCI specifications. See page 2-18 for details.

Serial ATA technology

The motherboard supports the Serial ATA technology through the Serial ATA interfaces and the Intel® ICH6. The SATA specification allows for thinner, more flexible cables with lower pin count, reduced voltage requirement, and up to 150 MB/s data transfer rate. See page 2-26 for details.

RAID solution

Onboard RAID controller provides the motherboard with RAID functionality that allows you to select the best RAID solution using IDE disk drives.

The ITE 8212 controller provides RAID 0, RAID 1, RAID 0+1, and JBOD functionality for two IDE channels that supports for up to four IDE hard disk drives. See pages 2-25 and 5-16 for details.

8-channel high definition audio

The motherboard supports 8-channel High Definition Audio through the onboard ALC861 CODEC with 24-bit DAC, a stereo 16-bit ADC, and an AC97 2.3 compatible multi-channel audio designed for PC multimedia systems. It also provides a Jack-Sensing function, S/PDIF out support, interrupt capability and includes the Realtek® proprietary UAJ® (Universal Audio Jack) technology. See page 2-22, 2-23 and 5-11 for details.

S/PDIF digital sound ready

The motherboard supports the S/PDIF Out function through the S/PDIF interfaces on the rear panel and at midboard. The S/PDIF technology turns your computer into a high-end entertainment system with digital connectivity to powerful audio and speaker systems. See page 2-23 for details.

USB 2.0 technology

The motherboard implements the Universal Serial Bus (USB) 2.0 specification, dramatically increasing the connection speed from the 12 Mbps bandwidth on USB 1.1 to a fast 480 Mbps on USB 2.0. USB 2.0 is backward compatible with USB 1.1. See page 2-23 and 2-28 for details.

Temperature, fan, and voltage monitoring

The CPU temperature is monitored by the ASIC (integrated in the Winbond Super I/O) to prevent overheating and damage. The system fan rotations per minute (RPM) is monitored for timely failure detection. The ASIC monitors the voltage levels to ensure stable supply of current for critical components.

1.3.2 ASUS Proactive features

AI NOS™ (Non-Delay Overclocking System)



The ASUS Non-delay Overclocking System™ (NOS) is a technology that auto-detects the CPU loading and dynamically overclocks the CPU speed only when needed.

AI NET2

The AI NET2 is a BIOS-based diagnostic tool that detects and reports Ethernet cable faults and shorts. With this utility, you can easily monitor the condition of the Ethernet cable(s) connected to the LAN (RJ-45) port(s). During the bootup process, AI NET2 immediately diagnoses the LAN cable(s) and reports shorts and faults up to 100 meters at 1 meter accuracy. See pages 2-22 and 5-10.

1.3.3 Innovative ASUS features

CrashFree BIOS 2

This feature allows you to restore the original BIOS data from the support CD in case when the BIOS codes and data are corrupted. This protection eliminates the need to buy a replacement ROM chip. See details on page 4-5.

ASUS Q-Fan technology

The ASUS Q-Fan technology smartly adjusts the CPU fan speed according to the system loading to ensure quiet, cool, and efficient operation. See page 4-31 for details.

ASUS Multi-language BIOS

The multi-language BIOS allows you to select the language of your choice from the available options. The localized BIOS menus allow you to configure easier and faster. See page 4-13 for details.

ASUS MyLogo™

This new feature present in the motherboard allows you to personalize and add style to your system with customizable boot logos.

This chapter lists the hardware setup procedures that you have to perform when installing system components. It includes description of the jumpers and connectors on the motherboard.

Hardware information



Chapter summary

| | | |
|-----|-------------------------------------|------|
| 2.1 | Before you proceed | 2-1 |
| 2.2 | Motherboard overview | 2-2 |
| 2.3 | Central Processing Unit (CPU) | 2-6 |
| 2.4 | System memory | 2-12 |
| 2.5 | Expansion slots | 2-16 |
| 2.6 | Jumpers | 2-19 |
| 2.7 | Connectors | 2-22 |

2.1 Before you proceed

Take note of the following precautions before you install motherboard components or change any motherboard settings.



- Unplug the power cord from the wall socket before touching any component.
- Use a grounded wrist strap or touch a safely grounded object or to a metal object, such as the power supply case, before handling components to avoid damaging them due to static electricity
- Hold components by the edges to avoid touching the ICs on them.
- Whenever you uninstall any component, place it on a grounded antistatic pad or in the bag that came with the component.
- **Before you install or remove any component, ensure that the ATX power supply is switched off or the power cord is detached from the power supply.** Failure to do so may cause severe damage to the motherboard, peripherals, and/or components.

Onboard LED

The motherboard comes with a standby power LED that lights up to indicate that the system is ON, in sleep mode, or in soft-off mode. This is a reminder that you should shut down the system and unplug the power cable before removing or plugging in any motherboard component. The illustration below shows the location of the onboard LED.

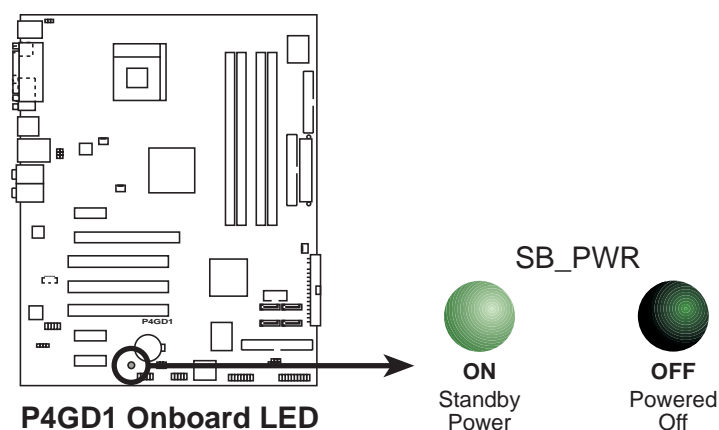

2.2 Motherboard overview

Before you install the motherboard, study the configuration of your chassis to ensure that the motherboard fits into it.



Make sure to unplug the power cord before installing or removing the motherboard. Failure to do so can cause you physical injury and damage motherboard components.

2.2.1 Placement direction

When installing the motherboard, make sure that you place it into the chassis in the correct orientation. The edge with external ports goes to the rear part of the chassis as indicated in the image below.

2.2.2 Screw holes

Place nine (9) screws into the holes indicated by circles to secure the motherboard to the chassis.



Do not overtighten the screws! Doing so can damage the motherboard.

Place this side towards
the rear of the chassis

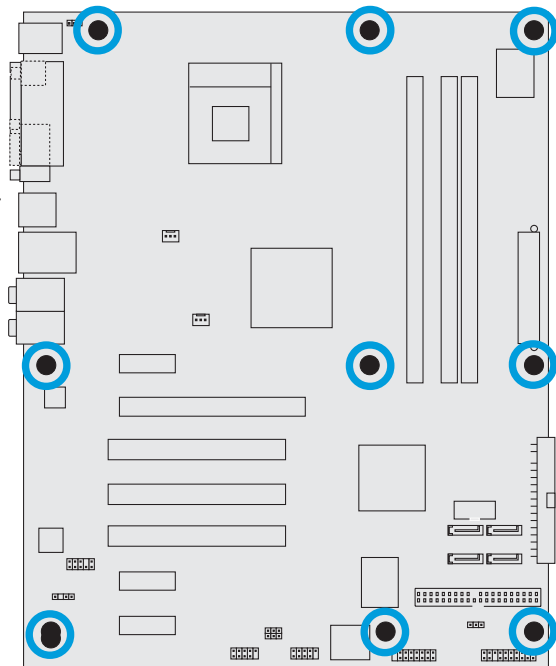

2.2.3 Motherboard layout

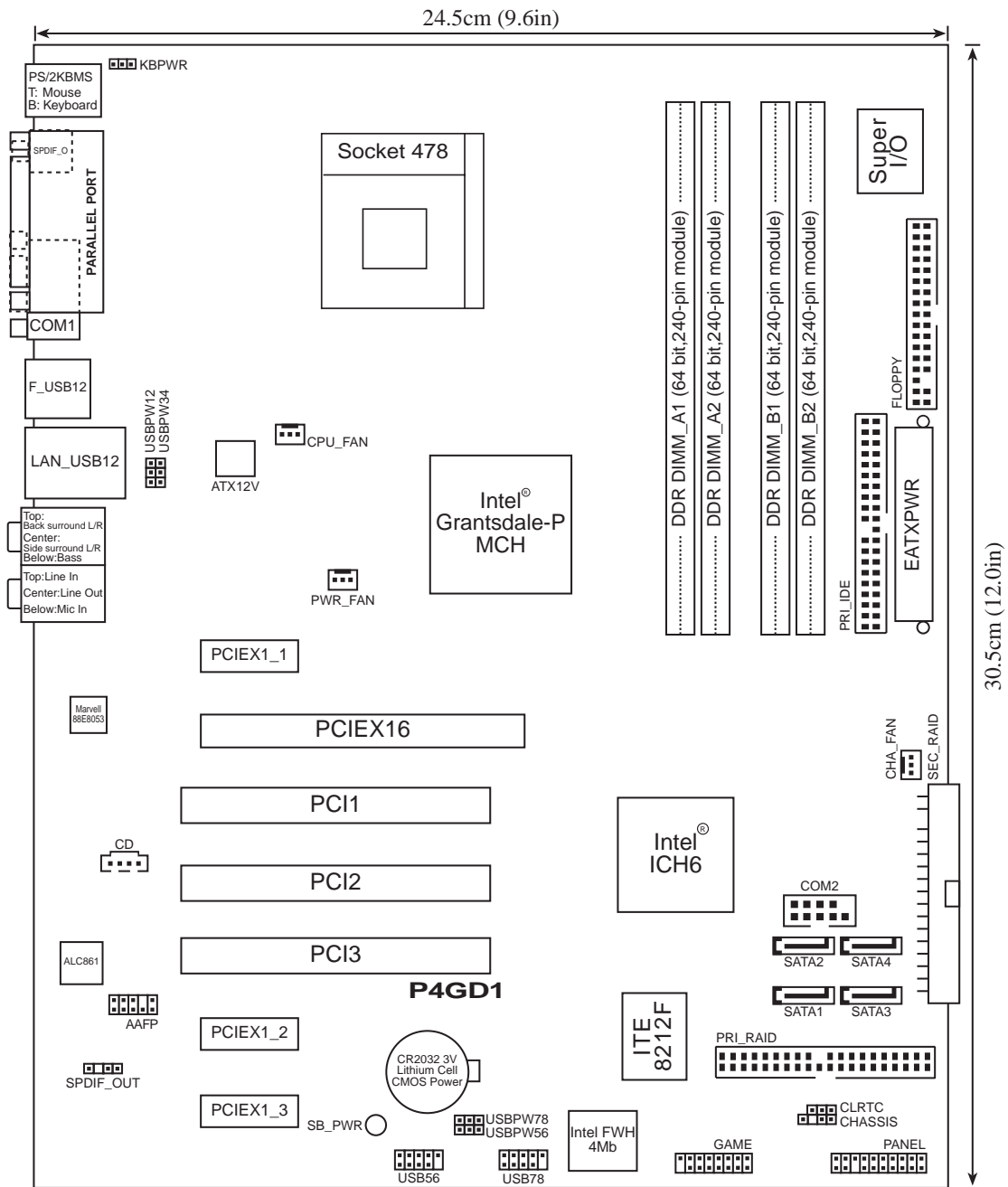

2.2.4 Layout Contents

| Slots | Page |
|---------------------|------|
| 1. DDR DIMM slots | 2-12 |
| 2. PCI slots | 2-18 |
| 3. PCI Express slot | 2-18 |

| Jumpers | Page |
|--|------|
| 1. Clear RTC RAM (3-pin CLRTC1) | 2-19 |
| 2. USB Device wake-up (3-pin USBPW12, USBPW34, USBPW56, USBPW78) | 2-20 |
| 3. Keyboard power (3-pin KBPWR1) | 2-21 |

| Rear panel connectors | Page |
|-----------------------------|------|
| 1. PS/2 mouse port | 2-22 |
| 2. Parallel port | 2-22 |
| 3. RJ-45 port | 2-22 |
| 4. Rear Speaker Out port | 2-22 |
| 5. Side Speaker Out port | 2-22 |
| 6. Line In port | 2-22 |
| 7. Line Out port | 2-22 |
| 8. Microphone port | 2-22 |
| 9. Center/Subwoofer port | 2-22 |
| 10. USB 2.0 ports 3 and 4 | 2-23 |
| 11. USB 2.0 ports 1 and 2 | 2-23 |
| 12. Serial connector | 2-23 |
| 13. S/PDIF coaxial out port | 2-23 |
| 14. PS/2 keyboard port | 2-23 |

| Internal connectors | Page |
|---|------|
| 1. Floppy disk drive connector (34-1 pin FLOPPY) | 2-24 |
| 2. Primary IDE connector (40-1 pin PRI_IDE) | 2-24 |
| 3. Primary RAID ATA connector (40-1 pin PRI_RAID) | 2-25 |
| 4. Secondary RAID ATA connector (40-1 pin SEC_RAID) | 2-25 |
| 5. Serial ATA connectors (7-pin SATA1, SATA2, SATA3, SATA4) | 2-26 |
| 6. CPU fan connector (3-pin CPU_FAN) | 2-27 |
| 7. Power fan connector (3-pin PWR_FAN) | 2-27 |
| 8. Chassis fan connector (3-pin CHA_FAN) | 2-27 |
| 9. Serial port connector (10-1 pin COM2) | 2-28 |
| 10. USB headers (10-1 USB56, USB78) | 2-28 |
| 11. ATX power connector (24-pin EATXPWR) | 2-29 |
| 12. ATX 12V power connector (4-pin ATX12V) | 2-29 |
| 13. Optical audio connector (4-pin CD) | 2-30 |
| 14. GAME/MIDI connector (16-1 pin GAME) | 2-30 |
| 15. Chassis intrusion connector (4-1 pin CHASSIS) | 2-31 |
| 16. Front panel audio connector (10-1 pin AAFP) | 2-31 |
| 17. System panel connectors (20-1 pin PANEL) | 2-32 |
| - System Power LED (Green 3-pin PLED) | |
| - Hard Disk activity (Red 2-pin IDE_LED) | |
| - System warning speaker (Orange 4-pin SPEAKER) | |
| - Power/Soft-off button (Yellow 2-pin PWRSW) | |
| - Reset switch (Blue 2-pin RESET) | |

2.3 Central Processing Unit (CPU)

2.3.1 Overview

The motherboard comes with a surface mount 478-pin Zero Insertion Force (ZIF) socket designed for the Intel® Pentium® 4 Processor.

Take note of the marked corner (with gold triangle) on the CPU. This mark should match a specific corner on the socket to ensure correct installation.

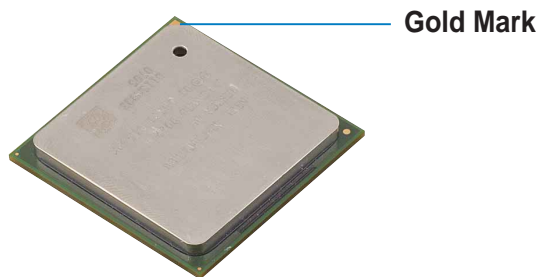

Your boxed Intel® Pentium® 4 processor package should come with installation instructions for the CPU, heatsink, and the retention mechanism. If the instructions in this section do not match the CPU documentation, follow the latter.



Incorrect installation of the CPU into the socket can bend the pins and severely damage the CPU!

Notes on Intel® Hyper-Threading Technology



- This motherboard supports Intel® Pentium® 4 CPUs with Hyper-Threading Technology.
 - Hyper-Threading Technology is supported under Windows® XP/2003 Server and Linux 2.4.x (kernel) and later versions only. Under Linux, use the Hyper-Threading compiler to compile the code. If you are using any other operating systems, disable the Hyper-Threading Technology item in BIOS to ensure system stability and performance.
 - We recommend that you install Windows® XP Service Pack 1.
 - Make sure to enable the Hyper-Threading Technology item in BIOS before installing a supported operating system
 - For more information on Hyper-Threading Technology, visit www.intel.com/info/hyperthreading.
-

To use the Hyper-Threading Technology on this motherboard:

1. Buy an Intel® Pentium® 4 CPU that supports Hyper-Threading Technology. Install the CPU.
2. Power up the system and enter BIOS Setup (see Chapter 4). Under the Advanced Menu, make sure that the item **Hyper-Threading Technology** is set to Enabled. The item appears only if you installed a CPU that supports Hyper-Threading Technology.
3. Reboot the computer.

2.3.2 Installing the CPU

Follow these steps to install a CPU.

1. Locate the 478-pin ZIF socket on the motherboard.

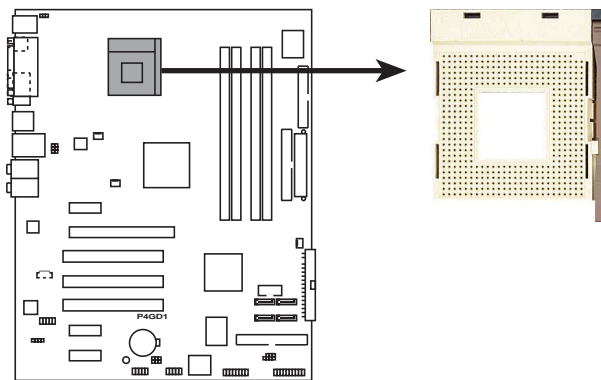

P4GD1 478-pin CPU Socket

2. Unlock the socket by pressing the lever sideways, then lift it up to a 90°-100° angle.

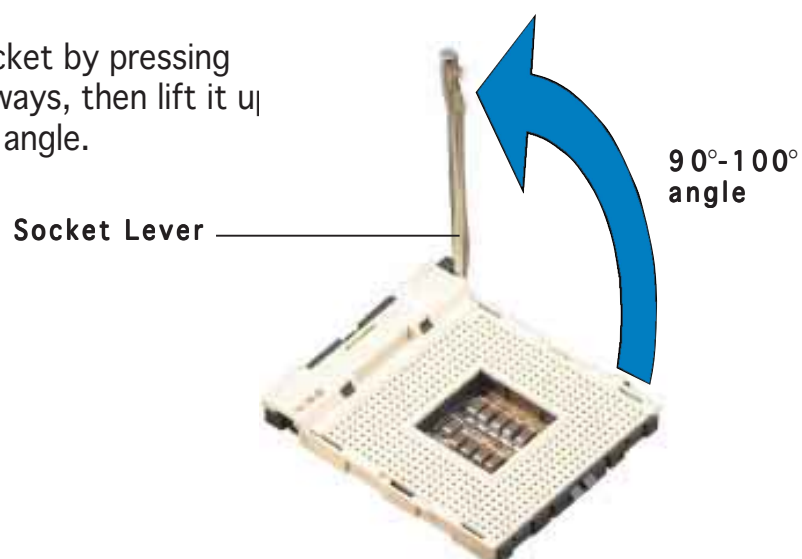

Make sure that the socket lever is lifted up to 90°-100° angle; otherwise, the CPU does not fit in completely.

3. Position the CPU above the socket such that its marked corner matches the base of the socket lever.
4. Carefully insert the CPU into the socket until it fits in place.

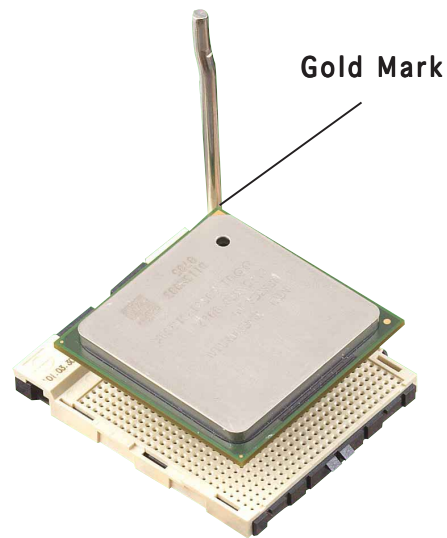

The CPU fits only in one correct orientation. DO NOT force the CPU into the socket to prevent bending the pins and damaging the CPU!

5. When the CPU is in place, push down the socket lever to secure the CPU. The lever clicks on the side tab to indicate that it is locked.

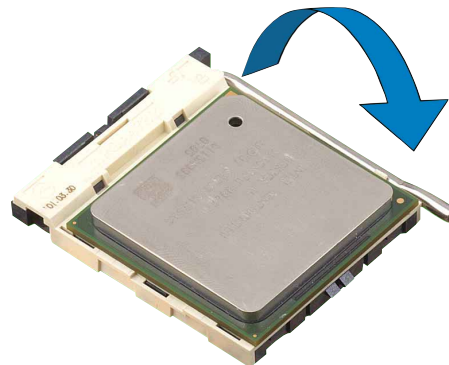

After installation, make sure to plug the 4-pin ATX power cable to the motherboard.



This motherboard does not support unlocked Intel® Pentium® 4 CPUs.

2.3.3 Installing the heatsink and fan

The Intel® Pentium® 4 Processor requires a specially designed heatsink and fan assembly to ensure optimum thermal condition and performance.



- When you buy a boxed Intel® Pentium® 4 processor, the package includes the heatsink, fan, and retention mechanism.
- If you buy a CPU separately, make sure that you use only Intel®-certified heatsink and fan.



If you purchased a separate CPU heatsink and fan assembly, make sure that a Thermal Interface Material is properly applied to the CPU heatsink or CPU before installing the heatsink and fan assembly.

Follow these steps to install the CPU heatsink and fan.

1. Place the heatsink on top of the installed CPU, making sure that the heatsink fits properly on the retention module base.



- The retention module base is already installed on the motherboard upon purchase.
- You do not have to remove the retention module base when installing the CPU or installing other motherboard components.

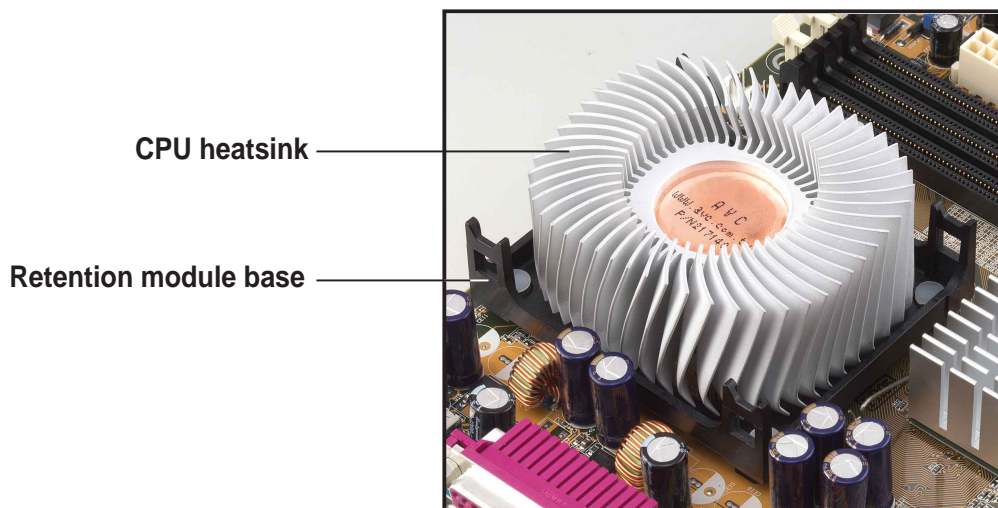

2. Position the fan with the retention mechanism on top of the heatsink. Align and snap the four hooks of the retention mechanism to the holes on each corner of the module base.



Make sure that the fan and retention mechanism assembly perfectly fits the heatsink and module base; otherwise, you cannot snap the hooks into the holes.

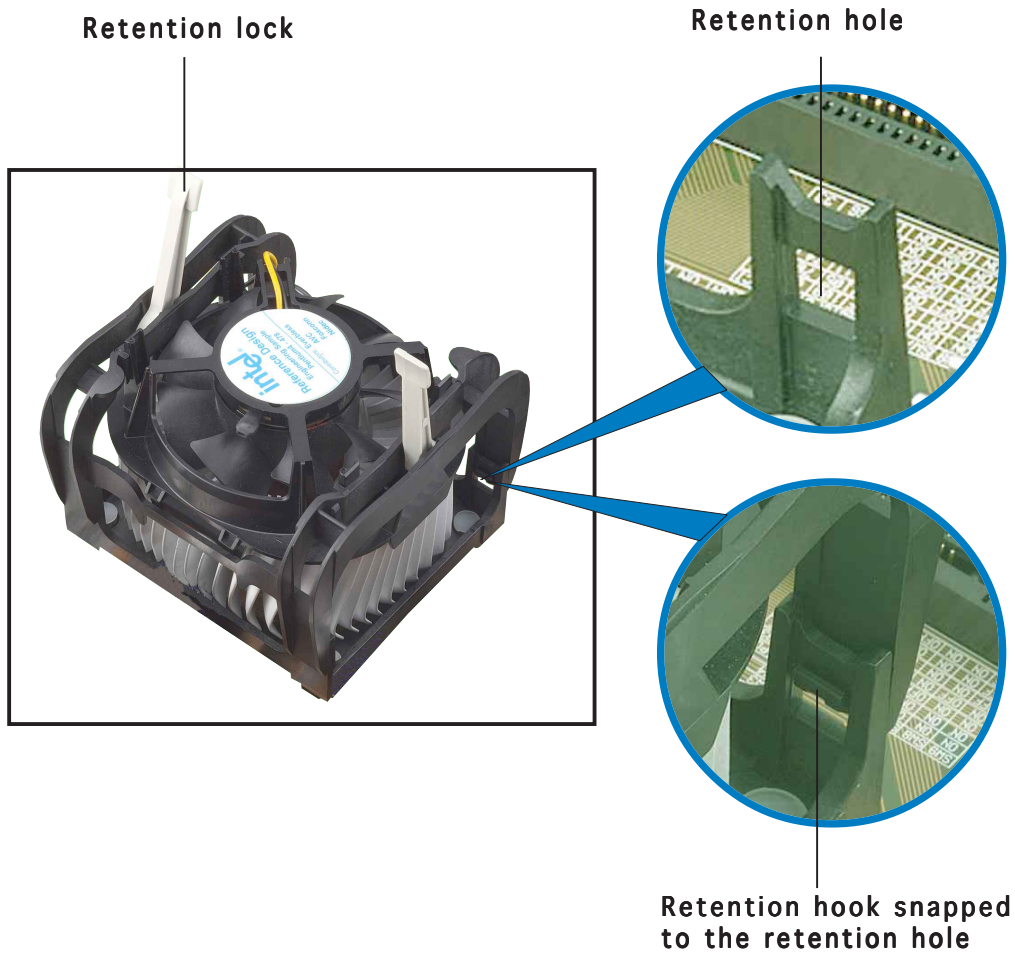

Keep the retention locks lifted upward while fitting the retention mechanism to the module base.

3. Push down the locks on the retention mechanism to secure the heatsink and fan to the module base.



When secure, the retention locks should point to opposite directions.



4. When the fan and heatsink assembly is in place, connect the CPU fan cable to the connector on the motherboard labeled CPU_FAN.

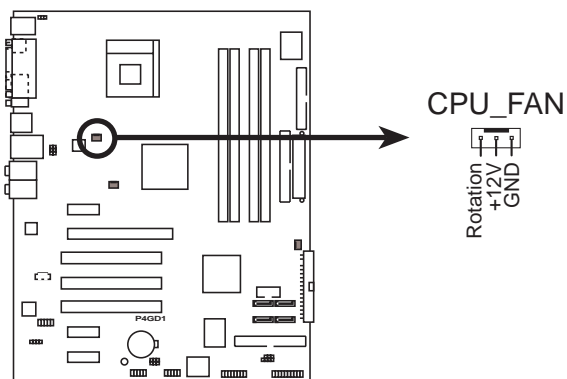

P4GD1 CPU Fan connector



Do not forget to connect the CPU fan connector! Hardware monitoring errors can occur if you fail to plug this connector.

2.4 System memory

2.4.1 Overview

The motherboard comes with four 184-pin Double Data Rate (DDR) Dual Inline Memory Modules (DIMM) sockets.

The following figure illustrates the location of the sockets:

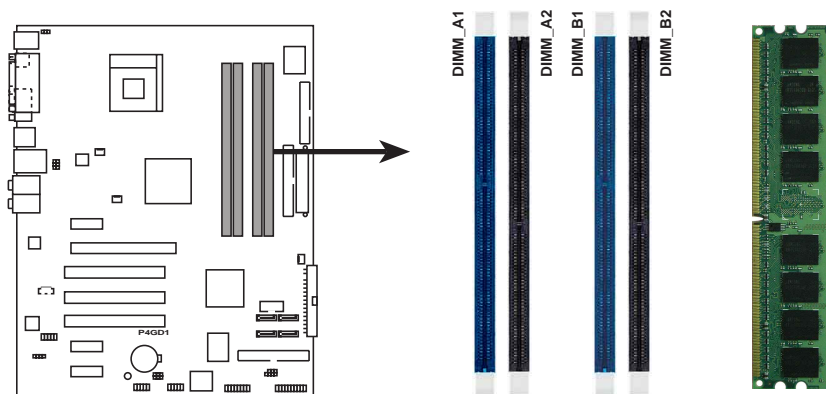

P4GD1 184-Pin DDR DIMM Sockets

2.4.2 Memory Configurations

You may install 128 MB, 256 MB, 512 MB, and 1 GB unbuffered non-ECC DDR DIMMs into the DIMM sockets using the memory configurations in this section.



- Installing DDR DIMMs other than the recommended configurations may cause memory sizing error or system boot failure. Use any of the recommended configurations in Table 1.
- In dual-channel configurations, install only **identical** (the same type and size) DDR DIMM pairs for each channel.
- Always install DIMMs with the same CAS latency. For optimum compatibility, it is recommended that you obtain memory modules from the same vendor.
- Double-sided x16 modules are not supported in this motherboard.
- Due to chipset resource allocation, the system may detect less than 4 GB of system memory when you installed four 1 GB DDR memory modules.
- Due to chipset limitation, DIMM modules with 128 Mb memory chips or double-sided x16 memory chips are not supported in this motherboard.

Table 1 Recommended memory configurations

| Mode | Sockets | | | |
|----------------|-------------------|--------------------|-------------------|--------------------|
| | DIMM_A1 (blue) | DIMM_A2 (black) | DIMM_B1 (blue) | DIMM_B2 (black) |
| Single-channel | (1) Populated | — | — | — |
| | (2) — | Populated | — | — |
| | (3) — | — | Populated | — |
| | (4) — | — | — | Populated |
| Dual-channel | (1) Populated | — | Populated | — |
| | (2) — | Populated | — | Populated |
| | (3)*Populated | Populated | Populated | Populated |

* For dual-channel configuration (3), you may:

- install identical DIMMs in all four sockets
- install identical DIMM pair in DIMM_A1 and DIMM_B1 (blue sockets) and identical DIMM pair in DIMM_A2 and DIMM_B2 (black sockets)
- install same size DIMMs in DIMM_A1 and DIMM_B1 (blue sockets) and another same size pair in DIMM_A2 and DIMM_B2 (black sockets)

Table 2 DDR400 Qualified Vendors List

| Size | Vendor | Model | Brand | Side(s) | Component | DIMM support A * B * C * |
|-------|----------|----------------------|--------------|---------|-------------------|-----------------------------|
| 256MB | KINGSTON | KVR400X64C3A/256 | Hynix | SS | HY5DU56822BT-D43 | • • |
| 512MB | KINGSTON | KVR400X64C3A/512 | Hynix | DS | HY5DU56822BT-D43 | • • |
| 256MB | KINGSTON | KVR400X64C3A/256 | Infineon | SS | HYB25D256800BT-5B | • • • |
| 512MB | KINGSTON | KVR400X64C3A/512 | Infineon | DS | HYB25D256809BT-5B | • • • |
| 256MB | KINGSTON | KVR400X64C3A/256 | KINGSTON | SS | D3208DL2T-5 | • • • |
| 512MB | KINGSTON | KVR400X64C3A/512 | KINGSTON | DS | D328DIB-50 | • • |
| 512MB | KINGSTON | KHX3200A/512 | N/A | DS | Heat-Sink Package | • • |
| 256MB | SAMSUNG | M368L3223ETM-CCC | SAMSUNG | SS | K4H560838E-TCCC | • • • |
| 256MB | SAMSUNG | M368L3223FTN-CCC | SAMSUNG | SS | K4H560838F-TCCC | • • |
| 512MB | SAMSUNG | M368L6423FTN-CCC | SAMSUNG | DS | K4H560838F-TCCC | • • |
| 512MB | Hynix | HYMD264646B8J-D43 AA | Hynix | DS | HY5DU56822BT-D43 | • • • |
| 256MB | MICRON | MT8VDDT3264AG-40BCB | MICRON | SS | MT46V32M8TG-5BC | • • |
| 512MB | MICRON | MT16VDDT6464AG-40BCB | MICRON | DS | MT46V32M8TG-5BC | • • • |
| 256MB | Infineon | HYS64D32300GU-5-B | Infineon | SS | HYB25D256800BT-5B | • • • |
| 512MB | Infineon | HYS64D64320GU-5-B | Infineon | DS | HYB25D256800BT-5B | • • |
| 256MB | Infineon | HYS64D32300HU-5-C | Infineon | SS | HYB25D256800CE-5C | • • • |
| 512MB | Infineon | HYS64D64320HU-5-C | Infineon | DS | HYB25D256800CE-5C | • • • |
| 256MB | CORSAIR | CMX256A-3200C2PT | Winbond | SS | W942508BH-5 | • • • |
| 512MB | CORSAIR | CMX512-3200C2 | Winbond | DS | Heat-Sink Package | • • • |
| 512MB | CORSAIR | VS512MB400 | VALUE seLecT | DS | VS32M8-5 | • • |
| 256MB | GEIL | GE2563200B | GEIL | SS | GL3LC32G88TG-5A | • • • |
| 512MB | GEIL | GE5123200B | GEIL | DS | GL3LC32G88TG-5A | • • |
| 512MB | GEIL | GE5123200B | GEIL | DS | GL3LC32G88TG-5A | • • • |
| 256MB | GEIL | GD3200-256V | GEIL | SS | GLIL DDR 32M8 | • • • |
| 512MB | GEIL | GD3200-512V | GEIL | DS | GLIL DDR 32M8 | • • • |

(Continued on the next page)

Table 2 DDR400 Qualified Vendors List

| Size | Vendor | Model | Brand | Side(s) | Component | DIMM support A * B * C * |
|--------|-------------|-----------------------|---------|---------|------------------|-----------------------------|
| 256MB | TwinMOS | M2S9I08AFAPS9F0811A-T | PSC | SS | A2S56D30ATP | • • • |
| 256MB | TwinMOS | M2G9I08AIATT9F081AADT | TwinMOS | SS | TMD7608F8E50D | • • • |
| 512MB | TwinMOS | M2G9J16AJATT9F081AADT | TwinMOS | DS | TMD7608F8E50D | • • |
| 256MB | Transcend | TS32MLD64V4F3 | Mosel | SS | V58C2256804SAT5B | • • • |
| 512MB | Transcend | TS64MLD64V4F3 | Mosel | DS | V58C2256804SAT5B | • • • |
| 256MB | Transcend | TS32MLD64V4F3 | SAMSUNG | SS | K4H560838E-TCCC | • |
| 512MB | Transcend | TS64MLD64V4F3 | SAMSUNG | DS | K4H560838E-TCCC | • • • |
| 256MB | A DATA | MDOSS6F3G31Y0K1EOZ | SAMSUNG | SS | K4H560838E-TCCC | • • • |
| 512MB | A DATA | MDOSS6F3H41Y0N1EOZ | SAMSUNG | DS | K4H560838E-TCCC | • • • |
| 256MB | A DATA | MDOHY6F3G31Y0N1EOZ | Hynix | SS | HY5DU56822CT-D43 | • • • |
| 512MB | A DATA | MDOHY6F3H41Y0N1EOZ | Hynix | DS | HY5DU56822CT-D43 | • • • |
| 256MB | A DATA | MDOAD5F3G31Y0D1E02 | N/A | SS | ADD8608A8A-5B | • • • |
| 512MB | A DATA | MDOAD5F3H41Y0D1E02 | N/A | DS | ADD8608A8A-5B | • • • |
| 256MB | Winbond | W9425GCDB-5 | Winbond | SS | W942508CH-5 | • • • |
| 512MB | Winbond | W9451GCDB-5 | Winbond | DS | W942508CH-5 | • • • |
| 256MB | PSC | AL5D8B53T-5B1K | PSC | SS | A2S56D30BTP | • • • |
| 512MB | PSC | AL6D8B53T-5B1K | PSC | DS | A2S56D30BTP | • • |
| 256MB | KINGMAX | MPXB62D-38KT3R | KINGMAX | SS | KDL388P4EA-50 | • • • |
| 512MB | KINGMAX | MPXC22D-38KT3R | KINGMAX | DS | KDL388P4EA-50 | • • • |
| 1024MB | ATP | AG28L64T8SMC4M | MICRON | DS | MT46V64M4TG-5BC | • • |
| 256MB | NANYA | NT256D64S88B1G-5T | NANYA | SS | NT5DS32M8BT-5T | • • • |
| 512MB | NANYA | N512D64S88B1G-5T | NANYA | DS | NT5DS32M8BT-5T | • • • |
| 256MB | BRAIN POWER | B6U808-256M-SAM-400 | SAMSUNG | SS | K4H560838D-TCC4 | • • • |
| 512MB | BRAIN POWER | B6U808-512M-SAM-400 | SAMSUNG | DS | K4H560838D-TCC4 | • • • |
| 256MB | CENTURY | DXV6S8SSCCD3K27C | SAMSUNG | SS | K4H560838D-TCCC | • • • |
| 512MB | CENTURY | DXV2S8SSCCD3K27C | SAMSUNG | DS | K4H560838D-TCCC | • • • |
| 256MB | CENTURY | DXV6S8SSCCE3K27E | SAMSUNG | SS | K4H560838E-TCCC | • • • |
| 512MB | CENTURY | DXV2S8SSCCE3K27E | SAMSUNG | DS | K4H560838E-TCCC | • • • |
| 256MB | CENTURY | DXV6S8MC5BC3U27E | MICRON | SS | MT46V32M8TG-5BC | • • • |
| 512MB | CENTURY | DXV2S8MC5BC3U27E | MICRON | DS | MT46V32M8TG-5BC | • • • |
| 256MB | elixir | M2U25664DS88B3G-5T | NANYA | SS | N2DS25680BT-5T | • • • |
| 512MB | elixir | M2U25664DS88B3G-5T | NANYA | DS | N2DS25680BT-5T | • • • |
| 256MB | Kreton | N/A | VT | SS | VT3225804T-5 | • • • |
| 512MB | Kreton | N/A | VT | DS | VT3225804T-5 | • • • |
| 256MB | Veritech | VT400FMV/2561103 | VT | SS | VT56DD32M8PC-5 | • • • |
| 512MB | Veritech | VT400FMV/5121003 | VT | DS | VT56DD32M8PC-5 | • • |
| 256MB | Pmi | MD44256VIT3208GMHA01 | MOSEL | SS | V58C2256804SAT5B | • • • |
| 512MB | Pmi | MD44512VIT3208GATA03 | MOSEL | DS | V58C2256804SAT5B | • • • |

Side(s): SS - Single Sided DS - Double Sided

DIMM Support:

- A** - supports one module inserted into either slot, in a Single-channel memory configuration.
- B** - supports on pair of modules inserted into either the yellow slots or the black slots as one pair of Dual-channel memory configuration.
- C** - support for 4 modules inserted into the yellow and black slots as two pairs of Dual-channel memory configuration.



Visit the ASUS website (www.asus.com) for the latest Qualified Vendors List.

2.4.3 Installing a DIMM



Make sure to unplug the power supply before adding or removing DIMMs or other system components. Failure to do so may cause severe damage to both the motherboard and the components.

1. Unlock a DIMM socket by pressing the retaining clips outward.
2. Align a DIMM on the socket such that the notch on the DIMM matches the break on the socket.

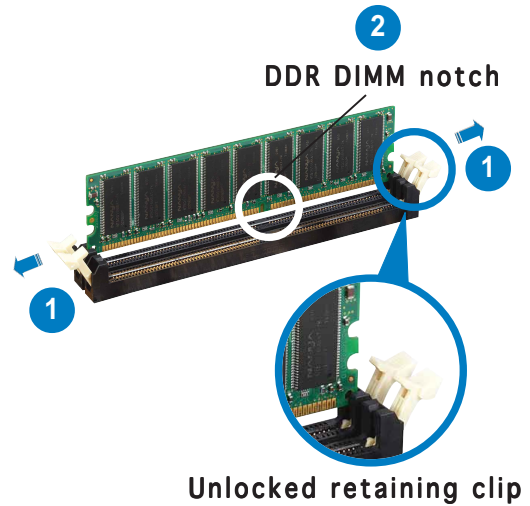

A DDR DIMM is keyed with a notch so that it fits in only one direction. DO NOT force a DIMM into a socket to avoid damaging the DIMM.

3. Firmly insert the DIMM into the socket until the retaining clips snap back in place and the DIMM is properly seated.

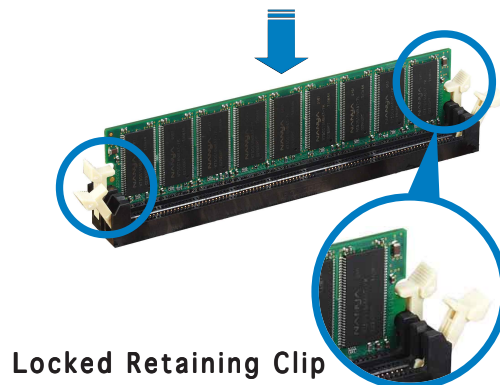

2.4.4 Removing a DIMM

Follow these steps to remove a DIMM.

1. Simultaneously press the retaining clips outward to unlock the DIMM.

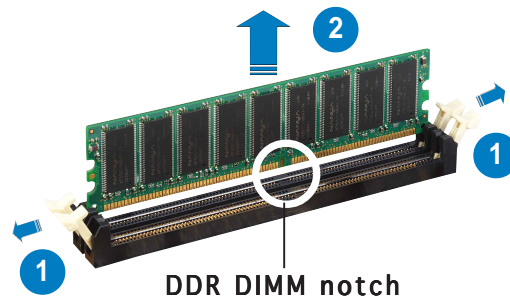

Support the DIMM lightly with your fingers when pressing the retaining clips. The DIMM might get damaged when it flips out with extra force.

2. Remove the DIMM from the socket.

2.5 Expansion slots

In the future, you may need to install expansion cards. The following sub-sections describe the slots and the expansion cards that they support.



Make sure to unplug the power cord before adding or removing expansion cards. Failure to do so may cause you physical injury and damage motherboard components.

2.5.1 Installing an expansion card

To install an expansion card:

1. Before installing the expansion card, read the documentation that came with it and make the necessary hardware settings for the card.
2. Remove the system unit cover (if your motherboard is already installed in a chassis).
3. Remove the bracket opposite the slot that you intend to use. Keep the screw for later use.
4. Align the card connector with the slot and press firmly until the card is completely seated on the slot.
5. Secure the card to the chassis with the screw you removed earlier.
6. Replace the system cover.

2.5.2 Configuring an expansion card

After installing the expansion card, configure it by adjusting the software settings.

1. Turn on the system and change the necessary BIOS settings, if any. See Chapter 4 for information on BIOS setup.
2. Assign an IRQ to the card. Refer to the tables on the next page.
3. Install the software drivers for the expansion card.

2.5.3 Interrupt assignments

Standard interrupt assignments

| IRQ | Priority | Standard Function |
|-----|----------|------------------------------|
| 0 | 1 | System Timer |
| 1 | 2 | Keyboard Controller |
| 2 | - | Re-direct to IRQ#9 |
| 3 | 11 | Communications Port (COM2)* |
| 4 | 12 | Communications Port (COM1)* |
| 5 | 13 | IRQ holder for PCI steering* |
| 6 | 14 | Floppy Disk Controller |
| 7 | 15 | Printer Port (LPT1)* |
| 8 | 3 | System CMOS/Real Time Clock |
| 9 | 4 | IRQ holder for PCI steering* |
| 10 | 5 | IRQ holder for PCI steering* |
| 11 | 6 | IRQ holder for PCI steering* |
| 12 | 7 | PS/2 Compatible Mouse Port* |
| 13 | 8 | Numeric Data Processor |
| 14 | 9 | Primary IDE Channel |
| 15 | 10 | Secondary IDE Channel |

* These IRQs are usually available for ISA or PCI devices.

IRQ assignments for this motherboard

| | A | B | C | D | E | F | G | H |
|----------------------------|--------|--------|--------|--------|------|------|------|--------|
| PCI slot 1 | — | — | — | — | — | — | used | — |
| PCI slot 2 | — | — | — | — | — | used | — | — |
| PCI slot 3 | — | shared | — | — | — | — | — | — |
| PCI E x1 slot 1 | shared | — | — | — | — | — | — | — |
| PCI E x1 slot 2 | — | — | shared | — | — | — | — | — |
| PCI E x1 slot 3 | — | — | — | shared | — | — | — | — |
| PCI E x16 slot | shared | — | — | — | — | — | — | — |
| Onboard USB controller 1 | — | — | — | — | — | — | — | shared |
| Onboard USB controller 2 | — | — | — | shared | — | — | — | — |
| Onboard USB controller 3 | — | — | shared | — | — | — | — | — |
| Onboard USB controller 4 | shared | — | — | — | — | — | — | — |
| Onboard USB 2.0 controller | — | — | — | — | — | — | — | shared |
| Onboard LAN | — | shared | — | — | — | — | — | — |
| Onboard audio | shared | — | — | — | — | — | — | — |
| Onboard PCI IDE RAID (ITE) | — | — | — | — | used | — | — | — |



When using PCI cards on shared slots, ensure that the drivers support “Share IRQ” or that the cards do not need IRQ assignments. Otherwise, conflicts will arise between the two PCI groups, making the system unstable and the card inoperable.

2.5.4 PCI slots

The PCI slots support cards such as a LAN card, SCSI card, USB card, and other cards that comply with PCI specifications. The figure shows a LAN card installed on a PCI slot.

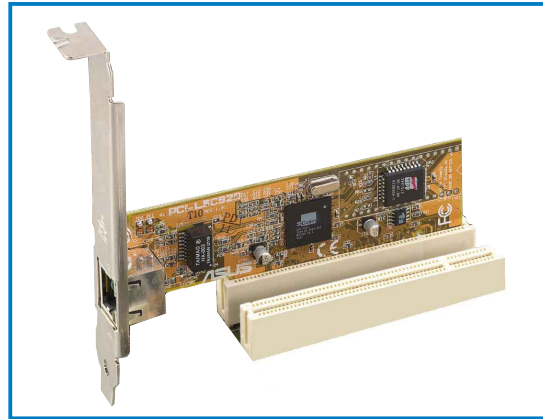

2.5.5 PCI Express x16 slot

This motherboard supports PCI Express x16 graphic cards that comply with the PCI Express specifications. The figure shows a graphics card installed on the PCI Express x16 slot.

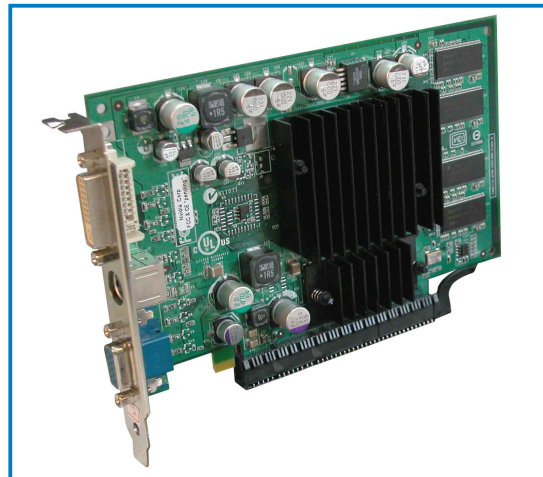

2.5.6 PCI Express x1 slot

This motherboard supports PCI Express x1 network cards, SCSI cards and other cards that comply with the PCI Express specifications. The figure shows a network card installed on the PCI Express x1 slot.

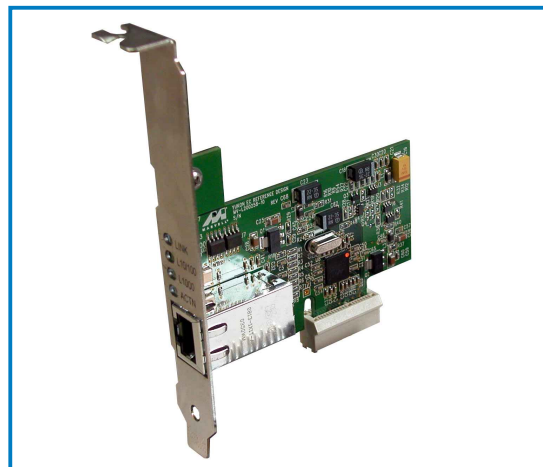

2.6 Jumpers

1. Clear RTC RAM (CLRTC)

This jumper allows you to clear the Real Time Clock (RTC) RAM in CMOS. You can clear the CMOS memory of date, time, and system setup parameters by erasing the CMOS RTC RAM data. The onboard button cell battery powers the RAM data in CMOS, which include system setup information such as system passwords.

To erase the RTC RAM:

1. Turn OFF the computer and unplug the power cord.
2. Remove the onboard battery.
3. Move the jumper cap from pins 1-2 (default) to pins 2-3. Keep the cap on pins 2-3 for about 5~10 seconds, then move the cap back to pins 1-2.
4. Re-install the battery.
5. Plug the power cord and turn ON the computer.
6. Hold down the key during the boot process and enter BIOS setup to re-enter data.



Except when clearing the RTC RAM, never remove the cap on CLRTC jumper default position. Removing the cap will cause system boot failure!

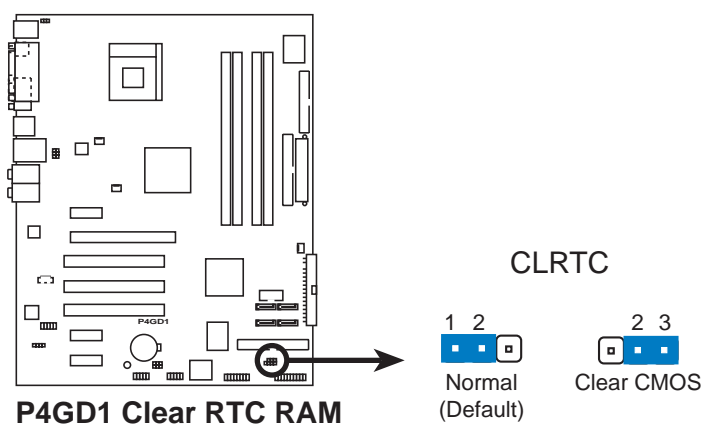

You do not need to clear the RTC when the system hangs due to overclocking. For system failure due to overclocking, use the C.P.R. (CPU Parameter Recall) feature. Shut down and reboot the system so the BIOS can automatically reset parameter settings to default values.

2. USB device wake-up (3-pin USBPW12, USBPW34, USBPW56, USBPW78)

Set these jumpers to +5V to wake up the computer from S1 sleep mode (CPU stopped, DRAM refreshed, system running in low power mode) using the connected USB devices. Set to +5VSB to wake up from S3 and S4 sleep modes (no power to CPU, DRAM in slow refresh, power supply in reduced power mode).

The USBPW12 and USBPW34 jumpers are for the rear USB ports. The USBPW56 and USBPW78 jumper is for the internal USB connectors that you can connect to additional USB ports.

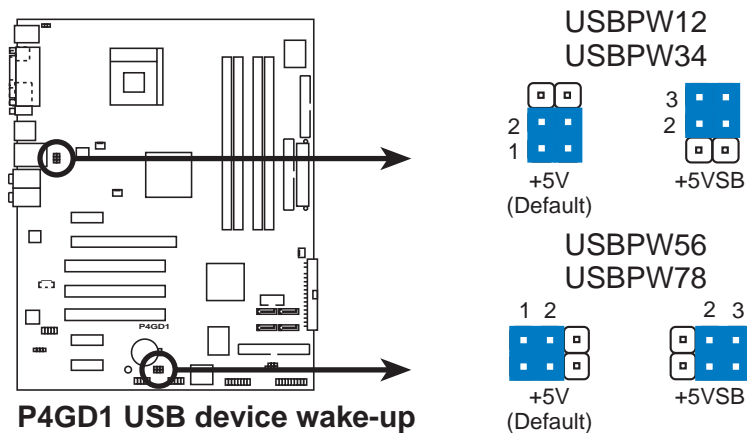

- The USB device wake-up feature requires a power supply that can provide 500mA on the +5VSB lead for each USB port; otherwise, the system would not power up.
- The total current consumed must NOT exceed the power supply capability (+5VSB) whether under normal condition or in sleep mode.

3. Keyboard power (3-pin KBPWR)

This jumper allows you to enable or disable the keyboard wake-up feature. Set this jumper to pins 2-3 (+5VSB) to wake up the computer when you press a key on the keyboard (the default is the Space Bar). This feature requires an ATX power supply that can supply at least 1A on the +5VSB lead, and a corresponding setting in the BIOS.

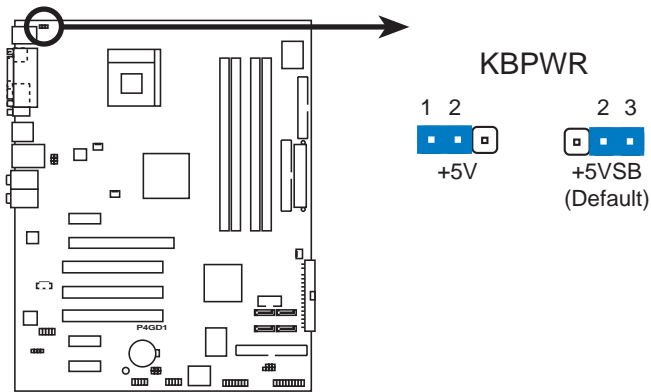

P4GD1 Keyboard power setting

2.7 Connectors

2.7.1 Rear panel connectors

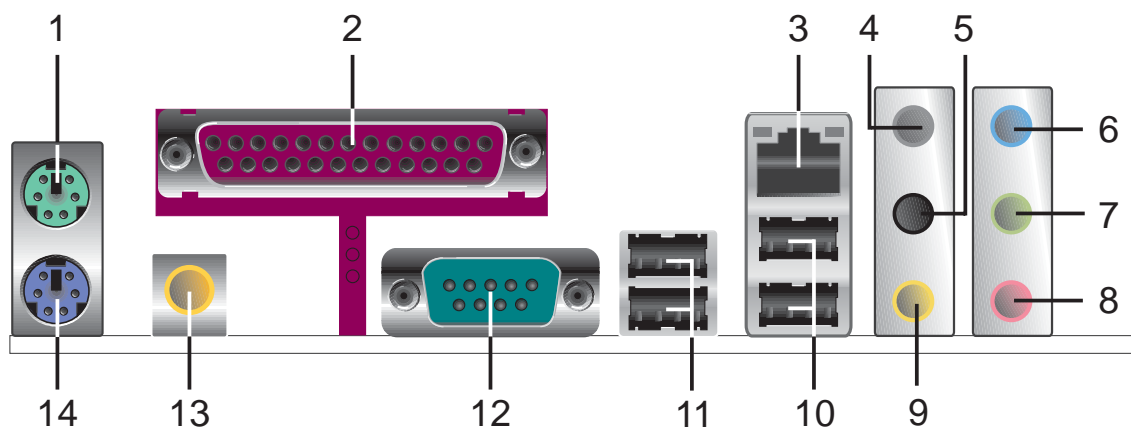

1. **PS/2 mouse port (green).** This port is for a PS/2 mouse.
2. **Parallel port.** This 25-pin port connects a parallel printer, a scanner, or other devices.
3. **LAN (RJ-45) port.** This port allows Gigabit connection to a Local Area Network (LAN) through a network hub. Refer to the table below for the LAN port LED indications.

LAN port LED indications

| ACT/LINK LED | | SPEED LED | |
|--------------|---------------|-----------|---------------------|
| Status | Description | Status | Description |
| OFF | No link | OFF | 10 Mbps connection |
| GREEN | Linked | ORANGE | 100 Mbps connection |
| BLINKING | Data activity | GREEN | 1 Gbps connection |

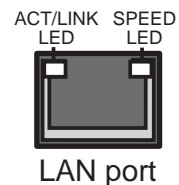

4. **Rear Speaker Out port (gray).** This port connects the rear speakers on a 4-channel, 6-channel, or 8-channel audio configuration.
5. **Side Speaker Out port (black).** This port connects the side speakers in an 8-channel audio configuration.
6. **Line In port (light blue).** This port connects a tape, CD, DVD player, or other audio sources.
7. **Line Out port (lime).** This port connects a headphone or a speaker. In 4-channel, 6-channel, and 8-channel configuration, the function of this port becomes Front Speaker Out.
8. **Microphone port (pink).** This port connects a microphone.
9. **Center/Subwoofer port (yellow orange).** This port connects the center/subwoofer speakers.



Refer to the audio configuration table for the function of the audio ports in 2, 4, 6, or 8-channel configuration.

Audio 2, 4, 6, or 8-channel configuration

| Port | Headset 2-channel | 4-channel | 6-channel | 8-channel |
|---------------|----------------------|-------------------|-------------------|-------------------|
| Light Blue | Line In | Line In | Line In | Line In |
| Lime | Line Out | Front Speaker Out | Front Speaker Out | Front Speaker Out |
| Pink | Mic In | Mic In | Mic In | Mic In |
| Gray | • | Rear Speaker Out | Rear Speaker Out | Rear Speaker Out |
| Black | • | • | • | Side Speaker Out |
| Yellow Orange | • | • | Center/Subwoofer | Center/Subwoofer |

- 10. USB 2.0 ports 3 and 4.** These two 4-pin Universal Serial Bus (USB) ports are available for connecting USB 2.0 devices.
- 11. USB 2.0 ports 1 and 2.** These two 4-pin Universal Serial Bus (USB) ports are available for connecting USB 2.0 devices.
- 12. Serial connector.** This 9-pin COM1 port is for serial devices.
- 13. S/PDIF Out port.** This port connects an external audio output device via a coaxial S/PDIF cable.
- 14. PS/2 keyboard port (purple).** This port is for a PS/2 keyboard.

2.7.2 Internal connectors

1. Floppy disk drive connector (34-1 pin FLOPPY)

This connector is for the provided floppy disk drive (FDD) signal cable. Insert one end of the cable to this connector, then connect the other end to the signal connector at the back of the floppy disk drive.



Pin 5 on the connector is removed to prevent incorrect cable connection when using an FDD cable with a covered Pin 5.

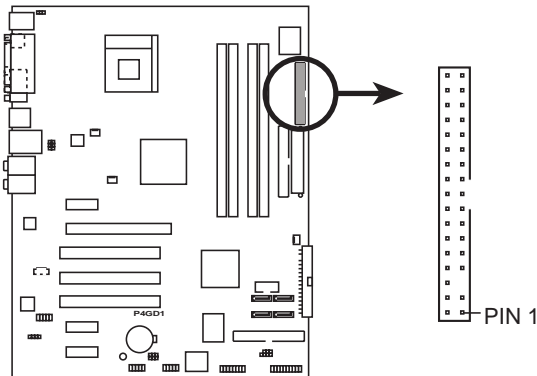

FLOPPY

NOTE: Orient the red markings on the floppy ribbon cable to PIN 1.

P4GD1 Floppy disk drive connector

2. Primary IDE connector (40-1 pin PRI_IDE)

This connector is for an Ultra DMA 100/66 signal cable. The Ultra DMA 100/66 signal cable has three connectors: a blue connector for the primary IDE connector on the motherboard, a black connector for an Ultra DMA 100/66 IDE slave device (optical drive/hard disk drive), and a gray connector for an Ultra DMA 100/66 IDE master device (hard disk drive). If you install two hard disk drives, you must configure the second drive as a slave device by setting its jumper accordingly. Refer to the hard disk documentation for the jumper settings.



- Pin 20 on the IDE connector is removed to match the covered hole on the Ultra DMA cable connector. This prevents incorrect insertion when you connect the IDE cable.
- Use the 80-conductor IDE cable for Ultra DMA 100/66 IDE devices.

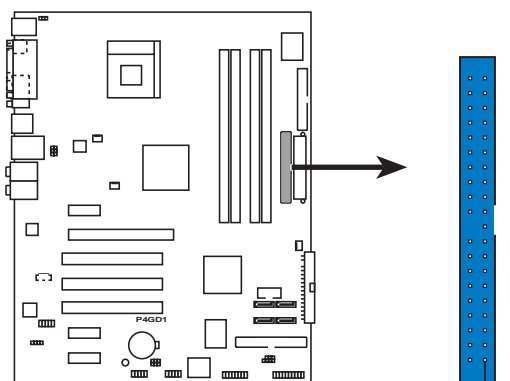

PRI_IDE

NOTE: Orient the red markings (usually zigzag) on the IDE ribbon cable to PIN 1.

P4GD1 IDE connector

PIN 1

3. IDE RAID connectors (40-1 pin PRI_RAID [blue], SEC_RAID [black])

These connectors are for Ultra ATA 133/100/66 signal cables. These connectors support up to four IDE hard disk drives that can be configured as a disk array through the onboard IDE RAID controller. Refer to Chapter 5 for details on how to set up RAID configurations.



These connectors are set to IDE mode by default. In IDE mode, you can connect IDE devices to these connectors such as boot/data hard disk drives or optical drives. If you intend to create an IDE RAID set using these connectors, set the **ITE8212F Controller** item in the BIOS to RAID Mode. See section “4.4.6 Onboard Devices Configuration” for details.

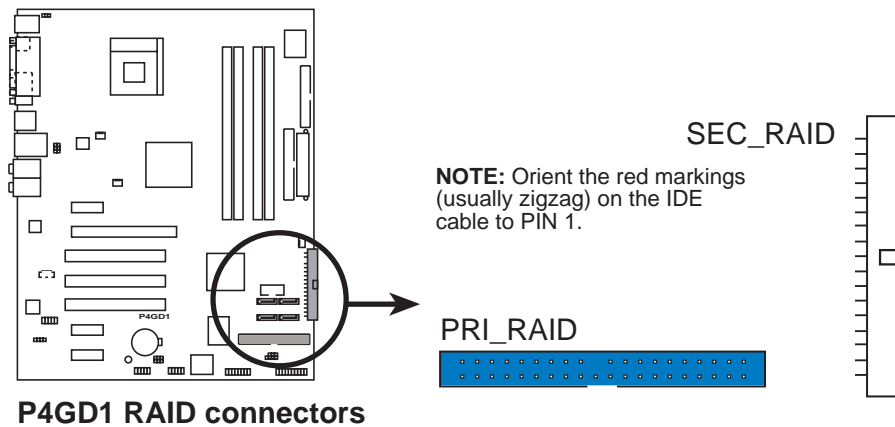

- Before creating a RAID set using Ultra ATA hard disks, make sure that you have connected the Ultra ATA signal cable and installed Ultra ATA 133/100/66 hard disk drives.
- The system automatically assigns the boot sequence of ATAPI devices connected to the IDE RAID connectors.
- The ITE® 8212F controller supports a maximum of 2 Ultra ATA hard disk drives.
- Set both drives either as Master or Slave before configuring a RAID 1 set.

4. Serial ATA connectors (7-pin SATA1, SATA2, SATA3, SATA4)

These connectors are for the Serial ATA signal cables for Serial ATA hard disk drives. The current Serial ATA interface allows up to 150 MB/s data transfer rate, faster than the standard parallel ATA with 133 MB/s (UltraDMA 133)

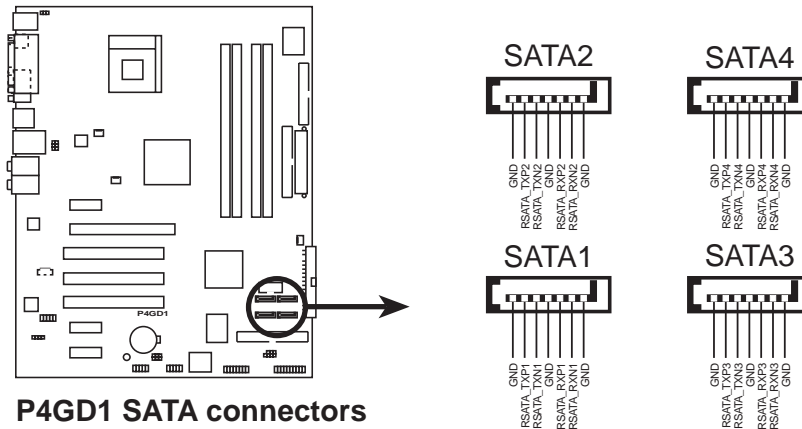

P4GD1 SATA connectors



Important notes on Serial ATA

- Install the Windows® 2000 Service Pack 4 or the Windows® XP Service Pack1 before using Serial ATA.
- Plug your Serial ATA boot disk on the master port (SATA1 and SATA2) to support S3 function. Refer to the table below for details.

Serial ATA Master/Slave connectors

| Connector | Setting | Use |
|--------------|---------|-----------|
| SATA1, SATA2 | Master | Boot disk |
| SATA3, SATA4 | Slave | Data disk |

5. CPU, Chassis, and Power fan connectors (3-pin CPU_FAN, 3-pin PWR_FAN, 3-pin CHA_FAN)

The fan connectors support cooling fans of 350mA~740mA (8.88W max.) or a total of 1A~2.22A (26.64W max.) at +12V. Connect the fan cables to the fan connectors on the motherboard, making sure that the black wire of each cable matches the ground pin of the connector.



Do not forget to connect the fan cables to the fan connectors. Insufficient air flow inside the system may damage the motherboard components. These are not jumpers! DO NOT place jumper caps on the fan connectors.

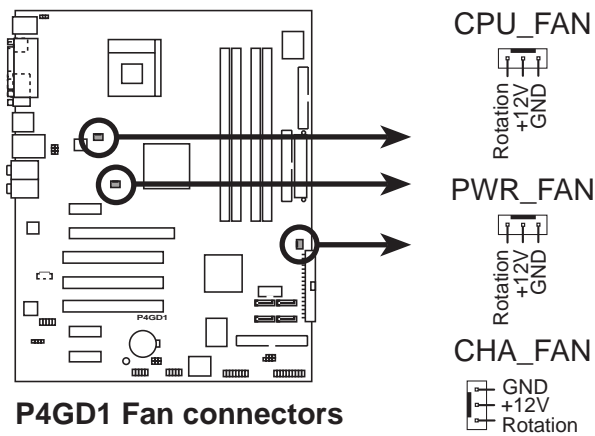

6. Serial port connector (10-1 pin COM2)

This connector is for a serial (COM) port. Connect the serial port module cable to this connector, then install the module to a slot opening at the back of the system chassis.

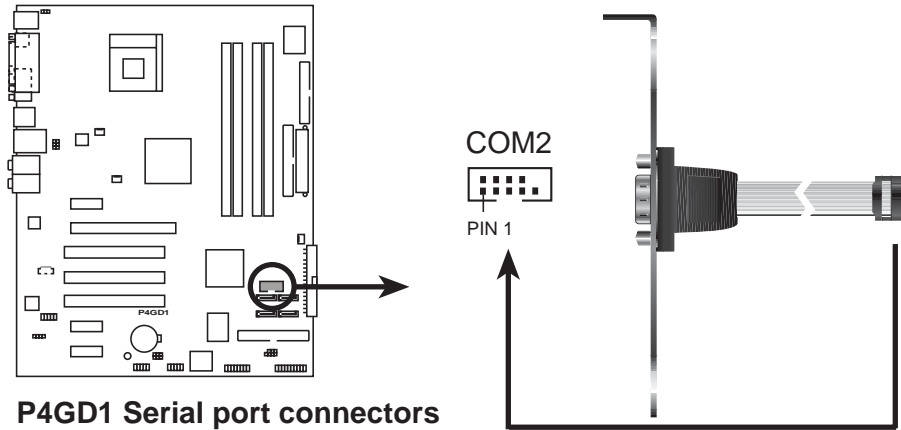

P4GD1 Serial port connectors



The Serial connector (COM2) module is purchased separately.

7. USB connectors (10-1 pin USB56, USB78)

These connectors are for USB 2.0 ports. Connect the USB/GAME module cable to any of these connectors, then install the module to a slot opening at the back of the system chassis. These USB connectors comply with USB 2.0 specification that supports up to 480 Mbps connection speed.

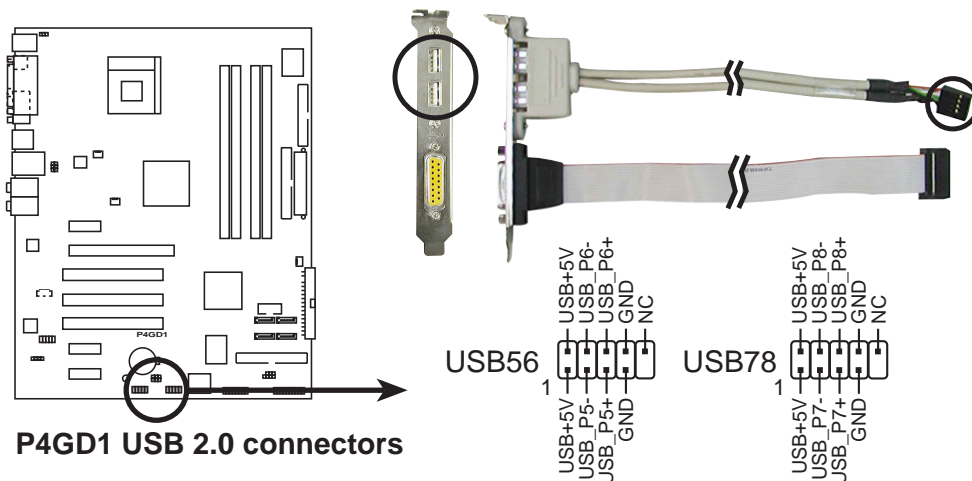

P4GD1 USB 2.0 connectors



Never connect a 1394 cable to the USB connectors. Doing so will damage the motherboard!

8. ATX power connectors (24-pin EATXPWR, 4-pin ATX12V)

These connectors are for an ATX power supply. The plugs from the power supply are designed to fit these connectors in only one orientation. Find the proper orientation and push down firmly until the connectors completely fit.



- It is recommended that you use an ATX 12 V Specification 2.0-compliant power supply unit (PSU) with a minimum of 300 W power rating. This PSU type has 24-pin and 4-pin power plugs.
- If you intend to use a PSU with 20-pin and 4-pin power plugs, make sure that the 20-pin power plug can provide at least 15A on +12V and that the PSU has a minimum power rating of 300 W. The system may become unstable or may not boot up if the power is inadequate.
- Do not forget to connect the 4-pin ATX +12 V power plug; otherwise, the system will not boot up.
- Use of a PSU with a higher power output is recommended when configuring a system with more power-consuming devices. The system may become unstable or may not boot up if the power is inadequate.
- The ATX 12 V Specification 2.0-compliant PSU passed the motherboard power requirement test with the following configuration:
 - CPU : Intel® Pentium® 4 3.4 GHz
 - Memory : 512 MB DDR (x 4)
 - Graphics card : PCI Express x16 Nvidia EN5900
 - Parallel ATA devices: IDE hard disk drive (x 2)
 - Serial ATA device : SATA hard disk drive
 - Optical drives : CD-ROM (x 2)
 - SCSI devices : SCSI card and SCSI hard disk drive
- You must install a PSU with a higher power rating if you intend to install additional devices.

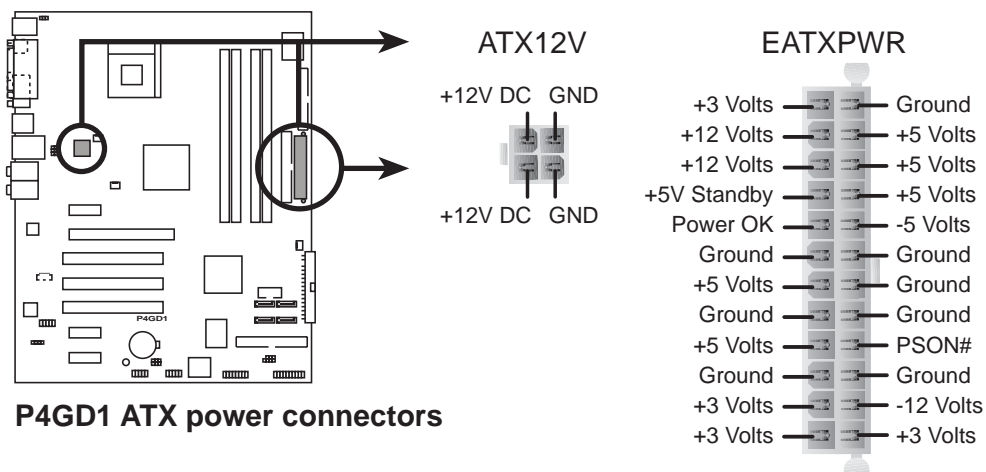

9. Optical drive audio connector (4-pin CD)

This connector is for the 4-pin audio cable that connects to the audio connector at the back of the optical drive.

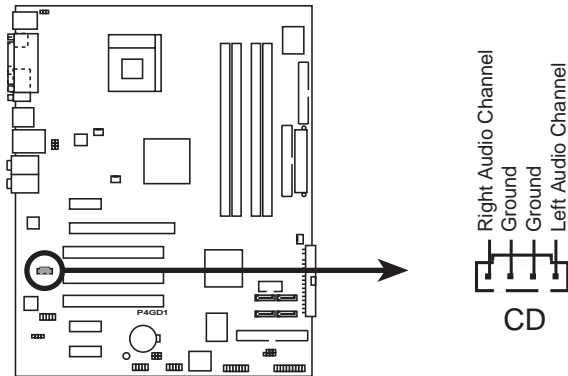

P4GD1 CD audio connector

10. GAME/MIDI port connector (16-1 pin GAME)

This connector is for a GAME/MIDI port. Connect the USB/GAME module cable to this connector, then install the module to a slot opening at the back of the system chassis. The GAME/MIDI port connects a joystick or game pad for playing games, and MIDI devices for playing or editing audio files.

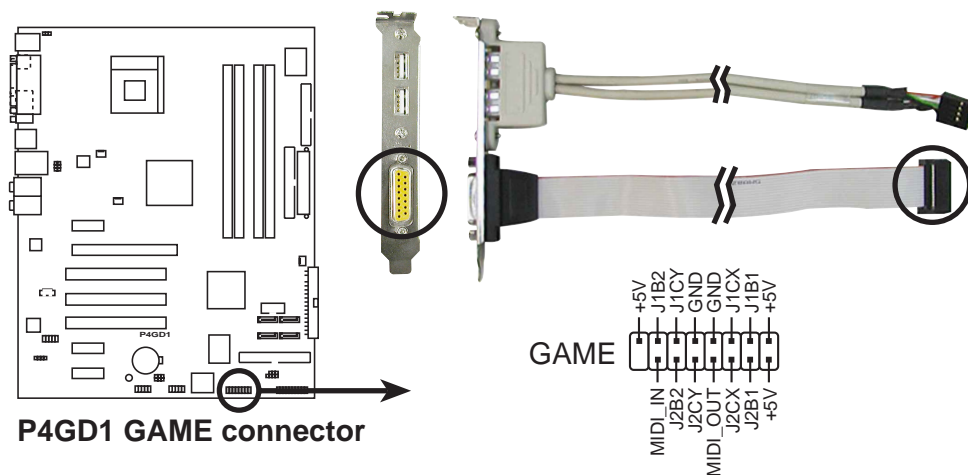

P4GD1 GAME connector

11. Chassis intrusion connector (4-1 pin CHASSIS)

This connector is for a chassis-mounted intrusion detection sensor or switch. Connect one end of the chassis intrusion sensor or switch cable to this connector. The chassis intrusion sensor or switch sends a high-level signal to this connector when a chassis component is removed or replaced. The signal is then generated as a chassis intrusion event.

By default, the pins labeled “Chassis Signal” and “Ground” are shorted with a jumper cap. Remove the jumper caps only when you intend to use the chassis intrusion detection feature.

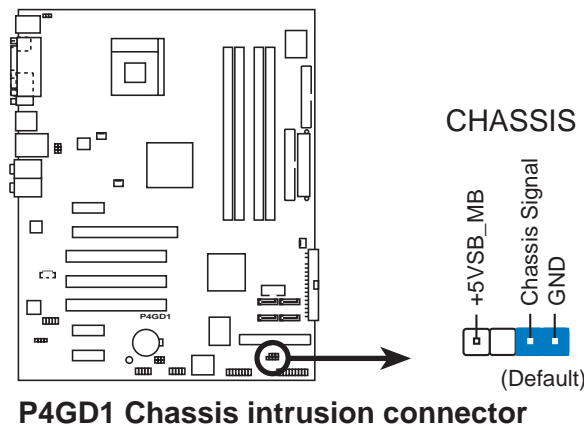

12. Front panel audio connector (10-1 pin AAFP)

This connector is for a chassis-mounted front panel audio I/O module that supports either HD Audio or legacy AC '97 audio standard. Connect one end of the front panel audio I/O module cable to this connector.

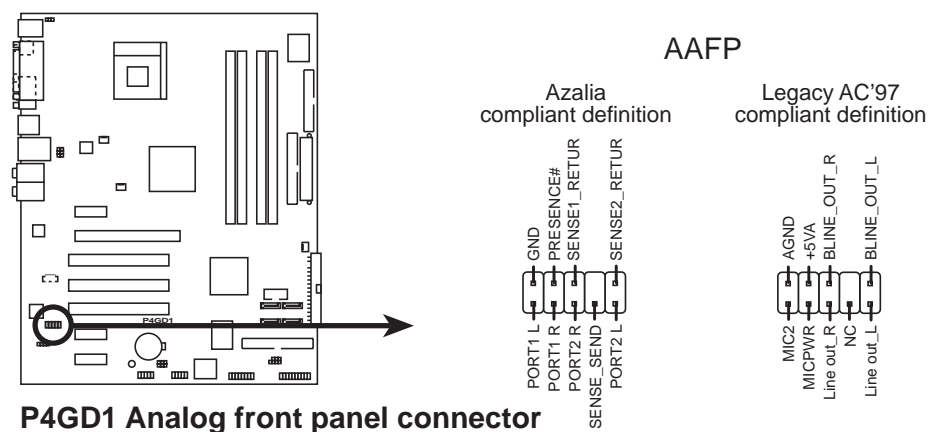

Connect a high-definition front panel audio module to this connector to avail the high-definition audio features of the motherboard.

13. System panel connector (20-1 pin PANEL)

This connector supports several chassis-mounted functions.

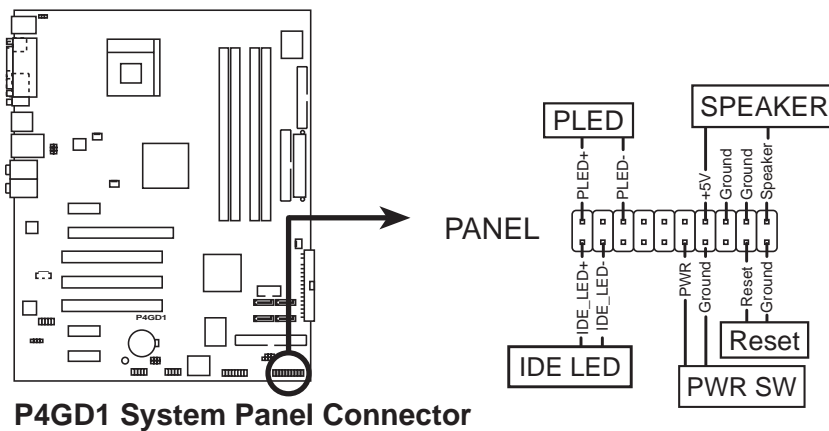

P4GD1 System Panel Connector



The system panel connector is color-coded for easy connection. Refer to the connector description below for details.

- **System power LED (Green 3-pin PLED)**
This 3-pin connector is for the system power LED. Connect the chassis power LED cable to this connector. The system power LED lights up when you turn on the system power, and blinks when the system is in sleep mode.
- **Hard disk drive activity (Red 2-pin IDE_LED)**
This 2-pin connector is for the HDD Activity LED. Connect the HDD Activity LED cable to this connector. The IDE LED lights up or flashes when data is read from or written to the HDD.
- **System warning speaker (Orange 4-pin SPEAKER)**
This 4-pin connector is for the chassis-mounted system warning speaker. The speaker allows you to hear system beeps and warnings.
- **Power/Soft-off button (Yellow 2-pin PWR SW)**
This connector is for the system power button. Pressing the power button turns the system ON or puts the system in SLEEP or SOFT-OFF mode depending on the BIOS settings. Pressing the power switch for more than four seconds while the system is ON turns the system OFF.
- **Reset button (Blue 2-pin RESET)**
This 2-pin connector is for the chassis-mounted reset button for system reboot without turning off the system power.

This chapter describes the power up sequence, the vocal POST messages, and ways of shutting down the system.

Powering up

Chapter summary

| | | |
|-----|--------------------------------------|-----|
| 3.1 | Starting up for the first time | 3-1 |
| 3.2 | Powering off the computer | 3-2 |

3.1 Starting up for the first time

1. After making all the connections, replace the system case cover.
2. Be sure that all switches are off.
3. Connect the power cord to the power connector at the back of the system chassis.
4. Connect the power cord to a power outlet that is equipped with a surge protector.
5. Turn on the devices in the following order:
 - a. Monitor
 - b. External SCSI devices (starting with the last device on the chain)
 - c. System power
6. After applying power, the system power LED on the system front panel case lights up. For systems with ATX power supplies, the system LED lights up when you press the ATX power button. If your monitor complies with “green” standards or if it has a “power standby” feature, the monitor LED may light up or switch between orange and green after the system LED turns on.

The system then runs the power-on self tests or POST. While the tests are running, the BIOS beeps (see BIOS beep codes table below) or additional messages appear on the screen. If you do not see anything within 30 seconds from the time you turned on the power, the system may have failed a power-on test. Check the jumper settings and connections or call your retailer for assistance.

AMI BIOS beep codes

| Beep Description | Error |
|---|---|
| One beep | Keyboard controller error Refresh Time error No master drive detected |
| Two continuous beeps followed by two short beeps | Floppy controller failure |
| Two continuous beeps followed by four short beeps | Hardware component failure |

7. At power on, hold down the <Delete> key to enter the BIOS Setup. Follow the instructions in Chapter 4.

3.2 Powering off the computer

3.2.1 Using the OS shut down function

If you are using Windows® 2000:

1. Click the **Start** button then click **Shut Down...**
2. Make sure that the **Shut Down** option button is selected, then click the **OK** button to shut down the computer.
3. The power supply should turn off after Windows® shuts down.

If you are using Windows® XP:

1. Click the **Start** button then select **Turn Off Computer.**
2. Click the **Turn Off** button to shut down the computer.
3. The power supply should turn off after Windows® shuts down.

3.2.2 Using the dual function power switch

While the system is ON, pressing the power switch for less than four seconds puts the system to sleep mode or to soft-off mode, depending on the BIOS setting. Pressing the power switch for more than four seconds lets the system enter the soft-off mode regardless of the BIOS setting. Refer to section “4.5 Power Menu” in Chapter 4 for details.

This chapter tells how to change the system settings through the BIOS Setup menus. Detailed descriptions of the BIOS parameters are also provided.

BIOS setup

Chapter summary

| | | |
|-----|---------------------------------------|------|
| 4.1 | Managing and updating your BIOS | 4-1 |
| 4.2 | BIOS setup program | 4-10 |
| 4.3 | Main menu | 4-13 |
| 4.4 | Advanced menu | 4-17 |
| 4.5 | Power menu | 4-28 |
| 4.6 | Boot menu | 4-33 |
| 4.7 | Exit menu | 4-37 |

4.1 Managing and updating your BIOS

The following utilities allow you to manage and update the motherboard Basic Input/Output System (BIOS) setup.

1. **ASUS AFUDOS** (Updates the BIOS in DOS mode using a bootable floppy disk.)
2. **ASUS EZ Flash** (Updates the BIOS using a floppy disk during POST.)
3. **ASUS CrashFree BIOS 2** (Updates the BIOS using a bootable floppy disk or the motherboard support CD when the BIOS file fails or gets corrupted.)
4. **ASUS Update** (Updates the BIOS in Windows® environment.)

Refer to the corresponding sections for details on these utilities.



Save a copy of the original motherboard BIOS file to a bootable floppy disk in case you need to restore the BIOS in the future. Copy the original motherboard BIOS using the ASUS Update or AFUDOS utilities.

4.1.1 Creating a bootable floppy disk

1. Do either one of the following to create a bootable floppy disk.

DOS environment

- a. Insert a 1.44MB floppy disk into the drive.
- b. At the DOS prompt, type `format a:/s` then press <Enter>.

Windows® XP environment

- a. Insert a 1.44 MB floppy disk to the floppy disk drive.
- b. Click **Start** from the Windows® desktop, then select **My Computer**.
- c. Select the 3 1/2 Floppy Drive icon.
- d. Click **File** from the menu, then select **Format**. A **Format 3 1/2 Floppy Disk** window appears.
- e. Select **Create an MS-DOS startup disk** from the format options field, then click **Start**.

Windows® 2000 environment

To create a set of boot disks for Windows® 2000:

- a. Insert a formatted, high density 1.44 MB floppy disk into the drive.
- b. Insert the Windows® 2000 CD to the optical drive.
- c. Click **Start**, then select **Run**.

- d. From the Open field, type
`D:\bootdisk\makeboot a:`
assuming that D: is your optical drive.
 - e. Press <Enter>, then follow screen instructions to continue.
2. Copy the original or the latest motherboard BIOS file to the bootable floppy disk.

4.1.2 ASUS EZ Flash utility

The ASUS EZ Flash feature allows you to update the BIOS without having to go through the long process of booting from a floppy disk and using a DOS-based utility. The EZ Flash utility is built-in the BIOS chip so it is accessible by pressing <Alt> + <F2> during the Power-On Self Tests (POST).

To update the BIOS using EZ Flash:

1. Visit the ASUS website (www.asus.com) to download the latest BIOS file for the motherboard and rename the same to **P4GD1.ROM**.
2. Save the BIOS file to a floppy disk, then restart the system.
3. Press <Alt> + <F2> during POST to display the following.

```
EZFlash starting BIOS update
Checking for floppy...
```

4. Insert the floppy disk that contains the BIOS file to the floppy disk drive. When the correct BIOS file is found, EZ Flash performs the BIOS update process and automatically reboots the system when done.

```
EZFlash starting BIOS update
Checking for floppy...
Floppy found!
Reading file "P4GD1.ROM". Completed.
Start erasing.....|
Start programming...|
Flashed successfully. Rebooting.
```



- Do not shutdown or reset the system while updating the BIOS to prevent system boot failure!
- A "Floppy not found!" error message appears if there is no floppy disk in the drive. A "P4GD1.ROM not found!" error message appears if the correct BIOS file is not found in the floppy disk. Make sure that you rename the BIOS file to P4GD1.ROM.

4.1.3 AFUDOS utility

The AFUDOS utility allows you to update the BIOS file in DOS environment using a bootable floppy disk with the updated BIOS file. This utility also allows you to copy the current BIOS file that you can use as backup when the BIOS fails or gets corrupted during the updating process.

Copying the current BIOS

To copy the current BIOS file using the AFUDOS utility:



- Make sure that the floppy disk is not write-protected and has at least 600 KB free space to save the file.
- The succeeding BIOS screens are for reference only. The actual BIOS screen displays may not be exactly the same as shown.

1. Copy the AFUDOS utility (afudos.exe) from the motherboard support CD to the bootable floppy disk you created earlier.
2. Boot the system in DOS mode, then at the prompt type:

```
afudos /o[filename]
```

where the [filename] is any user-assigned filename not more than eight alphanumeric characters for the main filename and three alphanumeric characters for the extension name.

```
A:\>afudos /oOLDBIOS1.ROM
```

Main filename Extension name

3. Press <Enter>. The utility copies the current BIOS file to the floppy disk.

```
A:\>afudos /oOLDBIOS1.ROM
AMI Firmware Update Utility - Version 1.10
Copyright (C) 2002 American Megatrends, Inc. All rights reserved.
  Reading flash ..... done
A:\>
```

The utility returns to the DOS prompt after copying the current BIOS file.

Updating the BIOS file

To update the BIOS file using the AFUDOS utility:

1. Visit the ASUS website (www.asus.com) and download the latest BIOS file for the motherboard. Save the BIOS file to a bootable floppy disk.



Write the BIOS filename on a piece of paper. You need to type the exact BIOS filename at the DOS prompt.

2. Copy the AFUDOS utility (afudos.exe) from the motherboard support CD to the bootable floppy disk you created earlier.
3. Boot the system in DOS mode, then at the prompt type:

```
afudos /i[filename]
```

where [filename] is the latest or the original BIOS file on the bootable floppy disk.

```
A:\>afudos /iP4GD1.ROM
```

4. The utility verifies the file and starts updating the BIOS.

```
A:\>afudos /iP4GD1.ROM
AMI Firmware Update Utility - Version 1.10
Copyright (C) 2002 American Megatrends, Inc. All rights reserved.
Reading file ..... done
Erasing flash .... done
Writing flash .... 0x0008CC00 (9%)
```



Do not shut down or reset the system while updating the BIOS to prevent system boot failure!

5. The utility returns to the DOS prompt after the BIOS update process is completed. Reboot the system from the hard disk drive.

```
A:\>afudos /iP4GD1.ROM
AMI Firmware Update Utility - Version 1.10
Copyright (C) 2002 American Megatrends, Inc. All rights reserved.
Reading file ..... done
Erasing flash .... done
Writing flash .... 0x0008CC00 (9%)
Verifying flash .. done
A:\>
```

4.1.4 ASUS CrashFree BIOS 2 utility

The ASUS CrashFree BIOS 2 is an auto recovery tool that allows you to restore the BIOS file when it fails or gets corrupted during the updating process. You can update a corrupted BIOS file using the motherboard support CD or the floppy disk that contains the updated BIOS file.



- Prepare the motherboard support CD or the floppy disk containing the updated motherboard BIOS before using this utility.
- Make sure that you rename the original or updated BIOS file in the floppy disk to **P4GD1.ROM**.

Recovering the BIOS from a floppy disk

To recover the BIOS from a floppy disk:

1. Turn on the system.
2. Insert the floppy disk with the original or updated BIOS file to the floppy disk drive.
3. The utility displays the following message and automatically checks the floppy disk for the original or updated BIOS file.

```
Bad BIOS checksum. Starting BIOS recovery...
Checking for floppy...
```

When found, the utility reads the BIOS file and starts flashing the corrupted BIOS file.

```
Bad BIOS checksum. Starting BIOS recovery...
Checking for floppy...
Floppy found!
Reading file "P4GD1.ROM". Completed.
Start flashing...
```



DO NOT shut down or reset the system while updating the BIOS! Doing so can cause system boot failure!

4. Restart the system after the utility completes the updating process.

Recovering the BIOS from the support CD

To recover the BIOS from the support CD:

1. Remove any floppy disk from the floppy disk drive, then turn on the system.
2. Insert the support CD to the optical drive.
3. The utility displays the following message and automatically checks the floppy disk for the original or updated BIOS file.

```
Bad BIOS checksum. Starting BIOS recovery...  
Checking for floppy...
```

When no floppy disk is found, the utility automatically checks the optical drive for the original or updated BIOS file. The utility then updates the corrupted BIOS file.

```
Bad BIOS checksum. Starting BIOS recovery...  
Checking for floppy...  
Floppy not found!  
Checking for CD-ROM...  
CD-ROM found!  
Reading file "P4GD1.ROM". Completed.  
Start flashing...
```



DO NOT shut down or reset the system while updating the BIOS! Doing so can cause system boot failure!

4. Restart the system after the utility completes the updating process.



The recovered BIOS may not be the latest BIOS version for this motherboard. Visit the ASUS website (www.asus.com) to download the latest BIOS file.

4.1.5 ASUS Update utility

The ASUS Update is a utility that allows you to manage, save, and update the motherboard BIOS in Windows® environment. The ASUS Update utility allows you to:

- Save the current BIOS file
- Download the latest BIOS file from the Internet
- Update the BIOS from an updated BIOS file
- Update the BIOS directly from the Internet, and
- View the BIOS version information.

This utility is available in the support CD that comes with the motherboard package.



ASUS Update requires an Internet connection either through a network or an Internet Service Provider (ISP).

Installing ASUS Update

To install ASUS Update:

1. Place the support CD in the optical drive. The **Drivers** menu appears.
2. Click the **Utilities** tab, then click **Install ASUS Update VX.XX.XX**. See page 5-3 for the **Utilities** screen menu.
3. The ASUS Update utility is copied to your system.



Quit all Windows® applications before you update the BIOS using this utility.

Updating the BIOS through the Internet

To update the BIOS through the Internet:

1. Launch the ASUS Update utility from the Windows® desktop by clicking **Start > Programs > ASUS > ASUSUpdate > ASUSUpdate**. The ASUS Update main window appears.

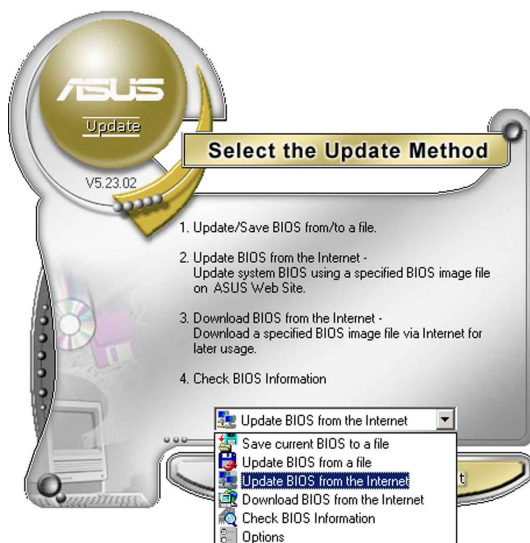
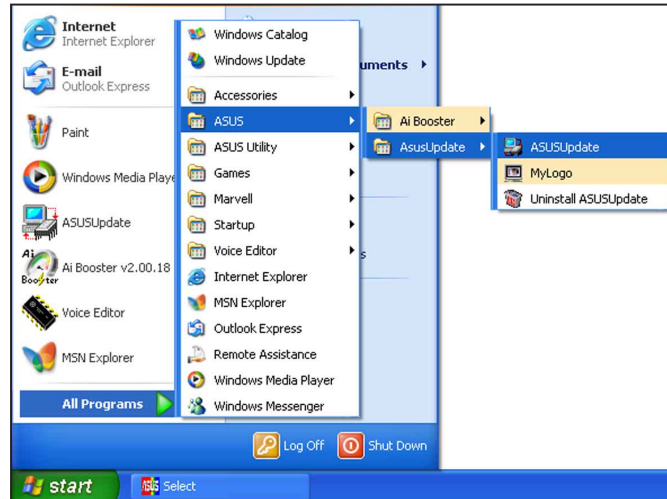

2. Select **Update BIOS from the Internet** option from the drop-down menu, then click **Next**.



3. Select the ASUS FTP site nearest you to avoid network traffic, or click **Auto Select**. Click **Next**.

- From the FTP site, select the BIOS version that you wish to download. Click Next.
- Follow the screen instructions to complete the update process.



The ASUS Update utility is capable of updating itself through the Internet. Always update the utility to avail all its features.

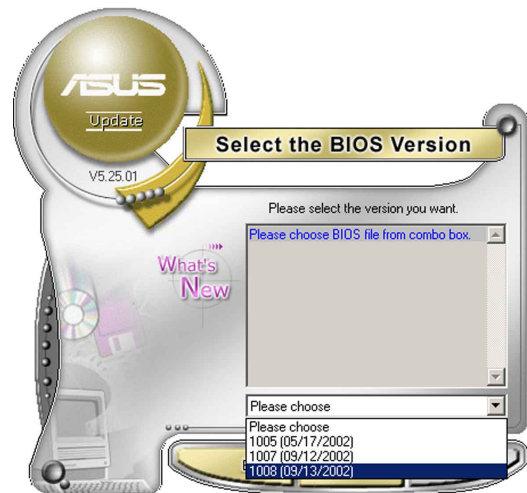

Updating the BIOS through a BIOS file

To update the BIOS through a BIOS file:

- Launch the ASUS Update utility from the Windows® desktop by clicking **Start > Programs > ASUS > ASUSUpdate > ASUSUpdate**. The ASUS Update main window appears.
- Select **Update BIOS from a file** option from the drop-down menu, then click **Next**.

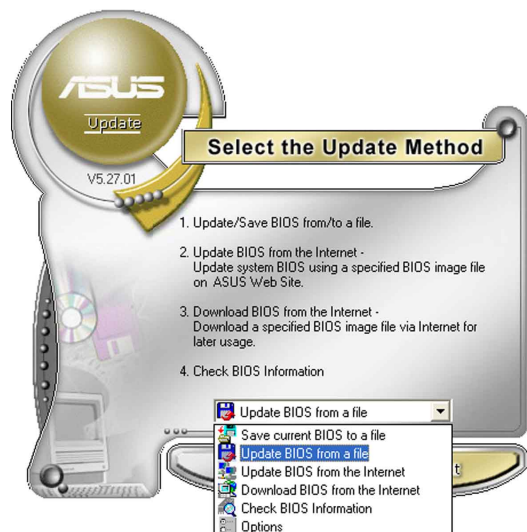

- Locate the BIOS file from the **Open** window, then click **Save**.
- Follow the screen instructions to complete the update process.

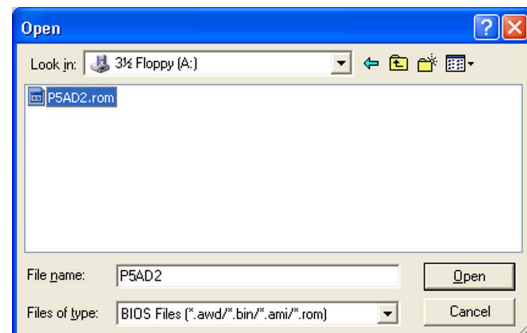

4.2 BIOS setup program

This motherboard supports a programmable firmware chip that you can update using the provided utility described in section “4.1 Managing and updating your BIOS.”

Use the BIOS Setup program when you are installing a motherboard, reconfiguring your system, or prompted to “Run Setup”. This section explains how to configure your system using this utility.

Even if you are not prompted to use the Setup program, you can change the configuration of your computer in the future. For example, you can enable the security password feature or change the power management settings. This requires you to reconfigure your system using the BIOS Setup program so that the computer can recognize these changes and record them in the CMOS RAM of the firmware hub.

The firmware hub on the motherboard stores the Setup utility. When you start up the computer, the system provides you with the opportunity to run this program. Press during the Power-On-Self-Test (POST) to enter the Setup utility; otherwise, POST continues with its test routines.

If you wish to enter Setup after POST, restart the system by pressing <Ctrl+Alt+Delete>, or by pressing the reset button on the system chassis. You can also restart by turning the system off and then back on. Do this last option only if the first two failed.

The Setup program is designed to make it as easy to use as possible. Being a menu-driven program, it lets you scroll through the various sub-menus and make your selections from the available options using the navigation keys.



-
- The default BIOS settings for this motherboard apply for most conditions to ensure optimum performance. If the system becomes unstable after changing any BIOS settings, load the default settings to ensure system compatibility and stability. Select the **Load Default Settings** item under the Exit Menu. See section “4.7 Exit Menu.”
 - The BIOS setup screens shown in this section are for reference purposes only, and may not exactly match what you see on your screen.
 - Visit the ASUS website (www.asus.com) to download the latest BIOS file for this motherboard and .
-

4.2.1 BIOS menu screen

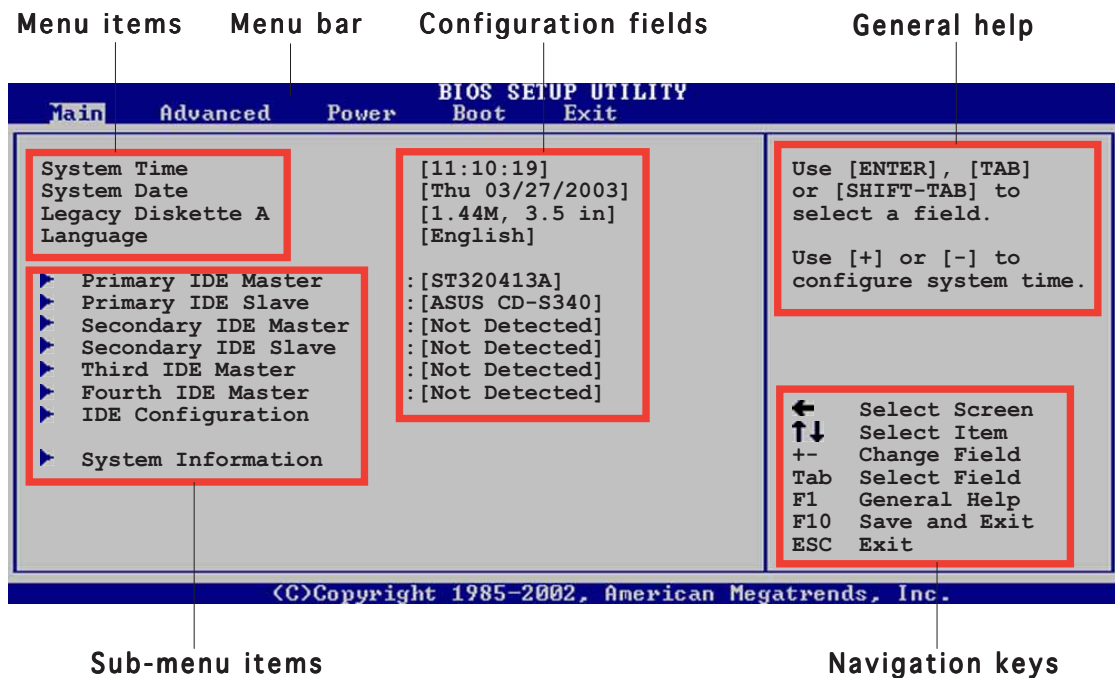

4.2.2 Menu bar

The menu bar on top of the screen has the following main items:

- Main** For changing the basic system configuration
- Advanced** For changing the advanced system settings
- Power** For changing the advanced power management (APM) configuration
- Boot** For changing the system boot configuration
- Exit** For selecting the exit options and loading default settings

To select an item on the menu bar, press the right or left arrow key on the keyboard until the desired item is highlighted.

4.2.3 Navigation keys

At the bottom right corner of a menu screen are the navigation keys for that particular menu. Use the navigation keys to select items in the menu and change the settings.



Some of the navigation keys differ from one screen to another.

4.2.4 Menu items

The highlighted item on the menu bar displays the specific items for that menu. For example, selecting **Main** shows the Main menu items.

The other items (Advanced, Power, Boot, and Exit) on the menu bar have their respective menu items.

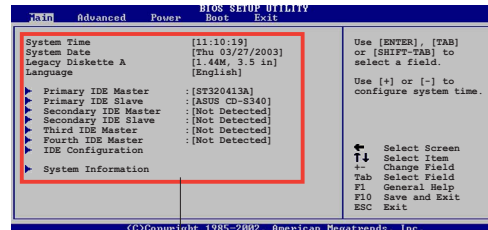

Main menu items

4.2.5 Sub-menu items

A solid triangle before each item on any menu screen means that the item has a sub-menu. To display the sub-menu, select the item and press <Enter>.

4.2.6 Configuration fields

These fields show the values for the menu items. If an item is user-configurable, you can change the value of the field opposite the item. You cannot select an item that is not user-configurable.

A configurable field is enclosed in brackets, and is highlighted when selected. To change the value of a field, select it then press <Enter> to display a list of options. Refer to “4.2.7 Pop-up window.”

4.2.7 Pop-up window

Select a menu item then press <Enter> to display a pop-up window with the configuration options for that item.

4.2.8 Scroll bar

A scroll bar appears on the right side of a menu screen when there are items that do not fit on the screen. Press the Up/Down arrow keys or <Page Up> / <Page Down> keys to display the other items on the screen.

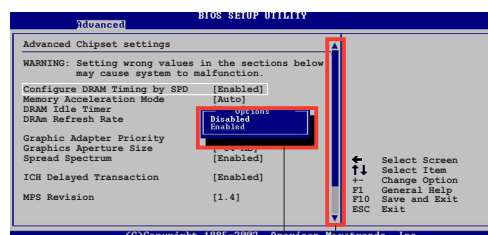

Pop-up window

Scroll bar

4.2.9 General help

At the top right corner of the menu screen is a brief description of the selected item.

4.3 Main menu

When you enter the BIOS Setup program, the Main menu screen appears, giving you an overview of the basic system information.



Refer to section “4.2.1 BIOS menu screen” for information on the menu screen items and how to navigate through them.

```
BIOS SETUP UTILITY
Main  Advanced  Power  Boot  Exit

System Time           [11:51:19]
System Date           [Thu 05/07/2004]
Legacy Diskette A     [1.44M, 3.5 in]
Language               [English]

▶ Primary IDE Master   : [ST320413A]
▶ Primary IDE Slave    : [Not Detected]
▶ Third IDE Master      : [Not Detected]
▶ Third IDE Slave       : [Not Detected]
▶ Fourth IDE Master     : [Not Detected]
▶ Fourth IDE Slave      : [Not Detected]
▶ IDE Configuration

▶ System Information

↔ Select Screen
↑↓ Select Item
+- Change Option
F1 General Help
F10 Save and Exit
ESC Exit

v00.00 (C)Copyright 1985-2002, American Megatrends, Inc.
```

4.3.1 System Time [xx:xx:xxxx]

Allows you to set the system time.

4.3.2 System Date [Day xx/xx/xxxx]

Allows you to set the system date.

4.3.3 Legacy Diskette A [1.44M, 3.5 in.]

Sets the type of floppy drive installed. Configuration options: [Disabled]
[360K, 5.25 in.] [1.2M, 5.25 in.] [720K, 3.5 in.] [1.44M, 3.5 in.]
[2.88M, 3.5 in.]

4.3.4 Language [English]

Allows you to choose the BIOS language version from the options.
Configuration options: [Français] [German] [English]

4.3.5 Primary, Third and Fourth IDE Master/Slave

While entering Setup, the BIOS automatically detects the presence of IDE devices. There is a separate sub-menu for each IDE device. Select a device item then press <Enter> to display the IDE device information.

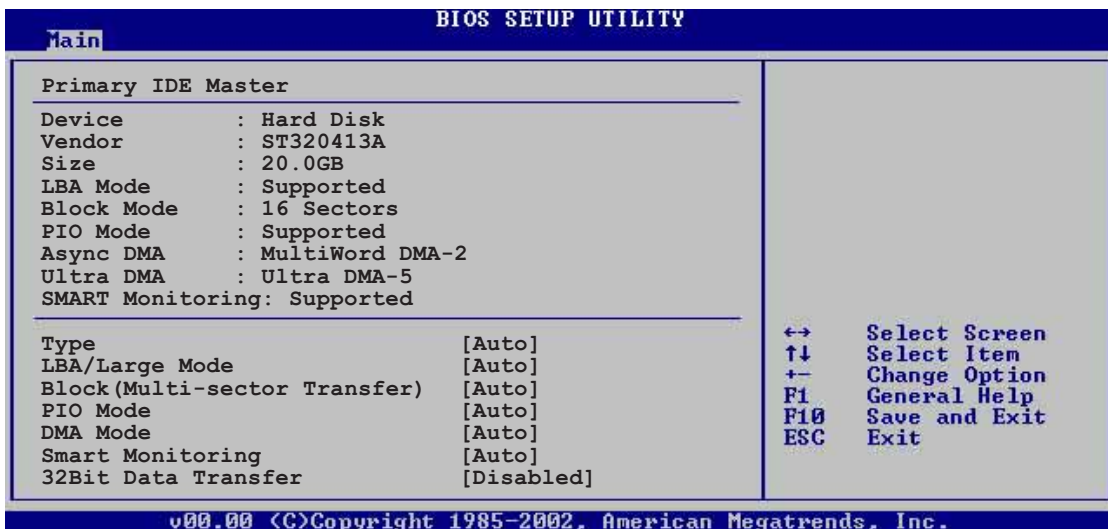

The BIOS automatically detects the values opposite the dimmed items (Device, Vendor, Size, LBA Mode, Block Mode, PIO Mode, Async DMA, Ultra DMA, and SMART monitoring). These values are not user-configurable. These items show N/A if no IDE device is installed in the system.

Type [Auto]

Selects the type of IDE drive. Setting to Auto allows automatic selection of the appropriate IDE device type. Select CDROM if you are specifically configuring a CD-ROM drive. Select ARMD (ATAPI Removable Media Device) if your device is either a ZIP, LS-120, or MO drive.

Configuration options: [Not Installed] [Auto] [CDROM] [ARMD]

LBA/Large Mode [Auto]

Enables or disables the LBA mode. Setting to Auto enables the LBA mode if the device supports this mode, and if the device was not previously formatted with LBA mode disabled.

Configuration options: [Disabled] [Auto]

Block (Multi-sector Transfer) [Auto]

Enables or disables data multi-sectors transfers. When set to Auto, the data transfer from and to the device occurs multiple sectors at a time if the device supports multi-sector transfer feature. When set to [Disabled], the data transfer from and to the device occurs one sector at a time.

Configuration options: [Disabled] [Auto]

PIO Mode [Auto]

Selects the PIO mode.

Configuration options: [Auto] [0] [1] [2] [3] [4]

DMA Mode [Auto]

Selects the DMA mode. Configuration options: [Auto] [SWDMA0]

[SWDMA1] [SWDMA2] [MWDMA0] [MWDMA1] [MWDMA2] [UDMA0]

[UDMA1] [UDMA2] [UDMA3] [UDMA4] [UDMA5]

SMART Monitoring [Auto]

Sets the Smart Monitoring, Analysis, and Reporting Technology.

Configuration options: [Auto] [Disabled] [Enabled]

32Bit Data Transfer [Disabled]

Enables or disables 32-bit data transfer.

Configuration options: [Disabled] [Enabled]

4.3.6 IDE Configuration

The items in this menu allow you to set or change the configurations for the IDE devices installed in the system. Select an item then press <Enter> if you wish to configure the item.

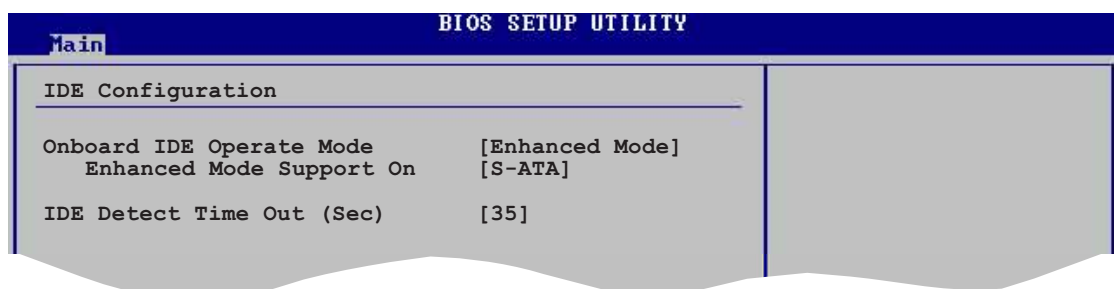

Onboard IDE Operate Mode [Enhanced Mode]

Allows selection of the IDE operation mode depending on the operating system (OS) that you installed. Set to Enhanced Mode if you are using native OS, such as Windows® 2000/XP.

Configuration options: [Disabled] [Compatible Mode] [Enhanced Mode]

Enhanced Mode Support On [S-ATA]

The default setting S-ATA allows you to use native OS on Serial ATA and Parallel ATA ports. We recommend that you do not change the default setting for better OS compatibility. In this setting, you may use legacy OS on the Parallel ATA ports **only** if you did not install any Serial ATA device.

The P-ATA+S-ATA and P-ATA options are for advanced users only. If you set to any of these options and encounter problems, revert to the default setting **S-ATA**. Configuration options: [P-ATA+S-ATA] [S-ATA] [P-ATA]

IDE Detect Time Out [35]

Selects the time out value for detecting ATA/ATAPI devices.
Configuration options: [0] [5] [10] [15] [20] [25] [30] [35]

4.3.7 System Information

This menu gives you an overview of the general system specifications. The BIOS automatically detects the items in this menu.

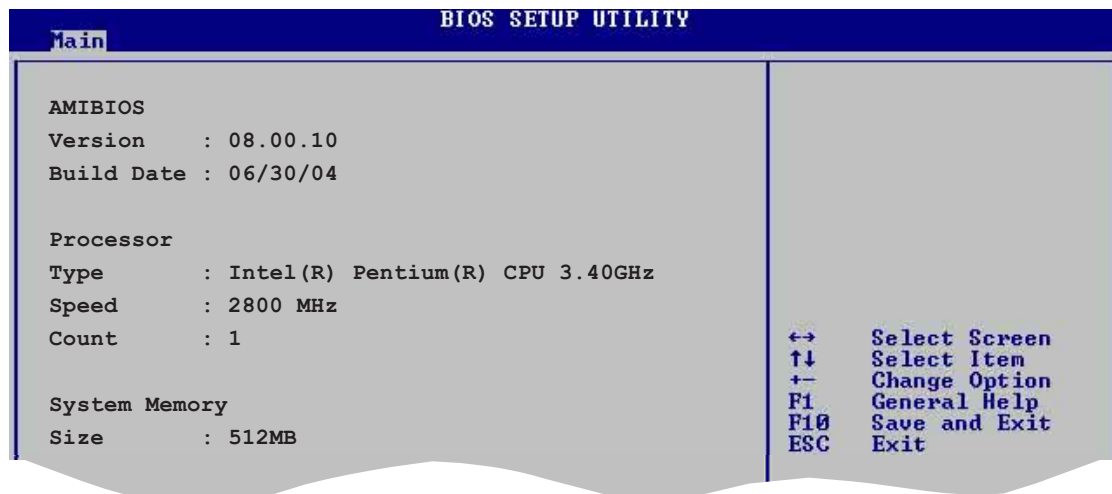

AMI BIOS

Displays the auto-detected BIOS information

Processor

Displays the auto-detected CPU specification

System Memory

Displays the auto-detected system memory

4.4 Advanced menu

The Advanced menu items allow you to change the settings for the CPU and other system devices.



Take caution when changing the settings of the Advanced menu items. Incorrect field values can cause the system to malfunction.

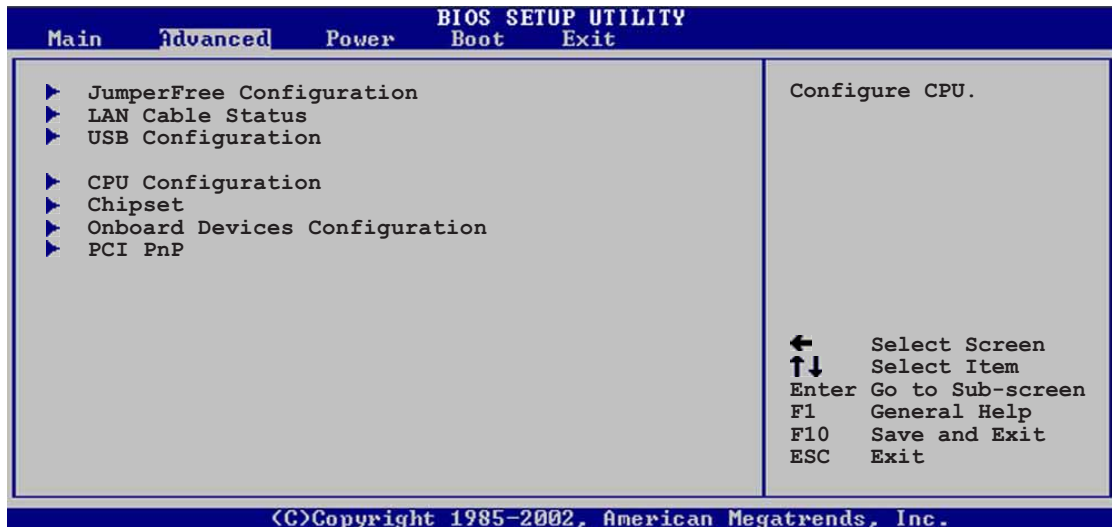

4.4.1 JumperFree Configuration

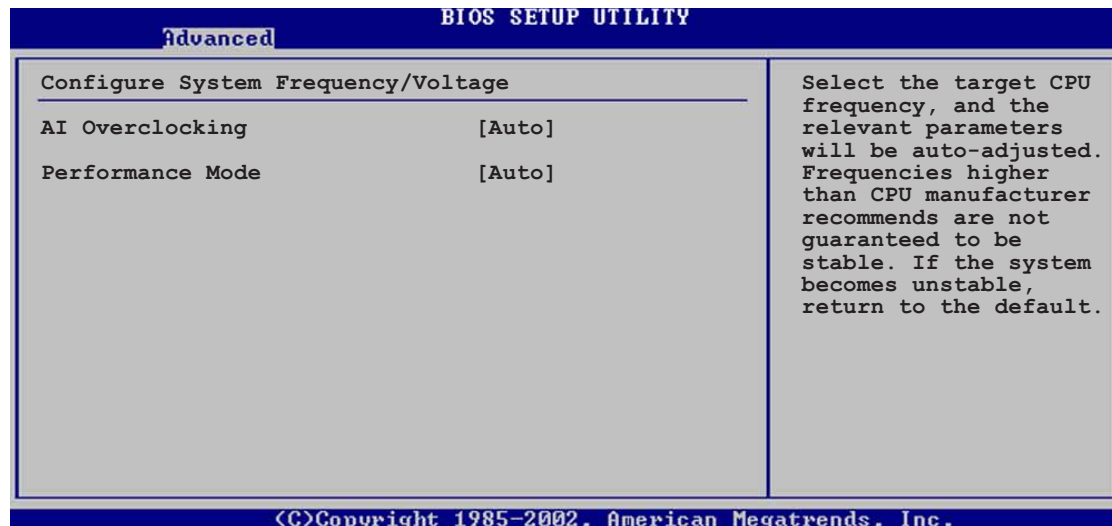

AI Overclocking [Auto]

Allows selection of CPU overclocking options to achieve desired CPU internal frequency. Select either one of the preset overclocking options. Configuration options: [Manual] [Auto] [Standard] [Overclock Profile] [AI NOS]

Performance Mode [Auto]

Allows enhanced system performance. Setting to [Turbo] may cause the system to become unstable. If this happens, revert to the default setting [Auto]. Configuration options: [Auto] [Standard] [Turbo]



The following item appears only when the AI Overclocking item is set to [Overclock Profile].

Overclock Options [Overclock 5%]

Allows you to set the overlocking options.

Configuration options: [Overclock 5%] [Overclock 10%] [Overclock 20%] [Overclock 30%] [FSB900/DDR-450] [FSB1000/DDR-500] [FSB1066/DDR-445] [FSB1066/DDR-533]



The following item appears only when the AI Overclocking item is set to [AI N.O.S.].

N.O.S Mode [Auto]

Sets the Non-Delay Overclocking System mode.

Configuration options: [Auto] [Standard] [Sensitive] [Heavy Load]



The following item appears only when the N.O.S Mode item is set to [Standard], [Sensitive], or [Heavy].

Turbo N.O.S. [Disabled]

Disables or sets the turbo non-delay overclocking system percentage.

Configuration options: [Disabled] [Overclock 3%] [Overclock 5%] [Overclock 7%] [Overclock 10%] [Overclock 15%] [Overclock 20%]

Twin Turbo N.O.S. [Disabled]

Disables or sets the twin turbo non-delay overclocking system percentage.

Configuration options: [Disabled] [Overclock 3%] [Overclock 5%] [Overclock 7%] [Overclock 10%] [Overclock 15%] [Overclock 20%] [Overclock 30%]



The following item appears only when the AI Overclocking item is set to [AI N.O.S.] or [Manual].

Memory Voltage [Auto]

Allows selection of the DDR SDRAM operating voltage. Set to Auto for safe mode. Configuration options: [2.60V] [2.70V] [2.80V] [2.90V] [Auto]



Refer to the DDR documentation before setting the memory voltage. Setting a very high memory voltage may damage the memory module(s)!

Chipset Core Voltage [Auto]

Allows selection of the chipset core voltage. Configuration options: [1.50V] [1.60V] [Auto]

CPU VCore Voltage [Auto]

Allows selection of the CPU VCore voltage. The configuration options vary depending on the CPU installed. Setting to Auto allows the BIOS to detect the VCore voltage of the CPU installed.



Refer to the CPU documentation before setting the CPU VCore voltage. A very high Vcore voltage can severely damage the CPU!

FSB Termination Voltage [Auto]

Sets the Front Side Bus (FSB) termination voltage. Configuration options: [1.20V] [1.40V] [Auto]

CPU Frequency [XXX] (value is auto-detected)

Indicates the frequency sent by the clock generator to the system bus and PCI bus. The bus frequency (external frequency) multiplied by the bus multiple equals the CPU speed. The value of this item is auto-detected by BIOS. The values range from 100 to 400. Refer to the following table for the correct Front Side Bus and CPU External Frequency settings. Use the <+> and <-> keys to adjust the value.

Table 4.4.2 FSB/CPU External Frequency Synchronization

| Front Side Bus | CPU External Frequency |
|----------------|------------------------|
| FSB 800 | 200 MHz |
| FSB 533 | 133 MHz |
| FSB 400 | 100 MHz |



Selecting a very high CPU frequency may cause the system to become unstable! If this happens, revert to the default setting.

DRAM Frequency [Auto]

Allows you to set the DDR operating frequency.

Configuration options: [Auto] [333 MHz] [400 MHz] [600 MHz]



Selecting a DRAM frequency that is not supported by your DIMM module may cause the system to become unstable! If this happens, revert to the default setting. See page 2-14 for qualified DDR DIMMs.

PCI Express Frequency [Auto]

Sets the PCI Express frequency. Configuration options: [Auto] [90] ~ [133]

PCI Clock Synchronization Mode [Auto]

Selects the PCI Clock Synchronization mode.

Configuration options: [To CPU] [33.33MHz] [Auto]

Spread Spectrum [Auto]

Enables, disables or set to Auto the clock generator spread spectrum.

Configuration options: [Disabled] [Enabled] [Auto]

4.4.2 LAN Cable Status

The items in this menu displays the status of the Local Area Network (LAN) cable.

The screenshot shows the BIOS Setup Utility interface. At the top, it says 'BIOS SETUP UTILITY' and 'Advanced'. Below that, there is a section for 'POST Check LAN cable' which is currently set to '[Disabled]'. Underneath, there is a table titled 'LAN Cable Status' with columns for 'Pair', 'Status', and 'Length'. The table lists four pairs of LAN cables, all of which are 'Open' and have a length of '0.0M'.

| Pair | Status | Length |
|------|--------|--------|
| 1-2 | Open | 0.0M |
| 3-6 | Open | 0.0M |
| 4-5 | Open | 0.0M |
| 7-8 | Open | 0.0M |

POST Check LAN cable [Disabled]

Enables or disables checking of the LAN cable during POST.

Configuration options: [Disabled] [Enabled]

4.4.3 USB Configuration

The items in this menu allows you to change the USB-related features. Select an item then press <Enter> to display the configuration options.

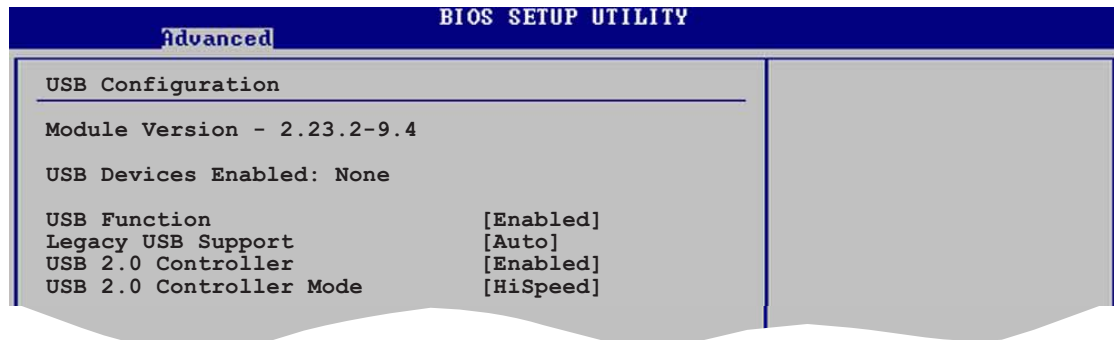

The Module Version and USB Devices Enabled items show the auto-detected values. If no USB device is detected, the item shows None.

USB Function [Enabled]

Allows you to enable or disable the USB function.
Configuration options: [Disabled] [Enabled]

Legacy USB Support [Auto]

Allows you to enable or disable support for USB devices on legacy operating systems (OS). Setting to Auto allows the system to detect the presence of USB devices at startup. If detected, the USB controller legacy mode is enabled. If no USB device is detected, the legacy USB support is disabled.

Configuration options: [Disabled] [Enabled] [Auto]

USB 2.0 Controller [Enabled]

Allows you to enable or disable the USB 2.0 controller.
Configuration options: [Disabled] [Enabled]

USB 2.0 Controller Mode [HiSpeed]

Allows you to set the USB 2.0 controller mode to HiSpeed (480 Mbps) or FullSpeed (12 Mbps). Configuration options: [FullSpeed] [HiSpeed]

4.4.4 CPU Configuration

The items in this menu show the CPU-related information that the BIOS automatically detects.



Ratio CMOS Setting [8]

Sets the ratio between the CPU Core Clock and the Front Side Bus frequency. The default value of this item is auto-detected by BIOS. Use the <+> or <-> keys to adjust the values.

VID CMOS Setting [45]

Allows you to set the VID CMOS setting at which the processor is to run. The default value of this item is auto-detected by BIOS. Use the <+> or <-> keys to adjust the values.

Microcode Updation [Enabled]

Enables or disables the Microcode Updation feature.
Configuration options: [Disabled] [Enabled]

Max CPUID Value Limit [Disabled]

Enable this item to boot legacy operating systems that cannot support CPUs with extended CPUID functions. Configuration options: [Disabled] [Enabled]

Enhanced C1 Control [Auto]

When set to [Auto], the BIOS will automatically check the CPU's capability to enable the C1E support. In C1E mode, the CPU power consumption is lower when idle. Configuration options: [Auto] [Disabled]

CPU Internal Thermal Control [Auto]

Disables or sets the CPU internal thermal control.
Configuration options: [Disabled] [Auto]

Hyper-Threading Technology [Enabled]

Allows you to enable or disable the processor Hyper-Threading Technology.
Configuration options: [Disabled] [Enabled]

4.4.5 Chipset

The Chipset menu allows you to change the advanced chipset settings.
Select an item then press <Enter> to display the sub-menu.

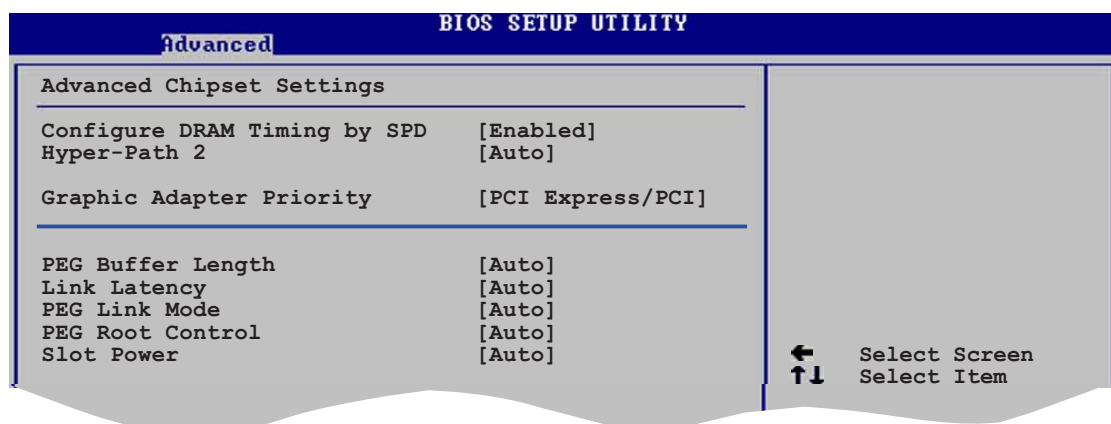

Advanced Chipset Settings

Configure DRAM Timing by SPD [Enabled]

When this item is enabled, the DRAM timing parameters are set according to the DRAM SPD (Serial Presence Detect). When disabled, you can manually set the DRAM timing parameters through the DRAM sub-items. The following sub-items appear when this item is Disabled.
Configuration options: [Disabled] [Enabled]

DRAM CAS# Latency [3 Clocks]

Controls the latency between the SDRAM read command and the time the data actually becomes available.
Configuration options: [3 Clocks] [2.5 Clocks] [2 Clocks]

DRAM RAS# Precharge [4 Clocks]

Controls the idle clocks after issuing a precharge command to the DDR SDRAM. Configuration options: [2 Clocks] [3 Clocks] [4 Clocks] [5 Clocks]

DRAM RAS# to CAS# Delay [4 Clocks]

Controls the latency between the DDR SDRAM active command and the read/write command. Configuration options: [2 Clocks] [3 Clocks] [4 Clocks] [5 Clocks]

DRAM RAS# Activate to Precharge [15 Clocks]

Sets the RAS Activate timing to Precharge timing.

Configuration options: [1 Clock] [2 Clocks] ~ [15 Clocks]

DRAM Write Recovery Time [4 Clocks]

Sets the DRAM Write Recover Time.

Configuration options: [2 Clocks] [3 Clocks] [4 Clocks] [5 Clocks]

Hyper Path 2 [Auto]

Enables or disables the memory acceleration mode feature.

Configuration options: [Disabled] [Enabled] [Auto]

Booting Graphic Adapter Priority [PCI Express/PCI]

Allows selection of the graphics controller to use as primary boot device.

Configuration options: [Internal VGA] [PCI Express/Int-VGA]

[PCI Express/PCI] [PCI/PCI Express] [PCI/Int-VGA]

PEG Buffer Length [Auto]

Sets the PCI Express Graphics card buffer length.

Configuration options: [Auto] [Long] [Short]

Link Latency [Auto]

Sets the link latency. Configuration options: [Auto] [Slow] [Normal]

PEG Link Mode [Auto]

Sets the PCI Express Graphics link mode.

Configuration options: [Auto] [Slow] [Normal] [Fast] [Faster]

PEG Root Control [Auto]

Enables or disables the PCI Express Graphics root control.

Configuration options: [Auto] [Disabled] [Enabled]

Slot Power [Auto]

Sets the slot operating power.

Configuration options: [Auto] [Light] [Normal] [Heavy] [Heavier]

4.4.6 Onboard Devices Configuration

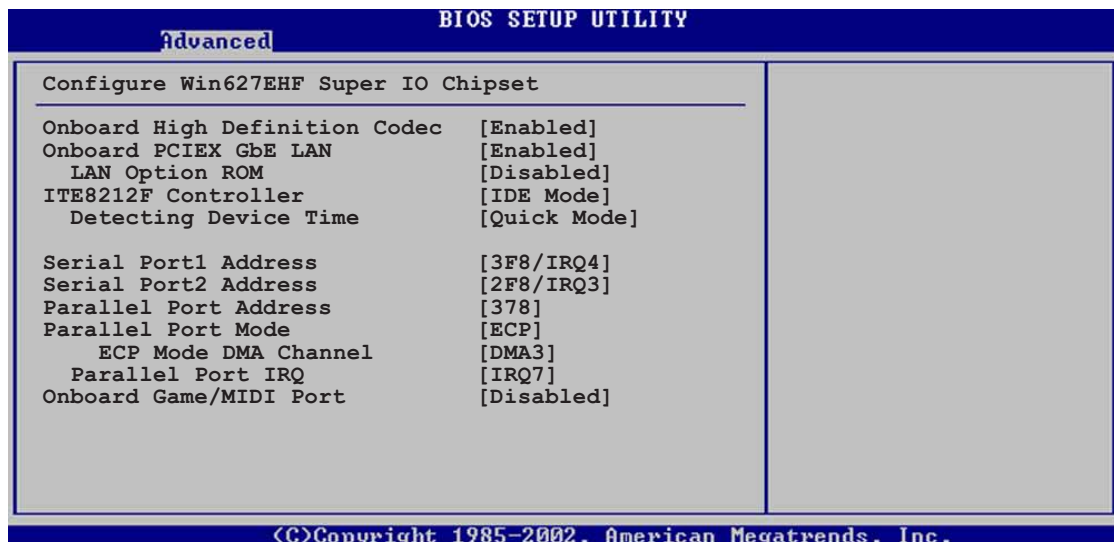

Onboard High Definition Codec [Enabled]

Enables or disables the onboard High-Definition Audio CODEC.
Configuration options: [Enabled] [Disabled]

OnBoard PCIEX GbE LAN [Enabled]

Allows you to enable or disable the onboard PCI Express Gigabit LAN controller. Configuration options: [Disabled] [Enabled]

LAN Option ROM [Disabled]

Allows you to enable or disable the option ROM in the onboard LAN controller. This item appears only when the Onboard LAN item is set to Enabled. Configuration options: [Disabled] [Enabled]

ITE8212F Controller [IDE Mode]

Allows you to set the onboard ITE® 8212F RAID controller operating mode.
Configuration options: [RAID Mode] [IDE Mode] [Disabled]

Detecting Device Time [Quick Mode]

Sets the ITE8212F detecting device time. If the devices installed on the IDE RAID connectors cannot be detected, set this item to Standard Mode to enable complete detecting process. This item appears only when the ITE8212F Controller is set to IDE Mode.
Configuration options: [Standard Mode] [Quick Mode]

Serial Port1 Address [3F8/IRQ4]

Allows you to select the Serial Port1 base address.
Configuration options: [Disabled] [3F8/IRQ4] [3E8/IRQ4] [2E8/IRQ3]

Serial Port2 Address [2F8/IRQ3]

Allows you to select the Serial Port2 base address.

Configuration options: [Disabled] [2F8/IRQ3] [3E8/IRQ4] [2E8/IRQ3]

Parallel Port Address [378]

Allows you to select the Parallel Port base addresses.

Configuration options: [Disabled] [378] [278] [3BC]

Parallel Port Mode [ECP]

Allows you to select the Parallel Port mode.

Configuration options: [Normal] [Bi-directional] [EPP] [ECP]

ECP Mode DMA Channel [DMA3]

Appears only when the Parallel Port Mode is set to [ECP]. This item allows you to set the Parallel Port ECP DMA.

Configuration options: [DMA0] [DMA1] [DMA3]

EPP Version [1.9]

Allows selection of the Parallel Port EPP version. This item appears only when the **Parallel Port Mode** is set to **EPP**.

Configuration options: [1.9] [1.7]

Parallel Port IRQ [IRQ7]

Configuration options: [IRQ5] [IRQ7]

Onboard Game/MIDI Port [Disabled]

Allows you to select the Game Port address or to disable the port.

Configuration options: [Disabled] [200/300] [200/330] [208/300] [208/330]

MIDI IRQ Select [IRQ10]

Sets MIDI port IRQ address.

Configuration options: [IRQ5] [IRQ10] [IRQ11]

4.4.7 PCI PnP

The PCI PnP menu items allow you to change the advanced settings for PCI/PnP devices. The menu includes setting IRQ and DMA channel resources for either PCI/PnP or legacy ISA devices, and setting the memory size block for legacy ISA devices.



Take caution when changing the settings of the PCI PnP menu items. Incorrect field values can cause the system to malfunction.

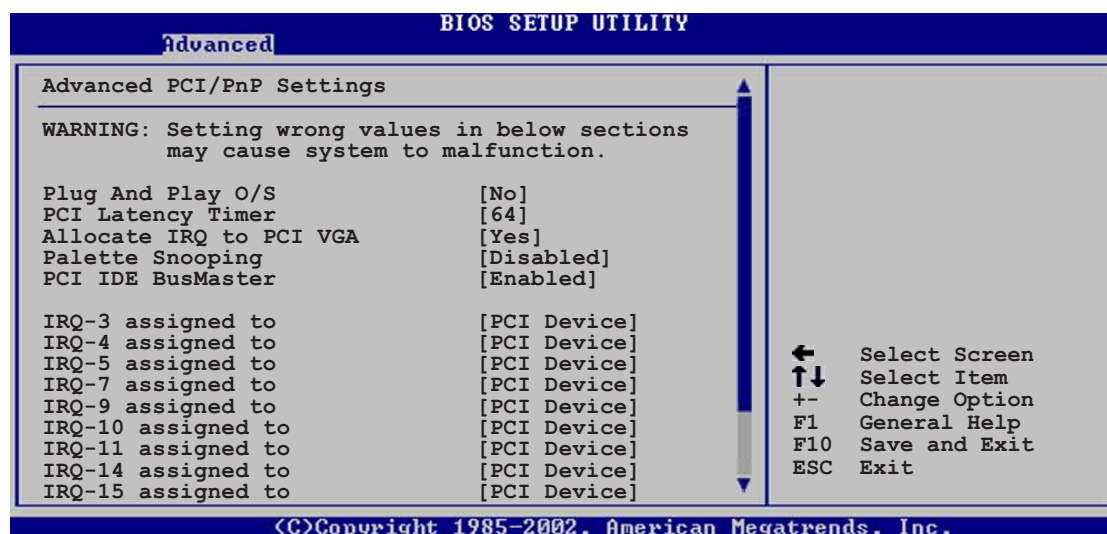

Plug And Play O/S [No]

When set to [No], BIOS configures all the devices in the system. When set to [Yes] and if you install a Plug and Play operating system, the operating system configures the Plug and Play devices not required for boot.

Configuration options: [No] [Yes]

PCI Latency Timer [64]

Allows you to select the value in units of PCI clocks for the PCI device latency timer register. Configuration options: [32] [64] [96] [128] [160] [192] [224] [248]

Allocate IRQ to PCI VGA [Yes]

When set to [Yes], BIOS assigns an IRQ to PCI VGA card if the card requests for an IRQ. When set to [No], BIOS does not assign an IRQ to the PCI VGA card even if requested. Configuration options: [No] [Yes]

Palette Snooping [Disabled]

When set to [Enabled], the palette snooping feature informs the PCI devices that an ISA graphics device is installed in the system so that the latter can function correctly. Configuration options: [Disabled] [Enabled]

PCI IDE BusMaster [Enabled]

Allows BIOS to use PCI bus mastering when reading/writing to IDE devices. Configuration options: [Disabled] [Enabled]

IRQ-xx assigned to [PCI Device]

When set to [PCI Device], the specific IRQ is free for use of PCI/PnP devices. When set to [Reserved], the IRQ is reserved for legacy ISA devices. Configuration options: [PCI Device] [Reserved]

4.5 Power menu

The Power menu items allow you to change the settings for the Advanced Power Management (APM). Select an item then press <Enter> to display the configuration options.

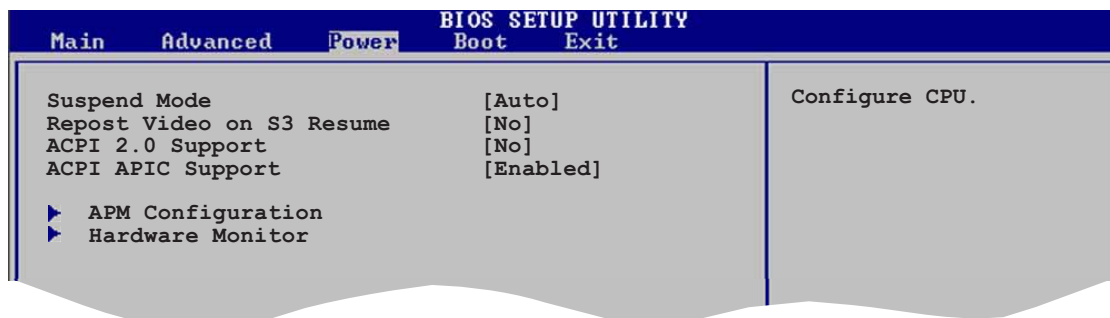

4.5.1 Suspend Mode [Auto]

Allows you to select the Advanced Configuration and Power Interface (ACPI) state to be used for system suspend.

Configuration options: [S1 (POS) Only] [S3 Only] [Auto]

4.5.2 Repost Video on S3 Resume [No]

Determines whether to invoke VGA BIOS POST on S3/STR resume.

Configuration options: [Yes] [No]

4.5.3 ACPI 2.0 Support [No]

Allows you to add more tables for Advanced Configuration and Power Interface (ACPI) 2.0 specifications. Configuration options: [No] [Yes]

4.5.4 ACPI APIC Support [Enabled]

Allows you to enable or disable the Advanced Configuration and Power Interface (ACPI) support in the Application-Specific Integrated Circuit (ASIC). When set to Enabled, the ACPI APIC table pointer is included in the RSDT pointer list. Configuration options: [Disabled] [Enabled]

4.5.5 APM Configuration

| BIOS SETUP UTILITY | | |
|--|-------------|-------------------------|
| Power | | |
| APM Configuration | | |
| Power Button Mode | [On/Off] | Enabled or disable APM. |
| Restore on AC Power Loss | [Power Off] | |
| Power On By RTC Alarm | [Disabled] | |
| Power On By External Modems | [Disabled] | |
| Power On By PCI Devices | [Disabled] | |
| Power On By PS/2 Keyboard | [Disabled] | |
| Keyboard Wakeup Password : Not Installed | | |
| Power On By PS/2 Mouse | [Disabled] | |

Power Button Mode [On/Off]

Allows the system to go into On/Off mode or suspend mode when the power button is pressed. Configuration options: [On/Off] [Suspend]

Restore on AC Power Loss [Power Off]

When set to Power Off, the system goes into off state after an AC power loss. When set to Power On, the system goes on after an AC power loss. When set to Last State, the system goes into either off or on state, whatever the system state was before the AC power loss. Configuration options: [Power Off] [Power On] [Last State]

Power On By RTC Alarm [Disabled]

Allows you to enable or disable RTC to generate a wake event. When this item is set to Enabled, the items RTC Alarm Date, RTC Alarm Hour, RTC Alarm Minute, and RTC Alarm Second appear with set values. Configuration options: [Disabled] [Enabled]

Power On By External Modems [Disabled]

This allows either settings of [Enabled] or [Disabled] for powering up the computer when the external modem receives a call while the computer is in Soft-off mode. Configuration options: [Disabled] [Enabled]



The computer cannot receive or transmit data until the computer and applications are fully running. Thus, connection cannot be made on the first try. Turning an external modem off and then back on while the computer is off causes an initialization string that turns the system power on.

Power On By PCI Devices [Disabled]

When set to [Enabled], this parameter allows you to turn on the system through a PCI LAN or modem card. This feature requires an ATX power supply that provides at least 1A on the +5VSB lead.

Configuration options: [Disabled] [Enabled]

Power On By PS/2 Keyboard [Disabled]

Allows you to use specific keys on the keyboard to turn on the system. This feature requires an ATX power supply that provides at least 1A on the +5VSB lead. Configuration options: [Disabled] [Enabled]

Wakeup Password

This item appears only when the Power On By PS/2 Keyboard is set to Enabled. Select this item then press <Enter> to set or change the keyboard wakeup password.

Keyboard Wakeup Password

Shows **Not Installed** if there is no wake-up password installed. After you have set a password, this item shows **Installed**.

Power On By PS/2 Mouse [Disabled]

When set to [Enabled], this parameter allows you to use the PS/2 mouse to turn on the system. This feature requires an ATX power supply that provides at least 1A on the +5VSB lead.

Configuration options: [Disabled] [Enabled]

4.5.6 Hardware Monitor

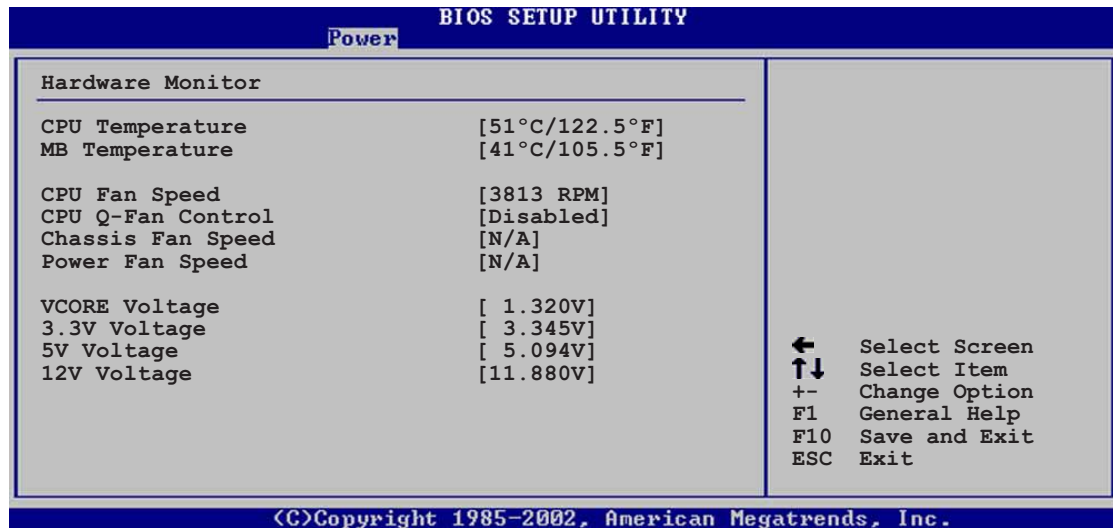

CPU Temperature [xxx°C/xxx°F]

MB Temperature [xxx°C/xxx°F]

The onboard hardware monitor automatically detects and displays the motherboard and CPU temperatures. Select Disabled if you do not wish to display the detected temperatures.

CPU Fan Speed [xxxxRPM] or [N/A]

The onboard hardware monitor automatically detects and displays the CPU fan speed in rotations per minute (RPM). If the fan is not connected to the motherboard, the field shows N/A.

CPU Q-Fan Control [Disabled]

Allows you to enable or disable the ASUS Q-Fan feature that smartly adjusts the fan speeds for more efficient system operation. When this field is set to [Enabled], the **CPU Fan Ratio** item appears to allow selection of the appropriate fan speed ratio. Configuration options: [Disabled] [Enabled]



The **CPU Q-Fan Mode**, **CPU Fan Ratio**, and **CPU Target Temperature** items appear when you enable the **CPU Q-Fan Control** feature.

CPU Q-Fan Mode [PWM]

Allows you to select the type of CPU fan cable connected to the CPU fan connector. Set to [PWM] when using a 4-pin CPU fan cable. Set to [DC] when using a 3-pin CPU fan cable. Configuration options: [PWM] [DC]



Some CPU fans with a 4-pin cable do not comply with Intel®'s PWM fan specification. When using this type of CPU fan, you can not reduce the CPU fan speed even if you set the CPU Q-Fan Mode to [PWM].

CPU Fan Ratio [Auto]

Allows you to select the appropriate CPU fan speed ratio for the system. The default [Auto] automatically selects the fan speed ratio when operating a low CPU temperature. Select a higher ratio if you installed additional devices and the system requires more ventilation. This item appears only when the CPU Q-Fan Control item is Enabled. Configuration options: [Auto] [90%] [80%] [70%] [60%]

CPU Target Temperature [xxx°C]

Allows you to set the CPU temperature threshold when the CPU fan speed is increased to lower the CPU temperature. The default target temperature is the Intel® Fan Speed Control (FSC) recommended value. This item appears only when the CPU Q-Fan Control item is Enabled. Configuration options: [35°C] [38°C] [41°C] [44°C] [47°C] [50°C] [53°C] [56°C] [59°C] [62°C] [65°C]

Chassis Fan Speed [xxxxRPM] or [N/A]

The onboard hardware monitor automatically detects and displays the chassis fan speed in rotations per minute (RPM). If the fan is not connected to the chassis, the specific field shows N/A.

Power Fan Speed [xxxxRPM] or [N/A]

The onboard hardware monitor automatically detects and displays the power fan speed in rotations per minute (RPM). If the fan is not connected to the power fan connector, the specific field shows N/A.

VCORE Voltage, 3.3V Voltage, 5V Voltage, 12V Voltage

The onboard hardware monitor automatically detects the voltage output through the onboard voltage regulators.

4.6 Boot menu

The Boot menu items allow you to change the system boot options. Select an item then press <Enter> to display the sub-menu.

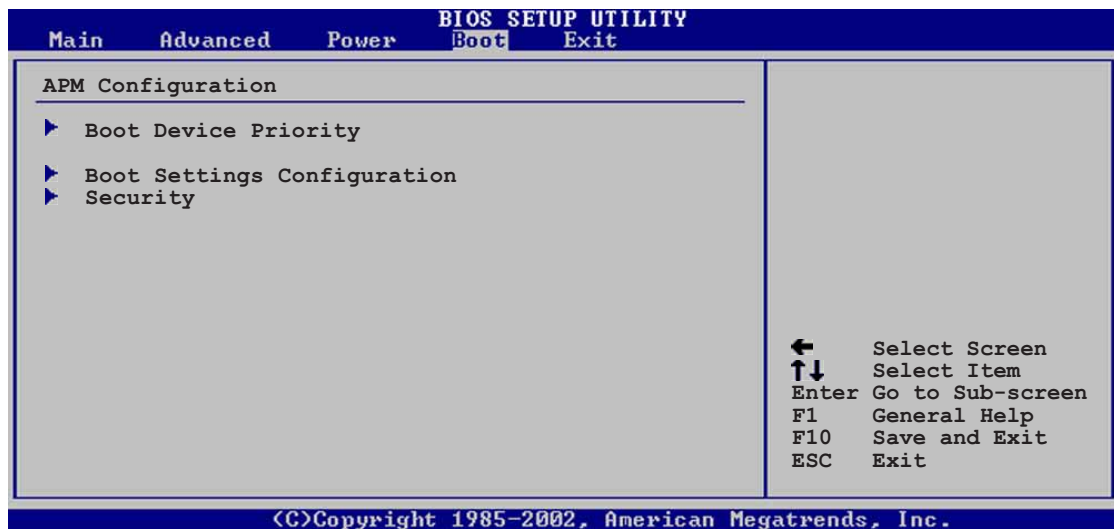

4.6.1 Boot Device Priority

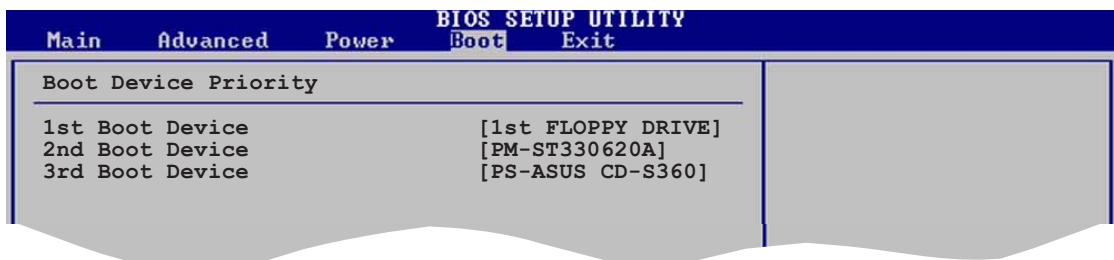

1st ~ xxth Boot Device [1st Floppy Drive]

These items specify the boot device priority sequence from the available devices. The number of device items that appears on the screen depends on the number of devices installed in the system.

Configuration options: [xxxxx Drive] [Disabled]

4.6.2 Boot Settings Configuration

| BIOS SETUP UTILITY | |
|------------------------------------|--------------|
| Boot | |
| Boot Settings Configuration | |
| Quick Boot | [Enabled] |
| Full Screen Logo | [Enabled] |
| AddOn ROM Display Mode | [Force BIOS] |
| Bootup Num-Lock | [On] |
| PS/2 Mouse Support | [Auto] |
| Wait For 'F1' If Error | [Enabled] |
| Hit 'DEL' Message Display | [Enabled] |
| Interrupt 19 Capture | [Disabled] |

Allows BIOS to skip certain tests while booting. This will decrease the time needed to boot the system.

Quick Boot [Enabled]

Enabling this item allows the BIOS to skip some power on self tests (POST) while booting to decrease the time needed to boot the system. When set to [Disabled], BIOS performs all the POST items.

Configuration options: [Disabled] [Enabled]

Full Screen Logo [Enabled]

This allows you to enable or disable the full screen logo display feature.

Configuration options: [Disabled] [Enabled]



Set this item to [Enabled] to use the ASUS MyLogo™ feature.

Add On ROM Display Mode [Force BIOS]

Sets the display mode for option ROM.

Configuration options: [Force BIOS] [Keep Current]

Bootup Num-Lock [On]

Allows you to select the power-on state for the NumLock.

Configuration options: [Off] [On]

PS/2 Mouse Support [Auto]

Allows you to enable or disable support for PS/2 mouse.

Configuration options: [Disabled] [Enabled] [Auto]

Wait for 'F1' If Error [Enabled]

When set to Enabled, the system waits for the F1 key to be pressed when error occurs. Configuration options: [Disabled] [Enabled]

Hit 'DEL' Message Display [Enabled]

When set to Enabled, the system displays the message "Press DEL to run Setup" during POST. Configuration options: [Disabled] [Enabled]

Interrupt 19 Capture [Disabled]

When set to [Enabled], this function allows the option ROMs to trap Interrupt 19. Configuration options: [Disabled] [Enabled]

4.6.3 Security

The Security menu items allow you to change the system security settings. Select an item then press <Enter> to display the configuration options.

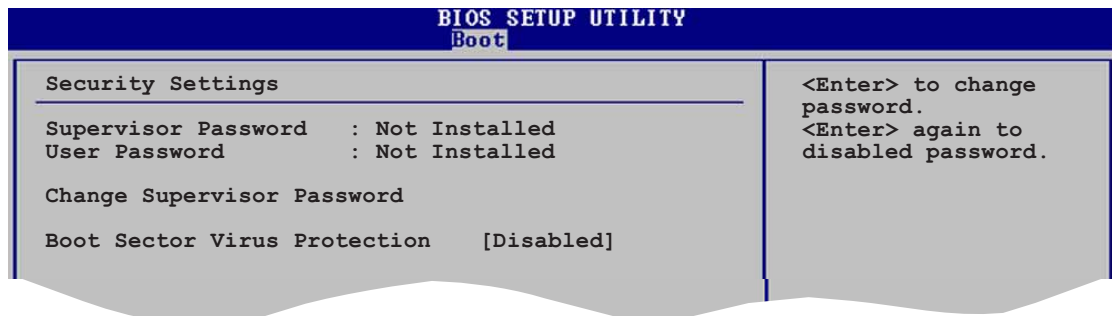

Change Supervisor Password

Select this item to set or change the supervisor password. The Supervisor Password item on top of the screen shows the default **Not Installed**. After you set a password, this item shows **Installed**.

To set a Supervisor Password:

1. Select the Change Supervisor Password item and press <Enter>.
2. From the password box, type a password composed of at least six letters and/or numbers, then press <Enter>.
3. Confirm the password when prompted.

The message "Password Installed" appears after you successfully set your password.

To change the supervisor password, follow the same steps as in setting a user password.

To clear the supervisor password, select the Change Supervisor Password then press <Enter>. The message "Password Uninstalled" appears.



If you forget your BIOS password, you can clear it by erasing the CMOS Real Time Clock (RTC) RAM. See section “2.6 Jumpers” for information on how to erase the RTC RAM.

After you have set a supervisor password, the other items appear to allow you to change other security settings.

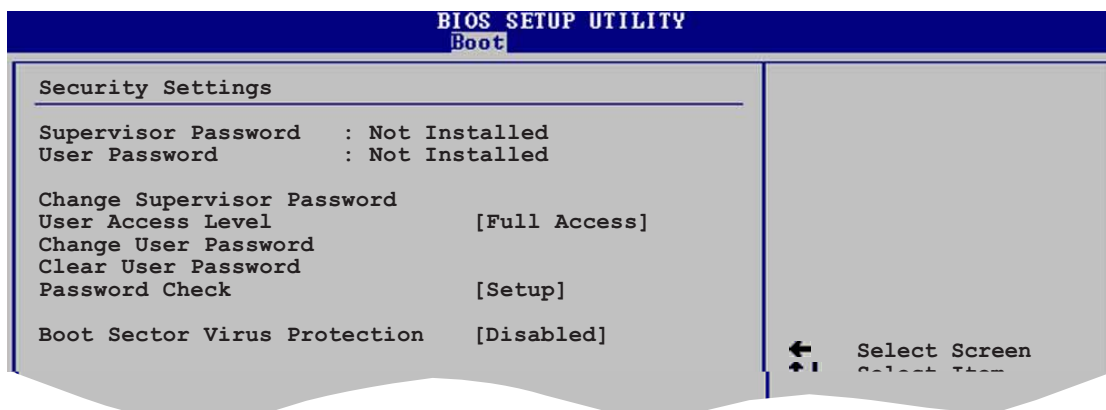

User Access Level (Full Access]

This item allows you to select the access restriction to the Setup items. Configuration options: [No Access] [View Only] [Limited] [Full Access]

No Access prevents user access to the Setup utility.

View Only allows access but does not allow change to any field.

Limited allows changes only to selected fields, such as Date and Time.

Full Access allows viewing and changing all the fields in the Setup utility.

Change User Password

Select this item to set or change the user password. The User Password item on top of the screen shows the default **Not Installed**. After you set a password, this item shows **Installed**.

To set a User Password:

1. Select the Change User Password item and press <Enter>.
2. On the password box that appears, type a password composed of at least six letters and/or numbers, then press <Enter>.
3. Confirm the password when prompted.

The message “Password Installed” appears after you set your password successfully.

To change the user password, follow the same steps as in setting a user password.

Clear User Password

Select this item to clear the user password.

Password Check [Setup]

When set to [Setup], BIOS checks for user password when accessing the Setup utility. When set to [Always], BIOS checks for user password both when accessing Setup and booting the system.

Configuration options: [Setup] [Always]

Boot Sector Virus Protection [Disabled]

Allows you to enable or disable the boot sector virus protection.

Configuration options: [Disabled] [Enabled]

4.7 Exit menu

The Exit menu items allow you to load the optimal or failsafe default values for the BIOS items, and save or discard your changes to the BIOS items.

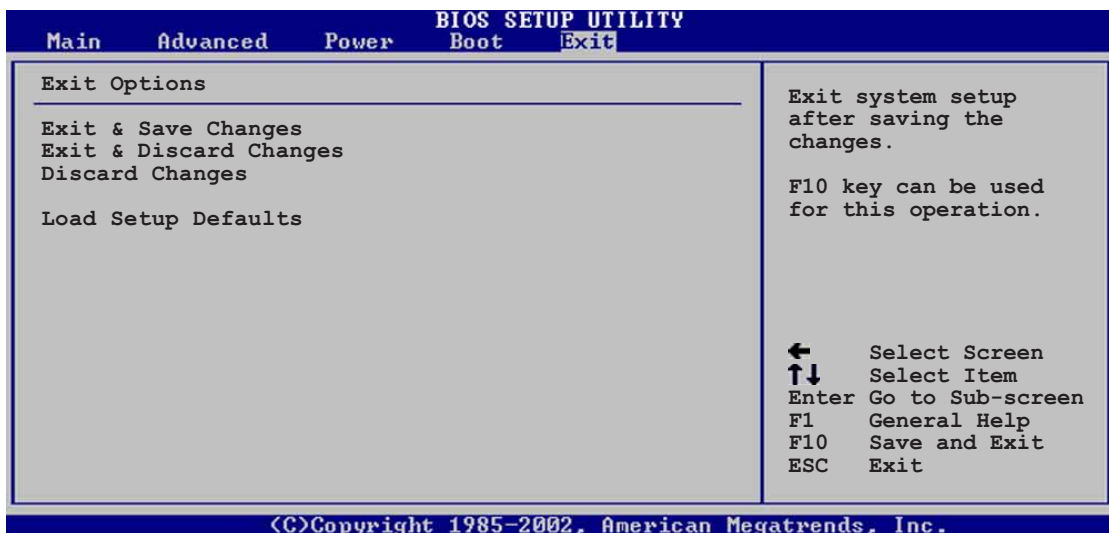

Pressing <Esc> does not immediately exit this menu. Select one of the options from this menu or <F10> from the legend bar to exit.

Exit & Save Changes

Once you are finished making your selections, choose this option from the Exit menu to ensure the values you selected are saved to the CMOS RAM. An onboard backup battery sustains the CMOS RAM so it stays on even when the PC is turned off. When you select this option, a confirmation window appears. Select **Yes** to save changes and exit.



If you attempt to exit the Setup program without saving your changes, the program prompts you with a message asking if you want to save your changes before exiting. Press <Enter> to save the changes while exiting.

Exit & Discard Changes

Select this option only if you do not want to save the changes that you made to the Setup program. If you made changes to fields other than System Date, System Time, and Password, the BIOS asks for a confirmation before exiting.

Discard Changes

This option allows you to discard the selections you made and restore the previously saved values. After selecting this option, a confirmation appears. Select **Yes** to discard any changes and load the previously saved values.

Load Setup Defaults

This option allows you to load the default values for each of the parameters on the Setup menus. When you select this option or if you press <F5>, a confirmation window appears. Select **Yes** to load default values. Select **Exit & Save Changes** or make other changes before saving the values to the non-volatile RAM.

This chapter describes the contents of the support CD that comes with the motherboard package.

5 Software support

Chapter summary

| | | |
|-----|--------------------------------------|------|
| 5.1 | Installing an operating system | 5-1 |
| 5.2 | Support CD information | 5-1 |
| 5.3 | Software information | 5-8 |
| 5.4 | RAID configurations | 5-16 |
| 5.5 | Creating a RAID driver disk | 5-24 |

5.1 Installing an operating system

This motherboard supports Windows® 2000/2003 Server/XP operating systems (OS). Always install the latest OS version and corresponding updates to maximize the features of your hardware.



- Motherboard settings and hardware options vary. Use the setup procedures presented in this chapter for reference only. Refer to your OS documentation for detailed information.
- Make sure that you install Windows® 2000 Service Pack 4 or the Windows® XP Service Pack 1 or later versions before installing the drivers for better compatibility and system stability.

5.2 Support CD information

The support CD that came with the motherboard package contains the drivers, software applications, and utilities that you can install to avail all motherboard features.



The contents of the support CD are subject to change at any time without notice. Visit the ASUS website(www.asus.com) for updates.

5.2.1 Running the support CD

Place the support CD to the optical drive. The CD automatically displays the **Drivers** menu if Autorun is enabled in your computer.

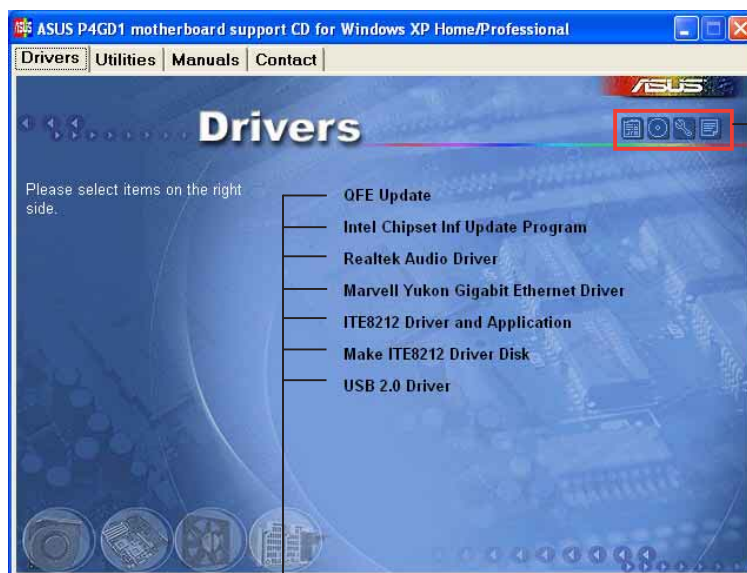

Click an icon to display support CD/motherboard information

Click an item to install



If **Autorun** is NOT enabled in your computer, browse the contents of the support CD to locate the file **ASSETUP.EXE** from the BIN folder. Double-click the **ASSETUP.EXE** to run the CD.

5.2.2 Drivers menu

The drivers menu shows the available device drivers if the system detects installed devices. Install the necessary drivers to activate the devices.



QFE Update

Installs the Quick Fix Engineering (QFE) driver updates.

Intel Chipset Inf Update Program

This item installs the Intel® Chipset INF Update Program. This driver enables Plug-n-Play INF support for the Intel® chipset components on the motherboard. When installed to the target system, this driver provides the method for configuring the chipset components.

You can install this utility using three different modes: interactive, silent, or unattended preload. Installing the driver in interactive mode requires user input during installation. User input is not required when installing the driver in silent or unattended preload modes. Refer to the online help or readme file that came with the utility for details.

Realtek Audio Driver

Executes the wizard to install the Realtek® ALC861 audio driver and application.

Marvell Yukon Gigabit Ethernet Driver

Installs the Marvell® Yukon 88E8053 PCI Express™ Gigabit LAN driver that provides up to 1000 Mbps data transfer rates.

IT8212 Driver and Application

Installs the IT8212 driver and application.

Make ITE8212 Driver Disk

Allows you to create a driver disk for the IT8212 IDE RAID setup.

USB 2.0 Driver

Installs the USB 2.0 driver.



The screen display and drivers option may not be the same for different operating system versions.

5.2.3 Utilities menu

The Utilities menu shows the applications and other software that the motherboard supports.

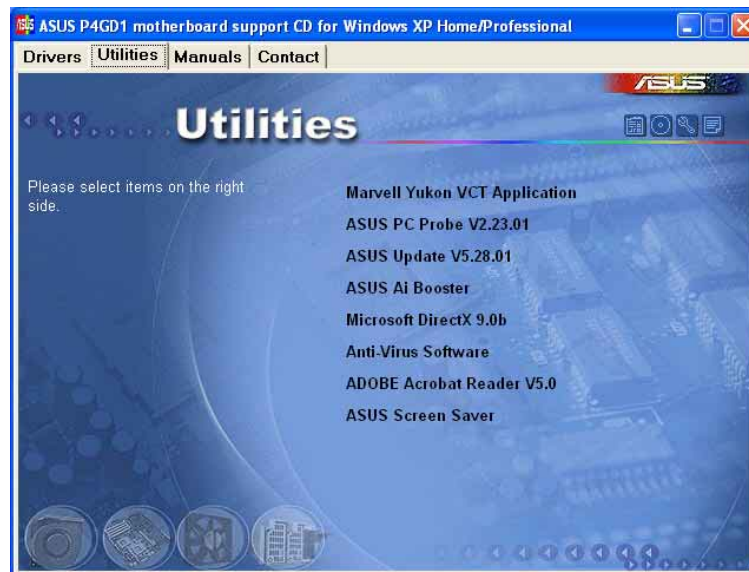

Marvell Yukon VCT Application

Installs the Marvell® Yukon VCT cable diagnostic application that analyzes and reports LAN cable faults and shorts. See page 5-10 for details.

ASUS PC Probe

This smart utility monitors the fan speed, CPU temperature, and system voltages, and alerts you of any detected problems. This utility helps you keep your computer in healthy operating condition.

ASUS Update

The ASUS Update utility allows you to update the motherboard BIOS in a Windows® environment. This utility requires an Internet connection either through a network or an Internet Service Provider (ISP). See page 4-7 for details.

ASUS Ai Booster

The ASUS AI Booster application allows you to overclock the CPU speed in a Windows® environment.

Microsoft DirectX

The Microsoft DirectX 9.0b is a multimedia technology that enhances computer graphics and sounds. DirectX improves the multimedia features of your computer so you can enjoy watching TV and movies, capturing videos, or playing games in your computer.

Anti-virus software

Installs the anti-virus program. View the online help for detailed information.

ADOBE Acrobat Reader

The Adobe® Acrobat® Reader V5.0 is for opening, viewing, and printing documents in Portable Document Format (PDF).

ASUS Screen Saver

Installs the ASUS screen saver.



The screen display and utilities option may not be the same for different operating system versions.

5.2.4 Manuals menu

The Manuals menu contains a list of supplementary user manuals. Click an item to open the folder of the user manual.



Install the Adobe® Acrobat® Reader from the Utilities menu before opening the manual files.

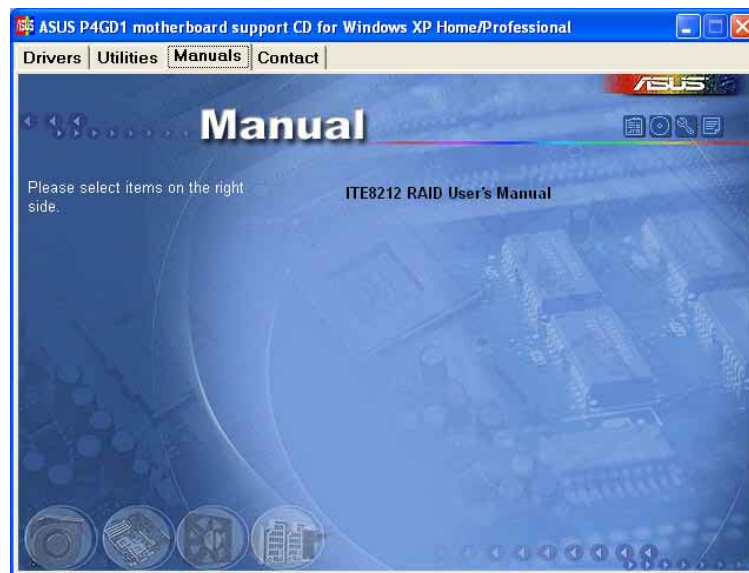

ITE8212 RAID User's Manual

Allows you to open the ITE® 8212F RAID User's manual.



The screen display and manuals option may not be the same for different operating system versions.

5.2.5 ASUS Contact information

Click the **Contact** tab to display the ASUS contact information. You can also find this information on the inside front cover of this user guide.



5.2.6 Other information

The icons on the top right corner of the screen give additional information on the motherboard and the contents of the support CD. Click an icon to display the specified information.

Motherboard Info

Displays the general specifications of the motherboard.

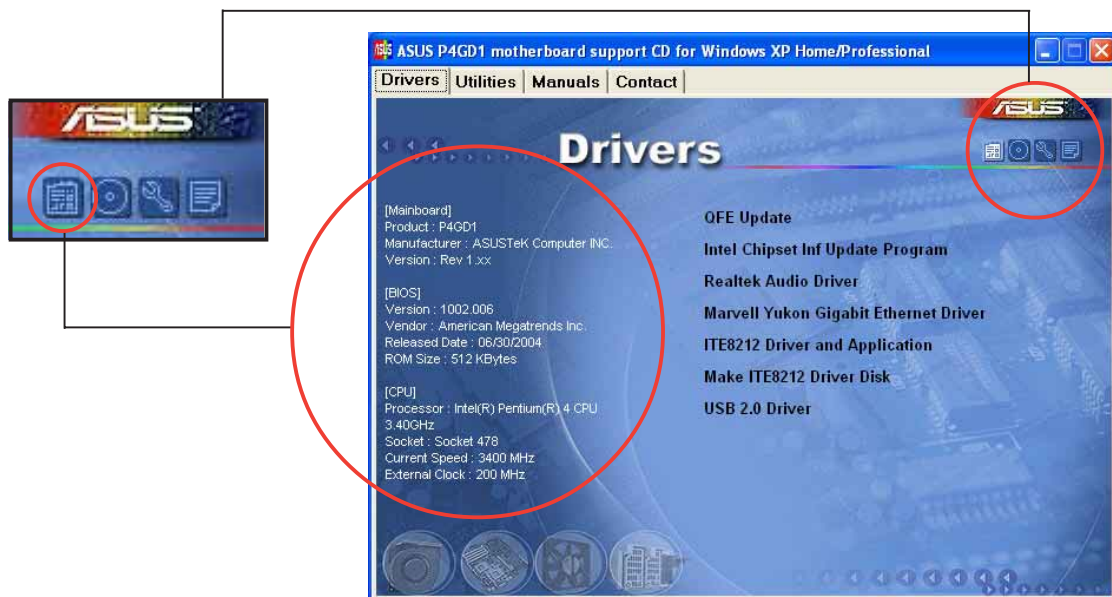

Browse this CD

Displays the support CD contents in graphical format.

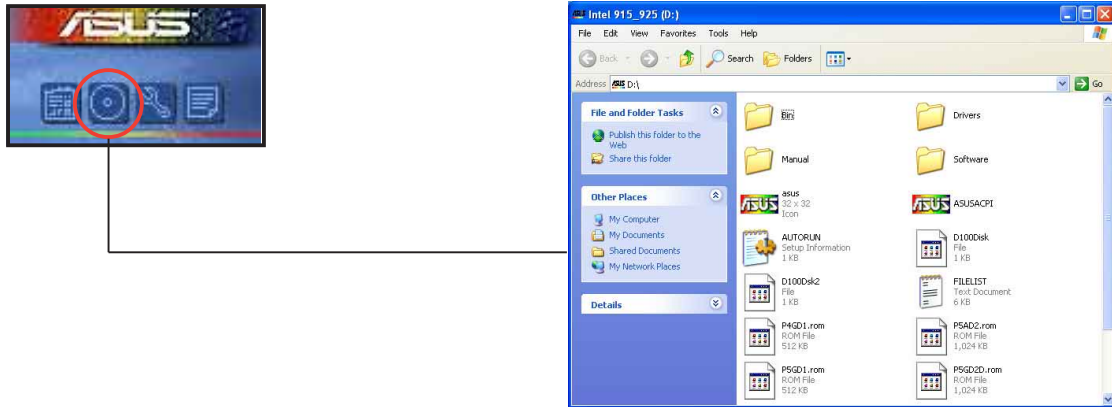

Technical support Form

Displays the ASUS Technical Support Request Form that you have to fill out when requesting technical support.

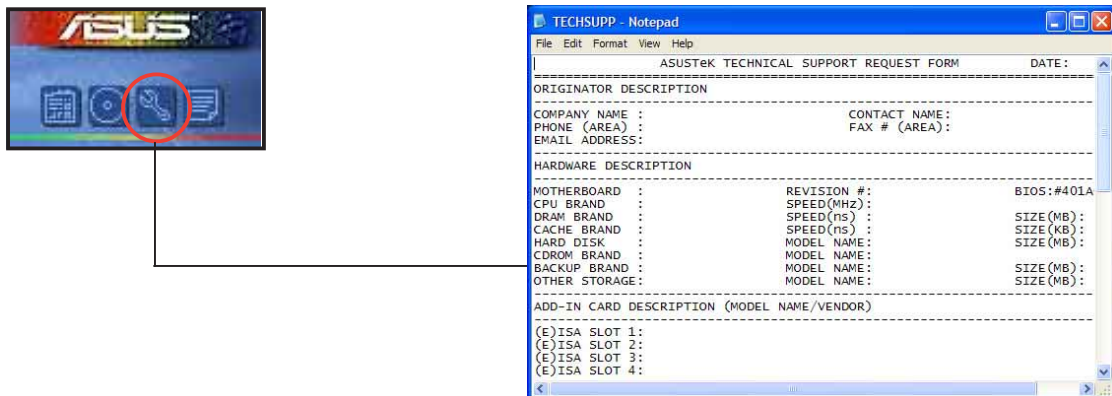

Filelist

Displays the contents of the support CD and a brief description of each in text format.

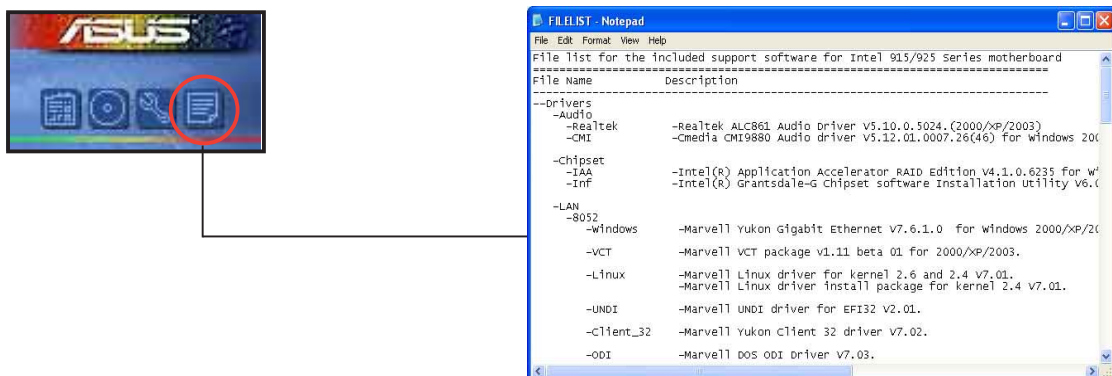

5.3 Software information

Most of the applications in the support CD have wizards that will conveniently guide you through the installation. View the online help or readme file that came with the software application for more information.

5.3.1 ASUS MyLogo™

The ASUS MyLogo™ utility lets you customize the boot logo. The boot logo is the image that appears on screen during the Power-On-Self-Tests (POST). The ASUS MyLogo™ is automatically installed when you install the **ASUS Update** utility from the support CD. See section “5.2.3 Utilities menu” for details.



- Before using the ASUS MyLogo™, use the AFUDOS utility to make a copy of your original BIOS file, or obtain the latest BIOS version from the ASUS website. See section “4.1.2 AFUDOS utility”.
- Make sure that the BIOS item **Full Screen Logo** is set to [Enabled] if you wish to use ASUS MyLogo™. See section “4.6.2 Boot Settings Configuration”.
- You can create your own boot logo image in GIF, JPG, or BMP file formats.

To launch the ASUS MyLogo™:

1. Launch the ASUS Update utility. Refer to section “4.1.4 ASUS Update utility” for details.
2. Select **Options** from the drop down menu, then click **Next**.
3. Check the option **Launch MyLogo to replace system boot logo before flashing BIOS**, then click **Next**.
4. Select **Update BIOS from a file** from the drop down menu, then click **Next**.
5. When prompted, locate the new BIOS file, then click **Next**. The ASUS MyLogo window appears.
6. From the left window pane, select the folder that contains the image you intend to use as your boot logo.



7. When the logo images appear on the right window pane, select an image to enlarge by clicking on it.



8. Adjust the boot image to your desired size by selecting a value on the **Ratio** box.



9. When the screen returns to the ASUS Update utility, flash the original BIOS to load the new boot logo.
10. After flashing the BIOS, restart the computer to display the new boot logo during POST.

5.3.2 AI NET 2

The Marvell® Virtual Cable Tester™ (VCT) is a cable diagnostic utility that reports LAN cable faults and shorts using the Time Domain Reflectometry (TDR) technology. The VCT detects and reports open and shorted cables, impedance mismatches, pair swaps, pair polarity problems, and pair skew problems of up to 64 ns at one meter accuracy.

The VCT feature reduces networking and support costs through a highly manageable and controlled network system. This utility can be incorporated in the network systems software for ideal field support as well as development diagnostics.

Using the Virtual Cable Tester™

To use the the Marvell® Virtual Cable Tester™ utility:

1. Launch the VCT utility from the Windows® desktop by clicking **Start > All Programs > Marvell > Virtual Cable Tester**.
2. Click **Virtual Cable Tester** from the menu to display the screen below.

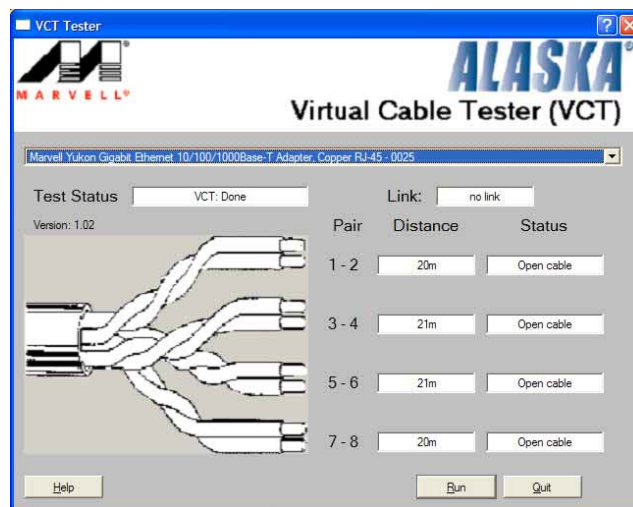

3. Click the **Run** button to perform a cable test.



- The VCT only runs on systems with Windows® XP or Windows® 2000 operating systems.
- The VCT utility only tests Ethernet cables connected to Gigabit LAN port(s).
- The **Run** button on the Virtual Cable Tester™ main window is disabled if no problem is detected on the LAN cable(s) connected to the LAN port(s).
- If you want the system to check the LAN cable before entering the OS, enable the **POST Check LAN cable** item in the BIOS.

5.3.3 Audio configurations

The Realtek® ALC861 High Definition Audio CODEC provides 8-channel audio capability to deliver the ultimate audio experience on your PC. The software provides Jack-Sensing function, S/PDIF out support and interrupt capability. The includes the Realtek® proprietary UAJ® (Universal Audio Jack) technology for three ports (Line-In, Line-Out and Mic-In), eliminating cable connection errors and giving users plug and play convenience. The utility is automatically installed when you install the Realtek Audio Driver from the motherboard support CD. Refer to section “5.2.2 Driver’s Menu”.

Launching the Realtek Sound Manager

From the Windows® taskbar, double-click the **Sound Effect** icon to display the **Realtek Sound Manager**.



Realtek
Sound Effect
icon

Using the Realtek® Sound Manager

The Realtek® Sound Manager has six menu options: Sound Effect, Speaker Configuration, 3D Audio Demo, General, SPDIF, and Audio Wizard. Click a button to display the details.

Sound Effect

The **Sound Effect** option allows you to set the environment, change the karaoke configuration, and adjust the equalizer settings. Click the **Sound Effect** button to display the following.



Environment. This section contains various pre-programmed environment settings. There are five featured materials that emulate the bathroom, an auditorium, sewer pipe, an arena, and underwater environments. Click the corresponding button to set an environment emulation. To set other environment emulations, click the combo list box and select from any of the environment settings.

Equalizer. The Equalizer section allows you to adjust the amplifier frequency. Use the 10-band equalizer to individually control the different frequency bands of your speaker system, or click a music style preset button to load a pre-defined equalizer setting. Click the corresponding control button to load, save, reset, or delete a user-defined preset.

Karaoke. The Karaoke section allows you to toggle the voice and adjust the pitch of the audio. Click the up or down arrows to adjust the pitch or the icon to toggle the voice.

Speaker Configuration

The **Speaker Configuration** option allows you to configure and test your speaker setup. Select your speaker setup to display the function of the front and back panel audio ports.



3D Audio Demo

The **3D Audio Demo** option shows a 3D audio demonstration with variable sound type, moving path and EAX settings. Click the **Play** or **Stop** button to start or stop the demo. Click the corresponding option button to adjust the sound type, moving path and EAX settings.



General

The **General** option displays your audio driver version, DirectX version, audio controller, and audio CODEC. Enable the option button to display the Sound Effect icon on the system tray. To change the language interface, click the combo list box and select from the list of supported languages.

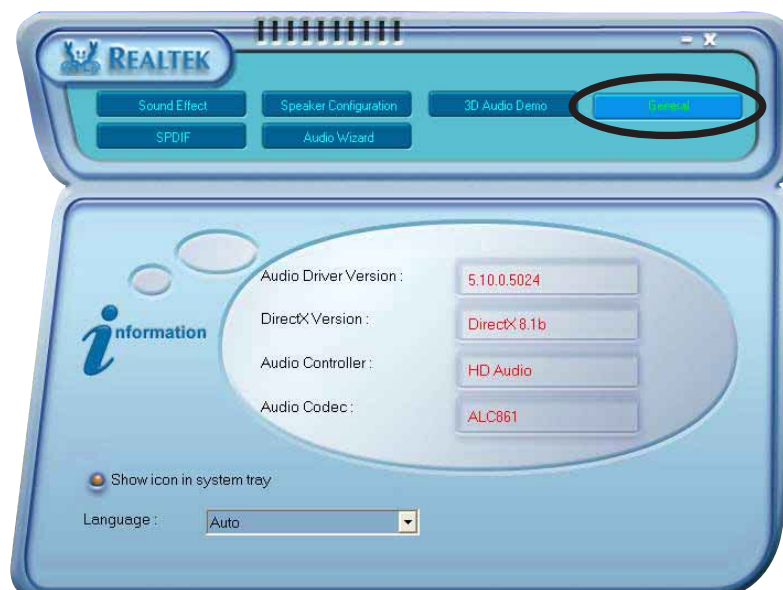

SPDIF

The **SPDIF** option allows you to set the S/PDIF output and change the S/PDIF output frequency. Click the option button of your choice.



Audio Wizard

The **Audio Wizard** guides you to the proper audio port for the device you plugged in. Click the **Front Panel** or **Back Panel** button to display their respective audio ports. Click **OK** when finished.



- The front panel audio connectors support both the Realtek® Jack-sensing and UAJ® technology features.
- The Back Panel audio connectors support the Realtek® Jack-sensing function only.

Rear panel audio ports function variation

The functions of the Line Out (lime), Line In (blue), Mic (pink), Rear Speaker Out (gray), Side Speaker Out (black), and Center/Subwoofer (yellow orange) ports on the rear panel change when you select the 4-channel, 6-channel or 8-channel audio configuration as shown in the following table.

Audio 2, 4, 6, or 8-channel configuration

| Port | Headset 2-channel | 4-channel | 6-channel | 8-channel |
|---------------|----------------------|-------------------|-------------------|-------------------|
| Light Blue | Line In | Line In | Line In | Line In |
| Lime | Line Out | Front Speaker Out | Front Speaker Out | Front Speaker Out |
| Pink | Mic In | Mic In | Mic In | Mic In |
| Gray | • | Rear Speaker Out | Rear Speaker Out | Rear Speaker Out |
| Black | • | • | • | Side Speaker Out |
| Yellow Orange | • | • | Center/Subwoofer | Center/Subwoofer |

5.4 RAID configurations

The motherboard comes with the ITE® 8212F RAID controller that allows you to configure IDE and Serial ATA hard disk drives as RAID sets. The motherboard supports the following RAID configurations.

RAID 0 (*Data striping*) optimizes two identical hard disk drives to read and write data in parallel, interleaved stacks. Two hard disks perform the same work as a single drive but at a sustained data transfer rate, double that of a single disk alone, thus improving data access and storage. Use of two new identical hard disk drives is required for this setup.

RAID 1 (*Data mirroring*) copies and maintains an identical image of data from one drive to a second drive. If one drive fails, the disk array management software directs all applications to the surviving drive as it contains a complete copy of the data in the other drive. This RAID configuration provides data protection and increases fault tolerance to the entire system. Use two new drives or use an existing drive and a new drive for this setup. The new drive must be of the same size or larger than the existing drive.

RAID 0+1 is *data striping* and *data mirroring* combined without parity (redundancy data) having to be calculated and written. With the RAID 0+1 configuration you get all the benefits of both RAID 0 and RAID 1 configurations. Use four new hard disk drives or use an existing drive and three new drives for this setup.

JBOD (*Spanning*) stands for **Just a Bunch of Disks** and refers to hard disk drives that are not yet configured as a RAID set. This configuration stores the same data redundantly on multiple disks that appear as a single disk on the operating system. Spanning does not deliver any advantage over using separate disks independently and does not provide fault tolerance or other RAID performance benefits.



If you want to boot the system from a hard disk drive included in a created RAID set, copy first the RAID driver from the support CD to a floppy disk before you install an operating system to the selected hard disk drive. Refer to section “5.5 Creating a RAID driver disk” for details.

5.4.1 Installing hard disks

The motherboard supports Ultra DMA 133/100/66 and Serial ATA hard disk drives. For optimal performance, install identical drives of the same model and capacity when creating a disk array.

Installing Parallel ATA hard disks

To install IDE hard disks for a RAID configuration:

1. Set the jumpers of each hard disk as Master/Master or Slave/Slave.
2. Install the hard disks into the drive bays.
3. Connect the HDD signal cables.
4. Connect a 4-pin power cable to the power connector on each drive.

Installing Serial ATA (SATA) hard disks

To install the SATA hard disks for a RAID configuration:

1. Install the SATA hard disks into the drive bays.
2. Connect the SATA signal cables.
3. Connect a SATA power cable to the power connector on each drive.

5.4.2 ITE® 8212F RAID configurations

The ITE® 8212F IDE RAID controller supports RAID 0, RAID 1, RAID 0+1 and JBOD configurations. Use the IT8212 BIOS Setup Utility or the ATA RAID Manager application to configure a disk array.

Setting the BIOS RAID items

After installing the hard disk drives, make sure to set the necessary RAID items in the BIOS before setting your RAID configuration.

To set the BIOS RAID items:

1. Boot the system and press during the Power-On Self-Test (POST) to enter the BIOS Setup Utility.
2. From the **Advanced > Onboard Devices Configuration** menu in the BIOS, set the **ITE8212F Controller** item to RAID Mode.
3. Save your changes and exit Setup.

Entering the ITE® 8212F Setup Utility

To enter the ITE® 8212F Setup Utility:

1. Boot up your computer.
2. The ITE8212F controller scans for IDE devices attached on the IDE RAID ports. When prompted, press <Ctrl+F> or <Ctrl+E> to display the main menu of the utility.

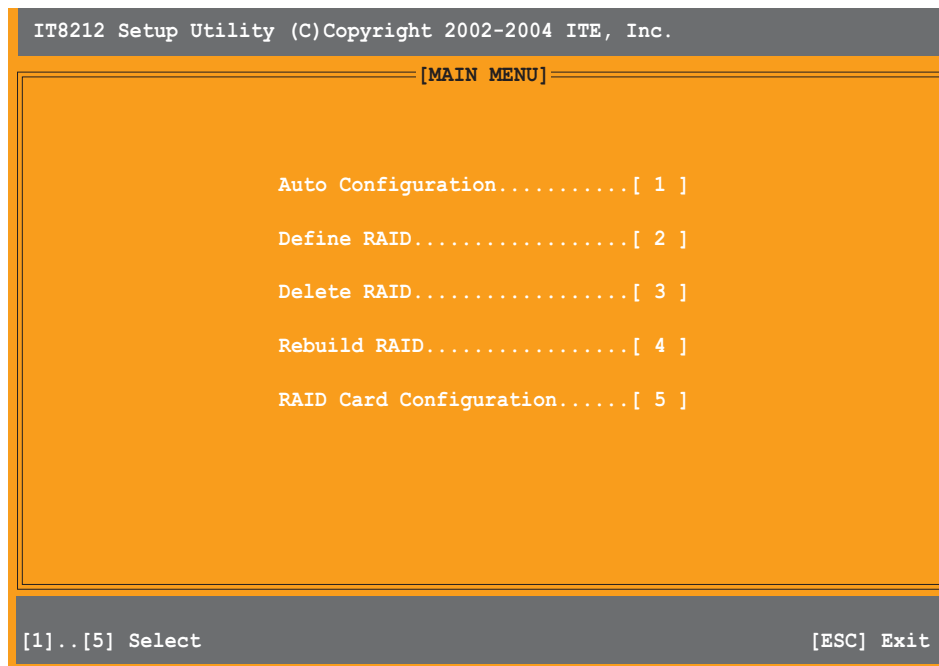

3. At the bottom of the screen are the navigation keys. These keys allow you to move through and select from the menu options.



4. Press the number of your selection or <Esc> to exit.

Auto-configuring a RAID array

This option allows you to select a supported RAID set for the utility to automatically configure.

To auto-configure a RAID set:

1. From the IT8212 Setup Utility screen, press <1>. The following screen appears.

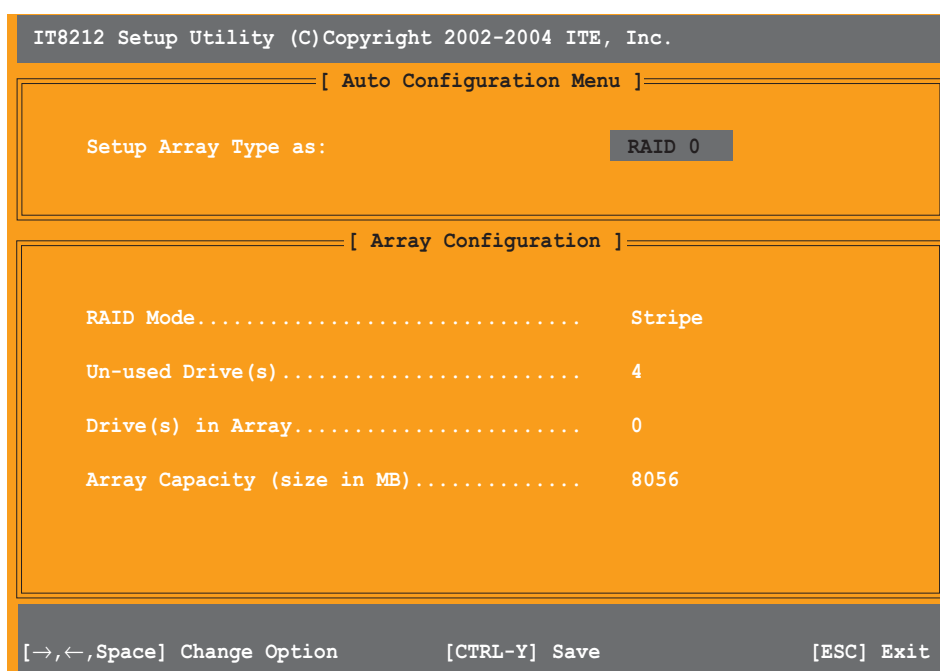

2. Use the left or right arrow keys or the space bar to select a RAID set. As you select an option, the screen displays the array configuration of the RAID based on the number of IDE devices installed.
3. Press <Ctrl+Y> to save your RAID set.
4. Press <Esc> to exit.

Defining a RAID array

This option allows you to define supported RAID arrays.

To define a RAID array:

1. From the IT8212 Setup Utility screen, press <2>. The following screen appears.

```
IT8212 Setup Utility (C)Copyright 2002-2004 ITE, Inc.
-----[ Define RAID Menu ]-----
  Array No      Array Mode      Drive No      Size (MB)      Status
-----
  Array 0       ----           ----          -----        -----
  Array 1       ----           ----          -----        -----
  Array 2       ----           ----          -----        -----
  Array 3       ----           ----          -----        -----

* : Capacity (GB)          ♦ : Bootable Array
[↑] Up    [↓] Down    [Space] Boot Array    [Enter] Select    [ESC] Exit
```

2. Use the up or down arrow keys or the space bar to select a RAID array, then press <Enter>. The following sub-menu appears.

```
IT8212 Setup Utility (C)Copyright 2002-2004 ITE, Inc.
-----[ Define RAID Sub-Menu ]-----
  Array No      Array Mode      Drive No      Status
-----
  Array 0       Stripe          4             Functional
  Block Size:   64KB

-----[ Drive Assignments ]-----
Channel
  ID   Drive Name      Size (MB)      Assignment
-----
Pri/D0 XXXXXXXXXXXXXXXX XXXXXX         Y
Pri/D1 XXXXXXXXXXXXXXXX XXXXXX         Y
Sec/D0 XXXXXXXXXXXXXXXX XXXXXX         Y
Sec/D1 XXXXXXXXXXXXXXXX XXXXXX         Y

* : Capacity (GB)
[↑] Up    [↓] Down    [Space] Change Option    [Ctrl-Y] Save    [ESC] Exit
```

3. Use the up or down arrow keys to select editable fields.
4. Use the Space bar to change field values.
5. Press <Ctrl+Y> to save RAID array.
6. Press <Esc> to exit.

Deleting a RAID array

This option allows you to delete an existing RAID array.

To delete a RAID array:

1. From the IT8212 Setup Utility screen, press <3>. The following screen appears.

| Array No | Array Mode | Drive No | Size (MB) | Status |
|----------|------------|----------|-----------|------------|
| Array 0 | Stripe | 2 | XXXXXX | Functional |
| Array 1 | Mirror | 2 | XXXX | Functional |
| Array 2 | ---- | ---- | ---- | ---- |
| Array 3 | ---- | ---- | ---- | ---- |

* : Capacity (GB) ♦ : Bootable Array
 [↑] Up [↓] Down [D] Delete [ESC] Exit

2. Use the up or down arrow keys to select a RAID array, then press <D> to delete.
3. Press <Esc> to exit.

Rebuilding a RAID array

This option allows you to reconstruct an existing RAID array. This option applies only to RAID1 (Mirrored) or RAID 0+1 (Striped+Mirrored) sets.

To rebuild a RAID array:

1. From the IT8212 Setup Utility screen, press <4>. The following screen appears.

```
IT8212 Setup Utility (C)Copyright 2002-2004 ITE, Inc.
----- [ Rebuild RAID Menu ] -----

```

| Array No | Array Mode | Drive No | Size (MB) | Status |
|----------|------------|----------|-----------|------------|
| Array 0 | Stripe | 4 | XXXXXX | Functional |
| Array 1 | Mirror | 2 | XXXX | Functional |
| Array 2 | ---- | ---- | ---- | ---- |
| Array 3 | ---- | ---- | ---- | ---- |

```

* : Capacity (GB)                               ♦ : Bootable Array
[↑] Up                                           [↓] Down
[Enter] Select                                  [ESC] Exit

```

2. Use the up or down arrow keys to select a RAID array, then press <Enter> to rebuild. The following screen appears.

```
IT8212 Setup Utility (C)Copyright 2002-2004 ITE, Inc.
----- [ Source Drive ] -----

```

| Channel ID | Drive Name | Size (MB) |
|------------|------------|-----------|
| Pri/D1 | XXXXXXXXXX | XXXXX |

```

----- [ Target Drive ] -----

```

| Channel ID | Drive Name | Size (MB) |
|------------|------------|-----------|
| Sec/D1 | XXXXXXXXXX | XXXXX |

```

----- [ Drive List ] -----

```

| Channel ID | Drive Name | Size (MB) |
|------------|------------|-----------|
| Pri/D1 | XXXXXXXXXX | XXXXX |
| Sec/D1 | XXXXXXXXXX | XXXXX |

```

* : Capacity (GB)
[↑] Up                                           [↓] Down
[Enter] Select                                  [ESC] Exit

```



- Use the up or down arrow keys to select a drive, then press <Enter>. Follow succeeding screen instructions.
- Press <Esc> to exit.

Viewing your RAID configuration

This option allows you to view your RAID configuration. You can also enable or disable the Auto-rebuild function in this section.

To view your RAID configuration:

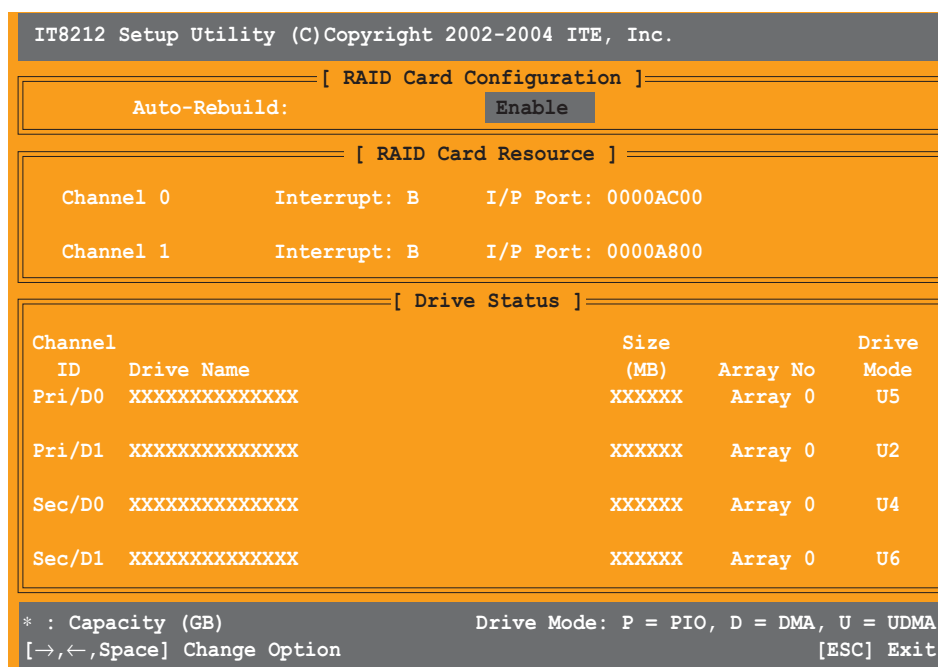
- From the IT8212 Setup Utility screen, press <5>. The following screen appears.



- Use the left or right keys or the space bar enable or disable the **Auto-rebuild** item.
- Press <Esc> to exit.

5.5 Creating a RAID driver disk

A floppy disk with the RAID driver is required when installing Windows® 2000/XP operating system on a hard disk drive that is included in a RAID set.

To create a RAID driver disk:

1. Place the motherboard support CD into the CD-ROM drive.
2. When the **Drivers** menu appears, select the RAID driver disk you want to create:
 - Click **Make ITE8212 Driver** to create an ITE® 8212F RAID driver disk.

Or

Browse the contents of the support CD to locate the driver disk utility.

- Go to **\Drivers\ITE8212\Makedisk.exe** for the ITE® 8212F RAID driver disk utility



Refer to section “5.2.2 Drivers menu” for details.

4. Insert a formatted high-density floppy disk to the floppy disk drive.
5. Follow succeeding screen information to complete process.
6. After creating a RAID driver disk, eject the floppy disk, then write-protect it to prevent computer virus infection.

To install the RAID driver:

1. Install an operating system to the selected hard disk drive. During installation, the computer prompts you to press the **F6** key if you want to install a third-party SCSI or RAID driver.
2. Press <F6> then insert the RAID driver disk into the floppy disk drive.
3. Follow the succeeding screen instructions to complete the installation.