

P4P800

User Guide

ASUS[®]

Motherboard

E1226

First Edition V1

April 2003

Copyright © 2003 ASUSTeK COMPUTER INC. All Rights Reserved.

No part of this manual, including the products and software described in it, may be reproduced, transmitted, transcribed, stored in a retrieval system, or translated into any language in any form or by any means, except documentation kept by the purchaser for backup purposes, without the express written permission of ASUSTeK COMPUTER INC. ("ASUS").

Product warranty or service will not be extended if: (1) the product is repaired, modified or altered, unless such repair, modification or alteration is authorized in writing by ASUS; or (2) the serial number of the product is defaced or missing.

ASUS PROVIDES THIS MANUAL "AS IS" WITHOUT WARRANTY OF ANY KIND, EITHER EXPRESS OR IMPLIED, INCLUDING BUT NOT LIMITED TO THE IMPLIED WARRANTIES OR CONDITIONS OF MERCHANTABILITY OR FITNESS FOR A PARTICULAR PURPOSE. IN NO EVENT SHALL ASUS, ITS DIRECTORS, OFFICERS, EMPLOYEES OR AGENTS BE LIABLE FOR ANY INDIRECT, SPECIAL, INCIDENTAL, OR CONSEQUENTIAL DAMAGES (INCLUDING DAMAGES FOR LOSS OF PROFITS, LOSS OF BUSINESS, LOSS OF USE OR DATA, INTERRUPTION OF BUSINESS AND THE LIKE), EVEN IF ASUS HAS BEEN ADVISED OF THE POSSIBILITY OF SUCH DAMAGES ARISING FROM ANY DEFECT OR ERROR IN THIS MANUAL OR PRODUCT.

SPECIFICATIONS AND INFORMATION CONTAINED IN THIS MANUAL ARE FURNISHED FOR INFORMATIONAL USE ONLY, AND ARE SUBJECT TO CHANGE AT ANY TIME WITHOUT NOTICE, AND SHOULD NOT BE CONSTRUED AS A COMMITMENT BY ASUS. ASUS ASSUMES NO RESPONSIBILITY OR LIABILITY FOR ANY ERRORS OR INACCURACIES THAT MAY APPEAR IN THIS MANUAL, INCLUDING THE PRODUCTS AND SOFTWARE DESCRIBED IN IT.

Products and corporate names appearing in this manual may or may not be registered trademarks or copyrights of their respective companies, and are used only for identification or explanation and to the owners' benefit, without intent to infringe.

Contents

FCC/CDC statements	vi
Safety information	vii
About this guide	viii
How this guide is organized	viii
Conventions used in this guide	ix
Where to find more information	ix
ASUS contact information	x
P4P800 specifications summary	xi

Chapter 1: Product introduction

1.1 Welcome!	1-1
1.2 Package contents	1-1
1.3 Special features	1-2
1.3.1 Product highlights	1-2
1.3.2 Value-added solutions	1-6
1.4 Motherboard overview	1-7
1.4.1 Major components	1-7
1.4.2 Core specifications	1-8

Chapter 2: Hardware information

2.1 Motherboard installation	2-1
2.1.1 Placement direction	2-1
2.1.2 Screw holes	2-1
2.2 Motherboard layout	2-2
2.3 Before you proceed	2-3
2.4 Central Processing Unit (CPU)	2-4
2.4.1 Overview	2-4
2.4.2 Installing the CPU	2-5
2.4.3 Installing the heatsink and fan	2-7
2.4.4 Connecting the CPU fan cable	2-9
2.5 System memory	2-10
2.5.1 Overview	2-10
2.5.2 Memory configurations	2-11
2.5.3 Installing a DIMM	2-14
2.5.4 Removing a DIMM	2-14
2.6 Expansion slots	2-15
2.6.1 Installing an expansion card	2-15
2.6.2 Configuring an expansion card	2-15
2.6.3 PCI slots	2-17
2.6.4 AGP slot	2-18
2.6.5 WiFi slot	2-19
2.7 Jumpers	2-20
2.8 Connectors	2-23

Contents

Chapter 3: Powering up

3.1	Starting up for the first time	3-1
3.2	Vocal POST Messages	3-2
3.3	Powering off the computer	3-4

Chapter 4: BIOS setup

4.1	Managing and updating your BIOS	4-1
4.1.1	Creating a bootable floppy disk	4-1
4.1.2	Using AFUDOS to update the BIOS	4-1
4.1.3	Using ASUS EZ Flash to update the BIOS	4-3
4.1.4	Recovering the BIOS with CrashFree BIOS 2	4-4
4.2	BIOS Setup program	4-6
4.2.1	BIOS menu screen	4-7
4.2.2	Menu bar	4-7
4.2.3	Navigation keys	4-7
4.2.4	Menu items	4-8
4.2.5	Sub-menu items	4-8
4.2.6	Configuration fields	4-8
4.2.7	Pop-up window	4-8
4.2.8	Scroll bar	4-8
4.2.9	General help	4-8
4.3	Main menu	4-9
4.3.1	System Time [xx:xx:xxxx]	4-9
4.3.2	System Date [Day xx/xx/xxxx]	4-9
4.3.3	Legacy Diskette A [1.44M, 3.5 in.]	4-9
4.3.4	Language [English]	4-9
4.3.5	Primary and Secondary IDE Master/Slave; Third and Fourth IDE Master	4-10
4.3.6	IDE Configuration	4-11
4.3.7	System Information	4-13
4.4	Advanced menu	4-14
4.4.1	JumperFree Configuration	4-14
4.4.2	CPU Configuration	4-17
4.4.3	Chipset	4-17
4.4.4	Onboard Devices Configuration	4-19
4.4.5	PCI PnP	4-21
4.4.6	USB Configuration	4-22
4.4.7	Instant Music Configuration	4-24
4.5	Power menu	4-25
4.5.1	Suspend Mode [Auto]	4-25
4.5.2	Repost Video on S3 Resume [No]	4-25
4.5.3	ACPI 2.0 Support [No]	4-25
4.5.4	ACPI APIC Support [Enabled]	4-25
4.5.5	BIOS -> AML ACPI Table [Enabled]	4-25

Contents

4.5.6	APM Configuration	4-26
4.5.7	Hardware Monitor	4-28
4.6	Boot menu	4-30
4.6.1	Boot Device Priority	4-30
4.6.2	Hard disk drives	4-31
4.6.3	Boot Settings Configuration	4-31
4.6.4	Security	4-33
4.7	Exit menu	4-35

Chapter 5: Software support

5.1	Install an operating system	5-1
5.2	Support CD information	5-1
5.2.1	Running the support CD	5-1
5.2.2	Drivers menu	5-2
5.2.3	Utilities menu	5-3
5.2.4	ASUS Contact Information	5-4
5.2.5	Other information	5-5
5.3	Software information	5-7
5.3.1	ASUS Update	5-7
5.3.2	ASUS MyLogo2™	5-8
5.3.3	ASUS PC Probe	5-10
5.3.4	ASUS Instant Music	5-14
5.3.5	SoundMAX® 4 XL software	5-17
5.4	Intel® RAID for Serial ATA configurations	5-21
5.4.1	BIOS Configuration	5-21
5.4.2	Installing Serial ATA hard disks	5-21
5.4.3	Creating, Deleting and Resetting RAID sets	5-22
5.4.4	Creating a RAID Volume	5-22
5.4.5	Deleting a RAID Volume	5-23
5.4.6	Reset RAID Data	5-24
5.5	3COM® Virtual Cable Tester™ (VCT) Technology	5-25

FCC/CDC statements

Federal Communications Commission Statement

This device complies with FCC Rules Part 15. Operation is subject to the following two conditions:

- This device may not cause harmful interference, and
- This device must accept any interference received including interference that may cause undesired operation.

This equipment has been tested and found to comply with the limits for a Class B digital device, pursuant to Part 15 of the FCC Rules. These limits are designed to provide reasonable protection against harmful interference in a residential installation. This equipment generates, uses and can radiate radio frequency energy and, if not installed and used in accordance with manufacturer's instructions, may cause harmful interference to radio communications. However, there is no guarantee that interference will not occur in a particular installation. If this equipment does cause harmful interference to radio or television reception, which can be determined by turning the equipment off and on, the user is encouraged to try to correct the interference by one or more of the following measures:

- Reorient or relocate the receiving antenna.
- Increase the separation between the equipment and receiver.
- Connect the equipment to an outlet on a circuit different from that to which the receiver is connected.
- Consult the dealer or an experienced radio/TV technician for help.



The use of shielded cables for connection of the monitor to the graphics card is required to assure compliance with FCC regulations. Changes or modifications to this unit not expressly approved by the party responsible for compliance could void the user's authority to operate this equipment.

Canadian Department of Communications Statement

This digital apparatus does not exceed the Class B limits for radio noise emissions from digital apparatus set out in the Radio Interference Regulations of the Canadian Department of Communications.

This class B digital apparatus complies with Canadian ICES-003.

Safety information

Electrical safety

- To prevent electrical shock hazard, disconnect the power cable from the electrical outlet before relocating the system.
- When adding or removing devices to or from the system, ensure that the power cables for the devices are unplugged before the signal cables are connected. If possible, disconnect all power cables from the existing system before you add a device.
- Before connecting or removing signal cables from the motherboard, ensure that all power cables are unplugged.
- Seek professional assistance before using an adapter or extension cord. These devices could interrupt the grounding circuit.
- Make sure that your power supply is set to the correct voltage in your area. If you are not sure about the voltage of the electrical outlet you are using, contact your local power company.
- If the power supply is broken, do not try to fix it by yourself. Contact a qualified service technician or your retailer.

Operation safety

- Before installing the motherboard and adding devices on it, carefully read all the manuals that came with the package.
- Before using the product, make sure all cables are correctly connected and the power cables are not damaged. If you detect any damage, contact your dealer immediately.
- To avoid short circuits, keep paper clips, screws, and staples away from connectors, slots, sockets and circuitry.
- Avoid dust, humidity, and temperature extremes. Do not place the product in any area where it may become wet.
- Place the product on a stable surface.
- If you encounter technical problems with the product, contact a qualified service technician or your retailer.

About this guide

This user guide contains the information you need when installing the ASUS P4P800 motherboard.

How this guide is organized

This manual contains the following parts:

- **Chapter 1: Product introduction**
This chapter describes the features of the P4P800 motherboard. It includes brief descriptions of the special attributes of the motherboard and the new technology it supports.
- **Chapter 2: Hardware information**
This chapter lists the hardware setup procedures that you have to perform when installing system components. It includes description of the switches, jumpers, and connectors on the motherboard.
- **Chapter 3: Powering up**
This chapter describes the power up sequence and gives information on the BIOS beep codes.
- **Chapter 4: BIOS setup**
This chapter tells how to change system settings through the BIOS Setup menus. Detailed descriptions of the BIOS parameters are also provided.
- **Chapter 5: Software support**
This chapter describes the contents of the support CD that comes with the motherboard package.

Conventions used in this guide

To make sure that you perform certain tasks properly, take note of the following symbols used throughout this manual.



WARNING: Information to prevent injury to yourself when trying to complete a task.



CAUTION: Information to prevent damage to the components when trying to complete a task.



IMPORTANT: Information that you **MUST** follow to complete a task.



NOTE: Tips and additional information to aid in completing a task.

Where to find more information

Refer to the following sources for additional information and for product and software updates.

1. ASUS Websites

The ASUS websites worldwide provide updated information on ASUS hardware and software products. The ASUS websites are listed in the ASUS Contact Information on page x.

2. Optional Documentation

Your product package may include optional documentation, such as warranty flyers, that may have been added by your dealer. These documents are not part of the standard package.

ASUS contact information

ASUSTeK COMPUTER INC. (Asia-Pacific)

Address: 150 Li-Te Road, Peitou, Taipei, Taiwan 112
General Tel: +886-2-2894-3447
General Fax: +886-2-2894-3449
General Email: info@asus.com.tw

Technical Support

MB/Others (Tel): +886-2-2890-7121 (English)
Notebook (Tel): +886-2-2890-7122 (English)
Desktop/Server (Tel): +886-2-2890-7123 (English)
Support Fax: +886-2-2890-7698
Web Site: www.asus.com.tw

ASUS COMPUTER INTERNATIONAL (America)

Address: 44370 Nobel Drive, Fremont, CA 94538, USA
General Fax: +1-510-608-4555
General Email: tmd1@asus.com

Technical Support

Support Fax: +1-510-608-4555
General Support: +1-510-739-3777
Web Site: www.asus.com
Support Email: tsd@asus.com

ASUS COMPUTER GmbH (Germany and Austria)

Address: Harkortstr. 25, 40880 Ratingen, BRD, Germany
General Fax: +49-2102-9599-31
General Email: sales@asuscom.de (for marketing requests only)

Technical Support

Support Hotline: MB/Others: +49-2102-9599-0
Support Fax: +49-2102-9599-11
Support (Email): www.asuscom.de/kontakt (for online support)
Web Site: www.asuscom.de

P4P800 specifications summary

CPU	Socket 478 for Intel® Pentium® 4 up to 3.2 GHz+ Supports Intel® Hyper-Threading Technology Supports Intel® Prescott CPU
Chipset	North Bridge: Intel 82865PE South Bridge: Intel ICH5R w/ RAID 0 support
Front Side Bus (FSB)	800/533/400 MHz
Memory	4 x 184-pin DDR DIMM sockets for up to 4GB memory Max 4GB unbuffered PC3200/2700/2100 non-ECC DDR Dual channel memory architecture
Expansion slots	1 x AGP 8X (1.5V only) 5 x PCI 1 x WiFi slot
Storage	Supported by South Bridge (ICH5R) - 2 x UltraDMA100 support for 4 drives - 2 x Serial ATA with RAID 0 function
AI Audio	ADI AD1985 6-channel audio CODEC 1 x S/PDIF out
AI Net	3COM 3C940 Gbit PCI controller
ASUS BIOS Features	ASUS CrashFree BIOS 2 ASUS Q-Fan Technology
AI Overclocking	Intelligent CPU frequency tuner ASUS JumperFree Adjustable CPU V _{CORE} , memory and AGP voltages SFS (Stepless Frequency Selection) from 100MHz to 400MHz at 1MHz increments C.P.R. (CPU Parameter Recall)
Special features	ASUS MyLogo 2 Instant Music ASUS EZ Flash Multi-language BIOS

(continued on the next page)

P4P800 specifications summary

Back I/O Panel	1 x Parallel port 1 x Serial ports 1 x PS/2 keyboard port 1 x PS/2 mouse port 4 x USB 2.0/USB 1.1 ports 1 x RJ-45 port (optional) 1 x S/PDIF-out port Line In/Line Out/Microphone ports
Internal I/O	2 x USB 2.0/1.1 connector for 4 additional USB ports CPU/Chassis/Power fan connectors 20-pin/4-pin ATX 12V power connectors Chassis intrusion GAME connector S/PDIF out connector CD/AUX/Modem audio connectors Front panel audio connector
BIOS features	4Mb Flash ROM, AMI BIOS, PnP, DMI2.0, ACPI, SM BIOS2.3, CrashFree BIOS 2, Multi-language BIOS, ASUS EZ Flash, ASUS MyLogo2, ASUS Instant Music
Industry standard	PCI 2.3, USB 2.0
Manageability	DMI 2.0, WOL/WOR by PME, WO_USB, WO_KB/MS, chassis intrusion
Form Factor	ATX form factor: 12 in x 9.6 in
Support CD contents	Device drivers ASUS PC Probe ASUS LiveUpdate Trend Micro™ PC-cillin 2002 anti-virus software

* Specifications are subject to change without notice.

Chapter 1

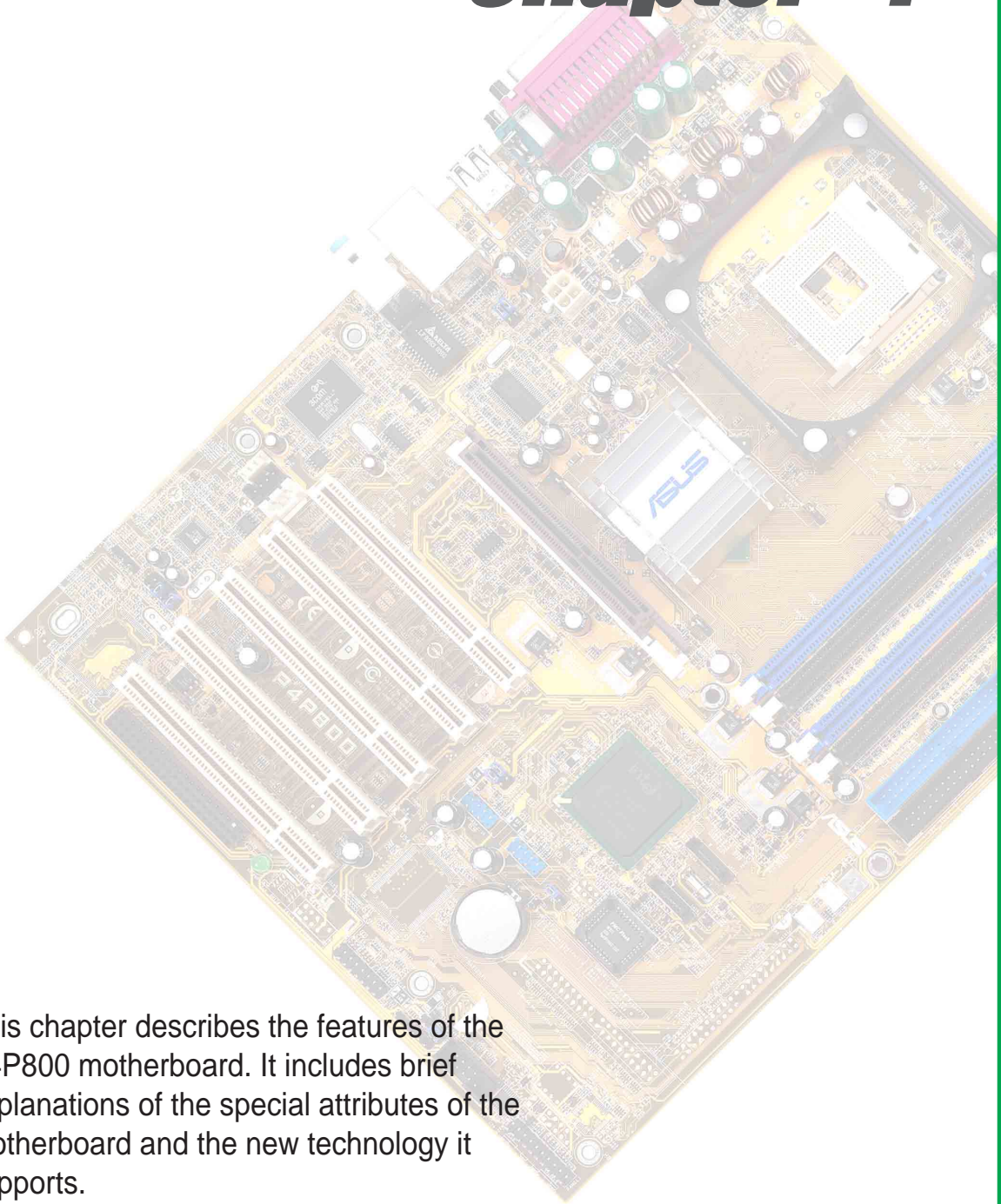

This chapter describes the features of the P4P800 motherboard. It includes brief explanations of the special attributes of the motherboard and the new technology it supports.

Product introduction

Chapter summary

1.1	Welcome!	1-1
1.2	Package contents	1-1
1.3	Special features	1-2
1.4	Motherboard overview	1-7

1.1 Welcome!

Thank you for buying the ASUS® P4P800 motherboard!

The ASUS P4P800 motherboard delivers a host of new features and latest technologies making it another standout in the long line of ASUS quality motherboards!

The P4P800 incorporates the Intel® Pentium® 4 Processor in 478-pin package coupled with Intel® 82865PE and ICH5R chipsets that support the fastest 800MHz FSB to set a new benchmark for an effective desktop platform solution.

Supporting up to 4GB of system memory with PC3200/2700/2100 DDR SDRAM, high-resolution graphics via an AGP 8X slot, Serial ATA support, USB 2.0, and 6-channel audio features, the P4P800 is your perfect tool to get ahead in the world of power computing!

Before you start installing the motherboard, and hardware devices on it, check the items in your package with the list below.

1.2 Package contents

Check your P4P800 package for the following items.

- ✓ ASUS P4P800 motherboard
- ✓ ASUS support CD
- ✓ 2 x SATA cable
- ✓ 80-conductor ribbon cables for UltraDMA/66/100 IDE drives
- ✓ 40-conductor IDE cable
- ✓ Ribbon cable for a 3.5-inch floppy drive
- ✓ I/O shield
- ✓ Bag of extra jumper caps
- ✓ User Guide
- ✓ Reference Card (last page of User Guide)
- ✓ Quick Setup Guide (retail boxes only)
- ✓ Jumpers and Connectors Sticker (retail boxes only)
- ✓ Instant Music keyboard label (retail boxes only)



If any of the above items is damaged or missing, contact your retailer.

1.3 Special features

1.3.1 Product highlights

Latest processor technology

The P4P800 motherboard supports the latest Intel® Pentium® 4 Processor via a 478-pin surface mount ZIF socket. The Pentium 4 processor with 512KB L2 cache on 0.13 micron processor includes a 800/533/400 MHz system bus and the FMB2 power design that allows up to 3.06+ GHz core frequencies and Intel® future Prescott CPU.

Dual Channel DDR memory support

Employing the dual channel Double Data Rate (DDR) memory architecture, the P4P800 motherboard supports up to 4GB of system memory using PC3200/2700/PC2100 DDR DIMMs. The ultra-fast 400MHz memory bus double the bandwidth to a maximum of 6.4GB/s that delivers the required bandwidth for the latest 3D graphics, multimedia, and Internet applications. See page 2-10.

Serial ATA solution, RAID 0 support

The motherboard supports two interfaces compliant to the Serial ATA (SATA) specification, an evolutionary replacement of the Parallel ATA storage interface. The Serial ATA specification allows for thinner, more flexible cables with lower pin count, reduced voltage requirement, up to 150 MB/s data transfer rate. With the SATA support built-in Intel® ICH5R controller onboard, the motherboard supports RAID 0 configuration using SATA drives.

Ai NET solution

The Ai Series supports Gigabit LAN by integrating the 3COM 3C940 controller, equipped with a unique net-diagnosing utility - VCT (Virtual Cable Tester). VCT intelligently diagnoses and reports cable faults from a remote location up to 100 meters and helps users improve network quality.

AGP 8X support

AGP 8X (AGP 3.0) is the next generation VGA interface specification that enables enhanced graphics performance with high bandwidth speeds up to 2.12 GB/s.

Ai Audio solution

The SoundMAX-class ADI AD1985 AC '97 audio CODEC supports 6-channel 5.1 surround sound output, stereo microphone input, variable sample rate conversion (SRC), professional quality 103-dB out put with 94-dB SNR, and analog enumeration capability. The SoundMAX 4 XL software features the AudioESP™ (Audio Enumeration and Sensing Process) that allows intelligent detection of the peripherals plugged into the audio ports and identifies the incompatible devices, if any.

USB 2.0 technology

The motherboard implements the new Universal Serial Bus (USB) 2.0 specification, extending the connection speed from 12 Mbps on USB 1.1 to a fast 480 Mbps on USB 2.0 - supporting up to 8 USB 2.0 ports. The higher bandwidth of USB 2.0 allows connection of devices such as high resolution video conferencing cameras, next generation scanners and printers, and fast storage units. USB 2.0 is backward compatible with USB 1.1. See page 2-30.

C.P.R. (CPU Parameter Recall)

The C.P.R. feature of the motherboard BIOS allows automatic re-setting to the BIOS default settings in case the system hangs due to overclocking. When the system hangs due to overclocking, C.P.R. eliminates the need to open the system chassis and clear the RTC data. Simply shut down and reboot the system, and BIOS automatically restores the CPU default setting for each parameter.

ASUS MyLogo2™

This new feature present in the P4P800 motherboard allows you to personalize and add style to your system with customizable boot logos. See details on page 5-8.

ASUS Multi-language BIOS

The multi-language BIOS allows you to select the language of your choice from the available options. The localized BIOS menus allow you to configure easier and faster. Visit the ASUS website for information on the supported languages.

ASUS EZ Flash BIOS

With the ASUS EZ Flash, you can easily update the system BIOS even before loading the operating system. No need to use a DOS-based utility or boot from a floppy disk. See details on page 4-3.

ASUS Q-Fan technology

The ASUS Q-Fan technology smartly adjusts the fan speeds according to the system loading to ensure quiet, cool, and efficient operation.

CrashFree BIOS 2

This feature allows you to restore the original BIOS data from the ASUS support CD in case when the BIOS codes and data are corrupted. This protection eliminates the need to buy a replacement ROM chip. See details on page 4-4.

ASUS J-Panel

This optional device is designed for ASUS motherboards with USB, S/PDIF or Intel Front Panel audio connector for additional front I/O connectors.

Instant Music

This unique feature allows you to playback audio files even without booting the system to Windows™. Just press the ASUS Instant Music special function keys and enjoy the music! See details on page 5-14.

1.3.2 Value-added solutions

Overclocking

- adjustable CPU frequency multiple in BIOS using the ASUS JumperFree™ solution
- C.P.R. (CPU Parameter Recall)
- adjustable CPU V_{CORE} , and DDR memory and AGP voltages
- Stepless Frequency Selection (SFS) for fine-tuning system bus frequency from 100MHz up to 400MHz at 1MHz increments

Temperature, fan, and voltage monitoring

The CPU temperature is monitored by the ASUS ASIC to prevent overheating and damage. The system fan rotations per minute (RPM) is monitored for timely failure detection. The system voltage levels are monitored to ensure stable supply of current for critical components.

Chassis intrusion detection

The motherboard supports chassis intrusion monitoring through the Winbond ASIC. A chassis intrusion event is retained in CMOS for more protection.

ASUS update

This utility allows you to update the motherboard BIOS through a user-friendly interface. Connect to the Internet then to the ASUS FTP site nearest you to obtain the latest BIOS version for your motherboard.

1.4 Motherboard overview

Before you install the P4P800 motherboard, familiarize yourself with its physical configuration and available features to facilitate the motherboard installation and future upgrades. A sufficient knowledge of the motherboard specifications will also help you avoid mistakes that may damage the board and its components.

1.4.1 Major components

The following are the major components of the P4P800 motherboard as pointed out in the picture on page 1-7.

1. ATX 12V connector
2. CPU socket
3. North Bridge controller
4. DDR DIMM sockets
5. ATX Power connector
6. Super I/O controller
7. Floppy disk connector
8. IDE connectors
9. AGP slot
10. Serial ATA connectors
11. Flash ROM
12. South Bridge controller
13. Standby Power LED
14. WiFi slot
15. PCI slots
16. Audio CODEC
17. Gigabit LAN controller
18. PS/2 Mouse
19. Parallel port
20. RJ-45 port
21. Line In jack
22. Line Out jack
23. Microphone jack
24. USB 2.0 ports 3 and 4
25. USB 2.0 ports 1 and 2
26. Serial port
27. S/PDIF output port
28. Keyboard port



See page 1-8 for the specifications of each component. Refer to Chapter 2 for detailed information on the components.

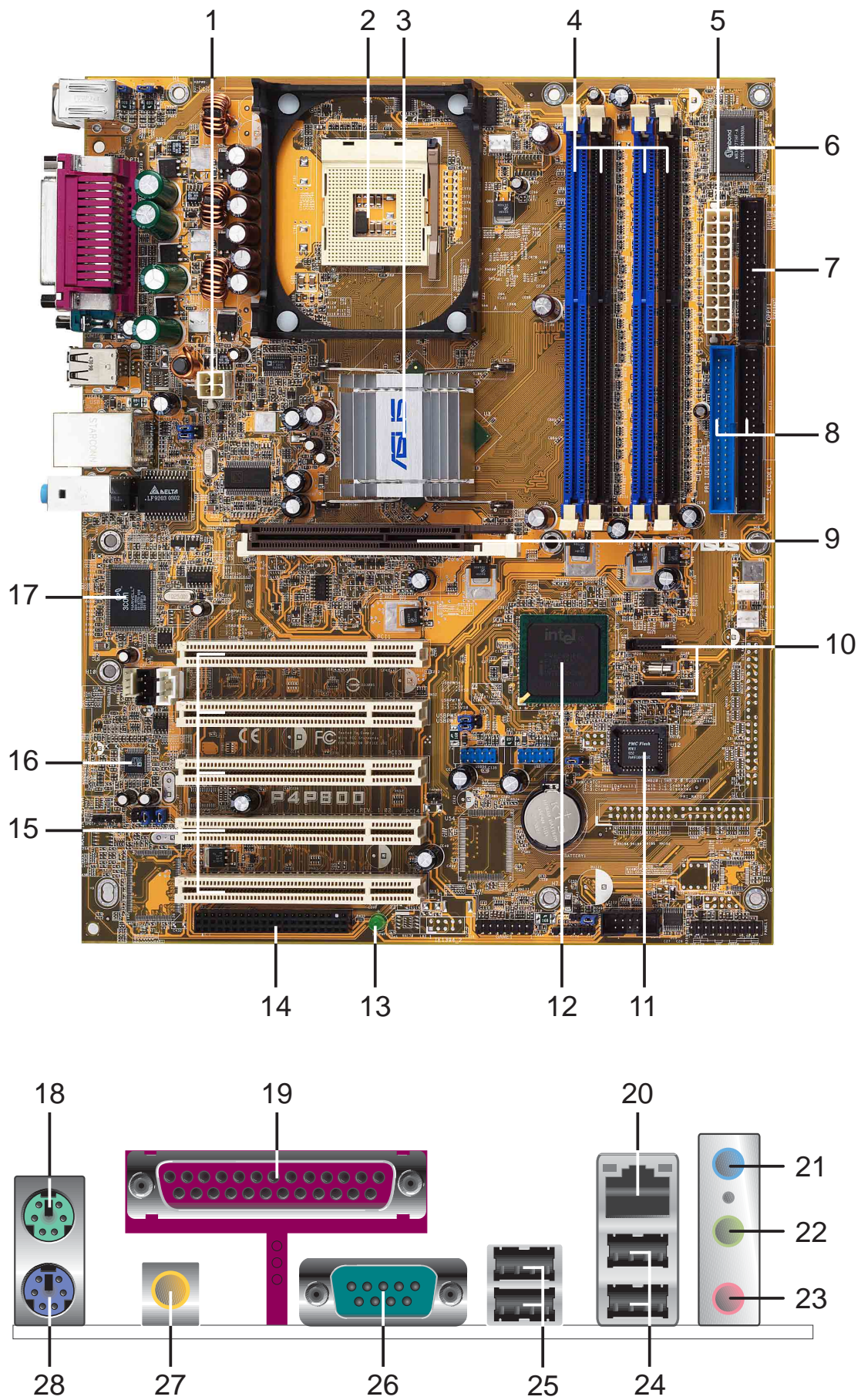

1.4.2 Core specifications

- 1 ATX 12V connector.** This power connector connects the 4-pin 12V plug from the ATX 12V power supply.
- 2 CPU socket.** A 478-pin surface mount, Zero Insertion Force (ZIF) socket for the Intel® Pentium® 4 Processor (and Intel's future Prescott CPU) support with 800/533/400 MHz system bus that allows up to 6.4GB/s data transfer rates.
- 3 North bridge controller.** The Intel® 82865PE Memory Controller Hub (MCH) provides the processor interface with 800/533/400 MHz frequency, system memory interface at 400/333/266MHz operation, and 1.5V AGP interface that supports AGP 3.0 specification including 8X Fast Write protocol.
- 4 DDR DIMM sockets.** These four 184-pin DIMM sockets support up to 4GB system memory using unbuffered non-ECC PC3200/2700/2100 DDR DIMMs.
- 5 ATX power connector.** This 20-pin connector connects to an ATX +12V power supply. The power supply must have at least 1A on the +5V standby lead (+5VSB).
- 6 Super I/O controller.** The Winbond 83627THF Low Pin Count (LPC) interface provides the commonly used Super I/O functionality. The chipset supports a high-performance floppy disk controller for a 360K/720K/1.44M/2.88M floppy disk drive, a multi-mode parallel port, two serial ports, a GAME port, the mouse and keyboard interface and the LPC (Low Pin Count) interface.
- 7 Floppy disk connector.** This connector accommodates the provided ribbon cable for the floppy disk drive. One side of the connector is slotted to prevent incorrect insertion of the floppy disk cable.
- 8 IDE connectors.** These dual-channel bus master IDE connectors support Ultra DMA100/66, PIO Modes 3 & 4 IDE devices. Both the primary (blue) and secondary (black) connectors are slotted to prevent incorrect insertion of the IDE ribbon cable.
- 9 AGP slot.** This Accelerated Graphics Port (AGP) slot supports 1.5V AGP8X mode graphics cards for 3D graphical applications.
- 10 Serial ATA connectors.** These two 7-pin connectors accommodate the thin cables for Serial ATA devices.

- 11 Flash ROM.** This 4Mb firmware contains the programmable BIOS program.
- 12 South bridge controller.** The Intel® ICH5R is a subsystem that integrates various I/O functions including 2-channel ATA100 bus master IDE controller, SATA RAID controller, up to eight USB 2.0/1.1 ports, I/O APIC, AC'97 2.2 interface, and PCI 2.3 interface.
- 13 Standby power LED.** This LED lights up if there is a standby power on the motherboard. This LED acts as a reminder to turn off the system power before plugging or unplugging devices.
- 14 Wi-Fi slot.** The Wi-Fi (**Wireless Fidelity**) slot connects a Wi-Fi certified equipment for wireless networking that allows 11Mbps transmission (with a fallback to 5.5, 2, and 1 Mbps) in the 2.4 GHz band. Wi-Fi networks use radio technologies known as IEEE 802.11b to provide a fast reliable wireless connectivity.
- 15 PCI slots.** These five 32-bit PCI 2.2 expansion slots support bus master PCI cards like SCSI or LAN cards with 133MB/s maximum throughput.
- 16 Audio CODEC.** The ADI AD1985 is an AC'97 CODEC that allows 6-channel audio playback. The audio CODEC provides six DAC channels for 5.1 surround sound, S/PDIF output, AUX and Line In stereo inputs, integrated headphone amplifier, greater than 90dB dynamic range with the jack sense and jack enumeration feature.
- 17 LAN controller.** The 3COM 3C940 Gigabit Ethernet is a single-chip solution for LAN on Motherboard (LOM) application. The 3C940 provides a 32-bit interface and supports 1000/100/10 Mbps data transfer rates.
- 18 PS/2 mouse port.** This green 6-pin connector is for a PS/2 mouse.
- 19 Parallel port.** This 25-pin port connects a parallel printer, a scanner, or other devices.
- 20 RJ-45 port.** This port allows connection to a Local Area Network (LAN) through a network hub.
- 21 Line In jack.** This Line In (light blue) jack connects a tape player or other audio sources. In 6-channel mode, the function of this jack becomes Bass/Center Speaker Out.

22 **Line Out jack.** This Line Out (lime) jack connects a headphone or a speaker. In 6-channel mode, the function of this jack becomes Front Speaker Out.

23 **Microphone jack.** This Mic (pink) jack connects a microphone. In 6-channel mode, the function of this jack becomes Rear Speaker Out.

Rear panel audio ports function variation

	Headphone/ 2-Speaker	4-Speaker	6-Speaker
Light Blue	Line In	Rear Speaker Out	Bass/Center
Lime	Line Out	Front Speaker Out	Front Speaker Out
Pink	Mic In	Mic In	Rear Speaker Out

24 **USB 2.0 ports 3 and 4.** These two 4-pin Universal Serial Bus (USB) ports are available for connecting USB 2.0 devices.

25 **USB 2.0 ports 1 and 2.** These two 4-pin Universal Serial Bus (USB) ports are available for connecting USB 2.0 devices.

26 **Serial port.** This 9-pin COM1 port is for pointing devices or other serial devices.

27 **S/PDIF jack.** This jack connects to external audio output devices.

28 **PS/2 keyboard port.** This purple connector is for a PS/2 keyboard.

Chapter 2

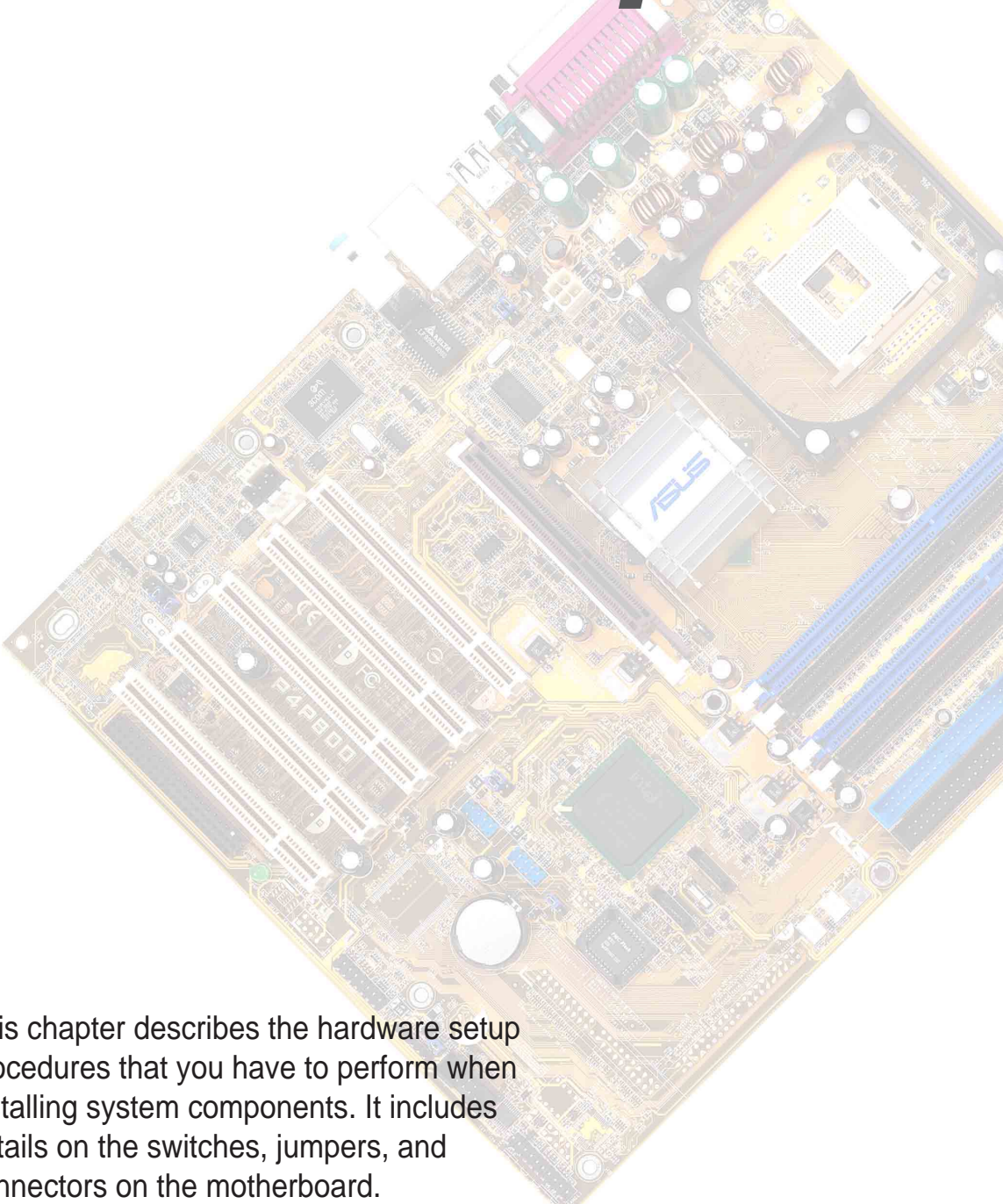

This chapter describes the hardware setup procedures that you have to perform when installing system components. It includes details on the switches, jumpers, and connectors on the motherboard.

Hardware information

Chapter summary

2.1	Motherboard installation	2-1
2.2	Motherboard layout	2-2
2.3	Before you proceed	2-3
2.4	Central Processing Unit (CPU)	2-4
2.5	System memory	2-10
2.6	Expansion slots	2-15
2.7	Jumpers	2-20
2.8	Connectors	2-23

2.1 Motherboard installation

Before you install the motherboard, study the configuration of your chassis to ensure that the motherboard fits into it. The P4P800 uses the ATX form factor that measures 12 inches x 9.6 inches.



Make sure to unplug the power cord before installing or removing the motherboard. Failure to do so may cause you physical injury and damage motherboard components.

2.1.1 Placement direction

When installing the motherboard, make sure that you place it into the chassis in the correct orientation. The edge with external ports goes to the rear part of the chassis as indicated in the image below.

2.1.2 Screw holes

Place nine (9) screws into the holes indicated by circles to secure the motherboard to the chassis.



Do not overtighten the screws! Doing so may damage the motherboard.

Place this side towards the rear of the chassis

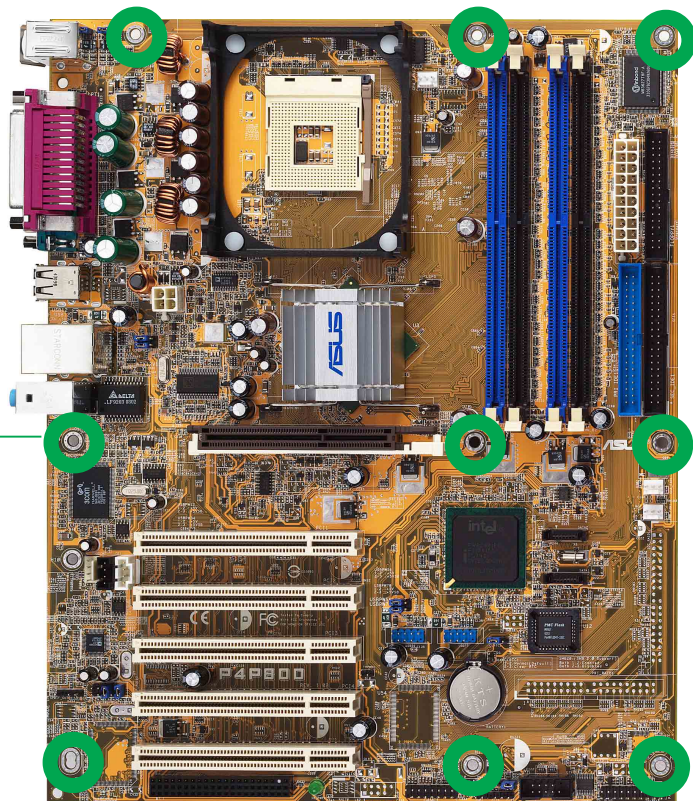

2.2 Motherboard layout

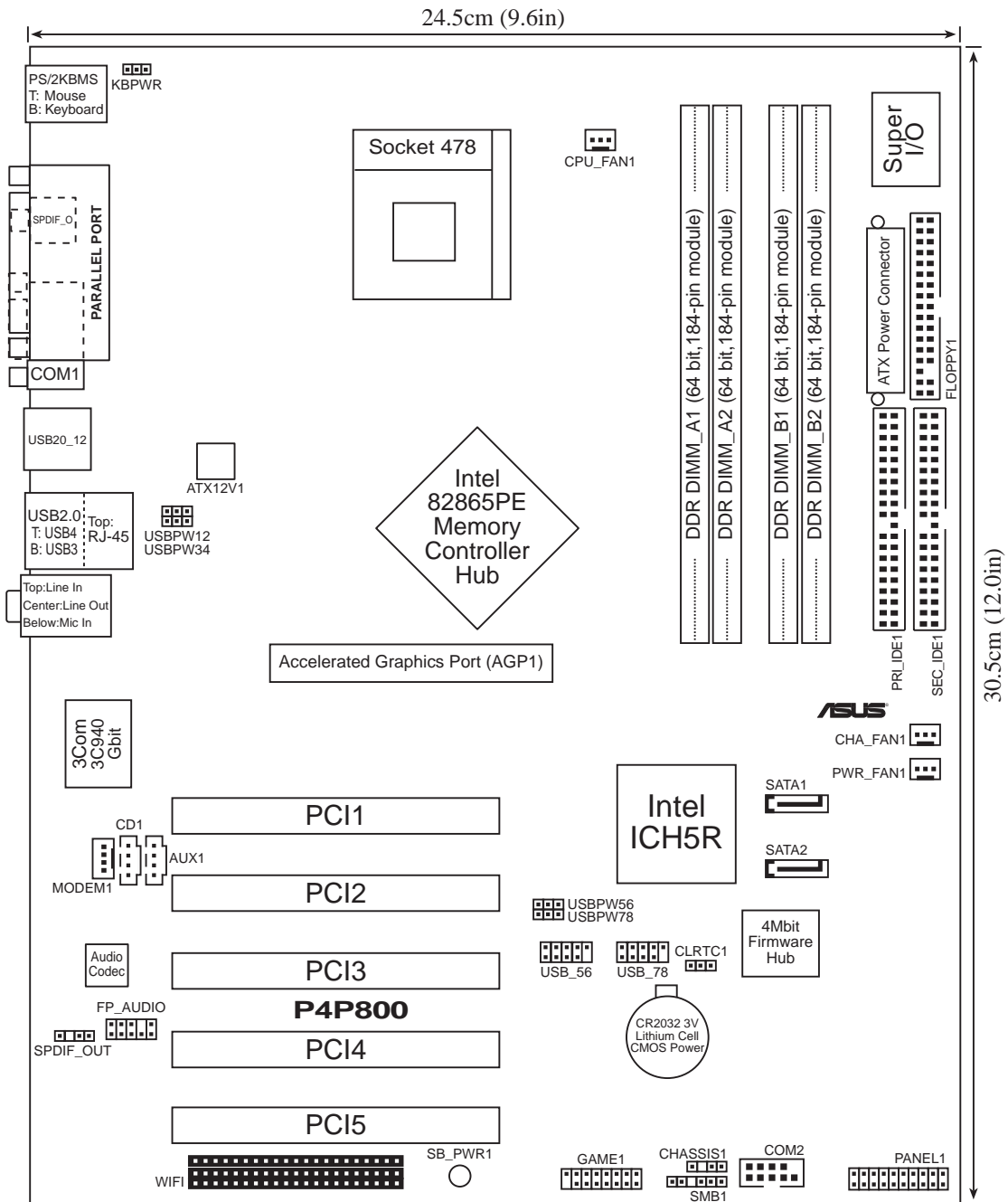

2.3 Before you proceed

Take note of the following precautions before you install motherboard components or change any motherboard settings.



1. Unplug the power cord from the wall socket before touching any component.
2. Use a grounded wrist strap or touch a safely grounded object or to a metal object, such as the power supply case, before handling components to avoid damaging them due to static electricity.
3. Hold components by the edges to avoid touching the ICs on them.
4. Whenever you uninstall any component, place it on a grounded antistatic pad or in the bag that came with the component.
5. **Before you install or remove any component, ensure that the ATX power supply is switched off or the power cord is detached from the power supply.** Failure to do so may cause severe damage to the motherboard, peripherals, and/or components.



When lit, the green LED (SB_PWR) indicates that the system is ON, in sleep mode, or in soft-off mode, a reminder that you should shut down the system and unplug the power cable before removing or plugging in any motherboard component.

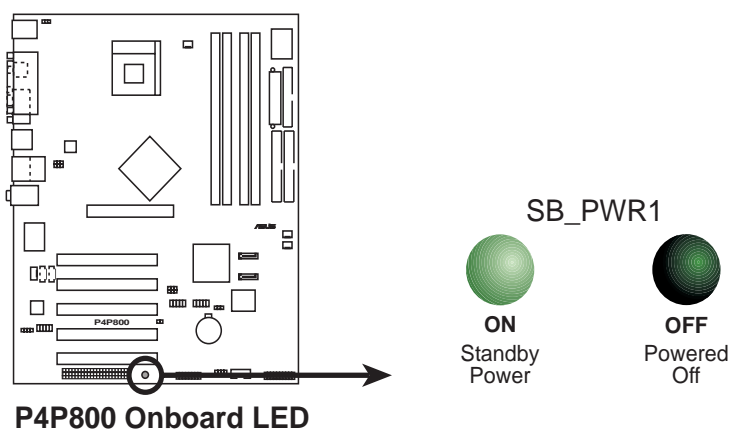

2.4 Central Processing Unit (CPU)

2.4.1 Overview

The motherboard comes with a surface mount 478-pin Zero Insertion Force (ZIF) socket. The socket is designed for the Intel® Pentium® 4 Processor in the 478-pin package with 512KB L2 cache on 0.13 micron process. This processor includes the Intel® NetBurst™ micro-architecture that features the rapid execution engine, Intel® Hyper-Threading Technology, 800/533/400MHz system bus, and execution trace cache. Together, these attributes improve system performance by allowing higher core frequencies, faster execution of integer instructions, and data transfer rates of 6.4GB/s, 4.2GB/s and 3.2GB/s.

Note in the illustration that the CPU has a gold triangular mark on one corner. This mark indicates the processor Pin 1 that should match a specific corner of the CPU socket.

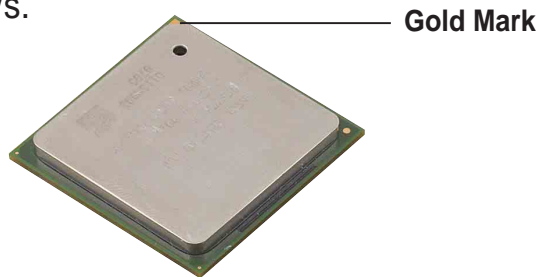

Notes on Intel® Hyper-Threading Technology



1. This motherboard supports Intel Pentium 4 CPUs with Hyper-Threading Technology.
2. Hyper-Threading Technology is supported under **Windows XP** and **Linux 2.4.x (kernel)** and later versions only. Under Linux, use the Hyper-Threading compiler to compile the code. If you are using any other operating systems, disable the Hyper-Threading Technology item in BIOS to ensure system stability and performance.
3. It is recommended that you install WinXP Service Pack 1.
4. Make sure to enable the Hyper-Threading Technology item in BIOS before installing a supported operating system.
5. For more information on Hyper-Threading Technology, visit www.intel.com/info/hyperthreading.

To use the Hyper-Threading Technology on this motherboard:

1. Buy an Intel Pentium 4 CPU that supports Hyper-Threading Technology. Install the CPU.
2. Power up the system and enter BIOS Setup (see Chapter 2). Under the Advanced Menu, make sure that the item **Hyper-Threading Technology->CPU Configuration** is set to Enabled. The item appears only if you installed a CPU that supports Hyper-Threading Technology.
3. Reboot the computer.

2.4.2 Installing the CPU

Follow these steps to install a CPU.

1. Locate the 478-pin ZIF socket on the motherboard.

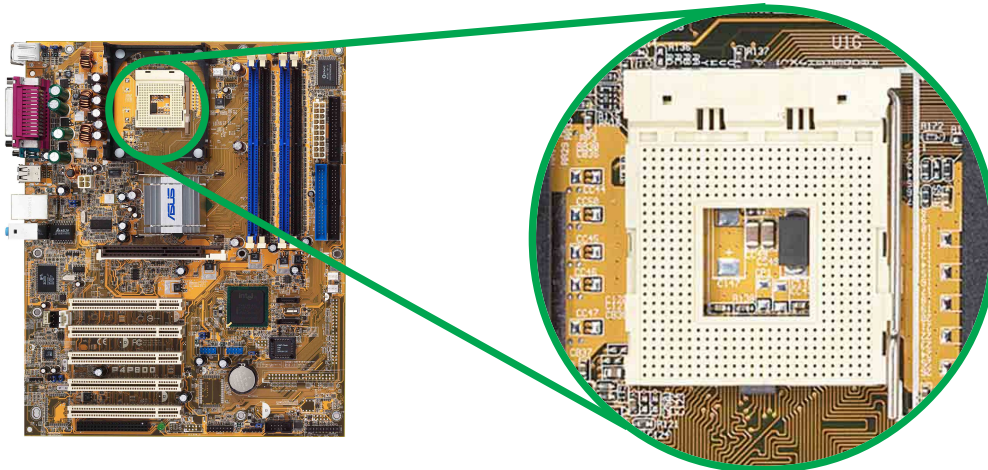

2. Unlock the socket by pressing the lever sideways, then lift it up to a 90°-100° angle.

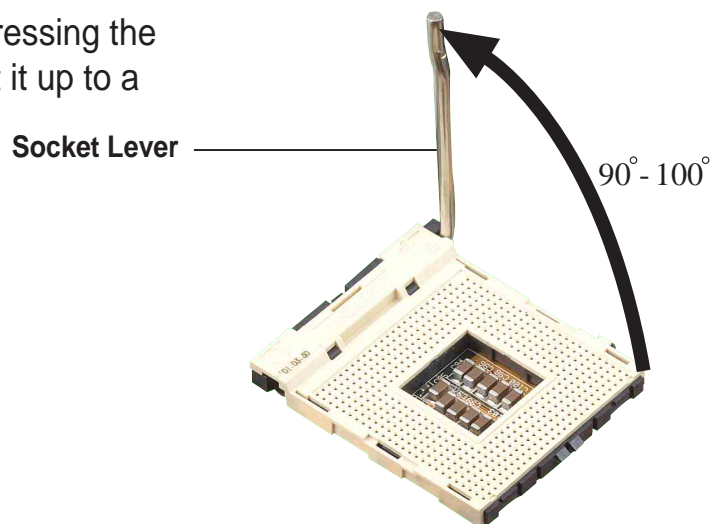

Make sure that the socket lever is lifted up to 90°-100° angle, otherwise the CPU does not fit in completely.



Incorrect installation of the CPU into the socket may bend the pins and severely damage the CPU!

3. Position the CPU above the socket such that its marked corner matches the base of the socket lever.
4. Carefully insert the CPU into the socket until it fits in place.

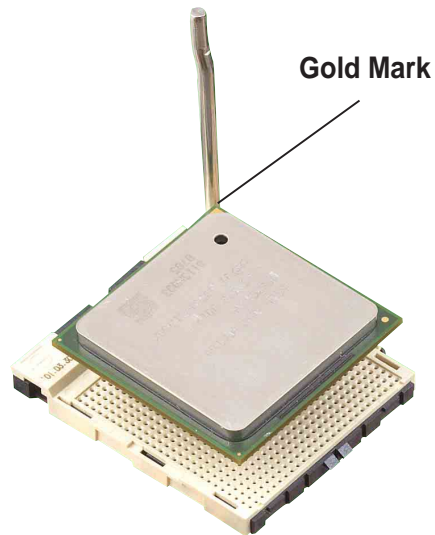

The CPU fits only in one correct orientation. DO NOT force the CPU into the socket to prevent bending the pins and damaging the CPU!

5. When the CPU is in place, push down the socket lever to secure the CPU. The lever clicks on the side tab to indicate that it is locked.

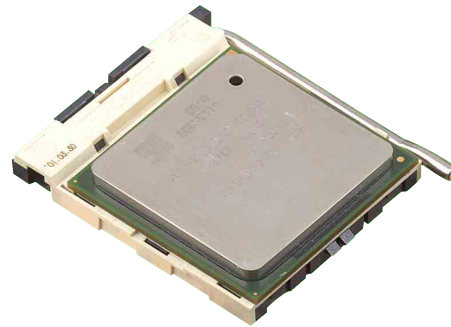

2.4.3 Installing the heatsink and fan

The Intel® Pentium® 4 Processor requires a specially designed heatsink and fan assembly to ensure optimum thermal condition and performance.



When you buy a boxed Intel Pentium 4 Processor, the package includes the heatsink, fan, and retention mechanism.

In case you buy a CPU separately, make sure that you use only Intel certified heatsink and fan.

Follow these steps to install the CPU heatsink and fan.

1. Place the heatsink on top of the installed CPU, making sure that the heatsink fits properly on the retention module base.



The retention module base is already installed on the motherboard upon purchase.

You do not have to remove the retention module base when installing the CPU or installing other motherboard components.

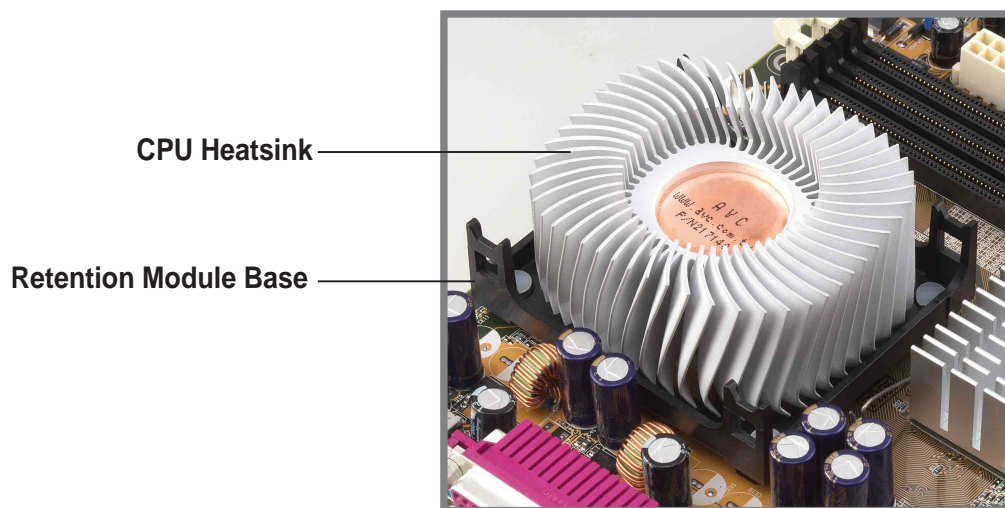

Your boxed Intel Pentium 4 Processor package should come with installation instructions for the CPU, heatsink, and the retention mechanism. If the instructions in this section do not match the CPU documentation, follow the latter.

2. Position the fan with the retention mechanism on top of the heatsink. Align and snap the four hooks of the retention mechanism to the holes on each corner of the module base.



Make sure that the fan and retention mechanism assembly perfectly fits the heatsink and module base, otherwise you cannot snap the hooks into the holes.

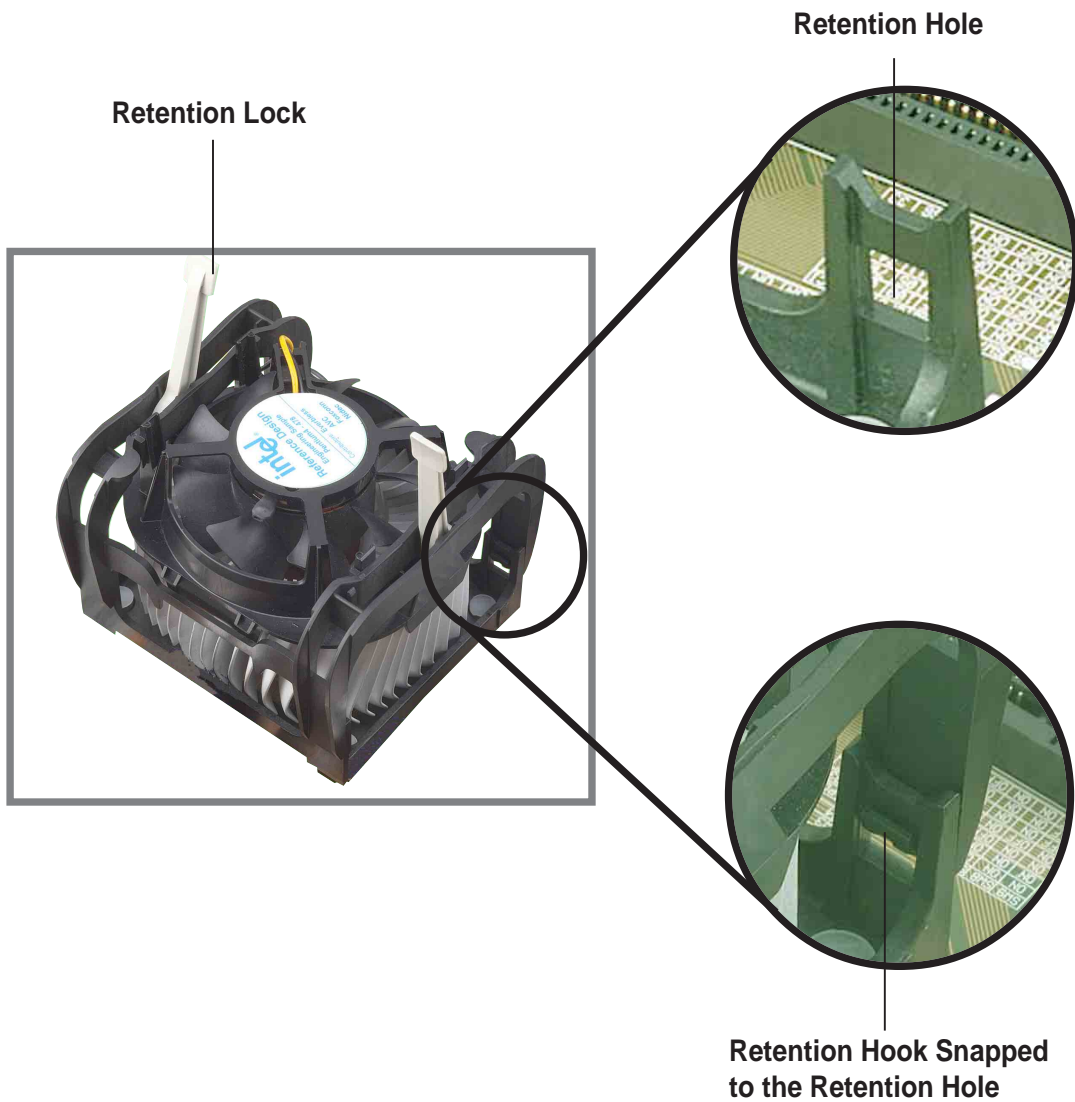

Keep the retention locks lifted upward while fitting the retention mechanism to the module base.

3. Push down the locks on the retention mechanism to secure the heatsink and fan to the module base.



When secure, the retention locks should point to opposite directions.



2.4.4 Connecting the CPU fan cable

When the fan, heatsink, and the retention mechanism are in place, connect the CPU fan cable to the connector on the motherboard labeled CPU_FAN.

CPU Fan Connector
(CPU_FAN)

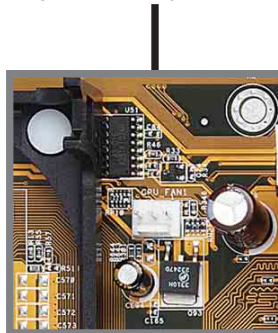

Don't forget to connect the CPU fan connector! Hardware monitoring errors may occur if you fail to plug this connector.

2.5 System memory

2.5.1 Overview

The motherboard comes with four Double Data Rate (DDR) Dual Inline Memory Module (DIMM) sockets. These sockets support up to 4GB system memory using 184-pin unbuffered non-ECC PC3200/2700/PC2100 DDR DIMMs and allow up to 6.4 GB/s data transfer rate.

The following figure illustrates the location of the DDR DIMM sockets.

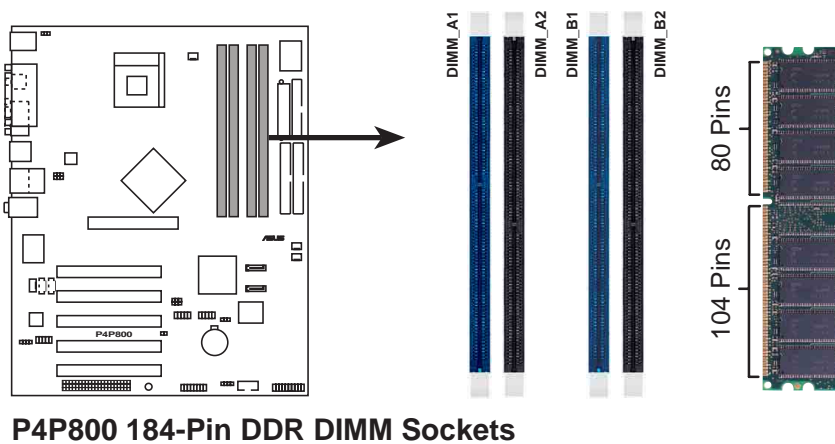

Notes on DDR technology

The DDR SDRAM technology evolved from the mainstream PC66, PC100, PC133 memory known as Single Data Rate (SDR) SDRAM. DDR memory however, has the ability to perform two data operations in one clock cycle, thus providing twice the throughput of SDR memory.

A DDR DIMM has the same physical dimensions as an SDR DIMM, but it has a 184-pin footprint compared to the 168-pin of the SDR DIMM. Also, a DDR DIMM is single notched while an SDR DIMM is double notched. Therefore, a DDR DIMM is not backward compatible with SDR, and should be installed only in a socket specially designed for DDR DIMMs.



It is recommended to use the blue DIMM slots first.

2.5.2 Memory configurations

You may install 64MB, 128MB, 256MB, 512MB, and 1GB DDR DIMMs into the DIMM sockets using the memory configurations in this section.

Important notes on memory configurations



-
1. Installing DDR DIMMs other than the recommended configurations may cause memory sizing error or system boot failure. Use any of the recommended configurations in Table 1.
 2. In dual-channel configurations, install only **identical** (the same type and size) DDR DIMM pairs for each channel.
 3. Always install DIMMs with the same CAS latency. For optimum compatibility, it is recommended that you obtain memory modules from the same vendor. See list of qualified vendors on page 2-12.
 4. Make sure that the memory frequency matches the CPU FSB (Front Side Bus). Refer to Table 2.
 5. DIMMs installed into **any three** sockets will function in single-channel mode.
 6. When all four sockets are populated with 1GB DIMMs (total 4GB), the system may detect only 3+GB (a little less than 4GB) due to ICH5R resource allocation.
-

Table 1 Recommended memory configurations

Mode		Sockets			
		DIMM_A1	DIMM_A2	DIMM_B1	DIMM_B2
Single-channel	(1)	Populated	—	—	—
	(2)	—	Populated	—	—
	(3)	—	—	Populated	—
	(4)	—	—	—	Populated
Dual-channel*	(1)	Populated	—	Populated	—
	(2)	—	Populated	—	Populated
	(3)	Populated	Populated	Populated	Populated

* Use **only** identical DDR DIMM pairs.

* For dual-channel configuration (3), you may:

- install identical DIMMs in all four sockets
- or
- install identical DIMM pair in DIMM_A1 and DIMM_B1 (blue sockets) and identical DIMM pair in DIMM_A2 and DIMM_B2 (black sockets)

Table 2 Memory frequency/CPU FSB synchronization

CPU FSB	DDR DIMM Type	Memory Frequency
800 MHz	PC3200/PC2700*/PC2100	400/333*/266 MHz
533 MHz	PC2700/PC2100	333/266 MHz
400 MHz	PC2100	266 MHz



*When using 800MHz CPU FSB, PC2700 DDR DIMMs may run only at 320MHz (not 333MHz) due to chipset limitation.

2.5.2.2 DDR Qualified Vendor List

The following table lists the PC3200 and 2700 (DDR400 and DDR333) memory modules that have been tested and qualified for use with this motherboard.

Size	Vendor	Model	Brand	Component	DIMMs Support
256MB	A DATA	MDGA5F3G315B1EC2	A DATA	ADD8608A8A-5B	1, 2
256MB	A DATA		Winbond	W942508BH-5	1, 2
256MB	Apacer		Samsung	K4H560838D-TCC4	1
512MB	Apacer		Samsung	K4H560838D-TCC4	1
256MB	GEIL		GEIL	GL3LC32G88TG-5A	1
128MB	Infineon	HYS64D16301GU-5-B	Infineon	HYB25D256160BT-5B	2, 4
256MB	Infineon	HYS64D32300GU-5-B	Infineon	HYB25D256800BT-5B	1, 2, 4
512MB	Infineon	HYS64D64320GU-5-B	Infineon	HYB25D256800BT-5B	1
256MB	Kingmax	MPXB62D-68KX3	Kingmax	KDL684T4AA-50	A1
512MB	Kingston	9905193-003	Winbond	W942508BH-5	A1B1
256MB	MICRON	MT16VDDT3264AG-403B5	MICRON	MT46V16M8-5ESB	1
256MB	MICRON	MT16VDDT3264AG-403B5	MICRON	MT46V16M8-5TESB	1, 2
512MB	Samsung	M368L322ETM-CCC	Samsung	K4H560838E-TCCC	A1, A1B1, A1A2, B1B2
512MB	Transcend	69960 Y0303	Samsung	K4H560838D-TCC4	1
512MB	Transcend	TS64MLD64V4F	Mosel	V58C2256804SAT5	1, 2, 4
512MB	Winbond	W9451TGADB-5	Winbond	W942508CH-5	A1, A1B1

DIMMs Support Table

Code	Description
1	Only one (1) DIMM support to any slot
2	Two (2) DIMMs support to any slot
4	Support for all slots
A1	Support for slot A1 only
A2	Support for slot A2 only
B1	Support for slot B1 only
B2	Support for slot B2 only
A1A2	Support for slots A1 and A2 only
B1B2	Support for slots B1 and B2 only
A1B1	Support for slots A1 and B1 only



Obtain DDR DIMMs only from ASUS qualified vendors for better system performance.



Make sure to use only the tested and qualified DDR400 and DDR333 DIMMs listed above. Other DDR DIMMs manufactured by other vendors may not be suitable for this motherboard. Visit the ASUS website (www.asus.com) for the latest qualified vendor DDR 400 and DDR333 module list.

2.5.3 Installing a DIMM



Make sure to unplug the power supply before adding or removing DIMMs or other system components. Failure to do so may cause severe damage to both the motherboard and the components.

Follow these steps to install a DIMM.

1. Locate the DIMM sockets in the motherboard.

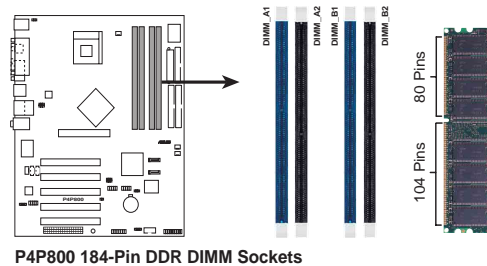

P4P800 184-Pin DDR DIMM Sockets

2. Unlock a DIMM socket by pressing the retaining clips outward.
3. Align a DIMM on the socket such that the notch on the DIMM matches the break on the socket.

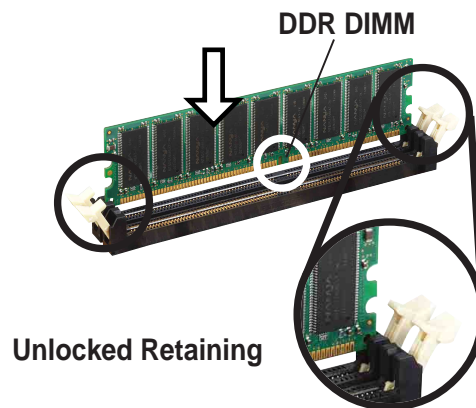

A DDR DIMM is keyed with a notch so that it fits in only one direction. DO NOT force a DIMM into a socket to avoid damaging the DIMM.

4. Firmly insert the DIMM into the socket until the retaining clips snap back in place and the DIMM is properly seated.

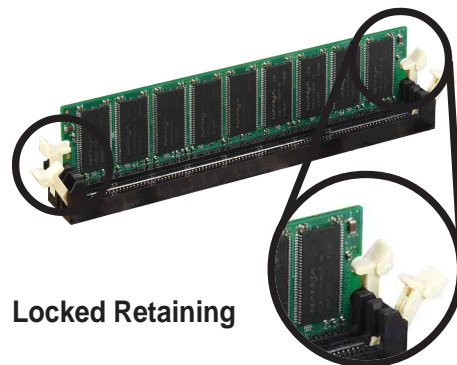

2.5.4 Removing a DIMM

Follow these steps to remove a DIMM.

1. Simultaneously press the retaining clips outward to unlock the DIMM.

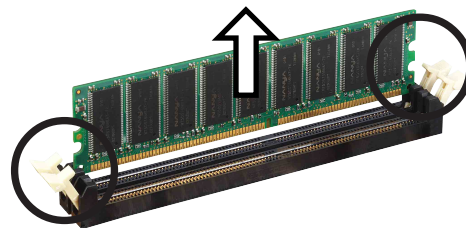

Support the DIMM lightly with your fingers when pressing the retaining clips. The DIMM might get damaged when it flips out with extra force.

2. Remove the DIMM from the socket.

2.6 Expansion slots

In the future, you may need to install expansion cards. The motherboard has five PCI slots and one Accelerated Graphics Port (AGP) slot. The following sub-sections describe the slots and the expansion cards that they support.



Make sure to unplug the power cord before adding or removing expansion cards. Failure to do so may cause you physical injury and damage motherboard components.

2.6.1 Installing an expansion card

Follow these steps to install an expansion card.

1. Before installing the expansion card, read the documentation that came with it and make the necessary hardware settings for the card.
2. Remove the system unit cover (if your motherboard is already installed in a chassis).
3. Remove the bracket opposite the slot that you intend to use. Keep the screw for later use.
4. Align the card connector with the slot and press firmly until the card is completely seated on the slot.
5. Secure the card to the chassis with the screw you removed earlier.
6. Replace the system cover.

2.6.2 Configuring an expansion card

After installing the expansion card, configure the card by adjusting the software settings.

1. Turn on the system and change the necessary BIOS settings, if any. See Chapter 4 for information on BIOS setup.
2. Assign an IRQ to the card. Refer to the tables on the next page.
3. Install the software drivers for the expansion card.

Standard Interrupt Assignments

IRQ	Priority	Standard Function
0	1	System Timer
1	2	Keyboard Controller
2	N/A	Programmable Interrupt
3*	11	Communications Port (COM2)
4*	12	Communications Port (COM1)
5*	13	Sound Card (sometimes LPT2)
6	14	Floppy Disk Controller
7*	15	Printer Port (LPT1)
8	3	System CMOS/Real Time Clock
9*	4	ACPI Mode when used
10*	5	IRQ Holder for PCI Steering
11*	6	IRQ Holder for PCI Steering
12*	7	PS/2 Compatible Mouse Port
13	8	Numeric Data Processor
14*	9	Primary IDE Channel
15*	10	Secondary IDE Channel

* These IRQs are usually available for ISA or PCI devices.

IRQ assignments for this motherboard

	A	B	C	D	E	F	G	H
PCI slot 1	—	—	—	—	—	shared	—	—
PCI slot 2	—	—	—	—	—	—	shared	—
PCI slot 3	—	—	—	—	—	—	—	shared
PCI slot 4	—	—	—	—	shared	—	—	—
PCI slot 5	—	—	—	—	—	shared	—	—
AGP slot	used	—	—	—	—	—	—	—
Onboard USB 1.1/2.0 controller	—	—	—	—	shared	shared	shared	shared
Onboard LAN	—	—	—	—	—	—	shared	—
Onboard Audio	—	—	used	—	—	—	—	—



When using PCI cards on shared slots, ensure that the drivers support “Share IRQ” or that the cards do not need IRQ assignments. Otherwise, conflicts will arise between the two PCI groups, making the system unstable and the card inoperable.

2.6.3 PCI slots

There are five 32-bit PCI slots on this motherboard. The slots support PCI cards such as a LAN card, SCSI card, USB card, and other cards that comply with PCI specifications. The following figure shows a LAN card installed on a PCI slot.

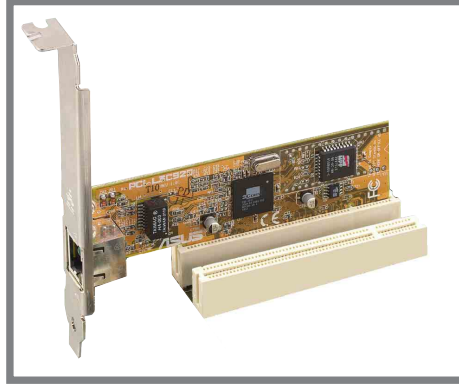

-
1. The PCI 5 slot and the WiFi slot may not be used at the same time.
 2. When installing long PCI cards, it is recommended that you install it in PCI slots 3, 4, or 5. Long PCI cards installed in PCI slots 1 and 2 may interfere with the SATA and GAME connectors.
-

2.6.4 AGP slot

This motherboard has an Accelerated Graphics Port (AGP) slot that only supports +1.5V AGP cards. When you buy an AGP card, make sure that you ask for one with +1.5V specification. Note the notches on the card golden fingers to ensure that they fit the AGP slot on your motherboard.



Install only 1.5V AGP cards on this motherboard! 3.3V AGP cards are not supported in this motherboard.

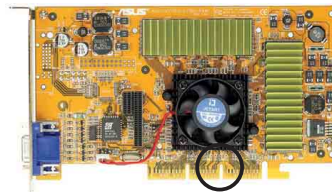
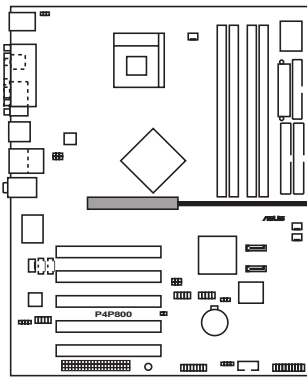

Keyed for 1.5v

P4P800 Accelerated Graphics Port (AGP)



If installing the ATi 9500 or 9700 Pro Series VGA cards, use only the card version **PN xxx-xxxx-30** or later, for optimum performance and overclocking stability.



2.6.5 Wi-Fi slot

The Wi-Fi (Wireless Fidelity) slot will support the ASUS Wi-Fi module when available. Visit the ASUS website (www.asus.com) for product updates.

The Wi-Fi slot conforms to the Institute of Electrical and Electronics Engineers (IEEE) 802.11b standard for wireless devices operating in the 2.4 GHz frequency band. This standard includes provisions for three radio technologies: direct sequence spread spectrum, frequency hopping spread spectrum, and infrared. Devices that comply with the 802.11b standard operate at data rates of up to 11 Mbps for direct sequence spread spectrum.

The IEEE 802.11b specification allocates the 2.4 GHz frequency band into 14 overlapping operating channels. Each Channel corresponds to a different set of frequencies. If operating multiple 802.11b wireless PCI cards in the same vicinity, the distance between the center frequencies must be at least 25 MHz to avoid interference.

The channels available to an 802.11b wireless PCI card will vary from country to country. In the United States, the 802.11b standard allocates 11 operating channels for direct sequence devices. Channels 1, 6, and 11 are independent and do not overlap with each other.

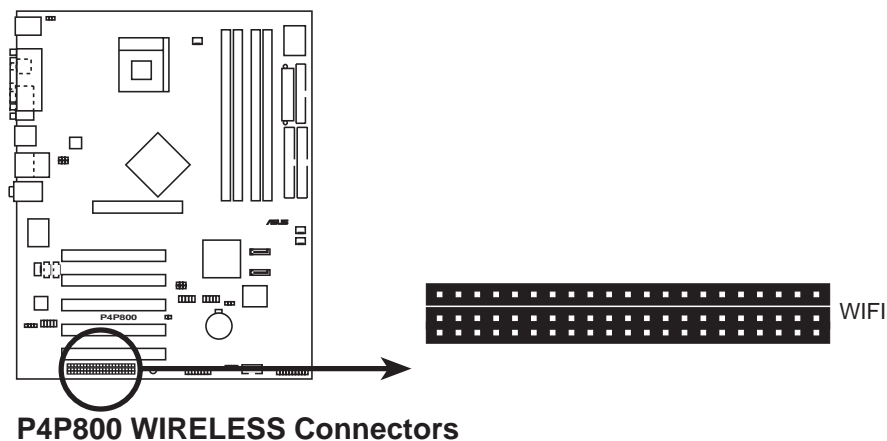

The PCI 5 slot and the Wi-Fi slot may not be used at the same time.

2.7 Jumpers

1. Clear RTC RAM (CLRRTC1)

This jumper allows you to clear the Real Time Clock (RTC) RAM in CMOS. You can clear the CMOS memory of date, time, and system setup parameters by erasing the CMOS RTC RAM data. The RAM data in CMOS, that include system setup information such as system passwords, is powered by the onboard button cell battery.

To erase the RTC RAM:

1. Turn OFF the computer and unplug the power cord.
2. Remove the onboard battery.
3. Move the jumper cap from pins 1-2 (default) to pins 2-3. Keep the cap on pins 2-3 for about 5~10 seconds, then move the cap back to pins 1-2.
4. Replace the battery.
5. Plug the power cord and turn ON the computer.
6. Hold down the key during the boot process and enter BIOS setup to re-enter data.



Except when clearing the RTC RAM, never remove the cap on CLRRTC1 jumper default position. Removing the cap will cause system boot failure!

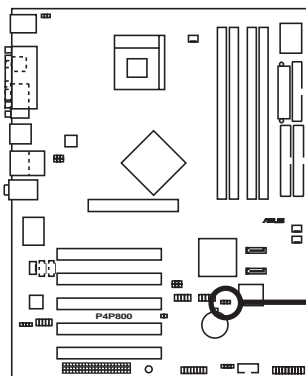

P4P800 Clear RTC RAM

CLRRTC1

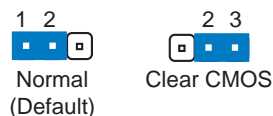

You do not need to clear the RTC when the system hangs due to overclocking. For system failure due to overclocking, use the C.P.R. (CPU Parameter Recall) feature. Shut down and reboot the system so BIOS can automatically reset parameter settings to default values.

2. Keyboard power (3-pin KBPWR)

This jumper allows you to enable or disable the keyboard wake-up feature. Set this jumper to pins 2-3 (+5VSB) if you wish to wake up the computer when you press a key on the keyboard (the default value is [Disabled]). This feature requires an ATX power supply that can supply at least 1A on the +5VSB lead and a corresponding setting in the BIOS. (see section 4.5.1 Power Up Control)

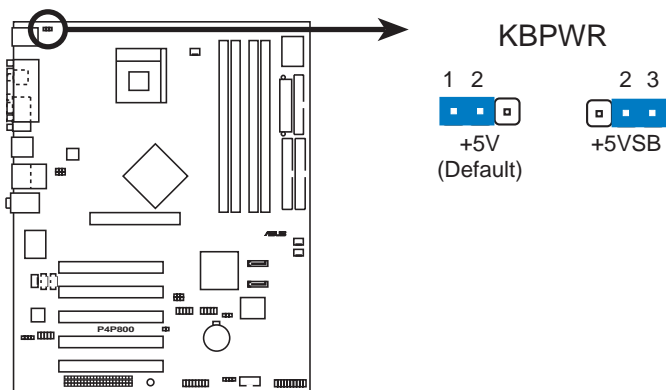

P4P800 Keyboard Power Setting

3. USB device wake-up (3-pin USBPW12, USBPW34, USBPW56, USBPW78)

Set these jumpers to +5V to wake up the computer from S1 sleep mode (CPU stopped, DRAM refreshed, system running in low power mode) using the connected USB devices. Set to +5VSB to wake up from S3 and S4 sleep modes (no power to CPU, DRAM in slow refresh, power supply in reduced power mode).

The USBPW12 and USBPW34 jumpers are for the rear USB ports. The USBPW56 and USBPW78 jumpers are for the internal USB header that you can connect to the front USB ports.

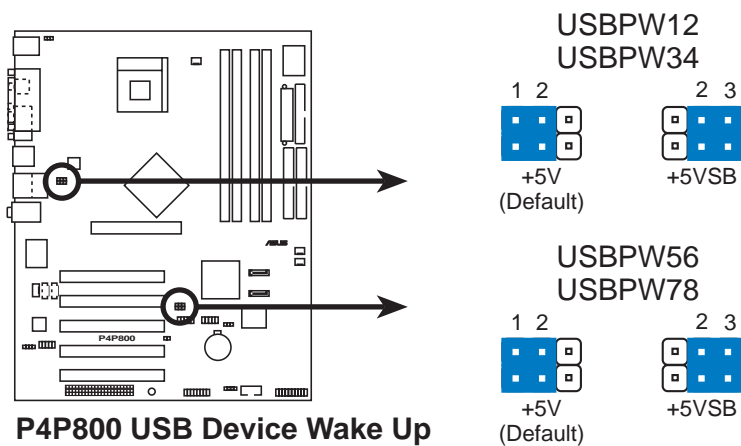

1. The USB device wake-up feature requires a power supply that can provide 500mA on the +5VSB lead for each USB port. Otherwise, the system would not power up.
2. The total current consumed must NOT exceed the power supply capability (+5VSB) whether under normal condition or in sleep mode.

2.8 Connectors

This section describes and illustrates the internal connectors on the motherboard.



Always connect ribbon cables with the red stripe to Pin 1 on the connectors. Pin 1 is usually on the side closest to the power connector on hard drives and CD-ROM drives, but may be on the opposite side on floppy disk drives.

1. Floppy disk drive connector (34-1 pin FLOPPY1)

This connector supports the provided floppy drive ribbon cable. After connecting one end to the motherboard, connect the other end to the floppy drive. (Pin 5 is removed to prevent incorrect insertion when using ribbon cables with pin 5 plug).

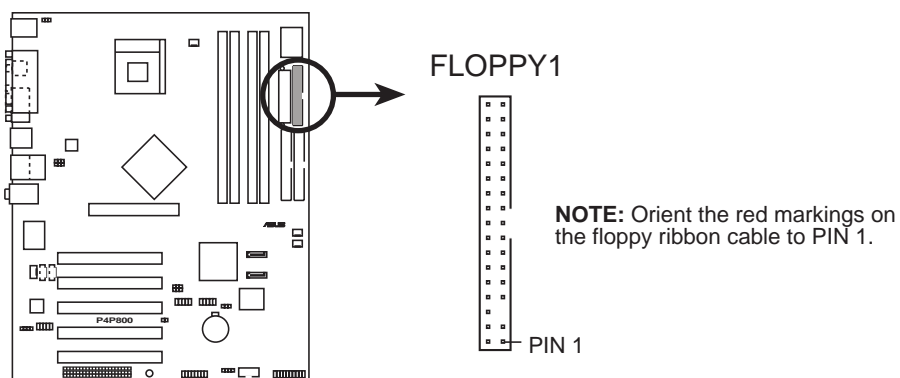

P4P800 Floppy Disk Drive Connector

2. IDE connectors (40-1 pin PRI_IDE1, SEC_IDE1)

This connector supports the provided UltraDMA100/66 IDE hard disk ribbon cable. Connect the cable's blue connector to the primary (recommended) or secondary IDE connector, then connect the gray connector to the UltraDMA100/66 slave device (hard disk drive) and the black connector to the UltraDMA100/66 master device. It is recommended that you connect non-UltraDMA100/66 devices to the secondary IDE connector. If you install two hard disks, you must configure the second drive as a slave device by setting its jumper accordingly. Refer to the hard disk documentation for the jumper settings. BIOS supports specific device bootup. If you have more than two UltraDMA100/66 devices, purchase another UltraDMA100/66 cable. You may configure two hard disks to be both master devices with two ribbon cables – one for the primary IDE connector and another for the secondary IDE connector.



1. Pin 20 on each IDE connector is removed to match the covered hole on the UltraDMA cable connector. This prevents incorrect orientation when you connect the cables.
2. The hole near the blue connector on the UltraDMA100/66 cable is intentional.

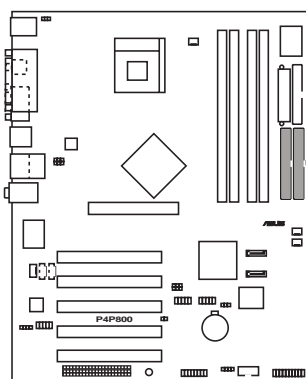

P4P800 IDE Connectors

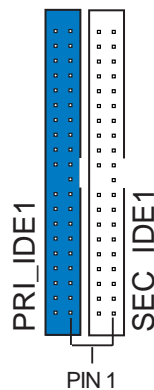

NOTE: Orient the red markings (usually zigzag) on the IDE ribbon cable to PIN 1.



For UltraDMA100/66 IDE devices, use an 80-conductor IDE cable. The UltraDMA/66 cable included in the motherboard package also supports UltraDMA100.



Important notes when using legacy OS

- Refer to page 2-26 on how to configure P-ATA and S-ATA devices if you installed a legacy operating system (e.g. MS-DOS, Windows 98/ME/NT4.0).
- In legacy OS, manually set DMA mode in Device Manager under System Properties, if your hard disk supports UDMA mode.

3. Serial ATA connectors (7-pin SATA1, SATA2)

These next generation connectors support the thin Serial ATA cables for primary internal storage devices. The current Serial ATA interface allows up to 150 MB/s data transfer rate, faster than the standard parallel ATA with 133 MB/s (Ultra ATA/133).

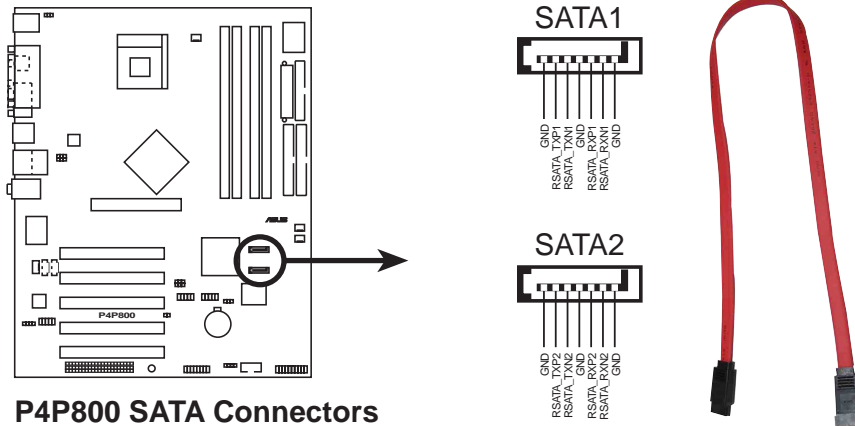

P4P800 SATA Connectors



Important notes on Serial ATA solution:

- In legacy operating system (Win 98, WinME, WinNT, DOS) environment, using SATA will disable one of the IDE channels from ICH5R south bridge chipset. See BIOS section for correct setting.
 - The Serial ATA cable is smaller and more flexible allowing easier routing inside the chassis. The lower pin count of the Serial ATA cable eliminates the problem caused by the wide, flat ribbon cables of the Parallel ATA interface.
 - The Serial ATA RAID driver is available for WinXP only.
 - Only RAID 0 is supported.
 - Hot plug support for Serial ATA drive and connections are not available in this motherboard.
-

Parallel ATA and Serial ATA device configurations

Following are the Parallel ATA and Serial ATA device configurations supported by Intel ICH5 specifications.

Native IDE mode capable operating systems (OS) are Windows 2000/XP. ICH5 supports a maximum of six (6) devices using these OS.

Legacy IDE compatible mode OS are MS-DOS, Windows 98/Me/NT4.0. ICH5 supports a maximum of four (4) devices using these OS.

Operating System	P-ATA		S-ATA	
	Primary (2 devices)	Secondary (2 devices)	Port 0 (1 device)	Port 1 (1 device)
1. Windows 2000/XP	✓	✓	✓	✓
2. Windows 98/Me/NT4.0				
Configuration A	✓ (Primary)	X	✓ (Secondary)	✓
Configuration B	X	✓ (Secondary)	✓	✓ (Primary)
Configuration C	✓ (Primary)	✓ (Secondary)	X	X

Legend:

- ✓ Supported
- X Disabled
- Primary Logical Primary Channel as recognized by software.
- Secondary Logical Secondary Channel as recognized by software.

Required IDE Configuration settings in BIOS

Refer to the following table for the appropriate BIOS settings of the above P-ATA and S-ATA device configurations. See section “4.3.6 IDE Configurations” for details on the BIOS items.

BIOS item	Windows 2000/XP	Windows 98/Me/NT4.0		
		A	B	C
Onboard IDE Operate Mode	Enhanced Mode	Compatible Mode	Compatible Mode	Compatible Mode
Enhanced Mode Support On	P-ATA & S-ATA	P-ATA & S-ATA	P-ATA & S-ATA	P-ATA Only
IDE Port Settings	Primary P-ATA+S-ATA	Yes	Yes	No



If you are using Serial ATA hard disks in a legacy operating system (Windows 98, 98SE, Me, NT, DOS) make sure to adjust appropriate BIOS settings. Refer to section “4.3.6 IDE Configuration” in page 4-11 for more detailed setting information.

5. SMBus connector (6-1 pin SMB1)

This connector allows you to connect SMBus (System Management Bus) devices. Devices communicate with an SMBus host and/or other SMBus devices using the SMBus interface.

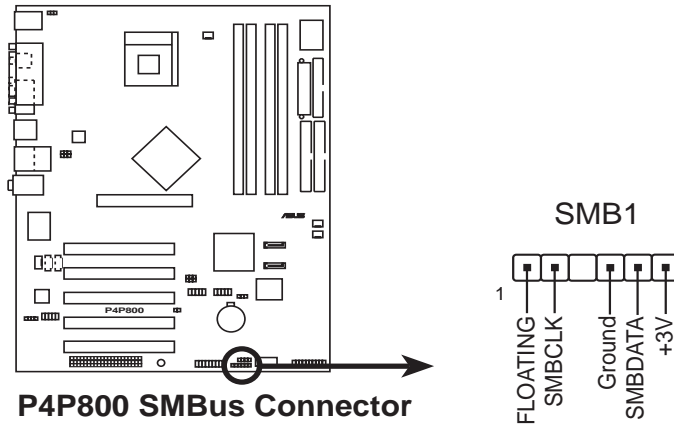

6. Chassis intrusion connector (4-1 pin CHASSIS1)

This lead is for a chassis designed with intrusion detection feature. This requires an external detection mechanism such as a chassis intrusion sensor or microswitch. When you remove any chassis component, the sensor triggers and sends a high-level signal to this lead to record a chassis intrusion event.

By default, the pins labeled “Chassis Signal” and “Ground” are shorted with a jumper cap. If you wish to use the chassis intrusion detection feature, remove the jumper cap from the pins.

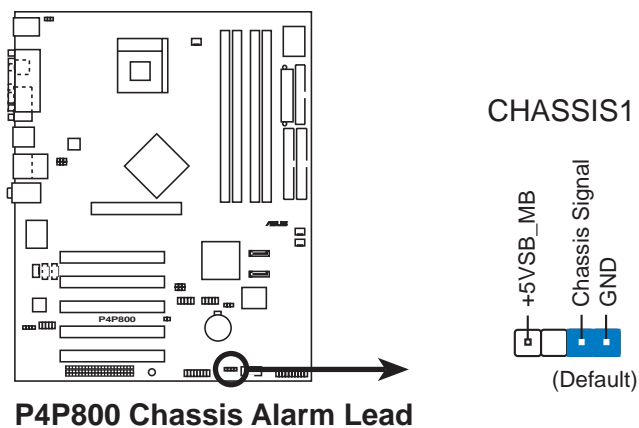

7. CPU, Chassis, and Power Fan Connectors (3-pin CPU_FAN1, PWR_FAN1, CHA_FAN1)

The fan connectors support cooling fans of 350mA~740mA (8.88W max.) or a total of 1A~2.22A (26.64W max.) at +12V. Connect the fan cables to the fan connectors on the motherboard, making sure that the black wire of each cable matches the ground pin of the connector.



Do not forget to connect the fan cables to the fan connectors. Lack of sufficient air flow within the system may damage the motherboard components. These are not jumpers! **DO NOT** place jumper caps on the fan connectors!

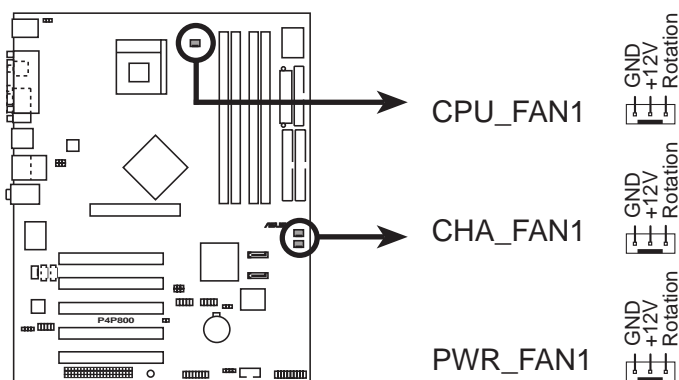

P4P800 12-Volt Fan Connectors

8. Power supply thermal connector (2-pin TRPWR1)

If your power supply has a thermal monitoring feature, connect its thermal sensor cable to this connector.

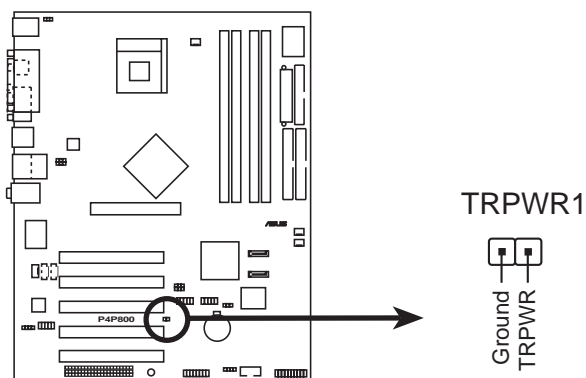

P4P800 Power Supply Thermal Connector

9. ATX power connectors (20-pin ATXPWR, 4-pin ATX12V)

These connectors connect to an ATX 12V power supply. The plugs from the power supply are designed to fit these connectors in only one orientation. Find the proper orientation and push down firmly until the connectors completely fit.

In addition to the 20-pin ATXPWR1 connector, this motherboard requires that you connect the 4-pin ATX +12V power plug to provide sufficient power to the CPU.



1. Do not forget to connect the 4-pin ATX +12V power plug. Otherwise, the system does not boot up.
2. Make sure that your ATX 12V power supply can provide 8A on the +12V lead and at least 1A on the +5-volt standby lead (+5VSB). The minimum recommended wattage is 230W, or 300W for a fully configured system. The system may become unstable or may not boot up if the power is inadequate.

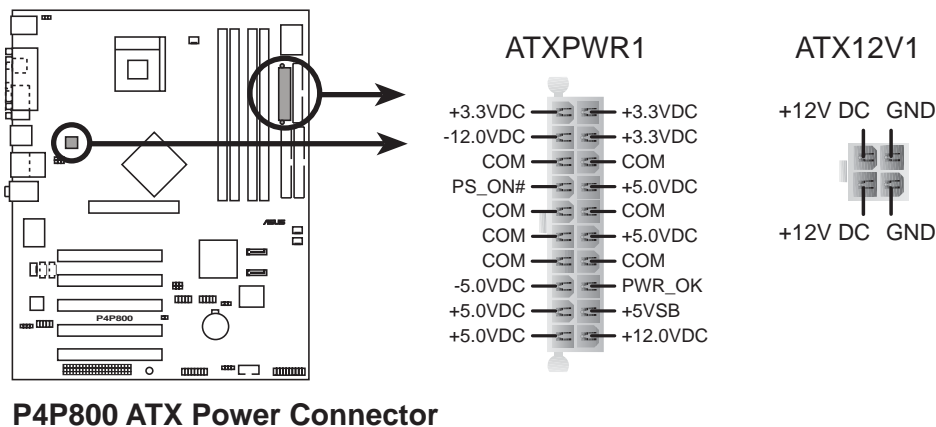

10. USB headers (10-1 pin USB_56, USB_78)

If the USB ports on the rear panel are inadequate, a USB header is available for additional USB ports. The USB header complies with USB 2.0 specification that supports up to 480 Mbps connection speed. This speed advantage over the conventional 12 Mbps on USB 1.1 allows faster Internet connection, interactive gaming, and simultaneous running of high-speed peripherals.



You must install the driver before you can use the USB 2.0 capability.

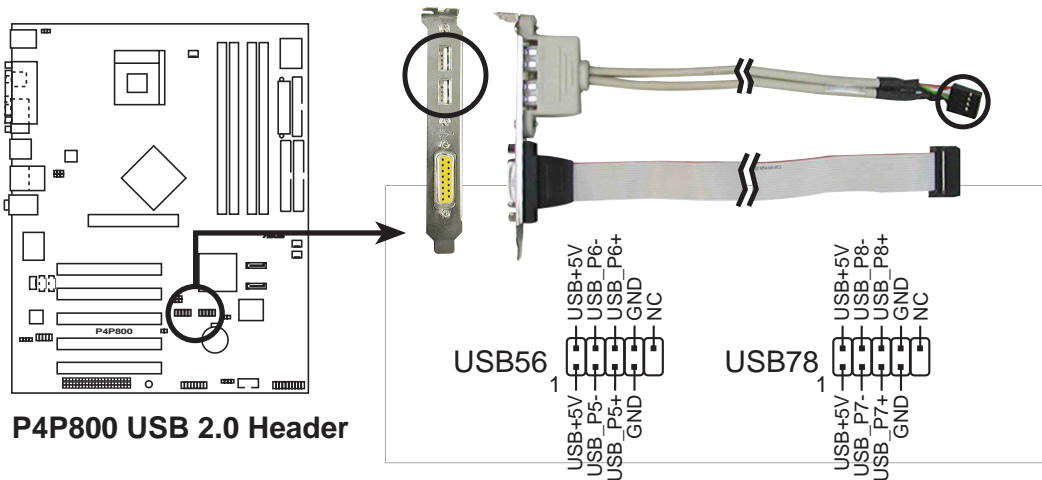

NEVER connect a **1394 cable** to the USB_56 or USB_78 connectors. Doing so will damage the motherboard!



The USB port is an optional item and not included in this motherboard package.

11. GAME/MIDI connector (16-1 pin GAME1)

This connector supports an optional GAME/MIDI module. If a GAME/MIDI module is available, connect the GAME/MIDI cable to this connector. The GAME/MIDI port on the module connects a joystick or a game pad for playing games, and MIDI devices for playing or editing audio files.

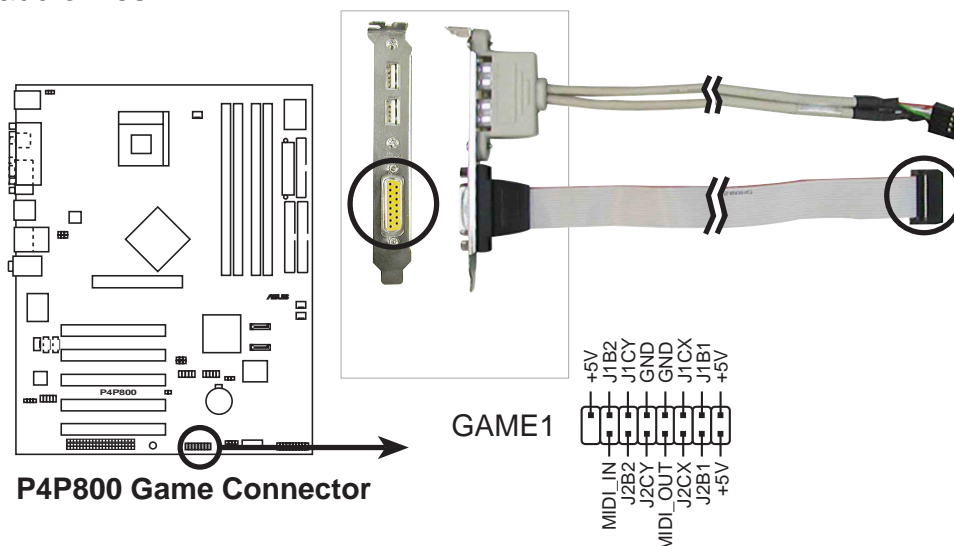

The GAME port module is an optional item not included in this motherboard package.

12. Internal audio connectors (4-pin CD1, AUX1, MODEM)

These connectors allow you to receive stereo audio input from sound sources such as a CD-ROM, TV tuner, or MPEG card. The MODEM connector allows the onboard audio to interface with a voice modem card with a similar connector. It also allows the sharing of mono_in (such as a phone) and a mono_out (such as a speaker) between the audio and a voice modem card.

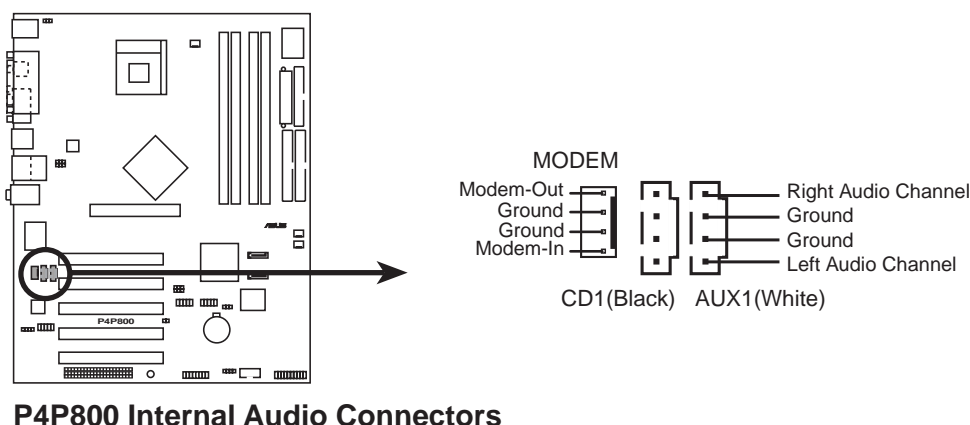

13. Front panel audio connector (10-1 pin FP_AUDIO)

This is an interface for the Intel front panel audio cable that allow convenient connection and control of audio devices.

By default, the pins labeled LINE_OUT_R/BLINE_OUT_R and the pins LINE_OUT_L/BLINE_OUT_L are shorted with jumper caps. Remove the caps only when you are connecting the front panel audio cable.

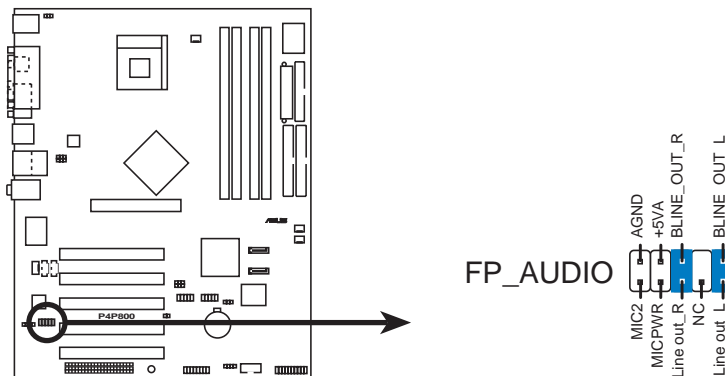

P4P800 Front Panel Audio Connector

14. Digital Audio connector (6-1 pin SPDIF_OUT)

This connector is for the S/PDIF audio module to allow digital sound output. Connect one end of the S/PDIF audio cable to this connector and the other end to the S/PDIF module.

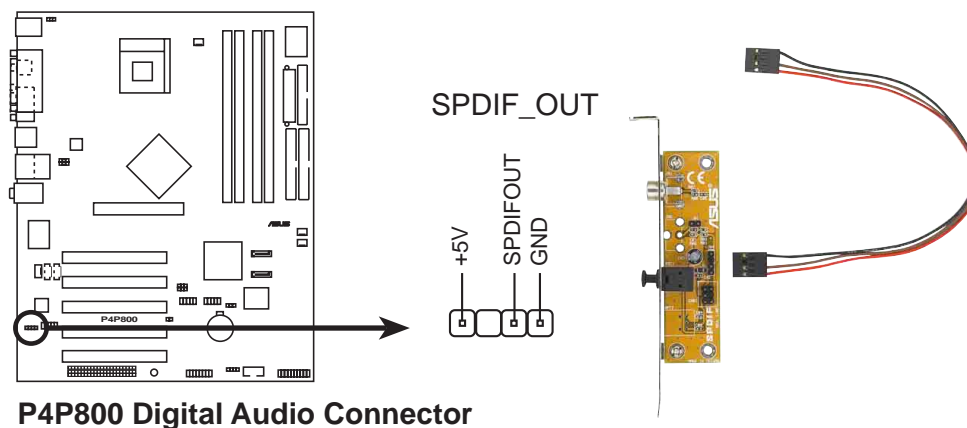

P4P800 Digital Audio Connector



The S/PDIF module is not included in this motherboard package.

15. Serial Port 2 connector (10-1 pin COM2)

This connector accommodates a second serial port using an optional serial port bracket. Connect the bracket cable to this connector then install the bracket into a slot opening at the back of the system chassis.

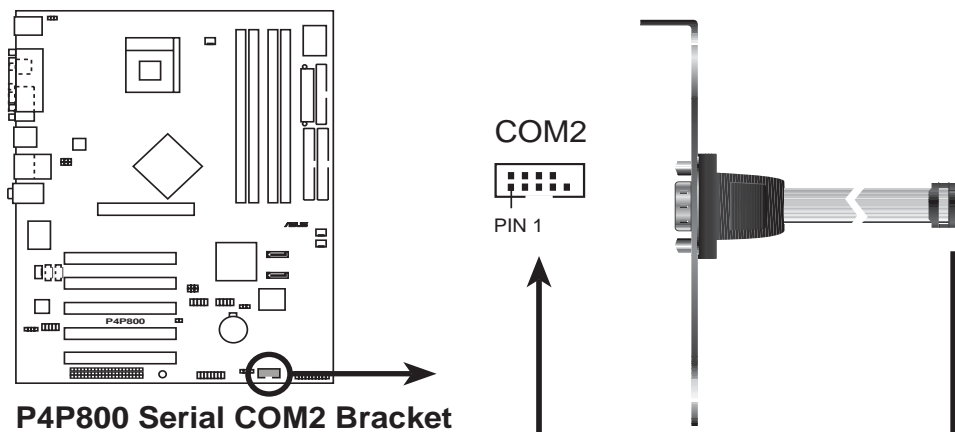

P4P800 Serial COM2 Bracket



The COM2 module is not included in this motherboard package.

16. System panel connector (20-pin PANEL)

This connector accommodates several system front panel functions.

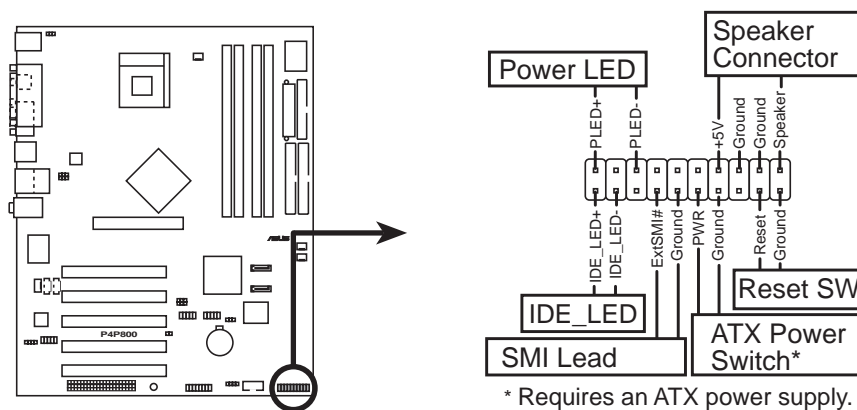

P4P800 System Panel Connectors

- **System Power LED Lead (3-1 pin PLED)**

This 3-1 pin connector connects to the system power LED. The LED lights up when you turn on the system power, and blinks when the system is in sleep mode.

- **System Warning Speaker Lead (4-pin SPKR)**

This 4-pin connector connects to the case-mounted speaker and allows you to hear system beeps and warnings.
- **System Management Interrupt Lead (2-pin SMI)**

This 2-pin connector allows you to manually place the system into a suspend mode, or “green” mode, where system activity is instantly decreased to save power and to expand the life of certain system components. Attach the case-mounted suspend switch to this 2-pin connector.
- **ATX Power Switch / Soft-Off Switch Lead (2-pin PWRBTN)**

This connector connects a switch that controls the system power. Pressing the power switch turns the system between ON and SLEEP, or ON and SOFT OFF, depending on the BIOS or OS settings. Pressing the power switch while in the ON mode for more than 4 seconds turns the system OFF.
- **Reset Switch Lead (2-pin RESET)**

This 2-pin connector connects to the case-mounted reset switch for rebooting the system without turning off the system power.
- **Hard disk activity LED (2-pin IDE_LED)**

This connector supplies power to the hard disk activity LED. Any read or write activity of an IDE device cause this LED to light up.

Chapter 3

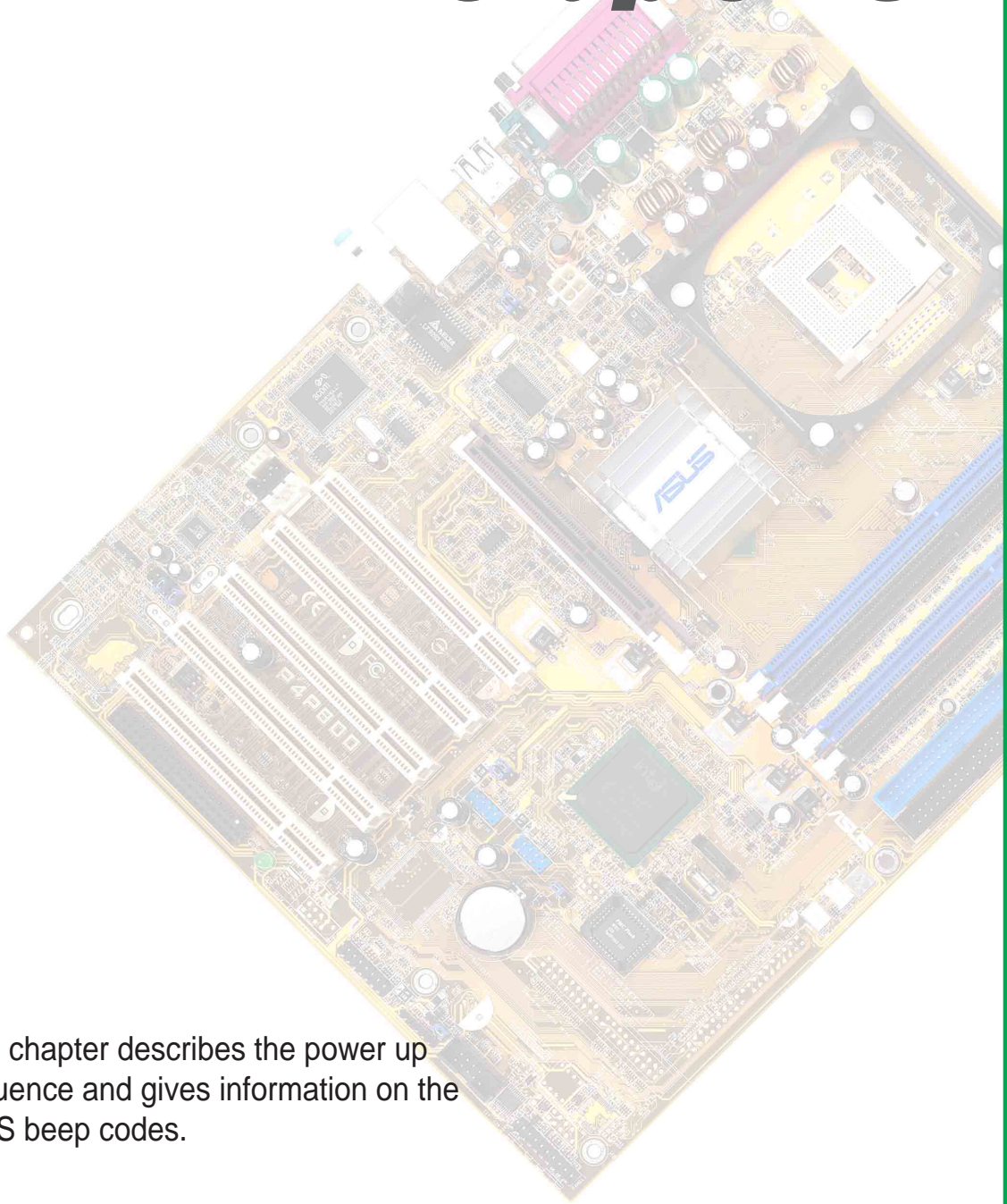

This chapter describes the power up sequence and gives information on the BIOS beep codes.

Powering up

Chapter summary

- 3.1 Starting up for the first time 3-1**
- 3.2 Powering off the computer 3-2**

3.1 Starting up for the first time

1. After making all the connections, replace the system case cover.
2. Be sure that all switches are off.
3. Connect the power cord to the power connector at the back of the system chassis.
4. Connect the power cord to a power outlet that is equipped with a surge protector.
5. Turn on the devices in the following order:
 - a. Monitor
 - b. External SCSI devices (starting with the last device on the chain)
 - c. System power
6. After applying power, the power LED on the system front panel case lights up. For ATX power supplies, the system LED lights up when you press the ATX power switch. If your monitor complies with “green” standards or if it has a “power standby” feature, the monitor LED may light up or switch between orange and green after the system LED turns on. The system then runs the power-on tests. While the tests are running, the BIOS beeps or additional messages appear on the screen. If you do not see anything within 30 seconds from the time you turned on the power, the system may have failed a power-on test. Check the jumper settings and connections or call your retailer for assistance.
7. At power on, hold down <Delete> to enter BIOS Setup. Follow the instructions in Chapter 4.

3.2 Powering off the computer

You must first exit the operating system and shut down the system before switching off the power. For ATX power supplies, you can press the ATX power switch after exiting or shutting down the operating system. If you use Windows ME/2000/XP, click the Start button, click Shut Down, then click the OK button to shut down the computer. The power supply should turn off after Windows shuts down.



- The message “You can now safely turn off your computer” does not appear when shutting down with ATX power supplies.
- If the OS fails to shut down the computer, press and hold the power button for 4 seconds to shut down the computer.

Using the dual function power switch

While the system is ON, pressing the power switch for less than 4 seconds puts the system to sleep mode or to soft-off mode, depending on the BIOS setting. Pressing the power switch for more than 4 seconds lets the system enter the soft-off mode regardless of the BIOS setting. See section “4.5 Power Menu” in Chapter 4.

Using the OS shut down function

If you use Windows 98SE/ME/2000/XP, click the **Start** button, click **Shut Down**, then the **OK** button to shut down the computer. The power supply should turn off after Windows shuts down.

Chapter 4

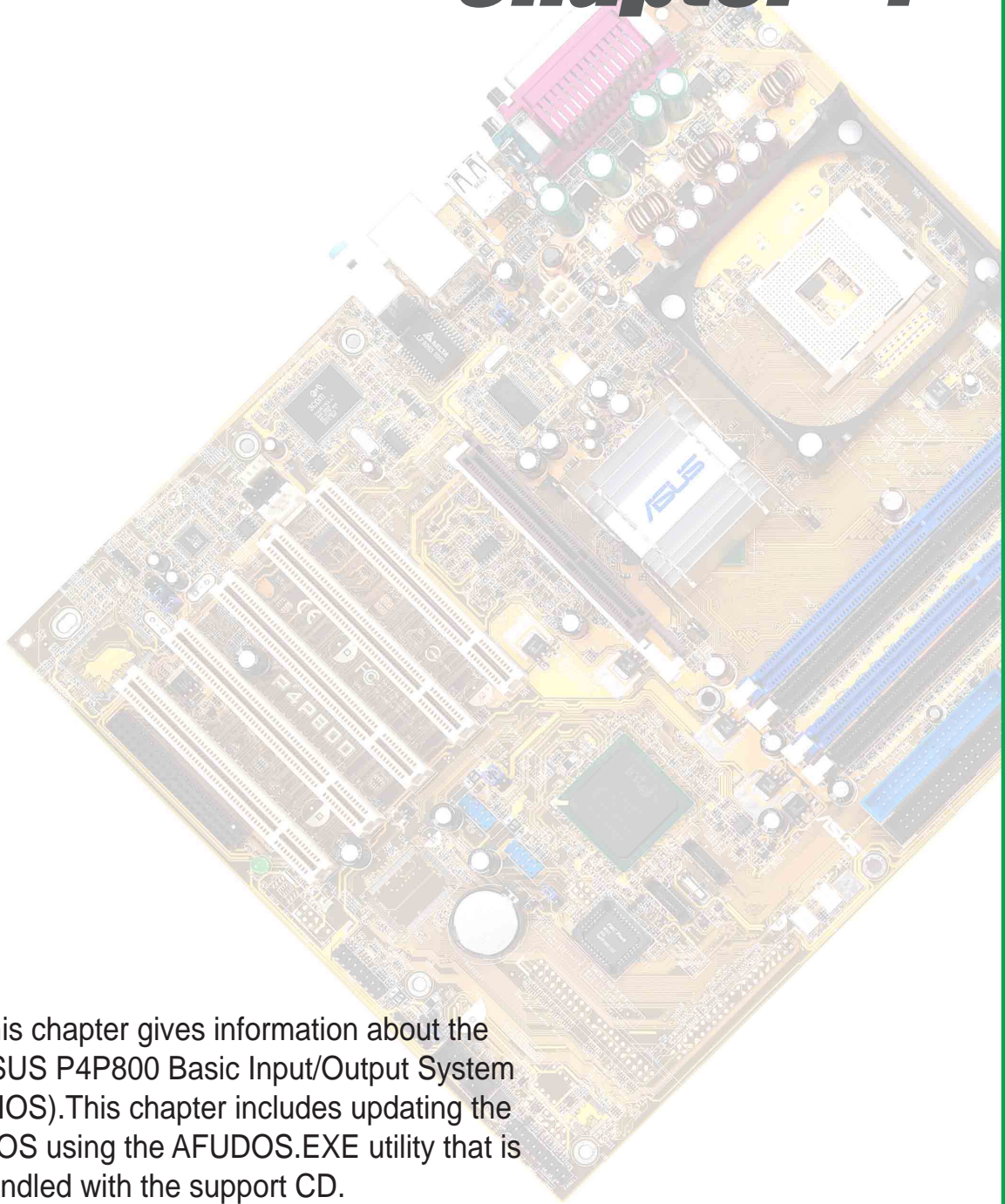

This chapter gives information about the ASUS P4P800 Basic Input/Output System (BIOS). This chapter includes updating the BIOS using the AFUDOS.EXE utility that is bundled with the support CD.

BIOS setup

Chapter summary

4.1	Managing and updating your BIOS	4-1
4.2	BIOS Setup program	4-6
4.3	Main Menu	4-9
4.4	Advanced Menu	4-14
4.5	Power Menu	4-25
4.6	Boot Menu	4-30
4.7	Exit Menu	4-35

4.1 Managing and updating your BIOS



-
- The **original BIOS file** for this motherboard is in the support CD.
 - Copy the original BIOS to a **bootable floppy disk** in case you need to restore the BIOS in the future.
-

4.1.1 Creating a bootable floppy disk

1. Do either one of the following to create a bootable floppy disk.

DOS environment

Insert a 1.44 MB floppy disk into the drive. At the DOS prompt, type:

format A:/S , then press the <Enter> key

Windows environment

- a. From your Windows desktop, click on **Start**, point to **Settings**, then click on **Control Panel**.
 - b. Double-click on **Add/Remove Programs** icon from the Control Panel window.
 - c. Click on the **Startup Disk** tab, then on **Create Disk...** button.
 - d. Insert a 1.44 MB floppy disk when prompted. Follow the succeeding screen instructions to complete the process.
2. Copy the original (or the latest) motherboard BIOS to the bootable floppy disk.

4.1.2 Using AFUDOS to update the BIOS

Update the BIOS using the AFUDOS.EXE utility in DOS environment.

1. Visit the ASUS website (www.asus.com) to download the latest BIOS file for your motherboard. Save the BIOS file to a bootable floppy disk.



Write down the BIOS file name to a piece of paper. You need to type the **exact BIOS file name** at the prompt.

2. Copy the AFUDOS.EXE utility from the support CD to the bootable floppy disk that contains the BIOS file.
3. Boot the system from the floppy disk.

4. At the DOS prompt, type the command line:

afudos /i<filename.rom>

where “filename.rom” means the latest (or original) BIOS file that you copied to the bootable floppy disk.

The screen displays the status of the update process.



The BIOS information on the screen is for reference only. What you see on your screen may not be exactly the same as shown.

```
A:\>afudos /iP4P800.rom
AMI Firmware Update Utility - Version 1.10
Copyright (C) 2002 American Megatrends, Inc. All rights reserved.

Reading file ..... done
Erasing flash .... done
Writing flash .... 0x0008CC00 (9%)
```



DO NOT shutdown or reset the system while updating the BIOS! Doing so may cause system boot failure!

When the BIOS update process is complete, the utility returns to the DOS prompt.

```
A:\>afudos /iP4P800.rom
AMI Firmware Update Utility - Version 1.10
Copyright (C) 2002 American Megatrends, Inc. All rights reserved.

Reading file ..... done
Erasing flash .... done
Writing flash .... 0x0008CC00 (9%)
Verifying flash .. done

A:\>
```

5. Reboot the system from the hard disk.

4.1.3 Using ASUS EZ Flash to update the BIOS

The ASUS EZ Flash feature allows you to easily update the BIOS without having to go through the long process of booting from a diskette and using a DOS-based utility. The EZ Flash is built-in the BIOS firmware so it is accessible by simply pressing <Alt> + <F2> during the Power-On Self Tests (POST).

To update the BIOS using ASUS EZ Flash:

1. Visit the ASUS website (www.asus.com) to download the latest BIOS file for your motherboard and rename the downloaded file as **P4P800.ROM**. Save the BIOS file to a floppy disk.
2. Reboot the system.
3. To launch EZ Flash, press <Alt> + <F2> during POST to display the following.

```
User recovery requested. Starting BIOS recovery...
Checking for floppy...
```



- If there is no floppy disk found in the drive, the error message “**Floppy not found!**” appears.
- If the correct BIOS file is not found in the floppy disk, the error message “**P4P800.ROM not found!**” is displayed. Make sure to rename the downloaded BIOS file as “**P4P800.ROM**”.

4. Insert the floppy disk that contains the BIOS file. If all the necessary files are found in the floppy disk, EZ Flash performs the BIOS update process and automatically reboots the system when done.



DO NOT shutdown or reset the system while updating the BIOS! Doing so may cause system boot failure!

```
User recovery requested. Starting BIOS recovery...
Checking for floppy...
Floppy found!
Reading file "P4P800.rom". Completed.
Start flashing...
Flashed successfully. Rebooting.
```

4.1.4 Recovering the BIOS with CrashFree BIOS 2

The CrashFree BIOS 2 auto recovery tool allows you to restore BIOS from the motherboard support CD, or from a floppy disk that contains the BIOS file, in case the current BIOS on the motherboard fails or gets corrupted.



1. Prepare the **support CD** that came with the motherboard or a **floppy disk that contains the motherboard BIOS** before proceeding with the BIOS update process.
2. If you have saved a copy of the original motherboard BIOS to a bootable floppy disk, you may also use this disk to restore the BIOS. See section “4.1.1 Creating a bootable floppy disk.”

To recover the BIOS from a floppy disk:

1. Boot the system.
2. When a corrupted BIOS is detected, the following screen message appears.

```
Bad BIOS checksum. Starting BIOS recovery...
Checking for floppy...
```

3. Insert a floppy disk that contains the original or the latest BIOS file for this motherboard. If all the necessary files are found in the floppy disk, the BIOS update process continues.



Make sure that the BIOS file in the floppy disk is renamed as **“P4P800.ROM”**.

```
Bad BIOS checksum. Starting BIOS recovery...
Checking for floppy...
Floppy found!
Reading file "P4P800.rom". Completed.
Start flashing...
```



DO NOT shutdown or reset the system while updating the BIOS! Doing so may cause system boot failure!

4. When the BIOS update process is complete, reboot the system.

To recover the BIOS from the support CD:

1. Boot the system.
2. When a corrupted BIOS is detected, the following screen message appears.

```
Bad BIOS checksum. Starting BIOS recovery...  
Checking for floppy...
```



If there is no floppy disk found in the drive, the system automatically checks the CD-ROM.

3. Place the support CD in the CD-ROM. The support CD contains the original BIOS for this motherboard.

```
Bad BIOS checksum. Starting BIOS recovery...  
Checking for floppy...  
Floppy not found!  
Checking for CD-ROM...  
CD-ROM found.  
Reading file "P4P800.rom". Completed.  
Start flashing...
```



DO NOT shutdown or reset the system while updating the BIOS! Doing so may cause system boot failure!

4. When the BIOS update process is complete, reboot the system.



The recovered BIOS may not be the latest BIOS version for this motherboard. Visit ASUS website (www.asus.com) to download the latest BIOS file.

4.2 BIOS Setup program

This motherboard supports a programmable firmware hub (FWH) that you can update using the provided utility described in section “4.1 Managing and updating your BIOS.”

Use the BIOS Setup program when you are installing a motherboard, reconfiguring your system, or prompted to “Run Setup”. This section explains how to configure your system using this utility.

Even if you are not prompted to use the Setup program, you may want to change the configuration of your computer in the future. For example, you may want to enable the security password feature or change the power management settings. This requires you to reconfigure your system using the BIOS Setup program so that the computer can recognize these changes and record them in the CMOS RAM of the firmware hub.

The firmware hub on the motherboard stores the Setup utility. When you start up the computer, the system provides you with the opportunity to run this program. Press <Delete> during the Power-On Self Test (POST) to enter the Setup utility. Otherwise, POST continues with its test routines.

If you wish to enter Setup after POST, restart the system by pressing <Ctrl> + <Alt> + <Delete>, or by pressing the reset button on the system chassis. You can also restart by turning the system off and then back on. Do this last option only if the first two failed.

The Setup program is designed to make it as easy to use as possible. It is a menu-driven program, which means you can scroll through the various sub-menus and make your selections from the available options using the navigation keys.



The default BIOS settings for this motherboard apply for most conditions to ensure optimum performance. If the system becomes unstable after changing any BIOS settings, load the default settings to ensure system compatibility and stability. Select the **Load Default Settings** item under the Exit Menu. See section “4.7 Exit Menu.”



The BIOS setup screens shown in this chapter are for reference purposes only, and may not exactly match what you see on your screen.

Visit the ASUS website (www.asus.com) to download the latest product and BIOS information.

4.2.1 BIOS menu screen

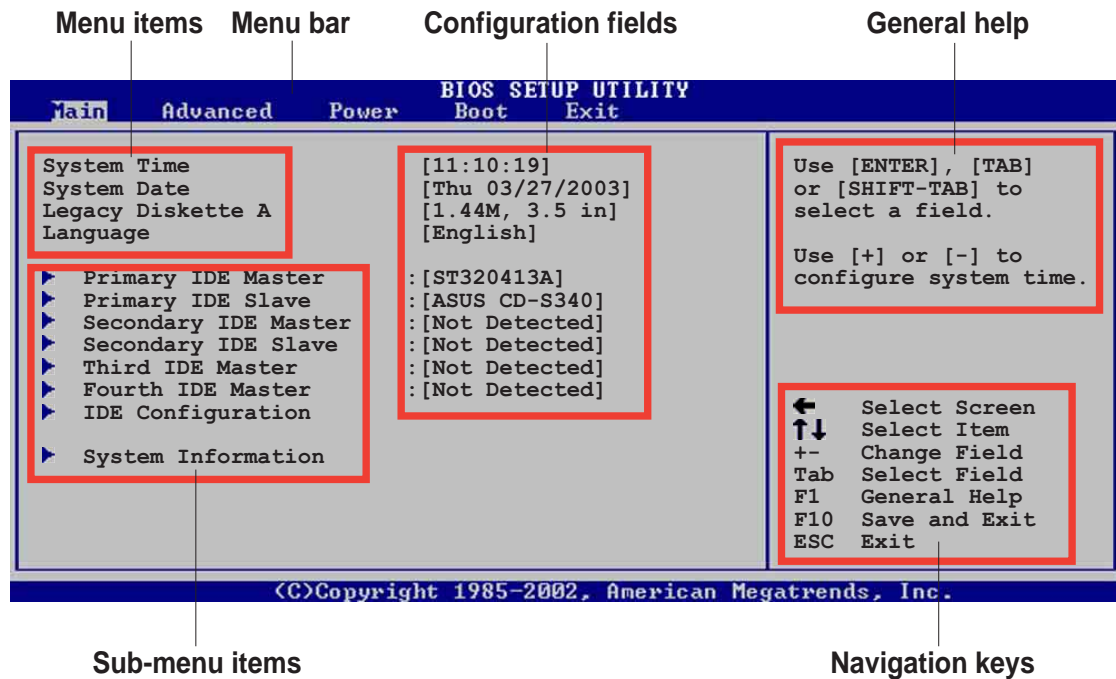

4.2.2 Menu bar

The menu bar on top of the screen has the following main items:

- Main** For changing the basic system configuration
- Advanced** For changing the advanced system settings
- Power** For changing the advanced power management (APM) configuration
- Boot** For changing the system boot configuration
- Exit** For selecting the exit options and loading default settings

To select an item on the menu bar, press the right or left arrow key on the keyboard until the desired item is highlighted.

4.2.3 Navigation keys

At the **bottom right corner** of a menu screen are the navigation keys for that particular menu. Use the navigation keys to select items in the menu and change the settings.



Some of the navigation keys differ from one screen to another.

4.2.4 Menu items

The highlighted item on the menu bar displays the specific items for that menu. For example, selecting **Main** shows the Main menu items.

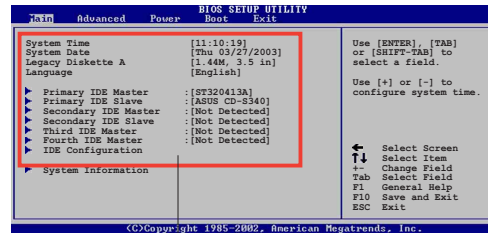

Main menu items

The other items (Advanced, Power, Boot, and Exit) on the menu bar have their respective menu items.

4.2.5 Sub-menu items

An item with a sub-menu on any menu screen is distinguished by a solid triangle before the item. To display the sub-menu, select the item and press Enter.

4.2.6 Configuration fields

These fields show the values for the menu items. If an item is user-configurable, you may change the value of the field opposite the item. You can not select an item that is not user-configurable.

A configurable field is enclosed in brackets, and is highlighted when selected. To change the value of a field, select it then press Enter to display a list of options. Refer to “4.2.7 Pop-up window.”

4.2.7 Pop-up window

Select a menu item then press Enter to display a pop-up settings window with the configuration options for that item.

4.2.8 Scroll bar

A scroll bar appears on the right side of a menu screen when there are items that do not fit on the screen. Press **Up/Down arrow keys** or **PageUp/PageDown keys** to display the other items on the screen.

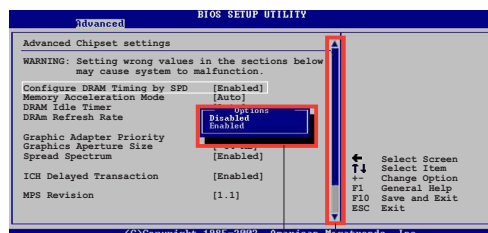

Pop-up window

Scroll bar

4.2.9 General help

At the top right corner of the menu screen is a brief description of the selected item.

4.3 Main menu

When you enter the BIOS Setup program, the Main menu screen appears giving you an overview of the basic system information.



Refer to section “4.2.1 BIOS menu screen” for information on the menu screen items and how to navigate through them.

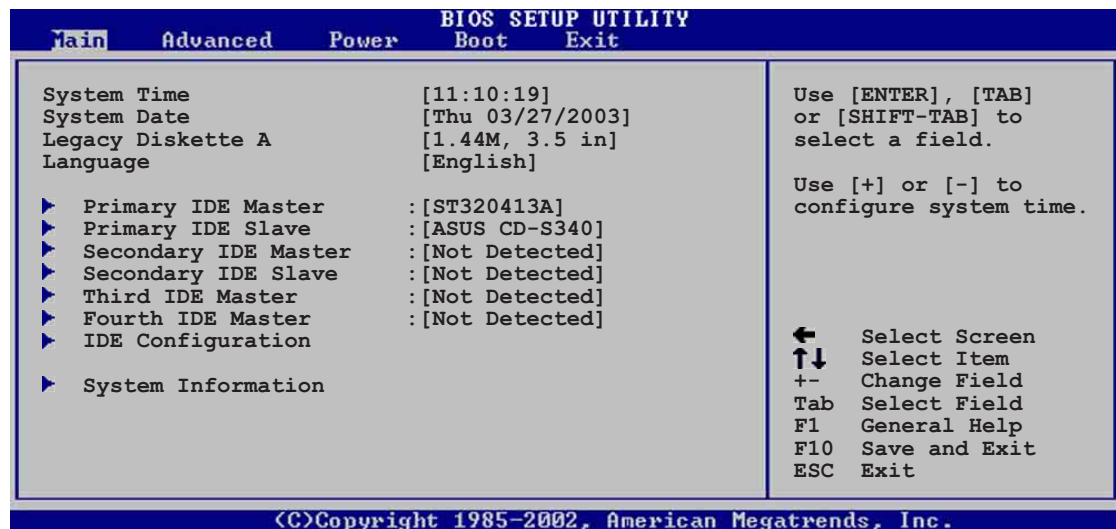

4.3.1 System Time [xx:xx:xxxx]

This item allows you to set the system time.

4.3.2 System Date [Day xx/xx/xxxx]

This item allows you to set the system date.

4.3.3 Legacy Diskette A [1.44M, 3.5 in.]

Sets the type of floppy drive installed. Configuration options: [Disabled] [360K, 5.25 in.] [1.2M , 5.25 in.] [720K , 3.5 in.] [1.44M, 3.5 in.] [2.88M, 3.5in.]

4.3.4 Language [English]

This field allows you to choose the BIOS language version from the available options.

4.3.5 Primary and Secondary IDE Master/Slave; Third and Fourth IDE Master

While entering Setup, BIOS auto-detects the presence of IDE devices. There is a separate sub-menu for each IDE device. Select a device item then press Enter to display the IDE device information.

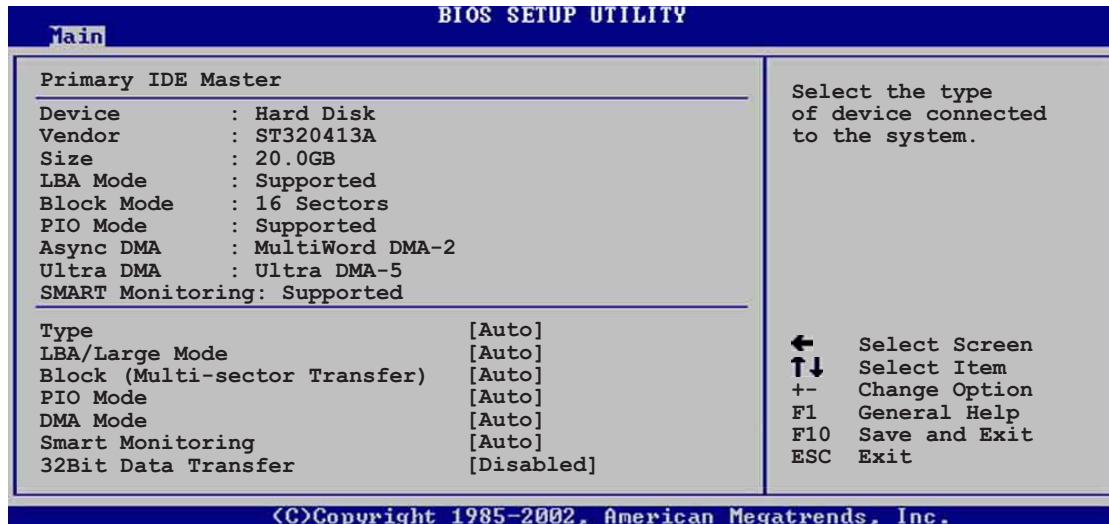

The values opposite the dimmed items (Device, Vendor, Size, LBA Mode, Block Mode, PIO Mode, Async DMA, Ultra DMA, and SMART monitoring) are auto-detected by BIOS and are not user-configurable. These items show N/A if no IDE device is installed in the system.

Type [Auto]

Selects the type of IDE drive. Setting to Auto allows automatic selection of the appropriate IDE device type. Select CDROM if you are specifically configuring a CD-ROM drive. Select ARMD (ATAPI Removable Media Device) if your device is either a ZIP, LS-120, or MO drive. Configuration options: [Not Installed] [Auto] [CDROM] [ARMD]

LBA/Large Mode [Auto]

Enables or disables the LBA mode. Setting to Auto enables the LBA mode if the device supports this mode, and if the device was not previously formatted with LBA mode disabled. Configuration options: [Disabled] [Auto]

Block (Multi-sector Transfer) [Auto]

Enables or disables data multi-sectors transfers. When set to Auto, the data transfer from and to the device occurs multiple sectors at a time if the device supports multi-sector transfer feature. When set to Disabled, the data transfer from and to the device occurs one sector at a time. Configuration options: [Disabled] [Auto]

PIO Mode [Auto]

Selects the PIO mode. Configuration options: [Auto] [0] [1] [2] [3] [4]

DMA Mode [Auto]

Selects the DMA mode. Configuration options: [Auto] [SWDMA0] [SWDMA1] [SWDMA2] [MWDMA0] [MWDMA1] [MWDMA2] [UDMA0] [UDMA1] [UDMA2] [UDMA3] [UDMA4] [UDMA5]

SMART Monitoring [Auto]

Sets the Smart Monitoring, Analysis, and Reporting Technology. Configuration options: [Auto] [Disabled] [Enabled]

32Bit Data Transfer [Disabled]

Enables or disables 32-bit data transfer. Configuration options: [Disabled] [Enabled]

4.3.6 IDE Configuration

The items in this menu allow you to set or change the configurations for the IDE devices installed in the system. Select an item then press Enter if you wish to configure the item.

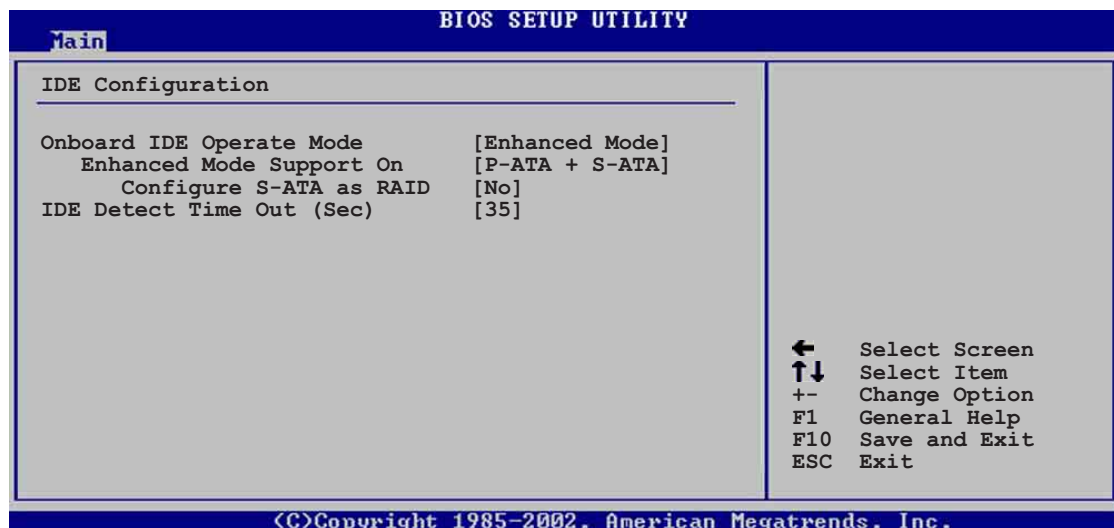

Onboard IDE Operate Mode [Enhanced Mode]

Allows selection of the IDE operation mode depending on the operating system (OS) that you installed. Set to Enhanced Mode if you are using native OS, such as Windows 2000/XP. Set to Compatible Mode if you are using legacy OS including MS-DOS, Windows ME/98/NT4.0.

Configuration options: [Compatible Mode] [Enhanced Mode]



Refer to the section “Parallel ATA and Serial ATA device configurations” on page 2-24 for the appropriate settings of the IDE Configuration items under different operating systems.

Enhanced Mode Support On [S-ATA]

The default setting S-ATA allows you to use native OS on Serial ATA and Parallel ATA ports. We recommend that you do not change the default setting for better OS compatibility. In this setting, you may use legacy OS on the Parallel ATA ports **only if** you did not install any Serial ATA device.

The P-ATA+S-ATA and P-ATA options are for advanced users only. If you set to any of these options and encounter problems, revert to the default setting **S-ATA**.

Configuration options: [P-ATA+S-ATA] [S-ATA] [P-ATA]



The **Enhanced Mode Support On** appears only when the item **Onboard IDE Operate Mode** is set to **Enhanced Mode**.

Configure S-ATA as RAID [No]

This field configures the S-ATA to function as an IDE controller or RAID. Configuration options: [Yes] [No]

Serial ATA BOOTROM [Enabled]

This field enables or disables the Serial ATA boot ROM.

Configuration options: [Disabled] [Enabled]



The **Serial ATA BOOTROM** item appears only when the item **Configure S-ATA as RAID** is set to **[Yes]**.

IDE Port Settings [Primary P-ATA+S-ATA]

Allows selection of the IDE ports to activate if you are using a **legacy** operating system. Set to [Primary P-ATA+S-ATA] if you wish to use the primary Parallel ATA and Serial ATA ports, or set to [Secondary P-ATA+SATA] to enable the secondary P-ATA port instead. Setting to [P-ATA Ports Only] disables the two Serial ATA ports supported by ICH5. Configuration options: [Primary P-ATA+S-ATA] [Secondary P-ATA+S-ATA] [P-ATA Ports Only]



The **IDE Port Settings** appears only when the item **Onboard IDE Operate Mode** is set to **Compatible Mode**.

IDE Detect Time Out [35]

Selects the time out value for detecting ATA/ATAPI devices. Configuration options: [0] [5] [10] [15] [20] [25] [30] [35]

4.3.7 System Information

This menu gives you an overview of the general system specifications. The items in this menu are auto-detected by BIOS.

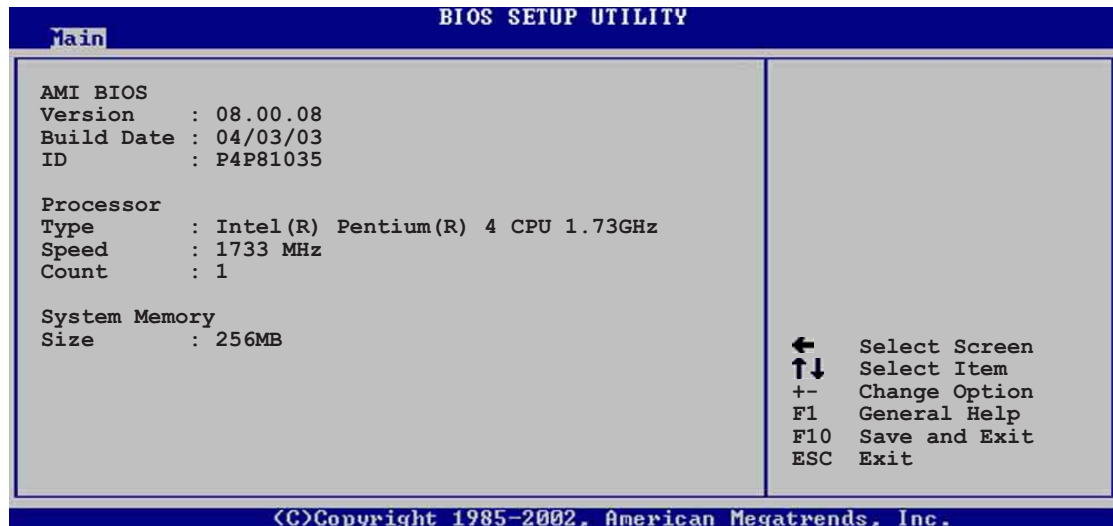

AMI BIOS

This item displays the auto-detected BIOS information.

Processor

This item displays the auto-detected CPU specification.

System Memory

This item displays the auto-detected system memory.

4.4 Advanced menu

The Advanced menu items allow you to change the settings for the CPU and other system devices.



Take caution when changing the settings of the Advanced menu items. Incorrect field values may cause the system to malfunction.

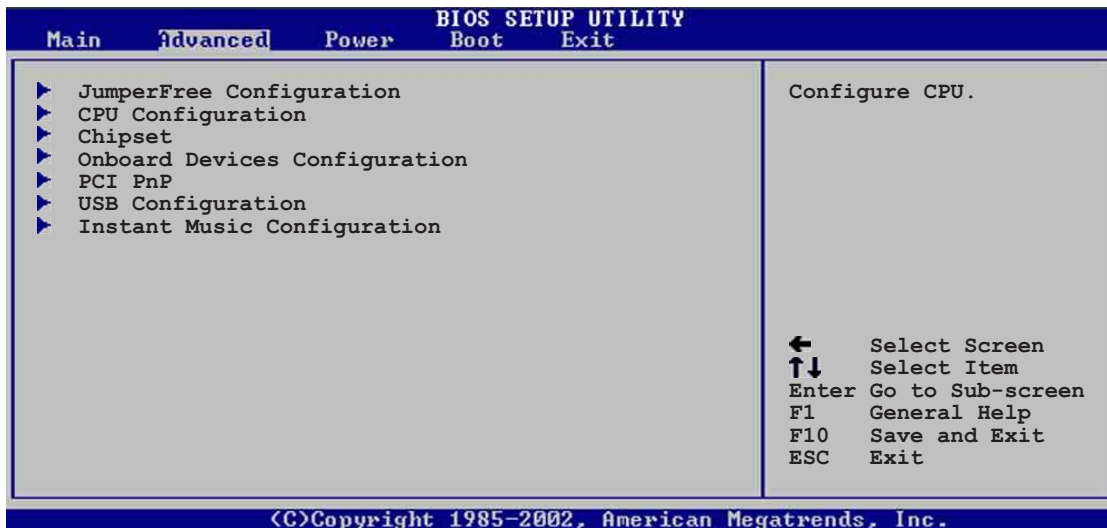

4.4.1 JumperFree Configuration

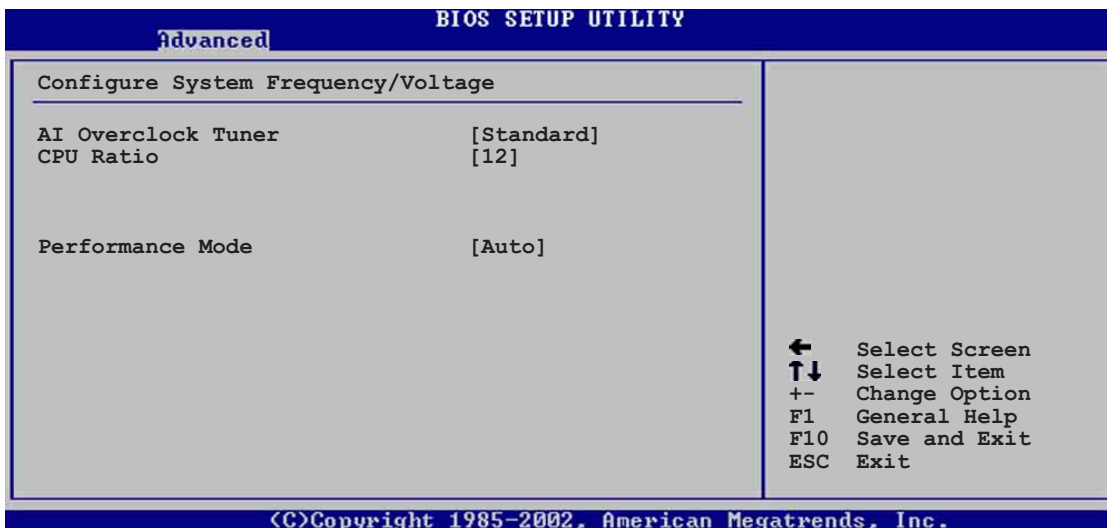

AI Overclock Tuner [Standard]

Allows selection of CPU overclocking options to achieve desired CPU internal frequency. Select either one of the preset overclocking options. Configuration options: [Manual] [Standard] [Overclock 5%] [Overclock 10%] [Overclock 20%] [Overclock 30]



Selecting a very high CPU frequency may cause the system to become unstable! If this happens, revert to the default setting.



If you are using an unlocked CPU, the item **CPU Ratio** appears under the AI Overclock Tuner item. You may select your desired ratio from the available options.

CPU Ratio [12]

This field sets the ratio between the CPU Core Clock and the Front Side Bus (FSB) Frequency.



If an invalid ratio is set in CMOS, the actual and setpoint values may differ.

Performance Mode [Auto]

Allows enhanced system performance. Setting to [Turbo] may cause the system to become unstable. If this happens, revert to the default setting [Auto]. Configuration options: [Auto] [Standard] [Turbo]

When you set the **AI Overclocking Tuner** item to [Manual], the related overclocking items appear.

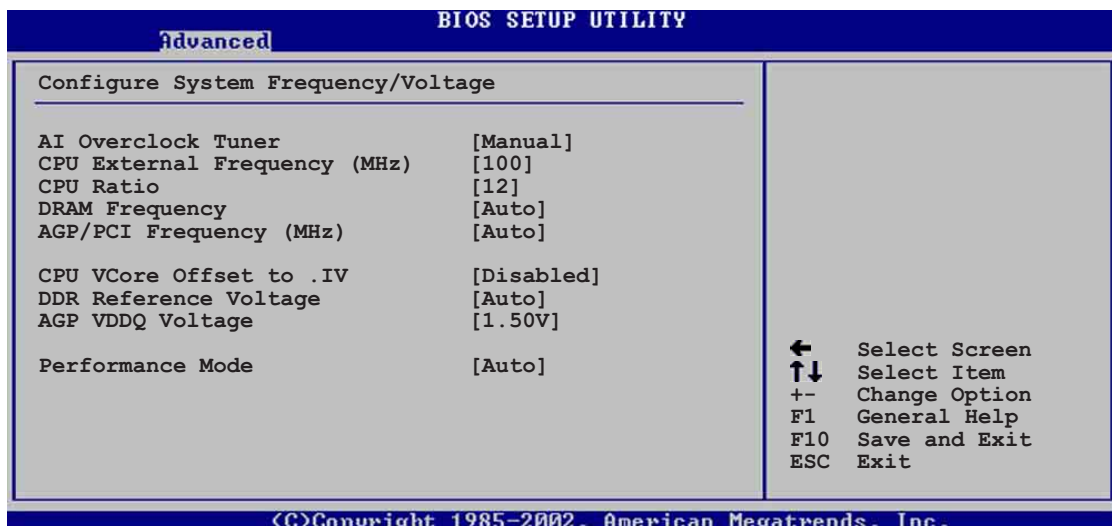

CPU External Frequency (MHz) [XXX] (value is auto-detected)

Indicates the frequency sent by the clock generator to the system bus and PCI bus. The bus frequency (external frequency) multiplied by the bus multiple equals the CPU speed. The value of this item is auto-detected by BIOS and is not manually configurable. The values range from 100 to 400. Refer to the following table for the correct Front Side Bus and CPU External Frequency settings.

Table 4.4.1 FSB/CPU External Frequency Synchronization

Front Side Bus	CPU External Frequency
FSB 800	200 MHz
FSB 533	133 MHz
FSB 400	100 MHz

DRAM Frequency [Auto]

Allows you to set the DDR operating frequency. Configuration options: [266 MHz] [333 MHz] [400 MHz] [Auto]

AGP/PCI Frequency (MHz) [Auto]

Allows you to adjust to a higher AGP/PCI frequency for better system performance and overclocking capability. Configuration options: [Auto] [66.66/33.33] [72.73/36.36] [80.00/40.00]



Selecting a very high AGP/PCI frequency may cause the system to become unstable! If this happens, revert to the default setting.

CPU VCore Voltage [Auto]

Allows you to select a specific CPU VCore voltage. Configuration options: [Auto] [1.6000V] ... [1.4750V]



Refer to the CPU documentation before setting the CPU VCore voltage. A very high Vcore voltage may severely damage the CPU!

DDR Reference Voltage [Auto]

Allows selection of the DDR SDRAM operating voltage. Configuration options: [2.85V] [2.75V] [2.65V] [2.55V] [Auto]

AGP VDDQ voltage [1.50V]

Allows selection of the AGP operating voltage. Configuration options: [1.80V] [1.70V] [1.60V] [1.50V]

4.4.2 CPU Configuration

The items in this menu show the CPU-related information auto-detected by BIOS.

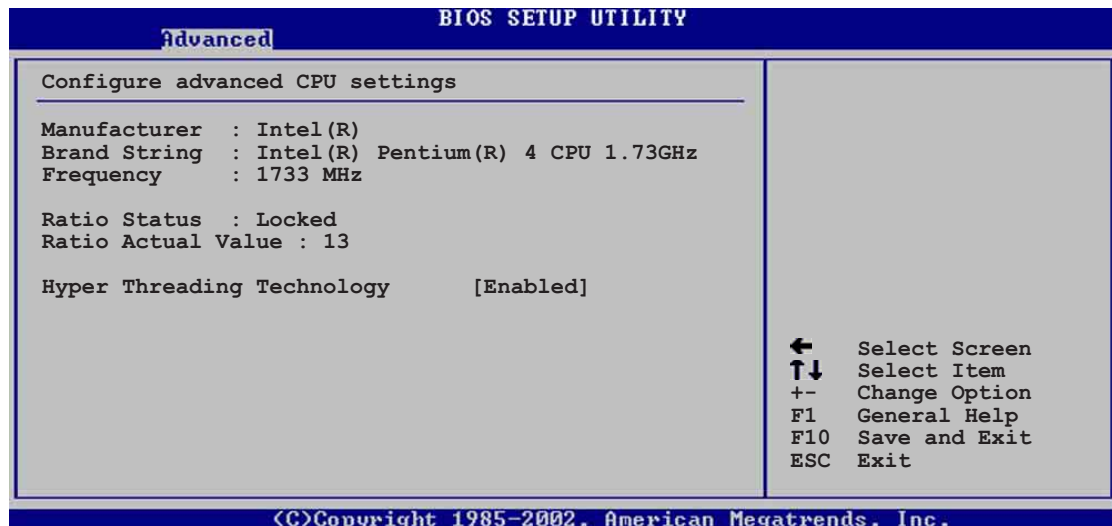

Hyper-Threading Technology [Enabled]

This item allows you to enable or disable the processor Hyper-Threading Technology. Configuration options: [Disabled] [Enabled]



The item **Hyper-Threading Technology** appears only if you installed an Intel Pentium 4 CPU that supports this feature.

4.4.3 Chipset

The Chipset menu items allow you to change the advanced chipset settings. Select an item then press Enter to display the sub-menu.

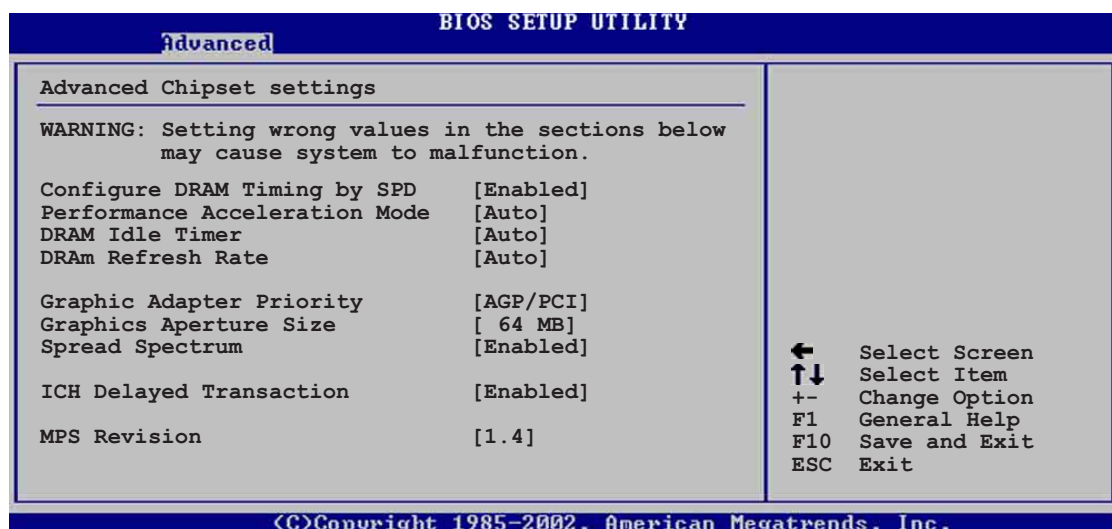

Configure DRAM Timing by SPD [Enabled]

When this item is enabled, the DRAM timing parameters are set according to the DRAM SPD (Serial Presence Detect). When disabled, you can manually set the DRAM timing parameters through the DRAM sub-items. Configuration options: [Disabled] [Enabled]

Memory Acceleration Mode [Auto]

This field when [Enabled] minimize latencies from CPU to memory to boost system performance. Configuration options: [Auto] [Enabled]



Setting to **[Enabled]** may cause the system to become unstable! If this happens, revert to the default setting **[Auto]**.

DRAM Idle Timer [Auto]

Configuration options: [Infinite] [0T] [8T] [16T] [64T] [Auto]

DRAM Refresh Mode [Auto]

Configuration options: [Auto] [15.6 uSec] [7.8 uSec] [64 uSec] [64T]



If the system becomes unstable after changing the settings of any of the above items, revert to the default settings.



The following sub-items appear only when the item **Configure DRAM Timing by SPD** is set to Disabled.

DRAM CAS# Latency [2.5 Clocks]

This item controls the latency between the SDRAM read command and the time the data actually becomes available. Configuration options: [2.0 Clocks] [2.5 Clocks] [3.0 Clocks]

DRAM RAS# Precharge [4 Clocks]

This item controls the idle clocks after issuing a precharge command to the DDR SDRAM. Configuration options: [4 Clocks] [3 Clocks] [2 Clocks]

DRAM RAS# to CAS# Delay [4 Clocks]

This item controls the latency between the DDR SDRAM active command and the read/write command. Configuration options: [4 Clocks] [3 Clocks] [2 Clocks]

DRAM Precharge Delay [8 Clocks]

Configuration options: [8 Clocks] [7 Clocks] [6 Clocks] [5 Clocks]

DRAM Burst Length [4 Clocks]

Configuration options: [4 Clocks] [8 Clocks]

Graphic Adapter Priority [AGP/PCI]

Allows selection of the graphics controller to use as primary boot device.
Configuration options: [AGP/PCI] [PCI/AGP]

Graphics Aperture Size [64MB]

Allows you to select the size of mapped memory for AGP graphic data.
Configuration options: [4MB] [8MB] [16MB] [32MB] [64MB] [128MB] [256MB]

Spread Spectrum [Enabled]

This field enables or disables the clock generator spread spectrum.
Configuration options: [Disabled] [Enabled]

ICH Delayed Transaction [Enabled]

Configuration options: [Disabled] [Enabled]

MPS Revision [1.4]

Configuration options: [1.1] [1.4]

4.4.4 Onboard Devices Configuration

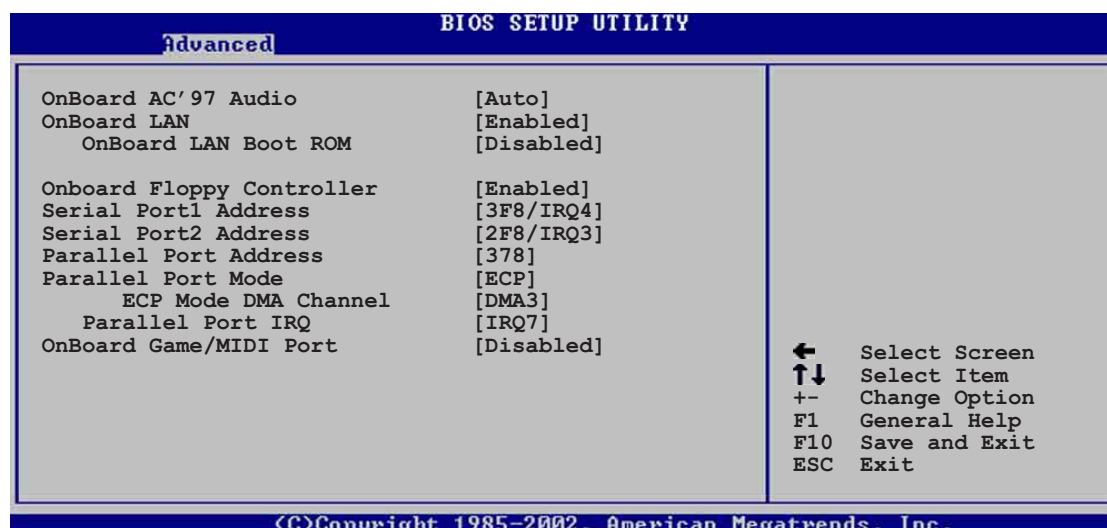

OnBoard AC'97 Audio [Auto]

[Auto] allows the BIOS to detect whether you are using any audio device. If an audio device is detected, the onboard audio controller is enabled; if no audio device is detected, the controller is disabled. Configuration options: [Disabled] [Auto]

OnBoard LAN [Enabled]

Allows you to enable or disable the onboard LAN controller. Configuration options: [Disabled] [Enabled]

OnBoard LAN Boot ROM [Disabled]

Allows you to enable or disable the option ROM in the onboard LAN controller. This item appears only when the Onboard LAN item is set to Enabled. Configuration options: [Disabled] [Enabled]

OnBoard Floppy Controller [Enabled]

Allows you to enable or disable the floppy disk controller. Configuration options: [Disabled] [Enabled]

Serial Port1 Address [3F8/IRQ4]

Allows you to select the Serial Port1 base address. Configuration options: [Disabled] [3F8/IRQ4] [3E8/IRQ4] [2E8/IRQ3]

Serial Port2 Address [2F8/IRQ3]

Allows you to select the Serial Port2 base address. Configuration options: [Disabled] [2F8/IRQ3] [3E8/IRQ4] [2E8/IRQ3]

Parallel Port Address [378]

Allows you to select the Parallel Port base addresses. Configuration options: [Disabled] [378] [278] [3BC]

Parallel Port Mode [ECP]

Allows you to select the Parallel Port mode. Configuration options: [Normal] [Bi-directional] [EPP] [ECP]

ECP Mode DMA Channel [DMA3]

Configuration options: [DMA0] [DMA1] [DMA3]

Parallel Port IRQ [IRQ7]

Configuration options: [IRQ5] [IRQ7]

Onboard Game/MIDI Port [Disabled]

Allows you to select the Game Port address or to disable the port. Configuration options: [Disabled] [200/300] [200/330] [208/300] [208/330]

4.4.5 PCI PnP

The PCI PnP menu items allow you to change the advanced settings for PCI/PnP devices. The menu includes setting IRQ and DMA channel resources for either PCI/PnP or legacy ISA devices, and setting the memory size block for legacy ISA devices.



Take caution when changing the settings of the PCI PnP menu items. Incorrect field values may cause the system to malfunction.

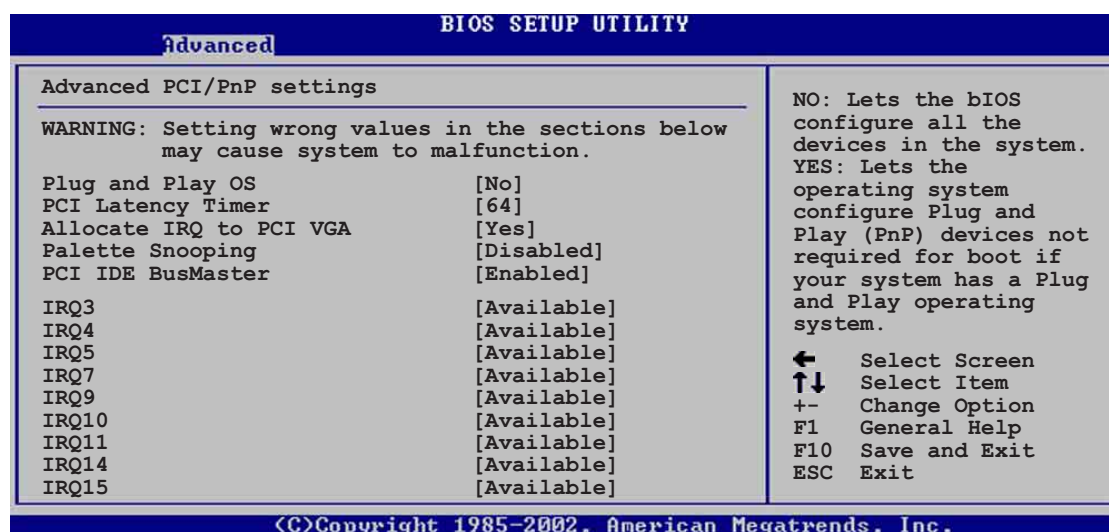

Plug and Play O/S [No]

When set to [No], BIOS configures all the devices in the system. When set to [Yes] and if you installed a Plug & Play operating system, the operating system configures the Plug & Play devices not required for boot.

Configuration options: [No] [Yes]

PCI Latency Timer [64]

Allows you to select the value in units of PCI clocks for the PCI device latency timer register. Configuration options: [32] [64] [96] [128] [160] [192] [224] [248]

Allocate IRQ to PCI VGA [Yes]

When set to [Yes], BIOS assigns an IRQ to PCI VGA card if the card requests for an IRQ. When set to [No], BIOS does not assign an IRQ to the PCI VGA card even if requested. Configuration options: [No] [Yes]

Pallete Snooping [Disabled]

When set to [Enabled], the pallete snooping feature informs the PCI devices that an ISA graphics device is installed in the system so that the latter can function correctly. Setting to [Disabled] deactivates this feature. Configuration options: [Disabled] [Enabled]

PCI IDE BusMaster [Enabled]

Allows BIOS to use PCI bus mastering when reading/writing to IDE devices. Configuration options: [Disabled] [Enabled]

IRQ xx [Available]

When set to [Available], the specific IRQ is free for use of PCI/PnP devices. When set to [Reserved], the IRQ is reserved for legacy ISA devices. Configuration options: [Available] [Reserved]

4.4.6 USB Configuration

The items in this menu allows you to change the USB-related features. Select an item then press Enter to display the configuration options.

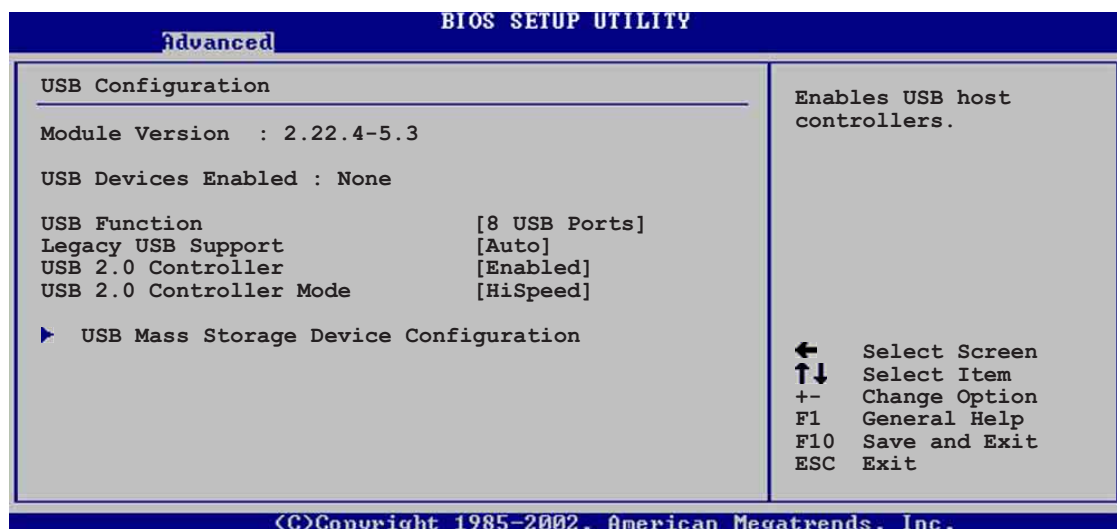

The Module Version and USB Devices Enabled items show the auto-detected values. If no USB device is detected, the item shows None.

USB Function [8 USB Ports]

Allows you to set the number of USB ports to activate. Configuration options: [Disabled] [2 USB Ports] [4 USB Ports] [6 USB Ports] [8 USB Ports]

Legacy USB Support [Auto]

Allows you to enable or disable support for legacy USB devices. Setting to Auto allows the system to detect the presence of USB devices at startup. If detected, the USB controller legacy mode is enabled. If no USB device is detected, the legacy USB support is disabled. Configuration options: [Disabled] [Enabled] [Auto]

USB 2.0 Controller [Enabled]

Allows you to enable or disable the USB 2.0 controller. Configuration options: [Disabled] [Enabled]

USB 2.0 Controller Mode [HiSpeed]

Allows you to configure the USB 2.0 controller in HiSpeed (480 Mbps) or Full Speed (12 Mbps). Configuration options: [HiSpeed] [Full Speed]

USB Mass Storage Device Configuration

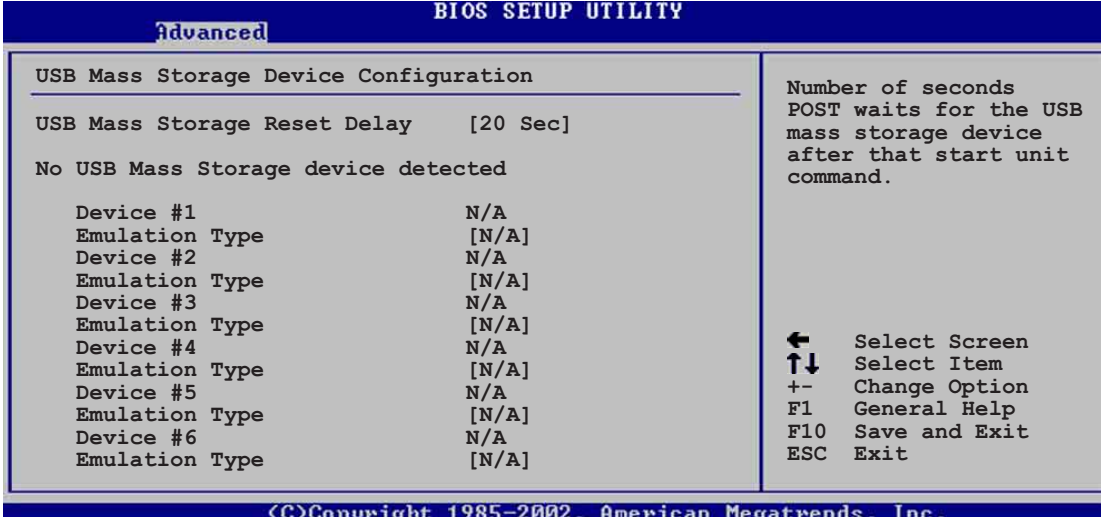

The screenshot shows the BIOS Setup Utility interface. At the top, it says "BIOS SETUP UTILITY" and "Advanced". The main section is titled "USB Mass Storage Device Configuration". It displays "USB Mass Storage Reset Delay [20 Sec]" and "No USB Mass Storage device detected". Below this, there are six rows for "Device #1" through "Device #6", each with "Emulation Type" set to "[N/A]". On the right side, there is a legend for navigation: a left arrow for "Select Screen", up/down arrows for "Select Item", "+-" for "Change Option", "F1" for "General Help", "F10" for "Save and Exit", and "ESC" for "Exit". At the bottom, it says "©Copyright 1985-2002, American Megatrends, Inc."

USB Mass Storage Reset Delay [20 Sec]

Allows you to select the number of seconds POST waits for the USB mass storage device after the start unit command. The message "No USB mass storage device detected" appears if none is installed in the system. Configuration options: [10 Sec] [20 Sec] [30 Sec] [40 Sec]

Emulation Type [N/A]

When set to Auto, USB devices less than 530MB will be emulated as floppy drive, and the remaining drives as hard drives. Forced FDD option can be used to force an HDD formatted drive to boot as FDD (for example, ZIP drive).



The Device and Emulation Type items appear only when there are installed USB devices.

4.4.8 Instant Music Configuration

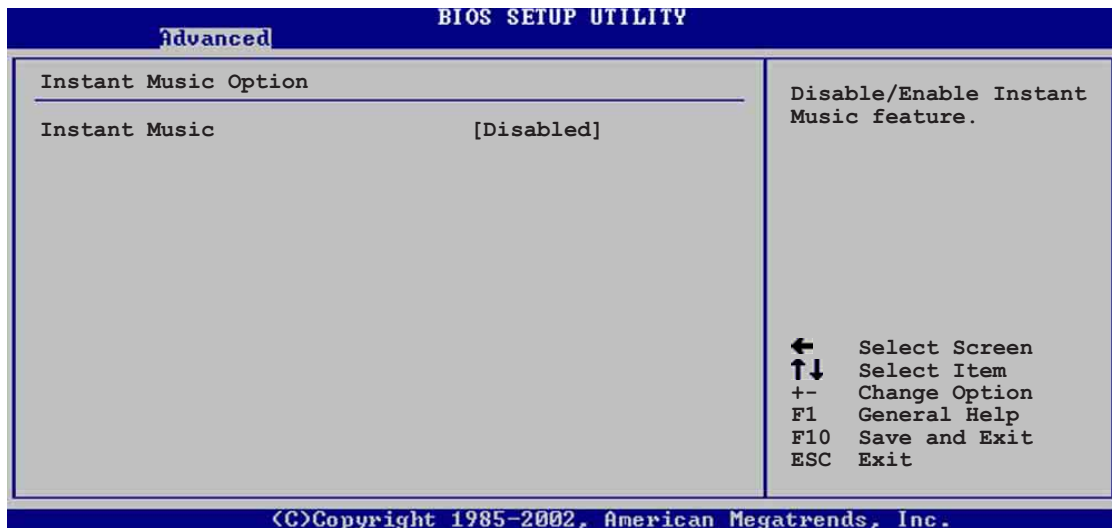

Instant Music [Disabled]

Allows you to enable or disable the Instant Music feature in BIOS.

Configuration options: [Disabled] [Enabled]



When Instant Music is enabled, the PS/2 keyboard power up feature is automatically disabled.

Instant Music CD-ROM Drive [IDE Secondary Master]

Allows you to select the CD-ROM drive that you wish to use for the Instant Music CD playback. Configuration options: [IDE Primary Master] [IDE Primary Slave] [IDE Secondary Master] [IDE Secondary Slave]



The above item appears only if you enabled the Instant Music item.

4.5 Power menu

The Power menu items allow you to change the settings for the Advanced Power Management (APM). Select an item then press Enter to display the configuration options.

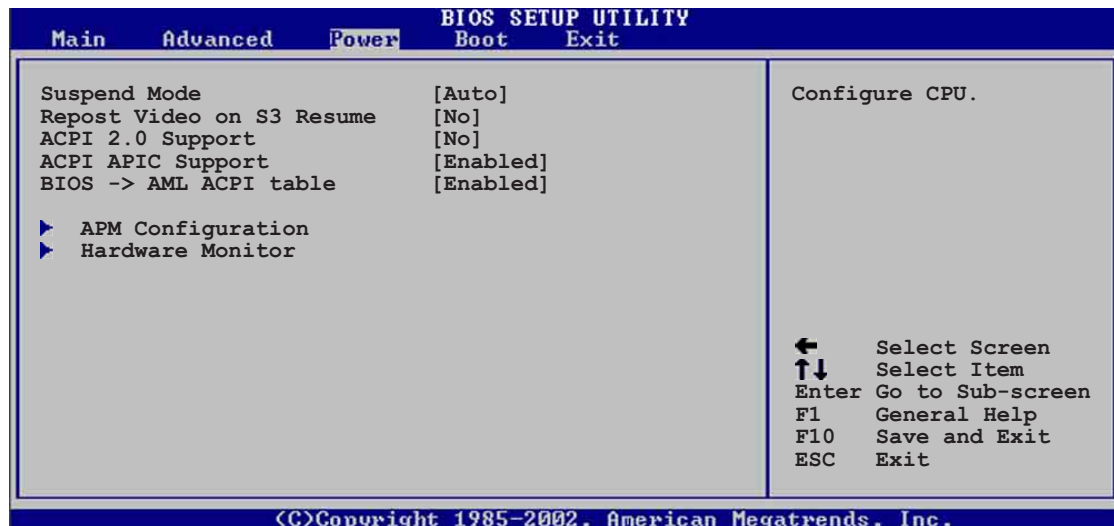

4.5.1 Suspend Mode [Auto]

Allows you to select the ACPI state to be used for system suspend.
Configuration options: [S1 (POS) Only] [S3 Only] [Auto]

4.5.2 Repost Video on S3 Resume [No]

Determines whether to invoke VGA BIOS POST on S3/STR resume.
Configuration options: [No] [Yes]

4.5.3 ACPI 2.0 Support [No]

Allows you to add more tables for ACPI 2.0 specifications. Configuration options: [No] [Yes]

4.5.4 ACPI APIC Support [Enabled]

Allows you to enable or disable the ACPI support in the ASIC. When set to Enabled, the ACPI APIC table pointer is included in the RSDT pointer list.
Configuration options: [Disabled] [Enabled]

4.5.5 BIOS -> AML ACPI Table [Enabled]

Allows you to enable or disable the inclusion of the BIOS ->AML exchange pointer to (X)RSDT pointer list. Configuration options: [Disabled] [Enabled]

4.5.6 APM Configuration

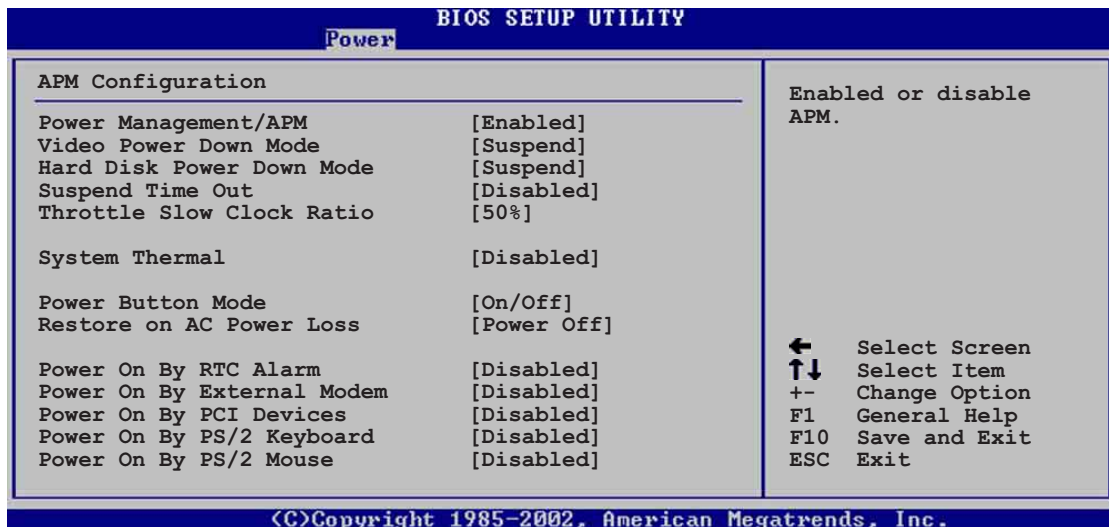

Power Management/APM [Enabled]

Allows you to enable or disable the Advanced Power Management (APM) feature. Configuration options: [Disabled] [Enabled]

Video Power Down Mode [Suspend]

Allows you to select the video power down mode. Configuration options: [Disabled] [Standby] [Suspend]

Hard Disk Power Down Mode [Suspend]

Allows you to select the hard disk power down mode. Configuration options: [Disabled] [Standby] [Suspend]

Suspend Time Out [Disabled]

Allows you to select the specified time at which the system goes on suspend. Configuration options: [Disabled] [1-2 Min] [2-3 Min] [4-5 Min] [8-9 Min] [10 Min] [20 Min] [30 Min] [40 Min] [50 Min] [60 Min]

Throttle Slow Clock Ratio [50%]

Allows you to select the duty cycle in throttle mode. Configuration options: [87.5%] [75.0%] [62.5%] [50%] [37.5%] [25%] [12.5%]

System Thermal [Disabled]

Allows you to enable or disable the system thermal feature to generate a power management event. Configuration options: [Disabled] [Enabled]

Power Button Mode [On/Off]

Allows the system to go into On/Off mode or suspend mode when the power button is pressed. Configuration options: [On/Off] [Suspend]

Restore on AC Power Loss [Power Off]

When set to Power Off, the system goes into off state after an AC power loss. When set to Power On, the system goes on after an AC power loss. When set to Last State, the system goes into either off or on state whatever was the system state before the AC power loss. Configuration options: [Power Off] [Power On] [Last State]

Power On By RTC Alarm [Disabled]

Allows you to enable or disable RTC to generate a wake event. When this item is set to Enabled, the items RTC Alarm Date, RTC Alarm Hour, RTC Alarm Minute, and RTC Alarm Second appear with set values. Configuration options: [Disabled] [Enabled]

Power On By External Modem [Disabled]

This allows either settings of [Enabled] or [Disabled] for powering up the computer when the external modem receives a call while the computer is in Soft-off mode. Configuration options: [Disabled] [Enabled]



The computer cannot receive or transmit data until the computer and applications are fully running. Thus, connection cannot be made on the first try. Turning an external modem off and then back on while the computer is off causes an initialization string that turns the system power on.

Power On By PCI Devices [Disabled]

When set to [Enabled], this parameter allows you to turn on the system through a PCI LAN or modem card. This feature requires an ATX power supply that provides at least 1A on the +5VSB lead. Configuration options: [Disabled] [Enabled]

Power On By PS/2 Keyboard [Disabled]

This parameter allows you to use specific keys on the keyboard to turn on the system. This feature requires an ATX power supply that provides at least 1A on the +5VSB lead. Configuration options: [Disabled] [Enabled]

Power On By PS/2 Mouse [Disabled]

When set to [Enabled], this parameter allows you to use the PS/2 mouse to turn on the system. This feature requires an ATX power supply that provides at least 1A on the +5VSB lead. Configuration options: [Disabled] [Enabled]

4.5.7 Hardware Monitor

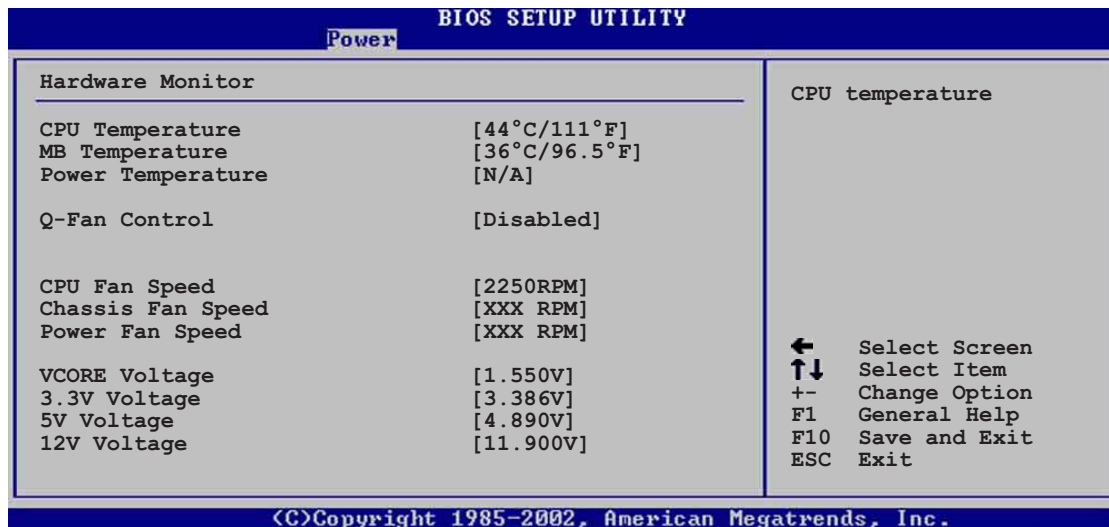

MB Temperature [xxxC/xxxF]

CPU Temperature [xxxC/xxxF]

POWER Temperature [N/A]

The onboard hardware monitor automatically detects and displays the motherboard, CPU, and power supply temperatures. Select Disabled if you do not wish to display the detected temperatures.

Q-Fan Control [Disabled]

This item allows you to enable or disable the ASUS Q-Fan feature that smartly adjusts the fan speeds for more efficient system operation. When this field is set to [Enabled], the **Fan Speed Ratio** item appears to allow selection of the appropriate fan speed ratio. Configuration options: [Disabled] [Enabled]

Fan Speed Ratio [11/16]

This item allows you to select the appropriate fan speed ratio for the system. The default [11/16] is the minimum fan speed ratio. Select a higher ratio if you installed additional devices and the system requires more ventilation. Configuration options: [11/16] [12/16] [13/16] [14/16] [15/16]



The above item appears only when the **Q-Fan Control** item is set to Enabled.

CPU Fan Speed [xxxxRPM] or [N/A] Chassis Fan Speed [xxxxRPM] or [N/A] Power Fan Speed [xxxxRPM] or [N/A]

The onboard hardware monitor automatically detects and displays the CPU, chassis, and power fan speeds in rotations per minute (RPM). If any of the fans is not connected to the motherboard, the specific field shows N/A.

VCORE Voltage, +3.3V Voltage, +5V Voltage, +12V Voltage

The onboard hardware monitor automatically detects the voltage output through the onboard voltage regulators.



If any of the monitored items is out of range, the following error message appears: "Hardware Monitor found an error. Enter Power setup menu for details". You will then be prompted to "Press F1 to continue or DEL to enter SETUP".

4.6 Boot menu

The Boot menu items allow you to change the system boot options. Select an item then press Enter to display the sub-menu.

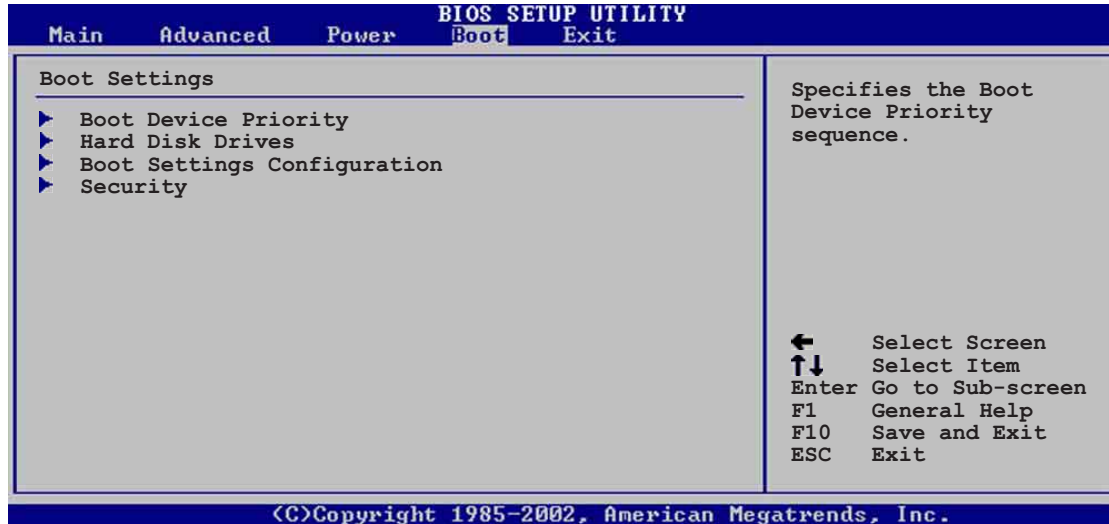

4.6.1 Boot Device Priority

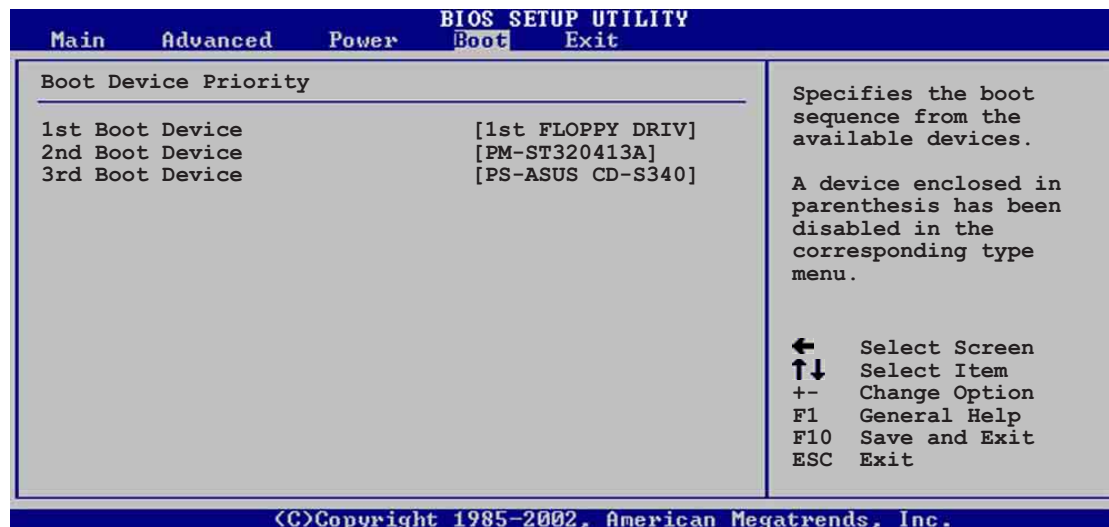

1st ~ xxth Boot Device [1st Floppy Drive]

These items specify the boot device priority sequence from the available devices. The number of device items that appear on the screen depends on the the number of devices installed in the system. Configuration options: [xxxxx Drive] [Disabled]

4.6.2 Hard disk drives

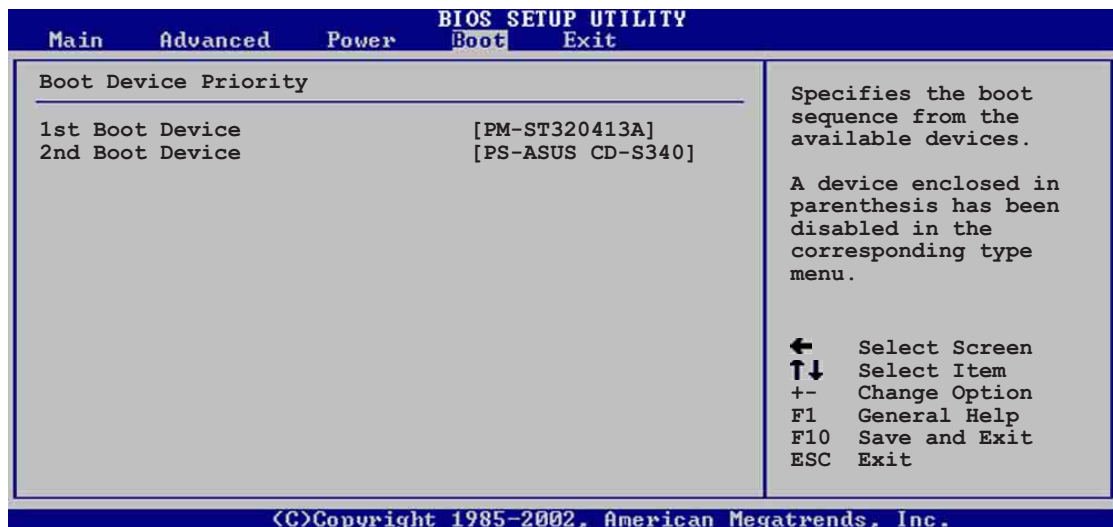

1st ~ xxth Boot Device [(Hard disk drive model name)]

These items specify the boot device priority sequence from the available hard disk drives. The number of items that appear on the screen depends on the the number of hard disk drives installed in the system.

Configuration options: [xxxxx Drive] [Disabled]

4.6.3 Boot Settings Configuration

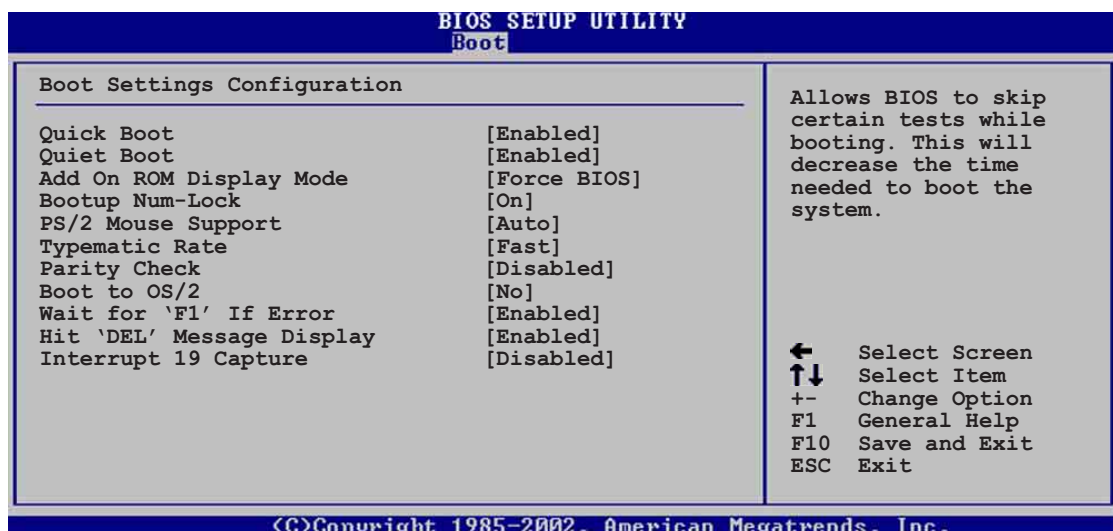

Quick Boot [Enabled]

Enabling this item allows BIOS to skip some power on self tests (POST) while booting to decrease the time needed to boot the system. When set to [Disabled], BIOS performs all the POST items. Configuration options: [Disabled] [Enabled]

Quiet Boot [Enabled]

Setting to [Disabled] displays the normal POST messages. Setting to [Enabled] displays the OEM logo instead of the POST messages.

Configuration options: [Disabled] [Enabled]

Add On ROM Display Mode [Force BIOS]

Sets the display mode for option ROM. Configuration options: [Force BIOS] [Keep Current]

Bootup Num-Lock [On]

Allows you to select the power-on state for the NumLock. Configuration options: [Off] [On]

PS/2 Mouse Support [Auto]

Allows you to enable or disable support for PS/2 mouse. Configuration options: [Disabled] [Enabled] [Auto]

Typematic Rate [Fast]

Allows you to select the keyboard typematic rate. Configuration options: [Slow] [Fast]

Parity Check [Disabled]

Allows you to enable or disable the memory parity error checking.

Configuration options: [Disabled] [Enabled]

Boot to OS/2 [No]

Allows you to specify the OS/2 compatibility mode. Configuration options: [No] [Yes]

Wait for 'F1' If Error [Enabled]

When set to Enabled, the system waits for F1 key to be pressed when error occurs. Configuration options: [Disabled] [Enabled]

Hit 'DEL' Message Display [Enabled]

When set to Enabled, the system displays the message "Press DEL to run Setup" during POST. Configuration options: [Disabled] [Enabled]

Interrupt 19 Capture [Disabled]

When set to [Enabled], this function allows the option ROMs to trap Interrupt 19. Configuration options: [Disabled] [Enabled]

4.6.4 Security

The Security menu items allow you to change the system security settings. Select an item then press Enter to display the configuration options.



Change Supervisor Password

Select this item to set or change the supervisor password. The Supervisor Password item on top of the screen shows the default **Not Installed**. After you have set a password, this item shows **Installed**.

To set a Supervisor Password:

1. Select the Change Supervisor Password item and press Enter.
2. On the password box that appears, type a password composed of letters and/or numbers, then press Enter. Your password should have at least six characters.
3. Confirm the password when prompted.
The message "Password Installed" appears after you have successfully set your password.

The Supervisor Password item now shows **Installed**.

To change the supervisor password, follow the same steps as in setting a user password.

To clear the supervisor password, select the Change Supervisor Password then press Enter. The message "Password Uninstalled" appears.



If you forget your BIOS password, you can clear it by erasing the CMOS Real Time Clock (RTC) RAM. See section "2.7 Jumpers" for information on how to erase the RTC RAM.

After you have set a supervisor password, the other items appear to allow you to change other security settings.

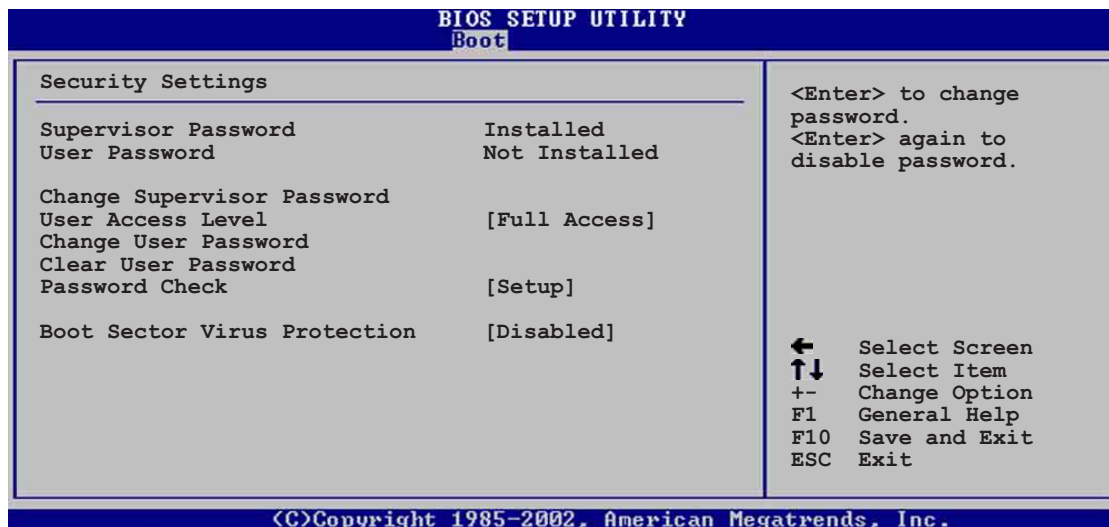

User Access Level (Full Access)

This item allows you to select the access restriction to the Setup items. Configuration options: [No Access] [View Only] [Limited] [Full Access]

No Access prevents user access to the Setup utility.

View Only allows access but does not allow change to any field.

Limited allows change to only selected fields, such as Date and Time.

Full Access allows viewing and changing all the fields in the Setup utility.

Change User Password

Select this item to set or change the user password. The User Password item on top of the screen shows the default **Not Installed**. After you have set a password, this item shows **Installed**.

To set a User Password:

1. Select the Change User Password item and press Enter.
2. On the password box that appears, type a password composed of letters and/or numbers, then press Enter. Your password should have at least six characters.
3. Confirm the password when prompted.
The message "Password Installed" appears after you have successfully set your password.

The User Password item now shows **Installed**.

To change the user password, follow the same steps as in setting a user password.

Clear User Password

Select this item if you wish to clear the user password.

Password Check [Setup]

When set to [Setup], BIOS checks for user password when accessing the Setup utility. When set to [Always], BIOS checks for user password both when accessing Setup and booting the system. Configuration options: [Setup] [Always]

Boot Sector Virus Protection [Disabled]

Allows you to enable or disable the boot sector virus protection. Configuration options: [Disabled] [Enabled]

4.7 Exit menu

The Exit menu items allow you to load the optimal or failsafe default values for the BIOS items, and save or discard your changes to the BIOS items.

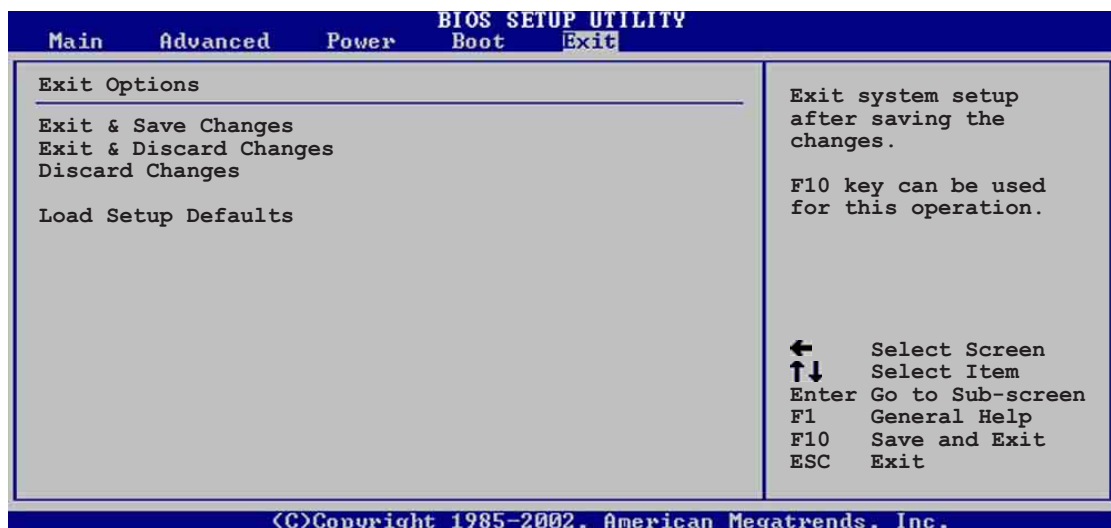

Pressing <Esc> does not immediately exit this menu. Select one of the options from this menu or <F10> from the legend bar to exit.

Exit & Save Changes

Once you are finished making your selections, choose this option from the Exit menu to ensure the values you selected are saved to the CMOS RAM. The CMOS RAM is sustained by an onboard backup battery and stays on even when the PC is turned off. When you select this option, a confirmation window appears. Select [Yes] to save changes and exit.



If you attempt to exit the Setup program without saving your changes, the program prompts you with a message asking if you want to save your changes before exiting. Pressing <Enter> saves the changes while exiting.

Exit & Discard Changes

Select this option only if you do not want to save the changes that you made to the Setup program. If you made changes to fields other than system date, system time, and password, the BIOS asks for a confirmation before exiting.

Discard Changes

This option allows you to discard the selections you made and restore the previously saved values. After selecting this option, a confirmation appears. Select [Yes] to discard any changes and load the previously saved values.

Load Setup Defaults

This option allows you to load the default values for each of the parameters on the Setup menus. When you select this option or if you press <F5>, a confirmation window appears. Select [Yes] to load default values. Select Exit Saving Changes or make other changes before saving the values to the non-volatile RAM.

Chapter 5

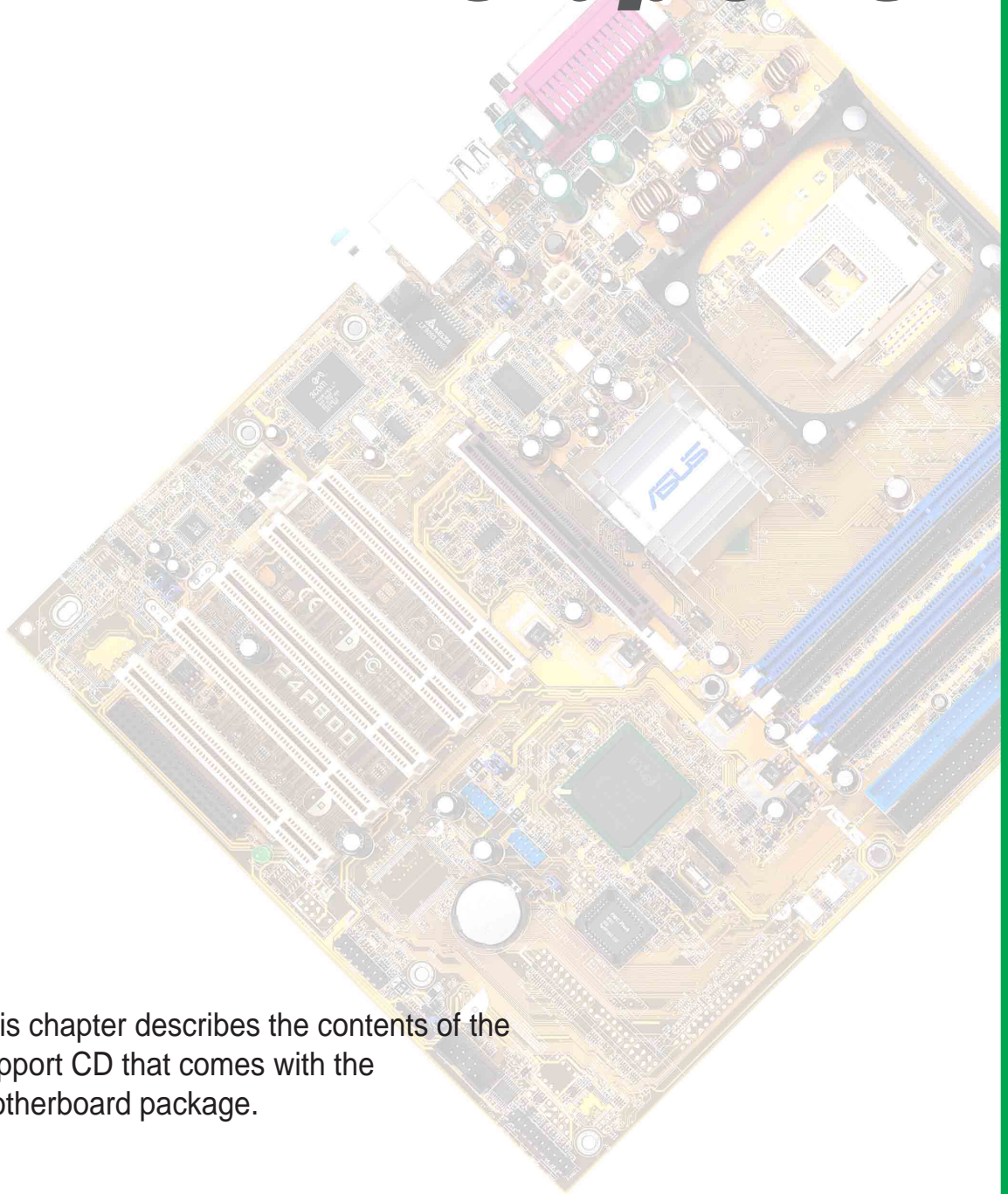

This chapter describes the contents of the support CD that comes with the motherboard package.

Software support

Chapter summary

- 5.1 Install an operating system 5-1**
- 5.2 Support CD information 5-1**
- 5.3 Software information 5-7**
- 5.4 Intel® RAID for Serial ATA configuration 5-21**
- 5.5 3COM® Virtual Cable Tester™ (VCT) 5-25**

5.1 Install an operating system

This motherboard supports Windows 98SE/ME/2000/XP operating system (OS). Always install the latest OS version and corresponding updates so you can maximize the features of your hardware.



Because motherboard settings and hardware options vary, use the setup procedures presented in this chapter for general reference only. Refer to your OS documentation for more information.

5.2 Support CD information

The support CD that came with the motherboard contains useful software and several utility drivers that enhance the motherboard features.



The contents of the support CD are subject to change at any time without notice. Visit the ASUS website for updates.

5.2.1 Running the support CD

To begin using the support CD, simply insert the CD into your CD-ROM drive. The CD automatically displays the **Drivers** menu if Autorun is enabled in your computer.

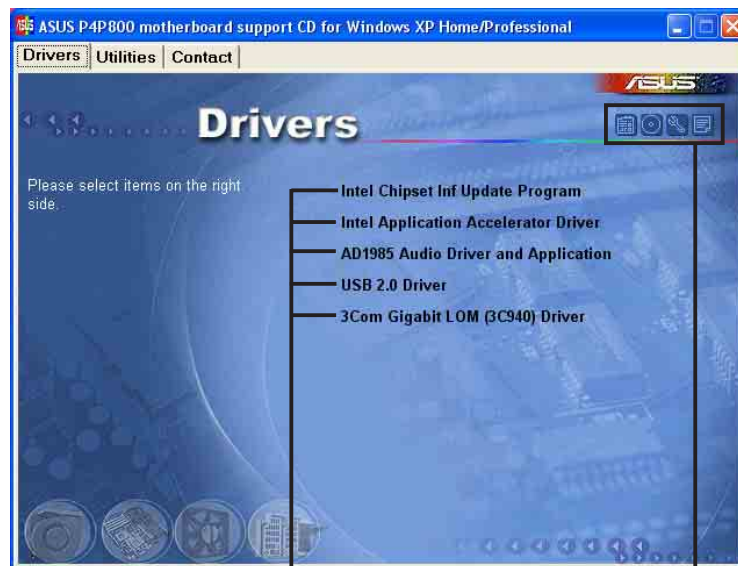

Click an item to install

Click an icon to display more information



If **Autorun** is NOT enabled in your computer, browse the contents of the support CD to locate the file **ASSETUP.EXE** from the **BIN** folder. Double-click the **ASSETUP.EXE** to run the CD.

5.2.2 Drivers menu

The drivers menu shows the available device drivers if the system detects installed devices. Install the necessary drivers to activate the devices.



Intel Chipset Inf Update Program

This item installs the Intel Chipset Inf Update Program.

Intel Application Accelerator Driver

This item installs the Intel Application Accelerator Driver.

AD1985 Audio Driver and Applications

This item executes the wizard to install the SoundMAX audio driver and applications.

USB 2.0 Driver

This item installs the Universal Serial Bus 2.0 driver.

3Com Gigabit LOM (3C940) Driver

This item executes the dialogue box interface for the 3COM NIC driver and diagnostics installation.



Screen display and driver options may not be the same for other operating system versions.

5.2.3 Utilities menu

The Utilities menu shows the applications and other software that the motherboard supports.

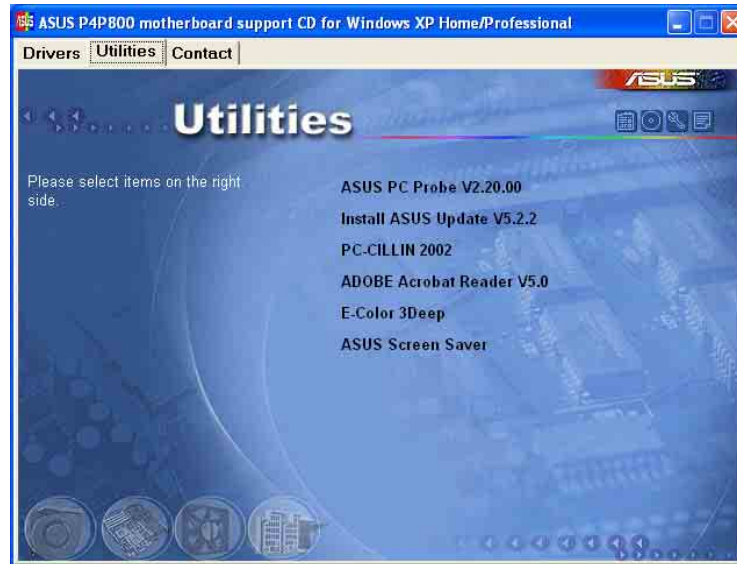

ASUS PC Probe

This smart utility monitors the fan speed, CPU temperature, and system voltages, and alerts you on any detected problems. This utility helps you keep your computer at a healthy operating condition.

Install ASUS Update

This program allows you to download the latest version of the BIOS from the ASUS website.



Before using the ASUS Update, make sure that you have an Internet connection so you can connect to the ASUS website.

Microsoft Direct X 8.1 Driver

This item installs the Microsoft V8.0a driver.

PC-CILLIN 2002

This item installs the PC-cillin 2002 anti-virus program. View the PC-cillin online help for detailed information.

Adobe Acrobat Reader V5.0

This item installs the Adobe Acrobat Reader V5.0. The Acrobat Reader software is for viewing files saved in Portable Document Format (PDF).

ASUS Screen Saver

This item installs the ASUS screen saver.

E-Color 3Deep

This item installs the 3Deep software. 3Deep is the first application that gives online gamers the competitive edge in multi-player skirmishes. This application removes dark washed-out graphics to deliver true vibrant colors.



Screen display and utilities option may not be the same for other operating system versions.

5.2.4 ASUS Contact Information

Clicking the ASUS Contact Information tab displays as stated. You may also find this information on page x of this user guide.



5.2.5 Other information

The icons on the top right corner of the screen give additional information on the motherboard and the contents of the support CD. Click an icon to display the specified information.

Motherboard Info

The window displays the general specifications of the P4P800 motherboard.

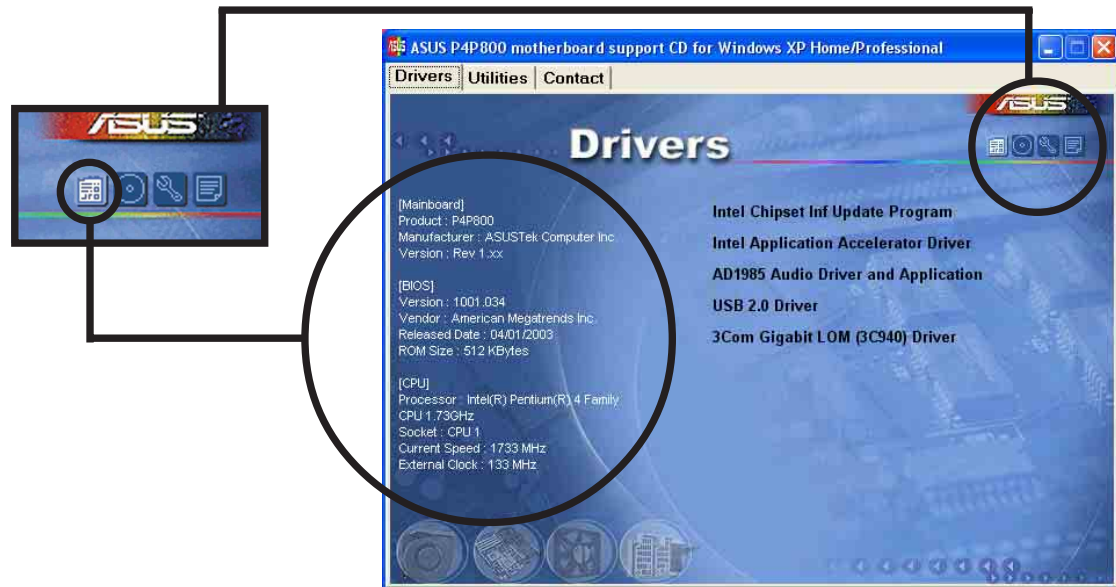

Browse this CD

The window displays the support CD contents in graphical format.

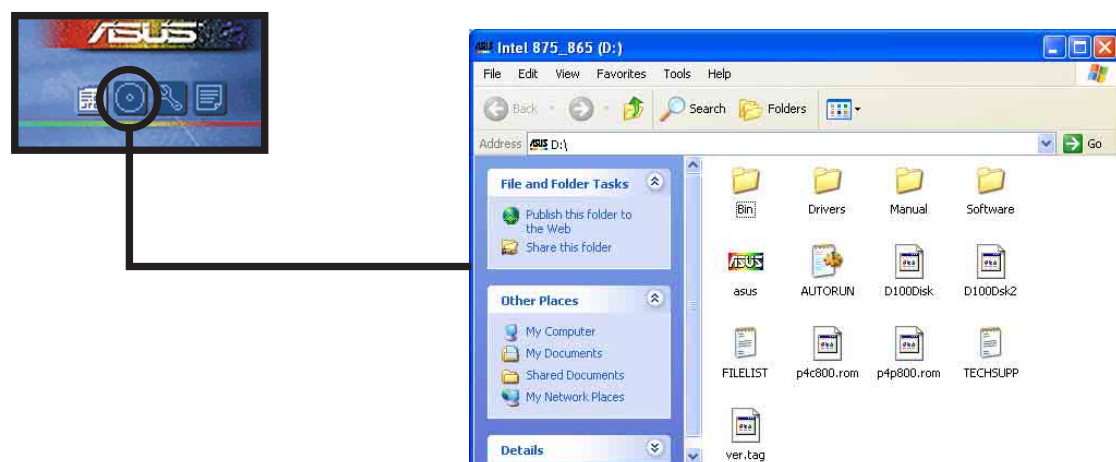

Technical Support Form

The window displays the ASUS Technical Support Request Form that you have to fill up when requesting technical support.

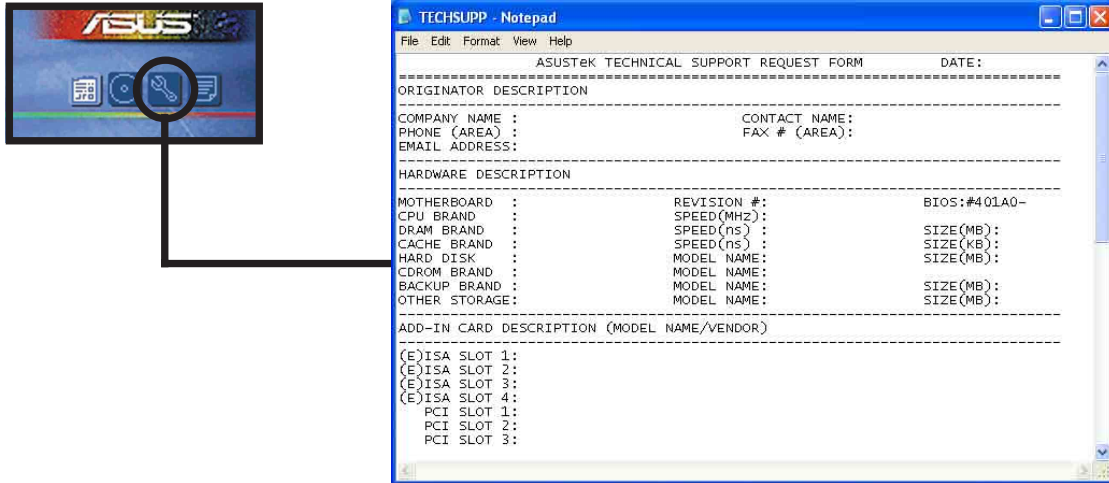

Filelist

The window displays the contents of the support CD and a brief description of each in text format.

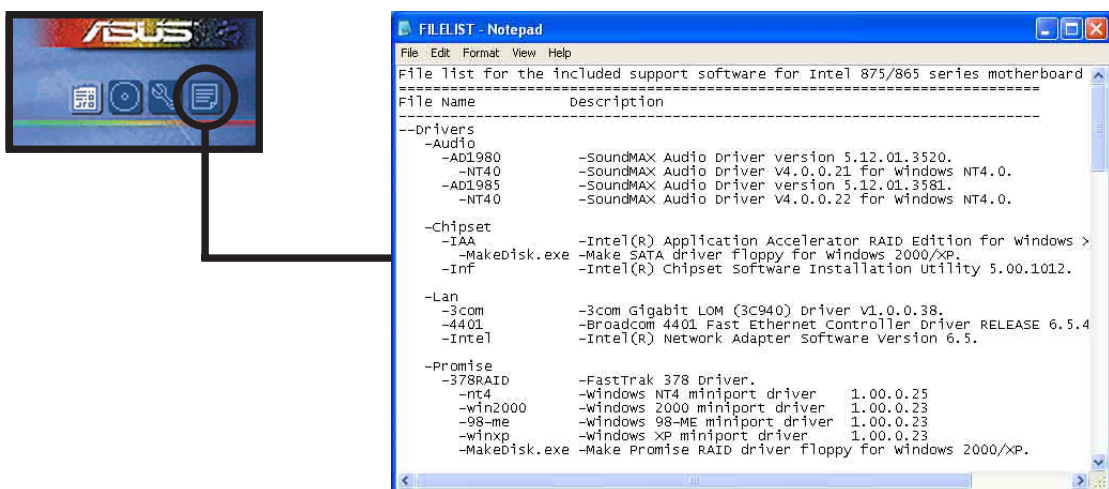

5.3 Software information

Most of the applications in the support CD have wizards that will conveniently guide you through the installation. View the online help or readme file that came with the software for more information.

This section provides details on the software applications that the motherboard supports.

5.3.1 ASUS Update

The ASUS Update is a utility that allows you to update the motherboard BIOS and drivers. This utility requires an Internet connection either through a network or an Internet Service Provider (ISP).

Follow these steps to use the ASUS Update.

1. Launch the utility from your Windows Start menu:

**Programs/AsusUpdate Vx.xx.xx/
AsusUpdate**

The ASUS Update initial screen appears.

2. Select your desired update method, then click Next.

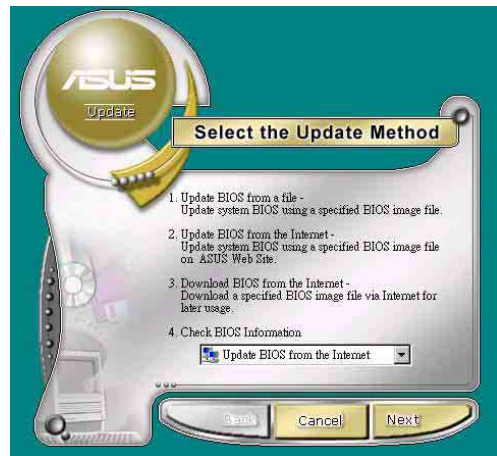

3. If you selected updating/downloading from the Internet, select the ASUS FTP site nearest you to avoid network traffic, or choose Auto Select. Click Next.

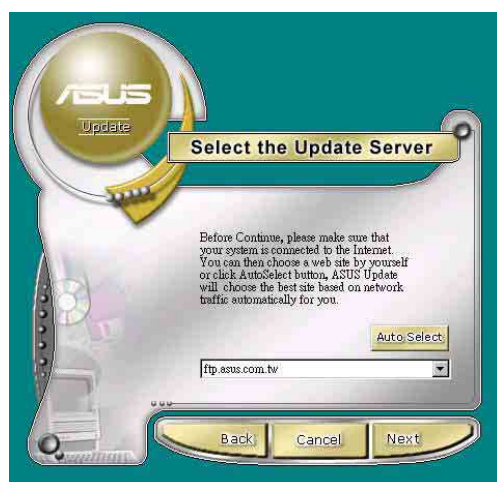

- From the FTP site, select the BIOS version that you wish to download. Click Next.
- Follow the instructions on the succeeding screens to complete the update process.

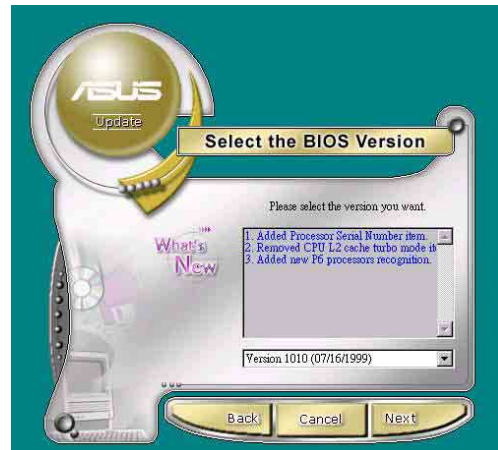

If you selected the option to update the BIOS from a file, a window pops up prompting you to locate the file. Select the file, click Save, then follow the screen instructions to complete the update process.

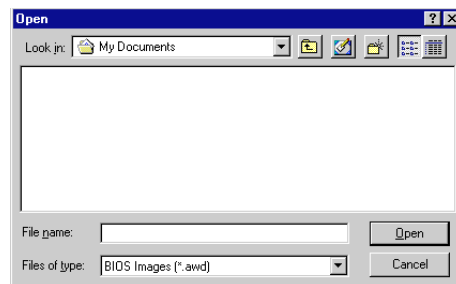

5.3.2 ASUS MyLogo2™

The ASUS MyLogo2™ is automatically installed when you install the ASUS Update utility from the software menu. See section “5.2.3 Utilities menu”.



Before using ASUS MyLogo2 feature, use the AFLASH utility to make a copy of your original BIOS file, or obtain the latest BIOS version from the ASUS website.

Follow these steps to use ASUS MyLogo2.

- Launch the ASUS Update utility. See section “5.3.1 ASUS Update.”
- When prompted for the BIOS update method, select the option “Update BIOS from a file.”
- Specify the location of the BIOS file, such as from a floppy disk. Click Next.



- From the selection that appears, choose a logo image. Click Next.



If you wish, you may create your own boot logo image in GIF, JPG, or BMP file formats.



- When you click on an image, it displays larger on the MyLogo2 screen.



If you will to make the logo image smaller, click on the arrow on the Ratio item and select your desired scale.



- The next screen prompts you to flash the original BIOS to update it with the new boot logo. Click Flash to update the BIOS.
- When finished, click Exit, then reboot your computer. Your system boots with the new boot logo.



Instead of starting from ASUS Update, you may also launch ASUS MyLogo2 directly from the Windows Start menu to change your BIOS boot logo. After you have modified the BIOS file with the new logo, use the ASUS Update utility to upload the new BIOS.

5.3.3 ASUS PC Probe

The ASUS PC Probe is a convenient utility to continuously monitor your computer system's vital components, such as fan rotations, voltages, and temperatures. It also has a utility that lets you review useful information about your computer, such as hard disk space, memory usage, and CPU type, CPU speed, and internal/external frequencies through the DMI Explorer.

Starting ASUS PC Probe

When ASUS PC Probe starts, a splash screen appears allowing you to select whether to show the screen again when you open PC Probe or not. To bypass this startup screen, clear the **Show up in next execution** check box.

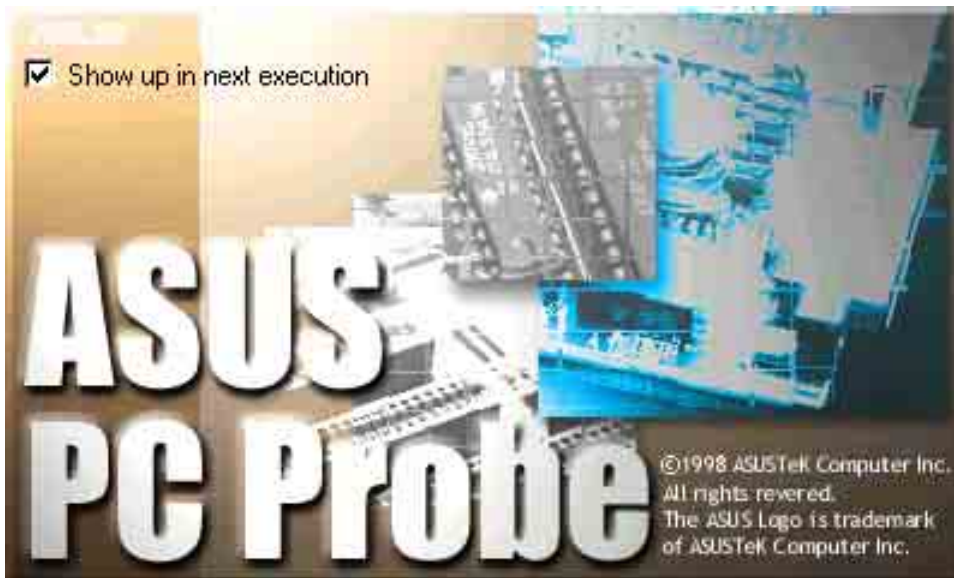

To launch **ASUS PC Probe**, click the Windows **Start** button, point to **Programs**, and then **ASUS Utility**, and then click **Probe Vx.xx**.

The PC Probe icon  appears on the taskbar system tray indicating that ASUS PC Probe is running. Clicking the icon allows you to see the status of your PC.



Using ASUS PC Probe

Monitoring

Monitor Summary

Shows a summary of the items being monitored.

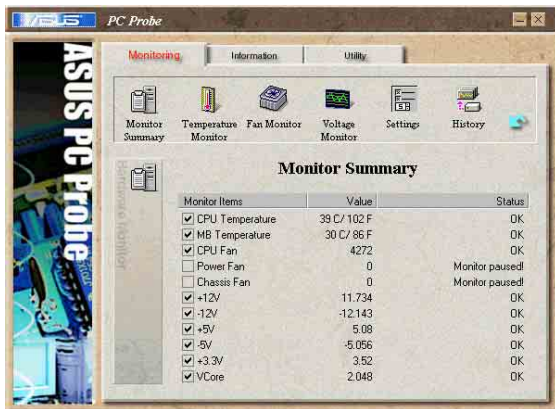

Temperature Monitor

Shows the PC temperature (for supported processors only).

Temperature Warning threshold adjustment
(Move the slider up to increase the threshold level or down to decrease the threshold level)

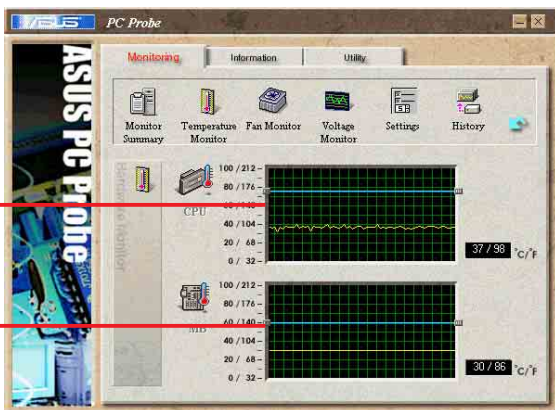

Fan Monitor

Shows the PC fan rotation.

Fan Warning threshold adjustment
(Move the slider up to increase the threshold level or down to decrease the threshold level)

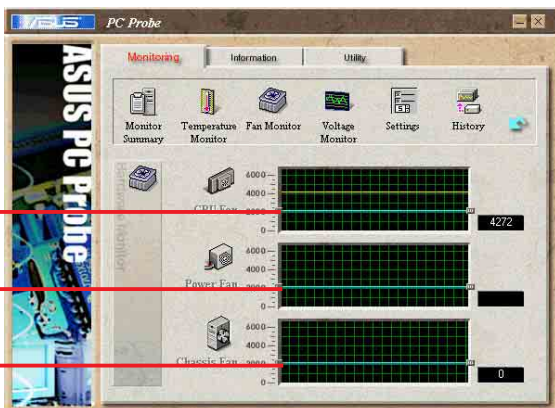

Voltage Monitor

Shows the PC voltages.

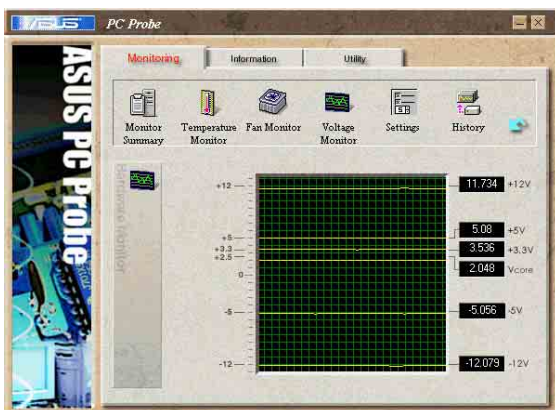

Settings

Lets you set threshold levels and polling intervals or refresh times of the PC's temperature, fan rotation, and voltages.

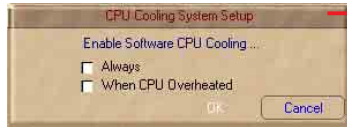

CPU Cooling System Setup

Lets you select when to enable software CPU cooling. When **When CPU Overheated** is selected, the CPU cooling system is enabled whenever the CPU temperature reaches the threshold value.



History

Lets you record the monitoring activity of a certain component of your PC for future reference.

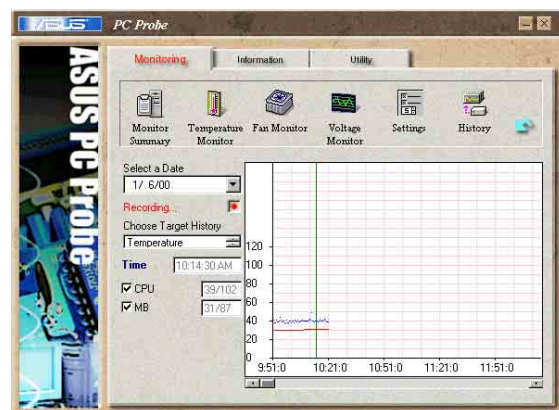

Hard Drives

Shows the used and free space of the PC's hard disk drives and the file allocation table or file system used.

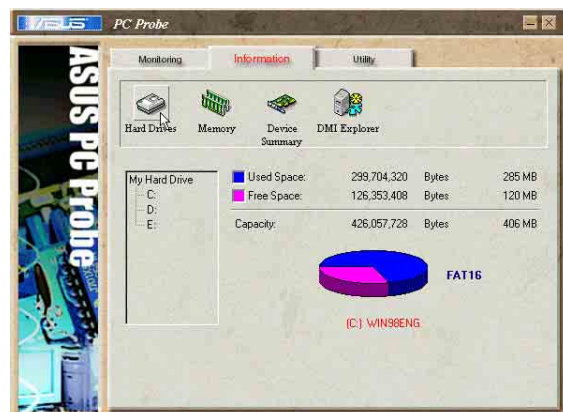

Information

Memory

Shows the PC memory load, memory usage, and paging file usage.

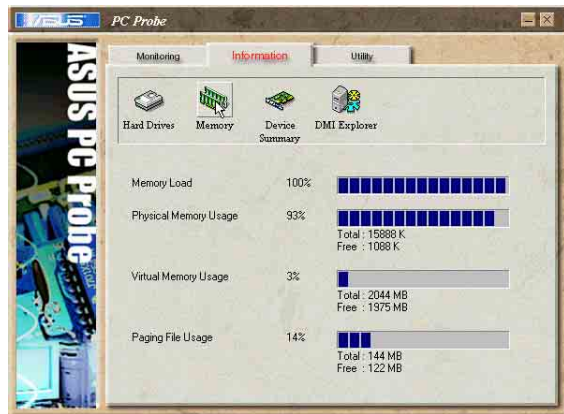

Device Summary

Shows a summary of devices present in your PC.

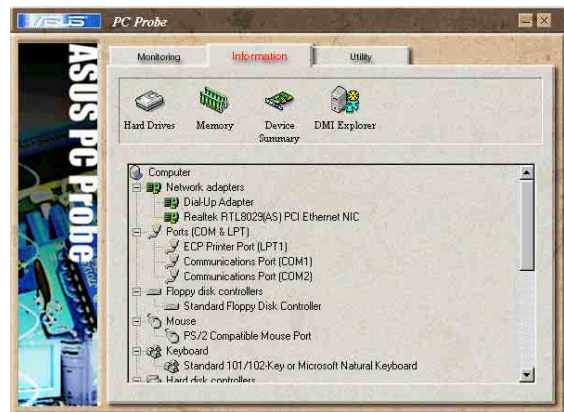

DMI Explorer

Shows information pertinent to the PC, such as CPU type, CPU speed, and internal/external frequencies, and memory size.

The screenshot shows the 'DMI Explorer' section of the ASUS PC Probe software. It displays a table of system information:

	Name	Property
BIOS	Vendor	Award Software, Inc.
System	Version	ASUS P3B-F ACPI BIOS P...
Motherboard	Starting Address	F000
Chassis	Release Date	08/07/1999
Processor	ROM Size	256K
Memory Controller	ISA	Supported
Cache	MCA	Not Supported
Port Connector	EISA	Not Supported
System Slots	PCI	Supported
OEM Information	PCMCIA	Not Supported
System Configuration	PrP	Supported
BIOS Language	APM	Supported
	BIOS is Upgradeable	Supported
	BIOS Shadowing	Supported
	VL-VESA	Not Supported

Utility

Lets you run programs outside of the ASUS Probe modules. To run a program, click **Execute Program**.

NOTE: This feature is currently unavailable.

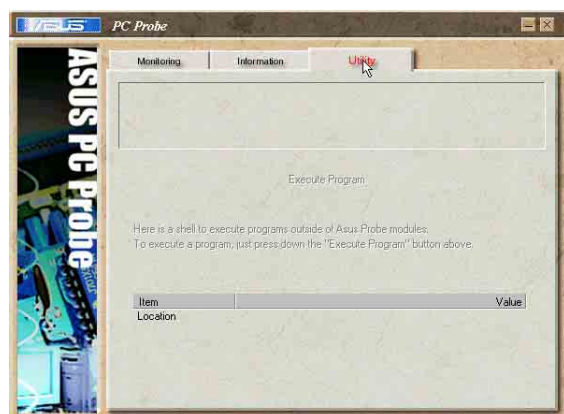

ASUS PC Probe Task Bar Icon

Right clicking the PC Probe icon brings up a menu to open or exit ASUS PC Probe and pause or resume all system monitoring.



When the ASUS PC Probe senses a problem with your PC, portions of the ASUS PC Probe icon change to red, the PC speaker beeps, and the ASUS PC Probe monitor appears.



5.3.4 ASUS Instant Music

The ASUS Instant Music is a BIOS-based audio playback feature that allows you to play audio CDs without turning on the system power. This feature is supported by the onboard audio AC'97 CODEC, and requires an optical drive (CD-ROM, DVD-ROM, or CD-RW).



1. Instant Music only supports CDs in audio format.
2. Instant Music would not work if you installed and enabled an add-on sound card.
3. Instant Music only supports PS/2 keyboard.

To enable ASUS Instant Music:

1. Connect the analog audio cable from the optical drive (CD-ROM, DVD-ROM, or CD-RW drive) to the 4-pin CD-In connector (labeled CD1) on the motherboard. See section "2.8 Connectors" for the connector location.



Make sure to connect the CD-ROM audio cable. Otherwise, you cannot control the audio volume using the Instant Music function keys.

2. Turn on the system and enter BIOS by pressing the **Delete** key during the Power On Self-Tests (POST).
3. In the **Advanced Menu** → **Instant Music Configuration** menu, select the item **Instant Music** and set it to **Enabled**.

4. Highlight the **Instant Music CDRom** item and press Enter to display the CD-ROM options. Select the CD-ROM drive that you wish to use for this feature.
5. Save your changes and exit BIOS Setup.



1. The Scroll Lock LED is fixed to ON after enabling Instant Music.
2. When set to Instant Music mode, the system wake-up features (LAN, keyboard, mouse, USB) are deactivated. In this case, power up the system using the power switch.
3. If the system lost connection or did not detect any optical drive, the Instant Music feature turns OFF (disabled) automatically. A “beep” indicates this condition.

To use ASUS Instant Music:

1. Ensure that the power cord is plugged to a grounded power source, so that the system has a standby power.
2. Place the **Instant Music keyboard label** over Esc and other function keys on your keyboard (top left corner). The keys covered by the label identify the Instant Music special function keys.

Instant Music function keys (Set 1)

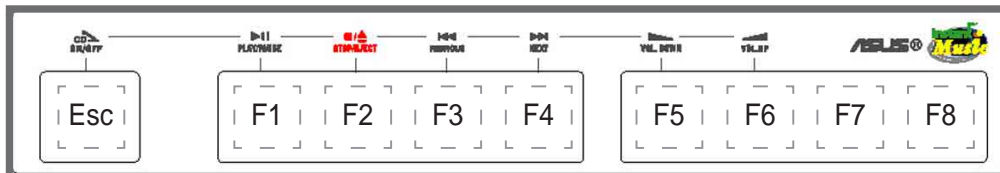

Instant Music function keys (Set 2)

As an alternative, you may also use another set of keys on the motherboard as Instant Music function keys. These keys are indicated by marked numbers in the keyboard illustration below. The functions are defined in the illustration on the right.

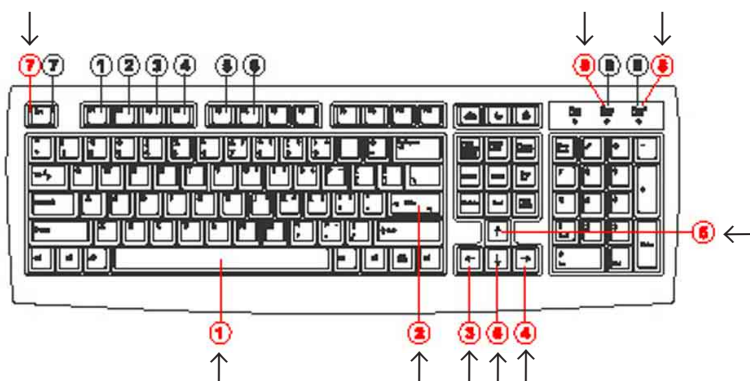

Instant Music		ASUS®	
① PLAY/PAUSE	② STOP/EJECT	③ PREVIOUS	④ NEXT
⑤ VOL. DOWN	⑥ VOL. UP	⑦ CD ON / OFF	⑧ CAPS LOCK * PAUSE
⑨ SCROLL LOCK * OFF			



These labels all come with your motherboard package.

3. Connect speakers or a headphone to the Line Out (lime colored) port on the rear panel for audio output.



You may also connect a headphone to the headphone jack on the CD-ROM drive front panel.

4. Place an audio CD on the drive.
5. Press **Esc** to turn ON Instant Music.
6. Press **F1** or the **Space Bar** to play the first track on the CD.



If there is no CD on the drive and you press F1 or Space Bar, the drive tray ejects.

7. Refer to the Instant Music function key definitions on the previous page to select other tracks or control the volume.
8. Press **F2** or **Enter** *once* to stop playing the CD.
Press **F2** or **Enter** *one more time* to eject the CD.

5.3.6 SoundMAX® 4 XL software

The ADI AD1985 AC '97 audio CODEC provides 6-channel audio capability through the SoundMAX4 XL with AudioESP™ software to deliver the ultimate audio experience on your PC. The software implements high quality audio synthesis/rendering, 3D sound positioning, and advanced voice-input technologies.

Follow the installation wizard install the **SoundMAX Audio Driver and Application** from the support CD that came with the motherboard package to activate the 6-channel audio feature.



You must use 4-channel or 6-channel speakers for this setup.

SoundMAX 4 XL requires Microsoft Windows 98SE/ME/2000/XP. Make sure that one of these operating systems is installed before installing SoundMAX.

If the SoundMAX4 XL software is correctly installed, you will find the SoundMAX4 XL icon on the taskbar.



SoundMAX4 XL icon

From the taskbar, double-click on the **SoundMAX4 XL** icon to display the **SoundMAX Control Panel**.



Setup wizards

Use the speaker and microphone setup wizards to fine tune the gain/attenuation of the inputs/outputs for optimal audio performance. You may launch the setup wizards by clicking the Configuration button when AudioESP detects and verifies a newly connected peripheral, or by clicking on the  icon from the SoundMAX control panel.

Speaker wizard

Follow the screen instructions to configure the speakers to your desired settings.

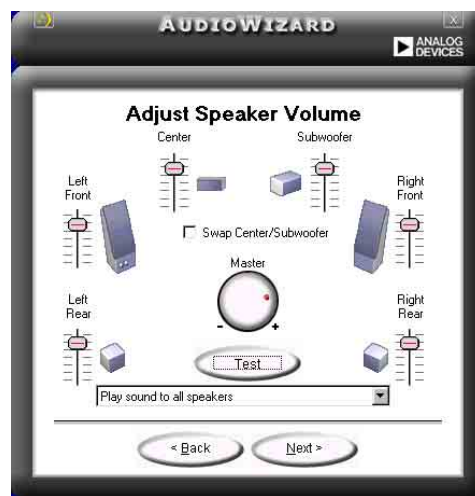

Microphone wizard

Follow the screen instructions to configure the microphone to your desired settings.



Audio preferences

The Preferences page of the SoundMAX4 XL allows you to change various audio settings.

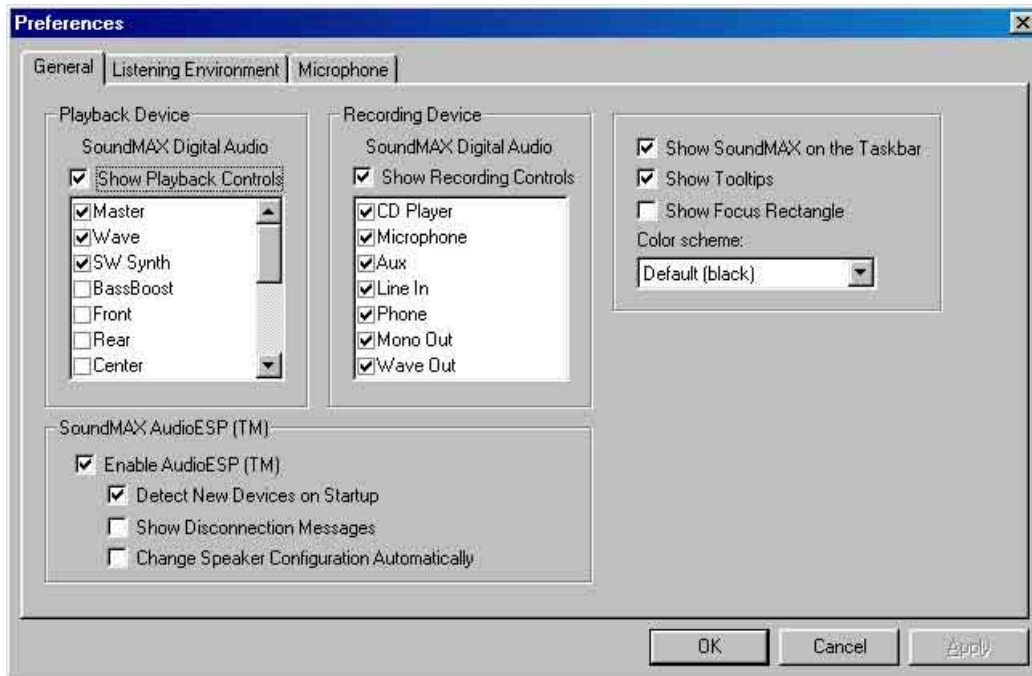

Listening environment options

The SoundMAX4 XL support several audio technologies including SoundMAX SPX™ Animated Audio, 3DPA™, MultiDrive™ 5.1, EnvironmentFC™, MacroFX/ZoomFX™, and Virtual Theater Surround.

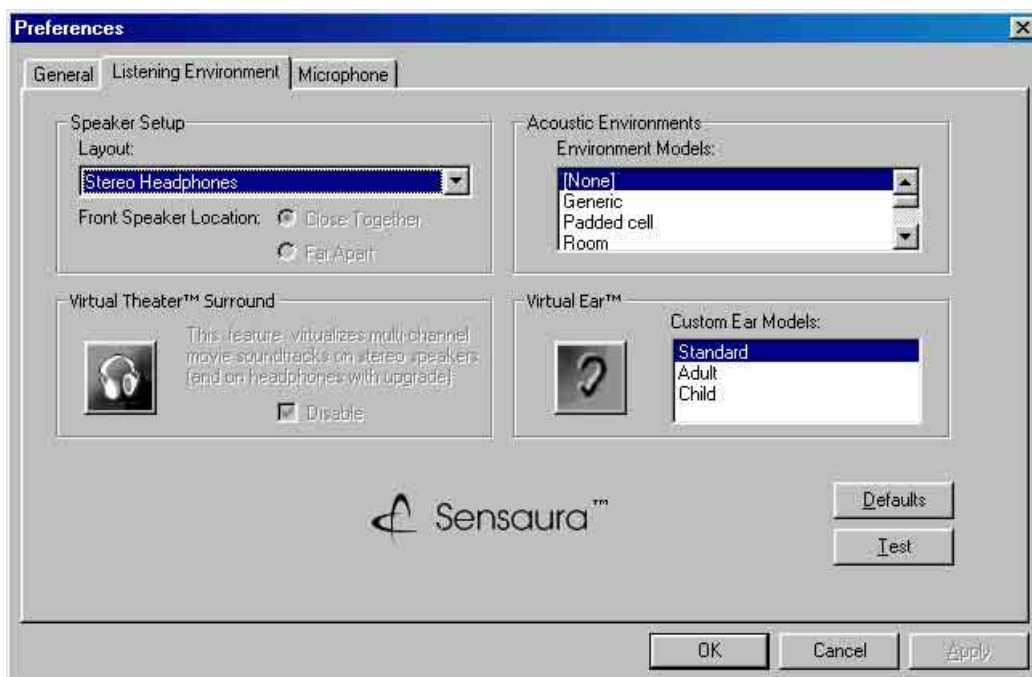

Rear panel audio ports function variation

The functions of the Line Out (lime), Line In (blue), and Mic (pink) ports on the rear panel change when you select the 4-channel or 6-channel audio configuration as shown in the following table.

	Headphone/ 2-Speaker	4-Speaker	6-Speaker
Light Blue	Line In	Rear Speaker Out	Bass/Center
Lime	Line Out	Front Speaker Out	Front Speaker Out
Pink	Mic In	Mic In	Rear Speaker Out

5.4 Intel® RAID for Serial ATA configuration

This motherboard supports Intel® RAID 0 for Serial ATA drives through the Intel® ICH5R chipset. The Serial ATA as RAID option must be enabled in the BIOS before the system can load the Intel® RAID Option ROM code for Intel® RAID. The Intel® RAID Option ROM is a standard PnP (Plug and Play) option ROM that provides a pre-operating system user interface for the Intel® RAID implementation. It also allows the boot order to be selected from within the BIOS setup utility.



For more information about the Intel® RAID for SATA configuration, refer to the Intel Application Accelerator, RAID Edition, User's manual found in "\Manual\IAA RAID Manual.doc" of the support CD.

5.4.1 BIOS Configuration

1. Enter the BIOS setup program by pressing the key after the Power-On Self Test (POST) memory test begins.
2. Select the *Main* menu, then the *IDE Configuration* menu.
3. If necessary, switch the Onboard IDE Operate Mode option from [Legacy Mode] to [Enhanced Mode].
4. Switch the Configure S-ATA as RAID option to [Yes].
5. Press <F10> to save the BIOS settings and exit the BIOS setup program.

5.4.2 Installing Serial ATA (SATA) hard disks

Installing Serial ATA (SATA) hard disks requires the use of a new SATA data cable (4-conductor) which supports the Serial ATA protocol and a SATA power cable. Either end of the SATA data cable can be connected to the SATA hard disk or the SATA connector on the motherboard.



- Both the data and power SATA cables are new cables. You cannot use older 40-pin 80-conductor IDE or regular IDE power cables with SATA hard drives.
 - Carefully follow any technical instructions that come from the hard disk manufacturer.
-

Follow the given steps for correct cable installation:

1. Attach either cable end to the SATA connector on the motherboard.
2. Attach the other cable end to the SATA hard disk.

5.4.3 Creating, Deleting, and Resetting RAID Sets

The Serial ATA RAID set must be configured in the RAID Configuration utility. This configuration can be done by the Intel® RAID Option ROM. During the Power-On Self Test (POST), the following message will appear for a few seconds: Press <Ctrl-I> to enter Raid Configuration Utility. After this message appears, press the <Ctrl> and <I> keys simultaneously, the following screen menu appears.

```
Intel(R) Integrated RAID for Serial ATA - RAID Configuration Utility
Copyright(C) 2003 Intel Corporation. All Rights Reserved. v3.x.x.xxxx

[ MAIN MENU ]

1. Create RAID Volume
2. Delete RAID Volume
3. Reset Disks to Non-RAID
4. Exit

[ DISK/VOLUME INFORMATION ]

RAID Volumes:
None defined.

Non-RAID Disks:
Port Drive Model      Serial #      Size      Status      Bootable
0 ST320413A           xxxxxxxx     18.6GB    Normal      Yes
1 ST320413A           xxxxxxxx     18.6GB    Normal      Yes

[ ↓↑ ] -Select      [ ESC ] Exit      [ Enter ] -Select Menu
```

5.4.4 Creating a RAID Volume

Follow the given steps to create a RAID 0 Volume

1. Select option **1 Create RAID Volume** and press the <Enter> key.

```
Intel(R) Integrated RAID for Serial ATA - RAID Configuration Utility
Copyright(C) 2003 Intel Corporation. All Rights Reserved. v3.x.x.xxxx

[ CREATE ARRAY MENU ]

Name: RAID Volume1
Strip Size: 64KB
RAID Level: RAID0 (Striping)
Capacity: 37.2GB

Create Volume

[ HELP ]

Enter a string between 1 and 16 characters in length taht can be used
to uniquely identify the RAID volume. This name is case sensitive and
can not contain special characters.

[ ↓↑ ] -Change      [ TAB ] -Next      [ ESC ] Previous Menu      [ Enter ] -Select
```

2. Select the stripe value for the RAID 0 array by scrolling through the available values by using the *Up* and *Down* arrow keys and pressing the <Enter> key.
3. The available values range from 8 KB to 128 KB increments. The strip value should be chosen based on the planned drive usage. Some suggested selections are listed below. The default selection is 64 KB.
 - 16 KB - low disk usage
 - 64 KB - typical disk usage
 - 128 KB - performance disk usage
4. Press the <Enter> key again to the Create Volume prompt to create the array. Confirm this selection by pressing the <Y> key after the prompt.

Are you sure you want to create this volume (Y/N)

5. Scroll to option **4 Exit** and press the <Enter> key to exit the RAID configuration utility. Confirm the exit by pressing <Y> key.

5.4.5 Deleting a RAID Volume

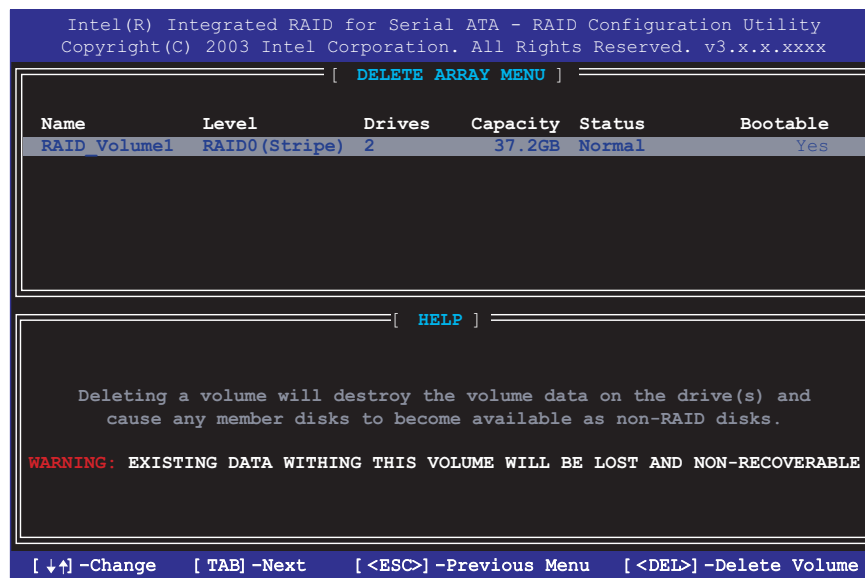

Take caution in using this option; All data on the RAID drives will be lost!

1. Select option **2 Delete RAID Volume** and press the <Enter> key to delete the RAID set.
2. Press the <Delete> key to delete the RAID volume.

```

[ VOLUME DELETE VERIFICATION ]

Are you sure you want to delete this volume?
ALL DATA IN THE VOLUME WILL BE LOST!!

Are you sure you want to delete volume "RAID_Volume1"? (Y/N)

```

3. Confirm the volume deletion by pressing the <Y> key.

5.4.6 Reset RAID Data

```

Intel(R) Integrated RAID for Serial ATA - RAID Configuration Utility
Copyright(C) 2003 Intel Corporation. All Rights Reserved. v3.x.x.xxxx

[ MAIN MENU ]

1. Create RAID Volume
2. Delete RAID Volume
3. Reset Disks to Non-RaID
4. Exit

[ DISK/VOLUME INFORMATION ]

RAID Volumes:
None defined.

Non-RAID Disks:
Port Drive Model      Serial #      Size      Status      Bootable
0 ST320413A           xxxxxxxx    18.6GB    Normal      Yes
1 ST320413A           xxxxxxxx    18.6GB    Normal      Yes

[ ↓↑ ] -Select      [ ESC ] Exit      [ Enter ] -Select Menu

```



Take caution in using this option; All data on the RAID drives and any internal RAID structures will be lost!

1. Select option **3 Reset RAID Data** and press the <Enter> key to delete the RAID set and remove any RAID structures from the drives.

```

[ RESET ALL DATA RAID DATA ]

Resetting all RAID data will remove any internal RAID structures
from all RAID disks, including disks with working volumes. These
structures are used to maintain the RAID volumes. By removing
these structures, the drive will revert back to a Non-RAID disk
that can then be used or reallocated to a new RAID volume.

WARNING: Selecting "Yes" will cause all data on any RAID disk
(RAID Volume or Other RAID Disk) to be lost.

Are you sure you want to destroy all RAID data (Y/N) :

```

2. Confirm the volume deletion by pressing the <Y> key.

5.5 3COM® Virtual Cable Tester™ (VCT) Technology

The P4P800 Deluxe motherboard supports the 3COM Virtual Cable Tester (VCT) Technology. The VCT virtually diagnose and report cable faults using the Time Domain Reflectometry (TDR). With this essential tool, installation and network diagnosis has never been easier. The VCT technology detects and reports open and shorted cables with up to 1 meter of accuracy. It also detects impedance mismatches, pair swaps, pair polarity problems and pair skew problems of up to 64ns.

VCT remarkably reduces networking and support costs, complementing a highly manageable and controlled network system. Also, this tool can be incorporated in the network systems software making it ideal for field support as well as development diagnostics.

Using the Virtual Cable Tester™

1. Right click on the My Computer icon on your desktop, on the pop-up menu, click on Properties to display the System Properties dialog box.
2. Locate *Network adapters* and select 3COM Gigabit LOM (3C940) from the list. Click on the **Properties** button.
3. From the 3Com Gigabit LOM (3C940) Properties dialogue box, select the Diagnostics tab.

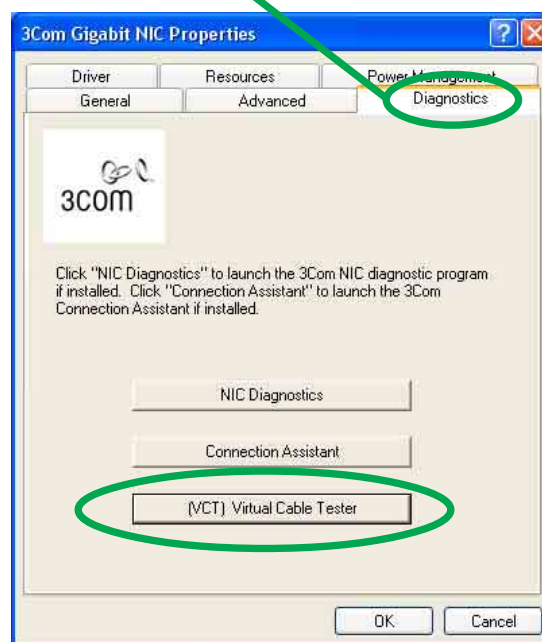

- Click on the **(VCT) Virtual Cable Tester** button. The following screen display appears.

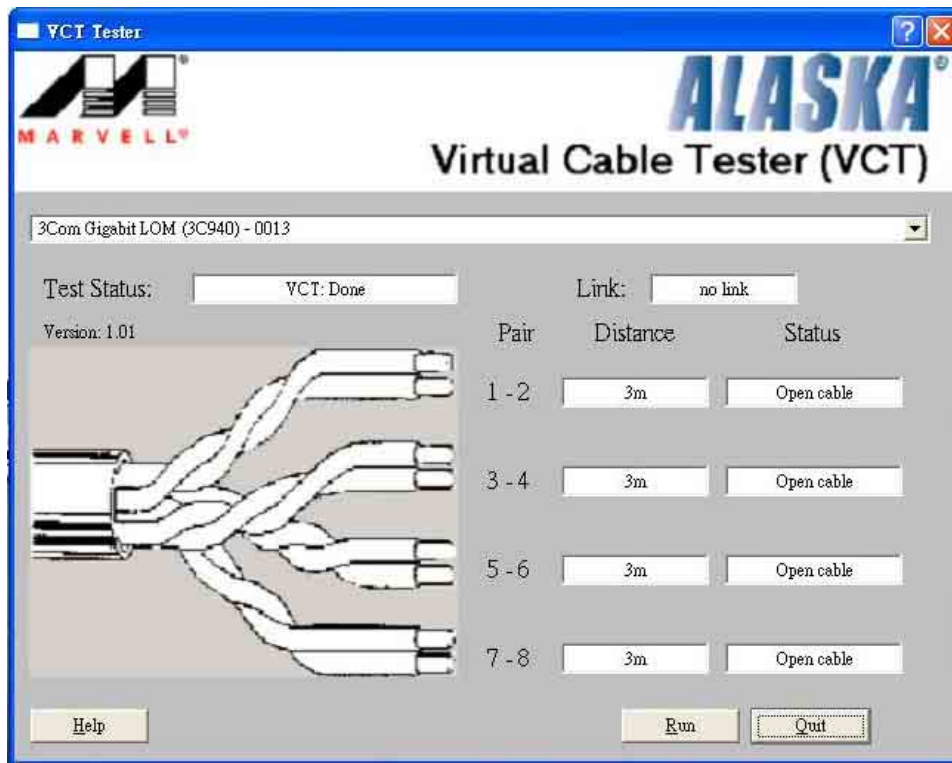

- Click on **Run** to execute test.



- The Virtual Cable Tester™ (VCT) feature is supported in Windows® XP™ and Windows® 2000™ operating systems only.
- The **Run** button on the VCT Tester dialogue box is disabled if no problem is detected on the network.