

# *P4P8X SE*

User Guide



# Motherboard

**E1479**

**First Edition**

**November 2003**

**Copyright © 2003 ASUSTeK COMPUTER INC. All Rights Reserved.**

No part of this manual, including the products and software described in it, may be reproduced, transmitted, transcribed, stored in a retrieval system, or translated into any language in any form or by any means, except documentation kept by the purchaser for backup purposes, without the express written permission of ASUSTeK COMPUTER INC. ("ASUS").

Product warranty or service will not be extended if: (1) the product is repaired, modified or altered, unless such repair, modification or alteration is authorized in writing by ASUS; or (2) the serial number of the product is defaced or missing.

ASUS PROVIDES THIS MANUAL "AS IS" WITHOUT WARRANTY OF ANY KIND, EITHER EXPRESS OR IMPLIED, INCLUDING BUT NOT LIMITED TO THE IMPLIED WARRANTIES OR CONDITIONS OF MERCHANTABILITY OR FITNESS FOR A PARTICULAR PURPOSE. IN NO EVENT SHALL ASUS, ITS DIRECTORS, OFFICERS, EMPLOYEES OR AGENTS BE LIABLE FOR ANY INDIRECT, SPECIAL, INCIDENTAL, OR CONSEQUENTIAL DAMAGES (INCLUDING DAMAGES FOR LOSS OF PROFITS, LOSS OF BUSINESS, LOSS OF USE OR DATA, INTERRUPTION OF BUSINESS AND THE LIKE), EVEN IF ASUS HAS BEEN ADVISED OF THE POSSIBILITY OF SUCH DAMAGES ARISING FROM ANY DEFECT OR ERROR IN THIS MANUAL OR PRODUCT.

SPECIFICATIONS AND INFORMATION CONTAINED IN THIS MANUAL ARE FURNISHED FOR INFORMATIONAL USE ONLY, AND ARE SUBJECT TO CHANGE AT ANY TIME WITHOUT NOTICE, AND SHOULD NOT BE CONSTRUED AS A COMMITMENT BY ASUS. ASUS ASSUMES NO RESPONSIBILITY OR LIABILITY FOR ANY ERRORS OR INACCURACIES THAT MAY APPEAR IN THIS MANUAL, INCLUDING THE PRODUCTS AND SOFTWARE DESCRIBED IN IT.

Products and corporate names appearing in this manual may or may not be registered trademarks or copyrights of their respective companies, and are used only for identification or explanation and to the owners' benefit, without intent to infringe.

# Contents

Notices .....	v
Safety information .....	vi
About this guide .....	vii
ASUS contact information .....	viii
P4P8X SE specifications summary .....	ix

## Chapter 1: Product introduction

1.1 Welcome! .....	1-2
1.2 Package contents .....	1-2
1.3 Special features .....	1-3
1.4 Motherboard components .....	1-5
1.5 Motherboard layout .....	1-9
1.6 Before you proceed .....	1-10
1.7 Motherboard installation .....	1-11
1.7.1 Placement direction .....	1-11
1.7.2 Screw holes .....	1-11
1.8 Central Processing Unit (CPU) .....	1-12
1.8.1 Overview .....	1-12
1.8.2 Installing the CPU .....	1-13
1.9 System memory .....	1-14
1.9.1 Memory configurations .....	1-14
1.9.2 Installing a DIMM .....	1-16
1.10 Expansion slots .....	1-17
1.10.1 Standard interrupt assignments .....	1-17
1.10.2 PCI slots .....	1-18
1.10.3 AGP slot .....	1-18
1.11 Jumpers .....	1-19
1.12 Connectors .....	1-21

## Chapter 2: BIOS information

2.1 Managing and updating your BIOS .....	2-2
2.1.1 Creating a bootable floppy disk .....	2-2
2.1.2 Using AFUDOS to update the BIOS .....	2-2
2.1.3 Using ASUS EZ Flash to update the BIOS .....	2-4
2.1.4 Recovering the BIOS with CrashFree BIOS 2 .....	2-5
2.2 BIOS Setup program .....	2-7
2.2.1 BIOS menu screen .....	2-8

# Contents

2.2.2	Menu bar .....	2-8
2.2.3	Navigation keys .....	2-8
2.2.4	Menu items .....	2-9
2.2.5	Sub-menu items .....	2-9
2.2.6	Configuration fields .....	2-9
2.2.7	Pop-up window .....	2-9
2.2.8	Scroll bar .....	2-9
2.2.9	General help .....	2-9
2.3	Main menu .....	2-10
2.3.1	System Time [xx:xx:xxxx] .....	2-10
2.3.2	System Date [Day xx/xx/xxxx] .....	2-10
2.3.3	Legacy Diskette A [1.44M, 3.5 in.] .....	2-10
2.3.4	Primary/Secondary/Third/ FourthIDE Master/Slave .....	2-11
2.3.5	IDE Configuration .....	2-12
2.3.6	System Information .....	2-14
2.4	Advanced menu .....	2-15
2.4.1	JumperFree Configuration .....	2-15
2.4.2	CPU Configuration .....	2-17
2.4.3	Chipset .....	2-18
2.4.4	Onboard Devices Configuration .....	2-20
2.4.5	PCI PnP .....	2-22
2.4.6	USB Configuration .....	2-23
2.5	Power menu .....	2-25
2.5.1	Suspend Mode [Auto] .....	2-25
2.5.2	Repost Video on S3 Resume [No] .....	2-25
2.5.3	ACPI 2.0 Support [No] .....	2-25
2.5.4	ACPI APIC Support [Enabled] .....	2-25
2.5.5	BIOS -> AML ACPI Table [Enabled] .....	2-25
2.5.6	APM Configuration .....	2-26
2.5.7	Hardware Monitor .....	2-28
2.6	Boot menu .....	2-29
2.6.1	Boot Device Priority .....	2-29
2.6.2	Boot Settings Configuration .....	2-30
2.6.3	Security .....	2-31
2.7	Exit menu .....	2-34

## Chapter 3: Software support

3.1	Install an operating system .....	3-2
3.2	Support CD information .....	3-2
3.3	AI Net .....	3-5

# Notices

## Federal Communications Commission Statement

This device complies with Part 15 of the FCC Rules. Operation is subject to the following two conditions:

- This device may not cause harmful interference, and
- This device must accept any interference received including interference that may cause undesired operation.

This equipment has been tested and found to comply with the limits for a Class B digital device, pursuant to Part 15 of the FCC Rules. These limits are designed to provide reasonable protection against harmful interference in a residential installation. This equipment generates, uses and can radiate radio frequency energy and, if not installed and used in accordance with manufacturer's instructions, may cause harmful interference to radio communications. However, there is no guarantee that interference will not occur in a particular installation. If this equipment does cause harmful interference to radio or television reception, which can be determined by turning the equipment off and on, the user is encouraged to try to correct the interference by one or more of the following measures:

- Reorient or relocate the receiving antenna.
- Increase the separation between the equipment and receiver.
- Connect the equipment to an outlet on a circuit different from that to which the receiver is connected.
- Consult the dealer or an experienced radio/TV technician for help.



---

The use of shielded cables for connection of the monitor to the graphics card is required to assure compliance with FCC regulations. Changes or modifications to this unit not expressly approved by the party responsible for compliance could void the user's authority to operate this equipment.

---

## Canadian Department of Communications Statement

This digital apparatus does not exceed the Class B limits for radio noise emissions from digital apparatus set out in the Radio Interference Regulations of the Canadian Department of Communications.

**This class B digital apparatus complies with Canadian ICES-003.**

# Safety information

## Electrical safety

- To prevent electrical shock hazard, disconnect the power cable from the electrical outlet before relocating the system.
- When adding or removing devices to or from the system, ensure that the power cables for the devices are unplugged before the signal cables are connected. If possible, disconnect all power cables from the existing system before you add a device.
- Before connecting or removing signal cables from the motherboard, ensure that all power cables are unplugged.
- Seek professional assistance before using an adapter or extension cord. These devices could interrupt the grounding circuit.
- Make sure that your power supply is set to the correct voltage in your area. If you are not sure about the voltage of the electrical outlet you are using, contact your local power company.
- If the power supply is broken, do not try to fix it by yourself. Contact a qualified service technician or your retailer.

## Operation safety

- Before installing the motherboard and adding devices on it, carefully read all the manuals that came with the package.
- Before using the product, make sure all cables are correctly connected and the power cables are not damaged. If you detect any damage, contact your dealer immediately.
- To avoid short circuits, keep paper clips, screws, and staples away from connectors, slots, sockets and circuitry.
- Avoid dust, humidity, and temperature extremes. Do not place the product in any area where it may become wet.
- Place the product on a stable surface.
- If you encounter technical problems with the product, contact a qualified service technician or your retailer.

# About this guide

## Conventions used in this guide

To make sure that you perform certain tasks properly, take note of the following symbols used throughout this manual.



**WARNING:** Information to prevent injury to yourself when trying to complete a task.



**CAUTION:** Information to prevent damage to the components when trying to complete a task.



**IMPORTANT:** Information that you **MUST** follow to complete a task.



**NOTE:** Tips and additional information to aid in completing a task.

## Where to find more information

Refer to the following sources for additional information and for product and software updates.

### 1. ASUS Websites

The ASUS websites worldwide provide updated information on ASUS hardware and software products. The ASUS websites are listed in the ASUS Contact Information on page viii.

### 2. Optional Documentation

Your product package may include optional documentation, such as warranty flyers, that may have been added by your dealer. These documents are not part of the standard package.

# ASUS contact information

## ASUSTeK COMPUTER INC. (Asia-Pacific)

Address 150 Li-Te Road, Peitou, Taipei, Taiwan 112  
Telephone +886-2-2894-3447  
Web site [www.asus.com.tw](http://www.asus.com.tw)

### *Technical Support*

Telephone(MB/Component) +886-2-2890-7121 (English)  
(Notebook) +886-2-2890-7122 (English)  
(Server/PC) +886-2-2890-7123 (English)  
(Networking) +886-2-2890-7902 (English)  
Support fax +886-2-2890-7698

## ASUS COMPUTER INTERNATIONAL (America)

Address 44370 Nobel Drive, Fremont, CA 94538, USA  
Fax +1-510-608-4555  
E-mail [tmd1@asus.com](mailto:tmd1@asus.com)  
Web site [usa.asus.com](http://usa.asus.com)

### *Technical Support*

Telephone (General) +1-502-995-0883  
(Notebook) +1-510-739-3777  
Support fax +1-502-933-8713  
Support e-mail [tsd@asus.com](mailto:tsd@asus.com)

## ASUS COMPUTER GmbH (Germany and Austria)

Address Harkort Str. 25, D-40880 Ratingen, Germany  
Telephone +49-2102-95990  
Fax +49-2102-959911  
Online contact [www.asuscom.de/sales](http://www.asuscom.de/sales)

### *Technical Support*

Telephone +49-2102-95990  
Fax +49-2102-959911  
Online support [www.asuscom.de/support](http://www.asuscom.de/support)  
Web site [www.asuscom.de/news](http://www.asuscom.de/news)

## ASUS COMPUTER (Middle East and North Africa)

Address P.O. Box 64133, Dubai, U.A.E.  
Telephone +9714-283-1774  
Fax +9714-283-1775  
Web site [www.ASUSarabia.com](http://www.ASUSarabia.com)



# P4P8X SE specifications summary

<b>CPU</b>	Socket 478 for Intel® Pentium® 4 / Celeron up to 3.2 GHz+ Supports Intel® Hyper-Threading Technology
<b>Chipset</b>	North Bridge: Intel 865P MCH South Bridge: Intel ICH5
<b>Front Side Bus (FSB)</b>	800*/533/400 MHz (*Overclocked)
<b>Memory</b>	Dual channel memory architecture 4 x 184-pin DDR DIMM sockets for up to 4GB memory Supports PC3200*/PC2700/PC2100 unbuffered non-ECC DDR DIMMs (*Overclocking mode)
<b>Expansion slots</b>	1 x AGP 8X 5 x PCI
<b>Storage</b>	2 x UltraDMA100 support for 4 drives 2 x Serial ATA
<b>Audio</b>	ADI AD1888 SoundMAX 6-channel audio CODEC Supports S/PDIF out interface
<b>Gigabit LAN</b>	Marvell® 88E8001 Gigabit LAN controller
<b>USB 2.0</b>	Integrated 8 USB 2.0 ports
<b>Special Features</b>	Power Loss Restart ASUS EZ Flash ASUS CrashFree BIOS 2 ASUS MyLogo2
<b>Overclocking Features</b>	ASUS JumperFree ASUS C.P.R. (CPU Parameter Recall) Adjustable CPU, memory and AGP voltages SFS (Stepless Frequency Selection) at 1MHz increments Adjustable FSB/DDR ratio, Fixed AGP/PCI frequencies
<b>Rear Panel I/O</b>	1 x Parallel port 1 x Serial port 1 x PS/2 keyboard port 1 x PS/2 mouse port 4 x USB 2.0/USB 1.1 ports 1 x RJ-45 port 1 x S/PDIF-out port Line In/Line Out/Microphone ports

*(continued on the next page)*

# P4P8X SE specifications summary

<b>Internal I/O</b>	2 x USB 2.0/1.1 connector for 4 additional USB ports 2 x Serial ATA connectors CPU/Chassis fan connectors 20-pin/4-pin ATX 12V power connectors Chassis intrusion GAME/MIDI connector CD/AUX audio connectors Front panel audio connector
<b>BIOS features</b>	4Mb Flash ROM, AMI BIOS, PnP, DMI2.0, ACPI, SM BIOS2.3, ASUS C.P.R., ASUS EZ Flash
<b>Industry standard</b>	PCI 2.2, USB 2.0
<b>Manageability</b>	WfM 2.0, DMI 2.0, WOL/WOR by PME, chassis intrusion
<b>Form Factor</b>	ATX form factor: 12 in x 9.6 in
<b>Support CD contents</b>	Device drivers ASUS PC Probe ASUS LiveUpdate Trend Micro™ PC-cillin 2002 anti-virus software

\* Specifications are subject to change without notice.

# *Chapter 1*

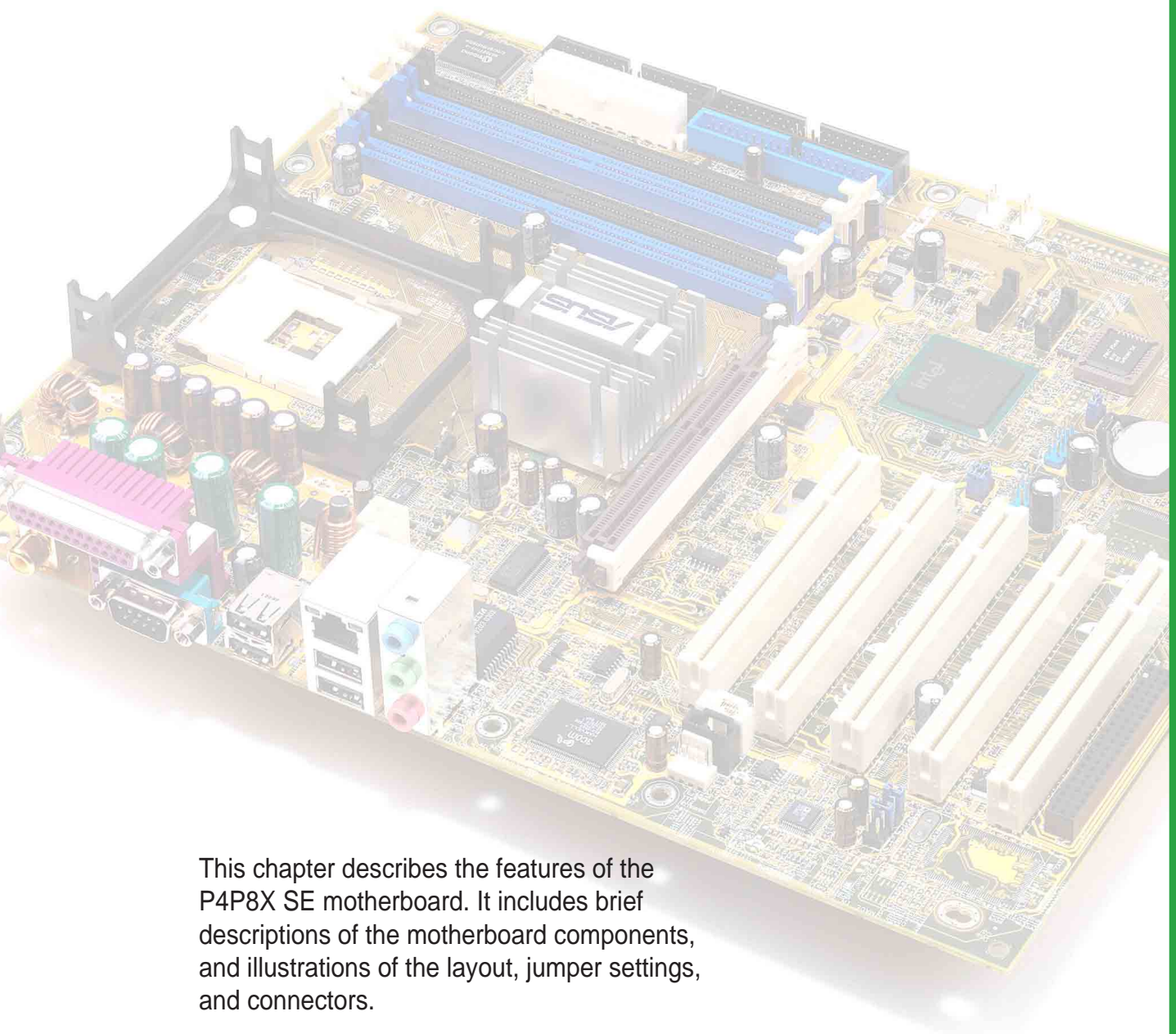

This chapter describes the features of the P4P8X SE motherboard. It includes brief descriptions of the motherboard components, and illustrations of the layout, jumper settings, and connectors.

## **Product introduction**

# 1.1 Welcome!

## Thank you for buying the ASUS® P4P8X SE motherboard!

The motherboard delivers a host of new features and latest technologies making it another standout in the long line of ASUS quality motherboards!

The motherboard incorporates the Intel® Pentium® 4 / Celeron Processor in 478-pin package coupled with the Intel® 865P chipset to set a new benchmark for an effective desktop platform solution.

Supporting up to 4GB of system memory with PC3200\*/2700/2100 DDR SDRAM, an AGP 8X slot, Serial ATA support, USB 2.0, and 6-channel audio features, the P4P8X SE is your affordable vehicle to enter the world of computing!

Before you start installing the motherboard, and hardware devices on it, check the items in your package with the list below. (\* Overclocking mode)

## 1.2 Package contents

Check your P4P8X SE package for the following items.

- ✓ ASUS P4P8X SE motherboard
- ✓ ASUS motherboard support CD
- ✓ 2 x Serial ATA cable
- ✓ UltraDMA 100/66 cable
- ✓ Floppy disk cable
- ✓ I/O shield
- ✓ Bag of extra jumper caps
- ✓ User Guide
- ✓ Jumpers and connectors sticker (Retail boxes only)



---

If any of the above items is damaged or missing, contact your retailer.

---

## 1.3 Special features

### Latest processor technology

The motherboard supports the Intel® Pentium® 4 / Celeron Processors with 512KB L2 cache and an 533/400 MHz system bus. The CPU features the Intel Hyper-Threading Technology and a new power design that allows up to 3.2GHz core frequencies. The motherboard will also support the next generation Intel Prescott CPU.

### Dual-channel DDR333 memory support

The motherboard supports up to 4GB of system memory using PC3200\*/2700/2100 non-ECC DDR DIMMs to deliver up to 3.2GB/s data transfer rate for the latest 3D graphics, multimedia, and Internet applications. (\*Overclocking mode)

### Serial ATA technology



The motherboard bundles the new Serial ATA technology through the SATA interfaces onboard. The SATA specification allows for thinner, more flexible cables with lower pin count, reduced voltage requirement, up to 150 MB/s data transfer rate, and software compatibility with the legacy Parallel ATA.

### AGP 8X support



The motherboard also mounts an AGP 8X interface (a.k.a. AGP 3.0), offering 2.1GB/s bandwidth.

### CrashFree BIOS 2



This feature allows you to restore the original BIOS data from the support CD, or from a bootable floppy disk, when the BIOS codes and data are corrupted. This protection eliminates the need to buy a replacement ROM chip.

### ASUS EZ Flash BIOS



With the ASUS EZ Flash, you can easily update the system BIOS even before loading the operating system. No need to use a DOS-based utility or boot from a floppy disk.

### Gigabit LAN solution



The motherboard supports Gigabit LAN by integrating the Marvell 88E8001 Gigabit LAN controller, equipped with a unique net-diagnosing utility - VCT (Virtual Cable Tester). VCT intelligently diagnoses and reports cable faults from a remote location up to 100 meters and helps users improve network quality.

## USB 2.0 technology

The motherboard implements the new Universal Serial Bus (USB) 2.0 specification, extending the connection speed from 12 Mbps on USB 1.1 to a fast 480 Mbps on USB 2.0.

## 6-channel digital audio

The ADI AD1888 SoundMAX AC'97 audio CODEC is onboard to provide 6-channel audio playback for 5.1 surround sound and over 90dB dynamic range.



---

Windows 98SE/ME/2000/XP support 6/4/2-channel audio modes.

---

## 1.4 Motherboard components

Before you install the motherboard, learn about its major components and available features to facilitate the installation and future upgrades. Refer to the succeeding pages for the component descriptions.

1. ATX 12V connector
2. CPU socket
3. North Bridge controller
4. DDR DIMM sockets
5. ATX power connector
6. Super I/O controller
7. Floppy disk connector
8. IDE connectors
9. AGP 8X slot
10. SATA connectors
11. Flash ROM
12. South Bridge controller
13. Standby power LED
14. PCI slots
15. Audio CODEC
16. LAN controller
17. PS/2 mouse port
18. Parallel port
19. RJ-45 port
20. Line In jack
21. Line Out jack
22. Microphone jack
23. USB 2.0 ports 3 and 4
24. USB 2.0 ports 1 and 2
25. Serial port
26. S/PDIF out port
27. Keyboard port



---

See page 1-6 for the specifications of each component.

---

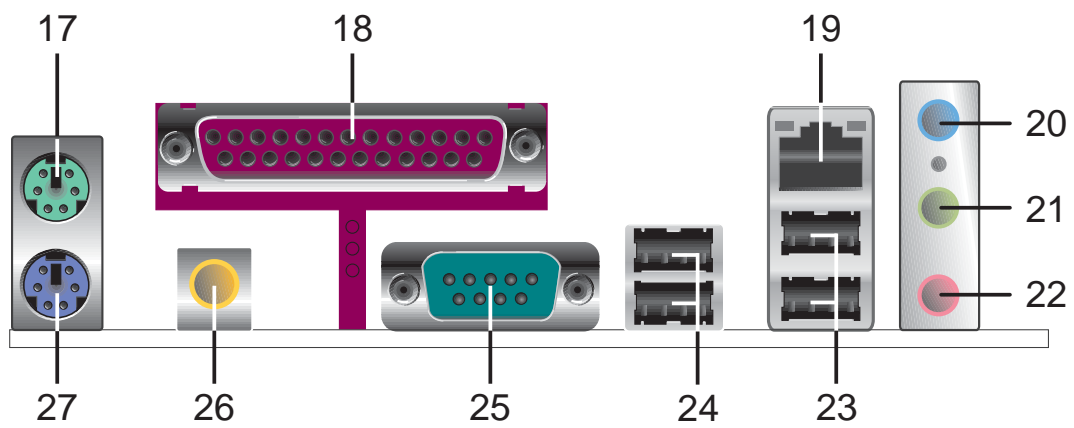
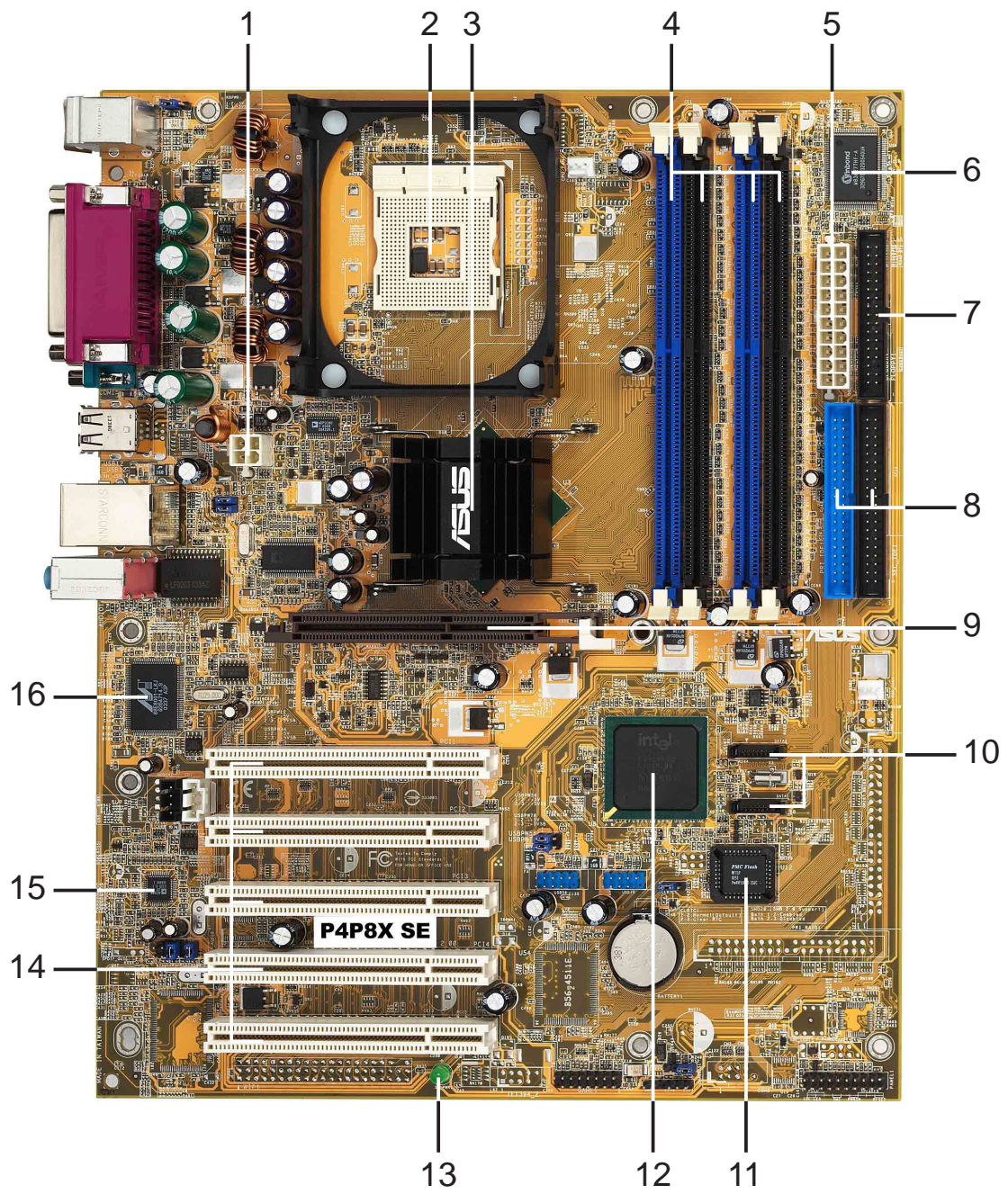



- 1 ATX 12V connector.** This power connector connects the 4-pin 12V plug from the ATX 12V power supply.
- 2 CPU socket.** A 478-pin surface mount, Zero Insertion Force (ZIF) socket for the Intel® Pentium® 4 Processor, with 800\*/533/400 MHz system bus that allows 4.3GB/s, and 3.2GB/s data transfer rates, respectively.  
(\*Overclocking mode)
- 3 North bridge controller.** The Intel® 82865P Memory Controller Hub (MCH) provides the processor interface with 533/400 MHz frequency, system memory interface at 333/266MHz operation and an AGP interface that supports AGP 3.0 specification including 8X Fast Write protocol. The MCH interconnects to the south bridge ICH5 via the Intel® proprietary Hub Interface.
- 4 DDR DIMM sockets.** These four 184-pin DIMM sockets support up to 4GB system memory using unbuffered non-ECC PC3200\*/2700/2100 DDR DIMMs. (\*Overclocking mode)
- 5 ATX power connector.** This 20-pin connector connects to an ATX power supply. The power supply must have at least 1A on the +5V standby lead (+5VSB).
- 6 Super I/O controller.** This Winbond Low Pin Count (LPC) interface provides the commonly used Super I/O functionality. The chipset supports a high-performance floppy disk controller for a 360K/720K/1.44M/2.88M floppy disk drive, a multi-mode parallel port, two standard compatible UARTs, and a Flash ROM interface. This controller also integrates the ASIC for PC health monitoring.
- 7 Floppy disk connector.** This connector accommodates the provided ribbon cable for the floppy disk drive. One side of the connector is slotted to prevent incorrect insertion of the floppy disk cable.
- 8 IDE connectors.** These dual-channel bus master IDE connectors support Ultra DMA100/66, PIO Modes 3 & 4 IDE devices. Both the primary (blue) and secondary (black) connectors are slotted to prevent incorrect insertion of the IDE ribbon cable.
- 9 AGP 8X slot.** This Accelerated Graphics Port (AGP) slot supports 0.8V/1.5V AGP 8X mode graphics cards for 3D graphical applications.
- 10 SATA connectors.** These connectors support Serial ATA HDDs and allows for up to 150MB/s data transfer rate, faster than the standard Parallel ATA with 133 MB/s.
- 11 Flash ROM.** This 4Mb firmware contains the programmable BIOS program.
- 12 South bridge controller.** The fifth-generation Intel I/O Controller Hub (ICH5) is a subsystem that integrates various I/O functions including 2-channel ATA100 bus master IDE controller, up to eight USB 2.0/1.1 ports, I/O APIC, SMBus 2.0 controller, LPC interface, AC'97 2.2 interface, and PCI 2.2 interface. The ICH5 also contains the necessary arbitration and buffering for efficient utilization of these interfaces.
- 13 Standby power LED.** This LED lights up if there is a standby power on the motherboard. This LED acts as a reminder to turn off the system power before plugging or unplugging devices.

- 14** **PCI slots.** These five 32-bit PCI 2.2 expansion slots support bus master PCI cards like SCSI or LAN cards with 133MB/s maximum throughput.
- 15** **Audio CODEC.** The ADI AD1888 SoundMAX is an AC'97 CODEC that allows 6-channel audio playback. The audio CODEC provides six DAC channels for 5.1 surround sound, S/PDIF output, AUX and Line In stereo inputs, integrated headphone amplifier, and supports greater than 90dB dynamic range.
- 16** **LAN controller.** This Marvell® 88E8001 Gbit PCI LAN controller support 10BASE/100BASE/1000BASE-TX networking.
- 17** **PS/2 mouse port.** This green 6-pin connector is for a PS/2 mouse.
- 18** **Parallel port.** This 25-pin port connects a parallel printer, a scanner, or other devices.
- 19** **RJ-45 port.** This port allows connection to a Local Area Network (LAN) through a network hub.
- 20** **Line In jack.** This Line In (light blue) jack connects a tape player or other audio sources. In 6-channel mode, the function of this jack becomes Rear Speaker out.
- 21** **Line Out jack.** This Line Out (lime) jack connects a headphone or a speaker. In 6-channel mode, the function of this jack becomes Front Speaker Out.
- 22** **Microphone jack.** This Mic (pink) jack connects a microphone. In 6-channel mode, the function of this jack becomes Bass/Center Speaker Out.



The functions of the Line Out, Line In, and Microphone jacks change when you select the 6-channel audio configuration as shown in the following table:

### Audio 2, 4 or 6-channel configuration

	Headphone/ 2-Speaker	4-Speaker	6-Speaker
Light Blue	Line In	Rear Speaker Out	Rear Speaker Out
Lime	Line Out	Front Speaker Out	Front Speaker Out
Pink	Mic In	Mic In	Bass/Center Speaker Out

- 23** **USB 2.0 ports 3 and 4.** These two 4-pin Universal Serial Bus (USB) ports are available for connecting USB 2.0 devices.
- 24** **USB 2.0 ports 1 and 2.** These two 4-pin Universal Serial Bus (USB) ports are available for connecting USB 2.0 devices.
- 25** **Serial port.** This 9-pin COM1 port is for pointing devices or other serial devices.
- 26** **S/PDIF jack.** This jack connects to external audio output devices.
- 27** **PS/2 keyboard port.** This purple connector is for a PS/2 keyboard.

# 1.5 Motherboard layout

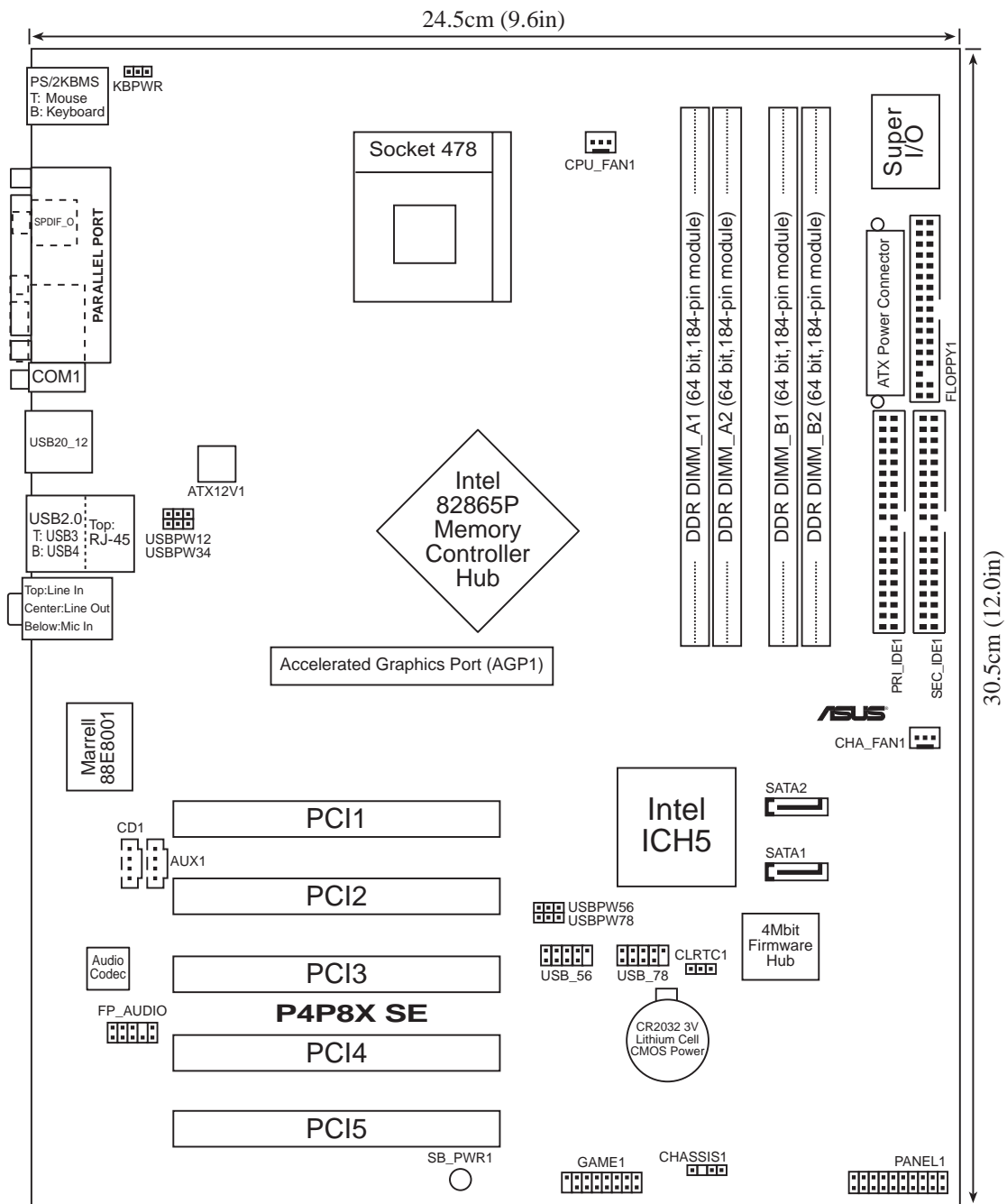

## 1.6 Before you proceed

Take note of the following precautions before you install motherboard components or change any motherboard settings.



1. Unplug the power cord from the wall socket before touching any component.
2. Use a grounded wrist strap or touch a safely grounded object or to a metal object, such as the power supply case, before handling components to avoid damaging them due to static electricity.
3. Hold components by the edges to avoid touching the ICs on them.
4. Whenever you uninstall any component, place it on a grounded antistatic pad or in the bag that came with the component.
5. **Before you install or remove any component, ensure that the ATX power supply is switched off or the power cord is detached from the power supply.** Failure to do so may cause severe damage to the motherboard, peripherals, and/or components.



When lit, the standby power LED (SB\_PWR1) indicates that the system is ON, in sleep mode, or in soft-off mode, a reminder that you should shut down the system and unplug the power cable before removing or plugging in any motherboard component.

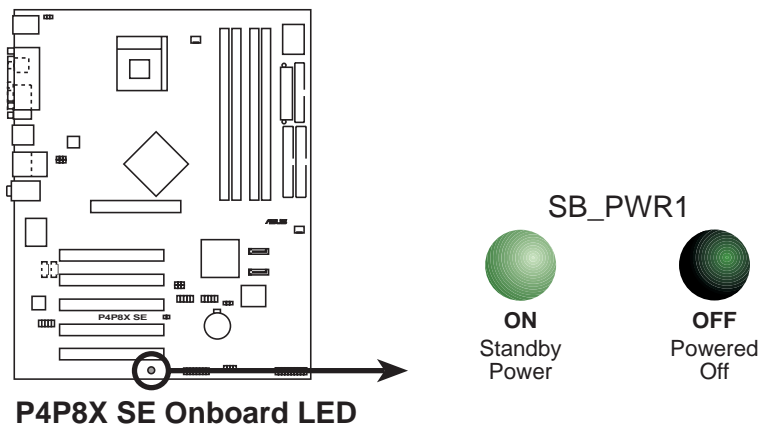

# 1.7 Motherboard installation

Before you install the motherboard, study the configuration of your chassis to ensure that the motherboard fits into it. The motherboard uses the micro-ATX form factor that measures 12 inches x 9 inches (30.5 cm x 24.5 cm).



Make sure to unplug the power cord before installing or removing the motherboard. Failure to do so may cause you physical injury and damage motherboard components.

## 1.7.1 Placement direction

When installing the motherboard, make sure that you place it into the chassis in the correct orientation. The edge with external ports goes to the rear part of the chassis as indicated in the image below.

## 1.7.2 Screw holes

Place nine (9) screws into the holes indicated by circles to secure the motherboard to the chassis.



Do not overtighten the screws! Doing so may damage the motherboard.

Place this side towards the rear of the chassis

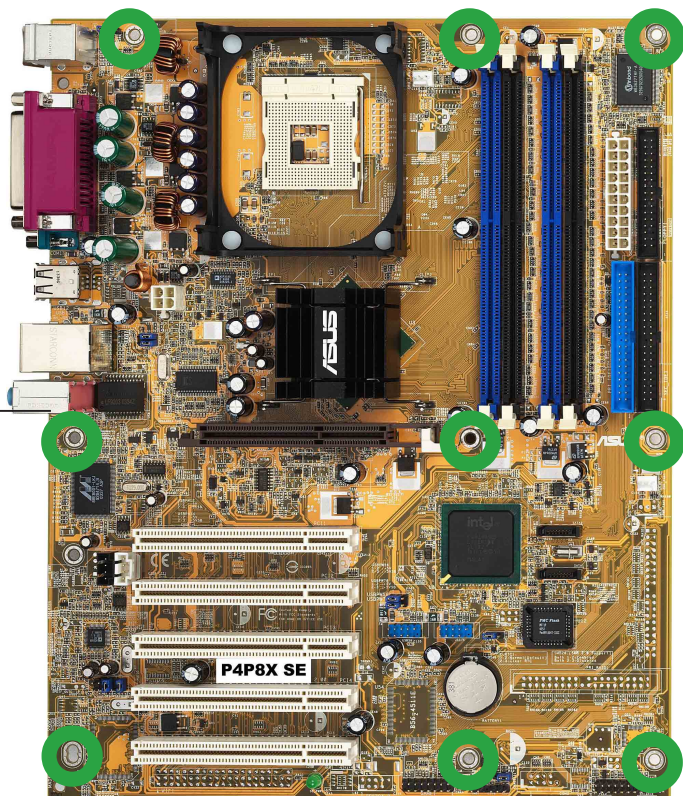

# 1.8 Central Processing Unit (CPU)

## 1.8.1 Overview

The motherboard comes with a surface mount 478-pin Zero Insertion Force (ZIF) socket. The socket is designed for the Intel® Pentium® 4 Processor in the 478-pin package with 512KB L2 cache. This processor supports 800\*/533/400MHz front side bus (FSB), and allows data transfer rates of up to 3.2GB/s. The socket will also support the Intel Prescott CPU when available. (\*Overclocking mode)

Note in the illustration that the CPU has a gold triangular mark on one corner. This mark indicates the processor Pin 1 that should match a specific corner of the CPU socket.

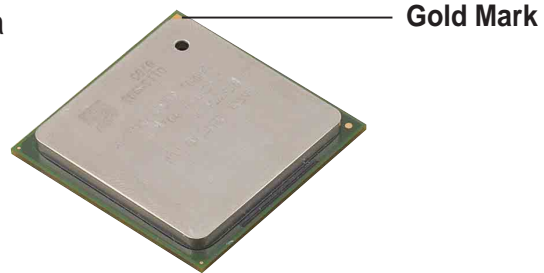

---

Incorrect installation of the CPU into the socket may bend the pins and severely damage the CPU!

---

## Notes on Intel® Hyper-Threading Technology



1. This motherboard supports Intel Pentium 4 CPUs with Hyper-Threading Technology.
  2. Hyper-Threading Technology is supported under **Windows XP** and later versions only. If you are using any other operating systems, disable the Hyper-Threading Technology item in BIOS to ensure system stability and performance.
  3. It is recommended that you install WinXP Service Pack 1.
  4. Make sure to enable the Hyper-Threading Technology item in BIOS before installing a supported operating system.
  5. For more information on Hyper-Threading Technology, visit [www.intel.com/info/hyperthreading](http://www.intel.com/info/hyperthreading).
- 

To use the Hyper-Threading Technology on this motherboard:

1. Buy an Intel Pentium 4 CPU that supports Hyper-Threading Technology. Install the CPU.
2. Power up the system and enter BIOS Setup (see Chapter 2). Under the Advanced Menu, make sure that the item **Hyper-Threading Technology** is set to Enabled. The item appears only if you installed a CPU that supports Hyper-Threading Technology.
3. Reboot the computer.

## 1.8.2 Installing the CPU

Follow these steps to install a CPU.

1. Locate the 478-pin ZIF socket on the motherboard.
2. Unlock the socket by pressing the lever sideways, then lift it up to a 90°-100° angle.



Make sure that the socket lever is lifted up to 90°-100° angle, otherwise the CPU does not fit in completely.

Socket Lever

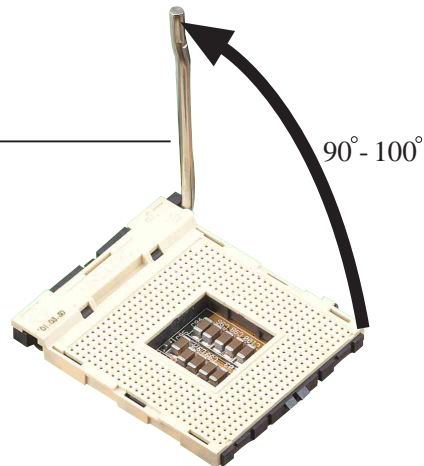

3. Position the CPU above the socket such that its marked corner matches the base of the socket lever.
4. Carefully insert the CPU into the socket until it fits in place.

Gold Mark

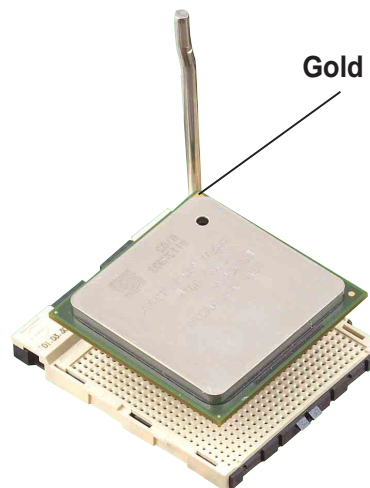

The CPU fits only in one correct orientation. **DO NOT** force the CPU into the socket to prevent bending the pins and damaging the CPU!

5. When the CPU is in place, push down the socket lever to secure the CPU. The lever clicks on the side tab to indicate that it is locked.
6. Install a CPU heatsink and fan following the instructions that came with the heatsink package.
7. Connect the CPU fan cable to the CPU\_FAN1 connector on the motherboard.



## 1.9 System memory

The motherboard comes with four Double Data Rate (DDR) Dual Inline Memory Module (DIMM) sockets. These sockets support up to 4GB system memory using 184-pin unbuffered non-ECC PC3200\*/2700/PC2100 DDR DIMMs. The following figure shows the location of the DDR DIMM sockets. (\*Overclocking mode)

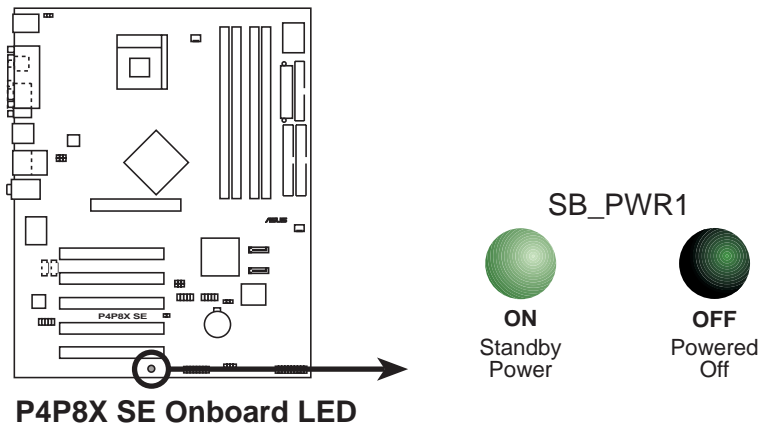

### 1.9.1 Memory configurations

You may install 64MB, 128MB, 256MB, 512MB, and 1GB DDR DIMMs into the DIMM sockets using the memory configurations in this section.

#### Important notes



1. Installing DDR DIMMs other than the recommended configurations may cause memory sizing error or system boot failure. Use any of the recommended configurations in Table 1.
2. In dual-channel configurations, install only **identical** (the same type and size) DDR DIMM pairs for each channel.
3. Always install DIMMs with the same CAS latency. For optimum compatibility, it is recommended that you obtain memory modules from the same vendor.
4. Make sure that the memory frequency matches the CPU FSB (Front Side Bus). Refer to Table 2.
5. DIMMs installed into **any three** sockets will function in single-channel mode.
6. When all four sockets are populated with 1GB DIMMs (total 4GB), the system may detect only 3+GB (a little less than 4GB) due to ICH5 resource allocation.
7. Double-sided DDR DIMMs with **x16** (databus width = 16-bit) memory chips are not supported due to chipset limitation.
8. It is recommended to use the blue DIMM slots first.



**Table 1 Recommended memory configurations**

Mode		Sockets			
		DIMM_A1 (blue)	DIMM_A2 (black)	DIMM_B1 (blue)	DIMM_B2 (black)
Single-channel	(1)	Populated	—	—	—
	(2)	—	Populated	—	—
	(3)	—	—	Populated	—
	(4)	—	—	—	Populated
Dual-channel	(1)	Populated	—	Populated	—
	(2)	—	Populated	—	Populated
	(3)*	Populated	Populated	Populated	Populated

\* For dual-channel configuration (3), you may:

- install identical DIMMs in all four sockets, or
- install identical DIMMs in DIMM\_A1 and DIMM\_B1 (blue sockets) and identical DIMMs in DIMM\_A2 and DIMM\_B2 (black sockets)

**Table 2 Memory frequency/CPU FSB synchronization**

This motherboard supports different memory frequencies depending on the CPU FSB (Front Side Bus) and the type of DDR DIMM.

CPU FSB	DDR DIMM Type	Memory Frequency
*800 MHz	*PC3200	400 MHz
533 MHz	PC2700/PC2100	333/266 MHz
400 MHz	PC2100	266 MHz

\* Overclocked mode



- When overclocking to 800MHz CPU FSB, the system supports only DDR400 (PC3200) DIMMs due to chipset limitation.
- The following FSB/DDR ratios are not supported: 400/333, 400/400, 533/400.

**Table 3 DDR400 Qualified Vendor List (QVL) (Overclocked Mode)**

Size	Vendor	P/N Number	DS/SS	Component	Max. DIMMs
512MB	TwinMOS	M2G9J16AGATT9F081AA4T	DS	TMD7608F8E50D	2
256MB	TwinMOS	M2S9I08AFAPS9F0811A-T	SS	A2S56D30ATP	2
256MB	Apacer	77.10636.465	SS	K4H560838D-TCC4	1
512MB	Apacer	77.10736.464	DS	K4H560838D-TCC4	2
256MB	Transcend	TS32MLD64V4F3	SS	K4H560838D-TCC4	2
512MB	Transcend	TS64MLD64V4F3	DS	K4H560838D-TCC4	2
256MB	Transcend	TS32MLD64V4F3	SS	V58C2256804SAT5	2
512MB	Transcend	TS64MLD64V4F3	DS	V58C2256804SAT5	2
256MB	A DATA	MDOAD5F3G315B1ECZ	SS	ADD8608A8A-5B	2
256MB	A DATA	MDOSS6F3G31JB1EAE	SS	K4H560838D-TCC4	2
256MB	A DATA	MDOWB5F3G316B1EAE	SS	W942508BH-5	2
256MB	KINGSTON	KVR400X64C25/256	SS	W942508BH-5	2
256MB	Winbond	W9425GCDB-5	SS	W942508BH-5	2
512MB	Winbond	W9451GCDB-5	DS	W942508BH-5	2
256MB	Infineon	HYS64D16301GU-5-B	SS	HYB25D256160BT-5B	2
256MB	Infineon	HYS64D32300GU-5-B	SS	HYB25D256800BT-5B	2
512MB	Infineon	HYS64D64320GU-5-B	DS	HYB25D256800BT-5B	2
256MB	SAMSUNG	M368L3223ETM-CCC	SS	K4H560838E-TCCC	2
512MB	SAMSUNG	M368L6432ETM-CCC	DS	K4H560838E-TCCC	2
256MB	Hynix	HYMD232646B8J-D43 AA	SS	HY5DU56822BT-D43	2
512MB	Hynix	HYMD264646B8J-D43 AA	DS	HY5DU56822BT-D43	2
512MB	MICRON	MT16VDDT6464AG-40BC4	DS	MT46V32M8TG-5BC	2
256MB	MICRON	MT8VDDT3264AG-40BC4	SS	MT46V32M8TG-5BC	2



- Obtain DDR DIMMs only from ASUS qualified vendors for better system performance. Visit the ASUS website ([www.asus.com](http://www.asus.com)) for the latest QVL.
- FSB800 and DDR400 is not a default specification, take caution when overclocking your system.

## 1.9.2 Installing a DIMM



Make sure to unplug the power supply before adding or removing DIMMs or other system components. Failure to do so may cause severe damage to both the motherboard and the components.

Follow these steps to install a DIMM.

1. Unlock a DIMM socket by pressing the retaining clips outward.
2. Align a DIMM on the socket such that the notch on the DIMM matches the break on the socket.
3. Firmly insert the DIMM into the socket until the retaining clips snap back in place and the DIMM is properly seated.

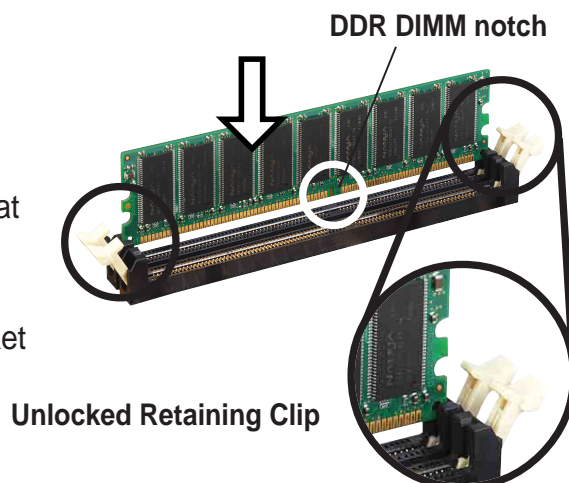

## 1.10 Expansion slots

The motherboard has five PCI slots and one Accelerated Graphics Port (AGP) slot.

To install and configure an expansion card:

1. Install an expansion card following the instructions that came with the chassis.  
NOTE: The AGP slot supports only +0.8V or 1.5V AGP cards.
2. Turn on the system and change the necessary BIOS settings, if any. See Chapter 2 for BIOS information.
3. Assign an IRQ to the card. Refer to the tables on the next page.
4. Install the drivers and/or software applications for the expansion card according to the card documentation.

### 1.10.1 Standard interrupt assignments

IRQ	Priority	Standard Function
0	1	System Timer
1	2	Keyboard Controller
2	N/A	Programmable Interrupt
3*	11	Communications Port (COM2)
4*	12	Communications Port (COM1)
5*	13	IRQ holder for PCI steering
6	14	Floppy Disk Controller
7*	15	Printer Port (LPT1)
8	3	System CMOS/Real Time Clock
9*	4	IRQ holder for PCI steering
10*	5	Advance AC'97 CODEC
11*	6	Standard PCI Graphics Adapter (VGA)
12*	7	PS/2 Compatible Mouse Port
13	8	Numeric Data Processor
14*	9	Primary IDE Channel
15*	10	Secondary IDE Channel

\* These IRQs are usually available for ISA or PCI devices.

### IRQ assignments for this motherboard

	A	B	C	D	E	F	G	H
PCI slot 1	—	—	—	—	—	shared	—	—
PCI slot 2	—	—	—	—	—	—	shared	—
PCI slot 3	—	—	—	—	—	—	—	shared
PCI slot 4	—	—	—	—	shared	—	—	—
PCI slot 5	—	—	—	—	—	shared	—	—
AGP slot	used	—	—	—	—	—	—	—
Onboard USB 1.1/2.0 controller	—	—	—	—	shared	shared	shared	shared
Onboard LAN	—	—	—	—	—	—	shared	—
Onboard Audio	—	—	used	—	—	—	—	—



When using PCI cards on shared slots, ensure that the drivers support “Share IRQ” or that the cards do not need IRQ assignments. Otherwise, conflicts will arise between the two PCI groups, making the system unstable and the card inoperable.

## 1.10.2 PCI slots

There are five 32-bit PCI slots on this motherboard. The slots support PCI cards such as a LAN card, SCSI card, USB card, and other cards that comply with PCI specifications.

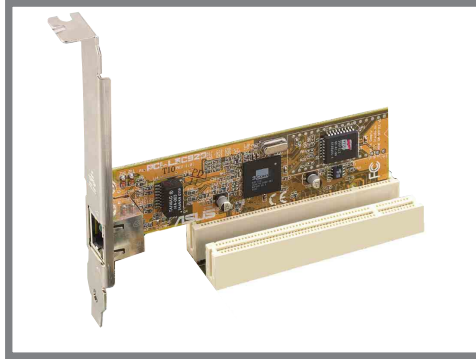

- When installing long PCI cards, it is recommended that to install in PCI slots 2, 4 or 5. Long PCI cards installed in PCI slot 1 may interfere with the SATA connectors.
- When installing 64-bit PCI cards, it is recommended not to install in PCI slot 3. 64-bit PCI cards installed in PCI slot 3 may interfere with the USB connectors.

## 1.10.3 AGP slot

This motherboard has an Accelerated Graphics Port (AGP) slot that supports AGP 8X (+0.8V) cards and AGP 4X (+1.5V) cards. When you buy an AGP card, make sure that you ask for one with +0.8V or +1.5V specification.

Note the notches on the card golden fingers to ensure that they fit the AGP slot on your motherboard.



Install only +0.8V or +1.5V AGP cards. This motherboard does not support 3.3V AGP cards.

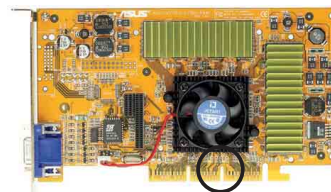
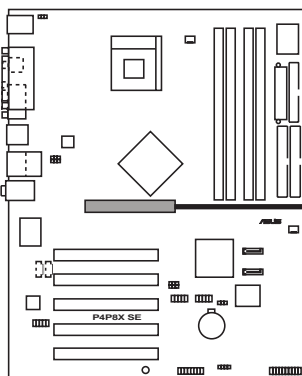

Keyed for 1.5v

### P4P8X SE Accelerated Graphics Port (AGP)



If installing the ATi 9500 or 9700 Pro Series VGA cards, use only the card version **PN xxx-xxxxx-30** or later, for optimum performance and overclocking stability.

# 1.11 Jumpers

## 1. Clear RTC RAM (CLRTC1)

This jumper allows you to clear the Real Time Clock (RTC) RAM in CMOS. You can clear the CMOS memory of date, time, and system setup parameters by erasing the CMOS RTC RAM data. The RAM data in CMOS, that include system setup information such as system passwords, is powered by the onboard button cell battery.

To erase the RTC RAM:

1. Turn OFF the computer and unplug the power cord.
2. Move the jumper cap from pins 1-2 (default) to pins 2-3. Keep the cap on pins 2-3 for about 5~10 seconds, then move the cap back to pins 1-2.
3. Plug the power cord and turn ON the computer.
4. Hold down the <Del> key during the boot process and enter BIOS setup to re-enter data.



Except when clearing the RTC RAM, never remove the cap on CLRTC1 jumper default position. Removing the cap will cause system boot failure!

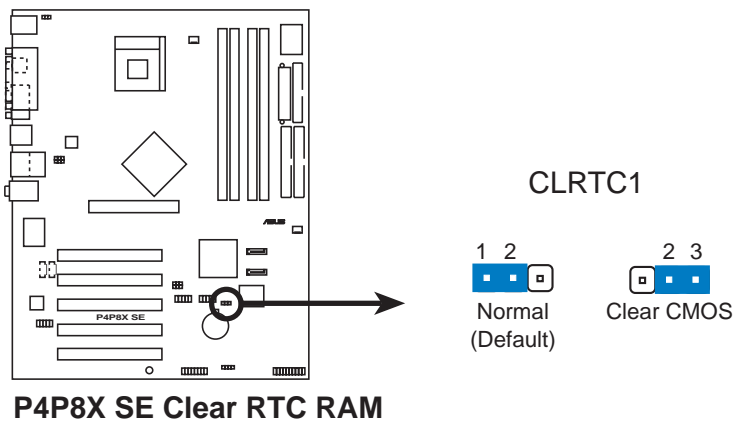

There is no need to clear the RTC when the system hands due to overclocking. For system failure due to overclocking, use the C.P.R. (CPU Parameter Recall) feature. Reboot the system and the BIOS will automatically reset the CPU parameters to its previous setting.

## 2. USB device wake-up (3-pin USBPW12, USBPW34, USBPW56, USBPW78)

Set these jumpers to +5V to wake up the computer from S1 sleep mode (CPU stopped, DRAM refreshed, system running in low power mode) using the connected USB devices. Set to +5VSB to wake up from S3 and S4 sleep modes (no power to CPU, DRAM in slow refresh, power supply in reduced power mode).

The USBPW12 and USBPW34 jumpers are for the rear USB ports. The USBPW56 and USBPW78 jumper is for the internal USB header that you can connect to the front USB ports.

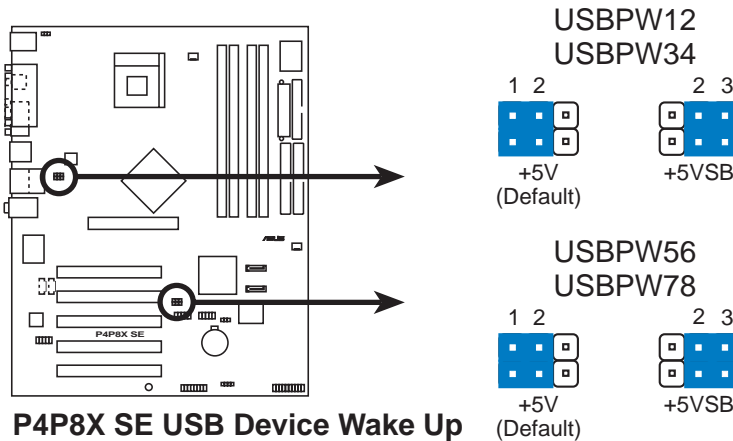

1. The USB device wake-up feature requires a power supply that can provide at least 500mA on the +5VSB lead when these jumpers are set to +5VSB. Otherwise, the system would not power up.
2. The total current consumed must NOT exceed the power supply capability (+5VSB) whether under normal condition or in sleep mode.

## 3. Keyboard power (3-pin KBPWR)

This jumper allows you to enable or disable the keyboard wake-up feature. Set this jumper to pins 2-3 (+5VSB) if you wish to wake up the computer when you press a key on the keyboard (the default value is [Disabled]). This feature requires an ATX power supply that can supply at least 1A on the +5VSB lead and a corresponding setting in the BIOS. (see section 2.5.1 Power Up Control)

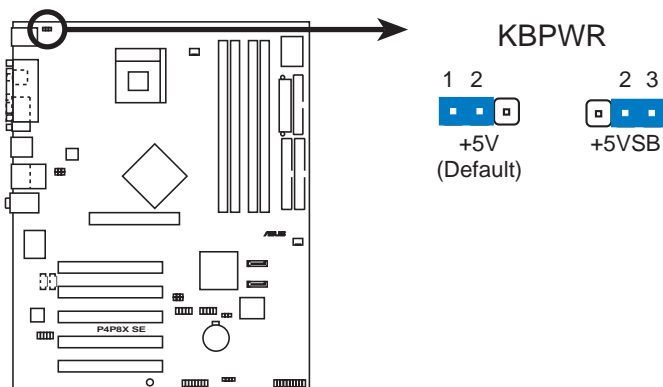

**P4P8X SE Keyboard Power Setting**

## 1.12 Connectors

This section describes and illustrates the internal connectors on the motherboard.

### 1. Floppy disk drive connector (34-1 pin FLOPPY1)

This connector supports the provided floppy drive ribbon cable. After connecting one end to the motherboard, connect the other end to the floppy drive. (Pin 5 is removed to prevent incorrect insertion when using ribbon cables with pin 5 plug).

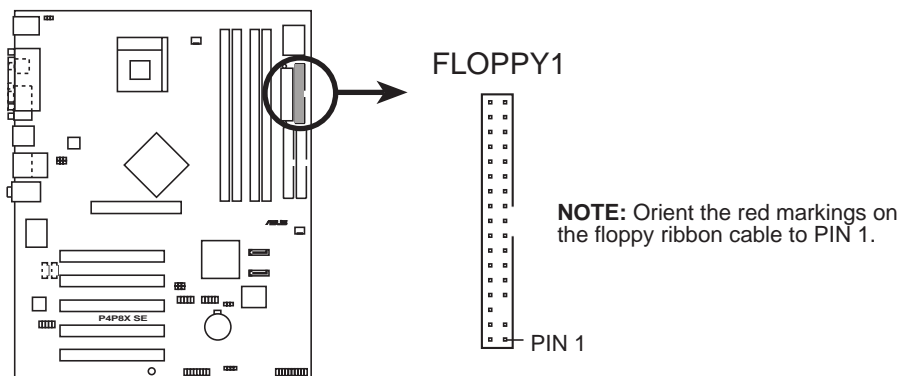

**P4P8X SE Floppy Disk Drive Connector**

### 2. GAME/MIDI connector (16-1 pin GAME1)

This connector supports an optional GAME/MIDI module. Connect the GAME/MIDI cable to this connector. The GAME/MIDI port on the module connects a joystick or a game pad for playing games, and MIDI devices for playing or editing audio files.



The USB 2.0/GAME module is purchased separately.

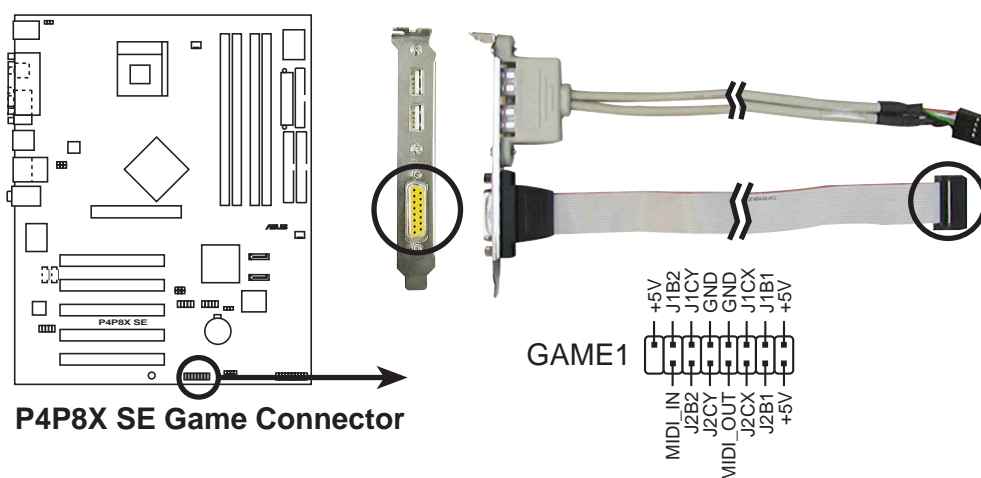

**P4P8X SE Game Connector**

### 3. IDE connectors (40-1 pin PRI\_IDE1, SEC\_IDE1)

This connector supports the provided UltraDMA100/66 IDE ribbon cable. Connect the cable's blue connector to the primary (recommended) or secondary IDE connector, then connect the gray connector to the UltraDMA100/66 slave device (hard disk drive) and the black connector to the UltraDMA100/66 master device. It is recommended that you connect non-UltraDMA100/66 devices to the secondary IDE connector. If you install two hard disks, you must configure the second drive as a slave device by setting its jumper accordingly. Refer to the hard disk documentation for the jumper settings. BIOS supports specific device bootup. If you have more than two UltraDMA100/66/33 devices, purchase another UltraDMA100/66/33 cable. You may configure two hard disks to be both master devices with two ribbon cables – one for the primary IDE connector and another for the secondary IDE connector.



1. Pin 20 on each IDE connector is removed to match the covered hole on the UltraDMA cable connector. This prevents incorrect orientation when you connect the cables.
2. The hole near the blue connector on the UltraDMA100/66 cable is intentional.
3. For UltraDMA100/66 IDE devices, use the 80-conductor IDE cable.

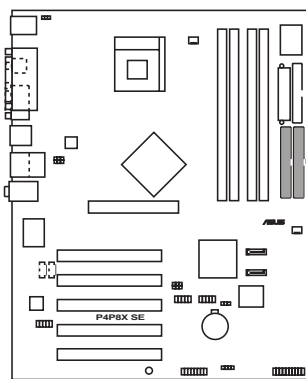

**P4P8X SE IDE Connectors**

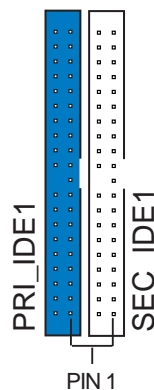

**NOTE:** Orient the red markings (usually zigzag) on the IDE ribbon cable to PIN 1.



#### **Important note when using legacy OS**

Refer to page 1-23 on how to configure P-ATA and S-ATA devices if you installed a legacy operating system (e.g. MS-DOS, Windows 98/Me/NT4.0).



#### 4. Serial ATA connectors (7-pin SATA1, SATA2)

These next generation connectors support the thin Serial ATA cables for Serial ATA hard disks. The current Serial ATA interface allows up to 150 MB/s data transfer rate, faster than the standard parallel ATA with 133 MB/s (Ultra ATA/133).

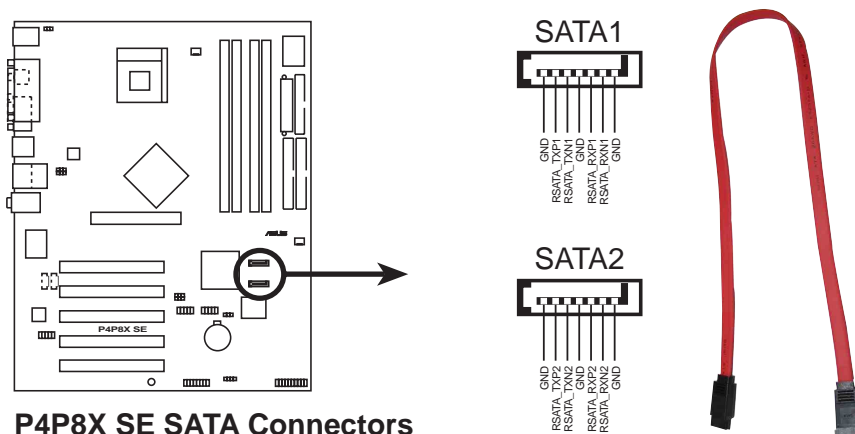

**P4P8X SE SATA Connectors**



##### Important notes on Serial ATA solution:

- In legacy operating system (Win98, WinME, WinNT, DOS) environment, using SATA will disable one of the IDE channels from ICH5 south bridge chipset. See BIOS section for correct settings.
- Hot plug support for Serial ATA drive and connections are not available in this motherboard.

### Parallel ATA and Serial ATA device configurations

Following are the Parallel ATA and Serial ATA device configurations supported by Intel ICH5 specifications.

**Native** operating systems (OS) are Windows 2000/XP. ICH5 supports a maximum of six (6) devices using these OS.

**Legacy** OS are MS-DOS, Windows 98/Me/NT4.0. ICH5 supports a maximum of four (4) devices using these OS.

Operating System	P-ATA		S-ATA	
	Primary (2 devices)	Secondary (2 devices)	Port 0 (1 device)	Port 1 (1 device)
1. Windows 2000/XP	✓	✓	✓	✓
2. Windows 98/Me/NT4.0				
Configuration A	✓	—	✓	✓
Configuration B	—	✓	✓	✓
Configuration C	✓	✓	—	—

##### Legend:

- ✓ Supported
- Disabled

## Required IDE Configuration settings in BIOS

Refer to the following table for the appropriate BIOS settings of the above P-ATA and S-ATA device configurations. See section “2.3.6 IDE Configuration” for details on the related BIOS items.

BIOS item	Windows 2000/XP	Windows 98/Me/NT4.0		
		A	B	C
Onboard IDE Operate Mode	Enhanced Mode	Compatible Mode	Compatible Mode	Compatible Mode
Enhanced Mode Support On	S-ATA	—	—	—
IDE Port Settings	—	Primary P-ATA+S-ATA	Sec. P-ATA+S-ATA	P-ATA Ports Only



- When using Serial ATA function, make sure that the Windows® XP™ Service Pack 1 is installed.
- When using Serial ATA hard disks in a legacy operating system (Windows 98, 98SE, ME, NT, DOS) make sure to adjust the appropriate BIOS settings. Refer to section “2.3.6 IDE Configuration” in page 2-12 for more detailed setting information.

### 5. ATX power connectors (20-pin ATXPWR1, 4-pin ATX12V1)

These connectors connect to an ATX 12V power supply. The plugs from the power supply are designed to fit these connectors in only one orientation. Find the proper orientation and push down firmly until the connectors completely fit.

In addition to the 20-pin ATXPWR1 connector, this motherboard requires that you connect the 4-pin ATX +12V power plug to provide sufficient power to the CPU.



- Do not forget to connect the 4-pin ATX +12V power plug. Otherwise, the system will not boot up.
- Make sure that your ATX 12V power supply can provide 8A on the +12V lead and at least 1A on the +5-volt standby lead (+5VSB). The minimum recommended wattage is 230W, or 300W for a fully configured system. The system may become unstable and may experience difficulty powering up if the power supply is inadequate.

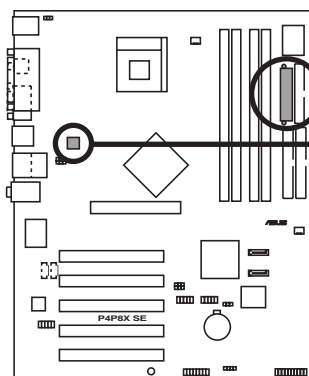

**P4P8X SE ATX Power Connector**

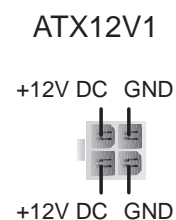
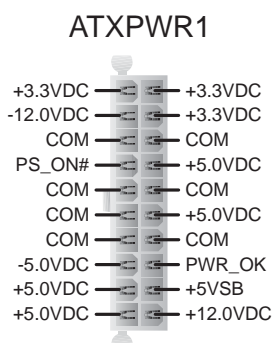

## 6. CPU and chassis fan connectors (3-pin CPU\_FAN1, CHA\_FAN1, PWR\_FAN1)

The fan connectors support cooling fans of 350mA~740mA (8.88W max.) or a total of 1A~2.22A (26.64W max.) at +12V. Connect the fan cables to the fan connectors on the motherboard, making sure that the black wire of each cable matches the ground pin of the connector.



Do not forget to connect the fan cables to the fan connectors. Lack of sufficient air flow within the system may damage the motherboard components. These are not jumpers! DO NOT place jumper caps on the fan connectors!

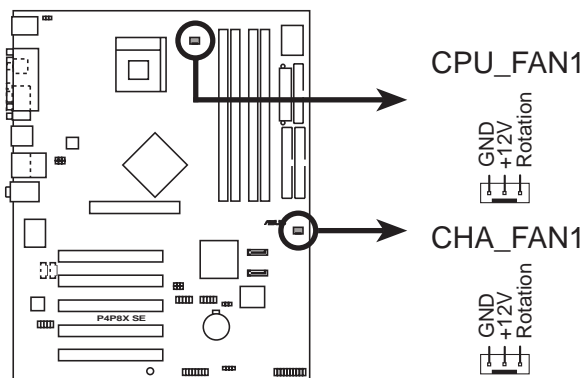

**P4P8X SE 12-Volt Fan Connectors**

## 7. Front panel audio connector (10-1 pin FP\_AUDIO)

This is an interface for the Intel front panel audio cable that allow convenient connection and control of audio devices.

By default, the pins labeled LINE OUT\_R/BLINE\_OUT\_R and the pins LINE OUT\_L/BLINE\_OUT\_L are shorted with jumper caps. Remove the caps only when you are connecting the front panel audio cable.

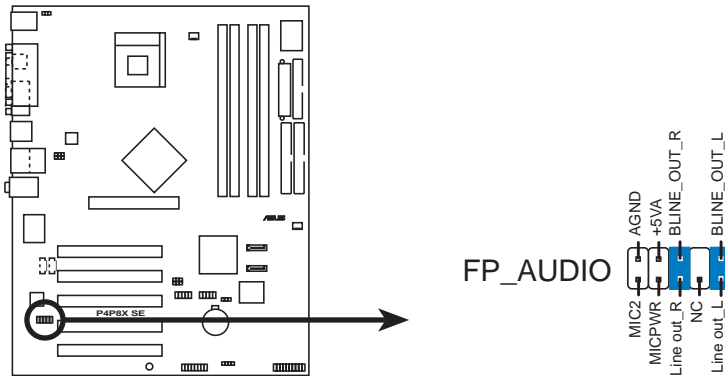

**P4P8X SE Front Panel Audio Connector**

## 8. Chassis intrusion connector (4-1 pin CHASSIS1)

This lead is for a chassis designed with intrusion detection feature. This requires an external detection mechanism such as a chassis intrusion sensor or microswitch. When you remove any chassis component, the sensor triggers and sends a high-level signal to this lead to record a chassis intrusion event.

By default, the pins labeled “Chassis Signal” and “Ground” are shorted with a jumper cap. If you wish to use the chassis intrusion detection feature, remove the jumper cap from the pins.

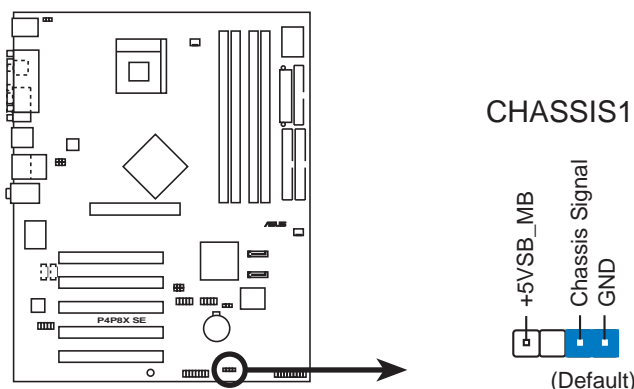

**P4P8X SE Chassis Alarm Lead**

## 9. Internal audio connectors (4-pin CD1, AUX1)

These connectors allow you to receive stereo audio input from sound sources such as a CD-ROM, TV tuner, or MPEG card.

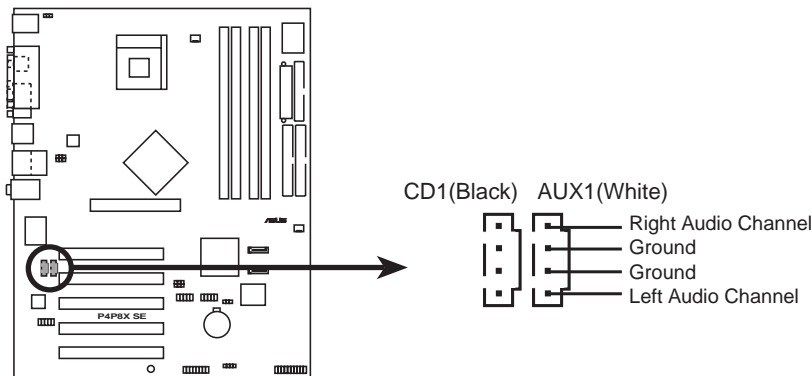

**P4P8X SE Internal Audio Connectors**

## 10. USB header (10-1 pin USB56, USB78)

If the USB ports on the rear panel are inadequate, two USB headers are available for additional USB ports. The USB header complies with USB 2.0 specification that supports up to 480 Mbps connection speed. This speed advantage over the conventional 12 Mbps on USB 1.1 allows faster Internet connection, interactive gaming, and simultaneous running of high-speed peripherals.

Connect an optional USB 2.0/GAME module to this header. The module has two USB 2.0 ports that support the next generation USB peripherals such as high resolution cameras, scanners, and printers.



You must install the driver before you can use the USB 2.0 capability.

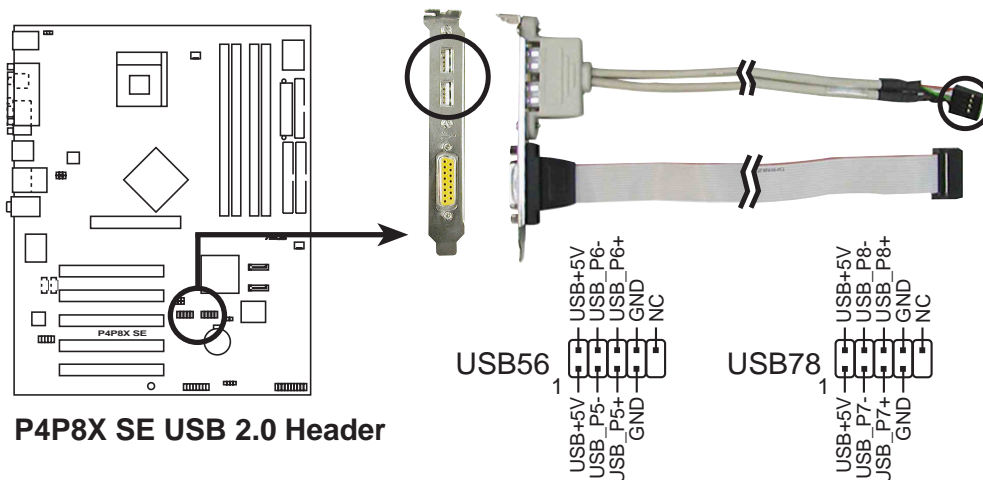

The USB 2.0/GAME module is purchased separately.

## 11. System panel connector (20-pin PANEL1)

This connector accommodates several system front panel functions.

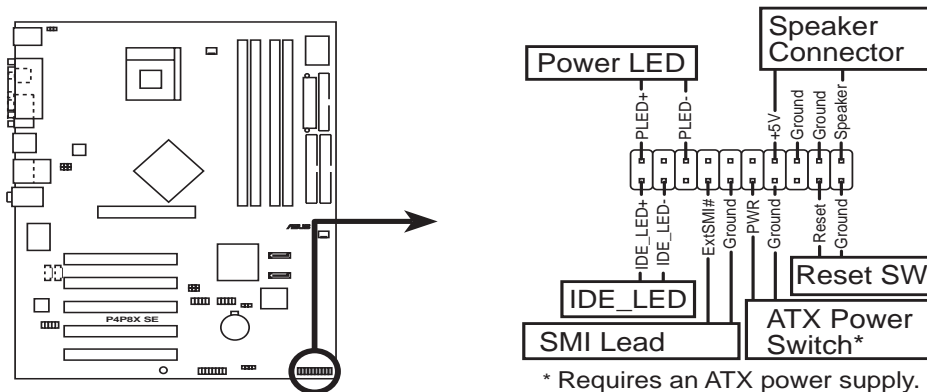

**P4P8X SE System Panel Connectors**

- **System Power LED Lead (3-1 pin PLED)**

This 3-1 pin connector connects to the system power LED. The LED lights up when you turn on the system power, and blinks when the system is in sleep mode.

- **Hard disk activity LED (2-pin IDELED)**

This 2-pin connector supplies power to the hard disk activity LED. The read and write activities of any device connected to the primary or secondary IDE connector cause this LED to light up.

- **System Warning Speaker Lead (4-pin SPEAKER)**

This 4-pin connector connects to the case-mounted speaker and allows you to hear system beeps and warnings.

- **System Management Interrupt Lead (2-pin SMI)**

This 2-pin connector allows you to manually place the system into a suspend mode, or “green” mode, where system activity is instantly decreased to save power and to expand the life of certain system components. Attach the case-mounted suspend switch to this 2-pin connector.

- **ATX Power Switch / Soft-Off Switch Lead (2-pin PWR)**

This connector connects a switch that controls the system power. Pressing the power switch turns the system between ON and SLEEP, or ON and SOFT OFF, depending on the BIOS or OS settings. Pressing the power switch while in the ON mode for more than 4 seconds turns the system OFF.

- **Reset Switch Lead (2-pin RESET)**

This 2-pin connector connects to the case-mounted reset switch for rebooting the system without turning off the system power.

# ***Chapter 2***

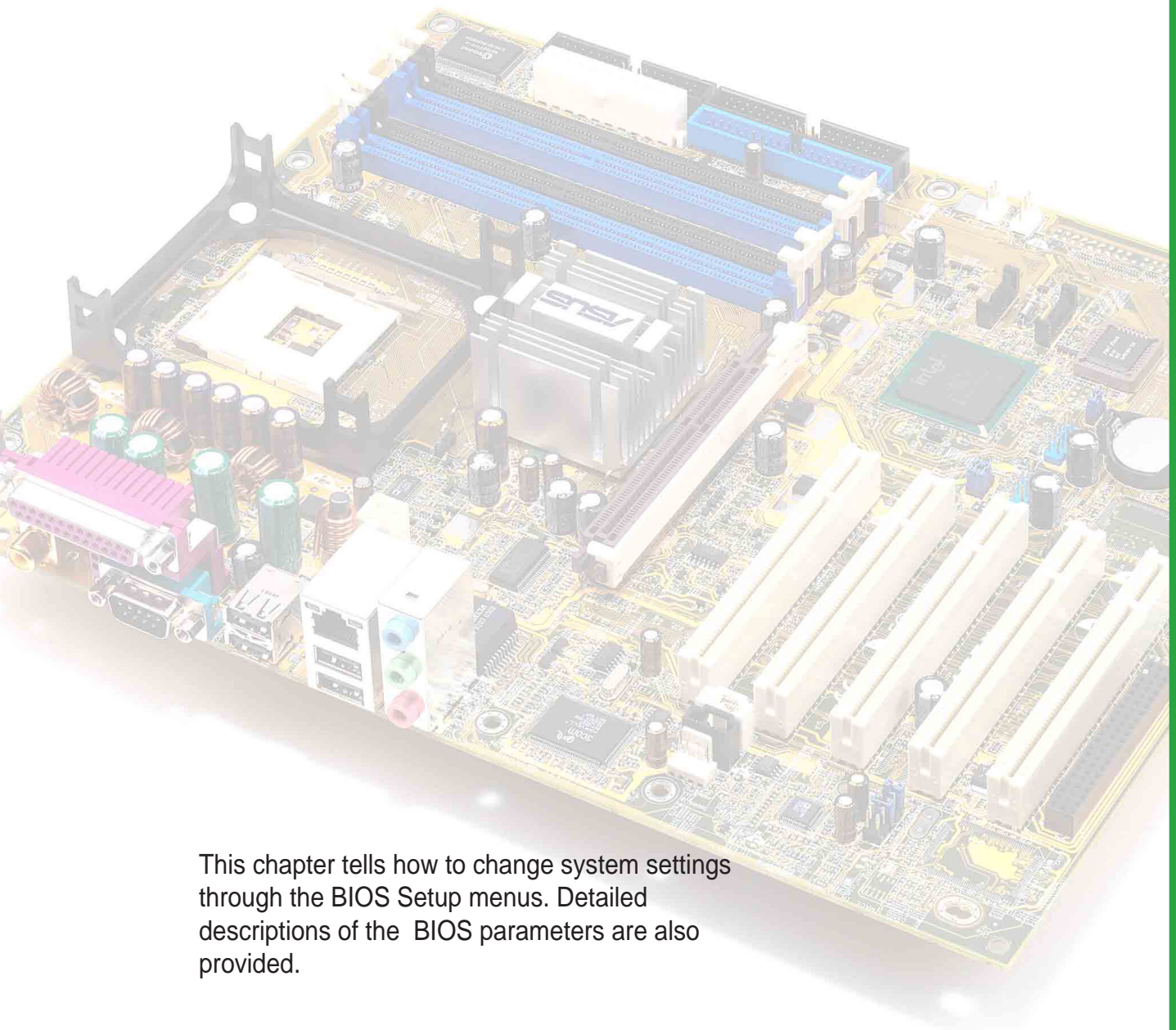

This chapter tells how to change system settings through the BIOS Setup menus. Detailed descriptions of the BIOS parameters are also provided.

## **BIOS information**

## 2.1 Managing and updating your BIOS



---

The **original BIOS file** for this motherboard is in the support CD.

Copy the original BIOS to a **bootable floppy disk** in case you need to restore the BIOS in the future.

---

### 2.1.1 Creating a bootable floppy disk

1. Do either one of the following to create a bootable floppy disk.

#### DOS environment

Insert a 1.44 MB floppy disk into the drive. At the DOS prompt, type:

**format A:/S** <Enter>

#### Windows environment

- a. From your Windows desktop, click on **Start**, point to **Settings**, then click on **Control Panel**.
  - b. Double-click on **Add/Remove Programs** icon from the Control Panel window.
  - c. Click on the **Startup Disk** tab, then on **Create Disk...** button.
  - d. Insert a 1.44 MB floppy disk when prompted. Follow the succeeding screen instructions to complete the process.
2. Copy the original (or the latest) motherboard BIOS to the bootable floppy disk.

### 2.1.2 Using AFUDOS to update the BIOS

Update the BIOS using the AFUDOS.EXE utility in DOS environment.

1. Visit the ASUS website ([www.asus.com](http://www.asus.com)) to download the latest BIOS file for your motherboard. Save the BIOS file to a bootable floppy disk.



---

Write down the BIOS file name to a piece of paper. You need to type the **exact BIOS file name** at the prompt.

---

2. Copy the AFUDOS.EXE utility from the support CD to the bootable floppy disk that contains the BIOS file.
3. Boot the system from the floppy disk.



---

DO NOT use the **P4P8X** BIOS file for this motherboard.

---



4. At the DOS prompt, type the command line:

**afudos /i<filename>**

where “filename” means the latest (or original) BIOS file that you copied to the bootable floppy disk.

The screen displays the status of the update process.



---

The BIOS information on the screen is for reference only. What you see on your screen may not be exactly the same as shown.

---

```
A:\>afudos /ip4p8xse.rom
AMI Firmware Update Utility - Version 1.10
Copyright (C) 2002 American Megatrends, Inc. All rights reserved.

Reading file ..... done
Erasing flash .... done
Writing flash .... 0x0008CC00 (9%)
```



---

**DO NOT** shutdown or reset the system while updating the BIOS! Doing so may cause system boot failure!

---

When the BIOS update process is complete, the utility returns to the DOS prompt.

```
A:\>afudos /ip4p8xse.rom
AMI Firmware Update Utility - Version 1.10
Copyright (C) 2002 American Megatrends, Inc. All rights reserved.

Reading file ..... done
Erasing flash .... done
Writing flash .... 0x0008CC00 (9%)
Verifying flash .. done

A:\>
```

5. Reboot the system from the hard disk.

## 2.1.3 Using ASUS EZ Flash to update the BIOS

The ASUS EZ Flash feature allows you to easily update the BIOS without having to go through the long process of booting from a diskette and using a DOS-based utility. The EZ Flash is built-in the BIOS firmware so it is accessible by simply pressing <Alt+F2> during the Power-On Self Tests (POST).

### To update the BIOS using ASUS EZ Flash:

1. Visit the ASUS website ([www.asus.com](http://www.asus.com)) to download the latest BIOS file for your motherboard and rename it to **P4P8XSE.ROM**. Save the BIOS file to a floppy disk.
2. Reboot the system.
3. To launch EZ Flash, press <Alt+F2> during POST to display the following.

```
User recovery requested. Starting BIOS recovery...
Checking for floppy...
```



---

If there is no floppy disk found in the drive, the error message “**Floppy not found!**” appears.

If the correct BIOS file is not found in the floppy disk, the error message “**P4P8XSE.ROM not found!**”

---

4. Insert the floppy disk that contains the BIOS file. If the **P4P8XSE.ROM** file is found in the floppy disk, EZ Flash performs the BIOS update process and automatically reboots the system when done.



---

DO NOT shutdown or reset the system while updating the BIOS! Doing so may cause system boot failure!

---

```
User recovery requested. Starting BIOS recovery...
Checking for floppy...
Floppy found!
Reading file "p4p8xse.rom". Completed.
Start flashing...
Flashed successfully. Rebooting.
```

## 2.1.4 Recovering the BIOS with CrashFree BIOS 2

The CrashFree BIOS 2 auto recovery tool allows you to restore BIOS from the motherboard support CD, or from a floppy disk that contains the BIOS file, in case the current BIOS on the motherboard fails or gets corrupted.



1. Prepare the **support CD** that came with the motherboard or a **floppy disk that contains the motherboard BIOS** (P4P8XSE.ROM) before proceeding with the BIOS update process.
2. If you have saved a copy of the original motherboard BIOS to a bootable floppy disk, you may also use this disk to restore the BIOS. See section "2.1.1 Creating a bootable floppy disk."

### To recover the BIOS from a floppy disk:

1. Boot the system.
2. When a corrupted BIOS is detected, the following message appears.

```
Bad BIOS checksum. Starting BIOS recovery...  
Checking for floppy...
```

3. Insert a floppy disk that contains the original, or the latest, BIOS file for this motherboard (P4P8XSE.ROM). If the BIOS file that you downloaded from the ASUS website has a different filename (e.g. P4P8XSE11.ROM), rename it to **P4P8XSE.ROM**. The BIOS update process continues when the P4P8XSE.ROM is found.

```
Bad BIOS checksum. Starting BIOS recovery...  
Checking for floppy...  
Floppy found!  
Reading file "p4p8xse.rom". Completed.  
Start flashing...
```



DO NOT shutdown or reset the system while updating the BIOS! Doing so may cause system boot failure!

4. When the BIOS update process is complete, reboot the system.

## To recover the BIOS from the support CD:

1. Boot the system.
2. When a corrupted BIOS is detected, the following screen message appears.

```
Bad BIOS checksum. Starting BIOS recovery...
Checking for floppy...
```



---

If there is no floppy disk found in the drive, the system automatically checks the CD-ROM.

---

3. Place the support CD in the CD-ROM. The support CD contains the original BIOS for this motherboard.

```
Bad BIOS checksum. Starting BIOS recovery...
Checking for floppy...
Floppy not found!
Checking for CD-ROM...
CD-ROM found.
Reading file "p4p8xse.rom". Completed.
Start flashing...
```



---

**DO NOT** shutdown or reset the system while updating the BIOS! Doing so may cause system boot failure!

---

4. When the BIOS update process is complete, reboot the system.



---

The recovered BIOS may not be the latest BIOS version for this motherboard. Visit the ASUS website ([www.asus.com](http://www.asus.com)) to download the latest BIOS file.

---

## 2.2 BIOS Setup program

This motherboard supports a programmable firmware hub (FWH) that you can update using the provided utility described in section “2.1 Managing and updating your BIOS.”

Use the BIOS Setup program when you are installing a motherboard, reconfiguring your system, or prompted to “Run Setup”. This section explains how to configure your system using this utility.

Even if you are not prompted to use the Setup program, you may want to change the configuration of your computer in the future. For example, you may want to enable the security password feature or make changes to the power management settings. This requires you to reconfigure your system using the BIOS Setup program so that the computer can recognize these changes and record them in the CMOS RAM of the firmware hub.

The firmware hub on the motherboard stores the Setup utility. When you start up the computer, the system provides you with the opportunity to run this program. Press <Delete> during the Power-On Self Test (POST) to enter the Setup utility, otherwise, POST continues with its test routines.

If you wish to enter Setup after POST, restart the system by pressing <Ctrl+Alt+Delete>, or by pressing the reset button on the system chassis. You can also restart by turning the system off and then back on. Do this last option only if the first two failed.

The Setup program is designed to make it as easy to use as possible. It is a menu-driven program, which means you can scroll through the various sub-menus and make your selections among the predetermined choices.



---

Because the BIOS software is constantly being updated, the following BIOS setup screens and descriptions are for reference purposes only, and may not exactly match what you see on your screen.

---

## 2.2.1 BIOS menu screen

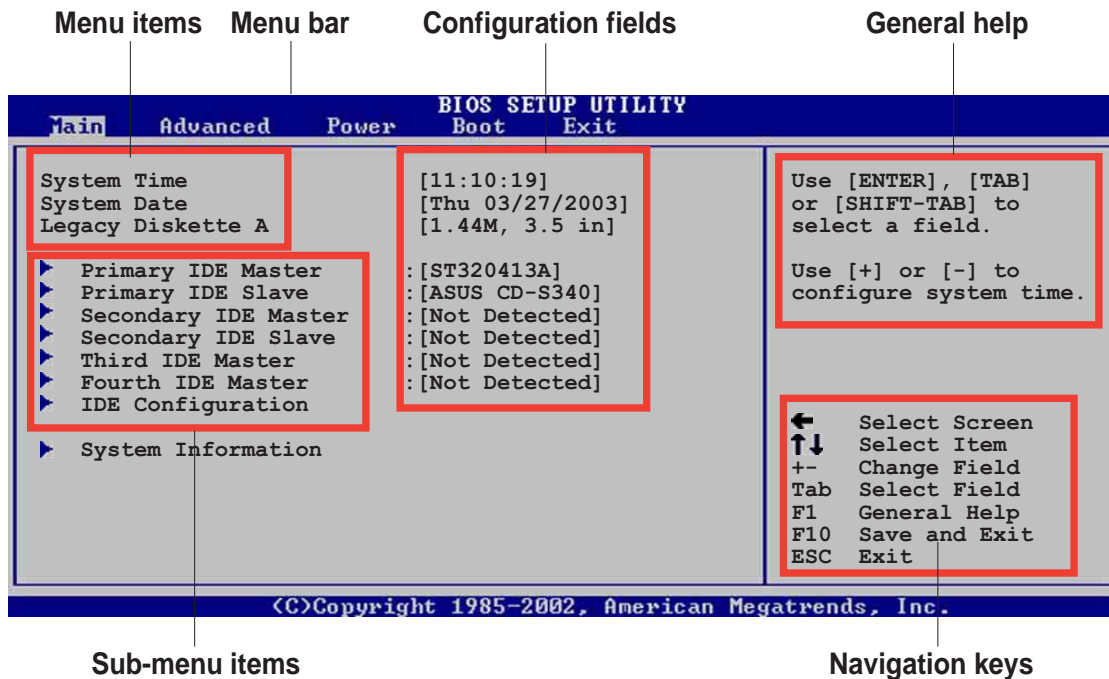

## 2.2.2 Menu bar

The menu bar on top of the screen has the following main items:

- |                 |  |
|-----------------|--|
| <b>Main</b>     | For changing the basic system configuration                    |
| <b>Advanced</b> | For changing the advanced system settings                      |
| <b>Power</b>    | For changing the advanced power management (APM) configuration |
| <b>Boot</b>     | For changing the system boot configuration                     |
| <b>Exit</b>     | For selecting the exit options and loading default settings    |

To select an item on the menu bar, press the right or left arrow key on the keyboard until the desired item is highlighted.

## 2.2.3 Navigation keys

At the **bottom right corner** of a menu screen are the navigation keys for that particular menu. Use the navigation keys to select items in the menu and change the settings.



Some of the navigation keys differ from one screen to another.

## 2.2.4 Menu items

The highlighted item on the menu bar displays the specific items for that menu. For example, selecting **Main** shows the Main menu items.

The other items (Advanced, Power, Boot, and Exit) on the menu bar have their respective menu items.

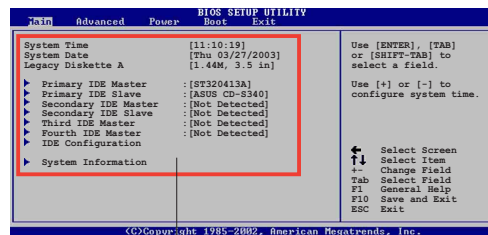

Main menu items

## 2.2.5 Sub-menu items

An item with a sub-menu on any menu screen is distinguished by a solid triangle before the item. To display the sub-menu, select the item and press Enter.

## 2.2.6 Configuration fields

These fields show the values for the menu items. If an item is user-configurable, you may change the value of the field opposite the item. You can not select an item that is not user-configurable.

A configurable field is enclosed in brackets, and is highlighted when selected. To change the value of a field, select it then press Enter to display a list of options. Refer to “2.2.7 Pop-up window.”

## 2.2.7 Pop-up window

Select a menu item then press Enter to display a pop-up window with the configuration options for that item.

## 2.2.8 Scroll bar

A scroll bar appears on the right side of a menu screen when there are items that do not fit on the screen. Press **Up/Down arrow keys** or **PageUp/PageDown keys** to display the other items on the screen.

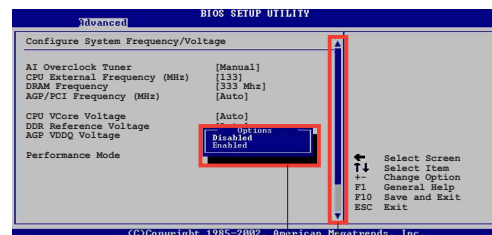

Pop-up window

Scroll bar

## 2.2.9 General help

At the top right corner of the menu screen is a brief description of the selected item.

## 2.3 Main menu

When you enter the BIOS Setup program, the Main menu screen appears giving you an overview of the basic system information.



Refer to section “2.2.1 BIOS menu screen” for information on the menu screen items and how to navigate through them.

```
BIOS SETUP UTILITY
Main  Advanced  Power  Boot  Exit

System Time           [11:10:19]
System Date           [Thu 03/27/2003]
Legacy Diskette A    [1.44M, 3.5 in]

▶ Primary IDE Master   : [ST320413A]
▶ Primary IDE Slave    : [ASUS CD-S340]
▶ Secondary IDE Master : [Not Detected]
▶ Secondary IDE Slave  : [Not Detected]
▶ Third IDE Master     : [Not Detected]
▶ Fourth IDE Master    : [Not Detected]
▶ IDE Configuration

▶ System Information

Use [ENTER], [TAB]
or [SHIFT-TAB] to
select a field.

Use [+] or [-] to
configure system time.

← Select Screen
↑↓ Select Item
+- Change Field
Tab Select Field
F1 General Help
F10 Save and Exit
ESC Exit

<C>Copyright 1985-2002, American Megatrends, Inc.
```

### 2.3.1 System Time [xx:xx:xxxx]

This item allows you to set the system time.

### 2.3.2 System Date [Day xx/xx/xxxx]

This item allows you to set the system date.

### 2.3.3 Legacy Diskette A [1.44M, 3.5 in.]

Sets the type of floppy drive installed. Configuration options: [Disabled] [360K, 5.25 in.] [1.2M , 5.25 in.] [720K , 3.5 in.] [1.44M, 3.5 in.] [2.88M, 3.5 in.]



## 2.3.4 Primary/Secondary/Third/Fourth IDE Master/Slave

While entering Setup, BIOS auto-detects the presence of IDE devices. There is a separate sub-menu for each IDE device. Select a device item then press Enter to display the IDE device information.

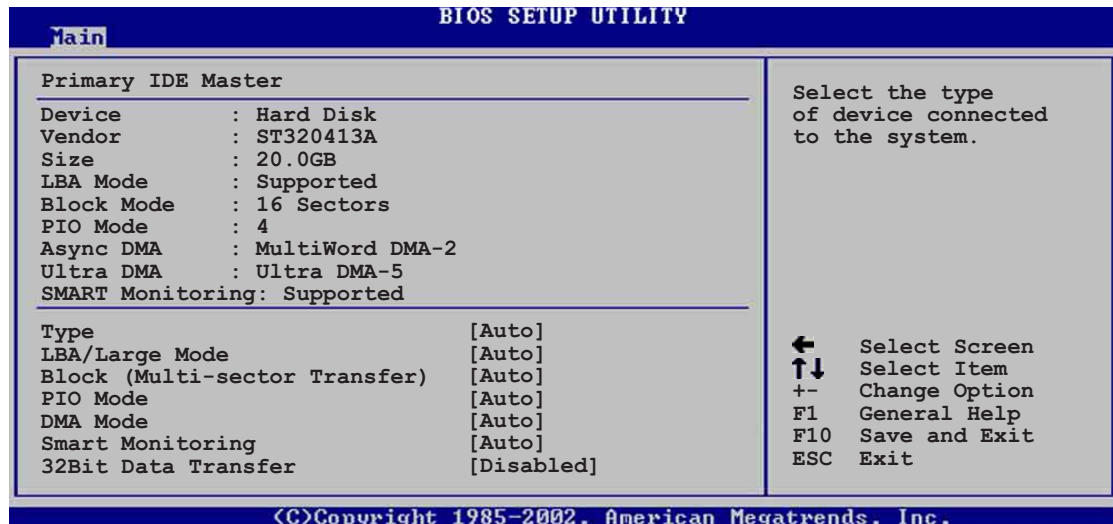

The values opposite the dimmed items (Device, Vendor, Size, LBA Mode, Block Mode, PIO Mode, Async DMA, Ultra DMA, and SMART monitoring) are auto-detected by BIOS and are not user-configurable. These items show N/A if no IDE device is installed in the system.

### Type [Auto]

Selects the type of IDE drive. Configuration options: [Not Installed] [Auto] [CDROM] [ARMD]

### LBA/Large Mode [Auto]

Enables or disables the LBA mode. Setting to Auto enables the LBA mode if the device supports this mode, and if the device was not previously formatted with LBA mode disabled. Configuration options: [Disabled] [Auto]

### Block (Multi-sector Transfer) [Auto]

Enables or disables data multi-sectors transfers. When set to Auto, the data transfer from and to the device occurs multiple sectors at a time if the device supports multi-sector transfer feature. When set to Disabled, the data transfer from and to the device occurs one sector at a time. Configuration options: [Disabled] [Auto]

### PIO Mode [Auto]

Selects the PIO mode. Configuration options: [Auto] [0] [1] [2] [3] [4]

### DMA Mode [Auto]

Selects the DMA mode. Configuration options: [Auto] [SWDMA0] [SWDMA1] [SWDMA2] [MWDMA0] [MWDMA1] [MWDMA2] [UDMA0] [UDMA1] [UDMA2] [UDMA3] [UDMA4] [UDMA5]

### SMART Monitoring [Auto]

Sets the Smart Monitoring, Analysis, and Reporting Technology. Configuration options: [Auto] [Disabled] [Enabled]

### 32Bit Data Transfer [Disabled]

Enables or disables 32-bit data transfer. Configuration options: [Disabled] [Enabled]

## 2.3.5 IDE Configuration

The items in this menu allows you to change the settings for the IDE devices installed in the system. Select an item then press Enter if you wish to configure the item.

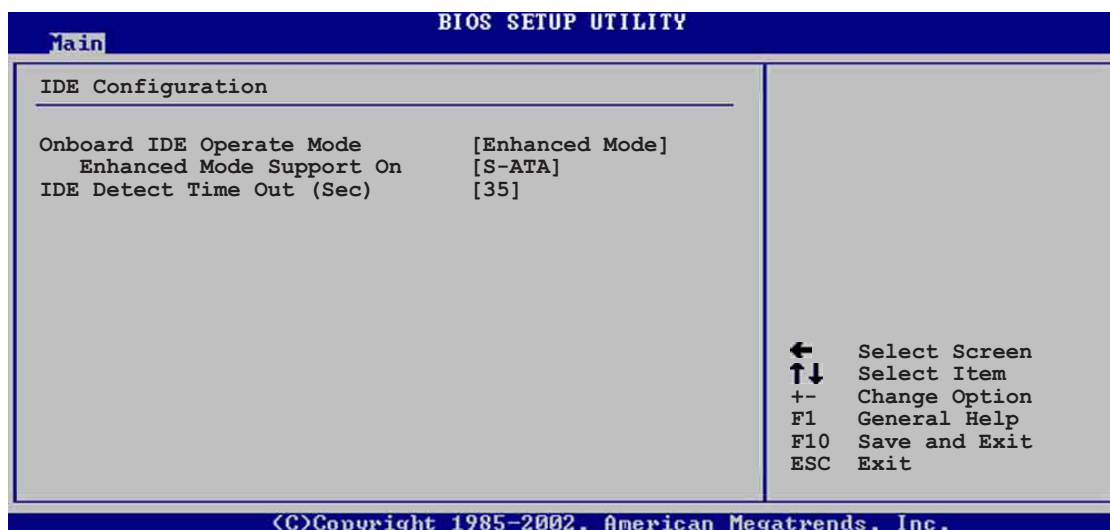

### Onboard IDE Operate Mode [Enhanced Mode]

Allows selection of the IDE operation mode depending on the operating system (OS) that you installed. Set to Enhanced Mode if you are using native OS, such as Windows 2000/XP. Set to Compatible Mode if you are using legacy OS including MS-DOS, Windows ME/98/NT4.0.

Configuration options: [Compatible Mode] [Enhanced Mode]



Refer to the section "Parallel ATA and Serial ATA device configurations" on page 1-23 for the appropriate settings of the IDE Configuration items under different operating systems.

### Enhanced Mode Support On [S-ATA]

The default setting S-ATA allows you to use native OS on Serial ATA and Parallel ATA ports. We recommend that you do not change the default setting for better OS compatibility. In this setting, you may use legacy OS on the Parallel ATA ports **only if** you did not install any Serial ATA device.

The P-ATA+S-ATA and P-ATA options are for advanced users only. If you set to any of these options and encounter problems, revert to the default setting **S-ATA**. Configuration options: [P-ATA+S-ATA] [S-ATA] [P-ATA]



---

The **Enhanced Mode Support On** appears only when the item **Onboard IDE Operate Mode** is set to **Enhanced Mode**.

---

### IDE Port Settings [Primary P-ATA+S-ATA]

Allows selection of the IDE ports to activate if you are using a **legacy** operating system. Set to [Primary P-ATA+S-ATA] if you wish to use the primary Parallel ATA and Serial ATA ports, or set to [Secondary P-ATA+SATA] to enable the secondary P-ATA port instead. Setting to [P-ATA Ports Only] disables the two Serial ATA ports supported by ICH5. Configuration options: [Primary P-ATA+S-ATA] [Secondary P-ATA+S-ATA] [P-ATA Ports Only]



---

The **IDE Port Settings** appears only when the item **Onboard IDE Operate Mode** is set to **Compatible Mode**.

---

### **IDE Detect Time Out [35]**

Selects the time out value for detecting ATA/ATAPI devices. Configuration options: [0] [5] [10] [15] [20] [25] [30] [35]

## 2.3.6 System Information

This menu gives you an overview of the general system specifications. The items in this menu are auto-detected by BIOS.

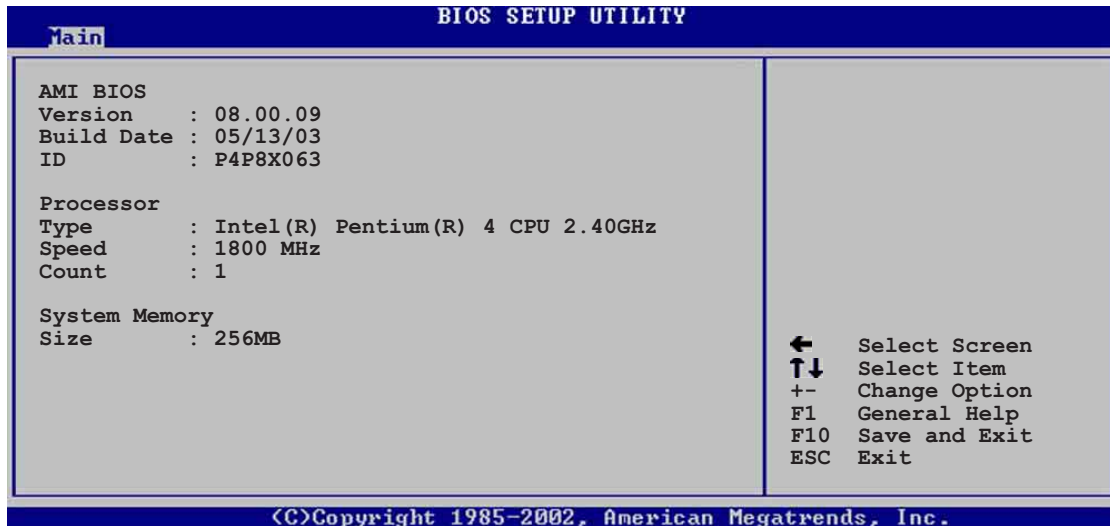

### AMI BIOS

This item displays the auto-detected BIOS information.

### Processor

This item displays the auto-detected CPU specification.

### System Memory

This item displays the auto-detected system memory.

## 2.4 Advanced menu

The Advanced menu items allow you to change the settings for the CPU and other system devices.



Take caution when changing the settings of the Advanced menu items. Incorrect field values may cause the system to malfunction.

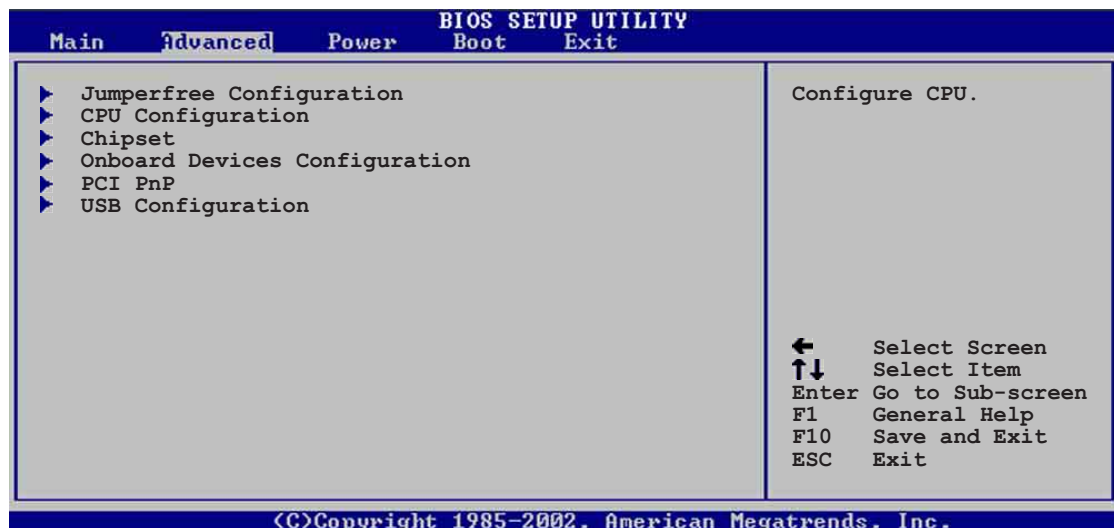

### 2.4.1 JumperFree Configuration

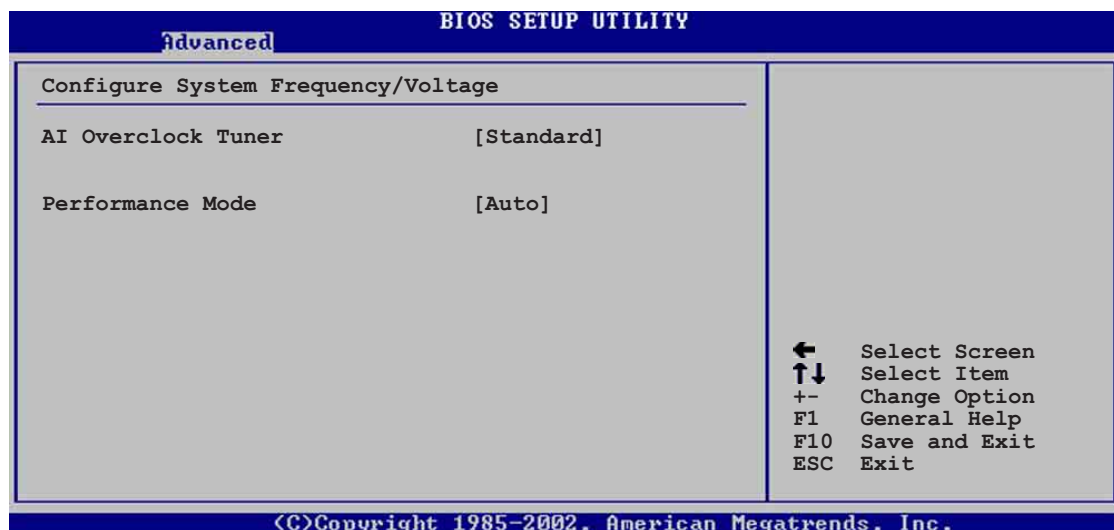

#### AI Overclock Tuner [Standard]

Allows selection of CPU overclocking options to achieve desired CPU internal frequency. Select either one of the preset overclocking options. Configuration options: [Manual] [Standard] [Overclock 5%] [Overclock 10%] [Overclock 20%] [Overclock 30%]



Selecting a very high CPU frequency may cause the system to become unstable! If this happens, revert to the default setting.

When you set the **AI Overclocking Tuner** item to [Manual], the related overclocking items appear.

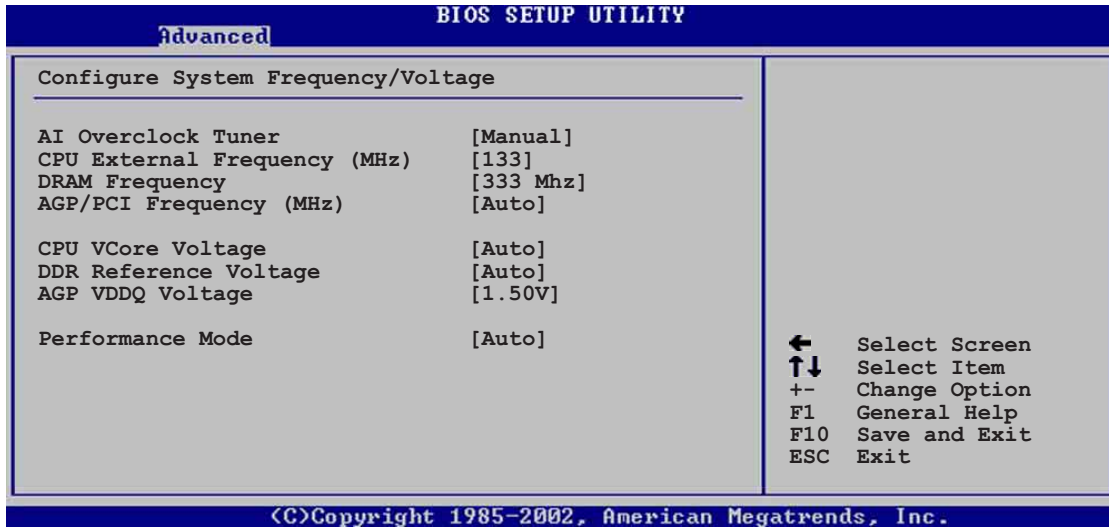

### CPU External Frequency (MHz) [XXX] (value is auto-detected)

Indicates the frequency sent by the clock generator to the system bus and PCI bus. The bus frequency (external frequency) multiplied by the bus multiple equals the CPU speed. The value of this item is auto-detected by BIOS. The values range from 100 to 400, use the plus (+) or minus (-) key to adjust the frequency. Refer to the following table for the correct Front Side Bus and CPU External Frequency settings.

### DRAM Frequency [Auto]

Allows you to set the DDR operating frequency. Configuration options: [266 MHz] [333 MHz] [Auto]

### AGP/PCI Frequency (MHz) [Auto]

Allows you to adjust to a higher AGP/PCI frequency for better system performance and overclocking capability. Configuration options: [Auto] [66.66/33.33] [72.73/36.36] [80.00/40.00]



Selecting a very high AGP/PCI frequency may cause the system to become unstable! If this happens, revert to the default setting.

### CPU VCore Voltage [Auto]

Allows you to select a specific CPU VCore voltage. Configuration options: [Auto] [1.9500V] ... [1.5000V]



Refer to the CPU documentation before setting the CPU VCore voltage. A very high Vcore voltage may severely damage the CPU!

## DDR Reference Voltage [Auto]

Allows selection of the DDR SDRAM operating voltage. Configuration options: [2.85V] [2.75V] [2.65V] [2.55V] [Auto]

## AGP VDDQ voltage [1.50V]

Allows selection of the AGP operating voltage. Configuration options: [1.80V] [1.70V] [1.60V] [1.50V]

## Performance Mode [Auto]

Allows enhanced system performance. Configuration options: [Auto] [Standard] [Turbo]



Setting to **Turbo** may cause the system to become unstable! If this happens, revert to the default setting Auto.

## 2.4.2 CPU Configuration

The items in this menu show the CPU-related information auto-detected by BIOS.

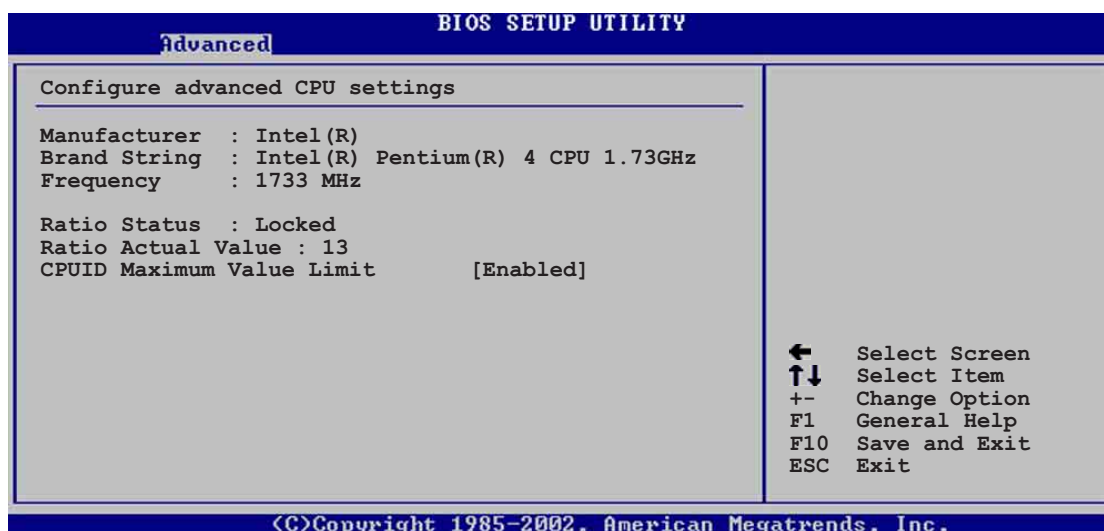

## CPUID Maximum Value Limit [Enabled]

Configuration options: [Disabled] [Enabled]

## 2.4.3 Chipset

The Chipset menu items allow you to change the advanced chipset settings. Select an item then press Enter to display the sub-menu.

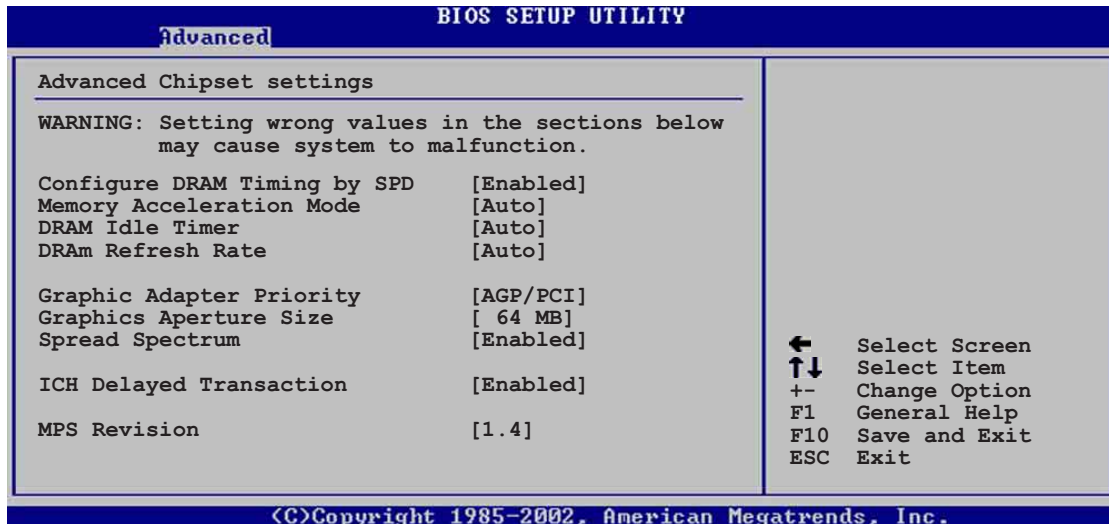

### Configure DRAM Timing by SPD [Enabled]

When this item is enabled, the DRAM timing parameters are set according to the DRAM SPD (Serial Presence Detect). When disabled, you can manually set the DRAM timing parameters through the DRAM sub-items. Configuration options: [Disabled] [Enabled]

### Memory Acceleration Mode [Auto]

This field when [Enabled] minimize latencies from CPU to memory to boost system performance. Configuration options: [Auto] [Enabled]



Setting to **[Enabled]** may cause the system to become unstable! If this happens, revert to the default setting **[Auto]**.

### DRAM Idle Timer [Auto]

Configuration options: [Infinite] [0T] [8T] [16T] [64T] [Auto]

### DRAM Refresh Mode [Auto]

Configuration options: [Auto] [15.6 uSec] [7.8 uSec] [64 uSec] [64T]



If the system becomes unstable after changing the settings of any of the above items, revert to the default settings.



The following sub-items appear only when the item **Configure DRAM Timing by SPD** is set to Disabled.



### DRAM CAS# Latency [2.5 Clocks]

This item controls the latency between the SDRAM read command and the time the data actually becomes available. Configuration options: [2.0 Clocks] [2.5 Clocks] [3.0 Clocks]

### DRAM RAS# Precharge [4 Clocks]

This item controls the idle clocks after issuing a precharge command to the DDR SDRAM. Configuration options: [4 Clocks] [3 Clocks] [2 Clocks]

### DRAM RAS# to CAS# Delay [4 Clocks]

This item controls the latency between the DDR SDRAM active command and the read/write command. Configuration options: [4 Clocks] [3 Clocks] [2 Clocks]

### DRAM Precharge Delay [8 Clocks]

Configuration options: [8 Clocks] [7 Clocks] [6 Clocks] [5 Clocks]

### DRAM Burst Length [4 Clocks]

Configuration options: [4 Clocks] [8 Clocks]

## **Graphic Adapter Priority [AGP/PCI]**

Allows selection of the graphics controller to use as primary boot device. Configuration options: [AGP/PCI] [PCI/AGP]

## **Graphics Aperture Size [64MB]**

Allows you to select the size of mapped memory for AGP graphic data. Configuration options: [4MB] [8MB] [16MB] [32MB] [64MB] [128MB] [256MB]

## **Spread Spectrum [Enabled]**

This field enables or disables the clock generator spread spectrum. Configuration options: [Disabled] [Enabled]

## **ICH Delayed Transaction [Enabled]**

Configuration options: [Disabled] [Enabled]

## **MPS Revision [1.1]**

Configuration options: [1.1] [1.4]

## 2.4.4 Onboard Devices Configuration

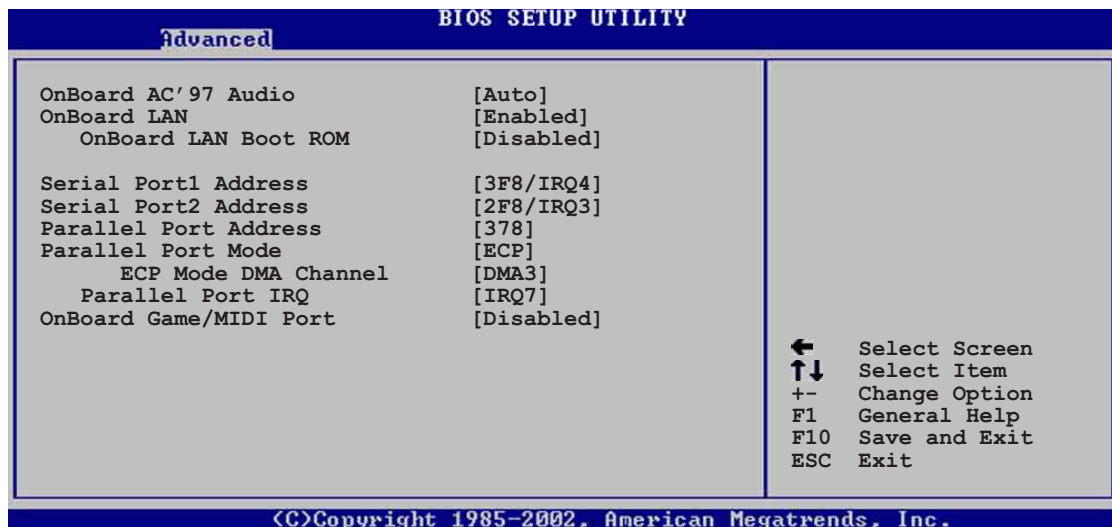

### OnBoard AC'97 Audio [Auto]

[Auto] allows the BIOS to detect whether you are using any audio device. If an audio device is detected, the onboard audio controller is enabled; if no audio device is detected, the controller is disabled. Configuration options: [Disabled] [Auto]

### OnBoard LAN [Enabled]

Allows you to enable or disable the onboard LAN controller. Configuration options: [Disabled] [Enabled]

#### *OnBoard LAN Boot ROM [Disabled]*

Allows you to enable or disable the option ROM in the onboard LAN controller. This item appears only when the Onboard LAN item is set to Enabled. Configuration options: [Disabled] [Enabled]

### Serial Port1 Address [3F8/IRQ4]

Allows you to select the Serial Port1 base address. Configuration options: [Disabled] [3F8/IRQ4] [3E8/IRQ4] [2E8/IRQ3]

### Serial Port2 Address [2F8/IRQ3]

Allows you to select the Serial Port2 base address. Configuration options: [Disabled] [2F8/IRQ3] [3E8/IRQ4] [2E8/IRQ3]

### Parallel Port Address [378]

Allows you to select the Parallel Port base addresses. Configuration options: [Disabled] [378] [278] [3BC]

## **Parallel Port Mode [ECP]**

Allows you to select the Parallel Port mode. When the item **Parallel Port Address** is set to **278**, the Parallel Port Mode options are only Normal and EPP.

Configuration options: [Normal] [Bi-directional] [EPP] [ECP]

### *EPP Version [1.9]*

Allows selection of the Parallel Port EPP version. This item appears only when the **Parallel Port Mode** is set to **EPP**. Configuration options: [1.9] [1.7]

### *ECP Mode DMA Channel [DMA3]*

Allows selection of the Parallel Port ECP DMA channel. This item appears only when the **Parallel Port Mode** is set to **ECP**. Configuration options: [DMA0] [DMA1] [DMA3]

### *Parallel Port IRQ [IRQ7]*

Allows you to select the Parallel Port IRQ. Configuration options: [IRQ5] [IRQ7]

## **Onboard Game/MIDI Port [Disabled]**

Allows you to select the Game Port address or to disable the port. Configuration options: [Disabled] [200/300] [200/330] [208/300] [208/330]

## 2.4.5 PCI PnP

The PCI PnP menu items allow you to change the advanced settings for PCI/PnP devices. The menu includes setting IRQ and DMA channel resources for either PCI/PnP or legacy ISA devices, and setting the memory size block for legacy ISA devices.



Take caution when changing the settings of the PCI PnP menu items. Incorrect field values may cause the system to malfunction.

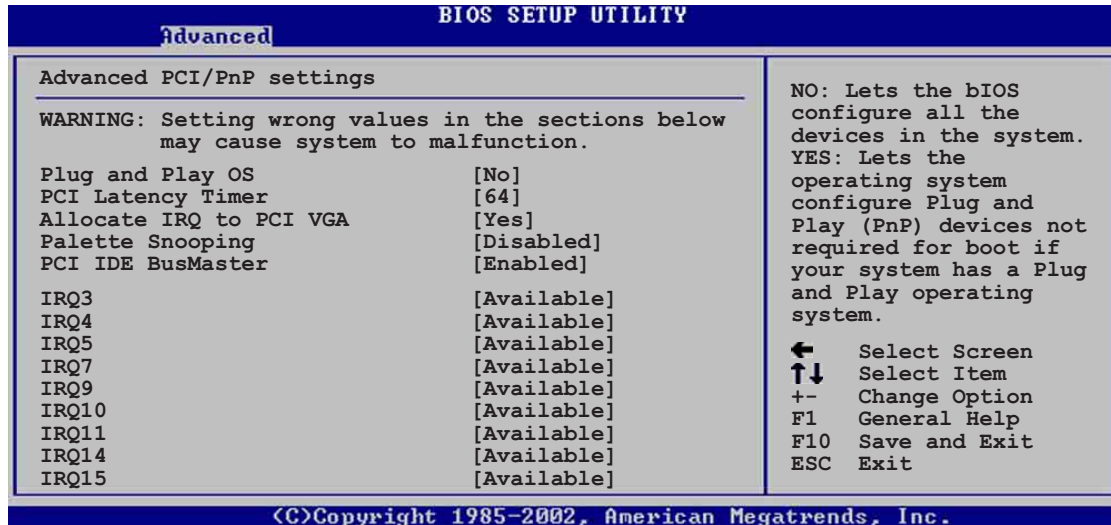

Scroll down to display the rest of the menu items

### Plug and Play O/S [No]

When set to [No], BIOS configures all the devices in the system. When set to [Yes] and if you installed a Plug & Play operating system, the operating system configures the Plug & Play devices not required for boot. Configuration options: [No] [Yes]

### PCI Latency Timer [64]

Allows you to select the value in units of PCI clocks for the PCI device latency timer register. Configuration options: [32] [64] [96] [128] [160] [192] [224] [248]

### Allocate IRQ to PCI VGA [Yes]

When set to [Yes], BIOS assigns an IRQ to PCI VGA card if the card requests for an IRQ. When set to [No], BIOS does not assign an IRQ to the PCI VGA card even if requested. Configuration options: [No] [Yes]

### Pallete Snooping [Disabled]

When set to [Enabled], the pallete snooping feature informs the PCI devices that an ISA graphics device is installed in the system so that the latter can function correctly. Setting to [Disabled] deactivates this feature. Configuration options: [Disabled] [Enabled]

## PCI IDE BusMaster [Enabled]

Allows BIOS to use PCI bus mastering when reading/writing to IDE devices.  
Configuration options: [Disabled] [Enabled]

## IRQ xx [Available]

When set to [Available], the specific IRQ is free for use of PCI/PnP devices. When set to [Reserved], the IRQ is reserved for legacy ISA devices. Configuration options: [Available] [Reserved]

## DMA Channel xx [Available]

When set to [Available], the specific DMA channel is free for use of PCI/PnP devices. When set to [Reserved], the DMA channel is reserved for legacy ISA devices. Configuration options: [Available] [Reserved]

## Reserved Memory Size [Disabled]

Sets the size of memory block reserved for legacy ISA devices. Configuration options: [Disabled] [16K] [32K] [64K]

## 2.4.6 USB Configuration

The items in this menu allows you to change the USB-related features. Select an item then press Enter to display the configuration options.

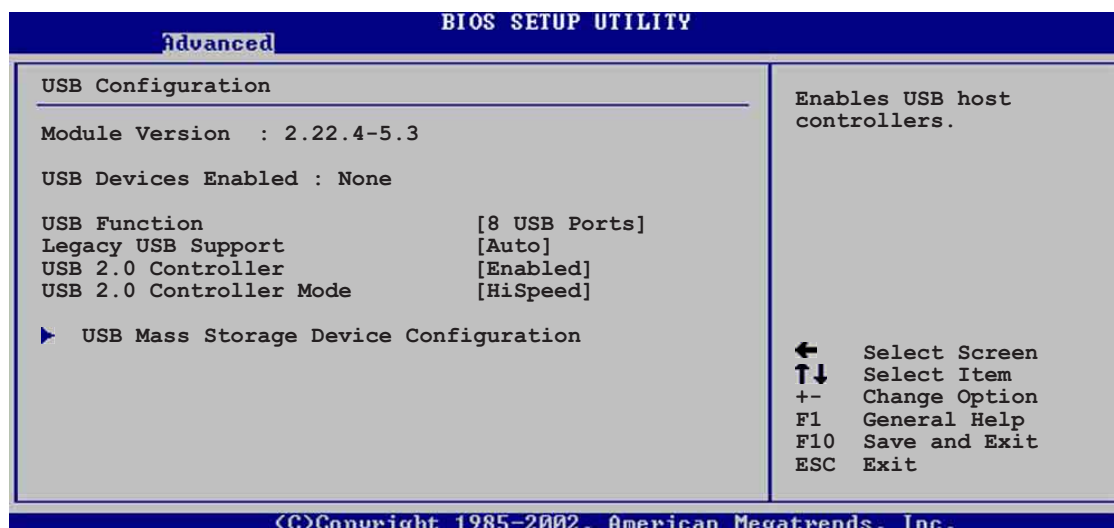

The Module Version and USB Devices Enabled items show the auto-detected values. If no USB device is detected, the item shows None.

## USB Function [8 USB Ports]

Allows you to set the number of USB ports to activate. Before using the USB 2.0 feature, make sure that the USB 2.0 driver is installed. Configuration options: [Disabled] [2 USB Ports] [4 USB Ports] [6 USB Ports] [8 USB Ports]

## Legacy USB Support [Auto]

Allows you to enable or disable support for legacy USB devices. Setting to Auto allows the system to detect the presence of USB devices at startup. If detected, the USB controller legacy mode is enabled. If no USB device is detected, the legacy USB support is disabled. Configuration options: [Disabled] [Enabled] [Auto]

## USB 2.0 Controller [Enabled]

Allows you to enable or disable the USB 2.0 controller. Configuration options: [Disabled] [Enabled]

## USB 2.0 Controller Mode [HiSpeed]

Allows you to configure the USB 2.0 controller in HiSpeed (480 Mbps) or Full Speed (12 Mbps). Configuration options: [HiSpeed] [Full Speed]

## USB Mass Storage Device Configuration

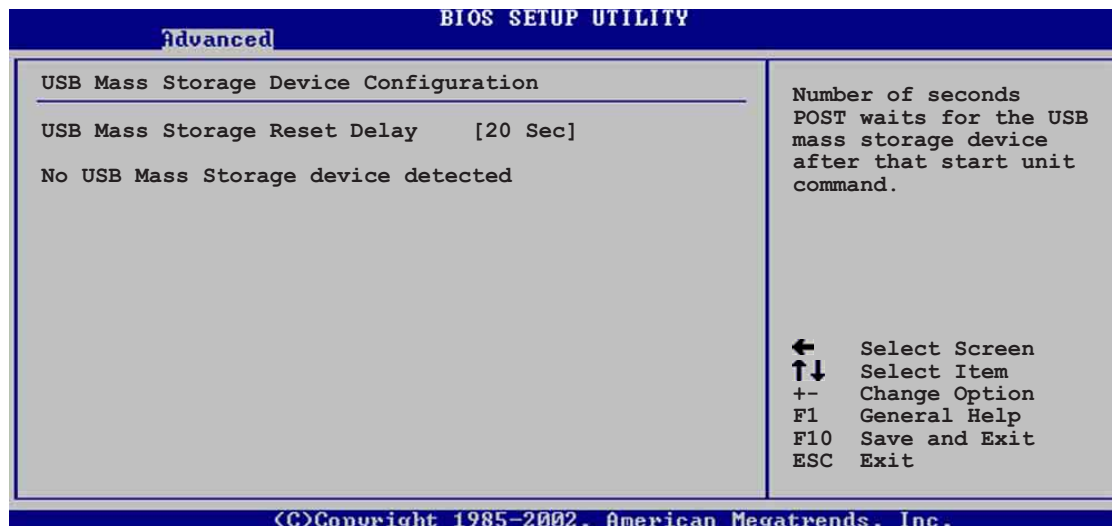

### USB Mass Storage Reset Delay [20 Sec]

Allows you to select the number of seconds POST waits for the USB mass storage device after the start unit command. The message “No USB mass storage device detected” appears if none is installed in the system.

Configuration options: [10 Sec] [20 Sec] [30 Sec] [40 Sec]



The Device items appear only when there are installed USB devices.

## 2.5 Power menu

The Power menu items allow you to change the settings for the Advanced Power Management (APM). Select an item then press Enter to display the configuration options.

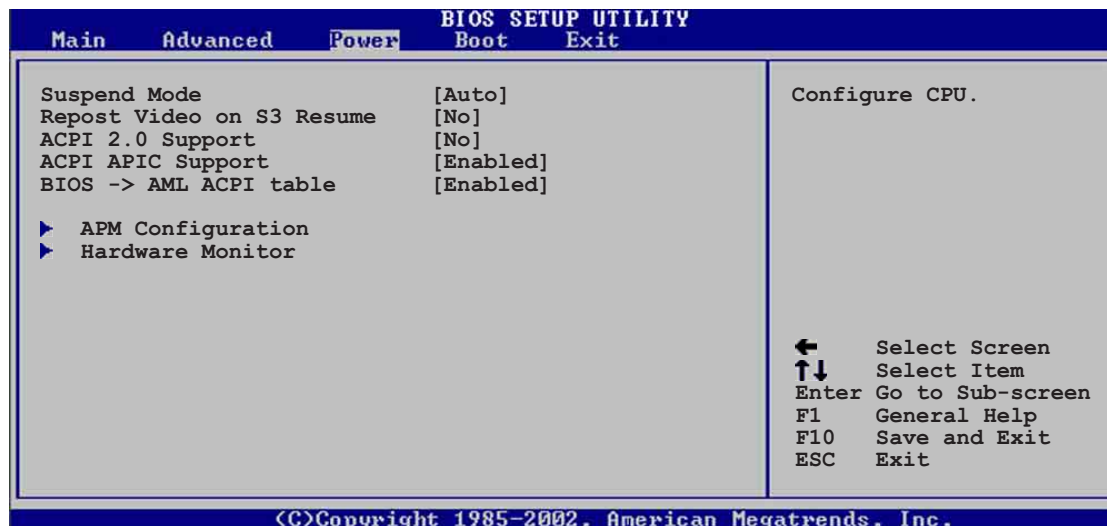

### 2.5.1 Suspend Mode [Auto]

Allows you to select the ACPI state to be used for system suspend. Configuration options: [S1 (POS) Only] [S3 Only] [Auto]

### 2.5.2 Repost Video on S3 Resume [No]

Determines whether to invoke VGA BIOS POST on S3/STR resume. Configuration options: [No] [Yes]

### 2.5.3 ACPI 2.0 Support [No]

Allows you to add more tables for ACPI 2.0 specifications. Configuration options: [No] [Yes]

### 2.5.4 ACPI APIC Support [Enabled]

Allows you to enable or disable the ACPI support in the ASIC. When set to Enabled, the ACPI APIC table pointer is included in the RSDT pointer list. Configuration options: [Disabled] [Enabled]

### 2.5.5 BIOS -> AML ACPI Table [Enabled]

Allows you to enable or disable the inclusion of the BIOS ->AML exchange pointer to (X)RSDT pointer list. Configuration options: [Disabled] [Enabled]

## 2.5.6 APM Configuration

BIOS SETUP UTILITY	
Power	
<b>APM Configuration</b>	
Power Management/APM	[Enabled]
Video Power Down Mode	[Suspend]
Hard Disk Power Down Mode	[Suspend]
Suspend Time Out	[Disabled]
Throttle Slow Clock Ratio	[50%]
System Thermal	[Disabled]
Power Button Mode	[On/Off]
Restore on AC Power Loss	[Power Off]
Power On By RTC Alarm	[Disabled]
Power On By External Modem	[Disabled]
Power On By PCI Devices	[Disabled]
Power On By PS/2 Keyboard	[Disabled]
Power On By PS/2 Mouse	[Disabled]

Enabled or disable APM.

← Select Screen  
↑↓ Select Item  
+- Change Option  
F1 General Help  
F10 Save and Exit  
ESC Exit

©Copyright 1985-2002, American Megatrends, Inc.

### Power Management/APM [Enabled]

Allows you to enable or disable the Advanced Power Management (APM) feature. Configuration options: [Disabled] [Enabled]

### Video Power Down Mode [Suspend]

Allows you to select the video power down mode. Configuration options: [Disabled] [Standby] [Suspend]

### Hard Disk Power Down Mode [Suspend]

Allows you to select the hard disk power down mode. Configuration options: [Disabled] [Standby] [Suspend]

### Standby Time Out [Disabled]

Allows you to select the specified time at which the system goes on standby. Configuration options: [Disabled] [1 Min] [2 Min] [4 Min] [8 Min] [10 Min] [20 Min] [30 Min] [40 Min] [50 Min] [60 Min]

### Suspend Time Out [Disabled]

Allows you to select the specified time at which the system goes on suspend. Configuration options: [Disabled] [1 Min] [2 Min] [4 Min] [8 Min] [10 Min] [20 Min] [30 Min] [40 Min] [50 Min] [60 Min]

### Throttle Slow Clock Ratio [50%]

Allows you to select the duty cycle in throttle mode. Configuration options: [87.5%] [75.0%] [62.5%] [50%] [37.5%] [25%] [12.5%]

### System Thermal [Disabled]

Allows you to enable or disable the system thermal feature to generate a power management event. Configuration options: [Disabled] [Enabled]



### **Power Button Mode [On/Off]**

Allows the system to go into On/Off mode or suspend mode when the power button is pressed. Configuration options: [On/Off] [Suspend]

### **Restore on AC Power Loss [Power Off]**

When set to Power Off, the system goes into off state after an AC power loss. When set to Power On, the system goes on after an AC power loss. When set to Last State, the system goes into either off or on state whatever was the system state before the AC power loss. Configuration options: [Power Off] [Power On] [Last State]

### **Power On By RTC Alarm [Disabled]**

Allows you to enable or disable RTC to generate a wake event. When this item is set to Enabled, the items RTC Alarm Date, RTC Alarm Hour, RTC Alarm Minute, and RTC Alarm Second appear with set values. Configuration options: [Disabled] [Enabled]

### **Power On By External Modem [Disabled]**

This allows either settings of [Enabled] or [Disabled] for powering up the computer when the external modem receives a call while the computer is in Soft-off mode. Configuration options: [Disabled] [Enabled]



---

The computer cannot receive or transmit data until the computer and applications are fully running. Thus, connection cannot be made on the first try. Turning an external modem off and then back on while the computer is off causes an initialization string that turns the system power on.

---

### **Power On By PCI Devices [Disabled]**

When set to [Enabled], this parameter allows you to turn on the system through a PCI LAN or modem card. This feature requires an ATX power supply that provides at least 1A on the +5VSB lead. Configuration options: [Disabled] [Enabled]

### **Power On By PS/2 Mouse [Disabled]**

When set to [Enabled], this parameter allows you to use the PS/2 mouse to turn on the system. This feature requires an ATX power supply that provides at least 1A on the +5VSB lead. Configuration options: [Disabled] [Enabled]

### **Power On By PS/2 Keyboard [Disabled]**

When set to [Enabled], this parameter allows you to use the PS/2 keyboard to turn on the system. This feature requires an ATX power supply that provides at least 1A on the +5VSB lead. Configuration options: [Disabled] [Enabled]

## 2.5.7 Hardware Monitor

BIOS SETUP UTILITY	
Power	
<b>Hardware Monitor</b>	
CPU Temperature	[44°C/111°F]
MB Temperature	[36°C/96.5°F]
Power Temperature	[N/A]
CPU Fan Speed	[2250RPM]
Chassis Fan Speed	[N/A]
Power Fan Speed	[N/A]
VCORE Voltage	[1.550V]
3.3V Voltage	[3.386V]
5V Voltage	[4.890V]
12V Voltage	[11.900V]
CPU temperature	
←	Select Screen
↑↓	Select Item
+ -	Change Option
F1	General Help
F10	Save and Exit
ESC	Exit

(C)Copyright 1985-2002, American Megatrends, Inc.

**CPU Temperature [xxx°C/xxx°F] or [N/A]**

**MB Temperature [xxx°C/xxx°F] or [N/A]**

**Power Temperature [xxx°C/xxx°F] or [N/A]**

The onboard hardware monitor automatically detects and displays the motherboard, CPU, and power supply temperatures. If any of the features is not available to the motherboard, the specific field shows N/A.

**CPU Fan Speed [xxxxRPM] or [N/A]**

**Chassis Fan Speed [xxxxRPM] or [N/A]**

**Power Fan Speed [xxxxRPM] or [N/A]**

The onboard hardware monitor automatically detects and displays the CPU and chassis fan speeds in rotations per minute (RPM). If any of the fans is not connected to the motherboard, the specific field shows N/A.

**VCORE Voltage, +3.3V Voltage, +5V Voltage, +12V Voltage**

The onboard hardware monitor automatically detects the voltage output through the onboard voltage regulators.



If any of the monitored items is out of range, the following error message appears: "Hardware Monitor found an error. Enter Power setup menu for details". You will then be prompted to "Press F1 to continue or DEL to enter SETUP".

## 2.6 Boot menu

The Boot menu items allow you to change the system boot options. Select an item then press Enter to display the sub-menu.

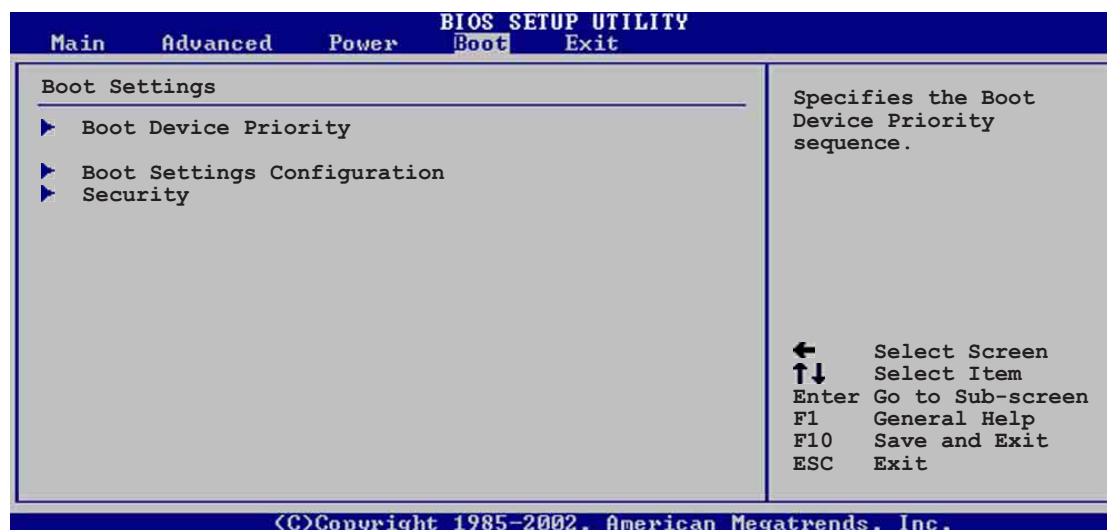

### 2.6.1 Boot Device Priority

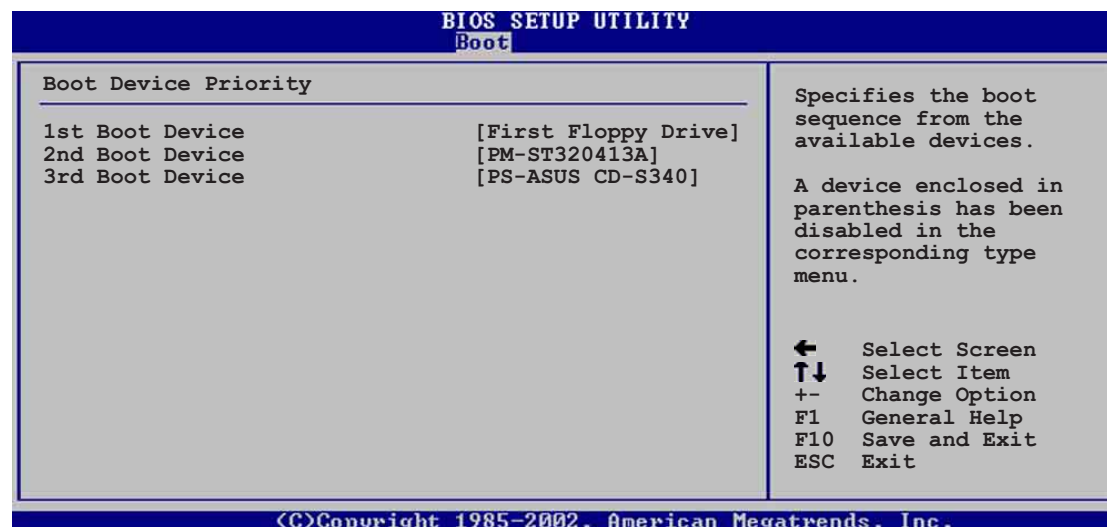

#### 1st ~ xxth Boot Device [1st Floppy Drive]

These items specify the boot device priority sequence from the available devices. The number of device items that appear on the screen depends on the the number of devices installed in the system. Configuration options: [xxxxx Drive] [Disabled]

## 2.6.2 Boot Settings Configuration

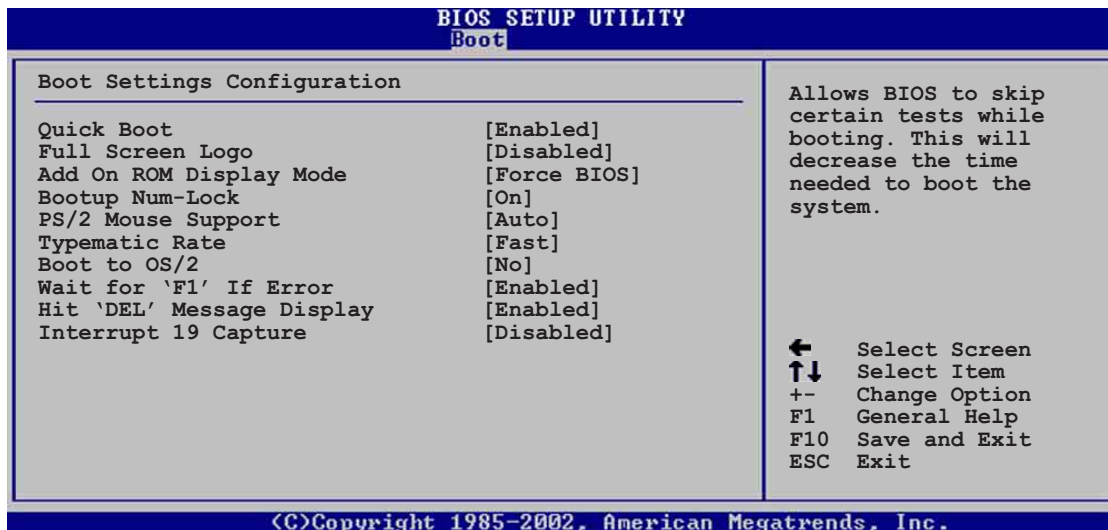

### Quick Boot [Enabled]

Enabling this item allows BIOS to skip some power on self tests (POST) while booting to decrease the time needed to boot the system. When set to [Disabled], BIOS performs all the POST items. Configuration options: [Disabled] [Enabled]

### Full Screen Logo [Disabled]

This item allows you to enable or disable the Full Screen Logo display feature. Make sure that this item is enabled if you want to use the ASUS MyLogo2™ utility. Configuration options: [Disabled] [Enabled]

### Add On ROM Display Mode [Force BIOS]

Sets the display mode for option ROM. Configuration options: [Force BIOS] [Keep Current]

### Bootup Num-Lock [On]

Allows you to select the power-on state for the NumLock. Configuration options: [Off] [On]

### PS/2 Mouse Support [Auto]

Allows you to enable or disable support for PS/2 mouse. Configuration options: [Disabled] [Enabled]

### Typematic Rate [Fast]

Allows you to select the keyboard typematic rate. Configuration options: [Slow] [Fast]

### Boot to OS/2 [No]

Allows you to specify the OS/2 compatibility mode. Configuration options: [No] [Yes]

### Wait for 'F1' If Error [Enabled]

When set to Enabled, the system waits for F1 key to be pressed when error occurs. Configuration options: [Disabled] [Enabled]

### Hit 'DEL' Message Display [Enabled]

When set to Enabled, the system displays the message "Press DEL to run Setup" during POST. Configuration options: [Disabled] [Enabled]

### Interrupt 19 Capture [Disabled]

When set to [Enabled], this function allows the option ROMs to trap Interrupt 19. Configuration options: [Disabled] [Enabled]

## 2.6.3 Security

The Security menu items allow you to change the system security settings. Select an item then press Enter to display the configuration options.

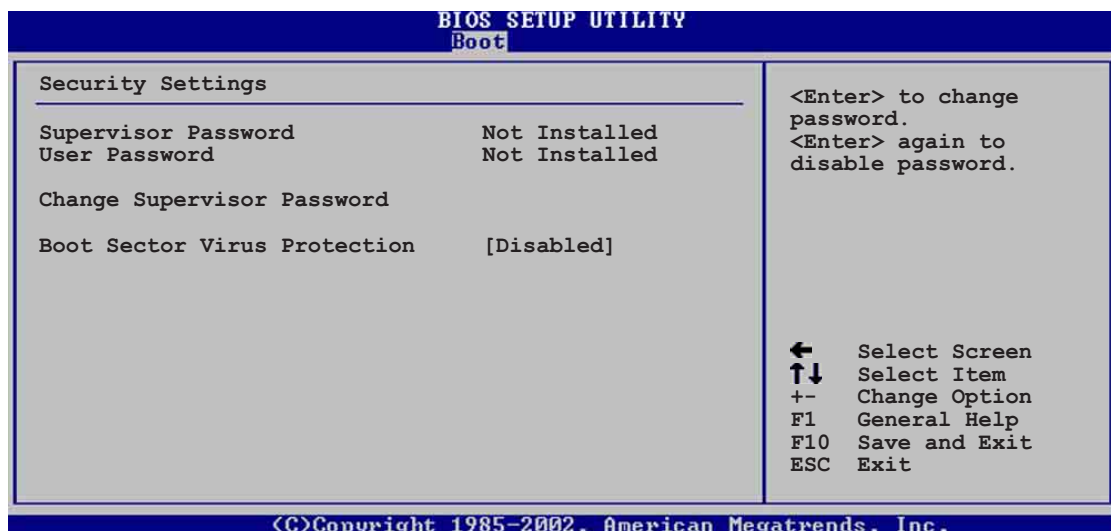

## Change Supervisor Password

Select this item to set or change the supervisor password. The Supervisor Password item on top of the screen shows the default **Not Installed**. After you have set a password, this item shows **Installed**.

To set a Supervisor Password:

1. Select the Change Supervisor Password item and press Enter.
2. On the password box that appears, type a password composed of letters and/or numbers, then press Enter. Your password should have at least six characters.
3. Confirm the password when prompted.  
The message "**Password Installed**" appears after you have successfully set your password.

The Supervisor Password item now shows **Installed**.

To change the supervisor password, follow the same steps as in setting a user password.

To clear the supervisor password, select the Change Supervisor Password then press Enter. The message "**Password Uninstalled**" appears.

After you have set a supervisor password, the other items appear to allow you to change other security settings.

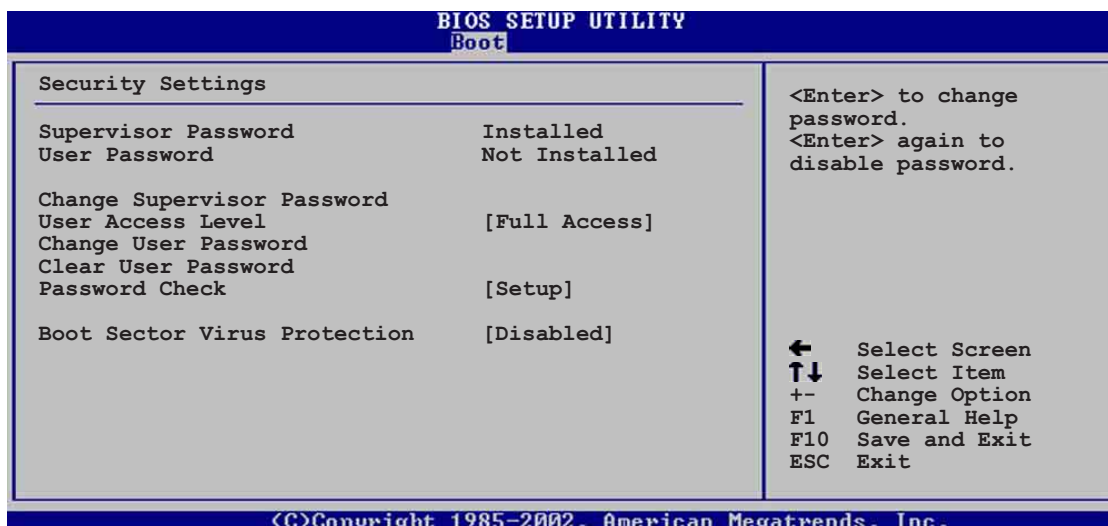

## User Access Level (Full Access]

This item allows you to select the access restriction to the Setup items. Configuration options: [No Access] [View Only] [Limited] [Full Access]

**No Access** prevents user access to the Setup utility.

**View Only** allows access but does not allow change to any field.

**Limited** allows change to only selected fields, such as Date and Time.

**Full Access** allows viewing and changing all the fields in the Setup utility.

## Change User Password

Select this item to set or change the user password. The User Password item on top of the screen shows the default **Not Installed**. After you have set a password, this item shows **Installed**.

To set a User Password:

1. Select the Change User Password item and press Enter.
2. On the password box that appears, type a password composed of letters and/or numbers, then press Enter. Your password should have at least six characters.
3. Confirm the password when prompted.  
The message "Password Installed" appears after you have successfully set your password.

The User Password item now shows **Installed**.

To change the user password, follow the same steps as in setting a user password.

## Clear User Password

Select this item if you wish to clear the user password.

## Password Check [Setup]

When set to [Setup], BIOS checks for user password when accessing the Setup utility. When set to [Always], BIOS checks for user password both when accessing Setup and booting the system. Configuration options: [Setup] [Always]

## Boot Sector Virus Protection [Disabled]

Allows you to enable or disable the boot sector virus protection. Configuration options: [Disabled] [Enabled]

## 2.7 Exit menu

The Exit menu items allow you to load the optimal or failsafe default values for the BIOS items, and save or discard your changes to the BIOS items.

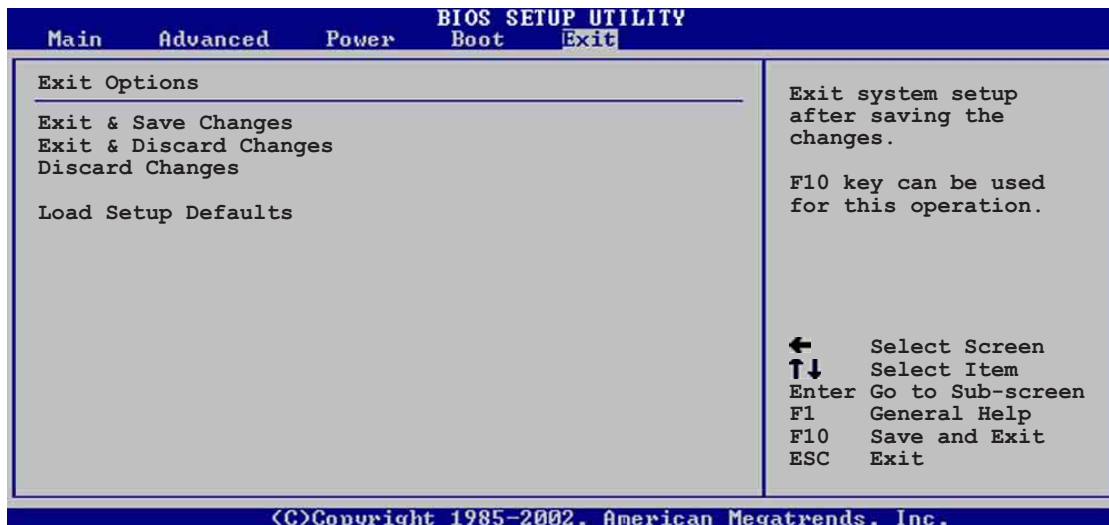

Pressing <Esc> does not immediately exit this menu. Select one of the options from this menu or <F10> from the legend bar to exit.

### Exit & Save Changes

Once you are finished making your selections, choose this option from the Exit menu to ensure the values you selected are saved to the CMOS RAM. The CMOS RAM is sustained by an onboard backup battery and stays on even when the PC is turned off. When you select this option, a confirmation window appears. Select [Yes] to save changes and exit.



If you attempt to exit the Setup program without saving your changes, the program prompts you with a message asking if you want to save your changes before exiting. Pressing <Enter> saves the changes while exiting.

### Exit & Discard Changes

Select this option only if you do not want to save the changes that you made to the Setup program. If you made changes to fields other than system date, system time, and password, the BIOS asks for a confirmation before exiting.

### Discard Changes

This option allows you to discard the selections you made and restore the previously saved values. After selecting this option, a confirmation appears. Select [Yes] to discard any changes and load the previously saved values.

### Load Setup Defaults

This option allows you to load the default values for each of the parameters on the Setup menus. When you select this option or if you press <F5>, a confirmation window appears. Select [Yes] to load default values. Select Exit Saving Changes or make other changes before saving the values to the non-volatile RAM.



# *Chapter 3*

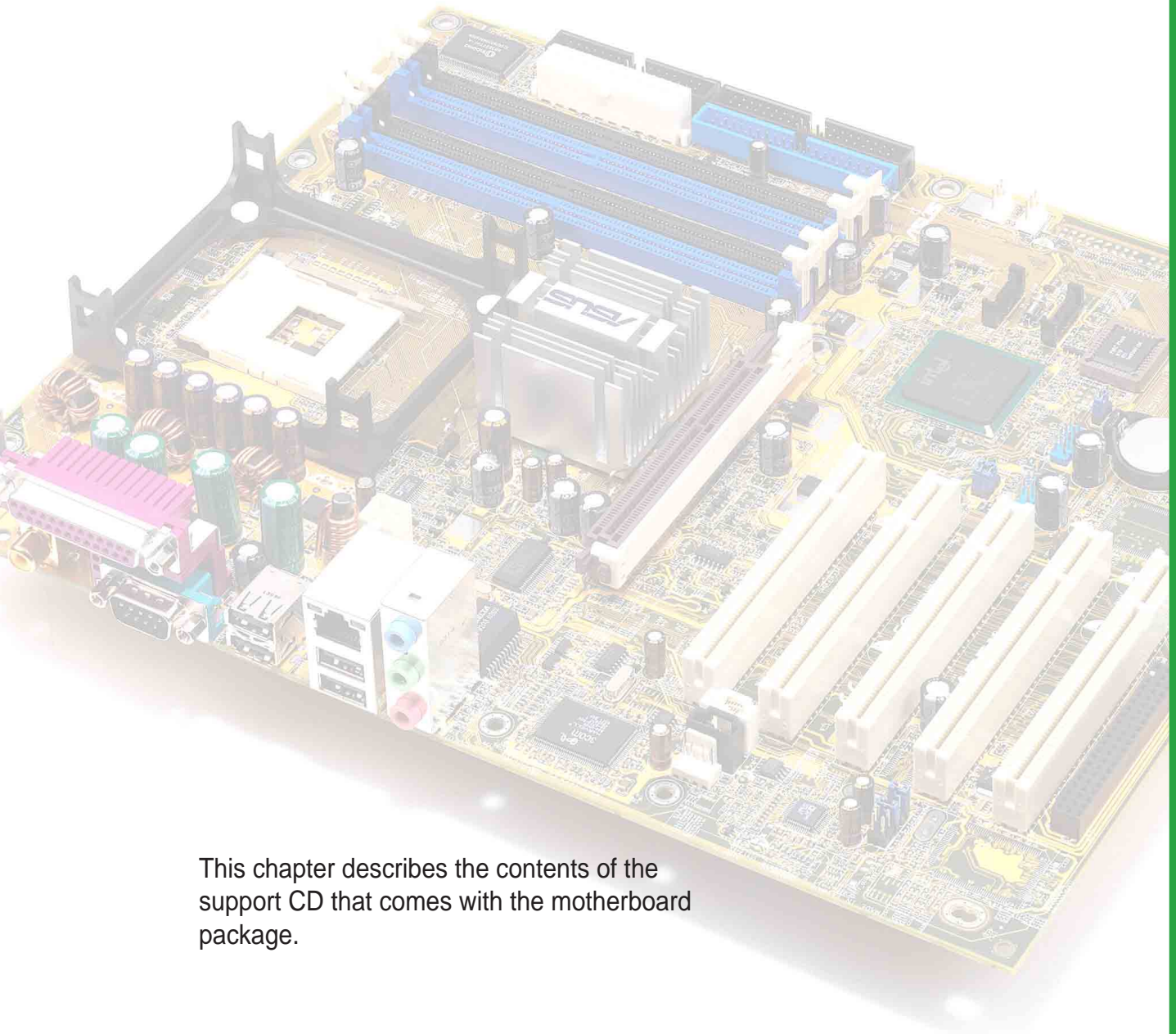

This chapter describes the contents of the support CD that comes with the motherboard package.

## **Software support**

## 3.1 Install an operating system

This motherboard supports Windows 98SE/ME/2000/XP operating system (OS). Always install the latest OS version and corresponding updates so you can maximize the features of your hardware.



---

Because motherboard settings and hardware options vary, use the setup procedures presented in this chapter for general reference only. Refer to your OS documentation for more information.

---

## 3.2 Support CD information

The support CD that came with the motherboard contains useful software and several utility drivers that enhance the motherboard features.



---

The contents of the support CD are subject to change at any time without notice. Visit the ASUS website for updates.

---

### 3.2.1 Running the support CD

To begin using the support CD, simply insert the CD into your CD-ROM drive. The CD automatically displays the **Drivers** menu if Autorun is enabled in your computer.

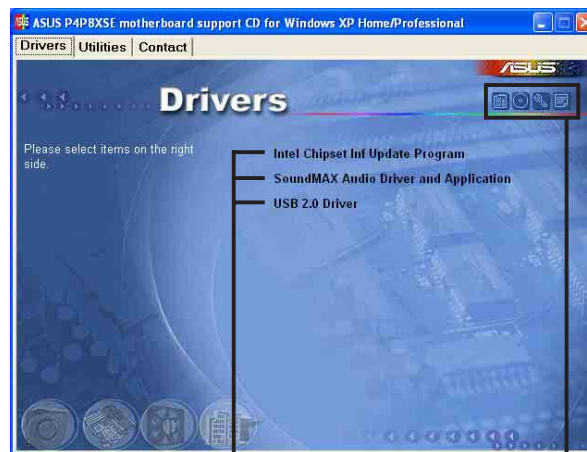

Click an item to install

Click an icon to display more information



---

If **Autorun** is NOT enabled in your computer, browse the contents of the support CD to locate the file **ASSETUP.EXE** from the **BIN** folder. Double-click the **ASSETUP.EXE** to run the CD.

---

## 3.2.2 Drivers menu

The drivers menu shows the available device drivers if the system detects installed devices. Install the necessary drivers to activate the devices.

### Intel® Chipset Inf Update program

This item installs the Intel® Chipset INF Update Program that enables Plug-n-Play INF support for Intel chipset components. This utility installs to the target system the Windows INF files that outline to the operating system how the chipset components will be configured. Refer to the online help or readme file that came with the utility.

### SoundMAX Audio Driver and Application

This item installs the AC'97 audio driver and applications to activate the 6-channel audio feature. After installing the driver and applications, the **SoundMAX Integrated Audio** icon appears on the taskbar. Double-click the icon to display the **SoundMAX Control Panel** from which you can adjust to 6-channel audio settings.



SoundMAX Integrated Audio icon

### USB 2.0 Driver

This item installs the USB 2.0 driver.

### Marvell® Gigabit LOM Driver

This item installs the Marvell Gigabit LAN On Motherboard (LOM) Ethernet driver to support 10/100/1000 Mbps networking.

## 3.2.3 Utilities menu

The Utilities menu shows the applications and other software that the motherboard supports.

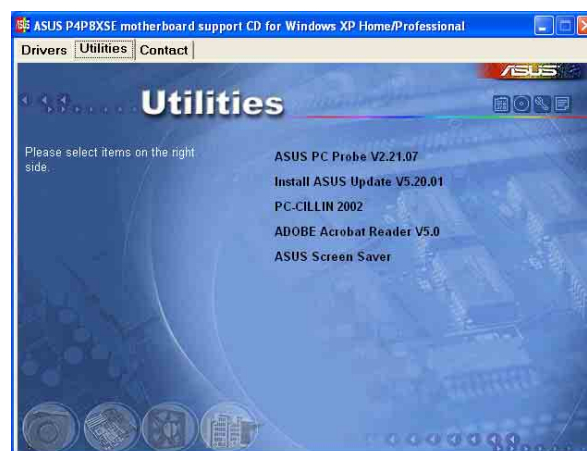

## ASUS PC Probe

This smart utility monitors the fan speed, CPU temperature, and system voltages, and alerts you on any detected problems. This utility helps you keep your computer at a healthy operating condition.

## Install ASUS Update

This program allows you to download the latest version of the BIOS from the ASUS website. Before using the ASUS Update, make sure that you have an Internet connection so you can connect to the ASUS website. Installing ASUS Update also installs ASUS Mylogo™.

## PC-CILLIN 2002

This item installs the PC-cillin 2002 anti-virus program. View the PC-cillin online help for detailed information.

## Adobe Acrobat Reader

This item installs the Adobe Acrobat Reader V5.0. The Acrobat Reader software is for viewing files saved in Portable Document Format (PDF).

## ASUS Screen Saver

This item installs the ASUS screen saver.

## 3.2.4 ASUS Contact Information

Clicking the ASUS Contact Information tab displays as stated. You may also find this information on page viii of this user guide.



## 3.3 AI Net

The motherboard supports the Marvell® Virtual Cable Tester (VCT) Technology. The VCT virtually diagnose and report cable faults using the Time Domain Reflectometry (TDR). With this essential tool, installation and network diagnosis has never been easier. The VCT technology detects and reports open and shorted cables with up to 1 meter of accuracy. It also detects impedance mismatches, pair swaps, pair polarity problems and pair skew problems of up to 64ns.

VCT remarkably reduces networking and support costs complementing a highly manageable and controlled network system. Also, this tool can be incorporated in the network systems software making it ideal for field support as well as development diagnostics.

### Using the Virtual Cable Tester™

To use the the Marvell® Virtual Cable Tester™ on your computer.

1. Click the **Start** button. Select **All Programs->Marvell->Virtual Cable Tester**.
2. From the menu, click **Virtual Cable Tester**. The following screen display appears.

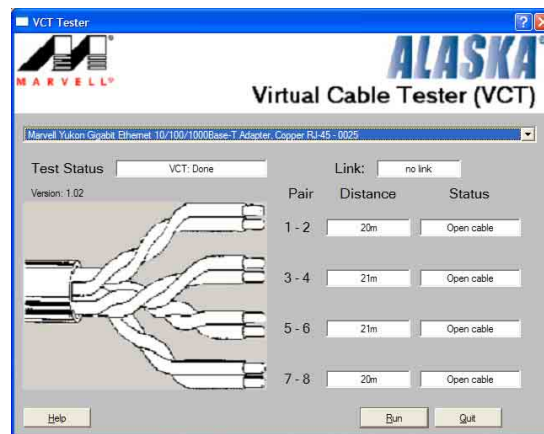

3. Click on **Run** to execute test.



- The Virtual Cable Tester™ (VCT) feature is supported in Windows® XP™ and Windows® 2000™ operating systems only.
- The Virtual Cable Tester™ (VCT) feature works in Gigabit LAN only.
- The **Run** button on the VCT Tester dialogue box is disabled if no problem is detected on the network.

