

ASUS[®] P5S-VM
Super7 microATX Motherboard

USER'S MANUAL

USER'S NOTICE

No part of this manual, including the products and software described in it, may be reproduced, transmitted, transcribed, stored in a retrieval system, or translated into any language in any form or by any means, except documentation kept by the purchaser for backup purposes, without the express written permission of ASUSTeK COMPUTER INC. ("ASUS").

ASUS PROVIDES THIS MANUAL "AS IS" WITHOUT WARRANTY OF ANY KIND, EITHER EXPRESS OR IMPLIED, INCLUDING BUT NOT LIMITED TO THE IMPLIED WARRANTIES OR CONDITIONS OF MERCHANTABILITY OR FITNESS FOR A PARTICULAR PURPOSE. IN NO EVENT SHALL ASUS, ITS DIRECTORS, OFFICERS, EMPLOYEES OR AGENTS BE LIABLE FOR ANY INDIRECT, SPECIAL, INCIDENTAL, OR CONSEQUENTIAL DAMAGES (INCLUDING DAMAGES FOR LOSS OF PROFITS, LOSS OF BUSINESS, LOSS OF USE OR DATA, INTERRUPTION OF BUSINESS AND THE LIKE), EVEN IF ASUS HAS BEEN ADVISED OF THE POSSIBILITY OF SUCH DAMAGES ARISING FROM ANY DEFECT OR ERROR IN THIS MANUAL OR PRODUCT.

Product warranty or service will not be extended if: (1) the product is repaired, modified or altered, unless such repair, modification or alteration is authorized in writing by ASUS; or (2) the serial number of the product is defaced or missing.

Products and corporate names appearing in this manual may or may not be registered trademarks or copyrights of their respective companies, and are used only for identification or explanation and to the owners' benefit, without intent to infringe.

- SiS is a trademark of Silicon Integrated Systems Corp.
- Adobe and Acrobat are registered trademarks of Adobe Systems Incorporated.
- Sound Blaster is a registered trademark of Creative Technology Ltd.
- Intel, LANDesk, and Pentium are registered trademarks of Intel Corporation.
- Symbios is a registered trademark of Symbios Logic Corporation.
- Windows and MS-DOS are registered trademarks of Microsoft Corporation.

The product name and revision number are both printed on the product itself. Manual revisions are released for each product design represented by the digit before and after the period of the manual revision number. Manual updates are represented by the third digit in the manual revision number.

For previous or updated manuals, BIOS, drivers, or product release information, contact ASUS at <http://www.asus.com.tw> or through any of the means indicated on the following page.

SPECIFICATIONS AND INFORMATION CONTAINED IN THIS MANUAL ARE FURNISHED FOR INFORMATIONAL USE ONLY, AND ARE SUBJECT TO CHANGE AT ANY TIME WITHOUT NOTICE, AND SHOULD NOT BE CONSTRUED AS A COMMITMENT BY ASUS. ASUS ASSUMES NO RESPONSIBILITY OR LIABILITY FOR ANY ERRORS OR INACCURACIES THAT MAY APPEAR IN THIS MANUAL, INCLUDING THE PRODUCTS AND SOFTWARE DESCRIBED IN IT.

Copyright © 1999 ASUSTeK COMPUTER INC. All Rights Reserved.

Product Name:	ASUS P5S-VM
Manual Revision:	1.02 E342
Release Date:	March 1999

ASUS CONTACT INFORMATION

ASUSTeK COMPUTER INC. (Asia-Pacific)

Marketing

Address: 150 Li-Te Road, Peitou, Taipei, Taiwan 112
Telephone: +886-2-2894-3447
Fax: +886-2-2894-3449
Email: info@asus.com.tw

Technical Support

Tel (English): +886-2-2894-3447 ext. 706
Tel (Chinese): +886-2-2894-3447 ext. 701
Fax: +886-2-2895-9254
Email: tsd@asus.com.tw
Newsgroup: news2.asus.com.tw
WWW: www.asus.com.tw
FTP: ftp.asus.com.tw/pub/ASUS

ASUS COMPUTER INTERNATIONAL (America)

Marketing

Address: 6737 Mowry Avenue, Mowry Business Center, Building 2
Newark, CA 94560, USA
Fax: +1-510-608-4555
Email: info-usa@asus.com.tw

Technical Support

Fax: +1-510-608-4555
BBS: +1-510-739-3774
Email: tsd-usa@asus.com.tw
WWW: www.asus.com
FTP: ftp.asus.com.tw/pub/ASUS

ASUS COMPUTER GmbH (Europe)

Marketing

Address: Harkort Str. 25, 40880 Ratingen, BRD, Germany
Telephone: 49-2102-445011
Fax: 49-2102-442066
Email: sales@asuscom.de

Technical Support

Hotline: 49-2102-499712
BBS: 49-2102-448690
Email: tsd@asuscom.de
WWW: www.asuscom.de
FTP: ftp.asuscom.de/pub/ASUSCOM

CONTENTS

I. INTRODUCTION	7
How this Manual is Organized	7
Item Checklist	7
II. FEATURES	8
ASUS P5S-VM Motherboard	8
Parts of the ASUS P5S-VM Motherboard	11
III. HARDWARE SETUP	12
ASUS P5S-VM Motherboard Layout	12
Hardware Setup Steps	14
1. Motherboard Settings	14
Jumpers	14
Compatible Cyrix CPU Identification	18
2. System Memory (DIMM)	20
DIMM Memory Installation Procedures:	21
3. Central Processing Unit (CPU)	22
4. Expansion Cards	23
Expansion Card Installation Procedure:	23
Assigning IRQs for Expansion Cards	23
Assigning DMA Channels for ISA Cards	24
ISA Cards and Hardware Monitor	24
5. External Connectors	25
Power Connection Procedures	35
Flash Memory Writer Utility	36
IV. BIOS SETUP	36
Main Menu	36
Managing and Updating Your Motherboard's BIOS	38
6. BIOS Setup	39
Load Defaults	40
Standard CMOS Setup	40
Details of Standard CMOS Setup	40
BIOS Features Setup	43
Details of BIOS Features Setup	43
Chipset Features Setup	46
Details of Chipset Features Setup	46
Power Management Setup	49
Details of Power Management Setup	49
PNP and PCI Setup	52
Details of PNP and PCI Setup	52

CONTENTS

Load BIOS Defaults	54
Load Setup Defaults	54
Supervisor Password and User Password	55
IDE HDD Auto Detection	56
Save & Exit Setup	57
Exit Without Saving	57
V. SOFTWARE SETUP	61
Operating Systems	61
Windows 98 First Time Installation	61
P5S-VM Support CD	62
Installation Menu	62
LDCM Local Setup	63
LDCM Administrator Setup	65
ASUS PC Probe Setup	66
Adobe Acrobat Reader	67
Install IDE Bus Master Driver	68
Install Video Driver	69
Install Audio Driver	70
Install PC-Cillin	71
Uninstalling Programs	72
VI. SOFTWARE REFERENCE	73
Intel LANDesk Client Manager	73
ASUS PC Probe	79
SiS 530 Display Properties	82
Creative Multimedia Decks	84
Desktop Management Interface (DMI)	91
VII. APPENDIX	95
ASUS PCI-L101 Fast Ethernet Card	95
Features	96
Software Driver Support	96
Question and Answer	96

FCC & DOC COMPLIANCE

Federal Communications Commission Statement

This device complies with FCC Rules Part 15. Operation is subject to the following two conditions:

- This device may not cause harmful interference, and
- This device must accept any interference received, including interference that may cause undesired operation.

This equipment has been tested and found to comply with the limits for a Class B digital device, pursuant to Part 15 of the FCC Rules. These limits are designed to provide reasonable protection against harmful interference in a residential installation. This equipment generates, uses and can radiate radio frequency energy and, if not installed and used in accordance with manufacturer's instructions, may cause harmful interference to radio communications. However, there is no guarantee that interference will not occur in a particular installation. If this equipment does cause harmful interference to radio or television reception, which can be determined by turning the equipment off and on, the user is encouraged to try to correct the interference by one or more of the following measures:

- Re-orient or relocate the receiving antenna.
- Increase the separation between the equipment and receiver.
- Connect the equipment to an outlet on a circuit different from that to which the receiver is connected.
- Consult the dealer or an experienced radio/TV technician for help.

WARNING! The use of shielded cables for connection of the monitor to the graphics card is required to assure compliance with FCC regulations. Changes or modifications to this unit not expressly approved by the party responsible for compliance could void the user's authority to operate this equipment.

Canadian Department of Communications Statement

This digital apparatus does not exceed the Class B limits for radio noise emissions from digital apparatus set out in the Radio Interference Regulations of the Canadian Department of Communications.

I. INTRODUCTION

How this Manual is Organized

I. Introduction	Manual information and checklist
II. Features	Information on motherboard features
III. Installation	Instructions on motherboard/jumper setup
IV. BIOS Setup	Instructions on BIOS software setup
V. Software Setup	Information on the included support software
VI. Software Reference	References for the included support software
VII. Appendix	Optional items and general reference

Item Checklist

Check that your package is complete. If you discover damaged or missing items, contact your retailer.

- (1) ASUS Motherboard
- (1) IDE ribbon cable for master and slave drives
- (1) COM2 cable with bracket
- (1) Ribbon cable for (1) 5.25" and (2) 3.5" floppy disk drives
- (1) Bag of spare jumpers
- (1) Support CD with drivers and utilities
- (1) Motherboard User's manual

- ASUS IrDA-compliant module (optional)
- ASUS PCI-L101 Wake-On-LAN 10/100 ethernet card (optional)

II. FEATURES

ASUS P5S-VM Motherboard

The ASUS P5S-VM is carefully designed for the demanding PC user who wants advanced features in a small package.

Specifications

- **SiS AGPset:** SiS (Silicon Integrated Systems Corp.) 530 AGPset with support for a 100MHz Front Side Bus (FSB), Accelerated Graphics Port (AGP), all current Socket 7 processors and with integrated Super AGP 2D/3D VGA controller for high performance hardware 2D/3D VGA acceleration.
- **Multi-Processor/Multi-Speed Support:** AMD K6[®]-2/266 & faster, AMD K6[®]/166 & faster, AMD K5[™]/100–133, IBM[®]/Cyrix[®] 6x86MX[™]/M II[™] (PR166 & faster), IBM[®]/Cyrix[®] 6x86-PR166+ (Rev 2.7 or later), Intel Pentium[®] 100–233MHz (P55C-MMX[™], P54C/P54CS).
- **PC100 Memory Support:** Equipped with three DIMM sockets to support Intel PC100-compliant SDRAMs (8, 16, 32, 64, 128, or 256MB) up to 768MB. These new SDRAMs are necessary to meet the enhanced 95MHz/100MHz bus speed requirement.
- **AGP VGA Onboard:** Features built-in 2D/3D AGP VGA (on AGPset) with optional 8MB SDRAM as local graphics memory.
- **Peripheral Wake Up:** Supports modem wake up, keyboard wake up, and LAN card wake up functions from sleep or soft-off mode.
- **Onboard Audio (optional):** Provides Creative Labs, Inc.'s ES1373 PCI audio chipset with 3D surround and positioning capability. Includes complete online software guide.
- **Audio CODEC (optional):** Features an 18-bit stereo, full duplex, audio CODEC that conforms to AC'97 analog component specifications.
- **PC Health Monitoring:** Provides an easier and convenient way to examine and manage system status information, such as system voltages, temperatures, and fan status through the onboard PCIset (South Bridge) and the bundled LDCM from Intel or PC Probe from ASUS.
- **Ultra DMA/66 BM IDE:** Comes with an onboard PCI Bus Master IDE controller with two connectors that support four IDE devices in two channels, supports Ultra DMA/66, Ultra DMA/33, PIO Modes 3/4 and Bus Master IDE DMA Mode 2, and supports Enhanced IDE devices, such as Tape Backup, CD-ROM, CD-R, CD-RW, and LS-120 drives.
- **Wake-On-LAN:** Supports Wake-On-LAN activity through an optional ASUS PCI-L101 10/100 Fast Ethernet PCI card (see **APPENDIX**) or a similar ethernet card.
- **Multi-I/O:** Provides two high-speed UART compatible serial ports and one parallel port with EPP and ECP capabilities. UART2 can also be directed from COM2 (with SIR) to the Infrared Module for wireless connections.
- **Multi-Cache:** Features 512KB/1MB (when chip is available) pipelined-burst SRAM/L2 memory cache and integrated Tag RAM to make using the 100MHz bus speed possible.
- **USB:** Supports the Universal Serial Bus standard through the onboard connectors for multi-device connections.
- **IrDA:** Supports an optional infrared port module for a wireless interface.

II. FEATURES

Special Features

- **Enhanced ACPI and Anti-Boot Virus BIOS:** Features a programmable BIOS, offering enhanced ACPI for Windows 98 compatibility, built-in firmware-based virus protection through Trend ChipAway Virus codes, and autodetection of most devices for virtually automatic setup.
- **Desktop Management Interface (DMI):** Supports DMI through BIOS, which allows hardware to communicate within a standard protocol creating a higher level of compatibility. (Requires DMI-enabled components.) (See **SOFTWARE REFERENCE**.)
- **Easy Installation:** Incorporates BIOS that supports autodetection of hard disk drives, PS/2 mouse, and Plug and Play devices to make the setup of hard disk drives, expansion cards, and other devices virtually automatic.
- **PC'98 Compliant:** Both the BIOS and hardware levels of this motherboard meet PC'98 compliancy. The new PC'98 requirements for systems and components are based on the following high-level goals: Support for Plug and Play compatibility and power management for configuring and managing all system components, and 32-bit device drivers and installation procedures for Windows 95/98/NT.
- **Symbios SCSI BIOS:** Supports optional ASUS SCSI controller cards or other Symbios SCSI cards through the onboard SYMBIOS firmware.

Performance Features

- **Concurrent PCI:** Concurrent PCI allows multiple PCI transfers from PCI master busses to the memory and processor.
- **High-Speed Data Transfer Interface:** This motherboard with its chipset and support for Ultra DMA/66 doubles the Ultra DMA/33 burst transfer rate to 66.6MB/s. Ultra DMA/66 is backward compatible with both DMA/33 and DMA and with existing DMA devices and systems so there is no need to upgrade current EIDE/IDE drives and host systems. (Ultra DMA/66 requires a 40-pin 80-conductor cable to be enabled and/or for Ultra DMA Mode 4.)
- **SDRAM Optimized Performance:** Supports the new generation memory — Synchronous Dynamic Random Access Memory (SDRAM) — which increases the data transfer rate to 800MB/s max using PC100-compliant SDRAM.

Intelligent Features (with optional PC Health Monitoring only)

- **Fan Status Monitoring and Alarm:** To prevent system overheat and system damage, the CPU fan and system fans are monitored for RPM and failure. Each fan can be set for its normal RPM range and alarm thresholds.
- **Temperature Monitoring and Alert:** To avoid any failures triggered by extremely high temperature, there is a heat sensor under the CPU to make sure your system is operating at a safe heat level.

II. FEATURES

- **Auto Fan Off:** The system fans will power off automatically **even in sleep mode**. This function reduces both energy consumption *and* **system noise**, and is an important feature in implementing silent PC systems.
- **Dual Function Power Button (requires ATX power supply):** Pushing the power button for less than 4 seconds when the system is in the working state places the system into one of two states: sleep mode or soft-off mode, depending on the BIOS setting (see *Power Management Setup* under **BIOS SETUP**). When the power button is pressed for more than 4 seconds, the system enters the soft-off mode regardless of the BIOS setting.
- **Keyboard Power Up:** Keyboard Power Up can be enabled or disabled to allow the computer to be powered on by pressing the keyboard's spacebar.
- **Voltage Monitoring and Alert:** System voltage levels are monitored to ensure stable current to critical motherboard components. Voltage specifications are more critical for future processors, so monitoring is necessary to ensure proper system configuration and management.
- **System Resources Alert:** Today's operating systems, such as Windows 95/98/NT and OS/2, require much more memory and hard drive space to present enormous user interfaces and run large applications. The system resource monitor will warn the user before the system resources are used up to prevent possible application crashes. Suggestions on managing the user's limited resources more efficiently are provided.
- **CPU Slow Down:** When CPU fans or system fans malfunction, the system will deactivate the CPU Clock line to decrease CPU utilization to the speed upon detection of system overheat. This will prevent CPU damage from system overheat. The CPU utilization will restore normal operations when temperature falls below a safe level.
- **Remote Ring On (requires external modem):** This feature allows a computer to be turned on remotely through an external modem. With this benefit on hand, any user can access vital information from their computer from anywhere in the world!
- **Message LED (requires ACPI-supported OS):** Turbo LEDs now act as information providers. Through the way a particular LED illuminates, the user can determine the stage the computer is in. A simple glimpse provides useful information to the user.

II. FEATURES

Parts of the ASUS P5S-VM Motherboard

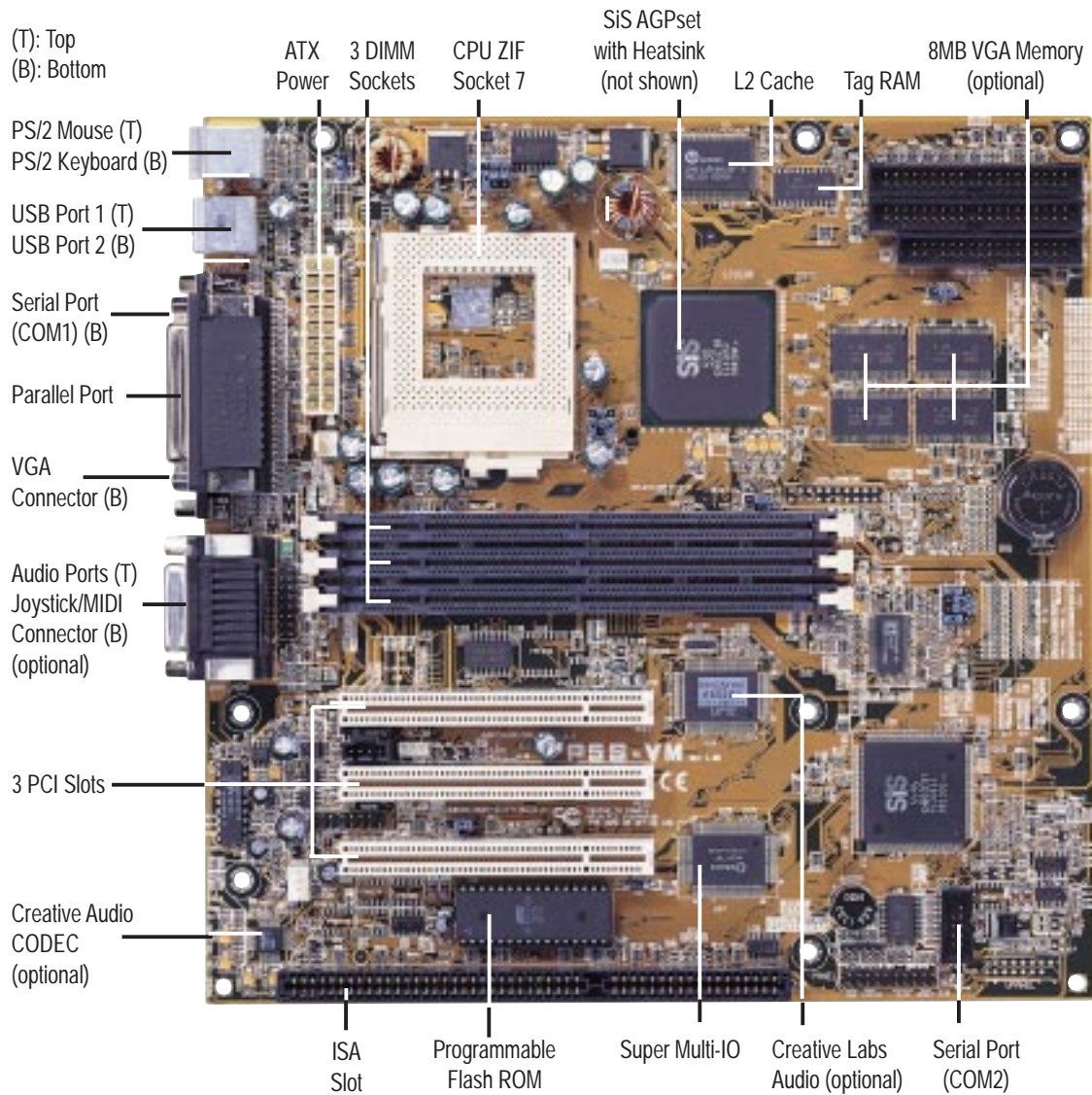

II. FEATURES
Motherboard Parts

III. HARDWARE SETUP

ASUS P5S-VM Motherboard Layout

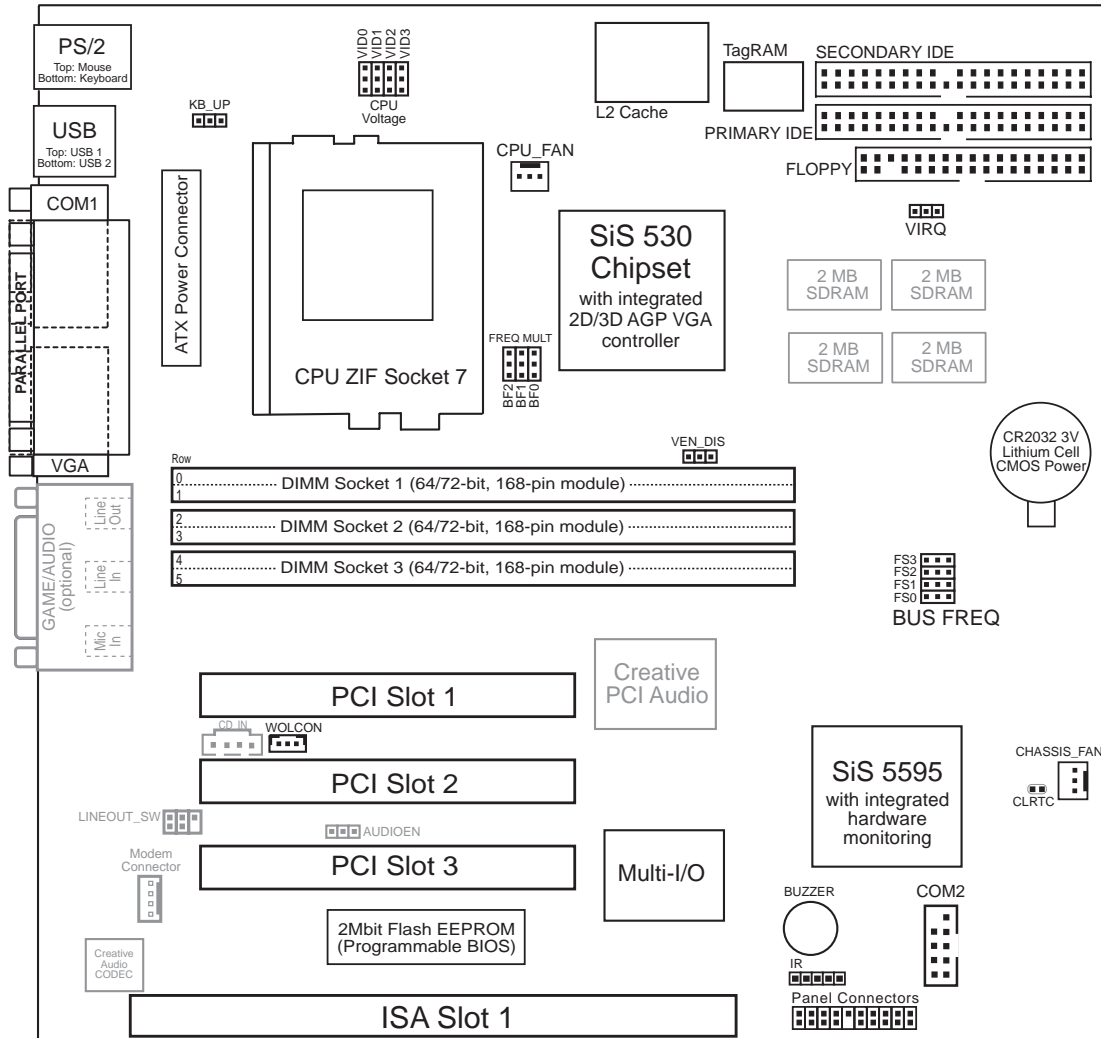

Dimmed components are optional.

III. HW SETUP
Motherboard Layout

III. HARDWARE SETUP

Motherboard Settings

- | | | |
|---------------------------|-------|---|
| 1) VIRQ | p. 14 | VGA Interrupt Selection (Enable/Disable) |
| 2) VEN_DIS | p. 14 | VGA Setting (Enable/Disable) |
| 3) LINEOUT_SW | p. 15 | Audio Line Out Setting (With amplifier/Without amplifier) |
| 4) AUDIOEN | p. 15 | Audio Setting (Enable/Disable) |
| 5) KB_UP | p. 15 | Keyboard Power (Wake) Up (Enable/Disable) |
| 6) FS0, FS1, FS2, FS3 | p. 16 | CPU External (BUS) Frequency Selection |
| 7) BF0, BF1, BF2 | p. 16 | CPU to BUS Frequency Multiple |
| 8) VID0, VID1, VID2, VID3 | p. 18 | Voltage Regulator Output Selection |

Expansion Slots/Sockets

- | | | |
|----------------------|-------|---------------------------------------|
| 1) DIMM Sockets | p. 20 | 168-Pin DIMM Memory Expansion Sockets |
| 2) CPU ZIF Socket 7 | p. 22 | Central Processing Unit (CPU) Socket |
| 3) SLOT 1 | p. 23 | 16-bit ISA Bus Expansion Slots* |
| 4) PCI 1, PCI2, PCI3 | p. 23 | 32-bit PCI Bus Expansion Slots** |

Connectors

- | | | |
|------------------------|-------|---|
| 1) PS2KBMS | p. 25 | PS/2 Keyboard Connector (6-pin Female) |
| 2) PS2MBMS | p. 25 | PS/2 Mouse Connector (6-pin Female) |
| 3) PARALLEL | p. 26 | Parallel (Printer) Port Connector (26-1 pins) |
| 4) COM1 | p. 26 | Serial Port COM1 (9-pin Male) |
| 5) COM2 | p. 26 | Serial Port COM2 (10-1 pins) |
| 6) VGA | p. 27 | Monitor (VGA) Outout Connector (15-Female) |
| 7) FLOPPY | p. 27 | Floppy Drive Connector (34-1 pins) |
| 8) GAME_AUDIO | p. 27 | Audio Port Connectors (Three 1/8" Female) |
| 9) GAME_AUDIO | p. 28 | Joystick/MidiConnector (15-pin Female) |
| 10) USB | p. 28 | Universal Serial BUS Ports 1 & 2 (Two 4-pin Female) |
| 11) PRIMARY/SECOND.IDE | p. 29 | Primary/Secondary IDE Connector (40-1 pins) |
| 12) ATX | p. 30 | ATX Motherboard Power Connector (20 pins) |
| 13) IR | p. 30 | IrDA/Fast IR-compliant Infrared Module Connector (5 pins) |
| 14) PWR (PANEL) | p. 31 | ATX Power Switch/Soft Power Switch Lead (2 pins) |
| 15) IDELED (PANEL) | p. 31 | IDE Activity LED Lead (2 pins) |
| 16) PLED (PANEL) | p. 31 | System Power LED Lead (3 pins) |
| 17) RESET (PANEL) | p. 31 | Reset Switch Lead (2 pins) |
| 18) MLED (PANEL) | p. 31 | System Message LED (2 pins) |
| 19) KEYLOCK (PANEL) | p. 31 | Keyboard Lock Switch Lead (2 pins) |
| 20) SPEAKER (PANEL) | p. 31 | Speaker Output Connector (4 pins) |
| 21) WOLCON | p. 32 | Wake-on-LAN Activity Connector (3 pins) |
| 22) CD_IN | p. 32 | Stereo Audio In Connector (4 pins) |
| 23) MODEM | p. 32 | MODEM Card Voice In Connector (4 pins) |
| 24) FAN | p. 34 | CPU/Chassis Cooling Fan Connectors (Two 3 pins) |

*The onboard hardware monitor uses the address 290H-297H so legacy ISA cards must not use this address or else conflicts will occur.

III. HARDWARE SETUP

Hardware Setup Steps

1. Check Motherboard Settings
2. Install Memory Modules
3. Install the Central Processing Unit (CPU)
4. Install Expansion Cards
5. Connect Ribbon Cables, Cabinet Wires, and Power Supply
6. Setup the BIOS Software

1. Motherboard Settings

This section explains how to change your motherboard's function settings through the use of switches and/or jumpers.

WARNING! Computer motherboards, baseboards and components, such as SCSI cards, contain very delicate Integrated Circuit (IC) chips. To protect them against damage from static electricity, you should follow some precautions whenever you work on your computer.

1. Unplug your computer when working on the inside.
2. Use a grounded wrist strap before handling computer components. If you do not have one, touch both of your hands to a safely grounded object or to a metal object, such as the power supply case.
3. Hold components by the edges and try not to touch the IC chips, leads or connectors, or other components.
4. Place components on a grounded antistatic pad or on the bag that came with the component whenever the components are separated from the system.

Jumpers

1. VGA Interrupt Selection (VIRQ) / 2. VGA Setting (VEN_DIS)

VIRQ allows you to set the VGA interrupt method. The default enables the chipset's internal interrupt routing. VEN_DIS allows you to enable or disable the onboard VGA. Disable the onboard VGA if you are using a VGA card on the expansion slot.

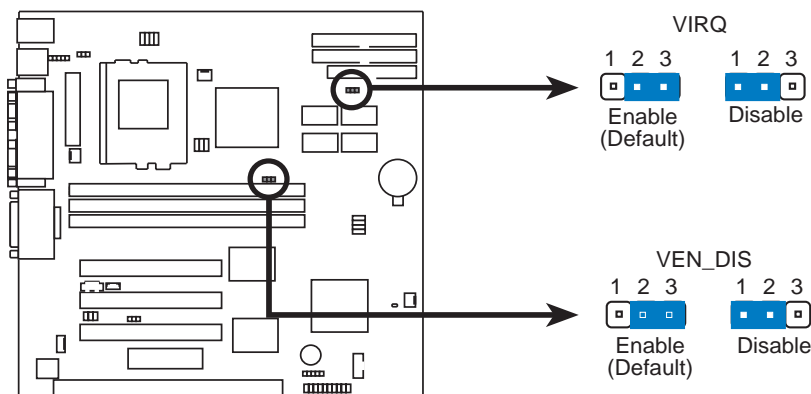

P5S-VM VGA Settings

III. HARDWARE SETUP

3. Audio Line Out Setting (LINEOUT_SW) / 4. Audio Setting (AUDIOEN)

LINEOUT_SW allows you to set the audio line out settings. The default allows a stereo amplified connection to external speakers through the Line Out jack of the optional GAME/AUDIO connector. Sound quality is better using the **Without amplifier** setting and an external amplifier or powered speakers. AUDIOEN allows you to enable or disable the onboard audio. Disable the onboard audio if you are using an audio card on the expansion slot. (These settings are available only on motherboards with the onboard audio option.)

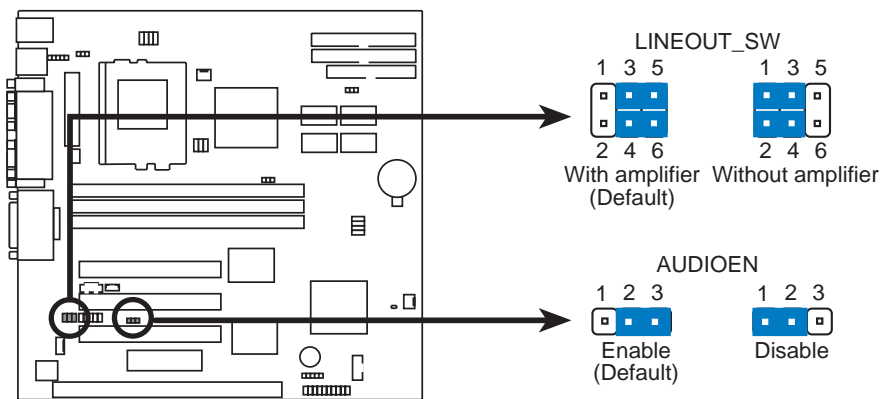

P5S-VM Audio Settings

5. Keyboard Power (Wake) Up (KB_UP)

This allows you to disable or enable the keyboard power or wake up function. Set to *Enable* if you want to use your keyboard (by pressing <Spacebar>) to power or wake up your computer. The default is set to *Disable* because not all computers have the appropriate ATX power supply.

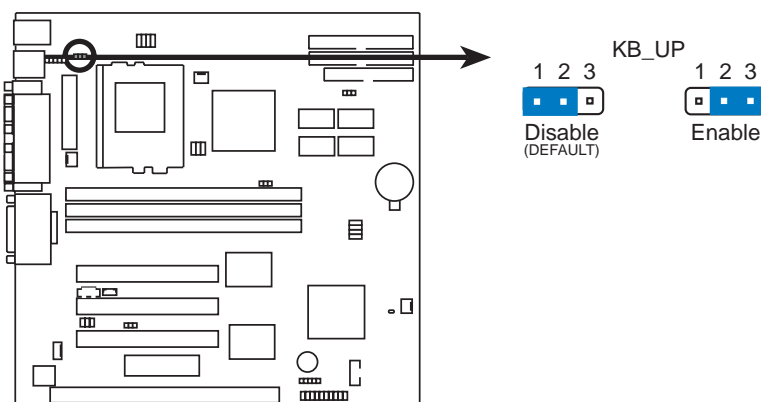

P5S-VM Keyboard Power (Wake) Up

III. HARDWARE SETUP

6. CPU External (BUS) Frequency Selection (FS0, FS1, FS2, FS3)

These jumpers tell the clock generator what frequency to send to the CPU, chipset, and AGP. These allow the selection of the CPU's *External* frequency (or *BUS Clock*). The BUS Clock times the BUS Ratio equals the CPU's *Internal* frequency (the advertised CPU speed).

7. CPU to BUS Frequency Multiple (BF0, BF1, BF2)

These jumpers set the frequency ratio between the *Internal* frequency of the CPU and the *External* frequency (called the *BUS Clock*) within the CPU. These must be set together with the jumpers for *CPU External (BUS) Frequency Selection*.

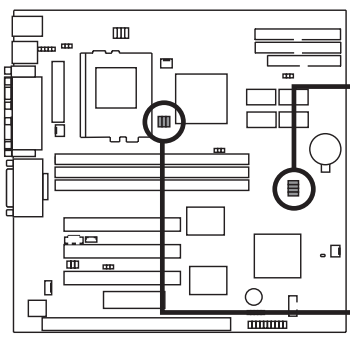

P5S-VM CPU Settings

Match the **Mult.** (Multiple) column of the table on the opposite page to these CPU types:

CPU A: AMD-K6-2, AMD-K6
CPU B: Intel Pentium P54C, AMD-K5
CPU C: Intel Pentium P55C, IBM/Cyrix 6x86MX, IBM/Cyrix M II
CPU D: IBM/Cyrix 6x86, IBM/Cyrix 6x86L

FS3	1 2 3	1 2 3	1 2 3	1 2 3	1 2 3	1 2 3	1 2 3
FS2	1 2 3	1 2 3	1 2 3	1 2 3	1 2 3	1 2 3	1 2 3
FS1	1 2 3	1 2 3	1 2 3	1 2 3	1 2 3	1 2 3	1 2 3
FS0	1 2 3	1 2 3	1 2 3	1 2 3	1 2 3	1 2 3	1 2 3
HOST	133MHz	124MHz	112MHz	100MHz	95MHz	83.3MHz	75MHz
SDRAM	133MHz	124MHz	112MHz	100MHz	95MHz	83.3MHz	75MHz
PCI	33MHz	31MHz	37.3MHz	33.3MHz	31.7MHz	33MHz	30MHz

FS3	1 2 3	1 2 3	1 2 3	1 2 3	1 2 3	1 2 3	1 2 3
FS2	1 2 3	1 2 3	1 2 3	1 2 3	1 2 3	1 2 3	1 2 3
FS1	1 2 3	1 2 3	1 2 3	1 2 3	1 2 3	1 2 3	1 2 3
FS0	1 2 3	1 2 3	1 2 3	1 2 3	1 2 3	1 2 3	1 2 3
HOST	133MHz	124MHz	112MHz	100MHz	100MHz	95MHz	66.7MHz
SDRAM	88.9MHz	82.7MHz	74.7MHz	75MHz	66.7MHz	63.3MHz	100MHz
PCI	33MHz	31MHz	37.3MHz	30MHz	33.3MHz	31.7MHz	33.3MHz

CPU Bus Frequency

BF→	2	1	0	2	1	0	2	1	0	2	1	0	2	1	0	2	1	0
3	1	0	0	1	0	0	1	0	0	1	0	0	1	0	0	1	0	0
2	0	1	0	0	1	0	0	1	0	0	1	0	0	1	0	0	1	0
1	0	0	1	0	0	1	0	0	1	0	0	1	0	0	1	0	0	1

CPU A → 3.5x(7/2) 2.0x(2/1) 2.5x(5/2) 3.0x(3/1) 4.0x(4/1) 4.5x(9/2) 5.0x(5/1) 5.5x(11/2)
 CPU B → 1.5x(3/2) 2.0x(2/1) 2.5x(5/2) 3.0x(3/1) — — — —
 CPU C → 3.5x(7/2) 2.0x(2/1) 2.5x(5/2) 3.0x(3/1) — — — —
 CPU D → 3.0x(3/1) 2.0x(2/1) 1.0x(1/1) — — — —

CPU Core : BUS Frequency Multiple

WARNING! Frequencies above 100MHz exceed the specifications for the on-board chipset and are not guaranteed to be stable. The table on the following page is for general reference purposes only. Always refer to the instructions included with your CPU when possible.

III. HARDWARE SETUP

Set the jumpers by the Internal speed of your CPU as follows:

CPU Model	Freq.	Mult.	(BUS Freq.)				(Freq. Mult.)			
			BUS F.	FS3	FS2	FS1	FS0	BF2	BF1	BF0
AMD-K6-2/450	450MHz	A-4.5x	100MHz	[1-2]	[2-3]	[2-3]	[1-2]	[2-3]	[2-3]	[2-3]
AMD-K6-2/400	400MHz	A-4.0x	100MHz	[1-2]	[2-3]	[2-3]	[1-2]	[2-3]	[1-2]	[2-3]
AMD-K6-2/380	380MHz	A-4.0x	95MHz	[2-3]	[1-2]	[2-3]	[2-3]	[2-3]	[1-2]	[2-3]
AMD-K6-2/366	366MHz	A-5.5x	66MHz	[2-3]	[2-3]	[2-3]	[1-2]	[2-3]	[1-2]	[1-2]
AMD-K6-2/350	350MHz	A-3.5x	100MHz	[1-2]	[2-3]	[2-3]	[1-2]	[----]	[1-2]	[1-2]
AMD-K6-2/333	333MHz	A-3.5x	95MHz	[2-3]	[1-2]	[1-2]	[1-2]	[----]	[1-2]	[1-2]
AMD-K6-2/300	300MHz	A-3.0x	100MHz	[1-2]	[2-3]	[2-3]	[1-2]	[----]	[2-3]	[1-2]
AMD-K6-2/266	266MHz	A-4.0x	66MHz	[2-3]	[2-3]	[2-3]	[1-2]	[2-3]	[1-2]	[2-3]
AMD-K6/300	300MHz	A-4.5x	66MHz	[2-3]	[2-3]	[2-3]	[1-2]	[2-3]	[2-3]	[2-3]
AMD-K6/266	266MHz	A-4.0x	66MHz	[2-3]	[2-3]	[2-3]	[1-2]	[2-3]	[1-2]	[2-3]
AMD-K6/233	233MHz	A-3.5x	66MHz	[2-3]	[2-3]	[2-3]	[1-2]	[----]	[1-2]	[1-2]
AMD-K6/200	200MHz	A-3.0x	66MHz	[2-3]	[2-3]	[2-3]	[1-2]	[----]	[2-3]	[1-2]
AMD-K6/166	166MHz	A-2.5x	66MHz	[2-3]	[2-3]	[2-3]	[1-2]	[----]	[2-3]	[2-3]
AMD-K5/133	100MHz	B-1.5x	66MHz	[2-3]	[2-3]	[2-3]	[1-2]	[----]	[1-2]	[1-2]
AMD-K5/100	100MHz	B-1.5x	66MHz	[2-3]	[2-3]	[2-3]	[1-2]	[----]	[1-2]	[1-2]
Intel Pentium P54C	166MHz	B-2.5x	66MHz	[2-3]	[2-3]	[2-3]	[1-2]	[----]	[2-3]	[2-3]
Intel Pentium P54C	133MHz	B-2.0x	66MHz	[2-3]	[2-3]	[2-3]	[1-2]	[----]	[1-2]	[2-3]
Intel Pentium P54C	100MHz	B-1.5x	66MHz	[2-3]	[2-3]	[2-3]	[1-2]	[----]	[1-2]	[1-2]
Intel Pentium P55C	233MHz	C-3.5x	66MHz	[2-3]	[2-3]	[2-3]	[1-2]	[----]	[1-2]	[1-2]
Intel Pentium P55C	200MHz	C-3.0x	66MHz	[2-3]	[2-3]	[2-3]	[1-2]	[----]	[2-3]	[1-2]
Intel Pentium P55C	166MHz	C-2.5x	66MHz	[2-3]	[2-3]	[2-3]	[1-2]	[----]	[2-3]	[2-3]
IBM/Cyrix M II-PR333	333MHz	C-3.0x	83MHz	[2-3]	[1-2]	[2-3]	[1-2]	[----]	[2-3]	[1-2]
IBM/Cyrix M II-PR300	300MHz	C-3.0x	75MHz	[2-3]	[2-3]	[1-2]	[1-2]	[----]	[2-3]	[1-2]
IBM/Cyrix M II-PR300	300MHz	C-3.5x	66MHz	[2-3]	[2-3]	[2-3]	[1-2]	[----]	[1-2]	[1-2]
IBM/Cyrix 6x86MX-PR233	200MHz	C-3.0x	66MHz	[2-3]	[2-3]	[2-3]	[1-2]	[----]	[2-3]	[1-2]
IBM/Cyrix 6x86MX-PR200	166MHz	C-2.5x	66MHz	[2-3]	[2-3]	[2-3]	[1-2]	[----]	[2-3]	[2-3]
IBM/Cyrix 6x86-PR166+*	133MHz	D-2.0x	66MHz	[2-3]	[2-3]	[2-3]	[1-2]	[----]	[1-2]	[2-3]
IBM/Cyrix 6x86L-PR166+*	133MHz	D-2.0x	66MHz	[2-3]	[2-3]	[2-3]	[1-2]	[----]	[1-2]	[2-3]

*The only IBM or Cyrix 6x86(L) (or M1) that is supported on this motherboard is revision 2.7 or later (see next page).

III. HARDWARE SETUP

Compatible Cyrix CPU Identification

The only Cyrix 6x86-PR166+ CPU that is supported on this motherboard must be Revision 2.7 or later. Look on the underside of the CPU for the serial number. The number should read G8DC6620A or later.

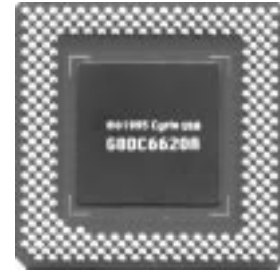

8. Voltage Regulator Output Selection (VID0, VID1, VID2, VID3)

These jumpers set the V_{CORE} voltage supplied to the CPU. Switching regulators allow some jumper settings to be the same for two voltages of different power planes.

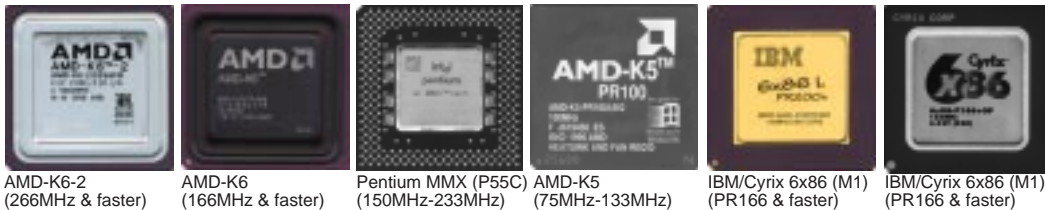

AMD-K6-2
(266MHz & faster)

AMD-K6
(166MHz & faster)

Pentium MMX (P55C)
(150MHz-233MHz)

AMD-K5
(75MHz-133MHz)

IBM/Cyrix 6x86 (M1)
(PR166 & faster)

IBM/Cyrix 6x86 (M1)
(PR166 & faster)

WARNING! Because CPU designs change rapidly, the table below is only intended as a simple guideline and thus may not be true for your CPU. Always refer to the CPU documentation for your CPU's voltage and then set the appropriate VID jumpers according to the **CPU Vcore Voltage Selection** illustration.

Manufacturer	CPU Type	Single Plane	Dual Plane	VID0	VID1	VID2	VID3
AMD (.25micron)	K6-2-450	----	2.3V(Dual)	[1-2]	[1-2]	[2-3]	[2-3]
AMD (.25micron)	K6-2-266,300,333, 366,380,400 K6-233,266,300	----	2.2V(Dual)	[2-3]	[1-2]	[2-3]	[2-3]
AMD	K5	3.5V(VRE)	----	[1-2]	[1-2]	[1-2]	[1-2]
IBM/Cyrix	6x86	3.5V(VRE)	----	[1-2]	[1-2]	[1-2]	[1-2]
IDT	WinChip2	3.5V(VRE)	----	[1-2]	[1-2]	[1-2]	[1-2]
Intel	P54C/P54CS	3.5V(VRE)	----	[1-2]	[1-2]	[1-2]	[1-2]
AMD	K5	3.4V(STD)	----	[2-3]	[1-2]	[1-2]	[1-2]
Intel	P54C/P54CS	3.4V(STD)	---	[2-3]	[1-2]	[1-2]	[1-2]
AMD (.35micron)	K6-233	----	3.2V(Dual)	[2-3]	[2-3]	[1-2]	[1-2]
AMD (.35micron)	K6-166,200	----	2.9V(Dual)	[1-2]	[2-3]	[2-3]	[1-2]
IBM/Cyrix	6x86MX	----	2.9V(Dual)	[1-2]	[2-3]	[2-3]	[1-2]
Intel	P55C-MMX	----	2.8V(Dual)	[2-3]	[2-3]	[2-3]	[1-2]

III. HARDWARE SETUP

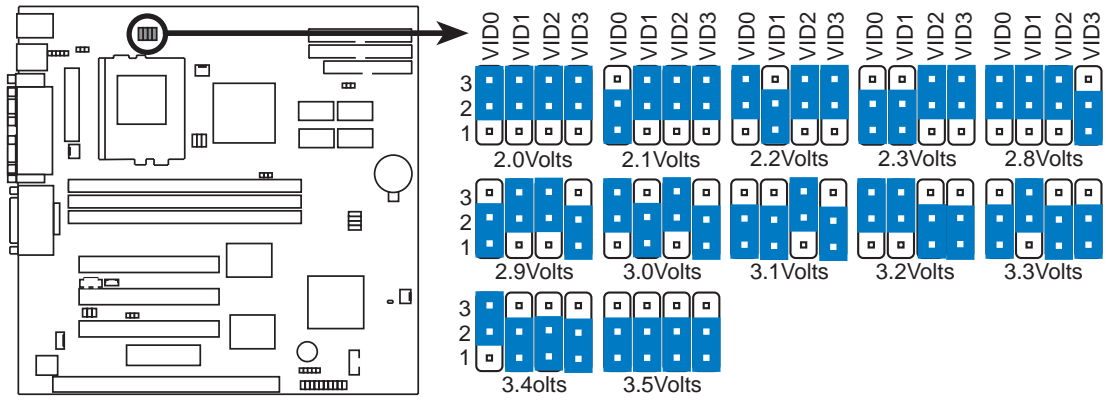

P5S-VM CPU Vcore Voltage Selection

III. HARDWARE SETUP

2. System Memory (DIMM)

This motherboard uses only Dual Inline Memory Modules (DIMMs). Sockets are available for **3.3Volt** (power level) unbuffered Synchronous Dynamic Random Access Memory (SDRAM) of either 8, 16, 32, 64, 128MB, or 256MB to form a memory size between 8MB and 768MB. One side (with memory chips) of the DIMM takes up one row on the motherboard.

To utilize the chipset's Error Checking and Correction (ECC) feature, you must use a DIMM module with 9 chips per side (standard 8 chips/side + 1 ECC chip) and make the proper settings through "Chipset Features Setup" in BIOS setup.

Memory speed setup is recommended through *SDRAM Configuration* under "Chipset Features Setup" in BIOS setup.

IMPORTANT (see **Notes** below)

- **To make using bus speeds $\geq 95\text{MHz}$ possible, SDRAMs used must be compatible with the current Intel PC100 SDRAM specification..**

Install memory in any combination as follows:

DIMM Location	168-pin DIMM		Total Memory
DIMM1 (Rows 0&1)	SDRAM 8, 16, 32, 64, 128, 256MB	x1	
DIMM2 (Rows 2&3)	SDRAM 8, 16, 32, 64, 128, 256MB	x1	
DIMM3 (Rows 4&5)	SDRAM 8, 16, 32, 64, 128, 256MB	x1	
	Total System Memory (Max 768MB)	=	

NOTES

- **DIMMs that have more than 18 chips are not supported on this motherboard.**
- **To make using bus speeds $\geq 95\text{MHz}$ possible, use only PC100-compliant DIMMs.** Most systems will not even boot if non-compliant modules are used because of the strict timing issues involved with speeds $\geq 95\text{MHz}$.
- Two possible memory chips are supported: SDRAM with and without ECC. **ECC is not supported when using bus speeds $\geq 83\text{MHz}$.**
- SDRAM chips are generally thinner and have higher pin density than EDO (Extended Data Output) chips.
- BIOS shows SDRAM memory on bootup screen.
- 8 chips/side modules do not support ECC, only 9 chips/side modules support ECC.
- Single-sided DIMMs are available in 16, 32, 64, 128MB; double-sided in 32, 64, 128, 256MB.

III. HARDWARE SETUP

DIMM Memory Installation Procedures:

Insert the module(s) as shown. Because the number of pins are different on either side of the breaks, the module will only fit in the orientation as shown. DRAM SIMM modules have the same pin contacts on both sides. SDRAM DIMMs have different pin contacts on each side and therefore have a higher pin density.

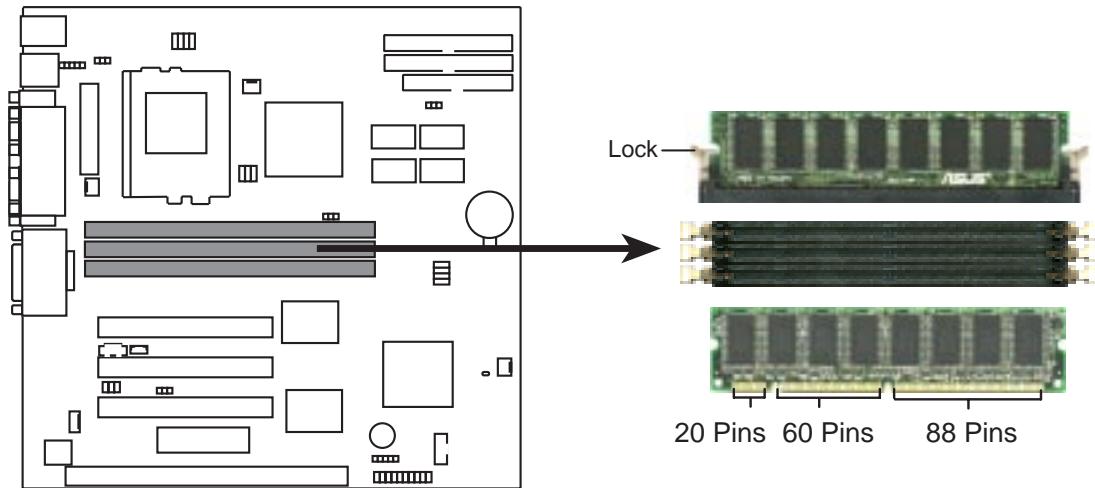

P5S-VM 168-Pin DIMM Sockets

The DIMMs must be 3.3Volt unbuffered SDRAMs. To determine the DIMM type, check the notches on the DIMMs (see figure below).

168-Pin DIMM Notch Key Definitions (3.3V)

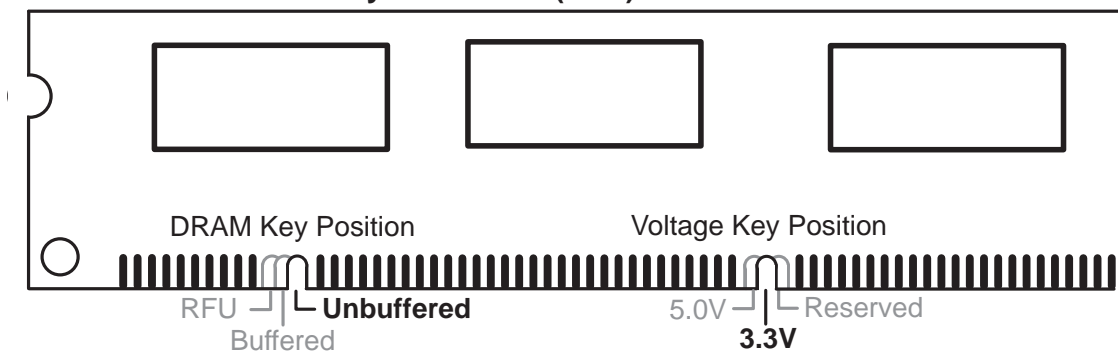

The notches on the DIMM will shift between left, center, or right to identify the type and also to prevent the wrong type from being inserted into the DIMM slot on the motherboard. You must tell your retailer the correct DIMM type before purchasing. This motherboard supports four clock signals.

III. HARDWARE SETUP

3. Central Processing Unit (CPU)

The motherboard provides a 321-pin ZIF Socket 7 that is backwards compatible with ZIF Socket 5 processors. The CPU that came with the motherboard should have a fan attached to it to prevent overheating. If this is not the case then purchase a fan before you turn on your system.

WARNING! Without a fan circulating air on the CPU, the CPU can overheat and cause damage to both the CPU and the motherboard.

To install a CPU, first turn off your system and remove its cover. Locate the ZIF socket and open it by first pulling the lever sideways away from the socket then upwards to a 90-degree right angle. Insert the CPU with the correct orientation as shown. Use the notched corner of the CPU with the white dot as your guide. The white dot should point towards the end the of the lever. Notice that there is a blank area where one hole is missing from that corner of the square array of pin holes and a “1” printed on the motherboard next to that corner. Because the CPU has a corner pin for three of the four corners, the CPU will only fit in the one orientation as shown. The picture is for reference only; you should have a CPU fan that will cover the face of the CPU. With the added weight of the CPU fan, no force is required to insert the CPU. Once completely inserted, hold down on the fan and close the socket’s lever.

IMPORTANT: You must set jumpers for “CPU to BUS Frequency Ratio” and jumpers for “BUS Frequency Selection” depending on the CPU that you install.

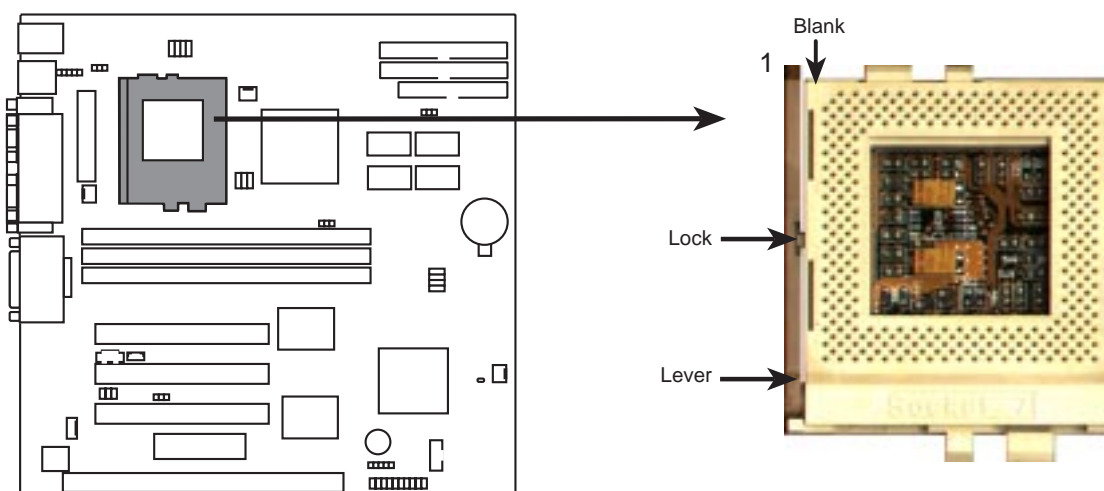

P5S-VM ZIF Socket 7

III. HARDWARE SETUP

4. Expansion Cards

WARNING! Make sure that you unplug your power supply when adding or removing expansion cards or other system components. Failure to do so may cause severe damage to both your motherboard and expansion cards.

Expansion Card Installation Procedure:

1. Read your expansion card documentation on any hardware and software settings that may be required to setup your specific card.
2. Set any necessary jumpers on your expansion card.
3. Remove your computer system's cover.
4. Remove the bracket on the slot you intend to use.
Keep the bracket for possible future use.
5. Carefully align the card's connectors and press firmly.
6. Secure the card on the slot with the screw you removed in step 4.
7. Replace the computer system's cover.
8. Setup the BIOS if necessary
(such as "IRQ xx Used By ISA: Yes" in PNP AND PCI SETUP)
9. Install the necessary software drivers for your expansion card.

Assigning IRQs for Expansion Cards

Some expansion cards need to use an IRQ to operate. Generally an IRQ must be exclusively assigned to one use. In a standard design there are 16 IRQs available but most of them are already in use by parts of the system which leaves 6 free for expansion cards.

Both ISA and PCI expansion cards may need to use IRQs. System IRQs are available to cards installed in the ISA expansion bus first, and any remaining IRQs are then used by PCI cards. Currently, there are two types of ISA cards.

The original ISA expansion card design, now referred to as "Legacy" ISA cards, requires that you configure the card's jumpers manually and then install it in any available slot on the ISA bus. You may use Microsoft's Diagnostic (MSD.EXE) utility included in the Windows directory to see a map of your used and free IRQs. For Windows 95 users, the "Control Panel" icon in "My Computer," contains a "System" icon, which gives you a "Device Manager" tab. Double clicking on a specific device give you "Resources" tab which shows the Interrupt number and address. Make sure that no two devices use the same IRQs or your computer will experience problems when those two devices are in use at the same time.

III. HARDWARE SETUP

To simplify this process, this motherboard complies with the Plug and Play (PNP) specification which was developed to allow automatic system configuration whenever a PNP-compliant card is added to the system. For PNP cards, IRQs are assigned automatically from those available.

If the system has both Legacy and PNP ISA cards installed, IRQs are assigned to PNP cards from those not used by Legacy cards. The PCI and PNP configuration of the BIOS setup utility can be used to indicate which IRQs are being used by Legacy cards. For older Legacy cards that do not work with the BIOS, you can contact your vendor for an ISA Configuration Utility.

An IRQ number is automatically assigned to PCI expansion cards after those used by Legacy and PNP ISA cards. In the PCI bus design, the BIOS automatically assigns an IRQ to a PCI slot that has a card in it that requires an IRQ. To install a PCI card, you need to set something called the INT (interrupt) assignment. Since all the PCI slots on this motherboard use an INTA#, be sure that the jumpers on your PCI cards are set to INT A.

Assigning DMA Channels for ISA Cards

Some ISA cards, both legacy and PnP, may also need to use a DMA (Direct Memory Access) channel. DMA assignments for this motherboard are handled the same way as the IRQ assignment process described earlier. You can select a DMA channel in the PCI and PnP configuration section of the BIOS Setup utility.

IMPORTANT: To avoid conflicts, reserve the necessary IRQs and DMAs for legacy ISA cards (under PNP AND PCI SETUP of the BIOS SOFTWARE, choose *Yes* in *IRQ xx Used By ISA* and *DMA x Used By ISA* for those IRQs and DMAs you want to reserve).

ISA Cards and Hardware Monitor

The onboard hardware monitor uses the address 290H-297H, so legacy ISA cards must not use this address or else conflicts will occur.

III. HARDWARE SETUP

5. External Connectors

WARNING! Some pins are used for connectors or power sources. These are clearly separated from jumpers in the motherboard layout. Placing jumper caps over these will cause damage to your motherboard.

IMPORTANT: Ribbon cables should always be connected with the red stripe on the Pin 1 side of the connector. The four corners of the connectors are labeled on the motherboard. Pin 1 is the side closest to the power connector on hard drives and some floppy drives. IDE ribbon cable must be less than 18in. (46cm), with the second drive connector no more than 6in. (15cm) from the first connector.

1. PS/2 Keyboard Connector (6-pin Female)

This connection is for a standard keyboard using an PS/2 plug (mini DIN). **This connector will not allow standard AT size (large DIN) keyboard plugs. You may use a DIN to mini DIN adapter on standard AT keyboards.**

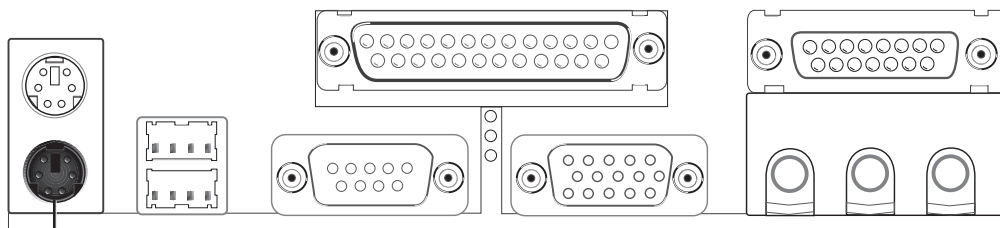

PS/2 Keyboard (6-pin Female)

2. PS/2 Mouse Connector (6-pin Female)

The system will direct IRQ12 to the PS/2 mouse if one is detected. If not detected, expansion cards can use IRQ12. See “PS/2 Mouse Control” in BIOS Features Setup of the BIOS SOFTWARE.

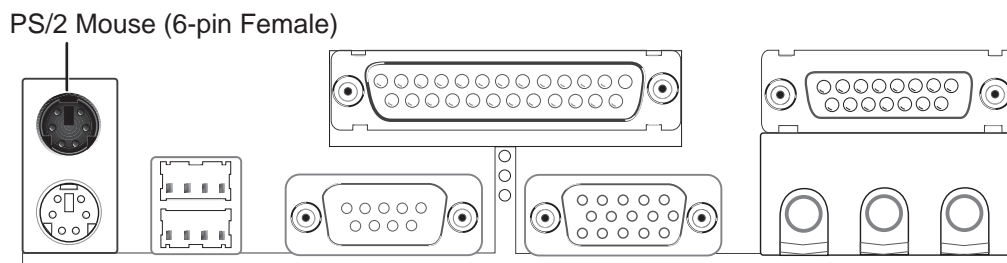

PS/2 Mouse (6-pin Female)

III. HARDWARE SETUP

3. Parallel Port Connector (25-pin Female)

You can enable the parallel port and choose the IRQ through “Onboard Parallel Port” in Chipset Features Setup of the BIOS SOFTWARE.

NOTE: Serial printers must be connected to the serial port.

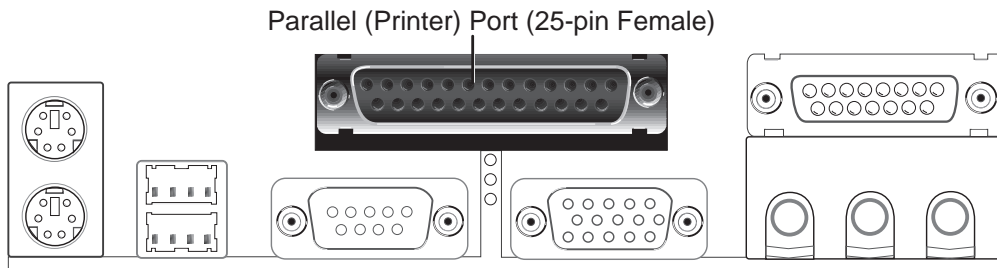

4. Serial Port COM1 (9-pin Male) / 5. COM2 Connectors (10-1 pin Male)

The two serial ports can be used for pointing devices or other serial devices. COM1 is ready for use while COM2 requires a serial port bracket connected from the motherboard to an expansion slot opening. For setting these ports up, see “Onboard Serial Port” in Chipset Features Setup of the BIOS SOFTWARE.

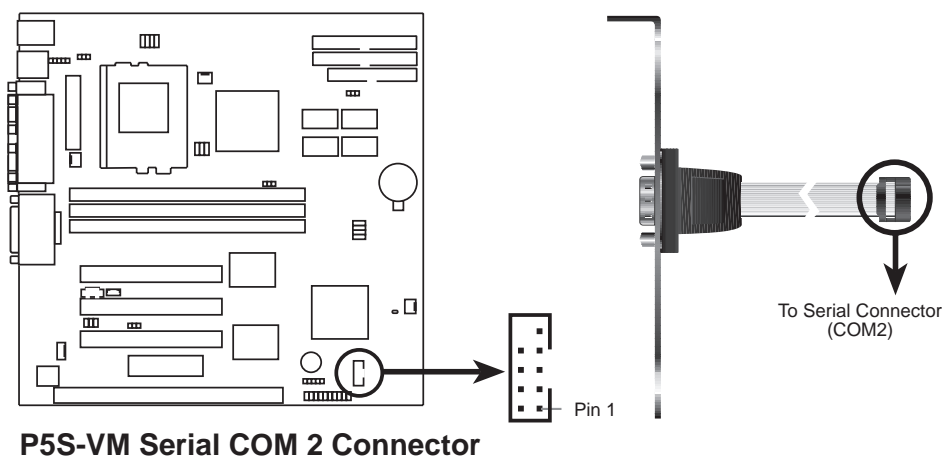
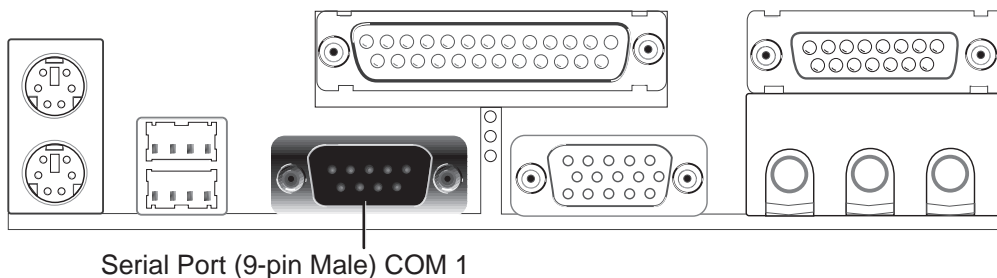

III. HARDWARE SETUP

6. Monitor (VGA) Output Connector (15-pin Female)

This connector is for output to a VGA-compatible device.

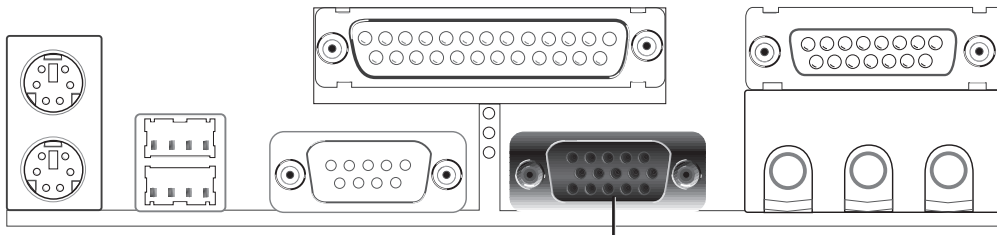

VGA Monitor (15-pin Female)

7. Floppy drive connector (FLOPPY, 34-1 pin block)

This connector supports the provided floppy drive ribbon cable. After connecting the single end to the board, connect the two plugs on the other end to the floppy drives. **(Pin 5 is removed to prevent inserting in the wrong orientation when using ribbon cables with pin 5 plugged).**

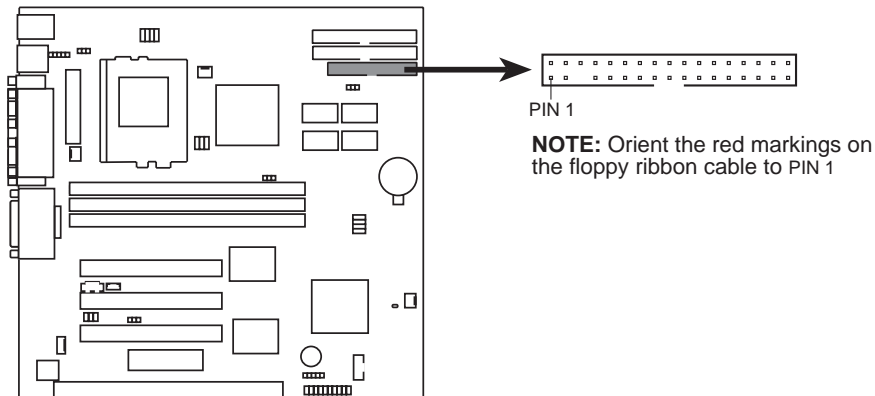

P5S-VM Floppy Disk Drive Connector

8. Audio Port Connectors (Three 1/8" Female) (with optional onboard audio)

Line Out can be connected to headphones or preferably powered speakers. **Line In** allows tape players or other audio sources to be recorded by your computer or played through the **Line Out**. **Mic** allows microphones to be connected for inputting voice.

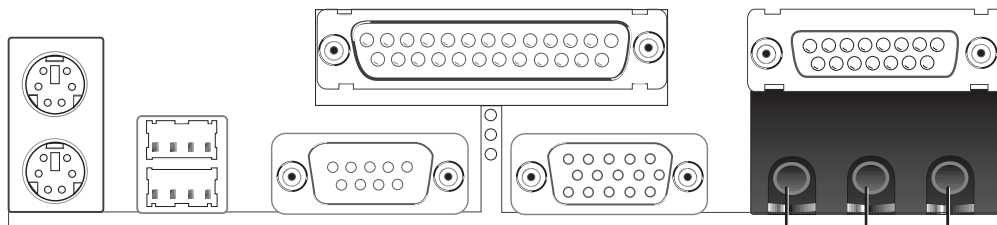

Line Out Line In Mic
1/8" Stereo Audio Connectors

III. HARDWARE SETUP

9. Joystick/Midi Connector (15-pin Female) (with optional onboard audio)

You may connect game joysticks or game pads to this connector for playing games. Connect Midi devices for playing or editing audio.

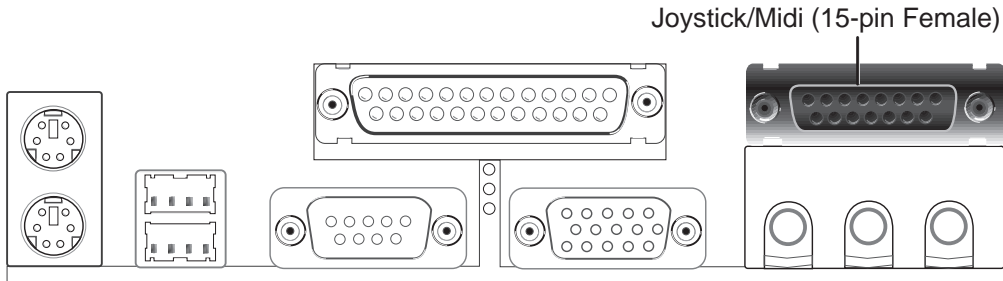

10. Universal Serial BUS Ports 1 & 2 (Two 4-pin Female Sockets)

Two USB ports are available for connecting USB devices.

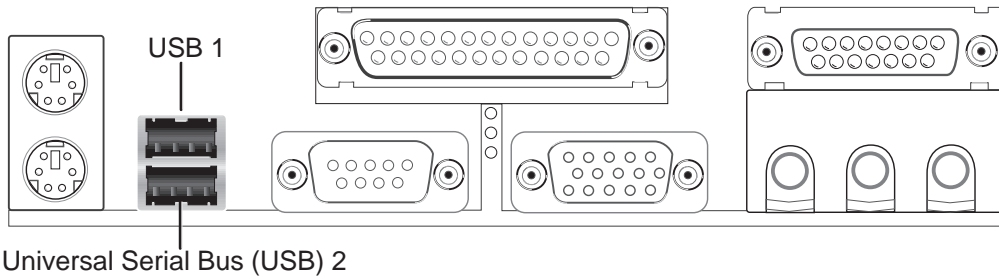

III. HARDWARE SETUP

11. Primary / Secondary IDE connectors (Two 40-1 pin block)

These connectors support the provided IDE hard disk ribbon cable. After connecting the single end to the board, connect the two plugs at the other end to your hard disk(s). If you install two hard disks on the same channel, you must set the second drive to Slave mode. Refer to the documentation of your hard disk for the jumper settings. BIOS now supports SCSI device or IDE CD-ROM bootup (see *HDD Sequence SCSI/IDE First & Boot Sequence* in **BIOS Features Setup** of the BIOS SOFTWARE) (**Pin 20 is removed to prevent inserting in the wrong orientation when using ribbon cables with pin 20 plugged**).

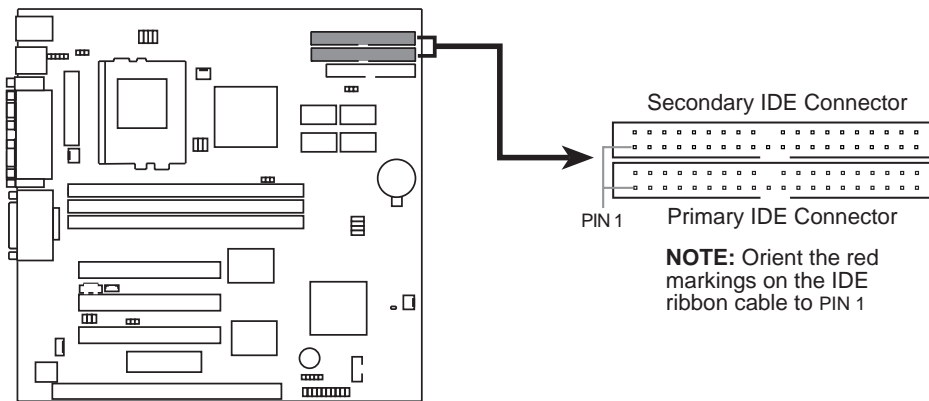

P5S-VM IDE Connectors

TIP: You may configure two hard disks to be both Master drives using one ribbon cable on the primary IDE connector and another ribbon cable on the secondary IDE connector. You may install one operating system on an IDE drive and another on a SCSI drive and select the boot disk through the BIOS features Setup.

III. HARDWARE SETUP

12. ATX Power Supply Connector (ATX, 20-pin block)

This connector connects to an ATX power supply. The plug from the power supply will only insert in one orientation because of the different hole sizes. Find the proper orientation and push down firmly making sure that the pins are aligned.

IMPORTANT: Make sure that your ATX power supply can supply at least 10mAmp on the 5-volt standby lead (+5VSB). You may experience difficulty in powering on your system if your power supply cannot support the load. For Wake on LAN support, your ATX power supply must supply at least 720mAmp.

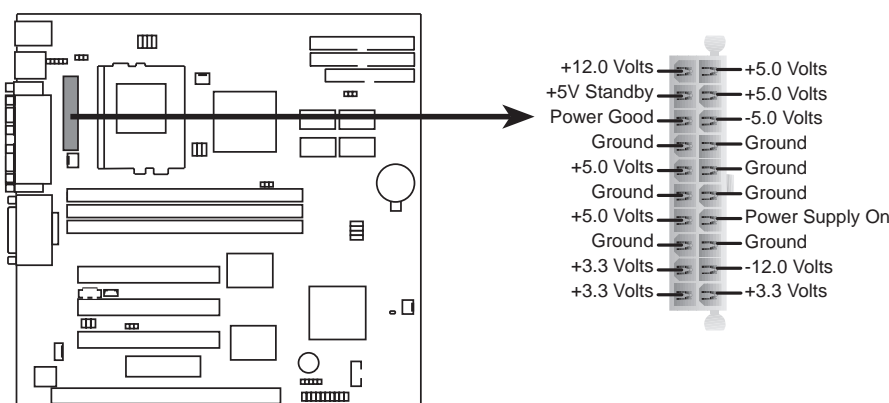

P5S-VM ATX Power Connector

13. IrDA-Compliant Infrared Module Connector (IR, 5-pin block)

This connector supports the optional wireless transmitting and receiving infrared module. This module mounts to a small opening on system cases that support this feature. You must also configure the setting through *UART2 Use Infrared* in **Chipset Features Setup** to select whether UART2 is directed for use with COM2 or IrDA. Use the five pins as shown below (Back View) and connect a ribbon cable from the module to the motherboard according to the pin definitions.

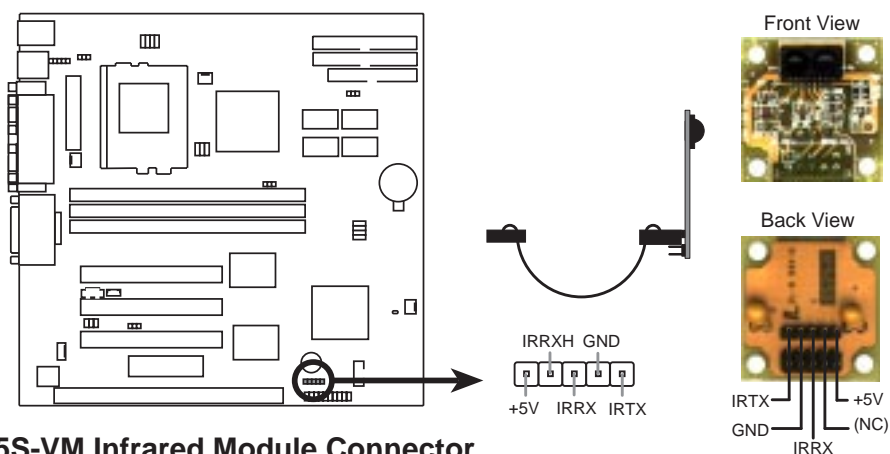

P5S-VM Infrared Module Connector

III. HARDWARE SETUP

14. ATX Power Switch/Soft Power Switch Lead (PWR, 2 pins)

The system power can be controlled by a momentary switch connected to this lead. Pushing the button once will switch the system between ON and SLEEP. Pushing the switch while in the ON mode for more than 4 seconds will turn the system off. The system power LED shows the status of the system's power.

15. IDE Activity LED Lead (IDELED, 2 pins)

This connector supplies power to the cabinet's IDE activity LED. Read and write activity by devices connected to the Primary or Secondary IDE connectors will cause the LED to light up.

16. System Power LED Lead (PLED, 3 pins)

This 3-pin connector connects the system power LED, which lights when the system is powered on and blinks when it is in sleep mode.

17. Reset Switch Lead (RESET, 2 pins)

This 2-pin connector connects to the case-mounted reset switch for rebooting your computer without having to turn off your power switch. This is a preferred method of rebooting in order to prolong the life of the system's power supply.

18. Message LED Lead (MLED, 2 pins)

This indicates whether a message has been received from a fax/modem. The LED will remain lit when there is no signal and blink when there is data transfer or messages waiting in the inbox. This function requires ACPI OS support.

19. Keyboard Lock Switch Lead (KEYLOCK, 2 pins)

This 2-pin connector connects to the case-mounted key switch to allow keyboard locking.

20. Speaker Connector (SPEAKER, 4 pins)

This 4-pin connector connects to the case-mounted speaker.

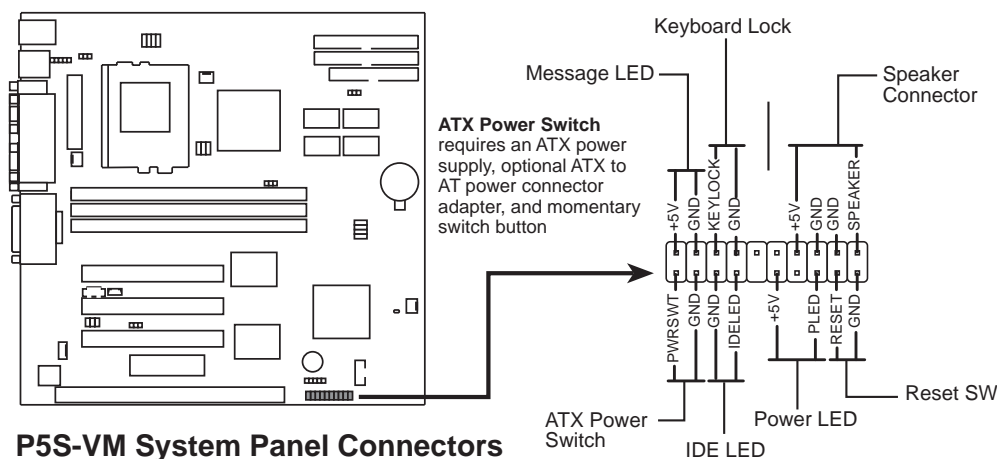

III. HARDWARE SETUP

21. Wake-on-LAN Activity Connector (3-pin WOLCON)

The WOLCON connector allows the system to power up when there is a wakeup packet or signal is received from the network through the ASUS PCI-L101 LAN card (see **ASUS LAN CARD**).

IMPORTANT: This feature requires that the **WAKE On LAN Power Up Control** is set to *Enabled* (see Power Management Setup under **BIOS SOFTWARE**) and that your system has an ATX power supply with at least 720mA +5V standby power.

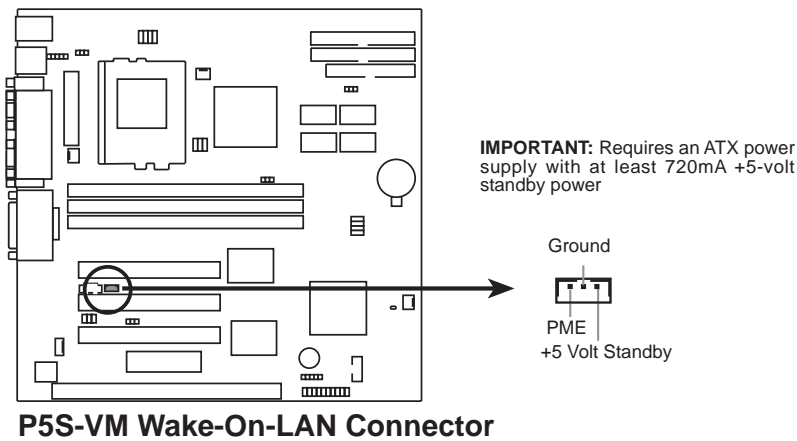

22. Stereo Audio In Connector (4-pin CD_IN) /

23. MODEM Card Voice In Connector (4-pin MODEM)

(with optional onboard audio)

CD_IN allows you to receive stereo audio input from an internal CD-ROM drive or other sound sources, such as a TV tuner or MPEG card. MODEM allows mono input and output for a compatible voice modem microphone and speaker interface.

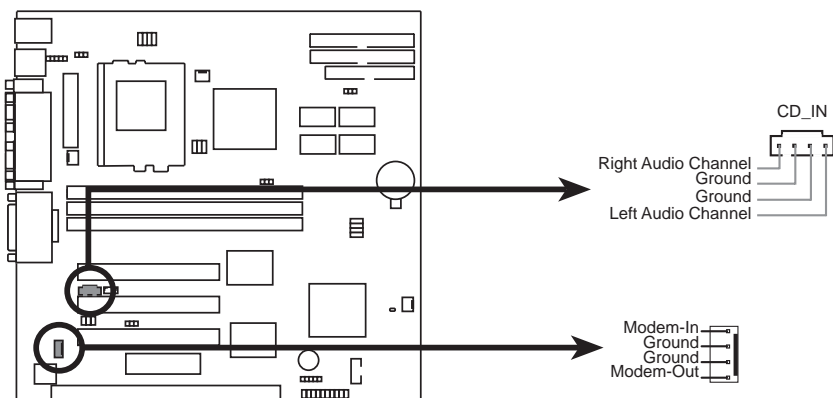

P5S-VM Stereo Audio In / Modem Card Voice In Connectors

III. HARDWARE SETUP

24. CPU/Chassis Cooling Fan Connectors (FAN, 3 pins)

This connector supports a 3-pin CPU and a chassis cooling fan of 500mA (6W) or less with a minimum of 3,500RPM. Depending on the fan manufacturer, the wiring and plug may be different. The red wire should be *Positive*, the black should be *Ground*, and the yellow wire should be *Rotation* signal.

WARNING! The CPU and/or motherboard will overheat if there is no airflow across the CPU. Damage may occur to the motherboard and/or the CPU fan if these pins are incorrectly used. **These are not jumpers, thus, do not place jumper caps over these pins.**

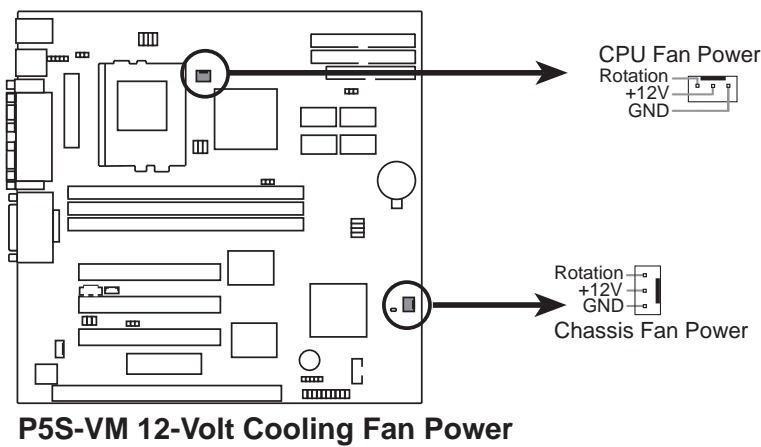

(This page was intentionally left blank.)

III. HARDWARE SETUP

Power Connection Procedures

1. After all jumpers and connections are made, close the system case cover.
2. Be sure that all switches are off (in some systems, marked with ○).
3. Connect the power supply cord into the power supply located on the back of your system case according to your system user's manual.
4. Connect the power cord into a power outlet that is equipped with a surge protector.
5. You may then turn on your devices in the following order:
 - a. Your monitor
 - b. External SCSI devices (starting with the last device on the chain)
 - c. Your system power. For ATX power supplies, you need to switch on the power supply as well as press the ATX power switch on the front of the case.
6. The power LED on the front panel of the system case will light. For ATX power supplies, the system LED will light when the ATX power switch is pressed. The monitor LED may light up after the system's if it complies with "green" standards or if it has a power standby feature. The system will then run power-on tests. While the tests are running, additional messages will appear on the screen. If you do not see anything within 30 seconds from the time you turn on the power, the system may have failed a power-on test. Recheck your jumper settings and connections or call your retailer for assistance.
7. During power-on, hold down <Delete> to enter BIOS setup. Follow the instructions in the next section, BIOS SOFTWARE.

***Powering Off your computer:** You must first exit or shut down your operating system before switching off the power switch. For ATX power supplies, you can press the ATX power switch after exiting or shutting down your operating system. If you use Windows 95, click the **Start** button, click **Shut Down**, and then click **Shut down the computer?**. The power supply should turn off after Windows shuts down.

NOTE: The message "You can now safely turn off your computer" will not appear when shutting down with ATX power supplies.

IV. BIOS SETUP

Flash Memory Writer Utility

AFLASH.EXE: This is the Flash Memory Writer utility that updates the BIOS by uploading a new BIOS file to the programmable flash ROM chip on the motherboard. To determine the BIOS version of your motherboard, check the last four numbers of the code displayed on the upper left-hand corner of your screen during bootup. Larger numbers represent a newer BIOS file. This file works only in DOS mode.

NOTE: The following screen displays are provided as examples only and may not reflect the screen contents displayed on your system.

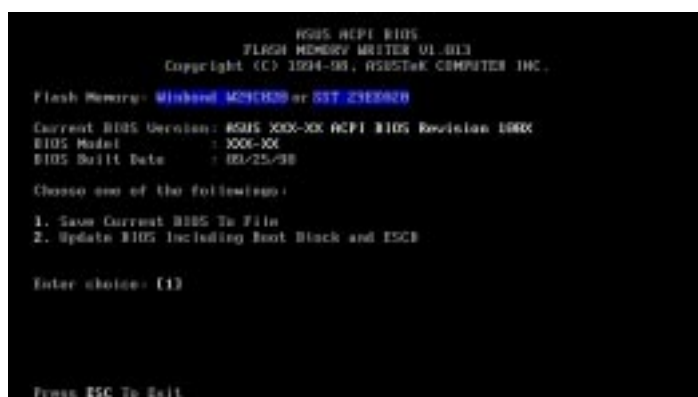

IMPORTANT! If “unknown” is displayed after **Flash Memory:**, the memory chip is either not programmable or is not supported by the ACPI BIOS and therefore, cannot be programmed by the Flash Memory Writer utility.

Main Menu

1. Save Current BIOS To File

This option allows you to save a copy of the original motherboard BIOS in case you need to reinstall it. It is recommended that you save **AFLASH.EXE** and the BIOS file to a bootable floppy disk.

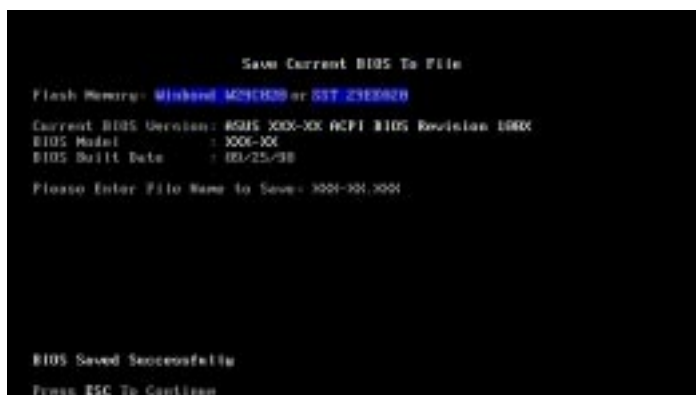

To save your current BIOS, type [1] at the **Main Menu** and then press <Enter>. The **Save Current BIOS To File** screen appears. Type a filename and the path and then press <Enter>.

IV. BIOS SETUP

2. Update BIOS Including Boot Block and ESCD

This option updates the boot block, the baseboard BIOS, and the ACPI extended system configuration data (ESCD) parameter block from a new BIOS file. See the next page for procedures on downloading an updated BIOS file.

To update your current BIOS, type [2] at the **Main Menu** and then press <Enter>. The **Update BIOS Including Boot Block and ESCD** screen appears. Type the filename of your new BIOS and the path and then press <Enter>.

```
Update BIOS Including Boot Block and ESCD
Flash Memory: Winbond W29C020 or SST 29E020
Current BIOS Version: 85215 3000-XX ACPI BIOS Revision 1000
BIOS Model          : 3000-XX
BIOS Build Date     : 09/25/98
Please Enter File Name for NEW BIOS: 81N3000-XX3000
```

When prompted to confirm the BIOS update, press **Y** to start the update.

```
Update BIOS Including Boot Block and ESCD
Flash Memory: Winbond W29C020 or SST 29E020
BIOS Version
(CURRENT) 3 85215 3000-XX ACPI BIOS Revision 1000
(Test.aud) 85215 3000-XX ACPI BIOS Revision 1000
BIOS Model
(CURRENT) 3 3000-XX
(Test.aud) 3000-XX
Date of BIOS Build
(CURRENT) 3 09/25/98
(DOOR,DOOR) 09/25/98
Check sum of 3000.3000 is C370.
Are you sure (Y/N) ? Y
Press ESC To Return to Main Menu
```

The utility starts to program the new BIOS information into the flash ROM. When the programming is finished, *Flashed Successfully* will be displayed.

```
Update BIOS Including Boot Block and ESCD
Flash Memory: Winbond W29C020 or SST 29E020
BIOS Version
(CURRENT) 3 85215 3000-XX ACPI BIOS Revision 1000
(Test.aud) 85215 3000-XX ACPI BIOS Revision 1000
BIOS Model
(CURRENT) 3 3000-XX
(Test.aud) 3000-XX
Date of BIOS Build
(CURRENT) 3 09/25/98
(DOOR,DOOR) 09/25/98
Check sum of 3000.3000 is C370.
Are you sure (Y/N) ? Y
Programming -- 3FFFF
Flashed Successfully
Press ESC To Return to Main Menu
```

Follow the onscreen instructions to continue.

```
85215 ACPI BIOS
FLASH MEMORY WRITER 01.B13
Copyright (C) 1994-98, ASUS/ASUS COMPUTER INC.
Flash Memory: Winbond W29C020 or SST 29E020
Current BIOS Version: 85215 3000-XX ACPI BIOS Revision 1000
BIOS Model          : 3000-XX
BIOS Build Date     : 09/25/98
Choose one of the following:
1. Save Current BIOS To File
2. Update BIOS Including Boot Block and ESCD
Enter choice: [1]
You have flashed the EPROM. It is recommended that you turn off
the power, enter SETUP and Load Setup Defaults to have CMOS
updated with new BIOS when exits.
Press ESC To Exit
```

IV. BIOS SETUP
Flash Memory Writer

IV. BIOS SETUP

Managing and Updating Your Motherboard's BIOS

Upon First Use of the Computer System

1. Create a bootable system floppy disk by typing [FORMAT A:/S] from the DOS prompt without creating "AUTOEXEC.BAT" and "CONFIG.SYS" files.
2. Copy AFLASH.EXE to the just created boot disk.
3. Run AFLASH.EXE from this new disk and select option **1. Save Current BIOS to File**. See **1. Save Current BIOS To File** on the previous page for more details and the rest of the steps.

Updating BIOS Procedures (only when necessary)

1. Download an updated ASUS BIOS file from the Internet (WWW or FTP) or a BBS (Bulletin Board Service) (see ASUS CONTACT INFORMATION on page 3 for details) and save to the disk you created earlier.
2. Boot from the disk you created earlier.
3. At the "A:\>" prompt, type **AFLASH** and then press <Enter>.
4. At the **Main Menu**, type **2** and then press <Enter>. See **2. Update BIOS Including Boot Block and ESCD** on the previous page for more details and the rest of the steps.

WARNING! If you encounter problems while updating the new BIOS, DO NOT turn off your system since this might prevent your system from booting up. Just repeat the process, and if the problem still persists, update the original BIOS file you saved to disk above. If the Flash Memory Writer utility was not able to successfully update a complete BIOS file, your system may not be able to boot up. If this happens, your system will need service.

IV. BIOS SETUP

6. BIOS Setup

The motherboard supports 5-volt programmable 2-Mbit Flash ROM chips. These memory chips can be updated when BIOS upgrades are released. Use the Flash Memory Writer utility to download the new BIOS file into the ROM chip as described in detail in this section.

All computer motherboards provide a Setup utility program for specifying the system configuration and settings. If your motherboard came in a computer system, the proper configuration entries may have already been made. If so, invoke the Setup utility, as described later, and take note of the configuration settings for future reference; in particular, the hard disk specifications.

If you are installing the motherboard, reconfiguring your system or you receive a Run Setup message, you will need to enter new setup information. This section describes how to configure your system using this utility.

The BIOS ROM of the system stores the Setup utility. When you turn on the computer, the system provides you with the opportunity to run this program. This appears during the Power-On Self Test (POST). Press <Delete> to call up the Setup utility. If you are a little bit late pressing the mentioned key(s), POST will continue with its test routines, thus preventing you from calling up Setup. If you still need to call Setup, reset the system by pressing <Ctrl> + <Alt> + <Delete>, or by pressing the Reset button on the system case. You can also restart by turning the system off and then back on again. But do so only if the first two methods fail.

When you invoke Setup, the CMOS SETUP UTILITY main program screen will appear with the following options:

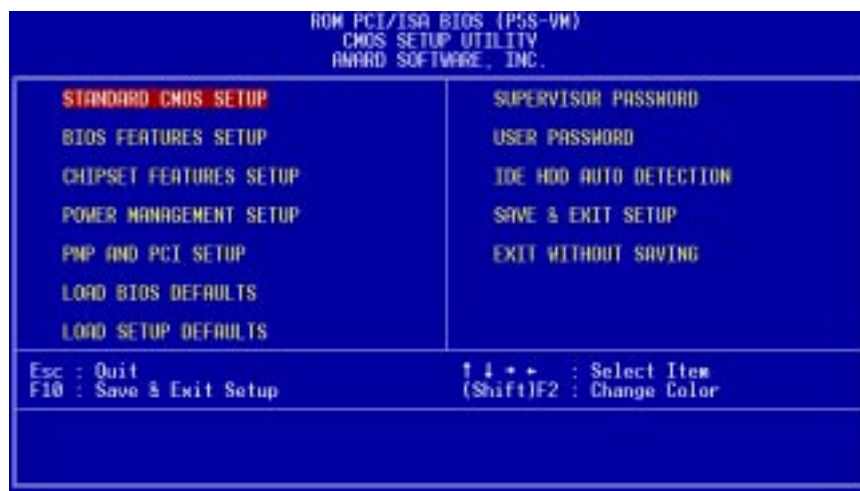

IV. BIOS SETUP

Load Defaults

Load BIOS Defaults loads the minimum settings for troubleshooting. **Load Setup Defaults**, on the other hand, is for loading optimized defaults for regular use. Choosing defaults at this level will modify all applicable settings.

A section at the bottom of the preceding screen displays the control keys for this screen. Take note of these keys and their respective uses.

Standard CMOS Setup

Standard CMOS Setup allows you to record some basic system hardware configuration and set the system clock and error handling. If the motherboard is already installed in a working system, you will not need to select this option anymore. However, if the configuration stored in the CMOS memory on the board gets lost or damaged, or if you change your system hardware configuration, you will need to respecify the configuration values. The configuration values usually get lost or corrupted when the power of the onboard CMOS battery weakens.



The preceding screen provides you with a list of options. At the bottom of this screen are the control keys. Take note of these keys and their respective uses.

User-configurable fields appear in a different color. If you need information on the selected field, press <F1>. The help menu will then appear to provide you with the information you need. The memory display at the lower right of the screen is read-only and automatically adjusts accordingly.

Details of Standard CMOS Setup

Date

To set the date, highlight the “Date” field and then press either <Page Up>/<Page Down> or <+>/<-> to set the current date. Follow the month, day and year format. Valid values for month, day and year are: **Month: (1 to 12), Day: (1 to 31), Year: (up to 2079)**

IV. BIOS SETUP

Time

To set the time, highlight the “Time” field and then press either <Page Up>/<Page Down> or <+>/<-> to set the current time. Follow the hour, minute and second format. Valid values for hour, minute and second are: **(Hour: (00 to 23), Minute: (00 to 59), Second: (00 to 59)**. If you do not want to modify the current time, press <Enter> three times to go to **HARD DISKS**.

NOTE: You can bypass the date and time prompts by creating an AUTOEXEC.BAT file. For information on how to create this file, refer to the MS-DOS manual.

Hard Disk Drives

This field records the specifications for all non-SCSI hard disk drives installed in your system. The onboard PCI IDE connectors provide Primary and Secondary channels for connecting up to four IDE hard disks or other IDE devices. Each channel can support up to two hard disks; the first of which is the “master” and the second is the “slave”.

Specifications for SCSI hard disks need not to be entered here since they operate using device drivers and are not supported by any the BIOS. If you install either the optional PCI-SC200 or PCI-SC860 SCSI controller card into the motherboard, see section VI for instructions. If you install other vendor’s SCSI controller card, refer to their respective documentations on how to install the required SCSI drivers.

For IDE hard disk drive setup, you can:

- Use the *Auto* setting for detection during bootup.
- Use the IDE HDD AUTO DETECTION in the main menu to automatically enter the drive specifications.
- Enter the specifications yourself manually by using the “User” option.

The entries for specifying the hard disk type include **CYLS** (number of cylinders), **HEAD** (number of read/write heads), **PRECOMP** (write precompensation), **LANDZ** (landing zone), **SECTOR** (number of sectors) and **MODE**. The **SIZE** field automatically adjusts according to the configuration you specify. The documentation that comes with your hard disk should provide you with the information regarding the drive specifications.

The **MODE** entry is for IDE hard disks only, and can be ignored for MFM and ESDI drives. This entry provides three options: *Normal*, *Large*, *LBA*, or *Auto* (see below). Set **MODE** to the *Normal* for IDE hard disk drives smaller than 528MB; set it to *LBA* for drives over 528MB that support Logical Block Addressing (LBA) to allow larger IDE hard disks; set it to *Large* for drives over 528MB that do not support LBA. *Large* type of drive can only be used with MS-DOS and is very uncommon. Most IDE drives over 528MB support the *LBA* mode.

IV. BIOS SETUP

Auto detection of hard disks on bootup

For each field: Primary Master, Primary Slave, Secondary Master, and Secondary Slave, you can select *Auto* under the TYPE and MODE fields. This will enable auto detection of your IDE hard disk during bootup. This will allow you to change your hard disks (with the power off) and then power on without having to reconfigure your hard disk type. If you use older hard disks that do not support this feature, then you must configure the hard disk in the standard method as described earlier by the “User” option.

NOTE: After the IDE hard disk drive information has been entered into BIOS, new IDE hard disk drives must be partitioned (such as with FDISK) and then formatted before data can be read from and write on. Primary IDE hard disk drives must have its partition set to *active* (also possible with FDISK).

NOTE: SETUP Defaults are noted in parenthesis next to each function heading.

Drive A / Drive B (None)

These fields record the types of floppy disk drives installed in your system. The available options for drives A and B are: *360K , 5.25 in.; 1.2M , 5.25 in.; 720K , 3.5 in.; 1.44M , 3.5 in.; 2.88M , 3.5 in.; None*

To enter the configuration value for a particular drive, highlight its corresponding field and then select the drive type using the left- or right-arrow keys.

Floppy 3 Mode Support (Disabled)

This is the Japanese standard floppy drive. The standard stores 1.2MB in a 3.5inch diskette. This is normally disabled but you may choose from either: *Drive A, Drive B, Both, and Disabled*

Video (EGA/VGA)

Set this field to the type of video display card installed in your system. The options are *EGA/VGA, CGA 40, CGA 80, and MONO* (for Hercules or MDA).

If you are using a VGA or any higher resolution card, choose *EGA/VGA*.

Halt On (All Errors)

This field determines which types of errors will cause the system to halt. Choose from *All Errors; No Errors; All,But Keyboard; All,But Diskette; and All,But Disk/Key*.

IV. BIOS SETUP

BIOS Features Setup

BIOS Features Setup consists of configuration entries that allow you to improve your system performance, or let you set up some system features according to your preference. Some entries are required by the motherboard's design to remain in their default settings.



A section at the lower right of the screen displays the control keys you can use. Take note of these keys and their respective uses. If you need information on a particular entry, highlight it and then press <F1>. A pop-up help menu will appear to provide you with the information you need. <F5> loads the last set values, <F6> and <F7> loads the BIOS default values and Setup default values, respectively.

NOTE: SETUP Defaults are noted in parenthesis next to each function heading.

Details of BIOS Features Setup

Boot Virus Detection (Enabled)

This field allows you to set boot virus detection, ensuring a virus-free boot sector. This new antivirus solution is unlike native BIOS tools, which offer limited virus protection typically by write-protecting the partition table. With this new solution, your computer is protected against boot virus threats earlier in the boot cycle, that is, before they have a chance to load into your system. This ensures your computer boots to a clean operating system. The system halts and displays a warning message when it detects a virus. If this occurs, you can either allow the operation to continue or use a virus-free bootable floppy disk to restart and investigate your system. Because of conflicts with new operating systems, for example, during installation of new software, you may have to set this to *Disabled* to prevent write errors.

CPU Internal Cache (Enabled)

Choose *Disable* to turn off the CPU's built-in level 1 cache.

External Cache (Enabled)

Choose *Disable* to turn off the CPU's external level 2 cache.

IV. BIOS SETUP

Quick Power On Self Test (Enabled)

This field speeds up the Power-On Self Test (POST) routine by skipping retesting a second, third, and fourth time. Setup default setting for this field is *Enabled*. A complete test of the system is done on each test.

HDD Sequence SCSI/IDE First (IDE)

When using both SCSI and IDE hard disk drives, IDE is always the boot disk using drive letter C (default setting of *IDE*). This new feature allows a SCSI hard disk drive to be the boot disk when set to *SCSI*. This allows multiple operating systems to be used on both IDE and SCSI drives or the primary operating system to boot using a SCSI hard disk drive.

Boot Sequence (A,C)

This field determines where the system looks first for an operating system. Options are *A,C*; *A,CDROM,C*; *CDROM,C,A*; *CDROM A,C*; *D,A*; *E,A*; *F,A*; *C only*; *LS/ZIP,C*; *LAN,A,C*; *LAN,C,A*; and *C,A*. The setup default setting, *A,C*, checks first the floppy disk and then the hard disk drive.

Boot Up Floppy Seek (Disabled)

When enabled, the BIOS will seek drive A one time.

Floppy Disk Access Control (R/W)

This allows protection of files from the computer system to be copied to floppy disk drives by allowing the setting of *Read Only* to only allow reads from the floppy disk drive but not writes. The setup default *R/W* allows both reads and writes.

IDE HDD Block Mode Sectors (HDD MAX)

This field enhances hard disk performance by making multi-sector transfers instead of one sector per transfer. Most IDE drives, except older versions, can utilize this feature. Selections are *HDD MAX*, *Disabled*, *2*, *4*, *8*, *16*, and *32*.

HDD S.M.A.R.T. capability (Disabled)

This field enables or disables S.M.A.R.T. (Self-Monitoring Analysis and Reporting Technology) support for S.M.A.R.T.-capable hard disk drives. This technology requires an application that can display S.M.A.R.T. warning messages.

PS/2 Mouse Function Control (Auto)

The setting of *Auto* allows the system to detect a PS/2 Mouse on bootup. If detected, IRQ12 will be used for the PS/2 Mouse. If not detected, IRQ12 will be reserved for expansion cards. *Enabled* will reserve IRQ12 for the PS/2 Mouse.

OS/2 Onboard Memory > 64M (Disabled)

When using OS/2 operating systems with installed DRAM of greater than 64MB, you need to *Enable* this option otherwise leave this on the setup default of *Disabled*.

.....

PCI/VGA Palette Snoop (Disabled)

Some display cards that are nonstandard VGA, such as graphic accelerators or MPEG video cards may not show colors properly. Setting this to *Enabled* should correct this problem. Otherwise, leave this on the default setting of *Disabled*.

Video ROM BIOS Shadow (Enabled)

This field allows you to change the video BIOS location from ROM to RAM. Relocating to RAM enhances system performance, as information access is faster than the ROM.

IV. BIOS SETUP

C8000 - CBFFF Shadow to DC000 - DFFFF Shadow (Disabled)

These fields are used for shadowing other expansion card ROMs. If you install other expansion cards with ROMs on them, you will need to know which addresses the ROMs use to shadow them specifically. Shadowing a ROM reduces the memory available between 640KB and 1024KB by the amount used for this purpose.

Boot Up NumLock Status (On)

This field enables users to activate the Number Lock function upon system boot.

Typematic Rate Setting (Disabled)

When enabled, you can set the **Typematic Rate** and **Delay**.

Typematic Rate (Chars/Sec) (6)

This field controls the speed at which the system registers repeated keystrokes. Options range from 6 to 30 characters per second. Setup default setting is **6**; other settings are **8, 10, 12, 15, 20, 24, and 30**.

Typematic Delay (Msec) (250)

This field sets the time interval for displaying the first and second characters. Four delay rate options are available: 250, 500, 750, and 1000.

Security Option (System)

When you specify a *Supervisor Password* and/or *User Password* (explained later in this section), the Security Option field determines when the system prompts for the password. The default setting is **System**, where the system prompts for the User Password every time you start your system. The other option is **Setup**, where the system goes through its startup routine unless the Setup utility is called, when the system prompts for the Supervisor Password.

IV. BIOS SETUP

Chipset Features Setup

Chipset Features Setup controls the configuration of the board's chipset. Control keys for this screen are the same as in the **BIOS Features Setup** screen.



NOTE: SETUP Defaults are noted in parenthesis next to each function heading.

Details of Chipset Features Setup

SDRAM Configuration (By SPD)

This sets the optimal timing for items 2-4. Leave on default setting, depending on the memory modules that you are using. Default setting is *By SPD*, which configures items 2-4 by reading the contents in the SPD (Serial Presence Detect) device. This 8-pin serial EEPROM device stores critical parameter information about the module, such as memory type, size, speed, voltage interface, and module banks.

SDRAM CAS Latency

This controls the latency between SDRAM read command and the time that the data actually becomes available. Leave on default setting.

SDRAM RAS Precharge Time

This controls the idle clocks after issuing a precharge command to SDRAM. Leave on default setting.

SDRAM RAS to CAS Delay

This controls the latency between SDRAM active command and the read/write command. Leave on default setting.

ROM Cycle Wait State (4-Wait)

Leave both on default setting.

16-bit I/O Recovery Time (5 BUSCLK) / 8-bit I/O Recovery Time (8 BUSCLK)

Timing for 16- and 8-bit ISA cards, respectively. Leave on default settings.

ISA Bus Clock (PCICLK/4)

Leave on default setting.

IV. BIOS SETUP

Graphics Aperture Size (64MB)

Memory-mapped, graphics data structures can reside in a Graphics Aperture. Leave on default setting.

Memory Hole At Address (None)

This allows you to specify the memory address space to be reserved for ISA expansion cards that specifically require this setting. Setting the address space to a particular setting (available settings: *15M-16M*, *14M-16M*, *12M-16M*) will make that memory space unavailable to the system. Expansion cards can only access memory up to 16M. The default is *None*.

Delayed Transaction (Disabled)

If *Enabled*, this frees the PCI Bus during CPU accessing of 8-bit ISA cards that normally consume about 50-60 PCI Clocks without PCI delayed transaction. If PCI Bus Masters cannot use the PCI Bus, leave this on the default setting of *Disabled* for some ISA cards that are not PCI 2.1 compliant.

VGA Shared Memory Size (4MB)

This allows you to specify the memory size (available settings: *2MB*, *4MB*, *8MB*) to be shared with the onboard VGA controller. Default setting is *4MB*.

.....

Onboard FDC Controller (Enabled)

When enabled, this field allows you to connect your floppy disk drives to the onboard floppy drive connector instead of a separate controller card. If you want to use a different controller card to connect the floppy disk drives, set this field to *Disabled*.

Onboard FDC Swap A & B (No Swap)

This field allows you to reverse the hardware drive letter assignments of your floppy disk drives. Two options are available: *Swap AB* and *No Swap* (default). If you want to switch drive letter assignments, set this field to *Swap AB*, and the swap will be controlled by the onboard chipset.

Onboard Serial Port 1 (3F8H/IRQ4)

Settings are *3F8H/IRQ4*, *2F8H/IRQ3*, *3E8H/IRQ4*, *2E8H/IRQ10*, and *Disabled* for the onboard serial connector.

Onboard Serial Port 2 (2F8H/IRQ3)

Settings are *3F8H/IRQ4*, *2F8H/IRQ3*, *3E8H/IRQ4*, *2E8H/IRQ10*, and *Disabled* for the onboard serial connector.

Onboard Parallel Port (378H/IRQ7)

This field sets the address of the onboard parallel port connector. You can select either *3BCH/IRQ7*, *378H/IRQ7*, *278H/IRQ5*, or *Disabled*. If you install an I/O card with a parallel port, ensure that there is no conflict in the address assignments. The PC can support up to three parallel ports as long as there are no conflicts for each port.

IV. BIOS SETUP

Parallel Port Mode (ECP+EPP)

This field allows you to set the operation mode of the parallel port. The setting *Normal*, allows normal-speed operation but in one direction only; *EPP* allows bidirectional parallel port operation at maximum speed; *ECP* allows the parallel port to operate in bidirectional mode and at a speed faster than the maximum data transfer rate; *ECP+EPP* allows normal speed operation in a two-way mode.

ECP DMA Select (3)

This selection is available only if you select *ECP* or *ECP+EPP* in the **Parallel Port Mode**. Select either DMA Channel *1*, *3*, or *Disabled*.

UART2 Use Infrared (Disabled)

When enabled, this field activates the onboard infrared feature and sets the second serial UART to support the infrared module connector on the motherboard. If your system already has a second serial port connected to the onboard COM2 connector, it will no longer work if you enable the infrared feature. By default, this field is set to *Disabled*, which leaves the second serial port UART to support the COM2 serial port connector. See **IrDA/Fast IR-Compliant Infrared Module Connector** under section III.

Onboard PCI IDE Enable (Both)

You can select to enable the *Primary* IDE channel, *Secondary* IDE channel, *Both*, or *Disable* both channels (for systems with only SCSI drives).

IDE Ultra DMA Mode (Auto)

This sets the IDE UltraDMA to be active when using UltraDMA-capable IDE devices. The BIOS will automatically adjust or disable this setting for slower IDE devices so that Auto or high settings will not cause problems for older IDE devices. Choose *Disable* if you do not want this feature for all devices.

IDE 0 Master/Slave PIO/DMA Mode, IDE 1 Master/Slave PIO/DMA Mode (Auto)

Each channel (0 and 1) has both a master and a slave making four IDE devices possible. Because each IDE device may have a different Mode timing (0, 1, 2, 3, 4), it is necessary for these to be independent. PIO and DMA timings can be independently set. The default setting of *Auto* will allow autodetection to ensure optimal performance.

IV. BIOS SETUP

Power Management Setup

Power Management Setup allows you to reduce power consumption. This feature turns off the video display and shuts down the hard disk after a period of inactivity.

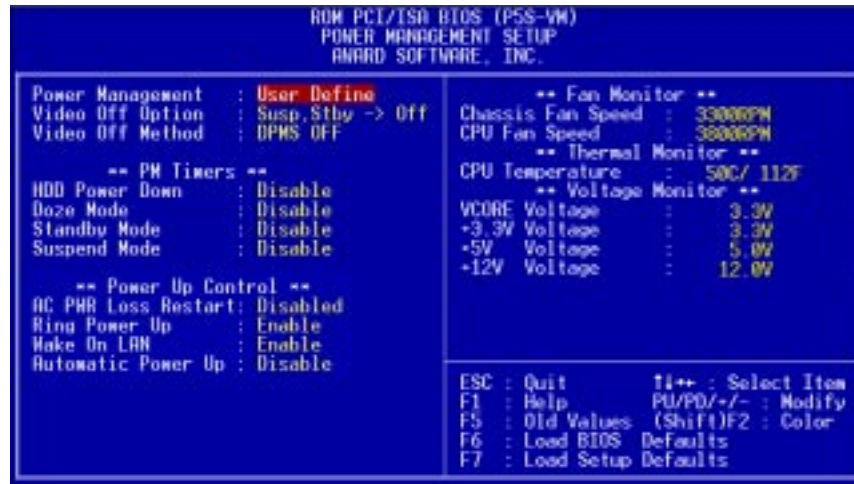

NOTE: SETUP Defaults are noted in parenthesis next to each function heading.

Details of Power Management Setup

Power Management (User Define)

This field acts as the master control for the power management modes. *User Define* allows you to set power saving options according to your preference; *Disable* disables the power saving features; *Min Saving* puts the system into power saving mode after 40 min of system inactivity; *Max Saving* puts the system into power saving mode after 30 sec of system inactivity.

IMPORTANT: Advanced Power Management (APM) should be installed to keep the system time updated when the computer enters suspend mode activated by the BIOS Power Management. For DOS environments, you need to add `DEVICE=C:\DOS\POWER.EXE` in you `CONFIG.SYS`. For Windows 3.x and Windows 95, you need to install Windows with the APM feature. A battery and power cord icon labeled “Power” will appear in the “Control Panel.” Choose “Advanced” in the Power Management Field.

Video Off Option (Susp,Stby -> Off)

This field determines when to activate the video off feature for monitor power management. The settings are *All Modes -> Off*; *Always On*; *Suspend -> Off*; and *Susp,Stby -> Off*.

IV. BIOS SETUP

Video Off Method (DPMS OFF)

This field defines the video off features. These options are available: *DPMS OFF*, *DPMS Reduce ON*, *Blank Screen*, *V/H SYNC+Blank*, *DPMS Standby*, and *DPMS Suspend*. The DPMS (Display Power Management System) features allow the BIOS to control the video display card if it supports the DPMS feature. *Blank Screen* only blanks the screen (for monitors without power management or “green” features). If set up in your system, your screen saver will not display with *Blank Screen* selected). *V/H SYNC+Blank* blanks the screen and turns off vertical and horizontal scanning.

.....

PM Timers

This section controls the time-out settings for the Power Management scheme. The fields included in this section are **HDD Power Down**, which places the hard disk into its lowest power consumption mode, and the **Doze**, **Standby** and **Suspend** system inactivation modes.

The system automatically “wakes up” from any power saving mode when there is system activity, such as when a key is pressed from the keyboard, or when there is activity detected from the enabled IRQ channels.

HDD Power Down (Disable)

This shuts down any IDE hard disk drives in the system after a period of inactivity. This time period is user-configurable from *1 Min* to *15 Min* or *Disable*. This feature does not affect SCSI hard disks.

Doze Mode, Standby Mode, Suspend Mode (Disable)

These fields set the period of time after which each of these modes activate: *1 Min*, *2 Min*, *3 Min*, *4 Min*, *8 Min*, *20 Min*, *30 Min*, *40 Min*, or *1 Hour*. The default setting is *Disable*.

.....

Power Up Control

This section determines the ways the system can be controlled when it is started or restarted, when modem activity is detected, or when power to the computer is interrupted and reapplied.

AC PWR Loss Restart (Disabled)

This allows you to set how you want your system to boot up after the power has been interrupted. **Disabled** leaves your system off after reapplying power and **Enabled** boots up your system after reapplying power.

Ring Power Up (Enable)

This allows either settings of *Enable* or *Disable* for powering up the computer (turns the ATX power supply on) when the modem receives a call while the computer is off.

NOTE: The computer cannot receive or transmit data until the computer and applications are fully running, thus connection cannot be made on the first try. Turning an external modem off and then back on while the computer is off causes an initialization string that will also cause the system to power on.

IV. BIOS SETUP

Wake On LAN (Enable)

This allows you to remotely power up your system through your network by sending a wake-up frame or signal. With this feature, you can remotely upload/download data to/from systems during off-peak hours. Set to *Enable* to use this feature.

IMPORTANT: This feature requires the ASUS PCI-L101 LAN Card (see **APPENDIX**) or a similar ethernet card and an ATX power supply with at least 720mA +5V standby power.

Automatic Power Up (Disable)

This allows you to have an unattended or automatic power up of your system. You may configure your system to power up at a certain time of a day in a week by selecting *Enable*.

.....

Fan Monitor (xxxxRPM)

The onboard hardware monitor is able to detect the Chassis Fan Speed and CPU Fan Speed in Rotations Per Minute (RPM). These values refresh upon any key entries in the BIOS setup screen. Set to *Ignore* if one of these are not used so that error messages will not be given.

Thermal Monitor (xxxC/xxxF)

The onboard hardware monitor is able to detect the CPU temperature. These values refresh upon key entries. Set to *Ignore* only if necessary.

Voltage Monitor (xx.xV)

The onboard hardware monitor is able to detect the voltages put out by the voltage regulators. These values refresh upon key entries. Set to *Ignore* only if necessary.

NOTE: If any of the monitored items are out of range, an error message will appear: "Hardware Monitor found an error, enter POWER MANAGEMENT SETUP for details". You will then be prompted to "Press **F1** to continue, **DEL** to enter SETUP".

IV. BIOS SETUP

PNP and PCI Setup

This “PNP and PCI Setup” option configures the PCI bus slots. All PCI bus slots on the system use INTA#, thus all installed PCI cards must be set to this value.

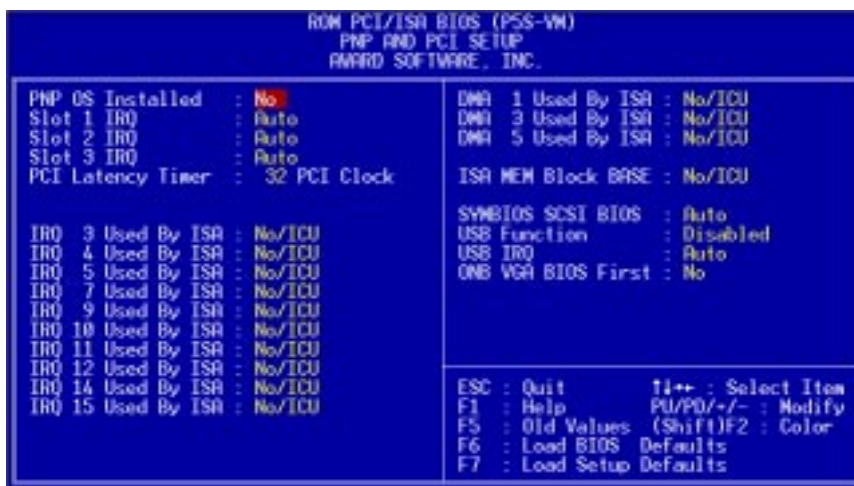

NOTE: SETUP Defaults are noted in parenthesis next to each function heading.

Details of PNP and PCI Setup

PNP OS Installed (No)

This field allows you to use a Plug-and-Play (PnP) operating system to configure the PCI bus slots instead of using the BIOS. Thus interrupts may be reassigned by the OS when *Yes* is selected. When a non-PnP OS is installed or to prevent reassigning of interrupt settings, select the default setting of *No*.

Slot 1 IRQ (Auto) / Slot 2 IRQ (Auto) / Slot 3 IRQ (Auto)

These fields set how IRQ use is determined for each PCI slot. The default setting for each field is *Auto*, which uses auto-routing to determine IRQ use. The other options are manual settings of *NA*, *3*, *4*, *5*, *7*, *9*, *10*, *11*, *12*, *14* or *15* for each slot.

PCI Latency Timer (32 PCI Clock)

The default setting of *32 PCI Clock* enables maximum PCI performance.

IRQ xx Used By ISA (No/ICU)

These fields indicate whether or not the displayed IRQ for each field is being used by a legacy (non-PnP) ISA card. Two options are available: *No/ICU* and *Yes*. The first option, the default value, indicates either that the displayed IRQ is not used or an ISA Configuration Utility (ICU) is being used to determine if an ISA card is using that IRQ. If you install a legacy ISA card that requires a unique IRQ, and you are not using an ICU, you must set the field for that IRQ to *Yes*. For example: If you install a legacy ISA card that requires IRQ 10, then set **IRQ10 Used By ISA** to *Yes*.

.....

IV. BIOS SETUP

DMA x Used By ISA (No/ICU)

These fields indicate whether or not the displayed DMA channel for each field is being used by a legacy (non-PnP) ISA card. Available options include: *No/ICU* and *Yes*. The first option, the default setting, indicates either that the displayed DMA channel is not used or an ICU is being used to determine if an ISA card is using that channel. If you install a legacy ISA card that requires a unique DMA channel, and you are not using an ICU, you must set the field for that channel to *Yes*.

ISA MEM Block BASE (No/ICU)

This field allows you to set the base address and block size of a legacy ISA card that uses any memory segment within the C800H and DFFFH address range. If you have such a card, and you are not using an ICU to specify its address range, select a base address from the six available options; the **ISA MEM Block SIZE** field will then appear for selecting the block size. If you have more than one legacy ISA card in your system that requires to use this address range, you can increase the block size to either 8K, 16K, 36K, or 64K. If you are using an ICU to accomplish this task, leave **ISA MEM Block BASE** to its default setting of *No/ICU*.

SYMBIOS SCSI BIOS (Auto)

Auto allows the BIOS to detect whether you have a Symbios SCSI card, if detected the onboard Symbios BIOS will be enabled, if not then it will be disabled. *Disabled* prevents the onboard Symbios BIOS to be enabled so that the external Symbios SCSI card's own BIOS can be used instead. **Note:** If your Symbios SCSI card does not have a BIOS the Symbios SCSI card will not function.

USB Function (Disabled)

This motherboard supports Universal Serial Bus (USB) devices. Set to *Enabled* if you want to use USB devices. Your system must support USB function. The default setting is *Disabled*.

USB IRQ (Auto)

This field allows you to reserve an IRQ# (5, 7, 9, 10, 11, 12, 14, or 15) for the USB to work. *Auto* assigns an IRQ# automatically to your USB device. If you are not using a USB device, you may disable this feature by setting it to *NA* to save an extra IRQ# for other devices or expansion cards.

ONB VGA BIOS First (No)

This field, when set to *Yes*, gives priority to the onboard VGA BIOS over other VGA controllers. The default setting is *No*.

IV. BIOS SETUP

Load BIOS Defaults

This “Load BIOS Defaults” option allows you to load the troubleshooting default values permanently stored in the BIOS ROM. These default settings are non-optimal and disable all high performance features. To load these default settings, highlight “Load BIOS Defaults” on the main screen and then press <Enter>. The system displays a confirmation message on the screen. Press <Y> and then <Enter> to confirm. Press <N> and then <Enter> to abort. This feature does not affect the fields on the Standard CMOS Setup screen.

Load Setup Defaults

This “Load Setup Defaults” option allows you to load the default values to the system configuration fields. These default values are the optimized configuration settings for the system. To load these default values, highlight “Load Setup Defaults” on the main screen and then press <Enter>. The system displays a confirmation message on the screen. Press <Y> and then <Enter> to confirm. Press <N> and then <Enter> to abort. This feature does not affect the fields on the Standard CMOS Setup screen.

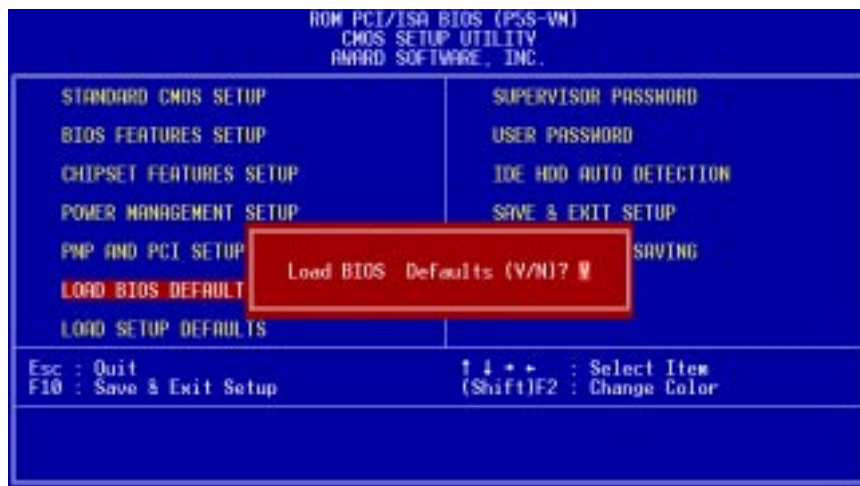

IV. BIOS SETUP

Supervisor Password and User Password

These two options set the system passwords. “Supervisor Password” sets a password that will be used to protect the system and the Setup utility; “User Password” sets a password that will be used exclusively on the system. By default, the system comes without any passwords. To specify a password, highlight the type you want and then press <Enter>. A password prompt appears on the screen. Taking note that the password is case sensitive, and can be up to 8 alphanumeric characters long, type in your password and then press <Enter>. The system confirms your password by asking you to type it again. After setting a password, the screen automatically reverts to the main screen.



To implement password protection, specify in the “Security Option” field of the BIOS Features Setup screen when the system will prompt for the password. If you want to disable either password, press <Enter> instead of entering a new password when the “Enter Password” prompt appears. A message confirms the password has been disabled.

Forgot the password?

If you forgot the password, you can clear the password by erasing the CMOS Real Time Clock (RTC) RAM. The RAM data containing the password information is powered by the onboard button cell battery. To erase the RTC RAM: (1) Unplug your computer, (2) Short the solder points, (3) Turn ON your computer, (4) Hold down <Delete> during bootup and enter BIOS setup to re-enter user preferences.

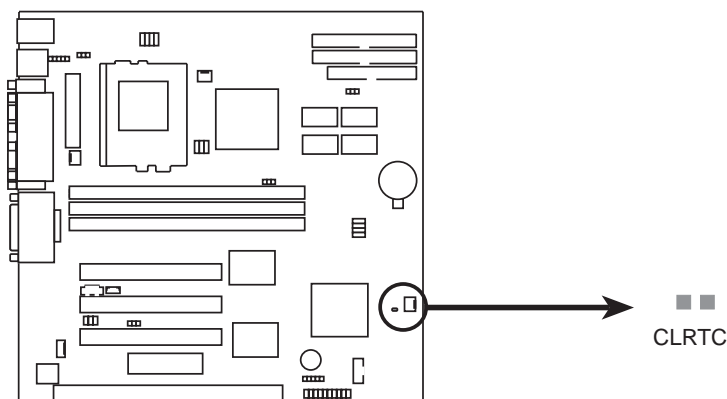

P5S-VM Clear RTC RAM

IV. BIOS SETUP

IDE HDD Auto Detection

This “IDE HDD Auto Detection” option detects the parameters of an IDE hard disk drive, and automatically enters them into the Standard CMOS Setup screen.

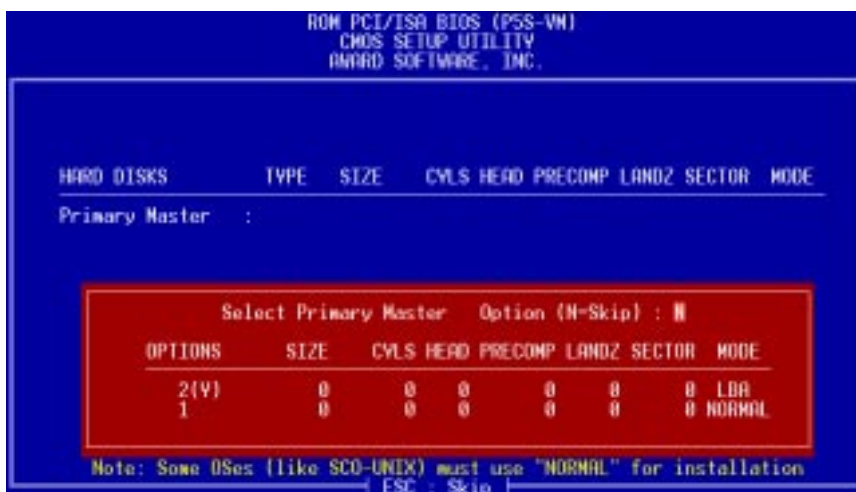

Up to four IDE drives can be detected, with parameters for each listed inside the box. To accept the optimal entries, press <Y> or else select from the numbers displayed under the OPTIONS field (2, 1, 3 in this case); to skip to the next drive, press <N>. If you accept the values, the parameters will appear listed beside the drive letter on the screen. The process then proceeds to the next drive letter. Pressing <N> to skip rather than to accept a set of parameters causes the program to enter zeros after that drive letter.

Remember that if you are using another IDE controller that does not feature Enhanced IDE support for four devices, you can only install two IDE hard disk drives. Your IDE controller must support the Enhanced IDE features in order to use Drive E and Drive F. The onboard PCI IDE controller supports Enhanced IDE, with two connectors for connecting up to four IDE devices. If you want to use another controller that supports four drives, you must disable the onboard IDE controller in the Chipset Features Setup screen.

When auto-detection is completed, the program automatically enters all entries you accepted on the field for that drive in the Standard CMOS Setup screen. Skipped entries are ignored and are not entered in the screen.

If you are auto-detecting a hard disk that supports the LBA mode, three lines will appear in the parameter box. Choose the line that lists LBA for an LBA drive. Do not select Large or Normal.

The auto-detection feature can only detect one set of parameters for a particular IDE hard drive. Some IDE drives can use more than one set. This is not a problem if the drive is new and empty.

IV. BIOS SETUP

IMPORTANT: If your hard disk was already formatted on an older previous system, incorrect parameters may be detected. You will need to enter the correct parameters manually or use low-level format if you do not need the data stored on the hard disk.

If the parameters listed differ from the ones used when the disk was formatted, the disk will not be readable. If the auto-detected parameters do not match the ones that should be used for your disk, do not accept them. Press <N> to reject the presented settings and enter the correct ones manually from the Standard CMOS Setup screen.

Save & Exit Setup

Select this option to save into the CMOS memory all modifications you specified during the current session. To save the configuration changes, highlight the “Save & Exit Setup” option on the main screen, type “Y”, and then press <Enter>.



Exit Without Saving

Select this option to exit the Setup utility without saving the modifications you specify during the current session. To exit without saving, highlight the “Exit Without Saving” option on the main screen and then press <Enter>.

(This page was intentionally left blank.)



V. SOFTWARE SETUP	61
Operating Systems	61
Windows 98 First Time Installation	61
P5S-VM Support CD	62
Installation Menu	62
LDCM Local Setup	63
LDCM Administrator Setup	65
ASUS PC Probe Setup	66
Adobe Acrobat Reader	67
Install IDE Bus Master Driver	68
Install Video Driver	69
Install Audio Driver	70
Install PC-Cillin	71
Uninstalling Programs	72
VI. SOFTWARE REFERENCE	73
Intel LANDesk Client Manager	73
ASUS PC Probe	79
SiS 530 Display Properties	82
Creative Multimedia Decks	84
Creative CD Player	85
Creative MIDI Player	86
Creative Remote	87
Creative Wave Player	88
SB AudioPCI 64V Mixer	89
Creative WaveStudio	90
Creative Soundo'LE	90
Desktop Management Interface (DMI)	91
VII. APPENDIX	95
ASUS PCI-L101 Fast Ethernet Card	95

V. SOFTWARE SETUP

Operating Systems

You should always use the latest operating system and updates when using new hardware to ensure full compliancy. For Windows 95, you must use OSR 2.0 or later. For Windows NT 4.0, you must use Service Pack 3.0 or later.

Windows 98 First Time Installation

When you start Windows for the first time after the installation of your motherboard, Windows 98 will detect the onboard audio and video chips and may attempt to install a driver from its system registry. When prompted to restart, select **No** and then follow the normal setup procedures later in this section.

IMPORTANT: Selecting **No** for the initial restart prompt is a necessary step because Windows may load an older display driver that is incompatible with the onboard VGA chip. Always use the driver available on the ASUS Support CD or an applicable driver update from your ASUS vendor or from the ASUS web site.

NOTE: The screen displays in this and the following section may not reflect exactly the screen contents displayed on your screen.

V. SOFTWARE SETUP

P5S-VM Support CD

NOTE: The support CD contents are subject to change at any time without notice.

To begin using your support CD disc, just insert it into your CD-ROM drive and the support CD installation menu should appear. If the menu does not appear, double click or run **D:\SETUP.EXE** (assuming that your CD-ROM drive is drive **D:**).

Installation Menu

- **LDCM Local Setup:** Installs the LANDesk Client Manager (LDCM) software to monitor the local system. A user's manual in Adobe Acrobat PDF format is available under the **LDCM33/Local** folder created on your system during setup.
- **LDCM Administrator Setup:** Installs the LDCM software to monitor PC systems on the network within the same bridge address with the Local software installed. A user's manual in PDF format is available under the **LDCM33/Admin** folder created on your system during setup.
- **ASUS PC Probe Setup:** Installs a simple utility to monitor your computer's fan, temperature, and voltages. (**NOTE:** This utility will not run with LDCM installed.) A user's manual in PDF format is available under the **ASUSLM** folder created on your system during setup.
- **Adobe Acrobat Reader:** Installs the Adobe Acrobat Reader software necessary to view user's manuals saved in PDF format, such as that of the ASUS PC Probe. Updated or other language versions of this motherboard's manual is available in PDF format at any of our web sites.
- **Install IDE Bus Master Driver:** Installs the BusMaster IDE driver for improved performance. (Available only for Windows NT.)
- **Install Video Driver:** Installs the necessary VGA drivers and utilities to access the features of the integrated VGA controller.
- **Install Audio Driver (Optional):** Installs the necessary audio drivers and utilities to access the features of the built-in PCI audio chipset.
- **Install PCCillin:** Installs the PC-cillin virus protection software. View the online help for more information.
- **Browse this CD:** Allows you to view the contents of the CD.
- **Read Me:** Displays the filelist for the included support software.
- **LDCM Introduce (MPEG VCD):** Plays an overview of LDCM in MPEG format.
- **Exit:** Exits the CD installation menu.

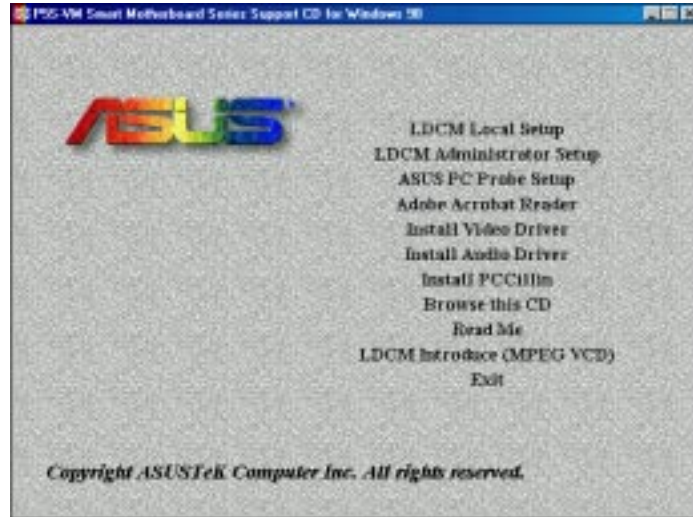

Additional CD Contents: DMI Configuration Utility under the **DMI** folder, Flash BIOS writer under the **AFLASH** folder.

V. SOFTWARE SETUP

LDCM Local Setup

Insert the Support CD that came with your motherboard into your CD-ROM drive or double-click the CD drive icon in **My Computer** to bring up the setup screen.

NOTE: LDCM will not run if ASUS' PC Probe utility is installed. To uninstall PC Probe, see section on *Uninstalling Programs*.

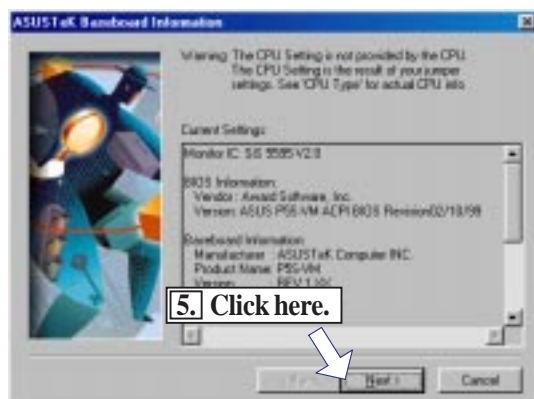
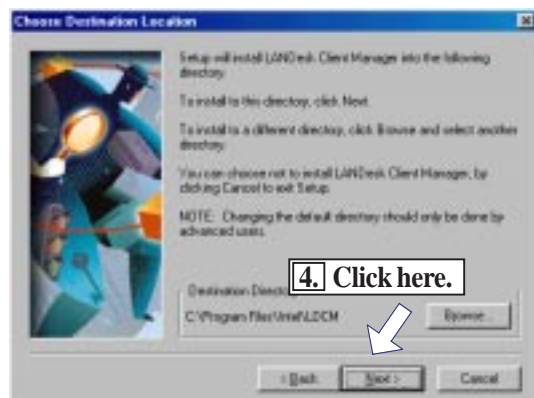
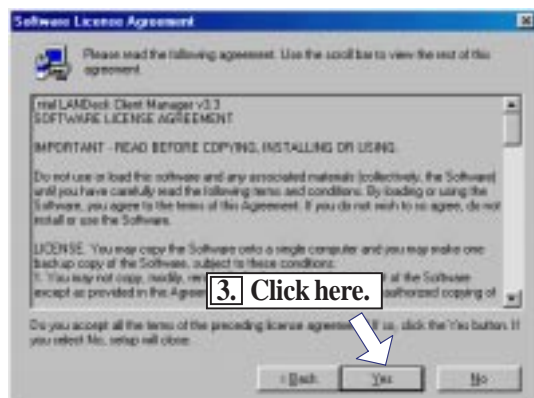
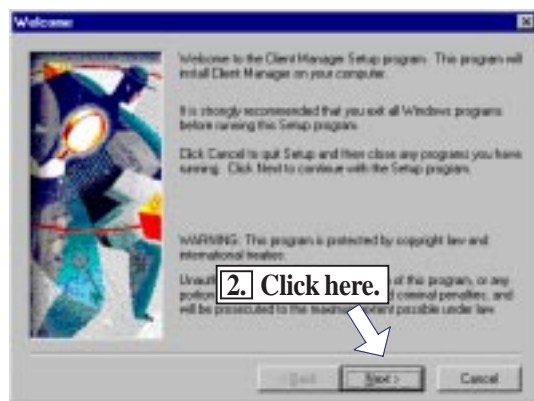
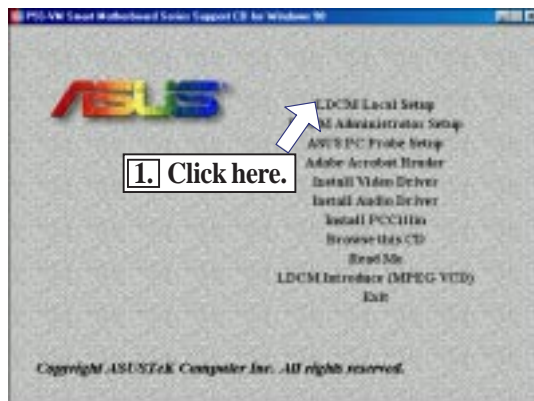

V. SOFTWARE SETUP

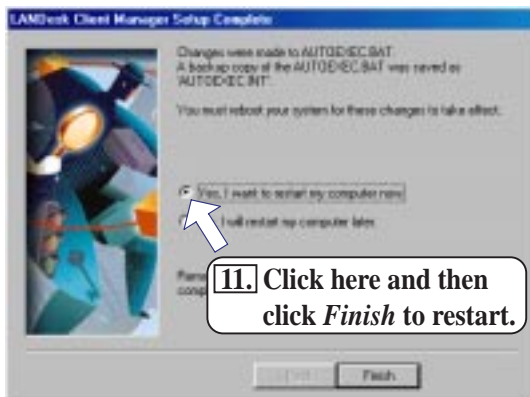
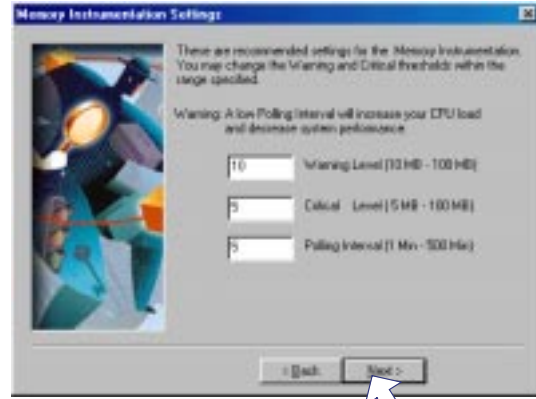

V. SOFTWARE SETUP

LDCM Administrator Setup

Insert the Support CD that came with your motherboard into your CD-ROM drive or double-click the CD drive icon in **My Computer** to bring up the setup screen.

NOTE: LDCM will not run if ASUS' PC Probe utility is installed. To uninstall PC Probe, see section on *Uninstalling Programs*.

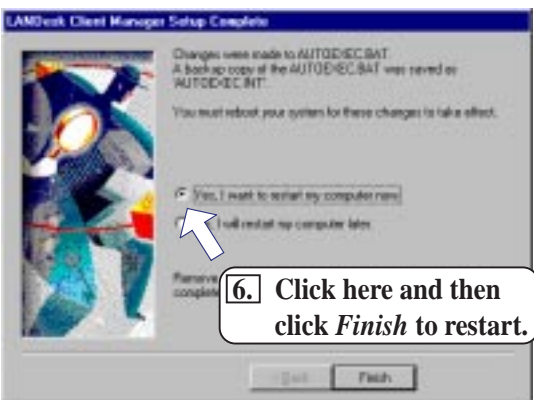
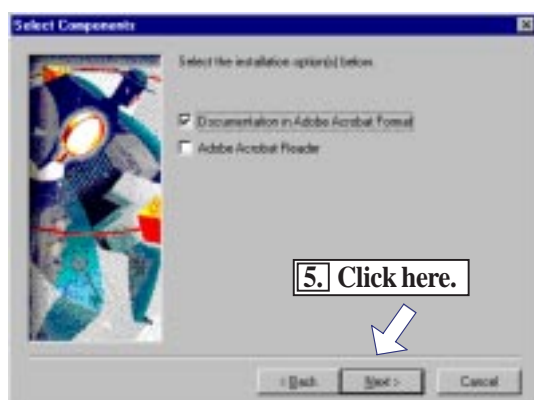
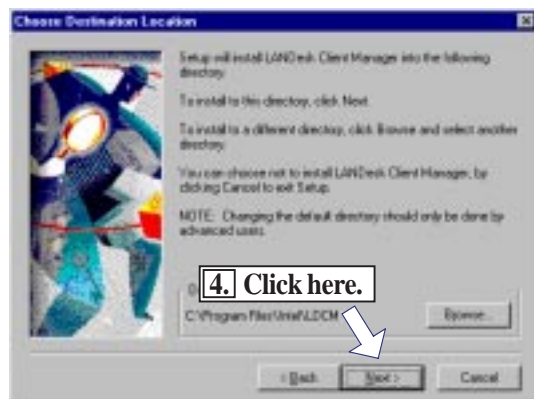
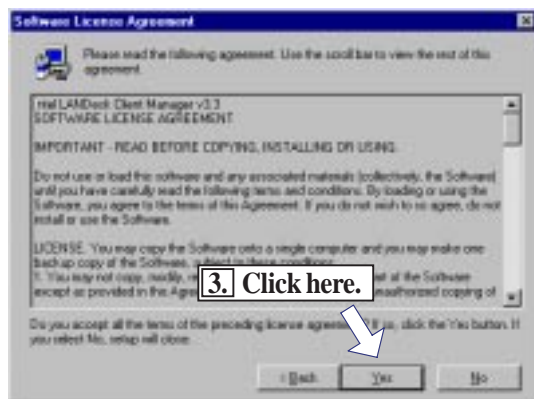
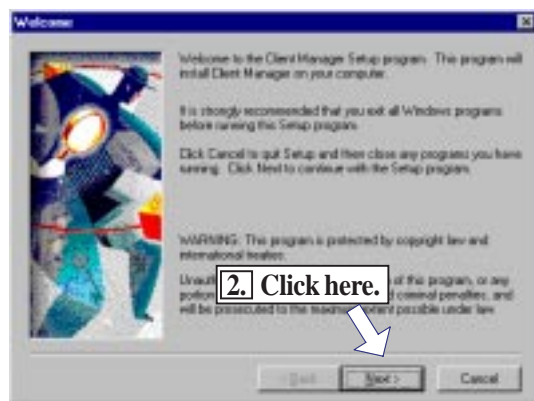

V. SOFTWARE SETUP

ASUS PC Probe Setup

Insert the Support CD that came with your motherboard into your CD-ROM drive or double-click the CD drive icon in **My Computer** to bring up the setup screen.

NOTE: ASUS PC Probe will not run if Intel's LDCM utility is installed. To uninstall Intel's LDCM utility, see section on *Uninstalling Programs*.

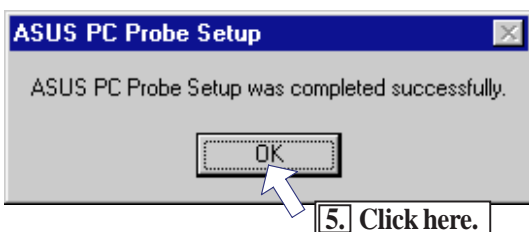
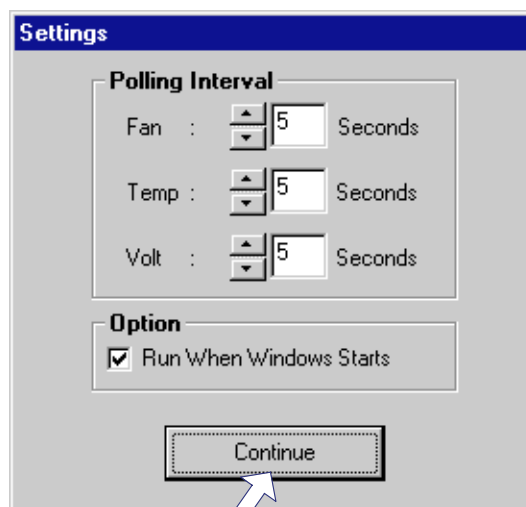
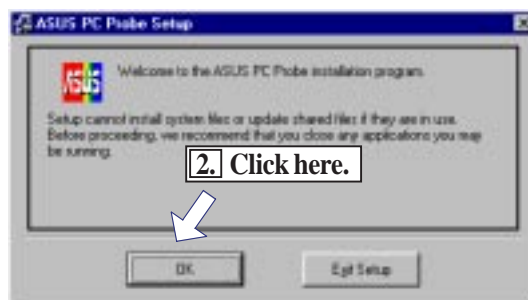

V. SOFTWARE SETUP

Adobe Acrobat Reader

Insert the Support CD that came with your motherboard into your CD-ROM drive or double-click the CD drive icon in **My Computer** to bring up the setup screen.

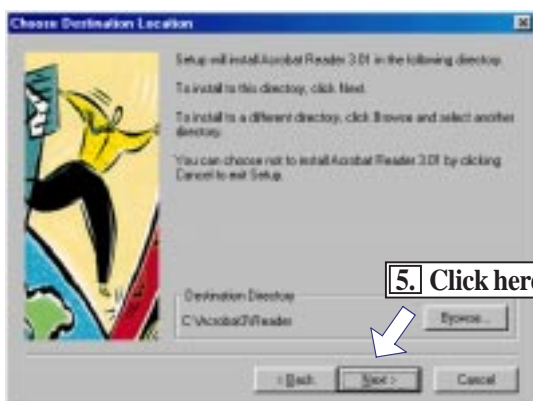
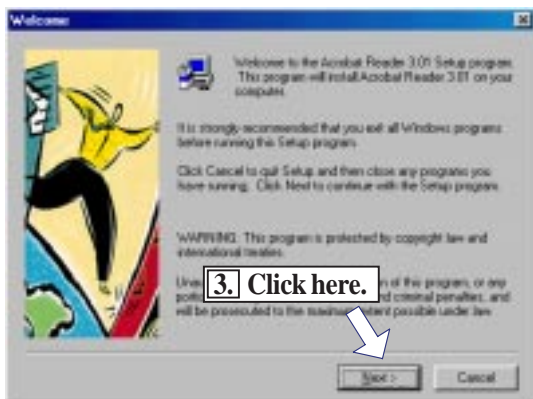
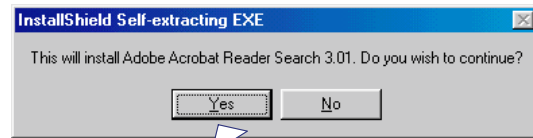
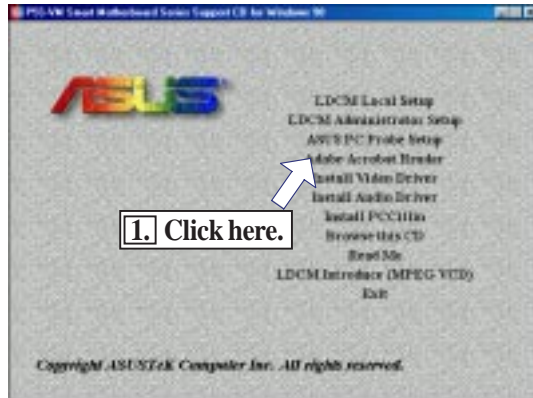

V. SOFTWARE SETUP

Install IDE Bus Master Driver

Insert the Support CD that came with your motherboard into your CD-ROM drive or double-click the CD drive icon in **My Computer** to bring up the setup screen. This option is available only for Windows NT systems.

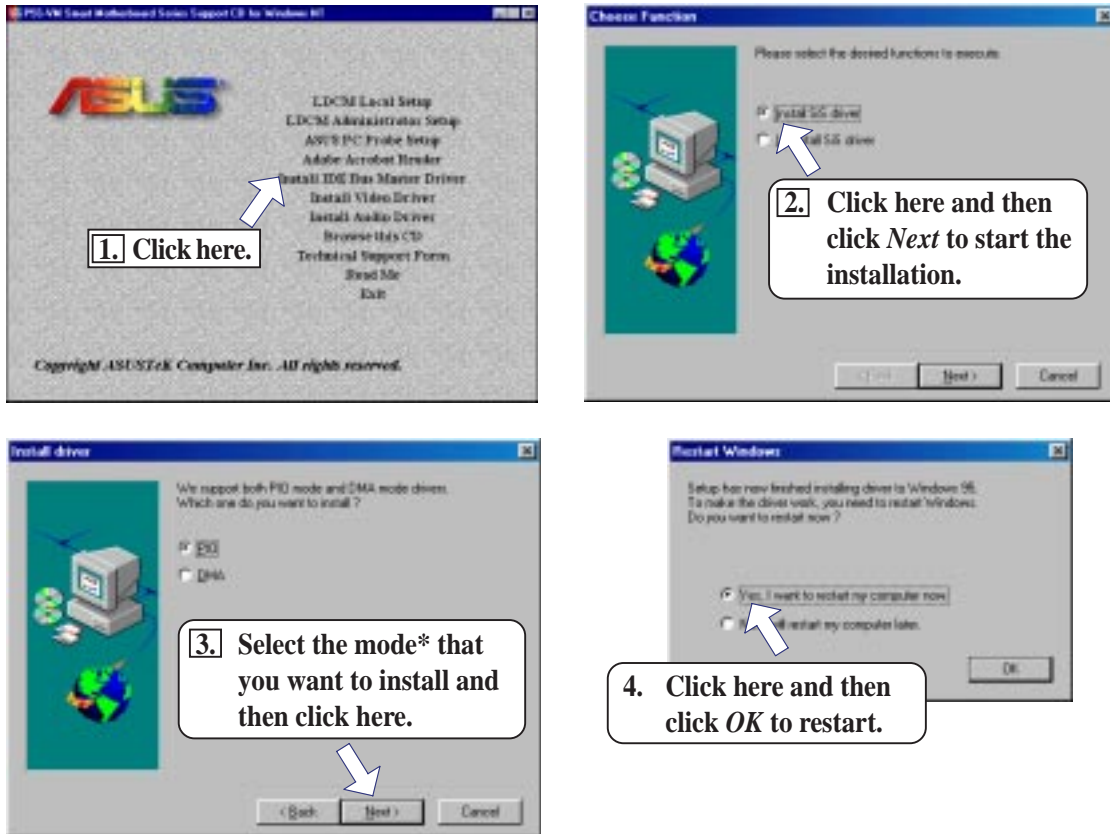

*Transfer Modes Supported

- **PIO Mode** or Programmed Input/Output Mode is the most common way computers transfer data to and from the disk drive. PIO Mode 4, which is the mode installed, differs only from the standard PIO transfer in how often the drive issues interrupts. In PIO Mode 4, each interrupt indicates the drive is ready for 4 sectors of data (read) or has completed the transfer of 4 sectors of data (write), compared with the one interrupt required in standard PIO for each sector. This eliminates some of the system overhead involved in a PIO transfer.
- **DMA (Direct Memory Access) Mode** is used in EISA-, VESA Local Bus-, and PCI-equipped systems. This mode is capable of very fast transfer rates using Bus Mastering. The advantage of using the Bus Master DMA is that it uses less CPU resources than PIO and therefore, it is useful in multitasking environments, where the CPU can work on a different program while data is transferred to or from IDE devices, such as hard disk or CD-ROM drives. **Ultra DMA**, which is the mode installed, is also known as Ultra-ATA (ATA is the "official" name for what the computer industry calls IDE or Integrated Drive Electronics) or Ultra-DMA/33. It is the latest advancement to the ATA specifications. Ultra-DMA, among others, almost doubles the maximum transfer speed of the ATA-3 standard and improves data integrity.

V. SOFTWARE SETUP

Install Video Driver

Insert the Support CD that came with your motherboard into your CD-ROM drive or double-click the CD drive icon in **My Computer** to bring up the setup screen.

Install Video Driver installs the video driver necessary for your card to have higher performance, resolutions, and special features.

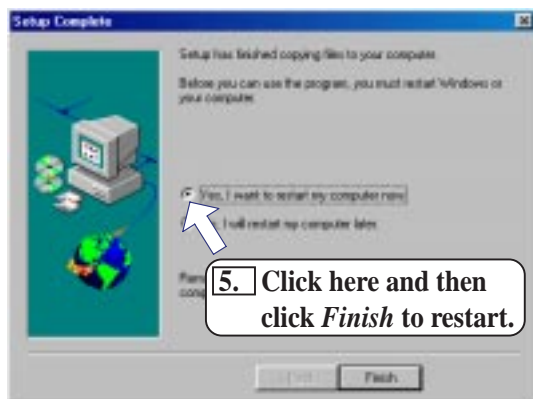
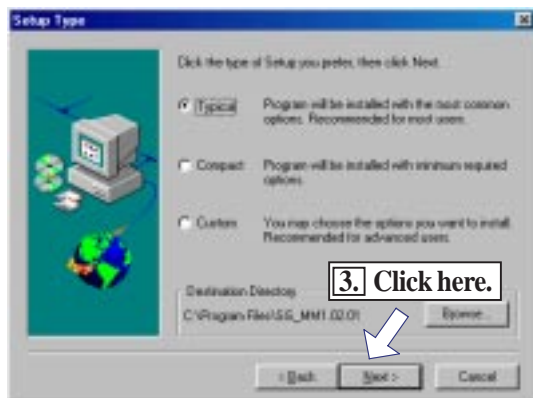
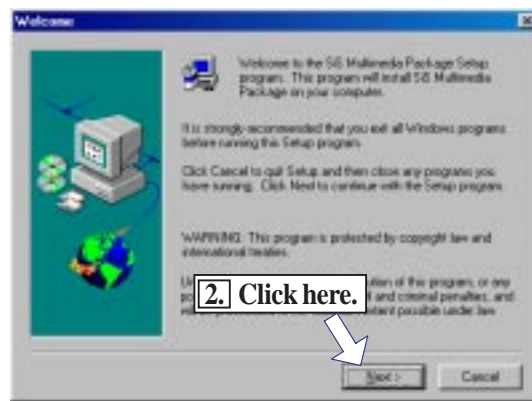
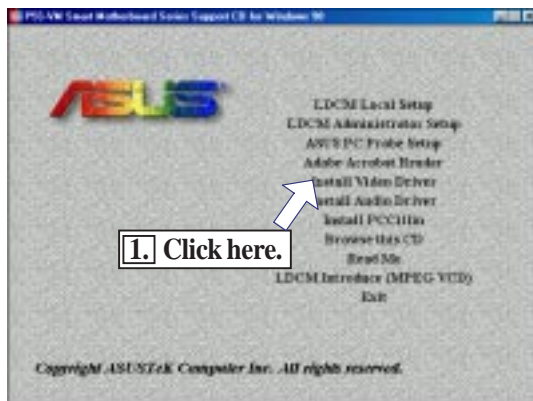

V. SOFTWARE SETUP

Install Audio Driver

CREATIVE SB AudioPCI 64V

Insert the Support CD that came with your motherboard into your CD-ROM drive or double-click the CD drive icon in **My Computer** to bring up the setup screen.

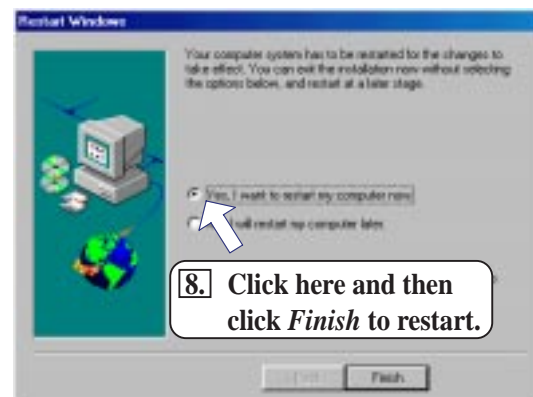
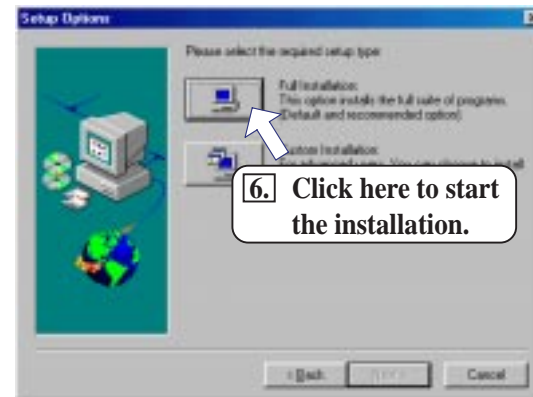
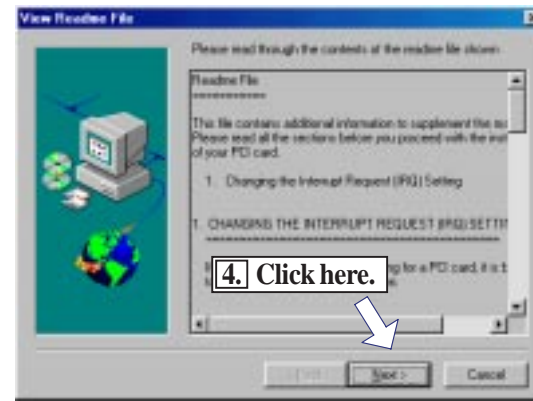

V. SOFTWARE SETUP

Install PC-Cillin

Insert the Support CD that came with your motherboard into your CD-ROM drive or double-click the CD drive icon in **My Computer** to bring up the setup screen.

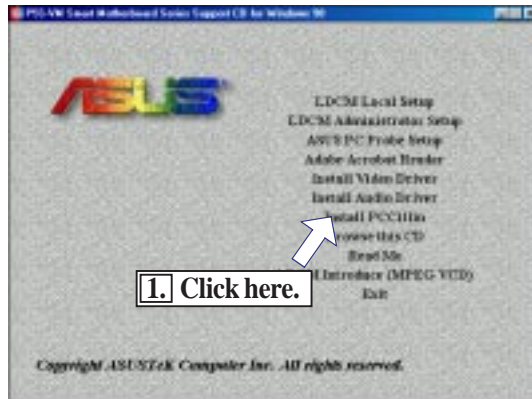

V. SOFTWARE SETUP

Uninstalling Programs

Add/Remove Programs is a basic component within Windows. You may use this function if a program does not provide its own uninstallation program.

1. Double-click here to open the Add/Remove Programs Properties dialog box.

2. Select the program you wish to remove and click here.

3. Click here.

Remove Programs From Your Computer

unInstallShield will remove the s Manager' from your computer. If the following components is removed:

- ✓ Shared program files...
- ✓ Standard program files
- ✓ Folder items...
- ✓ Program folders...
- ✓ Program directories...
- ✓ Program registry entries...

Uninstall completed. [Progress bar] [OK]

Uninstall completed. [Progress bar] [OK]

VI. SOFTWARE REFERENCE

Intel LANDesk Client Manager

With the growth of the computer industry, computer systems have become more complex and difficult to manage. Intel LANDesk Client Manager is a computer management application that simplifies many aspects of managing a computer and assists in troubleshooting common computer problems.

Use Client Manager to:

- Review system inventory
- View DMI-compliant component information
- Backup and restore system files
- Troubleshoot
- Monitor your computer's health
- Receive notifications for system events

Client Manager has been implemented in two different ways:

The client version enables you to view information and manage alerts for a local computer. This version does not permit you to select remote computers, transfer files, or reboot other computers.

The first time you run Client Manager, it searches your network for other computers running Client Manager. Client Manager creates a list of the computers it finds and saves the list to the Windows registry. From this point on, when you run Client Manager or open the Select Computer dialog box, Client Manager checks to see if these computers (listed in the registry) are available and healthy.



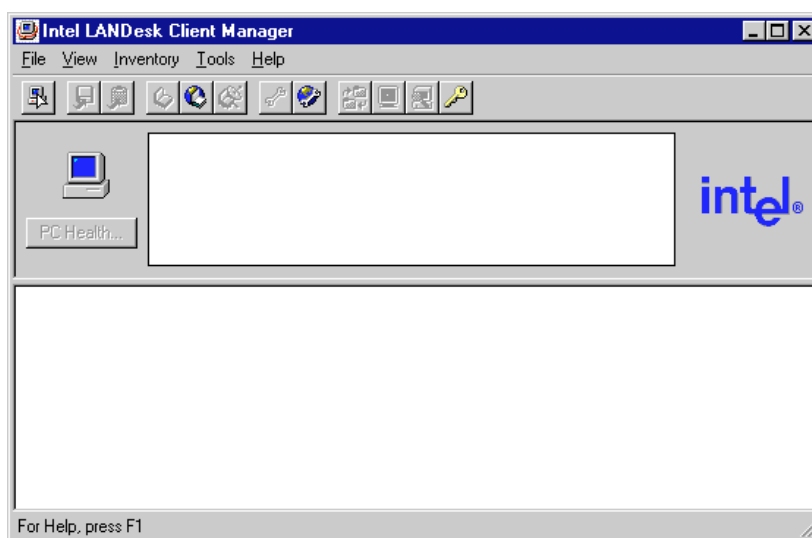









Main Client Manager Window



VI. SOFTWARE REFERENCE

Using the Taskbar icons







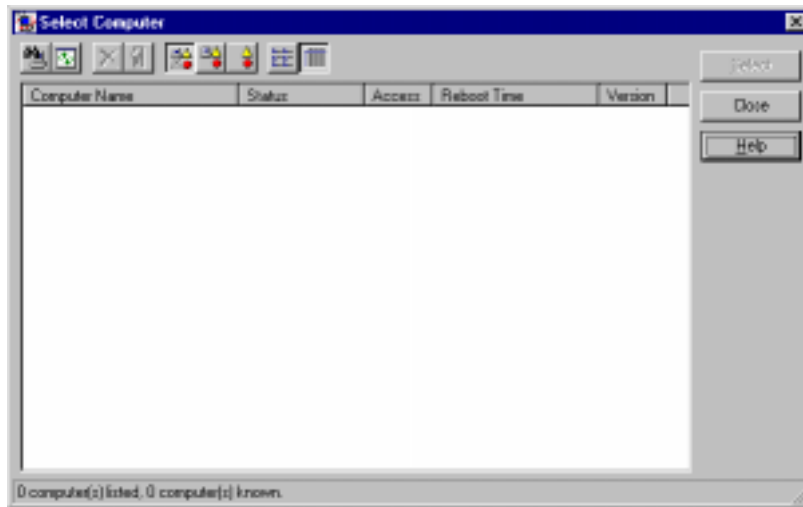

Toolbar Descriptions

	Opens the Select Computer dialog box	File Select Computer
	Opens the Export dialog box to export the inventory to a file	File Export
	Exports the inventory to the clipboard	File Export to clipboard
	Opens the notification log	View Notification Log
	Opens the global notification log	View Global Notification Log
	Opens the remote access log	View Remote Access Log
	Opens the Configure Notifications dialog box	Tools Configure Notifications
	Opens the Configure Global Notifications dialog box	Tools Configure Global
	Opens the File Transfer dialog box	Tools Transfer Files
	Reboots the computer	Tools Reboot
	Opens the DMI Explorer	Tools DMI Explorer
	Opens the Set Access Rights dialog box	Tools Set Access Rights

VI. SOFTWARE REFERENCE

Using the Select Computer Dialog Box



-  Discovers new computers on the network
-  Refreshes the health of known computers
-  Removes a computer from the list of discovered computers
-  Wakes up a sleeping computer
-  Shows all discovered computers
-  Shows only available computers
-  Shows only unhealthy computers
-  Shows a simple list view
-  Shows a detailed list view

VI. SOFTWARE REFERENCE

To select a computer

1. From the main Client Manager window, click **File | Select Computer**.
2. In the *Select Computer* dialog box, click the computer you want to view.
3. Click the **Select** button.

To discover new computers

- In the *Select Computer* dialog box, click the **Discover** button on the toolbar or press <Shift>+<F5>.

TIP: Use the **Discover** button each time you add a computer to the network, change a computer's network adapter, or upgrade a computer to a newer version Client Manager.

To refresh PC health

- In the *Select Computer* dialog box, click the **Refresh Known Computers** button on the toolbar or press <F5>.

TIP: PC health does not automatically update as changes occur. For example, if a computer's health changes while you are displaying the *Select Computer* dialog box, you need to refresh the list in order to view the correct PC health.

To remove a computer from the list

1. In the *Select Computer* dialog box, click the computer name you want to remove.
2. Click the **Remove Computer** button on the toolbar or press Delete.
3. At the prompt, click the **Yes** button.

TIP: Perform this task each time you remove a computer from the network, since the name of that computer is not automatically removed from this list.

To wake up a computer

1. In the *Select Computer* dialog box, click the computer name you want to wake up. You can also <Shift>+click to select a continuous group of computers or <Ctrl>+click to select individual computers in the list.

TIP: You can only attempt to wake up computers that have a status of Unavailable or Wakeable. If the *Select Computer* dialog box does not display any computers with a status of Unavailable or Wakeable and you suspect it should, the list view may be filtered to display only unhealthy or available computers. You may need to change your list view to display all computers.

2. Click the **Wake Up Computer** button on the toolbar to wake up the selected computer(s) or press <Alt>+<W>.

VI. SOFTWARE REFERENCE

After you attempt to wake up a computer, the status of that computer changes in the list view to a Wake Pending status. If the attempt to wake up a computer is successful, the Wake Pending status changes to a status reflecting the computer's health (such as Normal, Warning, or Critical). If the computer does not wake up after five minutes, a message box appears stating possible reasons why the computer did not respond. (For example, the computer may be disabled or may not support Wake-On-LAN.) After clicking OK, the Wake Pending status reverts to its original status of Unavailable or Wakeable.

NOTE: Your computer must have a Wake-On-LAN network adapter to support this feature. Some computers that support the Wake-On-LAN technology may have remote wakeup disabled in the BIOS by default. Before Client Manager can wake up a remote computer, you will need to enable this option in the BIOS configuration of each remote computer.









Displaying the Properties of a Client Computer

You can display the properties of any discovered client computer even if you cannot otherwise access the computer because of access limitations or Unavailable status. If you display the properties of an unavailable computer, the properties are read from a database in the Windows registry on your computer. Since the Operating System information is not stored in this same database, that information is not available for a computer with a status of Unavailable. Remember that some items may not be current if the properties have changed while the computer was off the network.

VI. SOFTWARE REFERENCE

Understanding the Computer Status Icons

When you open the Select Computer dialog box, each computer in the list displays an icon indicating the current status of that computer. The table below describes the seven states a computer may be in.

	Unavailable	The computer is currently in a powered-down state.
	Wakeable	The computer is currently in a powered-down state but supports Remote Wakeup technology.
	Wake Pending	A temporary status (not to exceed five minutes) while Client Manager attempts to wake up a computer. (A computer that is in the process of booting without having received a wakeup instruction is listed as <i>Unavailable</i> , not <i>Wake Pending</i> .)
	Normal	The computer is operating within normal tolerances.
	Warning	A computer that has exceeded a warning tolerance level. For example, the PC Health indicator can be configured to display a warning icon if a hard disk is running low on space.
	Critical	A computer that has exceeded a critical tolerance level. For example, if the hard disk is running critically low on available space, the PC Health indicator displays a critical icon.
	Unknown	A computer that is powered on, but the health status (Normal, Warning, or Critical) is not known.
	Normal (Mobile)	A computer that includes support for mobile PC features, such as mobile battery. Mobile computers display the same array of health icons (above) used for non-mobile computers.

VI. SOFTWARE REFERENCE

ASUS PC Probe

ASUS PC Probe is a convenient utility to monitor the computer system's vital components: fan rotations, voltages, and temperatures.

Starting ASUS PC Probe

When ASUS PC Probe starts, a splash screen appears allowing you to “Show Monitor” or “Hide”. You can select whether you want the splash screen to show the next time it opens.



Click **ASUS PC Probe** from the **Start** button to run the utility if you exit the utility or did not set it to “Run when Windows Starts.”

The PC Probe icon  will appear on the taskbar's system tray indicating that ASUS PC Probe is running. Left-clicking the icon will allow you to see your PC status.



VI. SOFTWARE REFERENCE

Using the ASUS PC Probe

Fan Rotation Status

- Analog view of PC's fan rotation
- Digital view of PC's fan rotation
- PC's Fan warning threshold adjustment



PC Temperature Status

- Temperature Warning threshold adjustment
- Analog view of PC's temperature
- Digital view of PC's temperature
- Digital view of PC's temperature warning threshold



PC Voltage Status

- Upper warning threshold adjustment
- Analog view of PC's voltages
- Lower warning threshold adjustment
- Digital view of PC's voltages
- Digital view of PC's voltage warning thresholds



PC Status Summary

- PC's Fan Rotations per minute
- PC's Temperature °C/°F
- PC's Voltages



VI. SOFTWARE REFERENCE

Using the ASUS PC Probe

PC Probe System Info.



Get information on your mainboard and BIOS from this screen.



PC Probe Settings



Change PC Probe refresh times here

Click here to start PC Probe each time you enter Windows.

Click the items you wish to reset to its default values and click this button.



PC Probe Task Bar Icon

Right clicking the PC Probe icon will bring up a menu to turn on, off, or exit ASUS PC Probe.



The icon appears dimmed when off or unavailable.



When there is a problem, the icon's head mirror flashes red, the PC speaker beeps, and the ASUS PC Probe monitor is displayed.

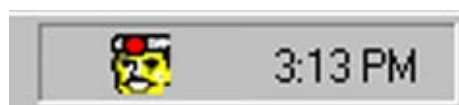

VI. SOFTWARE REFERENCE

SiS 530 Display Properties

The built-in 2D/3D AGP VGA on the SiS 530 AGPset supports professional graphics design, gaming, learning, and business applications.

To open the **SiS 530 Properties** dialog box, click **Start**, point to **Settings**, click **Control Panel**, double-click **Display**, click the **Settings** tab, and then the **Advanced** button.

General

This displays the current font size of the selected monitor. To use a different font size, click the arrow, and then click the font size you want.

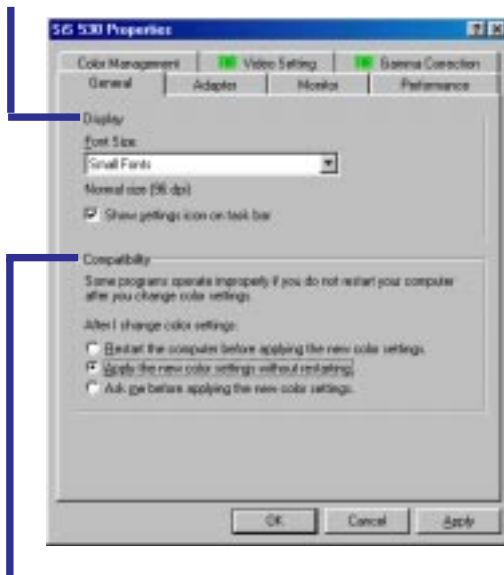

Specifies that you want your computer to apply changes to system color settings without restarting. **NOTE:** Some programs might not display colors correctly without being restarted after you make changes. To avoid this problem, close the program, change the color settings, and then open the program again.

Adapter

Shows what type of display adapter you are currently using. To install the software for a new display adapter, click **Change**.



Monitor

Shows what type of monitor you are currently using. To install the software for a new monitor, click **Change**.

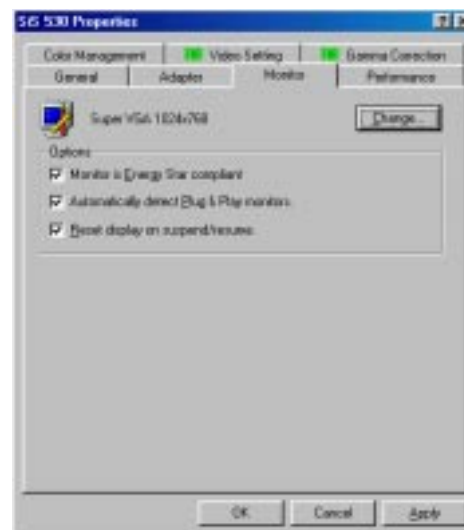

VI. SOFTWARE REFERENCE

Performance

Specifies the degree of acceleration you want for your graphics hardware. Full acceleration is the fastest and is recommended for most computers. If your computer is having problems and you suspect graphics acceleration to be the cause, use the highest setting at which you do not have problems.

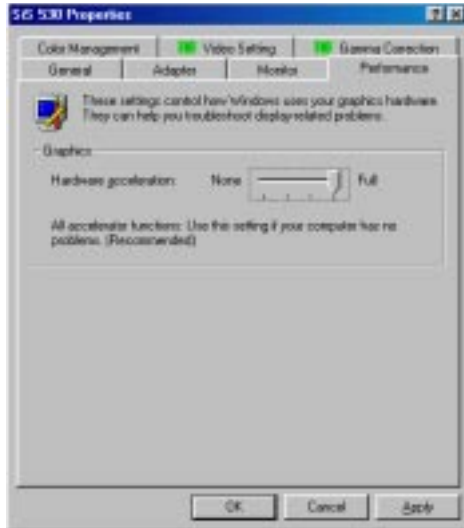

Video Setting

Allows you to adjust the brightness and contrast of the screen output. This function is available only in 16-bit color (high color, 65K-color) and 32-bit (true color plus 8 bits for an alpha channel, 16.7M-color) color depths.



Color Management

Lists all the color profile currently associated with your monitor. Click a profile to make it the active profile. Otherwise, the default profile is the active profile.

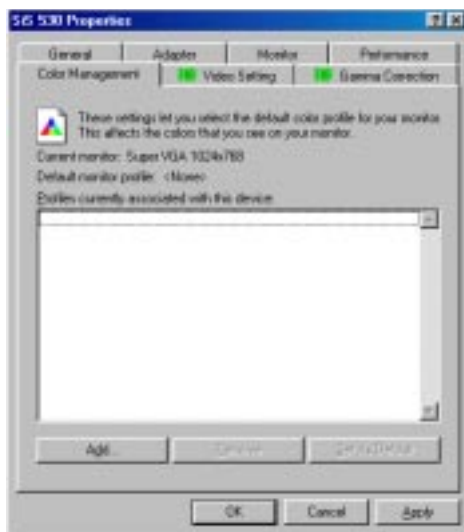

Gamma Correction

Allows you to adjust the quality of your display according to your preference. Gamma correction is available only in 16-bit color and 24-bit color (true color, 16.7M-color) modes. In 16-bit color and 8-bit color (standard color, 256-color) modes, gamma correction function is not supported.

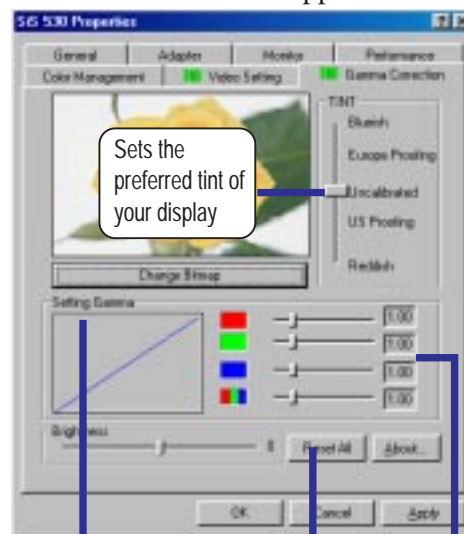

Sets your monitor's color mapping

Restores settings to the original program default

Allows adjustment of individual channel

VI. SOFTWARE REFERENCE

Creative Multimedia Decks

Creative Multimedia Decks is a collection of players that allows you to independently or concurrently control multimedia devices such as your CD-ROM drive and MIDI device. It consists of Creative Remote and other players such as Creative CD, Creative Wave, and Creative MIDI.

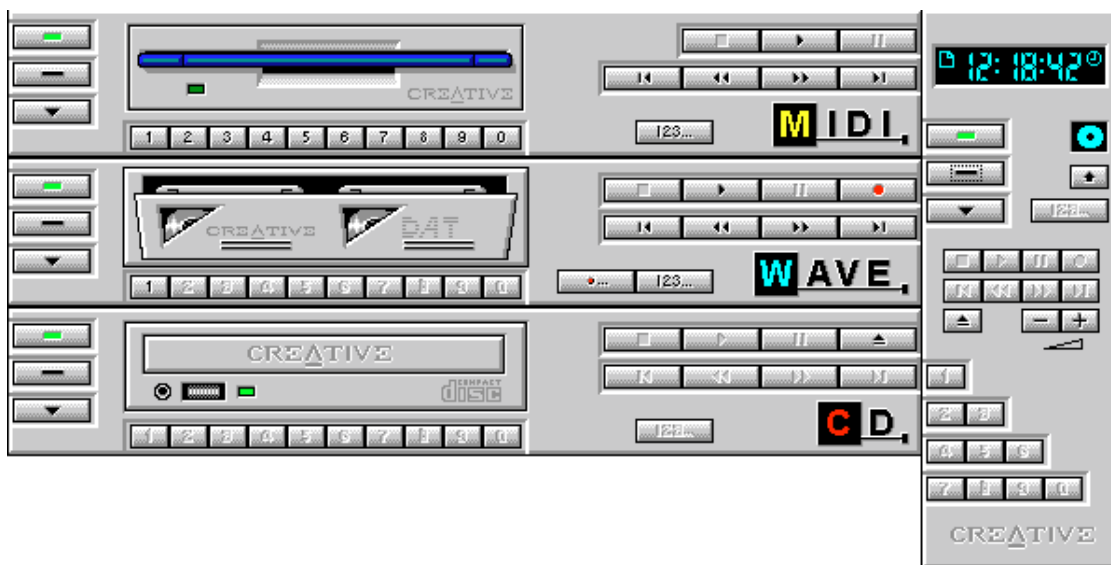

Common operations

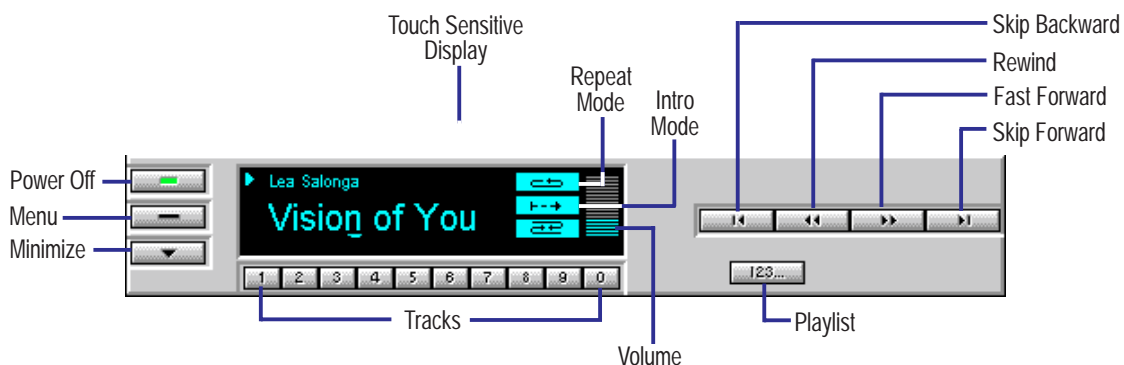

NOTE: The terms "track" and "file" are used interchangeably throughout this section.

VI. SOFTWARE REFERENCE

Creative CD Player

Creative CD operates like a home CD player, letting you play audio CDs from CD-ROM drives on your PC. In addition, it has some advanced features which include:

- Ability to be controlled by the Creative Remote
- OLE Automation support
- Plug and Play support
- Power management support
- "Touch-sensitive" display
- Multiple display forms
- Fine control of track's playing position
- Introduction Mode, Repeat Playlist Mode, Repeat Track Mode and Shuffle Mode for playback
- Playlist compilation of CD tracks into a collection
- Fast track selection
- Direct volume control for multiple sound cards

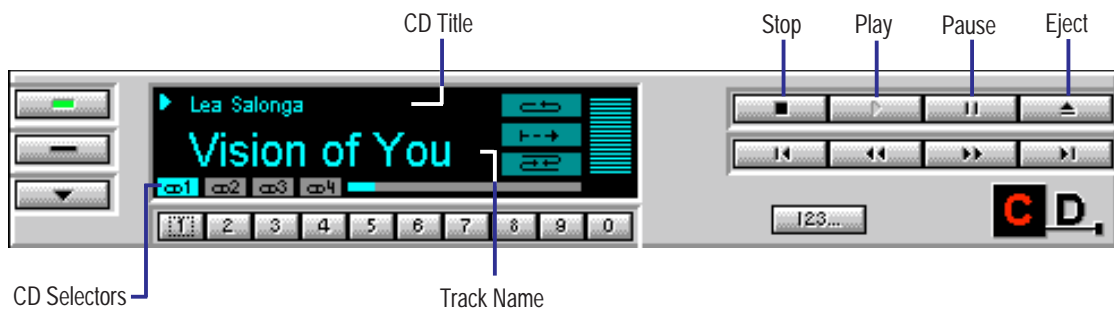

Using the CD Playlist

To access the Playlist dialog box, click **123...** on the CD player.

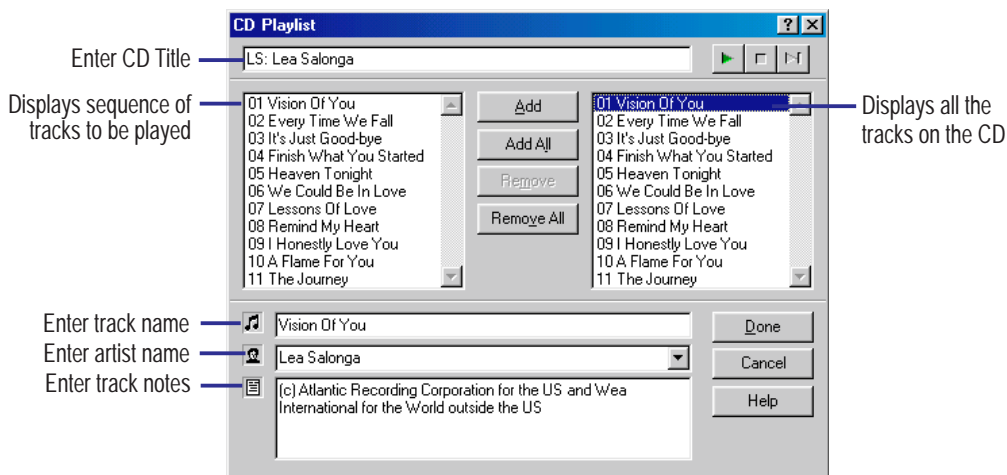

VI. SOFTWARE REFERENCE

Creative MIDI Player

Creative MIDI is the player in the Multimedia Decks suite of players that lets you play MIDI files. It also has some advanced features which include:

- Ability to be controlled by the Creative Remote
- OLE Automation support
- Plug and Play support
- Power management support
- "Touch-sensitive" display
- Multiple display forms
- Fine control of a track's playing position
- Introduction Mode, Repeat Playlist Mode, Repeat Track Mode and Shuffle Mode for playback
- Playlist compilation of different MIDI files
- Fast track selection
- Direct volume control for multiple sound cards



Using the MIDI Playlist

To access the Playlist dialog box, click **123...** on the MIDI player.

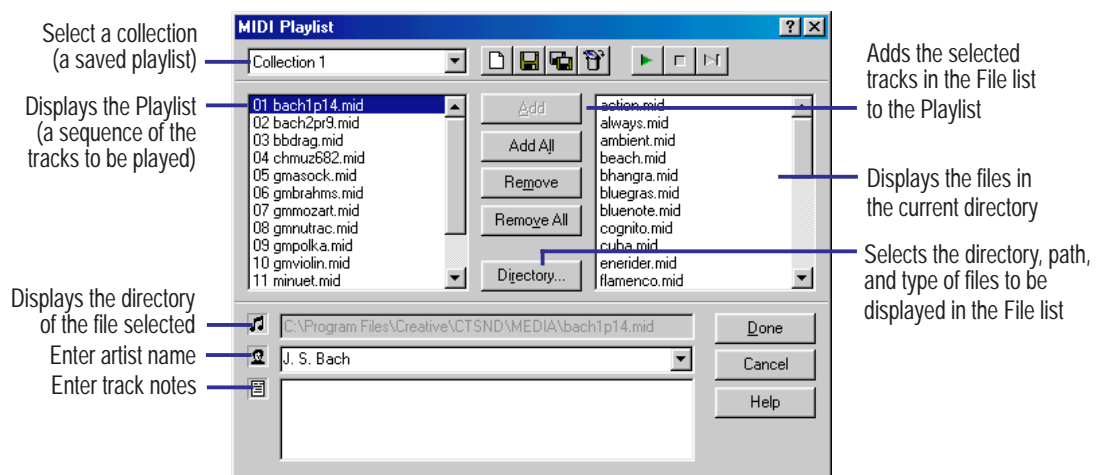

VI. SOFTWARE REFERENCE

Creative Remote

Creative Remote is the main component of the Creative Multimedia Decks group of players. Like a home remote control, it lets you control different Creative Multimedia Decks players from a single control interface. If you require more control over a player, you can also invoke the player from Creative Remote.

In addition, it consists of several advanced features like:

- Ability to launch any of the available Creative Multimedia Decks players for more direct control over a device
- "Touch-sensitive" display
- Multiple display forms
- Fast track selection
- Color scheme selection

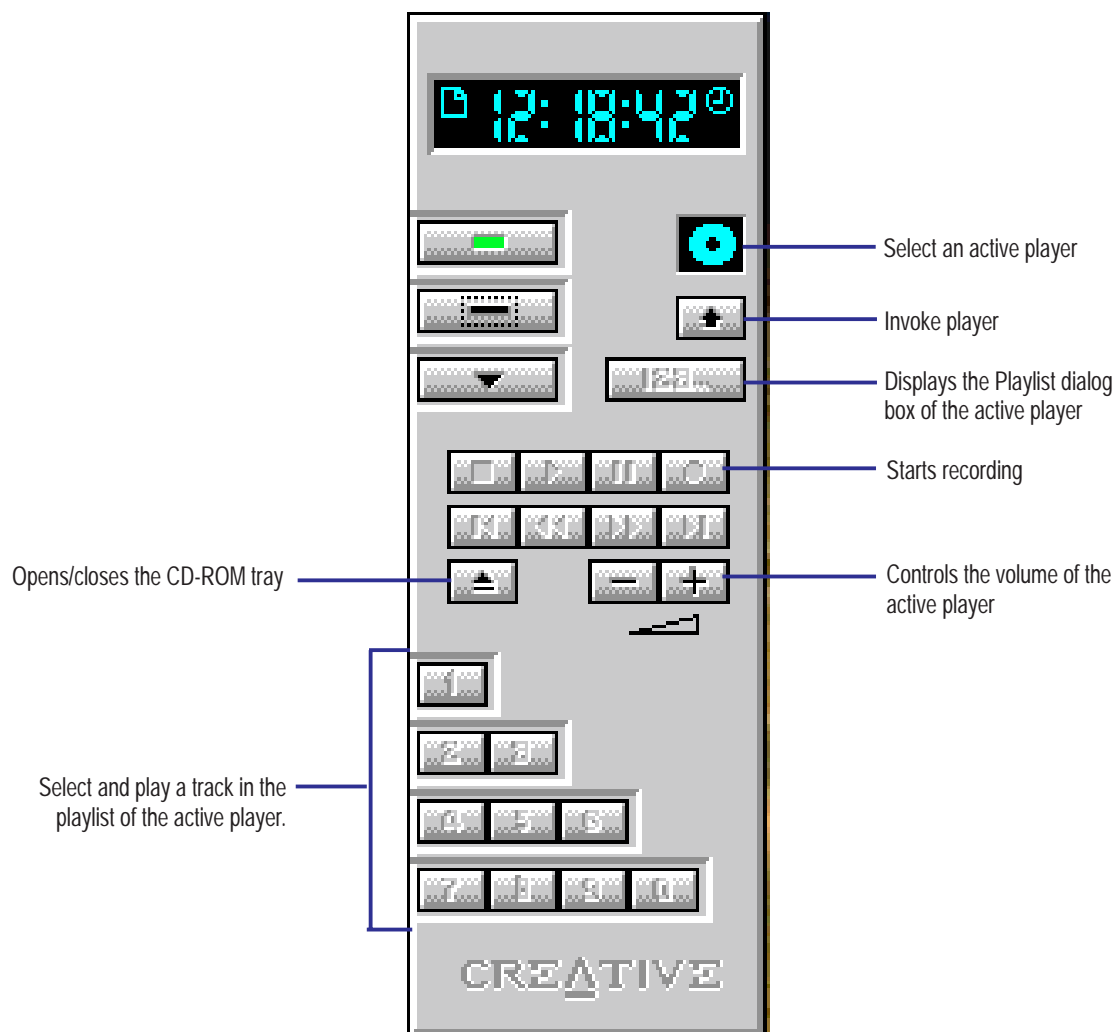

VI. SOFTWARE REFERENCE

Creative Wave Player

Creative Wave is the player in the Creative Multimedia Decks suite of players that lets you play wave files. It also has some advanced features which include:

- Ability to be controlled by the Creative Remote
- OLE Automation support
- Plug and Play support
- Power management support
- "Touch-sensitive" display
- Multiple display forms
- Fine control of a track's playing position
- Introduction Mode, Repeat Playlist Mode, Repeat Track Mode and Shuffle Mode for playback
- Playlist compilation of different wave files
- Fast track selection
- Direct volume control for multiple sound cards



Activates the Record Setting dialog box which allows you to select the format of the wave file to record.

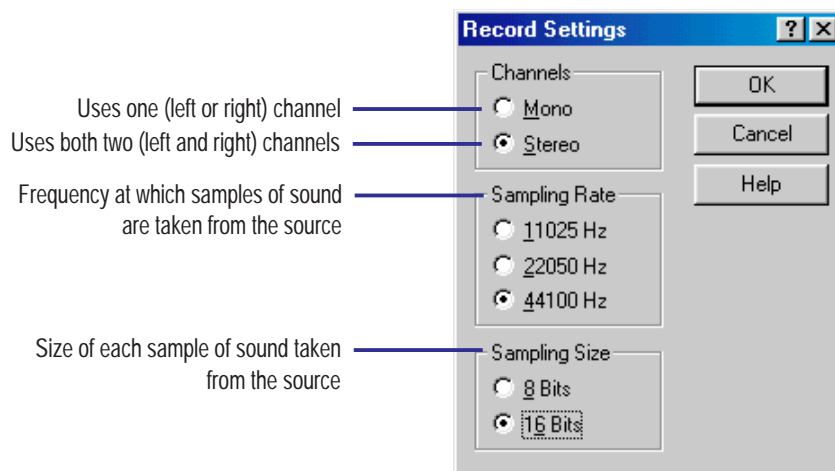

VI. SOFTWARE REFERENCE

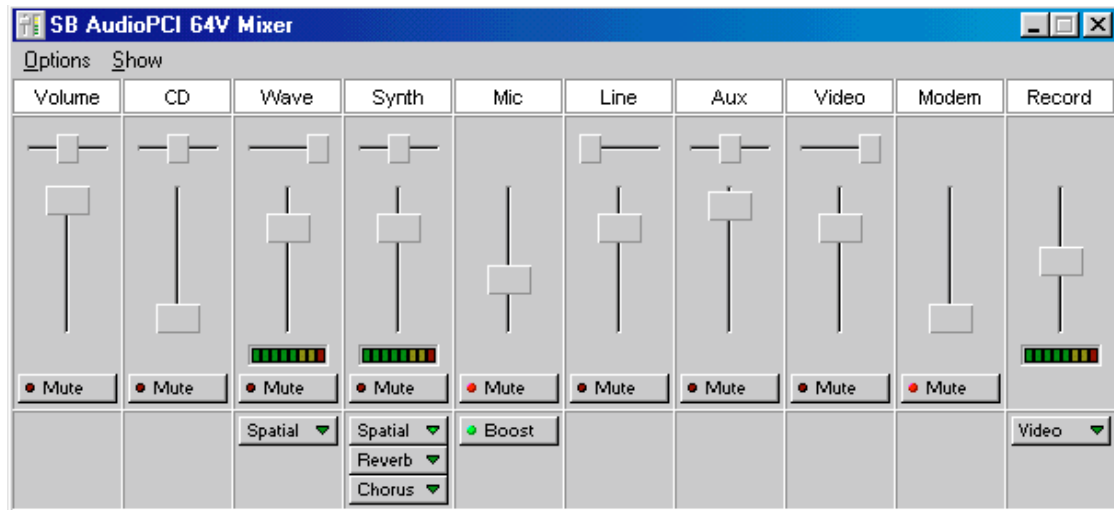

SB AudioPCI 64V Mixer

A mixer has been included for Sound Blaster AudioPCI 64V. This mixer accommodates some features found on the AudioPCI card. These features are unavailable through the Windows 95/98 mixer.



Real-Time Effects

AudioPCI supports real-time effects. In addition to the effects described below, more effects may be available in the future.

-  This effect provides a surround-sound effect. There is a drop-down box on the device panel that will allow you to switch between the three different spatial presets: Off, On, and Wide. By default this switch is set to Off.
-  The reverb effect will make the MIDI instruments on the card sound as if they were playing in a large concert hall or stadium. The three degrees of reverb provided are Off, On, and Full. This effect can be applied to the Synthesizer device.
-  The chorus effect will add depth to the card's synthesizer sounds. The three settings for chorus are Off, On, and Full. This effect can be applied to the Synthesizer device. **NOTE:** Chorus is a special effect, which should be used with discretion; it is generally not recommended to leave the chorus effect enabled at all times.

VI. SOFTWARE REFERENCE

Creative WaveStudio

WaveStudio is a Windows-based application that allows you to perform the following sound editing functions easily:

- Play, edit, and record 8-bit (tape quality) and 16-bit (CD quality) wave data.
- Enhance your wave data or create unique sounds with various special effects and editing operations such as rap, reverse, echo, mute, pan, cut, copy, and paste.
- Open and edit several wave files at the same time.
- Import and export raw (.RAW) data files.

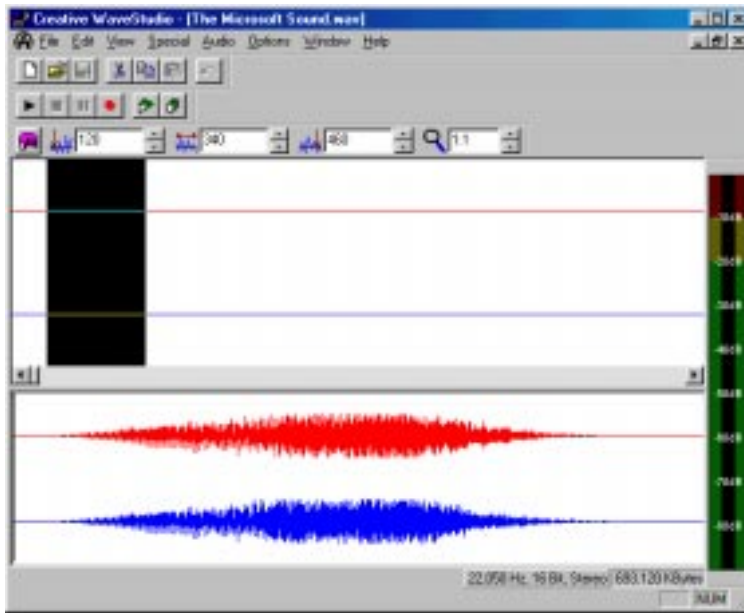

Creative Soundo'LE

Soundo'LE plays and records wave data. It supports Object Linking and Embedding (OLE) 2.0, allows playback of .WAV files of any format, allows recording of sounds from all available sound sources into .WAV files, and allows drag-and-drop support, as OLE objects, from Soundo'LE into other OLE clients.

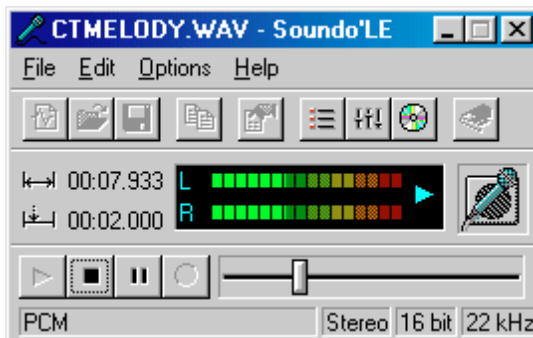

VI. SOFTWARE REFERENCE

Desktop Management Interface (DMI)

Introducing the ASUS DMI Configuration Utility

This motherboard supports DMI within the BIOS level and provides a DMI Configuration Utility to maintain the Management Information Format Database (MIFD). DMI is able to auto-detect and record information pertinent to a computer's system such as the CPU type, CPU speed, and internal/external frequencies, and memory size. The onboard BIOS will detect as many system information as possible and store those collected information in a 4KB block in the motherboard's Flash EPROM and allow the DMI to retrieve data from this database. Unlike other BIOS software, the BIOS on this motherboard uses the same technology implemented for Plug and Play to allow dynamic real-time updating of DMI information versus creating a new BIOS image file and requiring the user to update the whole BIOS. This DMI Configuration Utility also allows the system integrator or end user to add additional information into the MIFD such as serial numbers, housing configurations, and vendor information. Those information not detected by the motherboard BIOS and has to be manually entered through the DMI Configuration Utility and updated into the MIFD. This DMI Configuration Utility provides the same reliability as PnP updating and will prevent the refreshing failures associated with updating the entire BIOS.

Starting the ASUS DMI Configuration Utility

The DMI Configuration Utility (DMICFG2.EXE) must be used in real mode in order for the program to run, the base memory must be at least 180K. Memory managers like HIMEM.SYS (required by windows) must not be installed. You can boot up from a system diskette without AUTOEXEC.BAT and CONFIG.SYS files, "REM" HIMEM.SYS in the CONFIG.SYS, or press <Shift>+<F5> during bootup to bypass your AUTOEXEC.BAT and CONFIG.SYS files.

1. In Windows, copy DMICFG2.EXE to your hard disk drive.
2. Restart your computer and press <Shift>+<F5> during bootup to enter safe mode command prompt.
3. Go to the directory containing DMICFG2.EXE.
4. Type DMICFG2 and press <Enter> to run.

VI. SOFTWARE REFERENCE

Using the ASUS DMI Configuration Utility

NOTE: The following screen displays are provided as examples only and may not reflect the screen contents on your system.

Edit DMI (or delete)



Use the ←→ (left-right) cursors to move the top menu items and the ↑↓ (up-down) cursor to move between the left hand menu items. The bottom of the screen will show the available keys for each screen. Press enter at the menu item to enter the right hand screen for editing. “Edit component” appears on top. The reversed color field is the current cursor position and the blue text are available for editing. The orange text shows auto-detected information and are not available for editing. The blue text “Press [ENTER] for detail” contains a second pop-up menu is available, use the + - (plus-minus) keys to change the settings. Enter to exit *and save*, ESC to exit *and not save*.

If the user has made changes, ESC will prompt you to answer Y or N. Enter Y to go back to the left-hand screen *and save*, enter N to go back to left-hand screen and *not save*. If editing has not been made, ESC will send you back to the left hand menu without any messages.

Notes

A heading, *** BIOS Auto Detect ***, appears on the right for each menu item on the left side that has been auto detected by the system BIOS.

A heading, *** User Modified ***, will appear on the right for menu items that have been modified by the user.



VI. SOFTWARE REFERENCE

Save MIFD



You can save the MIFD (normally only saved to flash ROM) to a file by entering the drive and path here. If you want to cancel save, you may press ESC and a message “Bad File Name” appears here to show it was not saved.

Load MIFD



You can load the disk file to memory by entering a drive and path and file name here.

Load BIOS Defaults



You can load the BIOS defaults from a MIFD file and can clear all user modified and added data. You must reboot your computer in order for the defaults to be saved back into the Flash BIOS.

(This page was intentionally left blank.)

VII. APPENDIX

ASUS PCI-L101 Fast Ethernet Card

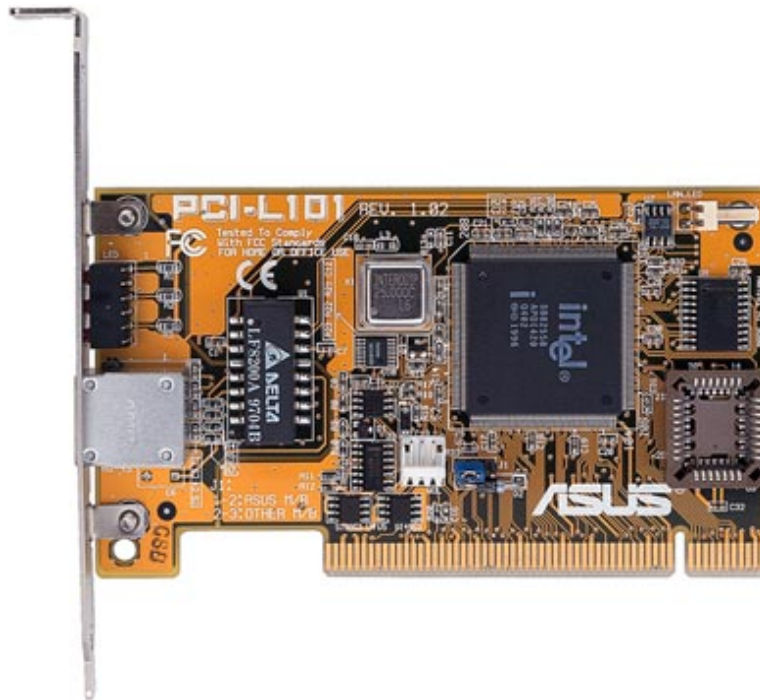

VII. APPENDIX
ASUS LAN Card

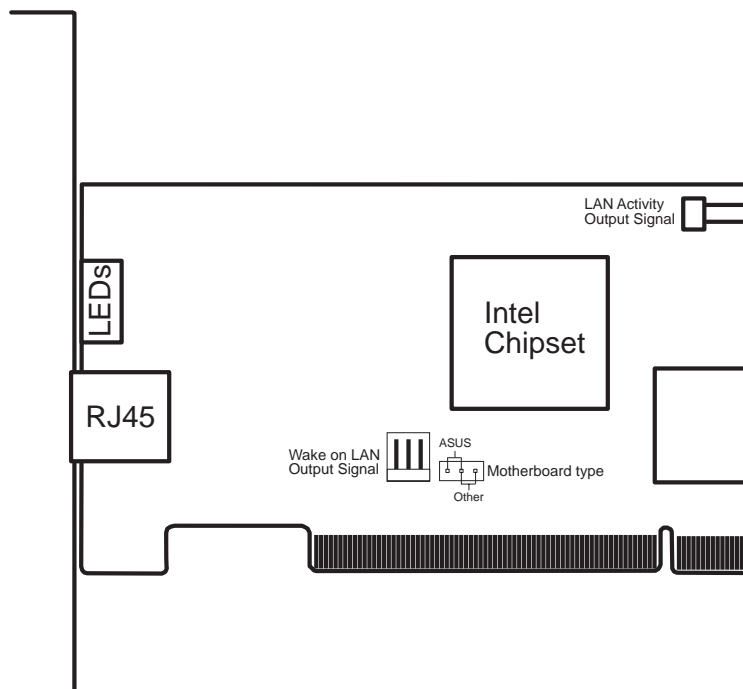

If you are using the ASUS PCI-L101 on an ASUS motherboard, leave the jumper on its default setting of “ASUS.” If you are using another brand of motherboard, set the jumper to “Other.” Connect the Wake on LAN (WOL) output signal to the motherboard’s WOL_CON in order to utilize the wake on LAN feature of the motherboard. Connect the LAN activity output signal (LAN_LED) to the system cabinet’s front panel LAN_LED in order to display the LAN data activity.

VII. APPENDIX

Features

- Intel 82558 Ethernet LAN Controller (Fully integrated 10BASE-T/100BASE-TX)
- Wake-On-LAN Remote Control Function Supported
- PCI Bus Master Complies to PCI Local Bus Rev. 2.1 specifications
- Consists of MAC & PHY (10/100Mbps) interfaces
- Complies to IEEE 802.3 10BASE-T and IEEE 802.3u 100BASE-TX interfaces
- Fully supports 10BASE-T & 100BASE-TX operations through a single RJ45 port
- Supports 32-bit Bus Master Technology / PCI Rev. 2.1
- Enhancements on ACPI & APM
- Adheres to PCI Bus Power Management Interface Rev. 1.0, ACPI Rev. 1.0, and Device Class Power Management Rev. 1.0
- IEEE 802.3u auto-negotiation for 10Mbps/100Mbps Network Data Transfer Rates.
- Provides LED indicators for monitoring network conditions
- Plug and Play

Software Driver Support

- **NetWare ODI Drivers** - Novell Netware 3.x, 4.x, DOS, OS/2 Client
- **NDIS 2.01 Drivers** - Microsoft LAN Manager, Microsoft Windows 3.11, IBM LAN Server
- **NDIS 3.0 Drivers** - Microsoft Windows NT, Microsoft Windows 95, Microsoft Windows 3.11

Question and Answer

Q: What is Wake-On-LAN ?

A: The Wake-On-LAN feature provides the capability to remotely power on systems supporting Wake-On-LAN by simply sending a wake-up frame. With this feature, remotely uploading/downloading data to/from systems during off-peak hours will be feasible.

Q: What can Wake-On-LAN do for you ?

A: Wake-On-LAN is a remote management tool with advantages that can reduce system management workload, provide flexibility to the system administrator's job, and then of course save you time-consuming efforts and costs.

Q: What components does Wake-On-LAN require to be enable?

A: To enable Wake-On-LAN function, your system requires Ethernet LAN adapter card that can activate Wake-On-LAN function, a client with Wake-On-LAN capability, and software such as LDCM Rev. 3.10 or up that can trigger wake-up frame.