

P5AD2
Deluxe

ASUS[®]

Motherboard

E1672

**First Edition
June 2004**

Copyright © 2004 ASUSTeK COMPUTER INC. All Rights Reserved.

No part of this manual, including the products and software described in it, may be reproduced, transmitted, transcribed, stored in a retrieval system, or translated into any language in any form or by any means, except documentation kept by the purchaser for backup purposes, without the express written permission of ASUSTeK COMPUTER INC. (“ASUS”).

Product warranty or service will not be extended if: (1) the product is repaired, modified or altered, unless such repair, modification or alteration is authorized in writing by ASUS; or (2) the serial number of the product is defaced or missing.

ASUS PROVIDES THIS MANUAL “AS IS” WITHOUT WARRANTY OF ANY KIND, EITHER EXPRESS OR IMPLIED, INCLUDING BUT NOT LIMITED TO THE IMPLIED WARRANTIES OR CONDITIONS OF MERCHANTABILITY OR FITNESS FOR A PARTICULAR PURPOSE. IN NO EVENT SHALL ASUS, ITS DIRECTORS, OFFICERS, EMPLOYEES OR AGENTS BE LIABLE FOR ANY INDIRECT, SPECIAL, INCIDENTAL, OR CONSEQUENTIAL DAMAGES (INCLUDING DAMAGES FOR LOSS OF PROFITS, LOSS OF BUSINESS, LOSS OF USE OR DATA, INTERRUPTION OF BUSINESS AND THE LIKE), EVEN IF ASUS HAS BEEN ADVISED OF THE POSSIBILITY OF SUCH DAMAGES ARISING FROM ANY DEFECT OR ERROR IN THIS MANUAL OR PRODUCT.

SPECIFICATIONS AND INFORMATION CONTAINED IN THIS MANUAL ARE FURNISHED FOR INFORMATIONAL USE ONLY, AND ARE SUBJECT TO CHANGE AT ANY TIME WITHOUT NOTICE, AND SHOULD NOT BE CONSTRUED AS A COMMITMENT BY ASUS. ASUS ASSUMES NO RESPONSIBILITY OR LIABILITY FOR ANY ERRORS OR INACCURACIES THAT MAY APPEAR IN THIS MANUAL, INCLUDING THE PRODUCTS AND SOFTWARE DESCRIBED IN IT.

Products and corporate names appearing in this manual may or may not be registered trademarks or copyrights of their respective companies, and are used only for identification or explanation and to the owners’ benefit, without intent to infringe.

Contents

Notices	vi
Safety information	vii
About this guide	viii
Typography	ix
P5AD2 Deluxe specifications summary	x

Chapter 1: Product introduction

1.1	Welcome!	1-1
1.2	Package contents	1-1
1.3	Special features	1-2
1.3.1	Product highlights	1-2
1.3.2	ASUS AI Proactive features	1-5
1.3.3	Innovative ASUS features	1-6

Chapter 2: Hardware information

2.1	Before you proceed	2-1
2.2	Motherboard overview	2-2
2.2.1	Placement direction	2-2
2.2.2	Screw holes	2-2
2.2.3	ASUS Stack Cool	2-3
2.2.4	Motherboard layout	2-4
2.2.5	Layout contents	2-5
2.3	Central Processing Unit (CPU)	2-7
2.3.1	Installing the CPU	2-7
2.3.2	Installing the CPU heatsink and fan	2-9
2.4	System memory	2-12
2.4.1	Overview	2-12
2.4.2	Memory configurations	2-12
2.4.3	Installing a DIMM	2-14
2.4.4	Removing a DIMM	2-14
2.5	Expansion slots	2-15
2.5.1	Installing an expansion card	2-15
2.5.2	Configuring an expansion card	2-15
2.5.3	Interrupt assignments	2-16
2.5.4	PCI slots	2-17
2.5.5	PCI Express x16 slot	2-17
2.5.6	PCI Express x1 slot	2-17
2.6	Jumpers	2-18
2.7	Connectors	2-20
2.7.1	Rear panel connectors	2-20
2.7.2	Internal connectors	2-22

Contents

Chapter 3: Powering up

3.1	Starting up for the first time	3-1
3.2	Powering off the computer	3-2
3.2.1	Using the OS shut down function	3-2
3.2.2	Using the dual function power switch	3-2
3.3	ASUS POST Reporter™	3-3
3.3.1	Vocal POST messages	3-3
3.3.2	Winbond Voice Editor	3-5

Chapter 4: BIOS setup

4.1	Managing and updating your BIOS	4-1
4.1.1	Creating a bootable floppy disk	4-1
4.1.2	AFUDOS utility	4-2
4.1.3	ASUS CrashFree BIOS 2 utility	4-5
4.1.4	ASUS EZ Flash utility	4-7
4.1.5	ASUS Update utility	4-8
4.2	BIOS setup program	4-11
4.2.1	BIOS menu screen	4-12
4.2.2	Menu bar	4-12
4.2.3	Navigation keys	4-12
4.2.4	Menu items	4-13
4.2.5	Sub-menu items	4-13
4.2.6	Configuration fields	4-13
4.2.7	Pop-up window	4-13
4.2.8	Scroll bar	4-13
4.2.9	General help	4-13
4.3	Main menu	4-14
4.3.1	System Time	4-14
4.3.2	System Date	4-14
4.3.3	Legacy Diskette A	4-14
4.3.4	Language	4-14
4.3.5	Primary, Third and Fourth IDE Master/Slave	4-15
4.3.6	IDE Configuration	4-16
4.3.7	System Information	4-18
4.4	Advanced menu	4-19
4.4.1	JumperFree Configuration	4-19
4.4.2	LAN Cable Status	4-22
4.4.3	USB Configuration	4-23
4.4.4	CPU Configuration	4-24
4.4.5	Chipset	4-25

Contents

4.4.6	Onboard Devices Configuration	4-27
4.4.7	PCI PnP	4-29
4.4.8	Speech Configuration	4-30
4.5	Power menu	4-31
4.5.1	Suspend Mode	4-31
4.5.2	Repost Video on S3 Resume	4-31
4.5.3	ACPI 2.0 Support	4-31
4.5.4	ACPI APIC Support	4-31
4.5.5	APM Configuration	4-32
4.5.6	Hardware Monitor	4-34
4.6	Boot menu	4-36
4.6.1	Boot Device Priority	4-36
4.6.2	Boot Settings Configuration	4-37
4.6.3	Security	4-38
4.7	Exit menu	4-41

Chapter 5: Software support

5.1	Installing an operating system	5-1
5.2	Support CD information	5-1
5.2.1	Running the support CD	5-1
5.2.2	Drivers menu	5-2
5.2.3	Utilities menu	5-3
5.2.4	Manuals menu	5-5
5.2.5	Contact information	5-5
5.2.6	Other information	5-6
5.3	Software information	5-8
5.3.1	ASUS MyLogo2™	5-8
5.3.2	AI NET2	5-10
5.3.3	C-Media 3D audio configuration	5-11
5.4	RAID configurations	5-16
5.4.1	Installing hard disks	5-17
5.4.2	Silicon Image RAID configurations	5-18
5.4.3	Intel® RAID configurations	5-28
5.4.4	ITE® 8212F RAID configurations	5-32
5.5	Creating a RAID driver disk	5-38

Notices

Federal Communications Commission Statement

This device complies with Part 15 of the FCC Rules. Operation is subject to the following two conditions:

- This device may not cause harmful interference, and
- This device must accept any interference received including interference that may cause undesired operation.

This equipment has been tested and found to comply with the limits for a Class B digital device, pursuant to Part 15 of the FCC Rules. These limits are designed to provide reasonable protection against harmful interference in a residential installation. This equipment generates, uses and can radiate radio frequency energy and, if not installed and used in accordance with manufacturer's instructions, may cause harmful interference to radio communications. However, there is no guarantee that interference will not occur in a particular installation. If this equipment does cause harmful interference to radio or television reception, which can be determined by turning the equipment off and on, the user is encouraged to try to correct the interference by one or more of the following measures:

- Reorient or relocate the receiving antenna.
- Increase the separation between the equipment and receiver.
- Connect the equipment to an outlet on a circuit different from that to which the receiver is connected.
- Consult the dealer or an experienced radio/TV technician for help.



The use of shielded cables for connection of the monitor to the graphics card is required to assure compliance with FCC regulations. Changes or modifications to this unit not expressly approved by the party responsible for compliance could void the user's authority to operate this equipment.

Canadian Department of Communications Statement

This digital apparatus does not exceed the Class B limits for radio noise emissions from digital apparatus set out in the Radio Interference Regulations of the Canadian Department of Communications.

This class B digital apparatus complies with Canadian ICES-003.

Safety information

Electrical safety

- To prevent electrical shock hazard, disconnect the power cable from the electrical outlet before relocating the system.
- When adding or removing devices to or from the system, ensure that the power cables for the devices are unplugged before the signal cables are connected. If possible, disconnect all power cables from the existing system before you add a device.
- Before connecting or removing signal cables from the motherboard, ensure that all power cables are unplugged.
- Seek professional assistance before using an adapter or extension cord. These devices could interrupt the grounding circuit.
- Make sure that your power supply is set to the correct voltage in your area. If you are not sure about the voltage of the electrical outlet you are using, contact your local power company.
- If the power supply is broken, do not try to fix it by yourself. Contact a qualified service technician or your retailer.

Operation safety

- Before installing the motherboard and adding devices on it, carefully read all the manuals that came with the package.
- Before using the product, make sure all cables are correctly connected and the power cables are not damaged. If you detect any damage, contact your dealer immediately.
- To avoid short circuits, keep paper clips, screws, and staples away from connectors, slots, sockets and circuitry.
- Avoid dust, humidity, and temperature extremes. Do not place the product in any area where it may become wet.
- Place the product on a stable surface.
- If you encounter technical problems with the product, contact a qualified service technician or your retailer.

About this guide

This user guide contains the information you need when installing and configuring the motherboard.

How this guide is organized

This manual contains the following parts:

- **Chapter 1: Product introduction**
This chapter describes the features of the motherboard and the new technology it supports.
- **Chapter 2: Hardware information**
This chapter lists the hardware setup procedures that you have to perform when installing system components. It includes description of the switches, jumpers, and connectors on the motherboard.
- **Chapter 3: Powering up**
This chapter describes the power up sequence, the vocal POST messages, and ways of shutting down the system.
- **Chapter 4: BIOS setup**
This chapter tells how to change system settings through the BIOS Setup menus. Detailed descriptions of the BIOS parameters are also provided.
- **Chapter 5: Software support**
This chapter describes the contents of the support CD that comes with the motherboard package.

Where to find more information

Refer to the following sources for additional information and for product and software updates.

1. ASUS websites

The ASUS website provides updated information on ASUS hardware and software products. Refer to the ASUS contact information.

2. Optional documentation

Your product package may include optional documentation, such as warranty flyers, that may have been added by your dealer. These documents are not part of the standard package.

Conventions used in this guide

To make sure that you perform certain tasks properly, take note of the following symbols used throughout this manual.



DANGER/WARNING: Information to prevent injury to yourself when trying to complete a task.



CAUTION: Information to prevent damage to the components when trying to complete a task.



IMPORTANT: Instructions that you **MUST** follow to complete a task.



NOTE: Tips and additional information to help you complete a task.

Typography

Bold text

Indicates a menu or an item to select.

Italics

Used to emphasize a word or a phrase.

<Key>

Keys enclosed in the less-than and greater-than sign means that you must press the enclosed key.

Example: <Enter> means that you must press the Enter or Return key.

<Key1+Key2+Key3>

If you must press two or more keys simultaneously, the key names are linked with a plus sign (+).

Example: <Ctrl+Alt+D>

Command

Means that you must type the command exactly as shown, then supply the required item or value enclosed in brackets.

Example: At the DOS prompt, type the command line:

afudos /i[filename]

afudos /iP5GD2.ROM

P5AD2 Deluxe specifications summary

CPU	LGA775 socket for Intel® Pentium® 4/Celeron processor Compatible with Intel® PCG 04A and 04B processors Supports Intel® Hyper-Threading Technology
Chipset	Northbridge: Intel® 925X Memory Controller Hub (MCH) Southbridge: Intel® ICH6R
Front Side Bus	800/533 MHz
Memory	Dual-channel memory architecture 4 x 240-pin DIMM sockets support unbuffered non-ECC 533/400 MHz DDR2 memory modules Up to 4 GB system memory Native DDR2-600 support
Expansion slots	1 x PCI Express x16 slot 2 x PCI Express x1 slots 3 x PCI slots
Storage	Intel® ICH6R South Bridge supports: <ul style="list-style-type: none"> - 1 x Ultra DMA 100/66/33 - 4 x Serial ATA with RAID 0, RAID 1 configuration and Intel® Matrix Storage Technology Silicon Image 3114R RAID controller supports: <ul style="list-style-type: none"> - 4 x Serial ATA with RAID 0, RAID 1, RAID 10, JBOD and RAID 5 (software patch, no WHQL) configuration ITE 8212F IDE RAID controller supports: <ul style="list-style-type: none"> - 2 x Ultra DMA 133/100/66 IDE - RAID 0, RAID 1, RAID 0+1, and JBOD configuration
Wireless LAN (optional)	WiFi-g™ wireless solution provides: <ul style="list-style-type: none"> - support for IEEE 802.11g/b standards - up to 54Mbps wireless data transmission - Software Access Point (Soft AP) feature on Windows® XP/2003 Server OS
High Definition Audio	Intel® High Definition Audio (HD Audio) C-Media CMI9880 7.1-channel audio CODEC Dolby® Digital Live™ technology support Coaxial and optical S/PDIF out ports
LAN	Marvell® 88E8053 PCI Express™ Gigabit LAN controller Supports Marvell® Virtual Cable Tester technology Supports POST Network-diagnostic program
USB	Supports up to 8 USB 2.0 ports
IEEE 1394	2 x IEEE 1394a ports

(continued on the next page)

P5AD2 Deluxe specifications summary

Overclocking features	<p>ASUS AI Overclocking ASUS NOS (Non-delay Overclocking System) ASUS C.P.R. (CPU Parameter Recall) Adjustable CPU, memory, and PCI Express voltages Stepless Frequency Selection (SFS) from 100MHz up to 400 MHz at 1 MHz increment Adjustable FSB/DDR2 frequencies with fixed PCI/PCI-E frequencies</p>
Special features	<p>ASUS Post Reporter™ ASUS Q-Fan2 ASUS CrashFree BIOS 2 ASUS Multi-language BIOS ASUS MyLogo2 ASUS Stack Cool™ technology</p>
BIOS features	<p>8 MB Flash ROM, AMI BIOS, PnP, DMI2.0, SM BIOS 2.3, WfM2.0</p>
Rear panel	<p>1 x Parallel port 1 x IEEE 1394a port 1 x LAN (RJ-45) port 1 x Wireless LAN antenna port (Wireless edition only) 1 x Wireless LAN LED (Wireless edition only) 4 x USB 2.0 ports 1 x Optical S/PDIF Out port 1 x Coaxial S/PDIF Out port 1 x PS/2 keyboard port (purple) 1 x PS/2 mouse port (green) 8-channel audio ports</p>
Internal connectors	<p>1 x Floppy disk drive connector 1 x Primary IDE connector 2 x IDE RAID connectors 8 x Serial ATA RAID connectors 1 x Optical drive audio connector 1 x Front panel audio connector 2 x USB connectors 1 x IEEE 1394a port connectors 1 x GAME/MIDI port connector 1 x Serial port connector Chassis intrusion connector CPU, chassis (x2), and power fan connectors ATX power connectors (24-pin and 4-pin) System panel connector</p>
Power Requirement	<p>ATX power supply (with 24-pin and 4-pin 12 V plugs) ATX 12V 2.0 compliant</p>

(continued on the next page)

P5AD2 Deluxe specifications summary

Form Factor	ATX form factor: 12 in x 9.6 in (30.5 cm x 24.4 cm)
Support CD contents	Device drivers ASUS PC Probe ASUS Live Update Utility ASUS WiFi-g™ One-Touch Wizard Anti-virus software

**Specifications are subject to change without notice.*

This chapter describes the motherboard features and the new technologies it supports.

Product introduction



Chapter summary



1.1	Welcome!	1-1
1.2	Package contents	1-1
1.3	Special features	1-2

1.1 Welcome!

Thank you for buying an ASUS® P5AD2 Deluxe motherboard!

The motherboard delivers a host of new features and latest technologies, making it another standout in the long line of ASUS quality motherboards!

Before you start installing the motherboard, and hardware devices on it, check the items in your package with the list below.

1.2 Package contents

Check your motherboard package for the following items.

Motherboard	ASUS P5AD2 Deluxe motherboard
I/O modules	Serial port module USB 2.0 (2 ports) and GAME (1 port) module
Cables	6 x Serial ATA signal cables 3 x Serial ATA power cables (dual plugs) 2 x Ultra DMA/133 cables 80-conductor IDE cable Floppy disk drive cable
Accessories	Dipolar wireless LAN antenna (Wireless Edition only) I/O shield
Application CDs	ASUS motherboard support CD InterVideo® WinDVD Suite® Platinum (Retail version only)
Documentation	User guide



If any of the above items is damaged or missing, contact your retailer.

1.3 Special features

1.3.1 Product highlights

Latest processor technology

The motherboard comes with a 775-pin surface mount Land Grid Array (LGA) socket designed for the Intel® Pentium® 4 processor in the 775-land package. The motherboard supports the Intel® Pentium® 4 processor with 800/533 MHz Front Side Bus (FSB). The motherboard also supports the Intel® Hyper-Threading Technology and is fully compatible with Intel® 04B and 04A processors. See page 2-7 for details.

Intel® 925X chipset

The Intel® 925X Memory Controller Hub (MCH) and the ICH6R I/O controller hub provide the vital interfaces for the motherboard. The MCH supports the Intel® Performance Accelerating Technology (PAT) that boosts system performance. The MCH also provides the processor, dual-channel memory, and PCI Express interfaces.

The Intel® ICH6R Southbridge represents the sixth generation I/O controller hub that provides the interface for the PCI Express and 8-channel high definition audio.

DDR2 memory support

The motherboard supports DDR2 memory which features data transfer rates of 533/400 MHz to meet the higher bandwidth requirements of the latest 3D graphics, multimedia, and Internet applications. The dual-channel DDR2 architecture doubles the bandwidth of your system memory to boost system performance, eliminating bottlenecks with peak bandwidths of up to 8.5 GB/s.

Serial ATA technology

The motherboard supports the Serial ATA technology through the Serial ATA interfaces and the Intel® ICH6R. The SATA specification allows for thinner, more flexible cables with lower pin count, reduced voltage requirement, and up to 150 MB/s data transfer rate. See page 2-24 and 2-25 for details.

Triple RAID solution

Onboard RAID controllers provide the motherboard with multi-RAID functionality that allows you to select the best RAID solution using IDE or Serial ATA devices.

The Intel® ICH6R allows RAID 0 and RAID 1 configuration for four SATA connectors and supports the Intel® Matrix Storage Technology. See page 2-24 for details.

The Sil3114R controller supports four additional SATA connectors and allows RAID 0, RAID 1, RAID 10, JBOD, and a software patch to support RAID 5. See page 2-25 for details.

If you are using IDE hard disk drives, the ITE8212 controller provides RAID 0, RAID 1, RAID 0+1, and JBOD functionality for two IDE channels that supports for up to four IDE hard disk drives. See page 2-23 for details.

PCI Express™ interface

The motherboard fully supports PCI Express, the latest I/O interconnect technology that speeds up the PCI bus. PCI Express features point-to-point serial interconnections between devices and allows higher clockspeeds by carrying data in packets. This high speed interface is software compatible with existing PCI specifications. See page 2-17 for details.

8-channel high definition audio

Onboard is the C-Media CMI9880 7.1-channel audio CODEC. This CODEC is fully-compliant with Intel® High Definition Audio standard (192 KHz, 24-bit audio). With the CODEC, 8-channel audio ports, and S/PDIF interfaces, you can connect your computer to home theater decoders to produce crystal-clear digital audio.

The CMI9880 CODEC comes with a software application that features jack detection to monitor the plugging status of each jack, impedance sensing to determine audio device classes, and pre-defined equalization for various audio devices. See page 2-21, 2-22, and 5-11 for details.

Dolby® Digital Live™

The CMI9880 audio CODEC comes with an AC-3 encoder capable of transforming your computer's digital audio contents into real-time Dolby® Digital stream. This digital stream passes through the S/PDIF out interfaces to an AC-3 decoder for 7.1-channel playback. See page 5-15 for details.

S/PDIF digital sound ready

The motherboard supports the S/PDIF In/Out function through the S/PDIF interfaces on the rear panel and at midboard. The S/PDIF technology turns your computer into a high-end entertainment system with digital connectivity to powerful audio and speaker systems. See page 2-21 for details.

IEEE 1394a support

The motherboard supports the IEEE 1394 interface that provides high-speed and flexible PC connectivity to a wide range of peripherals and devices compliant to IEEE 1394 standards. The IEEE 1394 interface allows up to 400Mbps transfer rates through simple, low-cost, high-bandwidth asynchronous (real-time) data interfacing between computers, peripherals, and consumer electronic devices such as camcorders, VCRs, printers, TVs, and digital cameras. See page 2-20 and 2-28 for details.

USB 2.0 technology

The motherboard implements the Universal Serial Bus (USB) 2.0 specification, dramatically increasing the connection speed from the 12 Mbps bandwidth on USB 1.1 to a fast 480 Mbps on USB 2.0. USB 2.0 is backward compatible with USB 1.1. See page 2-21 and 2-27 for details.

Gigabit and wireless LAN solutions

The motherboard comes with an onboard Gigabit and wireless LAN controllers to provide a total solution for your networking needs. The Gigabit LAN controller uses the PCI Express segment to provide faster data bandwidth. The onboard wireless LAN controller supports up to 54 Mbps data transmission for your wireless Internet, LAN, and file sharing requirements. See page 2-20 and 2-21 for details.

Temperature, fan, and voltage monitoring

The CPU temperature is monitored by the ASIC (integrated in the Winbond Super I/O) to prevent overheating and damage. The system fan rotations per minute (RPM) is monitored for timely failure detection. The ASIC monitors the voltage levels to ensure stable supply of current for critical components. See page 4-34 for details.

1.3.2 ASUS AI Proactive features



ASUS Stack Cool™



ASUS Stack Cool™ is an ideal thermal solution that reduces the heat dissipated by large capacitors and motherboard components. By placing a specially designed PCB under the motherboard CPU socket, Stack Cool™ effectively lowers the system temperature by 10° Celsius. Cooler system temperature means more stable system performance, longer component life, and more silent operation. See page 2-3 for details.

ASUS WiFi-g™ (Wireless Edition only)



ASUS WiFi-g™ is an IEEE 802.11g-compliant wireless LAN adapter that allows data transmission of up to 54 Mbps using the 2.4 GHz frequency band. ASUS provides full software application support and a user-friendly wizard to help you set up your wireless local area network effortlessly. The ASUS WiFi-g™ is backward compatible with IEEE 802.11b devices. See page 2-21 and the WiFi-g™ user guide for details.

AI NOS™ (Non-Delay Overclocking System)



ASUS Non-delay Overclocking System™ (NOS) is a technology that auto-detects the CPU loading and dynamically overclocks the CPU speed only when needed. See page 4-22 for details.

AI NET2



AI NET2 is a BIOS-based diagnostic tool that detects and reports Ethernet cable faults and shorts. With this utility, you can easily monitor the condition of the Ethernet cable connected to the LAN (RJ-45) port. During the bootup process, AI NET2 immediately diagnoses the LAN cable and reports shorts and faults up to 100 meters at 1 meter accuracy. See page 4-22 and 5-10 for details.

1.3.3 Innovative ASUS features

ASUS Hyper Path 2 technology

The ASUS Hyper Path 2 technology optimizes the full potential of the Intel® chipset by shortening the latency time between the CPU and the system memory. Enabling Hyper Path 2 on systems with the Intel® PAT improves memory performance without affecting system stability. See page 4-25 for details. See page 4-25 for details.

Native DDR2-600 support

This motherboard offers native DDR2-600 memory support to ensure superior system performance. With current processors supporting 800 MHz FSB, DDR2-600 provides the fastest solution for eliminating system bottlenecks when running system-intensive applications. See page 2-12, 2-13 and 4-20 for details.

CrashFree BIOS 2

This feature allows you to restore the original BIOS data from the support CD in case when the BIOS codes and data are corrupted. This protection eliminates the need to buy a replacement ROM chip. See page 4-5 for details.

ASUS Q-Fan 2 technology

The ASUS Q-Fan 2 technology smartly adjusts the fan speeds according to the system loading to ensure quiet, cool, and efficient operation. See page 4-34 for details.

ASUS POST Reporter™

The motherboard offers a new exciting feature called the ASUS POST Reporter™ to provide friendly voice messages and alerts during the Power-On Self-Tests (POST) informing you of the system boot status and causes of boot errors, if any. The bundled Winbond Voice Editor software lets you to customize the voice messages in different languages. See page 3-3 for details.

ASUS Multi-language BIOS

The multi-language BIOS allows you to select the language of your choice from the available options. The localized BIOS menus allow easier and faster configuration. See page 4-14 for details.

ASUS MyLogo2™

This new feature present in the motherboard allows you to personalize and add style to your system with customizable boot logos. See page 5-8 for details.

This chapter lists the hardware setup procedures that you have to perform when installing system components. It includes description of the jumpers and connectors on the motherboard.

Hardware information



Chapter summary



2.1	Before you proceed	2-1
2.2	Motherboard overview	2-2
2.3	Central Processing Unit (CPU)	2-7
2.4	System memory	2-12
2.5	Expansion slots	2-15
2.6	Jumpers	2-18
2.7	Connectors	2-20

2.1 Before you proceed

Take note of the following precautions before you install motherboard components or change any motherboard settings.



- Unplug the power cord from the wall socket before touching any component.
- Use a grounded wrist strap or touch a safely grounded object or to a metal object, such as the power supply case, before handling components to avoid damaging them due to static electricity.
- Hold components by the edges to avoid touching the ICs on them.
- Whenever you uninstall any component, place it on a grounded antistatic pad or in the bag that came with the component.
- **Before you install or remove any component, ensure that the ATX power supply is switched off or the power cord is detached from the power supply.** Failure to do so may cause severe damage to the motherboard, peripherals, and/or components.

Onboard LED

The motherboard comes with a standby power LED. The green LED lights up to indicate that the system is ON, in sleep mode, or in soft-off mode. This is a reminder that you should shut down the system and unplug the power cable before removing or plugging in any motherboard component. The illustration below shows the location of the onboard LED.

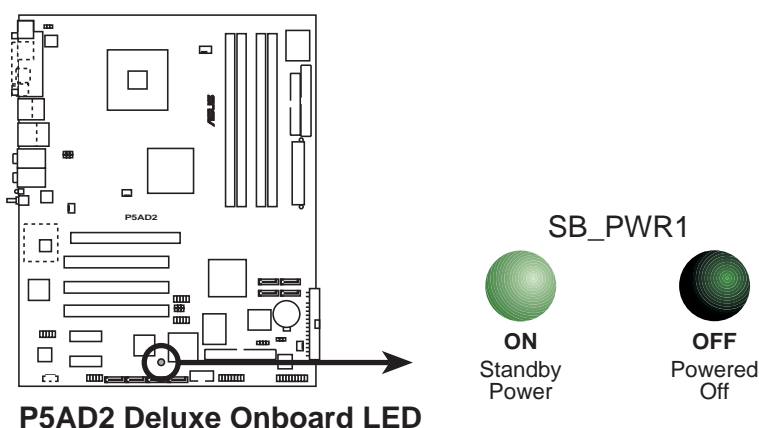

2.2 Motherboard overview

Before you install the motherboard, study the configuration of your chassis to ensure that the motherboard fits into it.



Make sure to unplug the chassis power cord before installing or removing the motherboard. Failure to do so can cause you physical injury and damage motherboard components.

2.2.1 Placement direction

When installing the motherboard, make sure that you place it into the chassis in the correct orientation. The edge with external ports goes to the rear part of the chassis as indicated in the image below.

2.2.2 Screw holes

Place nine (9) screws into the holes indicated by circles to secure the motherboard to the chassis.



Do not overtighten the screws! Doing so can damage the motherboard.

Place this side towards
the rear of the chassis

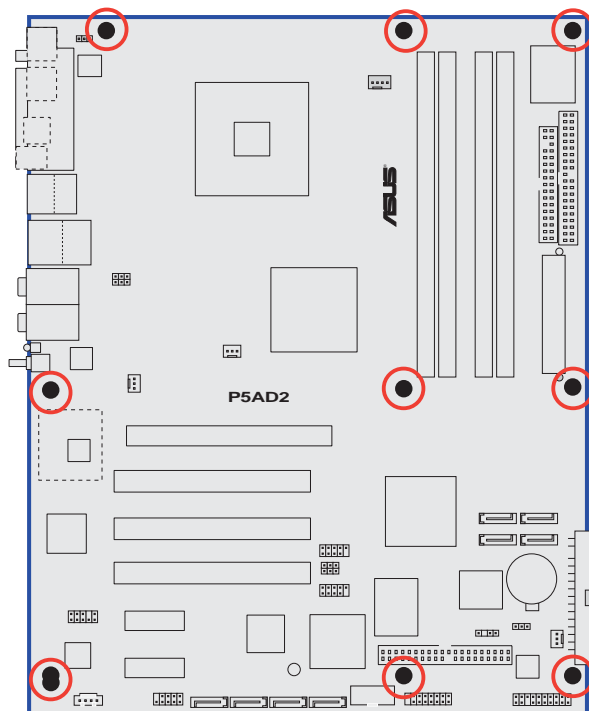

2.2.3 ASUS Stack Cool

The motherboard comes with the ASUS Stack Cool, an innovative thermal solution that provides supplementary cooling to the motherboard. Stack Cool is a mini-PCB installed underneath the motherboard CPU socket to conduct heat away from motherboard components. Stack Cool effectively lowers the motherboard temperature by as much as 10°C.

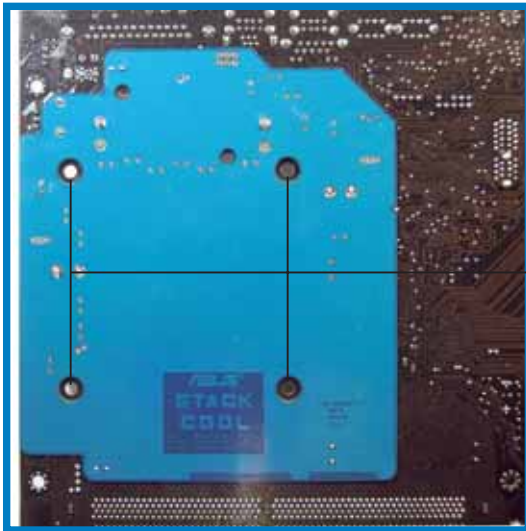

Motherboard holes
(for the CPU fan and
heatsink assembly pins)

2.2.4 Motherboard layout

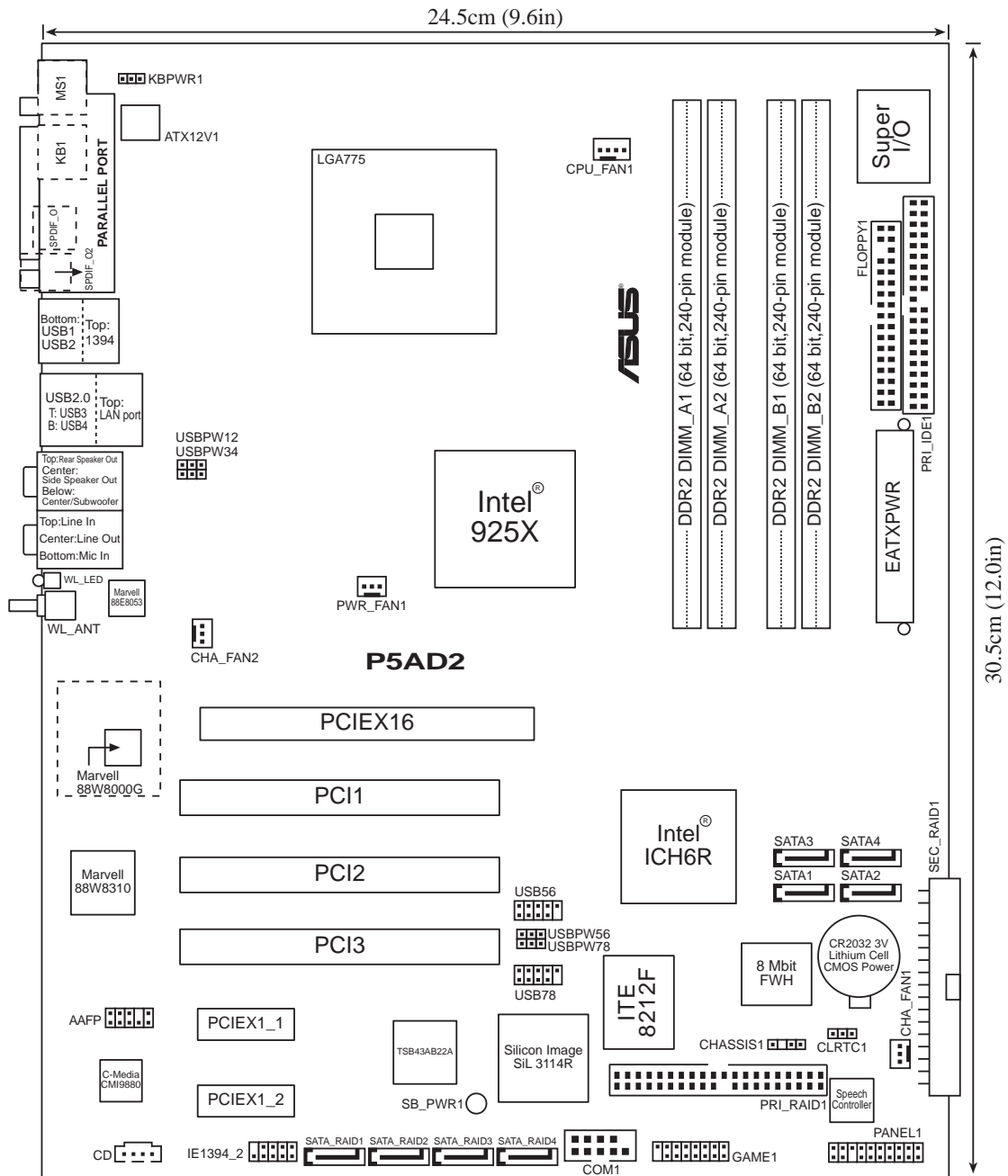

2.2.5 Layout contents

Slots	Page
1. DDR2 DIMM slots	2-12
2. PCI slots	2-17
3. PCI Express slot	2-17

Jumpers	Page
1. Clear RTC RAM (3-pin CLRTC1)	2-18
2. USB Device wake-up (3-pin USBPW12, USBPW34, USBPW56, USBPW78)	2-19
3. Keyboard power (3-pin KBPWR1)	2-19

Rear panel connectors	Page
1. Parallel port	2-20
2. IEEE 1394a port	2-20
3. LAN (RJ-45) port	2-20
4. Rear Speaker Out port (gray)	2-20
5. Side Speaker Out port (black)	2-20
6. Line In port (light blue)	2-20
7. Line Out port (lime)	2-20
8. Wireless LAN antenna port (Wireless Edition only)	2-21
9. Wireless LAN LED (Wireless Edition only)	2-21
10. Microphone port (pink)	2-21
11. Center/Subwoofer port (yellow orange)	2-21
12. USB 2.0 ports 3 and 4	2-21
13. USB 2.0 ports 1 and 2	2-21
14. Optical S/PDIF Out port	2-21
15. Coaxial S/PDIF Out port	2-21
16. PS/2 keyboard port (purple)	2-21
17. PS/2 mouse port (green)	2-21

Internal connectors		Page
1.	Floppy disk drive connector (34-1 pin FLOPPY)	2-22
2.	Primary IDE connector (40-1 pin PRI_IDE1)	2-22
3.	IDE RAID connectors (40-1 pin PRI_RAID1 [blue], SEC_RAID1 [black])	2-23
4.	Serial ATA connectors (7-pin SATA1, SATA2, SATA3, SATA4)	2-24
5.	Serial ATA RAID connectors (7-pin SATA_RAID1, SATA_RAID2, SATA_RAID3, SATA_RAID4)	2-25
6.	Optical drive audio connector (4-pin CD)	2-26
7.	Chassis intrusion connector (4-1 pin CHASSIS1)	2-26
8.	Front panel audio connector (10-1 pin AAFP)	2-27
9.	USB connectors (10-1 pin USB56, USB78)	2-27
10.	IEEE 1394a port connector (10-1 pin IE1394_2)	2-28
11.	GAME/MIDI port connector (16-1 pin GAME1)	2-28
12.	Serial port connector (10-1 pin COM1)	2-29
13.	CPU, Chassis, and Power Fan connectors (3-pin CPU_FAN1, PWR_FAN1, CHA_FAN1, CHA_FAN2)	2-29
14.	ATX power connectors (24-pin EATXPWR1, 4-pin ATX12V1)	2-30
15.	System panel connector (20-pin PANEL1)	2-31
	System power LED (Green 3-pin PLED)	
	Hard disk drive activity LED (Red 2-pin IDE_LED)	
	System warning speaker (Orange 4-pin SPEAKER)	
	ATX power button/soft-off button (Yellow 2-pin PWRSW)	
	Reset button (Blue 2-pin RESET)	

2.3 Central Processing Unit (CPU)

The motherboard comes with a surface mount LGA775 socket designed for the Intel® Pentium® 4 processor in the 775-land package



- Upon purchase of the motherboard, make sure that the LGA775 socket has its cap on and the socket contacts are not bent. If the cap is damaged or missing, or if the socket contacts are bent, contact your retailer immediately.
- Keep the cap after installing the motherboard. ASUS will process Return Merchandise Authorization (RMA) requests only if the motherboard comes with the cap on the LGA775 socket.

2.3.1 Installing the CPU

To install a CPU:

1. Locate the CPU socket on the motherboard.

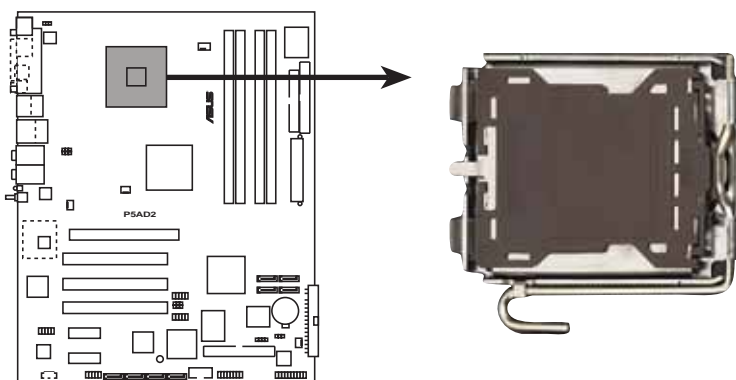

P5AD2 Deluxe Socket 775



Before installing the CPU, make sure that the cam box is facing towards you and the load lever is on your left.

2. Press the load lever with your thumb (a), then move it to the left (b) until it is released from the retention tab.

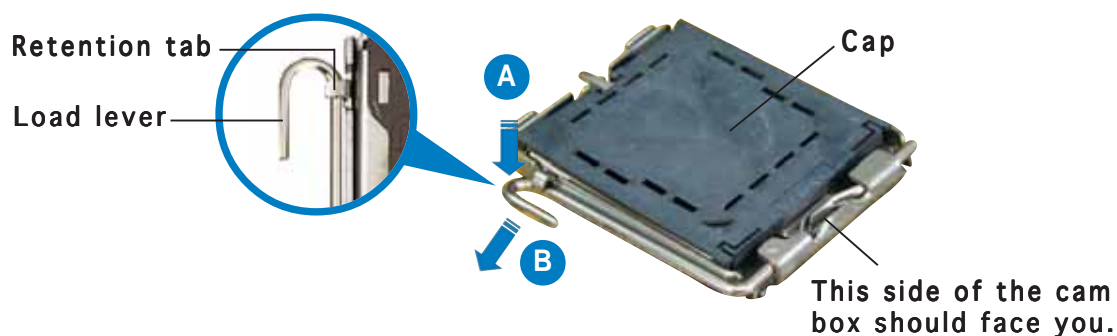



To prevent damage to the socket pins, do not remove the PnP cap unless you are installing a CPU.

3. Lift the load lever in the direction of the arrow to a 135° angle.

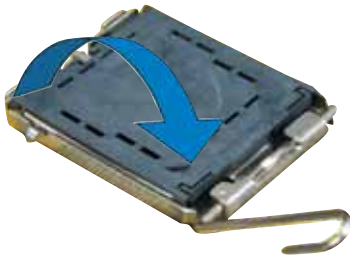

4. Lift the load plate with your thumb and forefinger to a 100° angle (A), then push the PnP cap from the load plate window to remove (B).

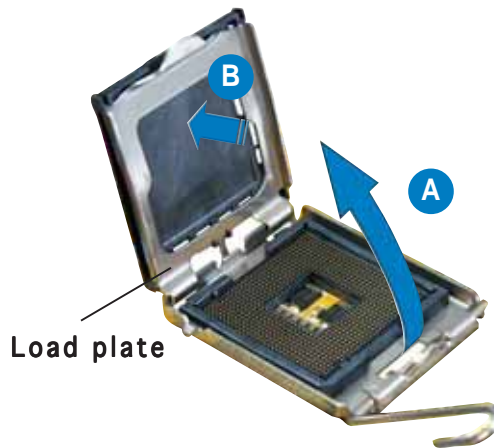

5. Position the CPU over the socket, making sure that the gold triangle is on the bottom-left corner of the socket. The socket alignment key should fit into the CPU notch.

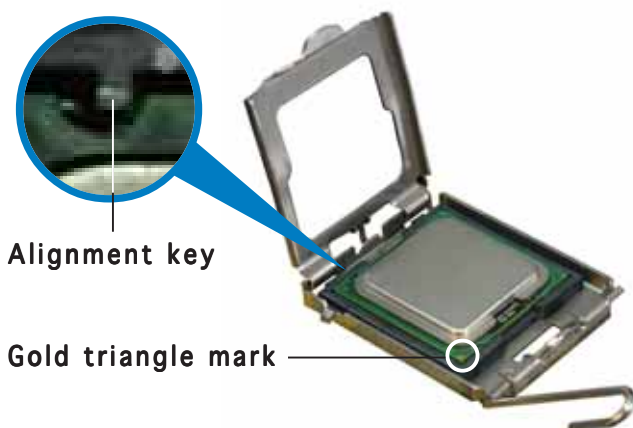

6. Close the load plate (A), then push the load lever (B) until it snaps into the retention tab.



The CPU fits in only one correct orientation. DO NOT force the CPU into the socket to prevent bending the connectors on the socket and damaging the CPU!

Notes on Intel® Hyper-Threading Technology



- This motherboard supports Intel® Pentium® 4 CPUs in the 775-land package with Hyper-Threading Technology.
 - Hyper-Threading Technology is supported under Windows® XP/2003 Server and Linux 2.4.x (kernel) and later versions only. Under Linux, use the Hyper-Threading compiler to compile the code. If you are using any other operating systems, disable the Hyper-Threading Technology item in the BIOS to ensure system stability and performance.
 - Installing Windows® XP Service Pack 1 or later version is recommended.
 - Make sure to enable the Hyper-Threading Technology item in BIOS before installing a supported operating system.
 - For more information on Hyper-Threading Technology, visit www.intel.com/info/hyperthreading.
-

To use the Hyper-Threading Technology on this motherboard:

1. Install an Intel® Pentium® 4 CPU that supports Hyper-Threading Technology.
2. Power up the system and enter the BIOS Setup (see Chapter 4). Under the Advanced Menu, make sure that the item Hyper-Threading Technology is set to Enabled. The item appears only if you installed a CPU that supports Hyper-Threading Technology.
3. Reboot the computer.

2.3.2 Installing the CPU heatsink and fan

The Intel® Pentium® 4 LGA775 processor requires a specially designed heatsink and fan assembly to ensure optimum thermal condition and performance.



- Install the motherboard to the chassis before installing the CPU fan and heatsink assembly
 - When you purchased a boxed Intel® Pentium® 4 processor, the package includes the CPU fan and heatsink assembly. If you purchased a CPU separately, make sure that you use only Intel®-certified multi-directional heatsink and fan.
 - Your boxed Intel® Pentium® 4 LGA775 processor package should come with installation instructions for the CPU, heatsink, and the retention mechanism. If the instructions in this section do not match the CPU documentation, follow the latter.
 - Your Intel® Pentium® 4 LGA775 heatsink and fan assembly comes in a push-pin design and requires no tool to install.
-

Follow these steps to install the CPU heatsink and fan.

1. Place the heatsink on top of the installed CPU, making sure that the four pins match the holes on the motherboard.

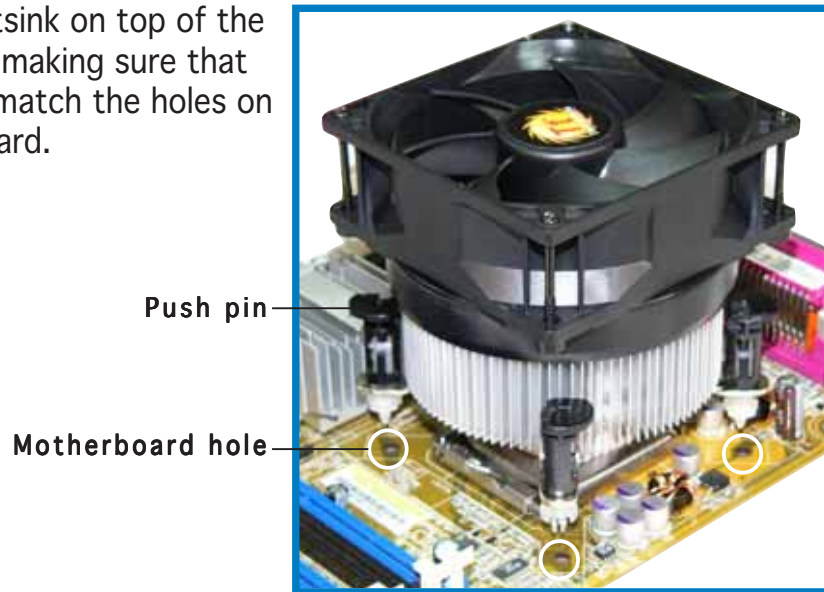

2. Push each of the pins downward to secure the heatsink and fan assembly in place.



3. Rotate the push-pins clockwise to lock.



4. When the fan and heatsink assembly is in place, connect the CPU fan cable to the connector on the motherboard labeled CPU_FAN1.

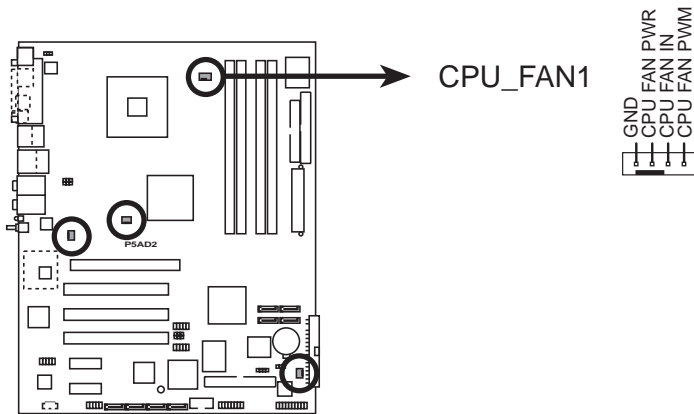

P5AD2 Deluxe Fan connectors



Do not forget to connect the CPU fan connector! Hardware monitoring errors can occur if you fail to plug this connector.

2.4 System memory

2.4.1 Overview

The motherboard comes with four Double Data Rate 2 (DDR2) Dual Inline Memory Modules (DIMM) sockets.

A DDR2 module has the same physical dimensions as a DDR DIMM but has a 240-pin footprint compared to the 184-pin DDR DIMM. DDR2 DIMMs are notched differently to prevent installation on a DDR DIMM socket.

The figure illustrates the location of the DDR2 DIMM sockets:

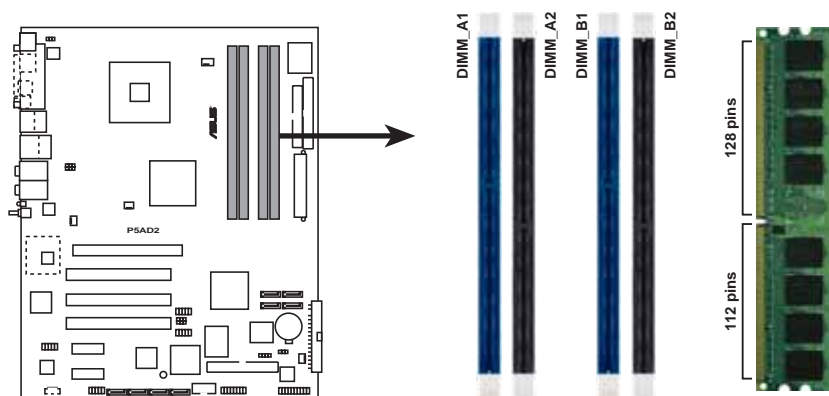

P5AD2 Deluxe DDR2 DIMM sockets

Channel	Sockets	Color
Channel A	DIMM_A1 and DIMM_B1	Yellow
Channel B	DIMM_A2 and DIMM_B2	Black

2.4.2 Memory configurations

You may install 256 MB, 512 MB and 1 GB unbuffered non-ECC DDR2 DIMMs into the DIMM sockets.



- For dual-channel configuration, the total size of memory module(s) installed per channel must be the same (DIMM_A1 + DIMM_B1 = DIMM_A2 + DIMM_B2).
- Always install DIMMs with the same CAS latency. For optimum compatibility, it is recommended that you obtain memory modules from the same vendor. Refer to the DDR2 Qualified Vendors List on the next page for details.
- Due to chipset resource allocation, the system may detect less than 4 GB system memory when you installed four 1 GB DDR2 memory modules.
- This motherboard does not support memory modules made up of 128 Mb chips or double sided x16 memory modules.

DDR2 (533 MHz) Qualified Vendors List

Size	Vendor	Model	Side(s)	Component	DIMM support		
					A	B	C
512 MB	SAMSUNG	M378T6553BG0-CD5	SS	K4T51083QB-GCD5	•	•	•
256 MB	SAMSUNG	M378T3253FG0-CD5	SS	K4T56083QF-GCD5	•	•	•
512 MB	Infineon	HYB18T512800AC37	SS	HYS64T64000GU-3.7-A	•	•	•
512 MB	CORSAIR	CM2X512-4300	DS	Heat-Sink Package	•	•	•
512 MB	Hynix	HYMP564U648-C4	SS	HY5PS12821F-C4	•	•	•
256 MB	MICRON	MT8HTF3264AG-53EB3	SS	3UBIIZ9BQT	•	•	•
512 MB	MICRON	MT16HTF6464AG-53EB1	DS	3TBIIZ9BQT	•	•	•
256 MB	MICRON	MT8HTF3264AG-53EB3	SS	3TBIIZ9BQT	•	•	•
512 MB	Kingston	KVR533D2N4/512	SS	E5108AB-5C-E	•	•	•
512 MB	Hynix	HYMP564U648-C4	SS	HY5PS12821F-C4	•	•	•
1024 MB	Hynix	N/A	DS	HY5PS12821F-C4	•	•	•
512 MB	Hynix	HYMP564U648-C4 AA	SS	HY5PS12821F-C4	•	•	•
1024 MB	Hynix	HYMP512U648-C4	DS	HY5PS12821F-C4	•	•	•
1024 MB	Hynix	HYM512U648-C4 AA	DS	HY5PS12821FP-C4	•	•	•
512 MB	KINGMAX	4CBIIZ9BQT	DS	HLBC28K-38M14-MAA	•	•	•
512 MB	A-DATA	N/A	SS	K4T51083QB-GCD5	•	•	•
256 MB	BRAIN POWER	BS212-1-256M-MIC-533	SS	4CBIIZ9BQT	•	•	•
512 MB	BRAIN POWER	BS213-1-512M-MIC-533	DS	4CBIIZ9BQT	•	•	•
512 MB	ELPIDA	EBE51UD8ABFA-5C	SS	E5108AB-5C-E	•	•	•
512 MB	ELPIDA	EBE51UD8ABFA-5C-E	SS	E5108AB-5C-E	•	•	•
1024 MB	ELPIDA	EBE11UD8ABFA-5C-E	DS	E5108AB-5C-E	•	•	•
512 MB	Pmi	MAB4512MIC	SS	K4T51083QB-GCD5	•	•	•

DDR2-533 with 600 MHz capability (overclocking)

Size	Vendor	Model	Side(s)	Component	CL	DIMM support		
						A	B	C
512 MB	SAMSUNG	M378T6553BG0-CD5	SS	K4T51083QB-GCD5	—	•	•	
1024 MB	SAMSUNG	M378T2953BG0-CD5	DS	K4T51083QB-GCD5	4	•	•	•
256 MB	SAMSUNG	M378T3253FG0-CD5	SS	K4T56083QF-GCD5	4	•	•	
512 MB	SAMSUNG	M378T6453FG0-CD5	DS	K4T56083QF-GCD5	4	•	•	•
512 MB	Infineon	HYS64T64000GU-3.7-A	SS	HYB18T512800AC37	4	•	•	•
256 MB	MICRON	MT8HTF3264AY-53EB3	SS	4FBIIID9CHM	4	•	•	•
512 MB	CORSAIR	CM2X512-4200	DS	Heat-Sink Package	4	•	•	•
512 MB	MICRON	MT16HTF6464AG-53EB2	DS	4FBIIID9BQM	4	•	•	•
1024 MB	MICRON	MT16HTF12864AY-53EA1	DS	4JAIID9CRZ	4	•	•	•
1024 MB	Kingston	KVR533D2N4/1G	DS	E5108AB-5C-E	—	•	•	•
256 MB	Kingston	KVR533D2N4/256	SS	HYB18T512160AC-3.7	—	•	•	•
1024 MB	Hynix	HYMP512U648-C4	DS	HY5PS12821FP-C4	4	•	•	•
256 MB	MICRON	MT8HTF3264AY-53EB3	SS	4FBIIID9CHM	4	•	•	•
512 MB	MICRON	MT16HTF6464AY-53EB2	DS	4FBIIID9CHM	4	•	•	•

Side(s): **SS** - Single-sided **DS** - Double-sided

CL - CAS Latency

DIMM support:

A - Supports one module inserted into either slot, in Single-channel memory configuration.

B - Supports one pair of modules inserted into either the yellow slots or the black slots as one pair of Dual-channel memory configuration.

C - Supports two pairs of modules inserted into the yellow and black slots as two pairs of Dual-channel memory configuration.



Visit the ASUS website for the latest DDR2 Qualified Vendors List.

2.4.3 Installing a DIMM



Unplug the power supply before adding or removing DIMMs or other system components. Failure to do so can cause severe damage to both the motherboard and the components.

To install a DIMM:

1. Unlock a DIMM socket by pressing the retaining clips outward.
2. Align a DIMM on the socket such that the notch on the DIMM matches the break on the socket.
3. Firmly insert the DIMM into the socket until the retaining clips snap back in place and the DIMM is properly seated.

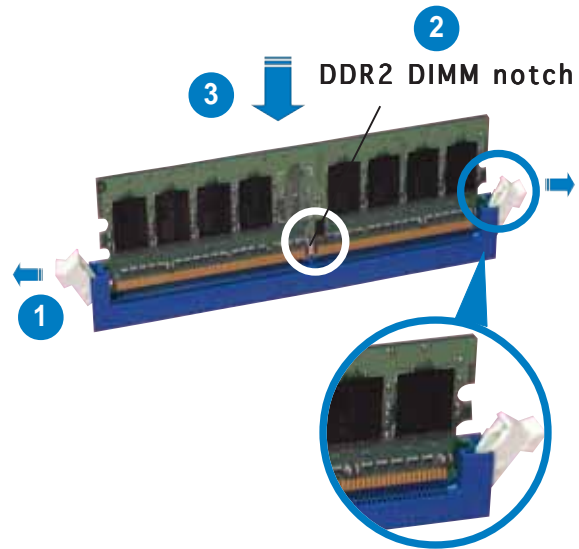

Unlocked retaining clip



- A DDR2 DIMM is keyed with a notch so that it fits in only one direction. Do not force a DIMM into a socket to avoid damaging the DIMM.
- The DDR2 DIMM sockets do not support DDR DIMMs. DO not install DDR DIMMs to the DDR2 DIMM sockets.

2.4.4 Removing a DIMM

Follow these steps to remove a DIMM.

1. Simultaneously press the retaining clips outward to unlock the DIMM.



Support the DIMM lightly with your fingers when pressing the retaining clips. The DIMM might get damaged when it flips out with extra force.

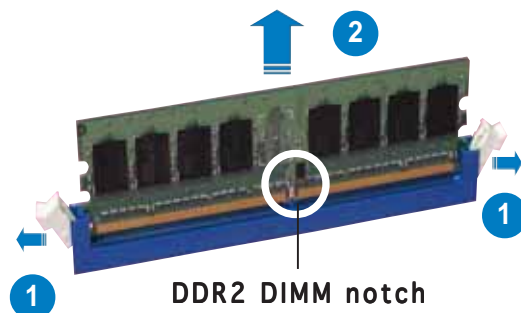

2. Remove the DIMM from the socket.

2.5 Expansion slots

In the future, you may need to install expansion cards. The following sub-sections describe the slots and the expansion cards that they support.



Make sure to unplug the power cord before adding or removing expansion cards. Failure to do so may cause you physical injury and damage motherboard components.

2.5.1 Installing an expansion card

To install an expansion card:

1. Before installing the expansion card, read the documentation that came with it and make the necessary hardware settings for the card.
2. Remove the system unit cover (if your motherboard is already installed in a chassis).
3. Remove the bracket opposite the slot that you intend to use. Keep the screw for later use.
4. Align the card connector with the slot and press firmly until the card is completely seated on the slot.
5. Secure the card to the chassis with the screw you removed earlier.
6. Replace the system cover.

2.5.2 Configuring an expansion card

After installing the expansion card, configure the it by adjusting the software settings.

1. Turn on the system and change the necessary BIOS settings, if any. See Chapter 4 for information on BIOS setup.
2. Assign an IRQ to the card. Refer to the tables on the next page.
3. Install the software drivers for the expansion card.



When using PCI cards on shared slots, ensure that the drivers support “Share IRQ” or that the cards do not need IRQ assignments. Otherwise, conflicts will arise between the two PCI groups, making the system unstable and the card inoperable.

2.5.3 Interrupt assignments

Standard interrupt assignments

IRQ	Priority	Standard Function
0	1	System Timer
1	2	Keyboard Controller
2	—	Re-direct to IRQ#9
3	11	Communications Port (COM2)*
4	12	Communications Port (COM1)*
5	13	IRQ holder for PCI steering*
6	14	Floppy Disk Controller
7	15	Printer Port (LPT1)*
8	3	System CMOS/Real Time Clock
9	4	IRQ holder for PCI steering*
10	5	IRQ holder for PCI steering*
11	6	IRQ holder for PCI steering*
12	7	PS/2 Compatible Mouse Port*
13	8	Numeric Data Processor
14	9	Primary IDE Channel
15	10	Secondary IDE Channel

* These IRQs are usually available for ISA or PCI devices.

IRQ assignments for this motherboard

	A	B	C	D	E	F	G	H
PCI slot 1	—	—	—	—	—	—	shared	—
PCI slot 2	—	—	—	—	—	shared	—	—
PCI slot 3	—	shared	—	—	—	—	—	—
PCI E x16 slot	shared	—	—	—	—	—	—	—
PCI E x1 slot 1	shared	—	—	—	—	—	—	—
PCI E x1 slot 2	—	—	—	shared	—	—	—	—
Onboard USB controller 1	shared	—	—	—	—	—	—	—
Onboard USB controller 2	—	shared	—	—	—	—	—	—
Onboard USB controller 3	—	—	shared	—	—	—	—	—
Onboard USB controller 4	—	—	—	shared	—	—	—	—
Onboard USB 2.0 controller	shared	—	—	—	—	—	—	—
Onboard IDE port	shared	—	—	—	—	—	—	—
Onboard SATA port	—	shared	—	—	—	—	—	—
Onboard Azalia audio	shared	—	—	—	—	—	—	—
Onboard LAN	—	shared	—	—	—	—	—	—
Onboard wireless LAN	—	—	—	—	used	—	—	—
Onboard PCI SATA RAID (SI)	—	—	—	—	—	—	shared	—
Onboard PCI IDE RAID (ITE)	—	—	—	—	—	—	—	used
Onboard 1394 controller	—	—	—	—	—	shared	—	—

2.5.4 PCI slots

The PCI slots support cards such as a LAN card, SCSI card, USB card, and other cards that comply with PCI specifications. The figure shows a LAN card installed on a PCI slot.

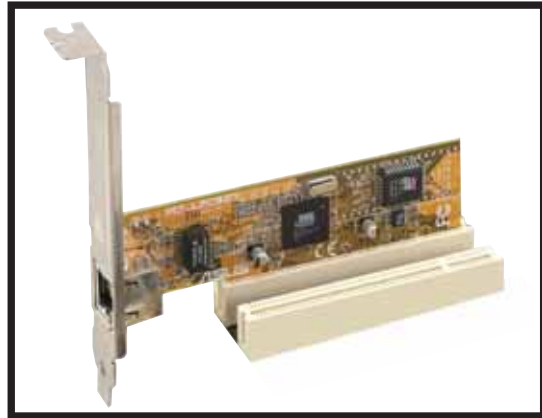

2.5.5 PCI Express x16 slot

This motherboard supports PCI Express x16 graphic cards that comply with the PCI Express specifications. The following figure shows a graphics card installed on the PCI Express x16 slot.



2.5.6 PCI Express x1 slot

This motherboard supports PCI Express x1 network cards, SCSI cards and other cards that comply with the PCI Express specifications. The following figure shows a network card installed on the PCI Express x1 slot.



2.6 Jumpers

1. Clear RTC RAM (CLRTC)

This jumper allows you to clear the Real Time Clock (RTC) RAM in CMOS. You can clear the CMOS memory of date, time, and system setup parameters by erasing the CMOS RTC RAM data. The onboard button cell battery powers the RAM data in CMOS, which include system setup information such as system passwords.

To erase the RTC RAM:

1. Turn OFF the computer and unplug the power cord.
2. Remove the onboard battery.
3. Move the jumper cap from pins 1-2 (default) to pins 2-3. Keep the cap on pins 2-3 for about 5~10 seconds, then move the cap back to pins 1-2.
4. Re-install the battery.
5. Plug the power cord and turn ON the computer.
6. Hold down the key during the boot process and enter BIOS setup to re-enter data.



Except when clearing the RTC RAM, never remove the cap on CLRTC jumper default position. Removing the cap will cause system boot failure!

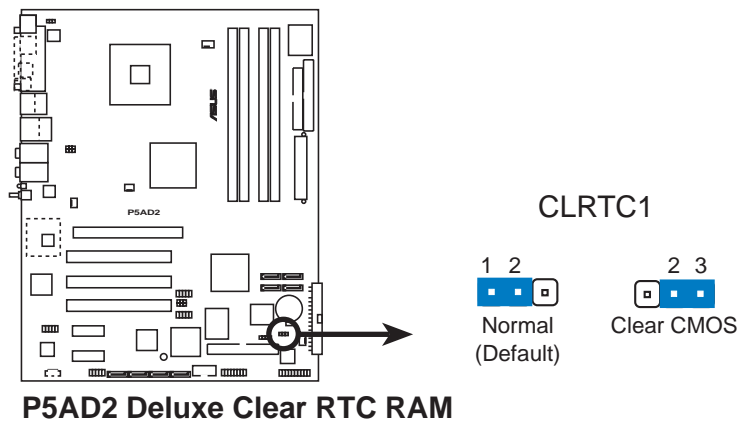

You do not need to clear the RTC when the system hangs due to overclocking. For system failure due to overclocking, use the C.P.R. (CPU Parameter Recall) feature. Shut down and reboot the system so the BIOS can automatically reset parameter settings to default values.

2. USB device wake-up jumpers (3-pin USBPW12, USBPW34, USBPW56, USBPW78)

Set these jumpers to +5V to wake up the computer from S1 sleep mode (CPU stopped, DRAM refreshed, system running in low power mode) using the connected USB devices. Set to +5VSB to wake up from S3 and S4 sleep modes (no power to CPU, DRAM in slow refresh, power supply in reduced power mode).

The USBPW12 and USBPW34 jumpers are for the rear USB ports. The USBPW56 and USBPW78 jumpers are for the internal USB connectors that you can connect to additional USB ports.

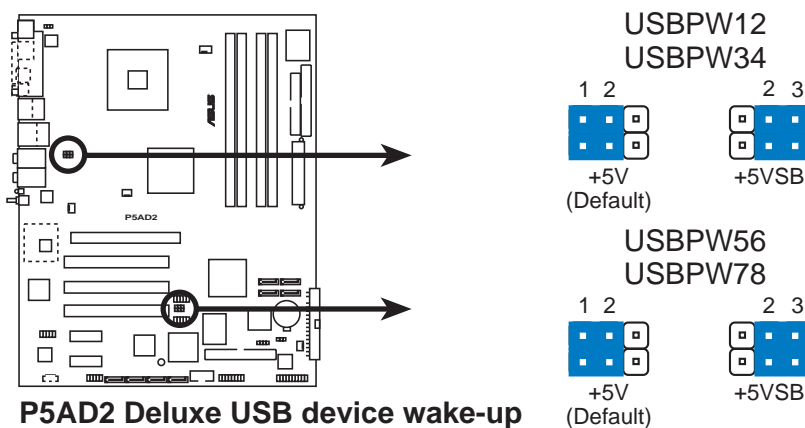

P5AD2 Deluxe USB device wake-up



- The USB device wake-up feature requires a power supply that can provide 500mA on the +5VSB lead for each USB port; otherwise, the system would not power up.
- The total current consumed must NOT exceed the power supply capability (+5VSB) whether under normal condition or in sleep mode.

3. Keyboard power (3-pin KBPWR1)

This jumper allows you to enable or disable the keyboard wake-up feature. Set this jumper to pins 2-3 (+5VSB) to wake up the computer when you press a key on the keyboard (the default is the Space Bar). This feature requires an ATX power supply that can supply at least 1A on the +5VSB lead, and a corresponding setting in the BIOS.

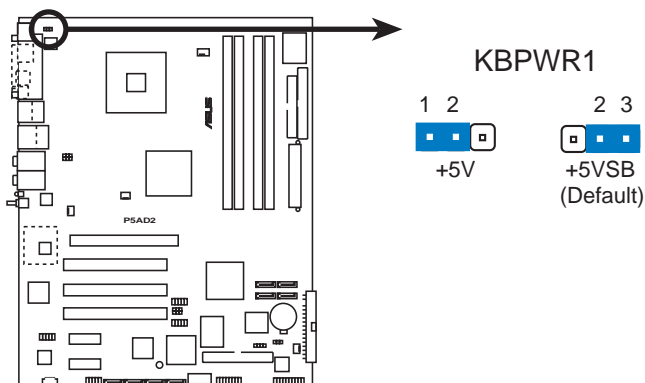

P5AD2 Deluxe Keyboard power setting

2.7 Connectors

2.7.1 Rear panel connectors

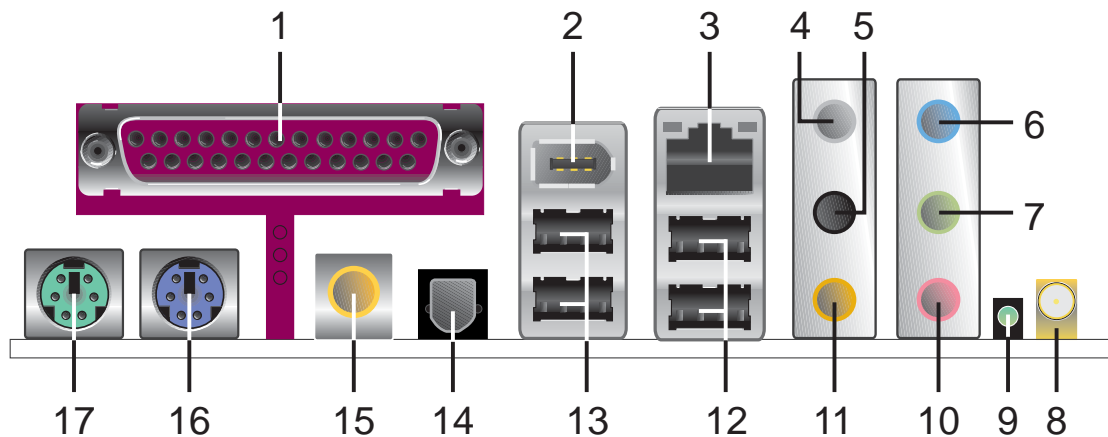

1. **Parallel port.** This 25-pin port connects a parallel printer, a scanner, or other devices.
2. **IEEE 1394a port.** This 6-pin IEEE 1394a port provides high-speed connectivity for audio/video devices, storage peripherals, PCs, or portable devices.
3. **LAN (RJ-45) port.** This port allows Gigabit connection to a Local Area Network (LAN) through a network hub. Refer to the table below for the LAN port LED indications.

LAN port LED indications

ACT/LINK LED		SPEED LED	
Status	Description	Status	Description
OFF	No link	OFF	10 Mbps connection
GREEN	Linked	ORANGE	100 Mbps connection
BLINKING	Data activity	GREEN	1 Gbps connection

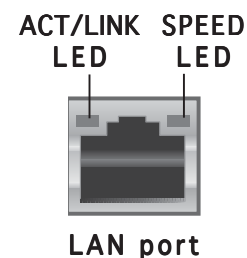

4. **Rear Speaker Out port (gray).** This port connects the rear speakers on a 4-channel, 6-channel, or 8-channel audio configuration.
5. **Side Speaker Out port (black).** This port connects the side speakers in an 8-channel audio configuration.
6. **Line In port (light blue).** This port connects a tape, CD, DVD player, or other audio sources.
7. **Line Out port (lime).** This port connects a headphone or a speaker. In 4-channel, 6-channel, and 8-channel configuration, the function of this port becomes Front Speaker Out.



Refer to the audio configuration table on the next page for the function of the audio ports in 2, 4, 6, or 8-channel configuration.

8. **Wireless LAN antenna port** (Wireless Edition only). This port connects to the optional dipolar antenna for the onboard WiFi-g™ solution.
9. **Wireless LAN LED** (Wireless Edition only). This green **AIR LED** indicates the data transmission status of the onboard wireless LAN adapter. Refer to the table below for the LED indications.

Wireless LAN LED indications

Status	Indication
On	The onboard WiFi-g™ is on but has no data activity.
Off	The onboard WiFi-g™ card is off.
Flashing	The onboard WiFi-g™ card is transmitting and/or receiving data.

10. **Microphone port (pink)**. This port connects a microphone.
11. **Center/Subwoofer port (yellow orange)**. This port connects the center/subwoofer speakers.

Audio 2, 4, 6, or 8-channel configuration

Port	2-channel (Headset)	4-channel	6-channel	8-channel
Light Blue	Line In	Line In	Line In	Line In
Lime	Line Out	Front Speaker Out	Front Speaker Out	Front Speaker Out
Pink	Mic In	Mic In	Mic In	Mic In
Gray	—	Rear Speaker Out	Rear Speaker Out	Rear Speaker Out
Black	—	—	—	Side Speaker Out
Yellow Orange	—	—	Center/Subwoofer	Center/Subwoofer

12. **USB 2.0 ports 3 and 4**. These two 4-pin Universal Serial Bus (USB) ports are available for connecting USB 2.0 devices.
13. **USB 2.0 ports 1 and 2**. These two 4-pin Universal Serial Bus (USB) ports are available for connecting USB 2.0 devices.
14. **Optical S/PDIF Out port**. This port connects an external audio output device via an optical S/PDIF cable.
15. **Coaxial S/PDIF Out port**. This port connects an external audio output device via a coaxial S/PDIF cable.
16. **PS/2 keyboard port (purple)**. This port is for a PS/2 keyboard.
17. **PS/2 mouse port (green)**. This port is for a PS/2 mouse.

2.7.2 Internal connectors

1. Floppy disk drive connector (34-1 pin FLOPPY)

This connector is for the provided floppy disk drive (FDD) signal cable. Insert one end of the cable to this connector, then connect the other end to the signal connector at the back of the floppy disk drive.



Pin 5 on the connector is removed to prevent incorrect cable connection when using a FDD cable with a covered Pin 5.

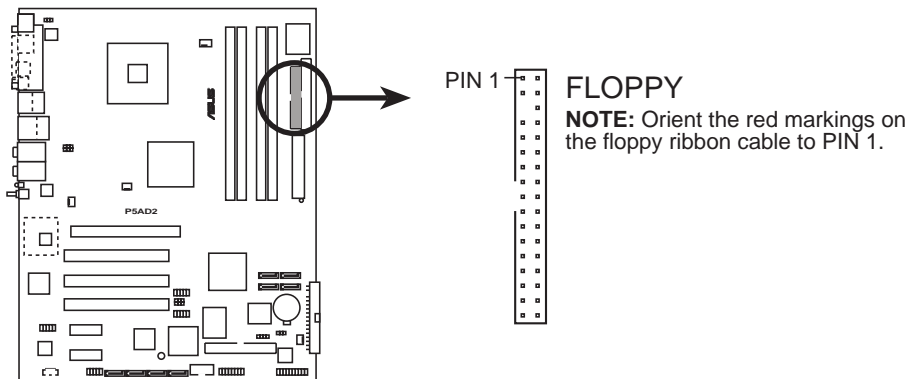

P5AD2 Deluxe Floppy disk drive connector

2. Primary IDE connector (40-1 pin PRI_IDE1)

This connector is for an Ultra DMA 100/66 signal cable. The Ultra DMA 100/66 signal cable has three connectors: a blue connector for the primary IDE connector on the motherboard, a black connector for an Ultra DMA 100/66 IDE slave device (optical drive/hard disk drive), and a gray connector for an Ultra DMA 100/66 IDE master device (hard disk drive). If you install two hard disk drives, you must configure the second drive as a slave device by setting its jumper accordingly. Refer to the hard disk documentation for the jumper settings.



- Pin 20 on the IDE connector is removed to match the covered hole on the Ultra DMA cable connector. This prevents incorrect insertion when you connect the IDE cable.
- Use the 80-conductor IDE cable for Ultra DMA 100/66 IDE devices.

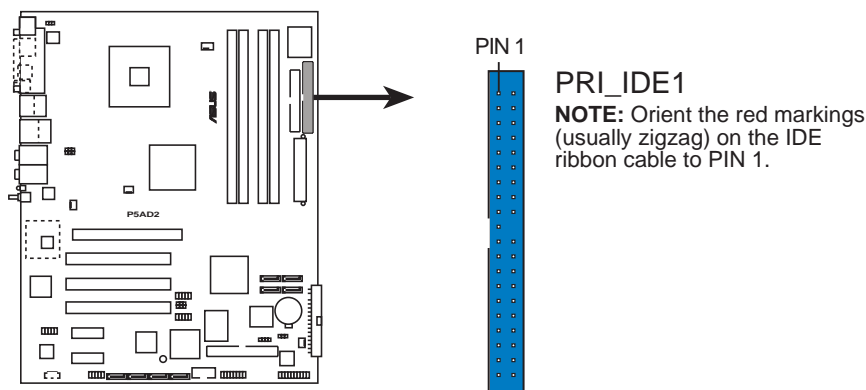

P5AD2 Deluxe IDE connector

3. IDE RAID connectors (40-1 pin PRI_RAID1 [red], SEC_RAID1 [red])

These connectors are for Ultra ATA 133/100/66 signal cables. The IDE RAID connectors support up to four IDE hard disk drives that you can configure as a disk array through the onboard IDE RAID controller. Refer to Chapter 5 for details on how to set up RAID configurations.



These connectors are set to **IDE Mode** by default. In **IDE Mode**, you can connect IDE devices to these connectors such as boot/data hard disk drives or optical drives. If you intend to create an IDE RAID set using these connectors, set the **ITE8212F Controller** item in the BIOS to [RAID Mode]. See section “4.4.6 Onboard Devices Configuration” for details.

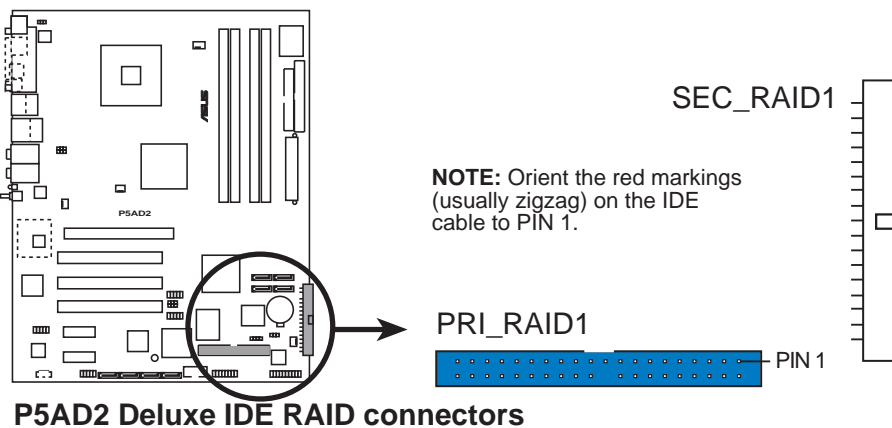

- Before creating a RAID set using Ultra ATA hard disks, make sure that you have connected the Ultra ATA signal cable and installed Ultra ATA 133/100/66 hard disk drives.
- The system automatically assigns the boot sequence of ATAPI devices connected to the IDE RAID connectors.
- The ITE® 8212F controller supports a maximum of two Ultra ATA hard disk drives in RAID 1 configuration.
- Before creating a RAID 1 set, make sure that you set the hard disk drives as either Master or Slave device. Refer to the hard disk drive documentation for details.

4. Serial ATA connectors (7-pin SATA1 [red], SATA2 [red], SATA3 [black], SATA4 [black])

These connectors are for the Serial ATA signal cables for Serial ATA hard disk drives.

If you installed Serial ATA hard disk drives, you can create a RAID 0 or RAID 1 configuration with the Intel® Matrix Storage Technology through the onboard Intel® ICH6R RAID controller. Refer to Chapter 5 for details on how to set up Serial RAID configurations.



These connectors are set to **Standard IDE** mode by default. In **Standard IDE** mode, you can connect Serial ATA boot/data hard disk drives to these connectors. If you intend to create a Serial ATA RAID set using these connectors, set the **Configure SATA As** item in the BIOS to [RAID]. See section “4.3.6 IDE Configuration” on page 4-15 for details.

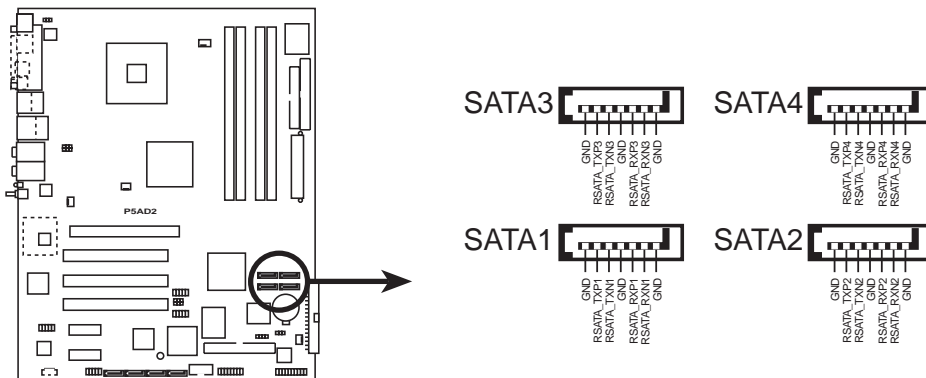

P5AD2 Deluxe SATA connectors



Important notes on Serial ATA

- You must install Windows® 2000 Service Pack 4 or the Windows® XP Service Pack 1 before using Serial ATA hard disk drives. The Serial ATA RAID feature (RAID 0/RAID 1) is available only if you are using Windows® 2000/XP.
- Use only two Serial ATA RAID connectors for each RAID 0 or RAID 1 set.
- When using the connectors in **Standard IDE** mode, connect the primary (boot) hard disk drive to the SATA1 or SATA2 connector. Refer to the table below for the recommended SATA hard disk drive connections.

Serial ATA hard disk drive connection

Connector	Color	Setting	Use
SATA1/SATA2	Red	Master	Boot disk
SATA3/SATA4	Black	Slave	Data disk

5. Serial ATA RAID connectors (7-pin SATA_RAID1, SATA_RAID2, SATA_RAID3, SATA_RAID4)

These connectors are for Serial ATA signal cables. These connectors support up to four Serial ATA hard disk drives that you can configure as a disk array through the onboard SATA RAID controller. Refer to Chapter 5 for details on how to set up Serial ATA RAID configurations.



These connectors are set to **RAID Mode** by default. If you want to connect Serial ATA boot/data hard disk drives to these connectors, set the **Silicon Image Controller** item in the BIOS to [SATA Mode]. See section “4.4.6 Onboard Devices Configuration” for details.

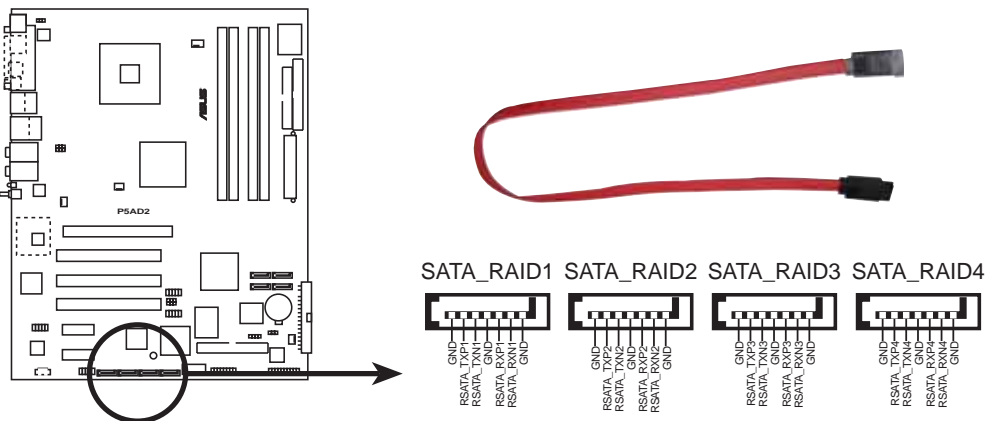

P5AD2 Deluxe SATA RAID connectors



- Before creating a RAID set using Serial ATA hard disks, make sure that you have connected the Serial ATA signal cable and installed Serial ATA hard disk drives; ; otherwise, you cannot enter the Silicon Image RAID utility and SATA BIOS setup during POST.
- You can only create RAID 5 and JBOD configuration using the SATALink™ SATA RAID Management software. See Chapter 5 for details. The RAID 5 feature is not Windows® Hardware Quality Labs (WHQL)-certified.

6. Optical drive audio connector (4-pin CD)

This connector is for the 4-pin audio cable that connects to the audio connector at the back of the optical drive.

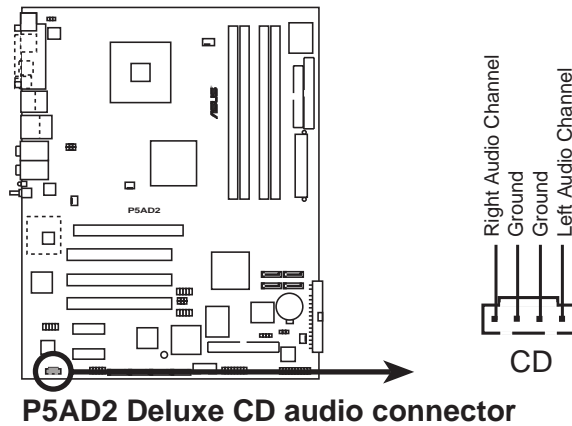

Enable the CD-IN function in the audio utility when using this connector.

7. Chassis intrusion connector (4-1 pin CHASSIS1)

This connector is for a chassis-mounted intrusion detection sensor or switch. Connect one end of the chassis intrusion sensor or switch cable to this connector. The chassis intrusion sensor or switch sends a high-level signal to this connector when a chassis component is removed or replaced. The signal is then generated as a chassis intrusion event.

By default, the pins labeled “Chassis Signal” and “Ground” are shorted with a jumper cap. Remove the jumper caps only when you intend to use the chassis intrusion detection feature.

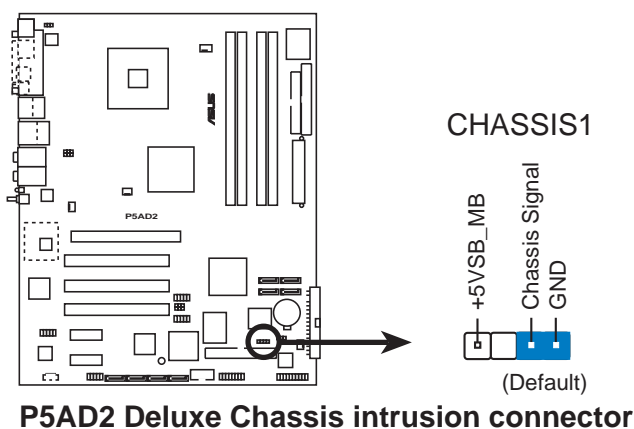

8. Front panel audio connector (10-1 pin AAFP)

This connector is for a chassis-mounted front panel audio I/O module that supports either HD Audio or legacy AC'97 audio standard.

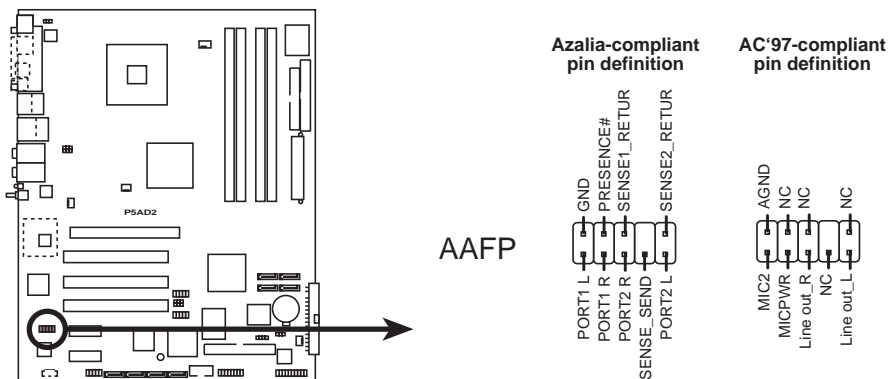

P5AD2 Deluxe Front panel audio connector



- It is recommended that you connect a high-definition front panel audio module to this connector to avail the motherboard high-definition audio capability.
- By default, this connector is set to legacy AC'97 audio. If you want to connect a high-definition front panel audio module to this connector, set the **Front Panel Support Type** item in the BIOS Setup to [Azalia]. See page 4-27 for details.

9. USB connectors (10-1 pin USB56, USB78)

These connectors are for USB 2.0 ports. Connect the USB/GAME module cable to any of these connectors, then install the module to a slot opening at the back of the system chassis. These USB connectors comply with USB 2.0 specification that supports up to 480 Mbps connection speed.

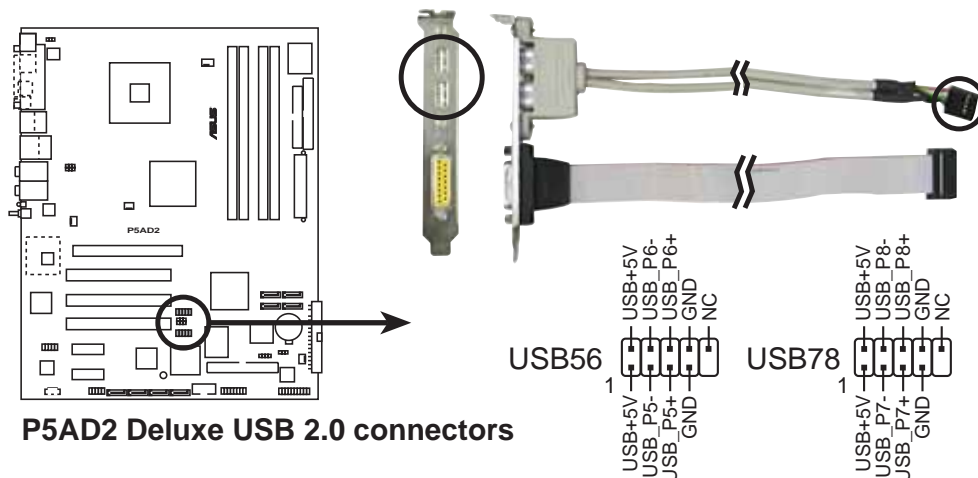

P5AD2 Deluxe USB 2.0 connectors



Never connect a **1394** cable to the USB connectors. Doing so will damage the motherboard!

10. IEEE 1394a port connector (10-1 pin IE1394_2 [red])

This connector is for an IEEE 1394a port. Connect the IEEE 1394a module cable to this connector, then install the module to a slot opening at the back of the system chassis.

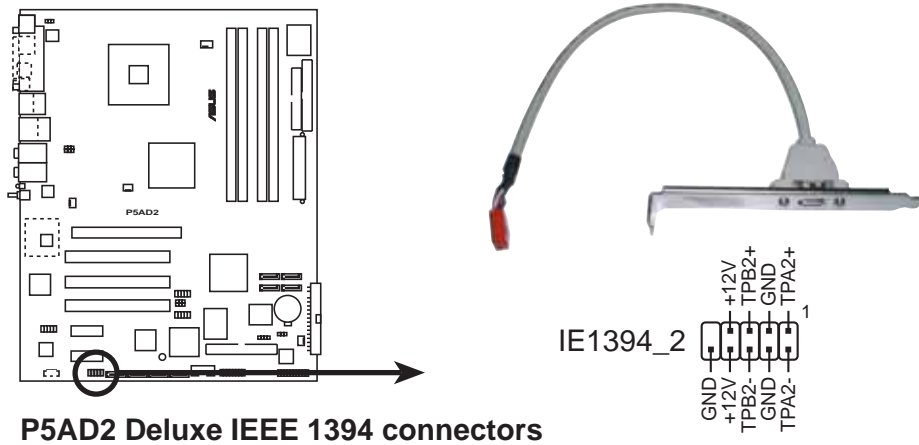

Never connect a **USB cable** to the IEEE 1394a connectors. Doing so will damage the motherboard!

11. GAME/MIDI port connector (16-1 pin GAME1)

This connector is for a GAME/MIDI port. Connect the USB/GAME module cable to this connector, then install the module to a slot opening at the back of the system chassis. The GAME/MIDI port connects a joystick or game pad for playing games, and MIDI devices for playing or editing audio files.

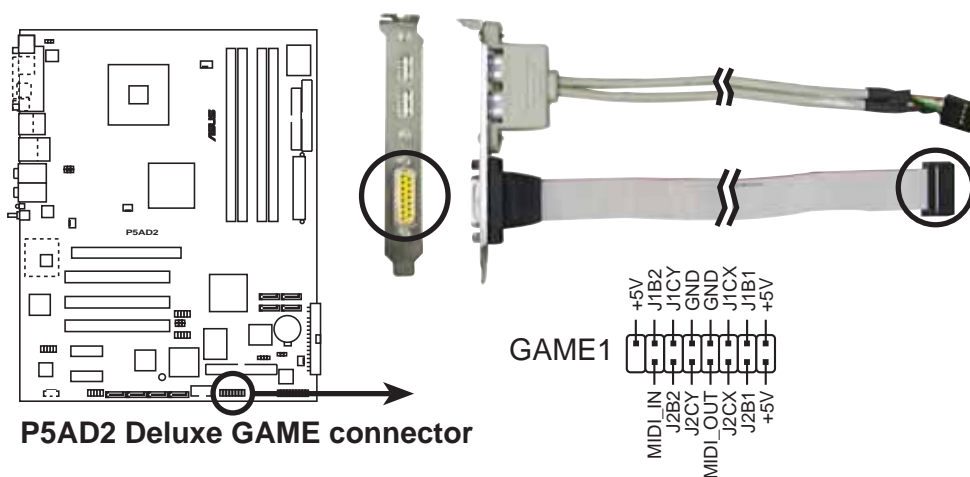

12. Serial port connector (10-1 pin COM1)

This connector is for a serial (COM) port. Connect the serial port module cable to this connector, then install the module to a slot opening at the back of the system chassis.

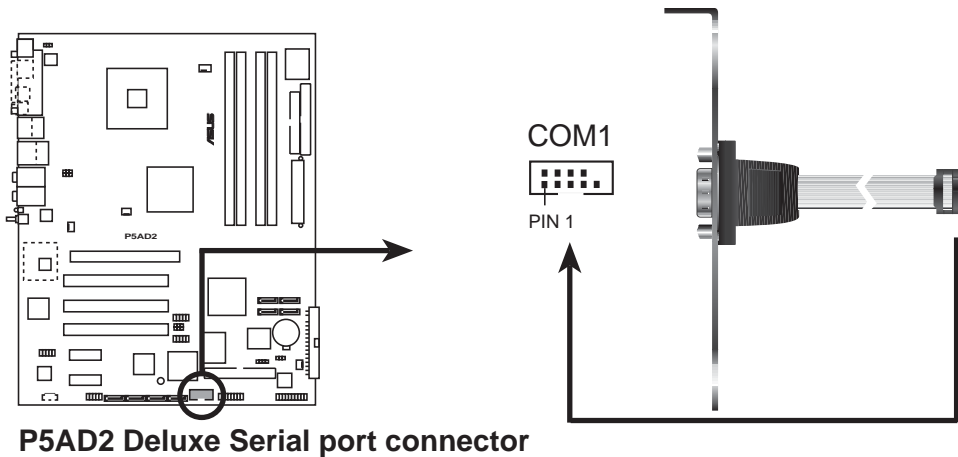

P5AD2 Deluxe Serial port connector

13. CPU, Chassis, and Power Fan connectors (3-pin CPU_FAN1, PWR_FAN1, CHA_FAN1, CHA_FAN2)

The fan connectors support cooling fans of 350 mA ~ 2000 mA (24 W max.) or a total of 1 A ~ 3.48 A (41.76 W max.) at +12V. Connect the fan cables to the fan connectors on the motherboard, making sure that the black wire of each cable matches the ground pin of the connector.



Do not forget to connect the fan cables to the fan connectors. Insufficient air flow inside the system may damage the motherboard components. These are not jumpers! Do not place jumper caps on the fan connectors!

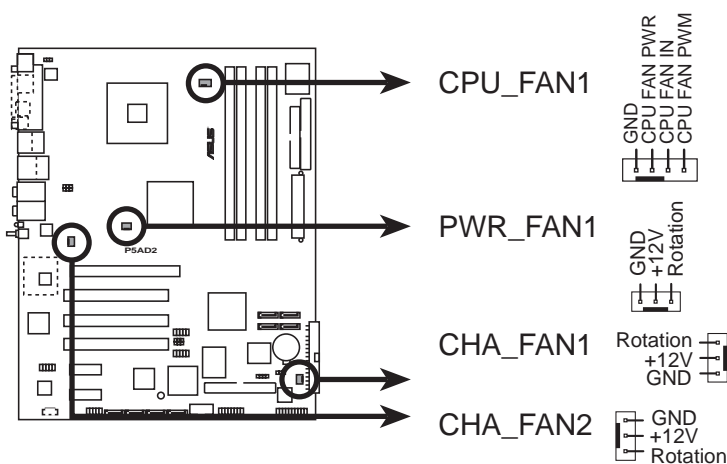

P5AD2 Deluxe Fan connectors



Only the CPU_FAN1 and CHA_FAN1 connectors support the ASUS Q-Fan 2 feature.

14. ATX power connectors (24-pin EATXPWR1, 4-pin ATX12V1)

These connectors are for ATX power supply plugs. The power supply plugs are designed to fit these connectors in only one orientation. Find the proper orientation and push down firmly until the connectors completely fit.



- Use of an ATX 12 V Specification 2.0 -compliant power supply unit (PSU) that provides a minimum power of 350 W is recommended for a fully-configured system.
- Do not forget to connect the 4-pin ATX +12 V power plug; otherwise, the system will not boot up.
- Use of a PSU with a higher power output is recommended when configuring a system with more power consuming devices. The system may become unstable or may not boot up if the power is inadequate.
- When using an ATX 12 V PSU with a 20-pin power plug, make sure that it can provide at least 15 A on the +12 V lead, and a minimum power of 350 W. Use of an ATX 12 V PSU with a 20-pin power plug is not recommended.
- The ATX 12 V Specification 2.0-compliant (350 W) PSU passed the motherboard power requirement test with the following configuration:

CPU	:	Intel® Pentium® 4 3.6 GHz
Memory	:	512 MB DDR2 (x 4)
Graphics card	:	PCI Express x16 Nvidia EN5900
Parallel ATA devices	:	IDE hard disk drive (x 2)
Serial ATA device	:	SATA hard disk drive
Optical drives	:	CD-ROM (x 2)
SCSI devices	:	SCSI card and SCSI hard disk drive

- You must install a PSU with a higher power rating if you intend to install additional devices.

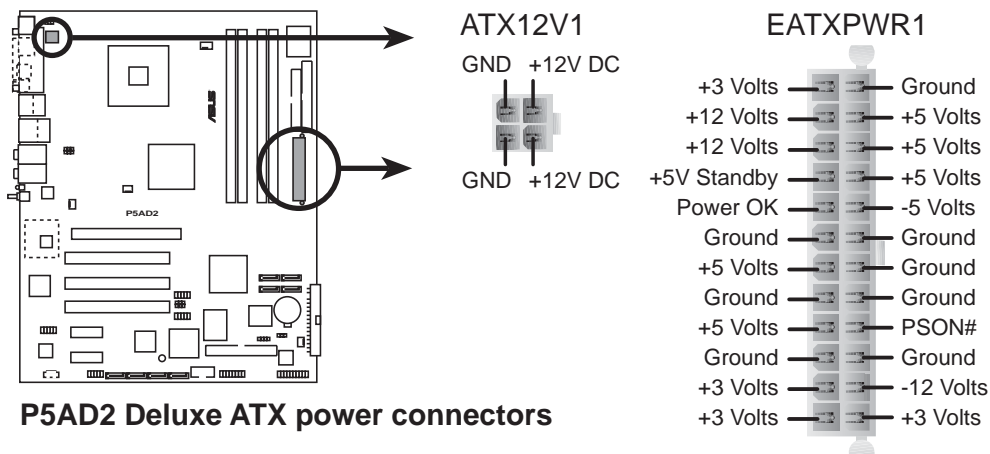

15. System panel connector (20-pin PANEL1)

This connector supports several chassis-mounted functions.

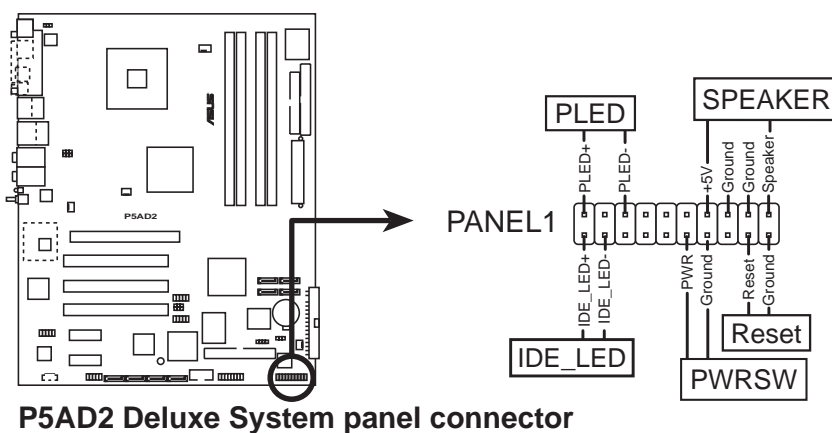

P5AD2 Deluxe System panel connector



The system panel connector is color-coded for easy connection. Refer to the connector description below for details.

- **System power LED (Green 3-pin PLED)**
This 3-pin connector is for the system power LED. Connect the chassis power LED cable to this connector. The system power LED lights up when you turn on the system power, and blinks when the system is in sleep mode.
- **Hard disk drive activity LED (Red 2-pin IDE_LED)**
This 2-pin connector is for the HDD Activity LED. Connect the HDD Activity LED cable to this connector. The IDE LED lights up or flashes when data is read from or written to the HDD.
- **System warning speaker (Orange 4-pin SPEAKER)**
This 4-pin connector is for the chassis-mounted system warning speaker. The speaker allows you to hear system beeps and warnings.
- **ATX power button/soft-off button (Yellow 2-pin PWRSW)**
This connector is for the system power button. Pressing the power button turns the system on or puts the system in sleep or soft-off mode depending on the BIOS settings. Pressing the power switch for more than four seconds while the system is ON turns the system OFF.
- **Reset button (Blue 2-pin RESET)**
This 2-pin connector is for the chassis-mounted reset button for system reboot without turning off the system power.

This chapter describes the power up sequence, the vocal POST messages, and ways of shutting down the system.

Powering up

Chapter summary

3

3.1	Starting up for the first time	3-1
3.2	Powering off the computer	3-2
3.3	ASUS POST Reporter™	3-3

3.1 Starting up for the first time

1. After making all the connections, replace the system case cover.
2. Be sure that all switches are off.
3. Connect the power cord to the power connector at the back of the system chassis.
4. Connect the power cord to a power outlet that is equipped with a surge protector.
5. Turn on the devices in the following order:
 - a. Monitor
 - b. External SCSI devices (starting with the last device on the chain)
 - c. System power
6. After applying power, the system power LED on the system front panel case lights up. For systems with ATX power supplies, the system LED lights up when you press the ATX power button. If your monitor complies with “green” standards or if it has a “power standby” feature, the monitor LED may light up or switch between orange and green after the system LED turns on.

The system then runs the power-on self tests or POST. While the tests are running, the BIOS beeps (see BIOS beep codes table below) or additional messages appear on the screen. If you do not see anything within 30 seconds from the time you turned on the power, the system may have failed a power-on test. Check the jumper settings and connections or call your retailer for assistance.

AMI BIOS beep codes

Beep Description	Error
One beep	Keyboard controller error Refresh Time error No master drive detected
Two continuous beeps followed by two short beeps	Floppy controller failure
Two continuous beeps followed by four short beeps	Hardware component failure

7. At power on, hold down the <Delete> key to enter the BIOS Setup. Follow the instructions in Chapter 4.

3.2 Powering off the computer

3.2.1 Using the OS shut down function

If you are using Windows® 2000:

1. Click the **Start** button then click **Shut Down...**
2. Make sure that the **Shut Down** option button is selected, then click the **OK** button to shut down the computer.
3. The power supply should turn off after Windows® shuts down.

If you are using Windows® XP:

1. Click the **Start** button then select **Turn Off Computer.**
2. Click the **Turn Off** button to shut down the computer.
3. The power supply should turn off after Windows® shuts down.

3.2.2 Using the dual function power switch

While the system is ON, pressing the power switch for less than four seconds puts the system to sleep mode or to soft-off mode, depending on the BIOS setting. Pressing the power switch for more than four seconds lets the system enter the soft-off mode regardless of the BIOS setting. Refer to section “4.5 Power Menu” in Chapter 4 for details.

3.3 ASUS POST Reporter™

This motherboard includes the Winbond speech controller to support a special feature called the ASUS POST Reporter™. This feature lets you hear vocal messages during POST that alerts you of system events and boot status. In case of a boot failure, you will hear the specific cause of the problem.

These POST messages are customizable using the Winbond Voice Editor software that came with your package. You can record your own messages to replace the default messages.

3.3.1 Vocal POST messages

Following is a list of the default POST messages and the corresponding actions you can take:

POST Message	Action
No CPU installed	<ul style="list-style-type: none">• Install a supported processor to the CPU socket. See section “2.3 Central Processing Unit (CPU)” for details.
System failed CPU test	<ul style="list-style-type: none">• Check the CPU if properly installed.• Call ASUS technical support for assistance. See the ASUS contact information on the inside front cover of this user guide.
System failed memory test	<ul style="list-style-type: none">• Install supported DDR2 DIMMs into the memory sockets.• Check if the DIMMs on the DIMM sockets are properly installed.• Make sure that your DIMMs are not defective.• Refer to section “2.4 System memory” for instructions on installing a DIMM.
System failed VGA test	<ul style="list-style-type: none">• Install a PCI graphics card into one of the PCI slots, or a PCI Express AGP card into the PCI Express x16 slot.• Make sure that your graphics card is not defective.
System failed due to CPU	<ul style="list-style-type: none">• Check your CPU overclocking settings in the BIOS setup and restore the default CPU parameters.
No keyboard detected	<ul style="list-style-type: none">• Check if your keyboard is properly connected to the purple PS/2 connector on the rear panel.• See section “2.7.1 Rear panel connectors” for the location of the connector.
No IDE hard disk detected	<ul style="list-style-type: none">• Make sure you have connected an IDE hard disk drive to one of the IDE connectors on the motherboard.

POST Message	Action
CPU temperature too high	<ul style="list-style-type: none"> • Check if the CPU fan is working properly.
CPU fan failed	<ul style="list-style-type: none"> • Check the CPU fan and make sure it turns on after you apply power to the system. • Make sure that your CPU fan supports the fan speed detection function.
CPU voltage out of range	<ul style="list-style-type: none"> • Check your power supply and make sure it is not defective. • Call ASUS technical support for assistance. See the “ASUS contact information” on the inside front cover of this user guide.
Computer now booting from operating system	<ul style="list-style-type: none"> • No action required



You can enable or disable the ASUS POST Reporter™ in the **Speech Configuration** option in the BIOS setup. See section 4.4.8 for details.

3.3.2 Winbond Voice Editor

The Winbond Voice Editor software allows you to customize the vocal POST messages. You can install this application from the support CD.



To avoid conflicts, do not run the Winbond Voice Editor while running the ASUS PC Probe application.

Launching the Voice Editor

You can launch the program from the Windows® desktop by clicking **Start > All Programs > Winbond Voice Editor > Voice Editor**.

The Winbond Voice Editor screen appears.



POST Events Default Messages

Playing the default wave files

To play the default wave files, simply click on a POST event on the left side of the screen, then click the Play button.



The default language setting is English.

Changing the default language

To change the default language:

1. Click the **Load** button from the Voice Editor main window. A window with the available languages appears.



2. Select your desired language, then click **Open**.

The event messages for the language you selected appear on the Voice Editor main window.



Not all events on some languages have a corresponding message due to file size constraints.

3. Click the **Write** button from the Voice Editor main window to update the EEPROM.
4. Click **Yes** to confirm.

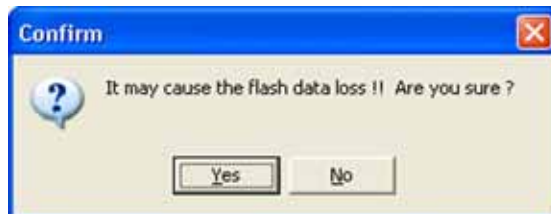

The next time you boot your computer, the ASUS Post Reporter announces the messages in the selected language.

Customizing your POST messages

The Voice Editor application allows you to record your own POST messages if your language is not supported or if you wish to replace the pre-installed wave files.

To customize your POST messages.

1. Launch the Voice Editor application and note the list of POST events on the leftmost column of the screen.
2. Prepare your message for each event.
3. Use a recording software (e.g. Windows® Recorder) to record your messages, then save the messages as wave files (.WAV).



- The total compressed size for all the wave files must not exceed 1Mbit, so keep your messages as short as possible.
- To keep file sizes small, save your files at a low quality. For example, use 8-bit, mono quality at 22Khz sampling rate.
- Create a separate folder for your wave files so you can locate them easily.

4. From the Voice Editor screen, click the **Add** button to display the **Add Wave File** window.
5. Copy the wave files that you recorded to the database, then close the window when done.

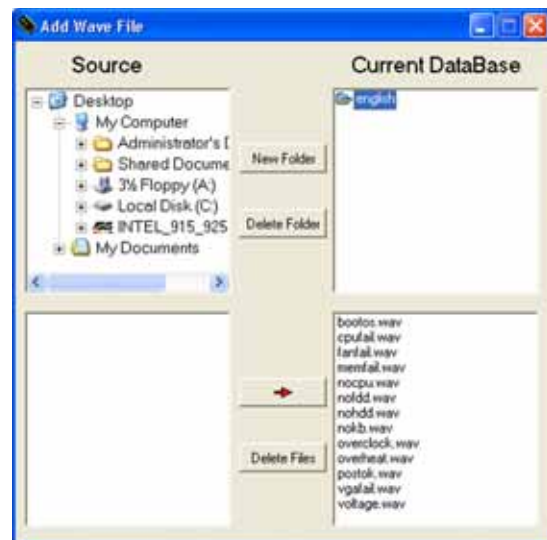

6. Select a POST event on the Voice Editor main window, then click the **Edit** button. The **Event Sound Editor** window appears.
7. Locate and select your wave file for the event, then click on the arrow opposite Voice1. The file you select appears on the space next to it.
8. Click **OK** to return to the Voice Editor main window.
9. Do steps 6 to 8 for the other events.

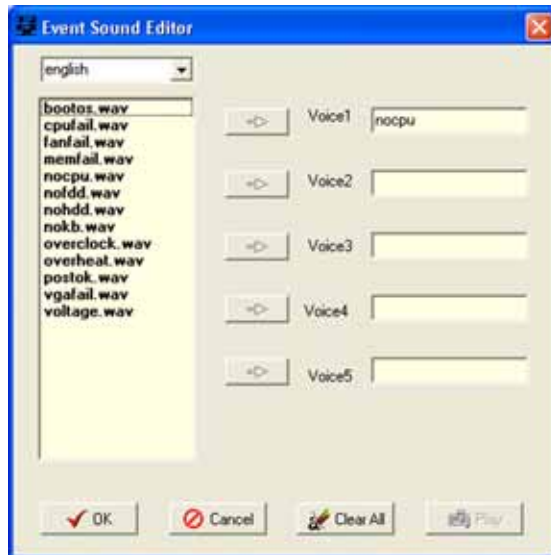

10. When done, click **Save**. A window appears prompting you to save your configuration.
11. Type a file name with an **.flh** extension, then click Save.

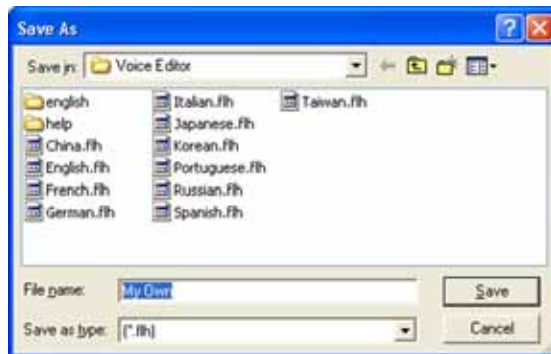

12. Click the **Write** button to compress the file and copy into the EEPROM.
13. Click **Yes** on the confirmation window that appears.

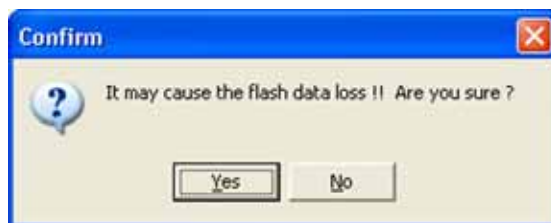

If you receive an error message telling you that the files exceed the total allowable size, do any or all of the following:

- Shorten your messages.
- Save the wave files at a lower quality
- Do not include seldom-used events like FDD Detection, IDE HDD Detection, etc.

This chapter tells how to change the system settings through the BIOS Setup menus. Detailed descriptions of the BIOS parameters are also provided.

BIOS setup

4.1	Managing and updating your BIOS	4-1
4.2	BIOS setup program	4-11
4.3	Main menu	4-14
4.4	Advanced menu	4-19
4.5	Power menu	4-31
4.6	Boot menu	4-36
4.7	Exit menu	4-41

4.1 Managing and updating your BIOS

The following utilities allow you to manage and update the motherboard Basic Input/Output System (BIOS) setup.

1. **ASUS AFUDOS** (Updates the BIOS in DOS mode using a bootable floppy disk.)
2. **ASUS CrashFree BIOS 2** (Updates the BIOS using a bootable floppy disk or the motherboard support CD when the BIOS file fails or gets corrupted.)
3. **ASUS EZ Flash** (Updates the BIOS in DOS mode using a floppy disk or the motherboard support CD.)
4. **ASUS Update** (Updates the BIOS in Windows® environment.)

Refer to the corresponding sections for details on these utilities.



Save a copy of the original motherboard BIOS file to a bootable floppy disk in case you need to restore the BIOS in the future. Copy the original motherboard BIOS using the ASUS Update or AFUDOS utilities.

4.1.1 Creating a bootable floppy disk

1. Do either one of the following to create a bootable floppy disk.

DOS environment

- a. Insert a 1.44MB floppy disk into the drive.
- b. At the DOS prompt, type **format A:/S** then press <Enter>.

Windows® XP environment

- a. Insert a 1.44 MB floppy disk to the floppy disk drive.
- b. Click **Start** from the Windows® desktop, then select **My Computer**.
- c. Select the 3 1/2 Floppy Drive icon.
- d. Click **File** from the menu, then select **Format**. A **Format 3 1/2 Floppy Disk** window appears.
- e. **Windows® XP users:** Select **Create an MS-DOS startup disk** from the format options field, then click **Start**.

Windows® 2000 environment

To create a set of boot disks for Windows® 2000:

- a. Insert a formatted, high density 1.44 MB floppy disk into the drive.
 - b. Insert the Windows® 2000 CD to the optical drive.
 - c. Click **Start**, then select **Run**.
 - d. In the **Open** field, type `D:\bootdisk\makeboot a:` assuming that D is your optical drive letter.
 - e. Press <Enter>, then follow screen instructions to continue.
2. Copy the original or the latest motherboard BIOS file to the bootable floppy disk.

4.1.2 AFUDOS utility

The AFUDOS utility allows you to update the BIOS file in DOS environment using a bootable floppy disk with the updated BIOS file. This utility also allows you to copy the current BIOS file that you can use as backup when the BIOS fails or gets corrupted during the updating process.

Copying the current BIOS

To copy the current BIOS file using the AFUDOS utility:



-
- Make sure that the floppy disk is not write-protected and has at least 600 KB free space to save the file.
 - The succeeding BIOS screens are for reference only. The actual BIOS screen displays may not be same as shown.
-

1. Copy the AFUDOS utility (afudos.exe) from the motherboard support CD to the bootable floppy disk you created earlier.
2. Boot the system in DOS mode, then at the prompt type:

```
afudos /o[filename]
```

where the [filename] is any user-assigned filename not more than eight alphanumeric characters for the main filename and three alphanumeric characters for the extension name.

```
A:\>afudos /oOLDBIOS1 .rom
```

Main filename Extension name

3. Press <Enter>. The utility copies the current BIOS file to the floppy disk.

```
A:\>afudos /oOLDBIOS1.rom
AMI Firmware Update Utility - Version 1.19 (ASUS V2.07(03.11.24BB))
Copyright (C) 2002 American Megatrends, Inc. All rights reserved.
  Reading flash ..... done
  Write to file..... ok
A:\>
```

The utility returns to the DOS prompt after copying the current BIOS file.

Updating the BIOS file

To update the BIOS file using the AFUDOS utility:

1. Visit the ASUS website (www.asus.com) and download the latest BIOS file for the motherboard. Save the BIOS file to a bootable floppy disk.



Write the BIOS filename on a piece of paper. You need to type the exact BIOS filename at the DOS prompt.

2. Copy the AFUDOS utility (afudos.exe) from the motherboard support CD to the bootable floppy disk you created earlier.
3. Boot the system in DOS mode, then at the prompt type:

```
afudos /i[filename]
```

where [filename] is the latest or the original BIOS file on the bootable floppy disk.

```
A:\>afudos /iP5AD2.rom
```

4. The utility verifies the file and starts updating the BIOS.

```
A:\>afudos /iP5AD2.rom
AMI Firmware Update Utility - Version 1.19(ASUS V2.07(03.11.24BB))
Copyright (C) 2002 American Megatrends, Inc. All rights reserved.

WARNING!! Do not turn off power during flash BIOS
Reading file ..... done
Reading flash .... done
Search bootblock version:
0% ██████████ 100%

Advance check ....
Erasing flash .... done
Writing flash .... 0x0008CC00 (9%)
```



Do not shut down or reset the system while updating the BIOS to prevent system boot failure!

5. The utility returns to the DOS prompt after the BIOS update process is completed. Reboot the system from the hard disk drive.

```
A:\>afudos /iP5AD2.rom
AMI Firmware Update Utility - Version 1.19(ASUS V2.07(03.11.24BB))
Copyright (C) 2002 American Megatrends, Inc. All rights reserved.

WARNING!! Do not turn off power during flash BIOS
Reading file ..... done
Reading flash .... done
Search bootblock version:
0% ██████████ 100%

Advance check ....
Erasing flash .... done
Writing flash .... done
Verifying flash .. DONE

Please restart your computer

A:\>
```

4.1.3 ASUS CrashFree BIOS 2 utility

The ASUS CrashFree BIOS 2 is an auto recovery tool that allows you to restore the BIOS file when it fails or gets corrupted during the updating process. You can update a corrupted BIOS file using the motherboard support CD or the floppy disk that contains the updated BIOS file.



- Prepare the motherboard support CD or the floppy disk containing the updated motherboard BIOS before using this utility.
- Make sure that you rename the original or updated BIOS file in the floppy disk to **P5AD2.ROM**.

Recovering the BIOS from a floppy disk

To recover the BIOS from a floppy disk:

1. Turn on the system.
2. Insert the floppy disk with the original or updated BIOS file to the floppy disk drive.
3. The utility displays the following message and automatically checks the floppy disk for the original or updated BIOS file.

```
Bad BIOS checksum. Starting BIOS recovery...
Checking for floppy...
```

When found, the utility reads the BIOS file and starts flashing the corrupted BIOS file.

```
Bad BIOS checksum. Starting BIOS recovery...
Checking for floppy...
Floppy found!
Reading file "P5AD2.ROM". Completed.
Start flashing...
```



DO NOT shut down or reset the system while updating the BIOS! Doing so can cause system boot failure!

4. Restart the system after the utility completes the updating process.

Recovering the BIOS from the support CD

To recover the BIOS from the support CD:

1. Remove any floppy disk from the floppy disk drive, then turn on the system.
2. Insert the support CD to the optical drive.
3. The utility displays the following message and automatically checks the floppy disk for the original or updated BIOS file.

```
Bad BIOS checksum. Starting BIOS recovery...  
Checking for floppy...
```

When no floppy disk is found, the utility automatically checks the optical drive for the original or updated BIOS file. The utility then updates the corrupted BIOS file.

```
Bad BIOS checksum. Starting BIOS recovery...  
Checking for floppy...  
Floppy not found!  
Checking for CD-ROM...  
CD-ROM found!  
Reading file "P5AD2.ROM". Completed.  
Start flashing...
```



DO NOT shut down or reset the system while updating the BIOS! Doing so can cause system boot failure!

4. Restart the system after the utility completes the updating process.



The recovered BIOS may not be the latest BIOS version for this motherboard. Visit the ASUS website (www.asus.com) to download the latest BIOS file.

4.1.4 ASUS EZ Flash utility

The ASUS EZ Flash feature allows you to update the BIOS without having to go through the long process of booting from a floppy disk and using a DOS-based utility. The EZ Flash utility is built-in the BIOS chip so it is accessible by pressing <Alt> + <F2> during the Power-On Self Tests (POST).

To update the BIOS using EZ Flash:

1. Visit the ASUS website (www.asus.com) to download the latest BIOS file for the motherboard and rename the same to **P5AD2.ROM**.
2. Save the BIOS file to a floppy disk, then restart the system.
3. Press <Alt> + <F2> during POST to display the following.

```
EZFlash starting BIOS update
Checking for floppy...
```

4. Insert the floppy disk that contains the BIOS file to the floppy disk drive. When the correct BIOS file is found, EZ Flash performs the BIOS update process and automatically reboots the system when done.

```
EZFlash starting BIOS update
Checking for floppy...
Floppy found!
Reading file "P5AD2.rom". Completed.
Start erasing.....|
Start programming...|
Flashed successfully. Rebooting.
```



- Do not shutdown or reset the system while updating the BIOS to prevent system boot failure!
- A “Floppy not found!” error message appears if there is no floppy disk in the drive. A “P5AD2.ROM not found!” error message appears if the correct BIOS file is not found in the floppy disk. Make sure that you rename the BIOS file to P5AD2.ROM.

4.1.5 ASUS Update utility

The ASUS Update is a utility that allows you to manage, save, and update the motherboard BIOS in Windows® environment. The ASUS Update utility allows you to:

- Save the current BIOS file
- Download the latest BIOS file from the Internet
- Update the BIOS from an updated BIOS file
- Update the BIOS directly from the Internet, and
- View the BIOS version information.

This utility is available in the support CD that comes with the motherboard package.



ASUS Update requires an Internet connection either through a network or an Internet Service Provider (ISP).

Installing ASUS Update

To install ASUS Update:

1. Place the support CD in the optical drive. The **Drivers** menu appears.
2. Click the **Utilities** tab, then click **Install ASUS Update VX.XX.XX**. See page 5-4 for the **Utilities** screen menu.
3. The ASUS Update utility is copied to your system.



Quit all Windows® applications before you update the BIOS using this utility.

Updating the BIOS through the Internet

To update the BIOS through the Internet:

1. Launch the ASUS Update utility from the Windows® desktop by clicking **Start > Programs > ASUS > ASUSUpdate > ASUSUpdate**. The ASUS Update main window appears.

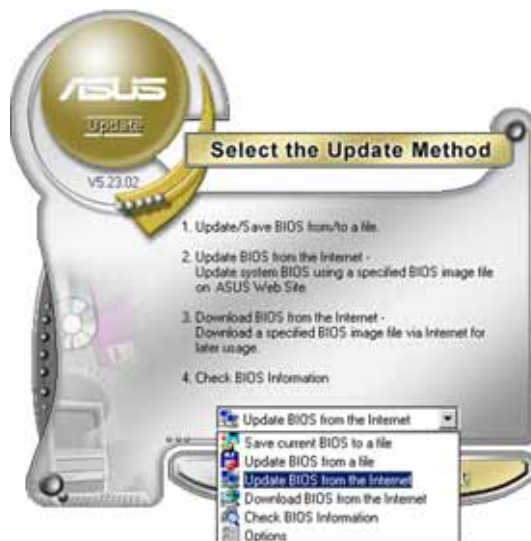
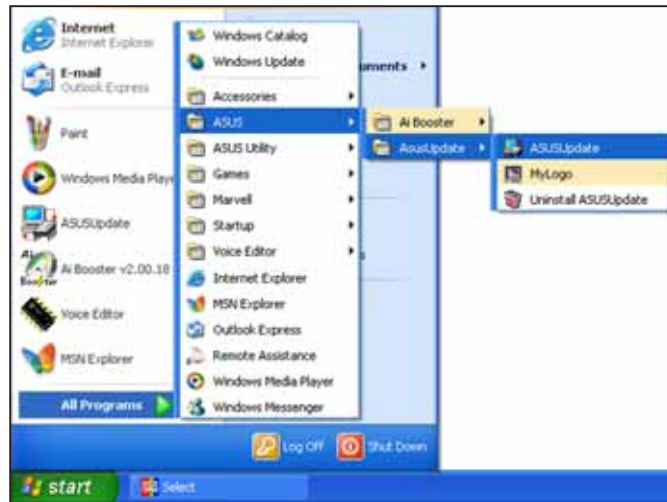

2. Select **Update BIOS from the Internet** option from the drop-down menu, then click **Next**.



3. Select the ASUS FTP site nearest you to avoid network traffic, or click **Auto Select**. Click **Next**.

4. From the FTP site, select the BIOS version that you wish to download. Click Next.
5. Follow the screen instructions to complete the update process.



The ASUS Update utility is capable of updating itself through the Internet. Always update the utility to avail all its features.



Updating the BIOS through a BIOS file

To update the BIOS through a BIOS file:

1. Launch the ASUS Update utility from the Windows® desktop by clicking **Start > Programs > ASUS > ASUSUpdate > ASUSUpdate**. The ASUS Update main window appears.
2. Select **Update BIOS from a file** option from the drop-down menu, then click **Next**.

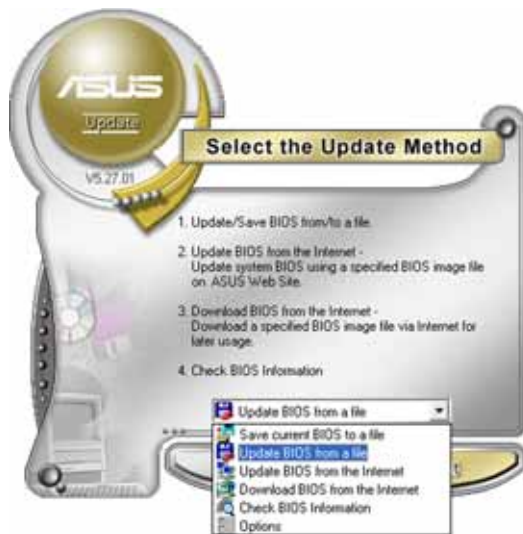

3. Locate the BIOS file from the **Open** window, then click **Save**.
4. Follow the screen instructions to complete the update process.

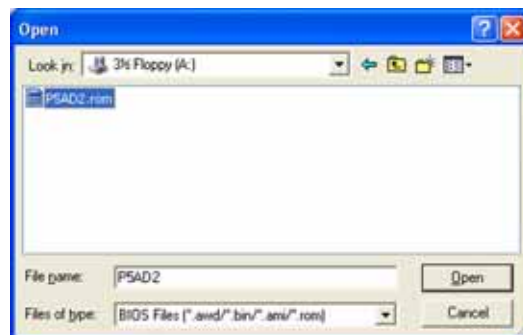

4.2 BIOS setup program

This motherboard supports a programmable firmware chip that you can update using the provided utility described in section “4.1 Managing and updating your BIOS.”

Use the BIOS Setup program when you are installing a motherboard, reconfiguring your system, or prompted to “Run Setup”. This section explains how to configure your system using this utility.

Even if you are not prompted to use the Setup program, you can change the configuration of your computer in the future. For example, you can enable the security password feature or change the power management settings. This requires you to reconfigure your system using the BIOS Setup program so that the computer can recognize these changes and record them in the CMOS RAM of the firmware hub.

The firmware hub on the motherboard stores the Setup utility. When you start up the computer, the system provides you with the opportunity to run this program. Press during the Power-On-Self-Test (POST) to enter the Setup utility; otherwise, POST continues with its test routines.

If you wish to enter Setup after POST, restart the system by pressing <Ctrl+Alt+Delete>, or by pressing the reset button on the system chassis. You can also restart by turning the system off and then back on. Do this last option only if the first two failed.

The Setup program is designed to make it as easy to use as possible. Being a menu-driven program, it lets you scroll through the various sub-menus and make your selections from the available options using the navigation keys.



-
- The default BIOS settings for this motherboard apply for most conditions to ensure optimum performance. If the system becomes unstable after changing any BIOS settings, load the default settings to ensure system compatibility and stability. Select the **Load Default Settings** item under the Exit Menu. See section “4.7 Exit Menu.”
 - The BIOS setup screens shown in this section are for reference purposes only, and may not exactly match what you see on your screen.
 - Visit the ASUS website (www.asus.com) to download the latest BIOS file for this motherboard.
-

4.2.1 BIOS menu screen

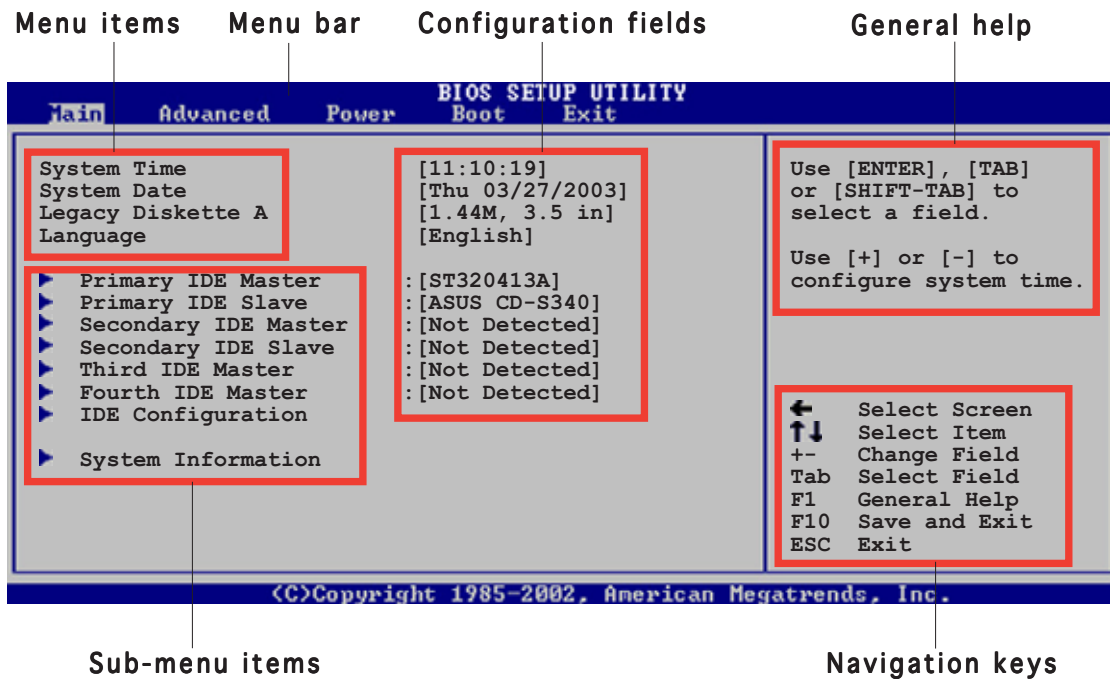

4.2.2 Menu bar

The menu bar on top of the screen has the following main items:

- Main** For changing the basic system configuration
- Advanced** For changing the advanced system settings
- Power** For changing the advanced power management (APM) configuration
- Boot** For changing the system boot configuration
- Exit** For selecting the exit options and loading default settings

To select an item on the menu bar, press the right or left arrow key on the keyboard until the desired item is highlighted.

4.2.3 Navigation keys

At the bottom right corner of a menu screen are the navigation keys for that particular menu. Use the navigation keys to select items in the menu and change the settings.



Some of the navigation keys differ from one screen to another.

4.2.4 Menu items

The highlighted item on the menu bar displays the specific items for that menu. For example, selecting **Main** shows the Main menu items.

The other items (Advanced, Power, Boot, and Exit) on the menu bar have their respective menu items.

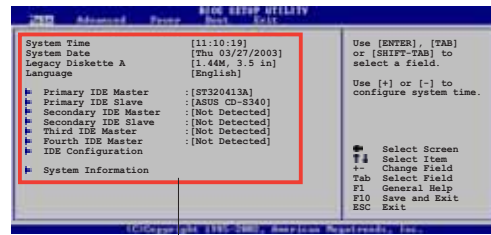

Main menu items

4.2.5 Sub-menu items

A solid triangle before each item on any menu screen means that the item has a sub-menu. To display the sub-menu, select the item and press <Enter>.

4.2.6 Configuration fields

These fields show the values for the menu items. If an item is user-configurable, you can change the value of the field opposite the item. You cannot select an item that is not user-configurable.

A configurable field is enclosed in brackets, and is highlighted when selected. To change the value of a field, select it then press <Enter> to display a list of options. Refer to “4.2.7 Pop-up window.”

4.2.7 Pop-up window

Select a menu item then press <Enter> to display a pop-up window with the configuration options for that item.

4.2.8 Scroll bar

A scroll bar appears on the right side of a menu screen when there are items that do not fit on the screen. Press the Up/Down arrow keys or <Page Up> / <Page Down> keys to display the other items on the screen.

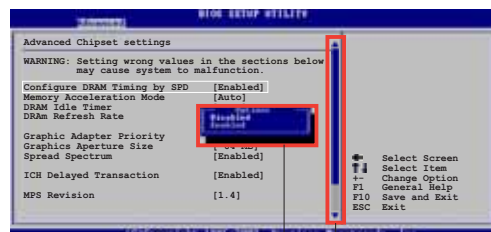

Pop-up window

Scroll bar

4.2.9 General help

At the top right corner of the menu screen is a brief description of the selected item.

4.3 Main menu

When you enter the BIOS Setup program, the **Main** menu screen appears, giving you an overview of the basic system information.



Refer to section “4.2.1 BIOS menu screen” for information on the menu screen items and how to navigate through them.

```
BIOS SETUP UTILITY
Main  Advanced  Power  Boot  Exit

System Time           [11:51:19]
System Date           [Thu 05/07/2004]
Legacy Diskette A    [1.44M, 3.5 in]
Language              [English]

▶ Primary IDE Master   : [ST320413A]
▶ Primary IDE Slave   : [ASUS CD-S520/A]
▶ Third IDE Master    : [Not Detected]
▶ Third IDE Slave     : [Not Detected]
▶ Fourth IDE Master   : [Not Detected]
▶ Fourth IDE Slave    : [Not Detected]
▶ IDE Configuration

▶ System Information

Use [ENTER], [TAB]
or [SHIFT-TAB] to
select a field.

Use [+] or [-] to
configure system time.

← Select Screen
↑↓ Select Item
+- Change Field
Tab Select Field
F1 General Help
F10 Save and Exit
ESC Exit

<C>Copyright 1985-2002, American Megatrends, Inc.
```

4.3.1 System Time [xx:xx:xxxx]

Allows you to set the system time.

4.3.2 System Date [Day xx/xx/xxxx]

Allows you to set the system date.

4.3.3 Legacy Diskette A [1.44M, 3.5 in.]

Sets the type of floppy drive installed. Configuration options: [Disabled]
[360K, 5.25 in.] [1.2M, 5.25 in.] [720K, 3.5 in.] [1.44M, 3.5 in.]
[2.88M, 3.5 in.]

4.3.4 Language [English]

Allows you to choose the BIOS language version from the options.
Configuration options: [English] [Français] [Deutsch] [Japanese]
[Chinese (GB)] [Chinese BIG5]

4.3.5 Primary, Third and Fourth IDE Master/Slave

The BIOS automatically detects the connected IDE devices. There is a separate sub-menu for each IDE device. Select a device item, then press <Enter> to display the IDE device information.

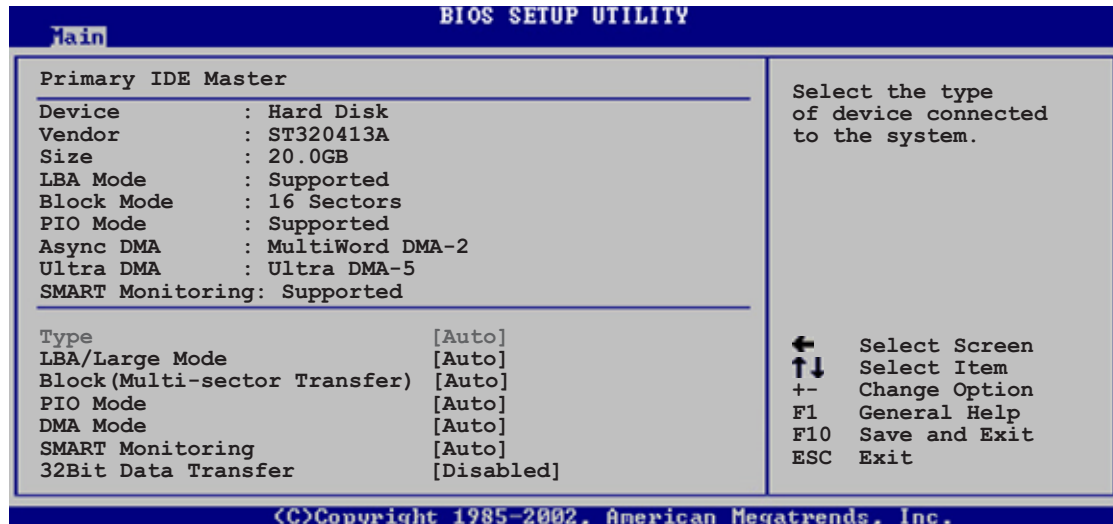

The BIOS automatically detects the values opposite the dimmed items (Device, Vendor, Size, LBA Mode, Block Mode, PIO Mode, Async DMA, Ultra DMA, and SMART monitoring). These values are not user-configurable. These items show N/A if no IDE device is installed in the system.

Type [Auto]

Selects the type of IDE drive. Setting to [Auto] allows automatic selection of the appropriate IDE device type. Select [CDROM] if you are specifically configuring a CD-ROM drive. Select [ARMD] (ATAPI Removable Media Device) if your device is either a ZIP, LS-120, or MO drive. Configuration options: [Not Installed] [Auto] [CDROM] [ARMD]

LBA/Large Mode [Auto]

Enables or disables the LBA mode. Setting to [Auto] enables the LBA mode if the device supports this mode, and if the device was not previously formatted with LBA mode disabled. Configuration options: [Disabled] [Auto]

Block (Multi-sector Transfer) [Auto]

Enables or disables data multi-sectors transfers. When set to [Auto], the data transfer from and to the device occurs multiple sectors at a time if the device supports multi-sector transfer feature. When set to [Disabled], the data transfer from and to the device occurs one sector at a time. Configuration options: [Disabled] [Auto]

PIO Mode [Auto]

Selects the PIO mode.

Configuration options: [Auto] [0] [1] [2] [3] [4]

SMART Monitoring [Auto]

Sets the Smart Monitoring, Analysis, and Reporting Technology.

Configuration options: [Auto] [Disabled] [Enabled]

32Bit Data Transfer [Disabled]

Enables or disables 32-bit data transfer.

Configuration options: [Disabled] [Enabled]

4.3.6 IDE Configuration

The items in this menu allow you to set or change the configurations for the IDE devices installed in the system. Select an item then press <Enter> if you wish to configure the item.

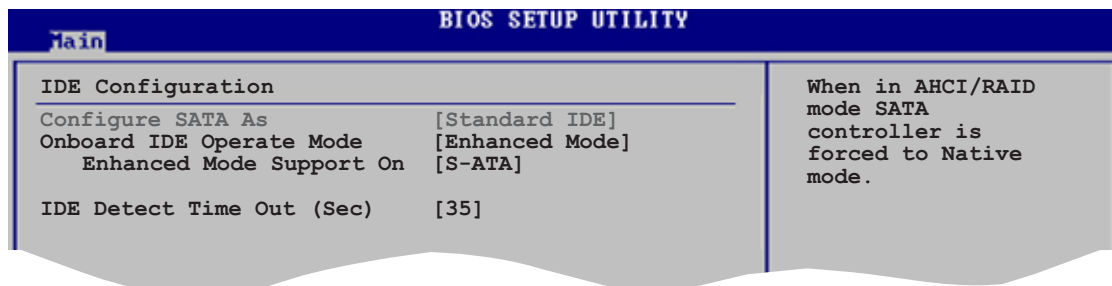

Configure SATA As [Standard IDE]

Allows you to set the Serial ATA devices connected to the Serial ATA connectors as IDE, AHCI, or RAID sets.

Configuration options: [Standard IDE] [AHCI] [RAID]

Onboard IDE Operate Mode [Enhanced Mode]

Allows selection of the IDE operation mode depending on the installed operating system (OS). Set to [Enhanced Mode] if you are using native OS including Windows® 2000/XP. Configuration options: [Compatible Mode] [Enhanced Mode]

Enhanced Mode Support On [S-ATA]

Allows you to use native OS on Serial ATA and Parallel ATA ports. It is recommended that you do not change the default setting for better OS compatibility. In this setting, you may use legacy OS on the Parallel ATA ports only if you do not install any Serial ATA device.

The P-ATA+S-ATA and P-ATA options are for advanced users only. If you set to any of these options and encountered problems, revert to the default setting **S-ATA**. Configuration options: [P-ATA+S-ATA] [S-ATA] [P-ATA]



The **Onboard IDE Operate Mode** and its sub-menu items appear only when the **Configure SATA As** item is set to [Standard IDE].

Onboard Serial-ATA BOOTROOM [Enabled]

Enables or disables the onboard Serial ATA boot ROM. This item appears only when the Configure SATA As item is set as RAID. Configuration options: [Disabled] [Enabled]



The **Onboard Serial-ATA BOOTROM** appears only when the **Configure SATA As** item is set to [RAID].

ALPE and ASP [Disabled]

Allows you to enable or disable the Aggressive Link Power Management (ALPE) and Aggressive Slumber/Partial (ASP) management features. Configuration options: [Disabled] [Enabled]

Stagger Spinup Support [Enabled]

Enables or disables the stagger spinup support. Configuration options: [Disabled] [Enabled]

AHCI Port 3 Interlock Switch [Disabled]

Enables or disables the Advanced Host Controller Interface (AHCI) Port 3 interlock switch. Configuration options: [Disabled] [Enabled]



The **ALPE and ASP** and its sub-menu appear only when the **Configure SATA As** item is set to [AHCI].

IDE Detect Time Out [35]

Selects the time out value for detecting ATA/ATAPI devices. Configuration options: [0] [5] [10] [15] [20] [25] [30] [35]

4.3.7 System Information

This menu gives you an overview of the general system specifications. The BIOS automatically detects the items in this menu.

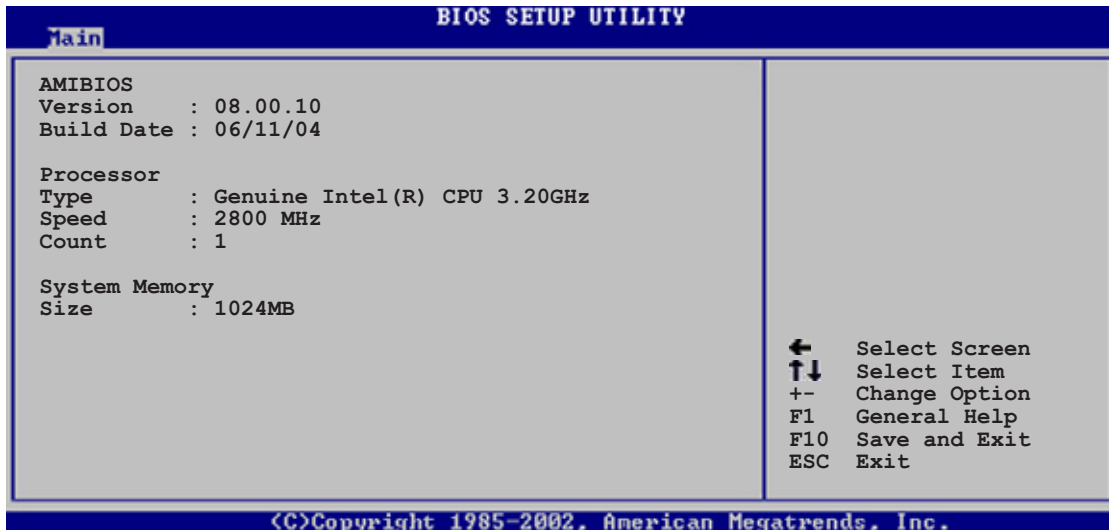

```
BIOS SETUP UTILITY
Main
AMIBIOS
Version : 08.00.10
Build Date : 06/11/04

Processor
Type : Genuine Intel(R) CPU 3.20GHz
Speed : 2800 MHz
Count : 1

System Memory
Size : 1024MB

← Select Screen
↑↓ Select Item
+- Change Option
F1 General Help
F10 Save and Exit
ESC Exit

<C>Copyright 1985-2002, American Megatrends, Inc.
```

AMI BIOS

Displays the auto-detected BIOS information

Processor

Displays the auto-detected CPU specification

System Memory

Displays the auto-detected system memory

4.4 Advanced menu

The Advanced menu items allow you to change the settings for the CPU and other system devices.



Take caution when changing the settings of the Advanced menu items. Incorrect field values can cause the system to malfunction.

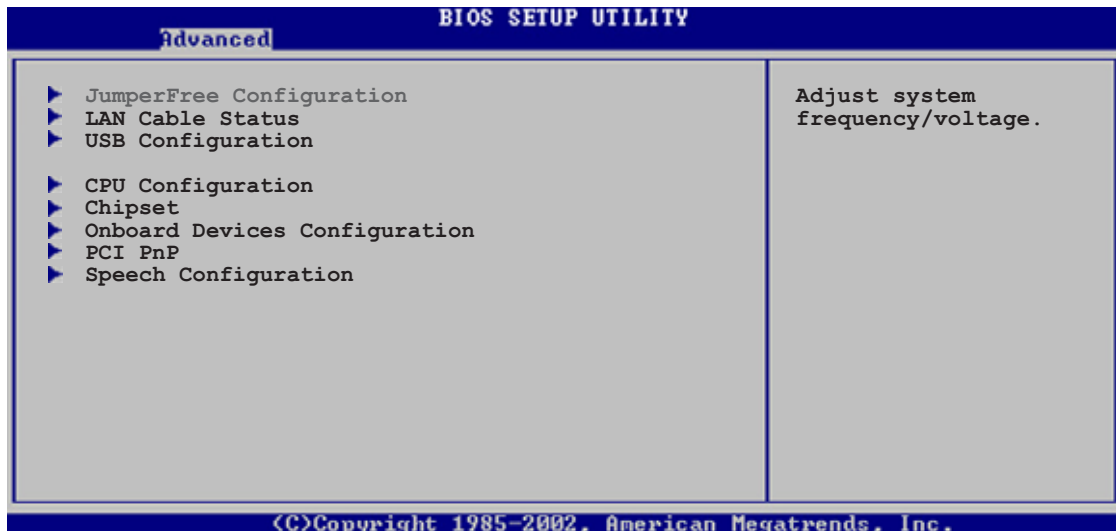

4.4.1 JumperFree Configuration

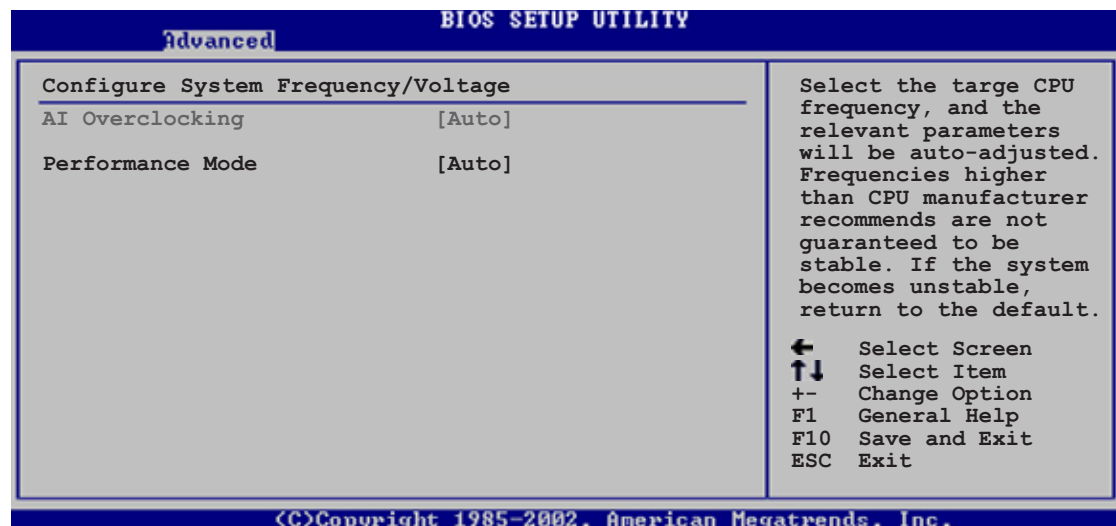

AI Overclocking [Auto]

Allows you to select the overclocking options to achieve the desired CPU internal frequency. Select either one of the preset overclocking options. Configuration options: [Manual] [Auto] [Standard] [Overclock Profile] [AI NOS].



Selecting a very high CPU frequency may cause the system to become unstable! If this happens, revert to the default setting.

Performance Mode [Auto]

Allows you to select the system performance mode.
Configuration options: [Auto] [Standard] [Turbo]



The following item appears only when you set the **AI Overclocking** item to [Manual].

CPU Frequency [XXX]

Displays the frequency sent by the clock generator to the system bus and PCI bus. The value of this item is auto-detected by the BIOS. Use the <+> and <-> keys to adjust the CPU frequency. You can also type the desired CPU frequency using the numeric keypad. The values range from 100 to 400. Refer to the table below for the correct Front Side Bus and CPU External Frequency settings.

FSB/CPU External Frequency Synchronization

Front Side Bus	CPU External Frequency
FSB 800	200 MHz
FSB 533	133 MHz
FSB 400	100 MHz

DRAM Frequency [Auto]

Allows you to set the DDR operating frequency.
Configuration options: [Auto] [400MHz] [533MHz] [600MHz]



Selecting a very high DRAM frequency may cause the system to become unstable! If this happens, revert to the default setting.

PCI Express Frequency [Auto]

Allows you to set the PCI Express frequency. This item is set to [Auto] by default. Configuration options: [Auto] [90]...[133]

PCI Clock Synchronization Mode [Auto]

Allows you to synchronize the PCI frequency with the PCI Express or CPU frequency. Configuration options: [To CPU] [33.33MHz] [Auto]

Spread Spectrum [Auto]

Allows you to enable or disable the clock generator spread spectrum.
Configuration options: [Disabled] [Enabled] [Auto]



The following items also appear when the **AI Overclocking** item is set to [AI NOS].

Memory Voltage [Auto]

Allows you to select the DDR2 reference voltage.

Configuration options: [1.80V] [1.90V] [2.00V] [2.10V] [Auto]



Refer to the DDR2 documentation before adjusting the memory voltage. Setting a very high memory voltage may damage the memory module(s)!

Chipset Core Voltage [Auto]

Allows you to select the chipset core voltage.

Configuration options: [1.50V] [1.60V] [Auto]



Refer to the CPU documentation before setting the chipset core voltage. Setting a high chipset core voltage may damage the chipset!

CPU VCore Voltage [Auto]

Allows you to select the CPU VCore voltage. Configuration options: [Auto]

[1.7000V] [1.6875V] [1.6750V] [1.6625V] [1.6500V] [1.6375V]

[1.6250V] [1.6125V] [1.6000V] [1.5875V] [1.5750V] [1.5625V]

[1.5500V] [1.5375V] [1.5250V] [1.5125V] [1.5000V] [1.4875V]

[1.4750V] [1.4625V] [1.4500V] [1.4375V] [1.4250V] [1.4125V]

[1.4000V] [1.3875V]



Setting a high Vcore voltage may damage the CPU!

FSB Termination Voltage [Auto]

Allows you to select the front side bus termination voltage.

Configuration options: [1.20V] [1.40V] [Auto]



The following item appears only when the **AI Overclocking** item is set to [Overclock Profile].

Overclock Options [Overclock 5%]

Allows you to overclock the CPU speed through the available preset values.

Configuration options: [Overclock 5%] [FSB888/DDR2-667]
[Overclock 10%] [FSB900/DDR2-600]
[Overclock 15%] [FSB950/DDR2-633]
[Overclock 20%] [FSB1000/DDR2-667]
[Overclock 30%] [FSB1066/DDR2-533]
[FSB1066/DDR2-710]



The following item appears only when the **AI Overclocking** item is set to [AI NOS].

NOS Mode [Auto]

Allows you to set the NOS mode for various CPU loading. Selecting [Auto] allows the NOS to automatically overclock the CPU speed based on the CPU loading. Configuration options: [Auto] [Standard] [Sensitive] [Heavy Load]



The following item appears only when the **NOS Mode** item is set to [Standard], [Sensitive], or [Heavy].

Turbo NOS [Disabled]

Allows you to disable or set the overclock percentage for the selected NOS Mode. Configuration options: [Disabled] [Overclock 3%] [Overclock 5%] [Overclock 7%] [Overclock 10%] [Overclock 15%] [Overclock 20%]

Twin Turbo NOS [Disabled]

Allows you to disable or set the overclock percentage for the selected Turbo NOS. Configuration options: [Disabled] [Overclock 3%] [Overclock 5%] [Overclock 7%] [Overclock 10%] [Overclock 15%] [Overclock 20%] [Overclock 30%]

4.4.2 LAN Cable Status

This menu displays the status of the Local Area Network (LAN) cable connected to the LAN (RJ-45) port.

Advanced			BIOS SETUP UTILITY
POST Check LAN Cable [Disabled]			Check LAN cable during POST.
LAN Cable Status			
Pair	Status	Length	
1-2	Normal	N/A	
3-6	Normal	N/A	
4-5	Normal	N/A	
7-8	Normal	N/A	

POST Check LAN Cable [Disabled]

Allows you to enable or disable LAN cable check during POST. When enabled, the menu reports the cable faults or shorts, and displays the point (length) where the fault or short is detected.

Configuration options: [Enabled] [Disabled]

4.4.3 USB Configuration

The items in this menu allows you to change the USB-related features. Select an item then press <Enter> to display the configuration options.

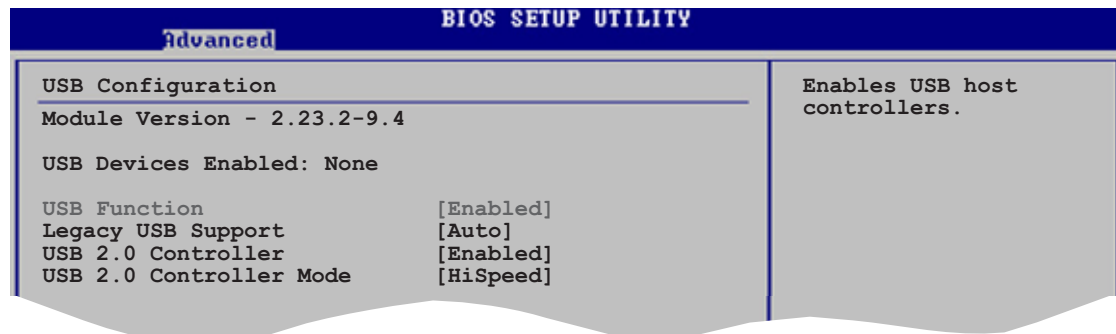

The **Module Version** and **USB Devices Enabled** items show the auto-detected values. If no USB device is detected, the item shows **None**.

USB Function [Enabled]

Allows you to enable or disable the USB function.
Configuration options: [Disabled] [Enabled]

Legacy USB Support [Auto]

Allows you to enable or disable support for legacy USB devices. Setting to [Auto] allows the system to detect the presence of USB devices at startup. If detected, the USB controller legacy mode is enabled. If no USB device is detected, the legacy USB support is disabled.
Configuration options: [Disabled] [Enabled] [Auto]

USB 2.0 Controller [Enabled]

Allows you to enable or disable the USB 2.0 controller.
Configuration options: [Enabled] [Disabled]

USB 2.0 Controller Mode [HiSpeed]

Allows you to set the USB 2.0 controller mode to HiSpeed (480 Mbps) or FullSpeed (12 Mbps). Configuration options: [FullSpeed] [HiSpeed]

4.4.4 CPU Configuration

The items in this menu show the CPU-related information that the BIOS automatically detects.

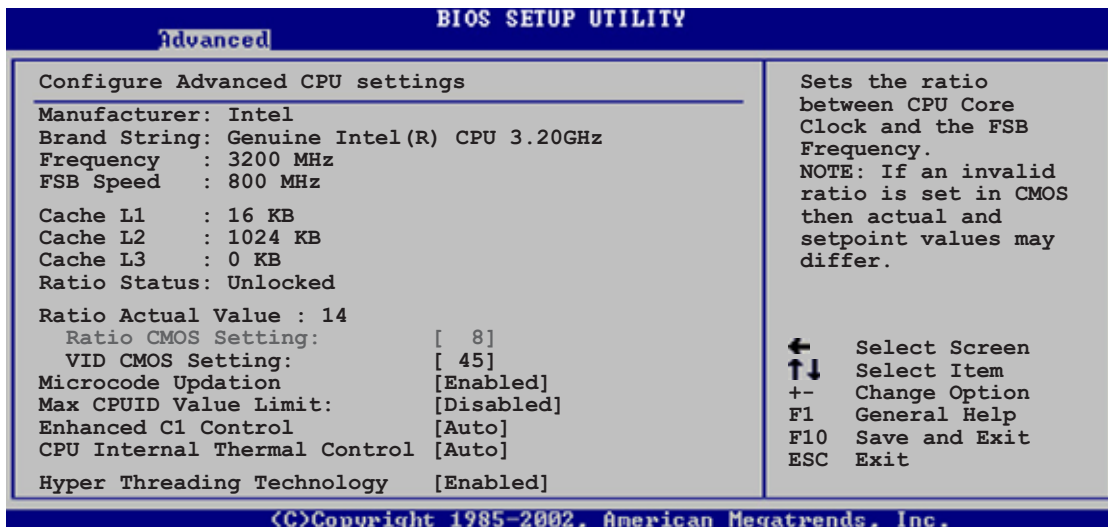

Ratio CMOS Setting [8]

Sets the ratio between the CPU core clock and the Front Side Bus frequency. The BIOS auto-detects the default value of this item. Use the <+> or <-> keys to adjust the values. Configuration options: [8]...[28]

VID CMOS Setting [45]

Allows you to set the VID CMOS setting at which the processor is to run. The BIOS auto-detects the default value of this item. Use the <+> or <-> keys to adjust the values.



You can only adjust the **Ratio CMOS** and the **VID CMOS** settings if you installed an unlocked CPU. Refer to the CPU documentation for details.

Microcode Updation [Enabled]

Allows you to enable or disable the microcode updation. Configuration options: [Disabled] [Enabled]

Max CPUID Value Limit [Disabled]

Setting this item to [Enabled] allows legacy operating systems to boot even without support for CPUs with extended CPUID functions. Configuration options: [Disabled] [Enabled]

Enhanced C1 Control [Auto]

When set to [Auto], the BIOS automatically checks the CPU's capability to enable the C1E support. In C1E mode, the CPU power consumption is lower when idle. Configuration options: [Auto] [Disabled]

CPU Internal Thermal Control [Auto]

Allows you to disable or set to auto the CPU Internal Thermal Control function. Configuration options: [Auto] [Disabled]

Hyper-Threading Technology [Enabled]

Allows you to enable or disable the processor Hyper-Threading Technology. Configuration options: [Disabled] [Enabled]

4.4.5 Chipset

The Chipset menu allows you to change the advanced chipset settings. Select an item then press <Enter> to display the sub-menu.

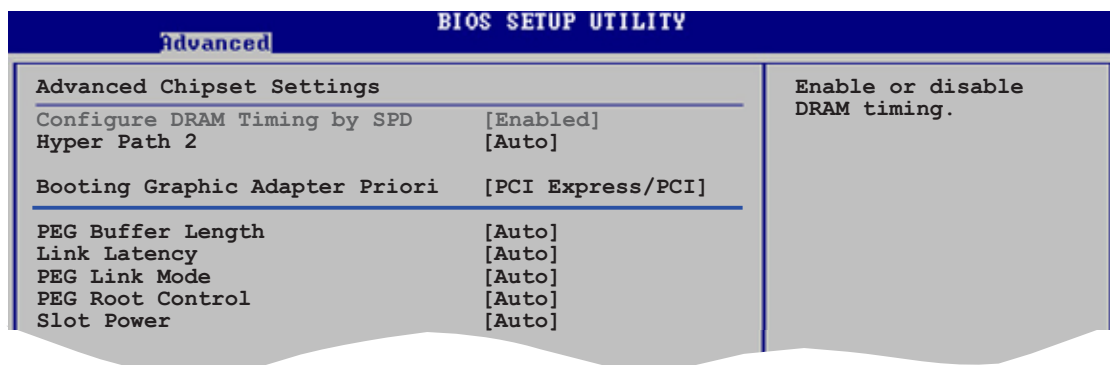

Advanced Chipset Settings

Configure DRAM Timing by SPD [Enabled]

When this item is enabled, the DRAM timing parameters are set according to the DRAM SPD (Serial Presence Detect). When disabled, you can manually set the DRAM timing parameters through the DRAM sub-items. The following sub-items appear when this item is Disabled.

Configuration options: [Disabled] [Enabled]

DRAM CAS# Latency [5 Clocks]

Controls the latency between the SDRAM read command and the time the data actually becomes available.

Configuration options: [5 Clocks] [4 Clocks] [3 Clocks]

DRAM RAS# Precharge [4 Clocks]

Controls the idle clocks after issuing a precharge command to the DDR SDRAM. Configuration options: [2 Clocks] [3 Clocks] [4 Clocks] [5 Clocks]

DRAM RAS# to CAS# Delay [4 Clocks]

Controls the latency between the DDR SDRAM active command and the read/write command. Configuration options: [2 Clocks] [3 Clocks] [4 Clocks] [5 Clocks]

DRAM RAS# Activate to Precharge Delay [15 Clocks]

Configuration options: [4 Clocks] [5 Clocks] ~ [15 Clocks]

DRAM Write Recovery Time [4 Clocks]

Configuration options: [2 Clocks] [3 Clocks] [4 Clocks] [5 Clocks]

Hyper Path 2 [Auto]

Allows you to enable or disable the ASUS Hyper Path 2 feature.

Configuration options: [Disabled] [Enabled] [Auto]

Booting Graphic Adapter Priority [PCI Express/PCI]

Allows selection of the graphics controller to use as primary boot device.

Configuration options: [PCI Express/PCI] [PCI/PCI Express]

PEG Buffer Length [Auto]

Sets the length of the PCI Express graphics card buffer.

Configuration options: [Auto] [Long] [Short]

Link Latency [Auto]

Sets the PCI Express graphics card link latency.

Configuration options: [Auto] [Slow] [Normal]

PEG Link Mode [Auto]

Sets the PCI Express graphics card link mode.

Configuration options: [Auto] [Slow] [Normal] [Fast] [Faster]

PEG Root Control [Auto]

Allows you to enable, disable, or set to automatic the PCI Express graphics card root control. Configuration options: [Auto] [Disabled] [Enabled]

Slot Power [Auto]

Sets the PCI Express graphics card slot power.

Configuration options: [Auto] [Light] [Normal] [Heavy] [Heavier]

4.4.6 Onboard Devices Configuration

Advanced		BIOS SETUP UTILITY
Configure Win627EHF Super IO Chipset		Enable or disable Azalia Controller.
Azalia Controller	[Enabled]	
Front Panel Support Type	[AC97]	
Onboard 1394 Controller	[Enabled]	
Onboard PCIEX GbE LAN	[Enabled]	
LAN Option ROM	[Disabled]	
Onboard WIFI Controller	[Enabled]	
ITE8212F Controller	[IDE Mode]	
Detecting Device Time	[Quick Mode]	
Silicon Image Controller	[RAID Mode]	
Serial Port1 Address	[3F8/IRQ4]	
Parallel Port Address	[378]	
Parallel Port Mode	[ECP]	
ECP Mode DMA Channel	[DMA3]	
Parallel Port IRQ	[IRQ7]	
Onboard Game/MIDI Port	[Disabled]	

(C)Copyright 1985-2002, American Megatrends, Inc.

Azalia Controller [Enabled]

Allows you to enable or disable the high-definition audio CODEC.
Configuration options: [Enabled] [Disabled]

Front Panel Support Type [AC97]

Allows you to set the front panel audio connector (AAAF) mode to legacy AC'97 or high-definition audio depending on the audio standard that the front panel audio module supports. Configuration options: [AC '97] [Azalia]

OnBoard 1394 Controller [Enabled]

Allows you to enable or disable the onboard IEEE 1394 controller.
Configuration options: [Disabled] [Enabled]

OnBoard PCIEX GbE LAN [Enabled]

Allows you to enable or disable the onboard PCI Express Gigabit LAN controller. Configuration options: [Disabled] [Enabled]



The Gigabit LAN controller does not support S5 Wake-On-LAN function under DOS mode or Windows® ME.

LAN Option ROM [Disabled]

This item allows you to enable or disable the option ROM in the onboard LAN controller. This item appears only when the **Onboard PCIEX Gbe LAN** items are set to Enabled.
Configuration options: [Disabled] [Enabled]

OnBoard WiFi Controller [Enabled]

Allows you to enable or disable the onboard Wi-Fi controller.

Configuration options: [Disabled] [Enabled]

ITE8212F Controller [IDE Mode]

Allows you to set the onboard ITE® 8212F IDE RAID controller operating mode. Configuration options: [RAID Mode] [IDE Mode] [Disabled]

Detecting Device Time [Quick Mode]

Sets the time the ITE8212F IDE RAID controller detects devices connected to the IDE RAID connectors. This item appears only when the **ITE8212F Controller** is set to IDE Mode.

Configuration options: [Standard Mode] [Quick Mode]

Silicon Image Controller [RAID Mode]

Allows you to enable or disable the onboard Silicon Image SATA RAID controller. Configuration options: [RAID Mode] [SATA Mode] [Disabled]

Serial Port1 Address [3F8/IRQ4]

Allows you to select the Serial Port1 base address.

Configuration options: [Disabled] [3F8/IRQ4] [3E8/IRQ4] [2E8/IRQ3]

Parallel Port Address [378]

Allows you to select the Parallel Port base addresses.

Configuration options: [Disabled] [378] [278] [3BC]

Parallel Port Mode [ECP]

Allows you to select the Parallel Port mode.

Configuration options: [Normal] [Bi-directional] [EPP] [ECP]

ECP Mode DMA Channel [DMA3]

Appears only when the Parallel Port Mode is set to [ECP]. This item allows you to set the Parallel Port ECP DMA.

Configuration options: [DMA0] [DMA1] [DMA3]

Parallel Port IRQ [IRQ7]

Configuration options: [IRQ5] [IRQ7]

Onboard Game/MIDI Port [Disabled]

Allows you to select the Game Port address or to disable the port.

Configuration options: [Disabled] [200/300] [200/330] [208/300] [208/330]

4.4.7 PCI PnP

The PCI PnP menu items allow you to change the advanced settings for PCI/PnP devices. The menu includes setting IRQ and DMA channel resources for either PCI/PnP or legacy ISA devices, and setting the memory size block for legacy ISA devices.



Take caution when changing the settings of the PCI PnP menu items. Incorrect field values can cause the system to malfunction.



Plug And Play O/S [No]

When set to [No], BIOS configures all the devices in the system. When set to [Yes] and if you install a Plug and Play operating system, the operating system configures the Plug and Play devices not required for boot.

Configuration options: [No] [Yes]

PCI Latency Timer [64]

Allows you to select the value in units of PCI clocks for the PCI device latency timer register. Configuration options: [32] [64] [96] [128] [160] [192] [224] [248]

Allocate IRQ to PCI VGA [Yes]

When set to [Yes], BIOS assigns an IRQ to PCI VGA card if the card requests for an IRQ. When set to [No], BIOS does not assign an IRQ to the PCI VGA card even if requested. Configuration options: [No] [Yes]

Palette Snooping [Disabled]

When set to [Enabled], the palette snooping feature informs the PCI devices that an ISA graphics device is installed in the system so that the latter can function correctly. Configuration options: [Disabled] [Enabled]

PCI IDE BusMaster [Enabled]

Allows BIOS to use PCI bus mastering when reading/writing to IDE devices.
Configuration options: [Disabled] [Enabled]

IRQ-xx assigned to [PCI Device]

When set to [PCI Device], the specific IRQ is free for use of PCI/PnP devices. When set to [Reserved], the IRQ is reserved for legacy ISA devices. Configuration options: [PCI Device] [Reserved]

4.4.8 Speech Configuration

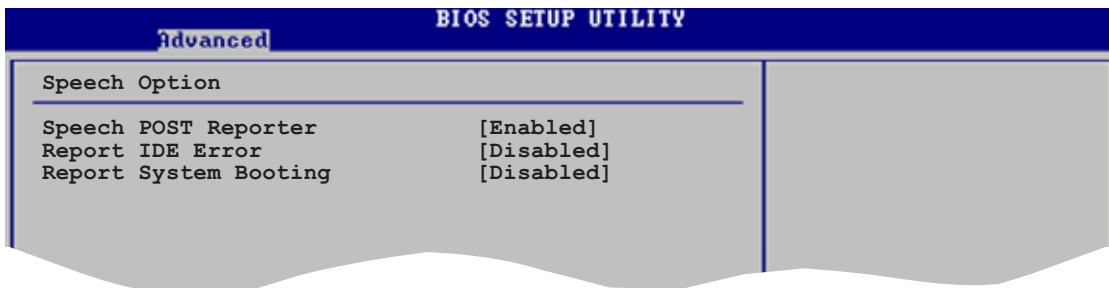

Speech POST Reporter [Enabled]

Allows you to enable or disable the ASUS Speech POST Reporter™ feature.
Configuration options: [Disabled] [Enabled]



The following items appear only when Speech POST Reporter is set to Enabled.

Report IDE Error [Disabled]

Enables or disables the report feature in the event of an IDE error.
Configuration options: [Disabled] [Enabled]

Report System Booting [Disabled]

Enables or disables the report after booting the system.
Configuration options: [Disabled] [Enabled]

4.5 Power menu

The Power menu items allow you to change the settings for the ACPI and Advanced Power Management (APM) features. Select an item then press <Enter> to display the configuration options.

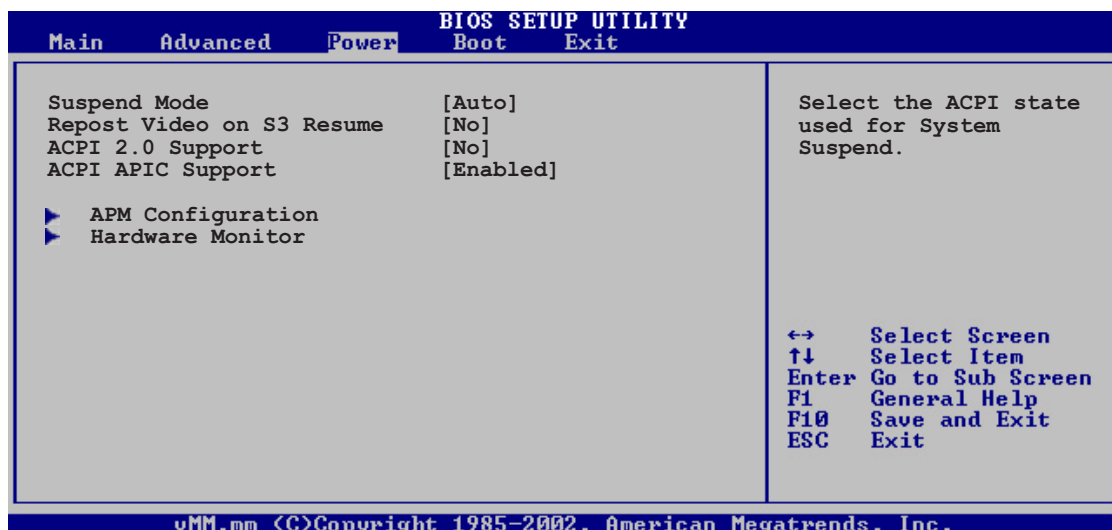

4.5.1 Suspend Mode [Auto]

Allows you to select the Advanced Configuration and Power Interface (ACPI) state to be used for system suspend.

Configuration options: [S1 (POS) Only] [S3 Only] [Auto]

4.5.2 Repost Video on S3 Resume [No]

Determines whether to invoke VGA BIOS POST on S3/STR resume.

Configuration options: [Yes] [No]

4.5.3 ACPI 2.0 Support [No]

Allows you to add more tables for Advanced Configuration and Power Interface (ACPI) 2.0 specifications. Configuration options: [No] [Yes]

4.5.4 ACPI APIC Support [Enabled]

Allows you to enable or disable the Advanced Configuration and Power Interface (ACPI) support in the Application-Specific Integrated Circuit (ASIC). When set to Enabled, the ACPI APIC table pointer is included in the RSDT pointer list. Configuration options: [Disabled] [Enabled]

4.5.5 APM Configuration

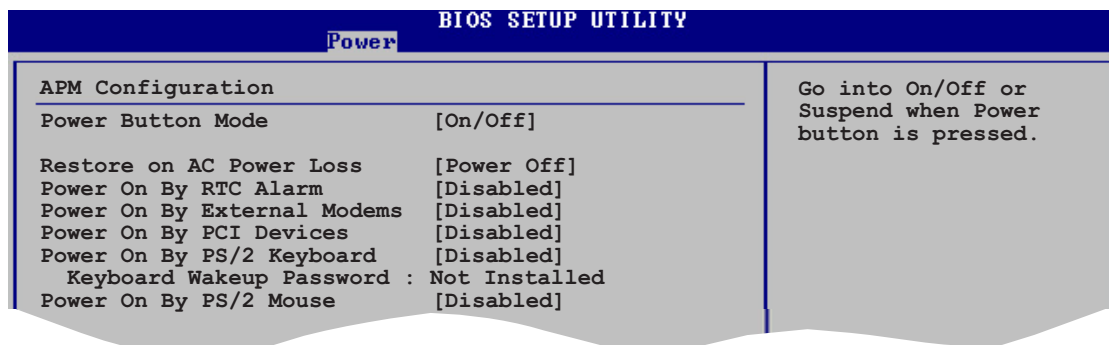

Power Button Mode [On/Off]

Allows the system to go into On/Off mode or suspend mode when the power button is pressed. Configuration options: [On/Off] [Suspend]

Restore on AC Power Loss [Power Off]

When set to Power Off, the system goes into off state after an AC power loss. When set to Power On, the system goes on after an AC power loss. When set to Last State, the system goes into either off or on state, whatever the system state was before the AC power loss. Configuration options: [Power Off] [Power On] [Last State]

Power On By RTC Alarm [Disabled]

Allows you to enable or disable RTC to generate a wake event. When this item is set to Enabled, the items RTC Alarm Date, RTC Alarm Hour, RTC Alarm Minute, and RTC Alarm Second appear with set values. Configuration options: [Disabled] [Enabled]

Power On By External Modems [Disabled]

Allows either settings of [Enabled] or [Disabled] for powering up the computer when the external modem receives a call while the computer is in Soft-off mode. Configuration options: [Disabled] [Enabled]



The computer cannot receive or transmit data until the computer and applications are fully running. Thus, connection cannot be made on the first try. Turning an external modem off and then back on while the computer is off causes an initialization string that turns the system power on.

Power On By PCI Devices [Disabled]

When set to [Enabled], this parameter allows you to turn on the system through a PCI LAN or modem card. This feature requires an ATX power supply that provides at least 1A on the +5VSB lead. Configuration options: [Disabled] [Enabled]

Power On By PS/2 Keyboard [Disabled]

Allows you to use specific keys on the keyboard to turn on the system. This feature requires an ATX power supply that provides at least 1A on the +5VSB lead. Configuration options: [Disabled] [Enabled]

Wakeup Password

This item appears only when the **Power On By PS/2 Keyboard** is set to [Enabled]. Select this item to set or change the keyboard wakeup password.

Keyboard Wakeup Password

Shows [**Not Installed**] if the **Wakeup Password** is disabled. After you have set a keyboard password, this item shows [**Installed**].

Power On By PS/2 Mouse [Disabled]

When set to [Enabled], this parameter allows you to use the PS/2 mouse to turn on the system. This feature requires an ATX power supply that provides at least 1A on the +5VSB lead. Configuration options: [Disabled] [Enabled]

4.5.6 Hardware Monitor

BIOS SETUP UTILITY	
Power	
Hardware Monitor	
CPU Temperature	[51°C/122.5°F]
MB Temperature	[41°C/105.5°F]
CPU Fan Speed	[3813 RPM]
CPU Q-Fan Control	[Disabled]
Chassis Fan Speed	[N/A]
Power Fan Speed	[N/A]
VCORE Voltage	[1.320V]
3.3V Voltage	[3.345V]
5V Voltage	[5.094V]
12V Voltage	[11.880V]
	←→ Select Screen ↑↓ Select Item +- Change Option F1 General Help F10 Save and Exit ESC Exit

vMM.mm <C>Copyright 1985-2002, American Megatrends, Inc.

CPU Temperature [xxx°C/xxx°F]

MB Temperature [xxx°C/xxx°F]

The onboard hardware monitor automatically detects and displays the motherboard and CPU temperatures. Select [Disabled] if you do not wish to display the detected temperatures.

CPU Fan Speed [xxxxRPM] or [N/A]

The onboard hardware monitor automatically detects and displays the CPU fan speed in rotations per minute (RPM). If the fan is not connected to the motherboard, the field shows N/A.

CPU Q-Fan Control [Disabled]

Allows you to enable or disable the ASUS Q-Fan feature that smartly adjusts the fan speeds for more efficient system operation. Configuration options: [Disabled] [Enabled]



The **CPU Q-Fan Mode**, **CPU Fan Ratio**, **CPU Target Temperature**, and **Chassis Q-Fan Control** items appear when you enable the **CPU Q-Fan Control** feature.

CPU Q-Fan Mode [PWM]

Allows you to select the type of CPU fan cable connected to the CPU fan connector. Set to [PWM] when using a 4-pin CPU fan cable. Set to [DC] when using a 3-pin CPU fan cable. Configuration options: [PWM] [DC]



Some CPU fans with a 4-pin cable do not comply with Intel®'s PWM fan specification. When using this type of CPU fan, you can not reduce the CPU fan speed even if you set the CPU Q-Fan Mode to [PWM].

CPU Fan Ratio [Auto]

Allows you to select the appropriate CPU fan speed ratio for the system. The default [Auto] automatically selects the fan speed ratio when operating a low CPU temperature. Select a higher ratio if you installed additional devices and the system requires more ventilation. Configuration options: [Auto] [90%] [80%] [70%] [60%]

CPU Target Temperature [xxx°C]

Allows you to set the CPU temperature threshold when the CPU fan speed is increased to lower the CPU temperature. The configuration options for this item depend on the recommended Intel® Fan Speed Control (FSC) temperature settings. The Intel® FSC provides target temperature options at $\pm 15^\circ$ with 3° interval.

Chassis Fan Speed [xxxxRPM] or [N/A]

The onboard hardware monitor automatically detects and displays the chassis fan speed in rotations per minute (RPM). If the fan is not connected to the chassis, the specific field shows N/A.

Chassis Q-Fan Control [Disabled]

Allows you to enable or disable the ASUS Q-Fan feature that smartly adjusts the chassis fan speeds for more efficient system operation. Configuration options: [Disabled] [Enabled]

Power Fan Speed [xxxxRPM] or [N/A]

The onboard hardware monitor automatically detects and displays the power fan speed in rotations per minute (RPM). If the fan is not connected to the power fan connector, the specific field shows N/A.

VCORE Voltage, 3.3V Voltage, 5V Voltage, 12V Voltage

The onboard hardware monitor automatically detects the voltage output through the onboard voltage regulators.

4.6 Boot menu

The Boot menu items allow you to change the system boot options. Select an item then press <Enter> to display the sub-menu.



4.6.1 Boot Device Priority

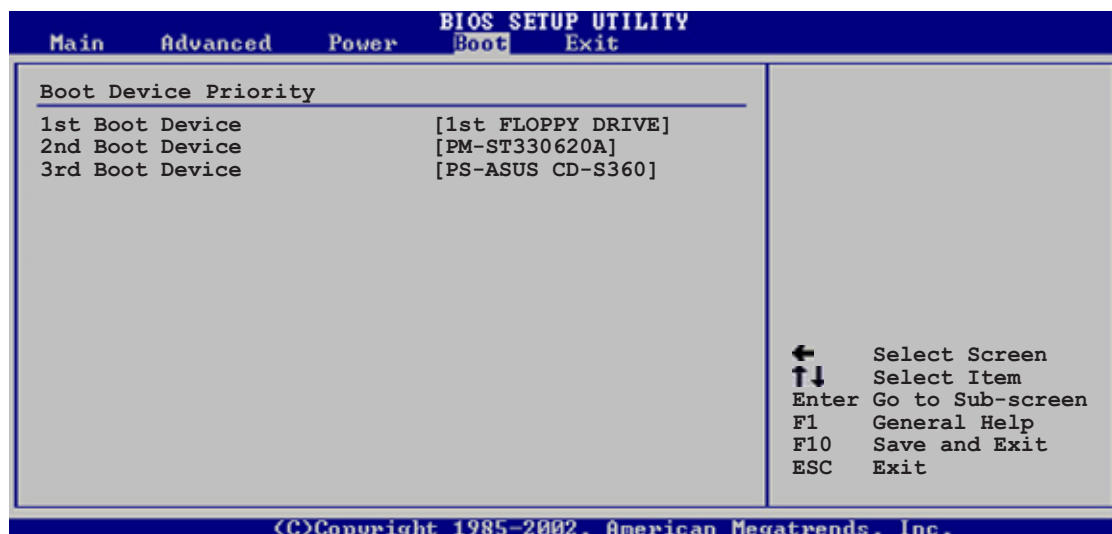

1st ~ xxth Boot Device [1st Floppy Drive]

These items specify the boot device priority sequence from the available devices. The number of device items that appears on the screen depends on the number of devices installed in the system.

Configuration options: [xxxxx Drive] [Disabled]

4.6.2 Boot Settings Configuration

BIOS SETUP UTILITY	
Boot	
Boot Settings Configuration	
Quick Boot	[Enabled]
Full Screen Logo	[Enabled]
AddOn ROM Display Mode	[Force BIOS]
Bootup Num-Lock	[On]
PS/2 Mouse Support	[Auto]
Wait For 'F1' If Error	[Enabled]
Hit 'DEL' Message Display	[Enabled]
Interrupt 19 Capture	[Disabled]

Allows BIOS to skip certain tests while booting. This will decrease the time needed to boot the system.

Quick Boot [Enabled]

Enabling this item allows the BIOS to skip some power on self tests (POST) while booting to decrease the time needed to boot the system. When set to [Disabled], BIOS performs all the POST items.

Configuration options: [Disabled] [Enabled]

Full Screen Logo [Enabled]

Allows you to enable or disable the full screen logo display feature.

Configuration options: [Disabled] [Enabled]



Set this item to [Enabled] to use the ASUS MyLogo2™ feature.

Add On ROM Display Mode [Force BIOS]

Sets the display mode for option ROM.

Configuration options: [Force BIOS] [Keep Current]

Bootup Num-Lock [On]

Allows you to select the power-on state for the NumLock.

Configuration options: [Off] [On]

PS/2 Mouse Support [Auto]

Allows you to enable or disable support for PS/2 mouse.

Configuration options: [Disabled] [Enabled] [Auto]

Wait for 'F1' If Error [Enabled]

When set to Enabled, the system waits for the F1 key to be pressed when error occurs. Configuration options: [Disabled] [Enabled]

Hit 'DEL' Message Display [Enabled]

When set to Enabled, the system displays the message "Press DEL to run Setup" during POST. Configuration options: [Disabled] [Enabled]

Interrupt 19 Capture [Disabled]

When set to [Enabled], this function allows the option ROMs to trap Interrupt 19. Configuration options: [Disabled] [Enabled]

4.6.3 Security

The Security menu items allow you to change the system security settings. Select an item then press <Enter> to display the configuration options.

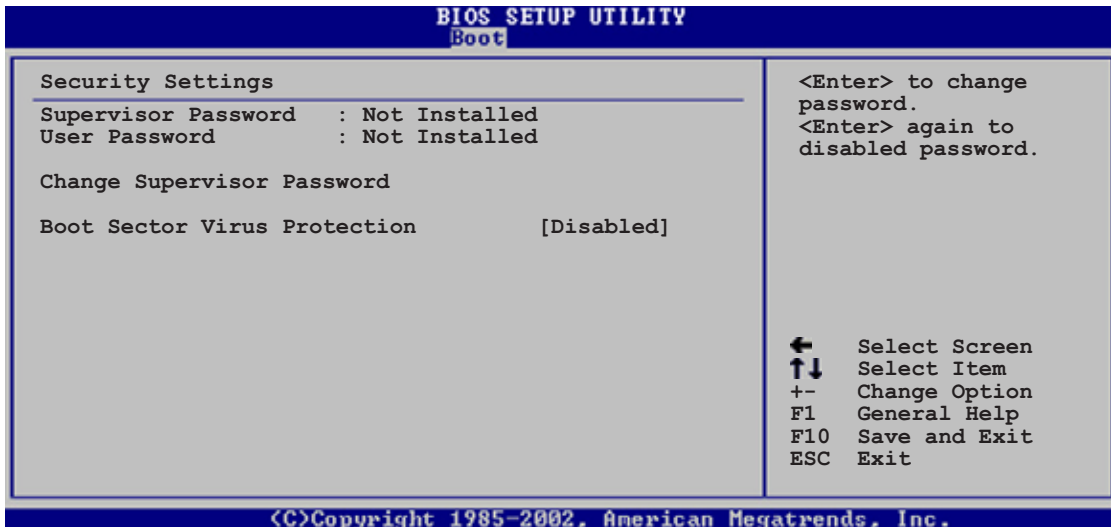

Change Supervisor Password

Select this item to set or change the supervisor password. The Supervisor Password item on top of the screen shows the default **Not Installed**. After you set a password, this item shows **Installed**.

To set a Supervisor Password:

1. Select the Change Supervisor Password item and press <Enter>.
2. From the password box, type a password composed of at least six letters and/or numbers, then press <Enter>.
3. Confirm the password when prompted.

The message "Password Installed" appears after you successfully set your password.

To change the supervisor password, follow the same steps as in setting a user password.

To clear the supervisor password, select the Change Supervisor Password then press <Enter>. The message "Password Uninstalled" appears.



If you forget your BIOS password, you can clear it by erasing the CMOS Real Time Clock (RTC) RAM. See section "2.6 Jumpers" for information on how to erase the RTC RAM.

After you have set a supervisor password, the other items appear to allow you to change other security settings.

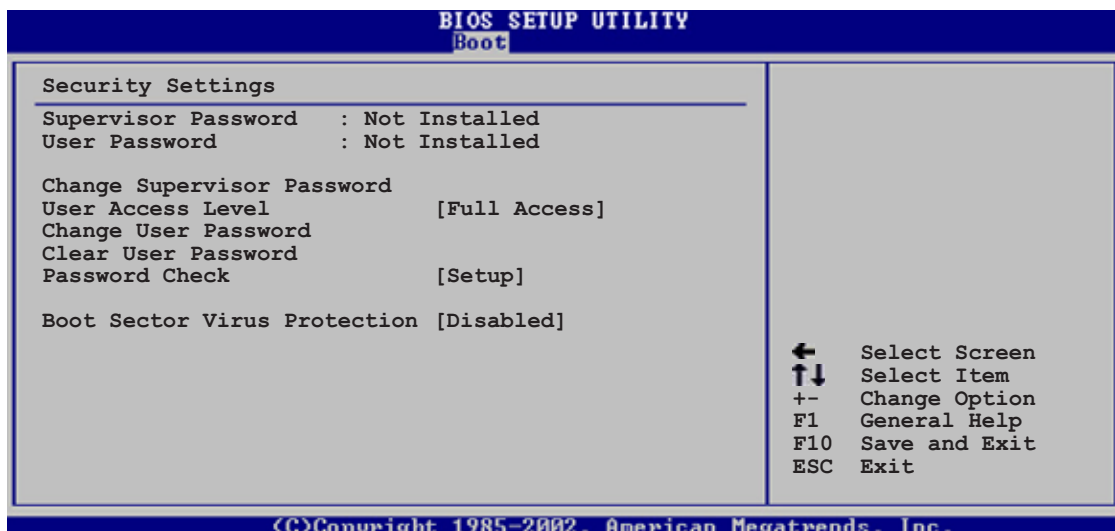

User Access Level [Full Access]

This item allows you to select the access restriction to the Setup items. Configuration options: [No Access] [View Only] [Limited] [Full Access]

No Access prevents user access to the Setup utility.

View Only allows access but does not allow change to any field.

Limited allows changes only to selected fields, such as Date and Time.

Full Access allows viewing and changing all the fields in the Setup utility.

Change User Password

Select this item to set or change the user password. The User Password item on top of the screen shows the default **Not Installed**. After you set a password, this item shows **Installed**.

To set a User Password:

1. Select the Change User Password item and press <Enter>.
2. On the password box that appears, type a password composed of at least six letters and/or numbers, then press <Enter>.
3. Confirm the password when prompted.

The message “Password Installed” appears after you set your password successfully.

To change the user password, follow the same steps as in setting a user password.

Clear User Password

Select this item to clear the user password.

Password Check [Setup]

When set to [Setup], BIOS checks for user password when accessing the Setup utility. When set to [Always], BIOS checks for user password both when accessing Setup and booting the system.

Configuration options: [Setup] [Always]

Boot Sector Virus Protection [Disabled]

Allows you to enable or disable the boot sector virus protection.

Configuration options: [Disabled] [Enabled]

4.7 Exit menu

The Exit menu items allow you to load the optimal or failsafe default values for the BIOS items, and save or discard your changes to the BIOS items.

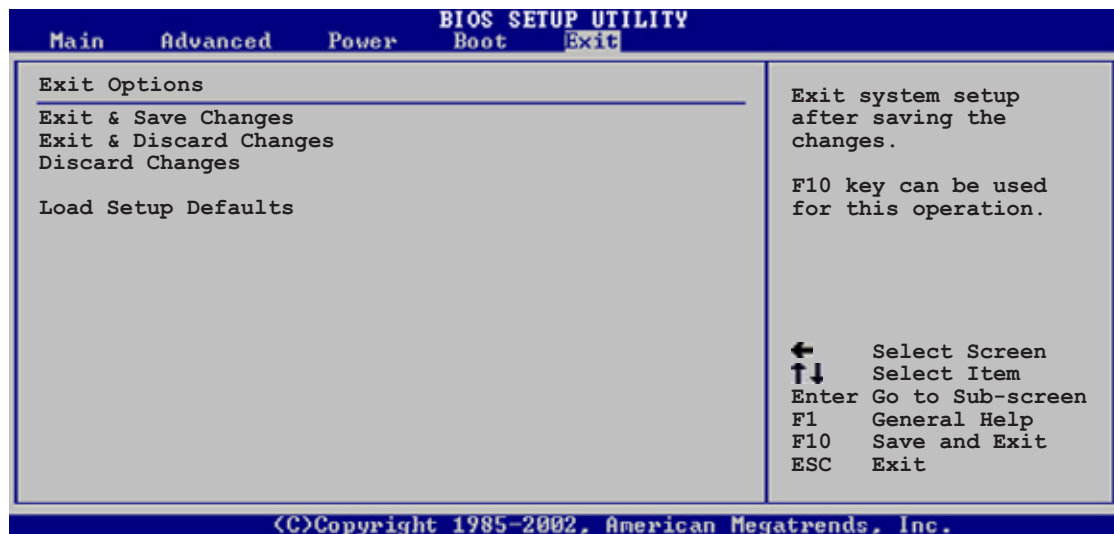

Pressing <Esc> does not immediately exit this menu. Select one of the options from this menu or <F10> from the legend bar to exit.

Exit & Save Changes

Once you are finished making your selections, choose this option from the Exit menu to ensure the values you selected are saved to the CMOS RAM. An onboard backup battery sustains the CMOS RAM so it stays on even when the computer is turned off. When you select this option, a confirmation window appears. Select **Yes** to save the changes and exit.



If you attempt to exit the Setup program without saving your changes, the program prompts you with a message asking if you want to save your changes before exiting. Press <Enter> to save the changes while exiting.

Exit & Discard Changes

Select this option only if you do not want to save the changes that you made to the Setup program. If you made changes to fields other than System Date, System Time, and Password, the BIOS asks for a confirmation before exiting.

Discard Changes

Allows you to discard the selections you made and restore the previously saved values. After selecting this option, a confirmation appears. Select **Yes** to discard any changes and load the previously saved values.

Load Setup Defaults

Allows you to load the default values for each of the parameters on the Setup menus. When you select this option or if you press <F5>, a confirmation window appears. Select **Yes** to load default values. Select **Exit & Save Changes** or make other changes before saving the values to the non-volatile RAM.

This chapter describes the contents of the support CD that comes with the motherboard package.

5 Software support

5.1	Installing an operating system	5-1
5.2	Support CD information	5-1
5.3	Software information	5-8
5.4	RAID configurations	5-16
5.5	Creating a RAID driver disk	5-38

5.1 Installing an operating system

This motherboard supports Windows® 2000/2003 Server/XP operating systems (OS). Always install the latest OS version and corresponding updates to maximize the features of your hardware.



- Motherboard settings and hardware options vary. Use the setup procedures presented in this chapter for reference only. Refer to your OS documentation for detailed information.
- Make sure that you install Windows® 2000 Service Pack 4 or the Windows® XP Service Pack 1 or later versions before installing the drivers for better compatibility and system stability.

5.2 Support CD information

The support CD that came with the motherboard package contains the drivers, software applications, and utilities that you can install to avail all motherboard features.



The contents of the support CD are subject to change at any time without notice. Visit the ASUS website (www.asus.com) for updates.

5.2.1 Running the support CD

Place the support CD to the optical drive. The CD automatically displays the **Drivers** menu if Autorun is enabled in your computer.

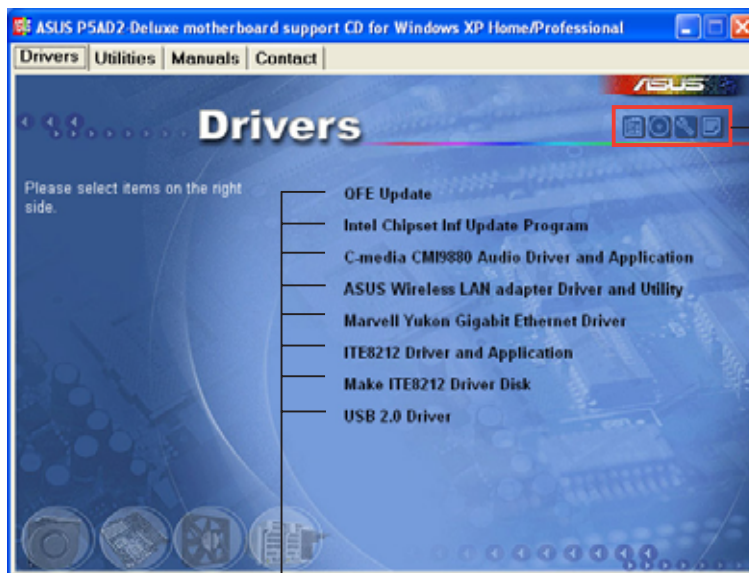

Click an icon to display support CD/motherboard information

Click an item to install



If **Autorun** is NOT enabled in your computer, browse the contents of the support CD to locate the file **ASSETUP.EXE** from the BIN folder. Double-click the **ASSETUP.EXE** to run the CD.

5.2.2 Drivers menu

The drivers menu shows the available device drivers if the system detects installed devices. Install the necessary drivers to activate the devices.



The screen display and driver options vary under different operating system versions.

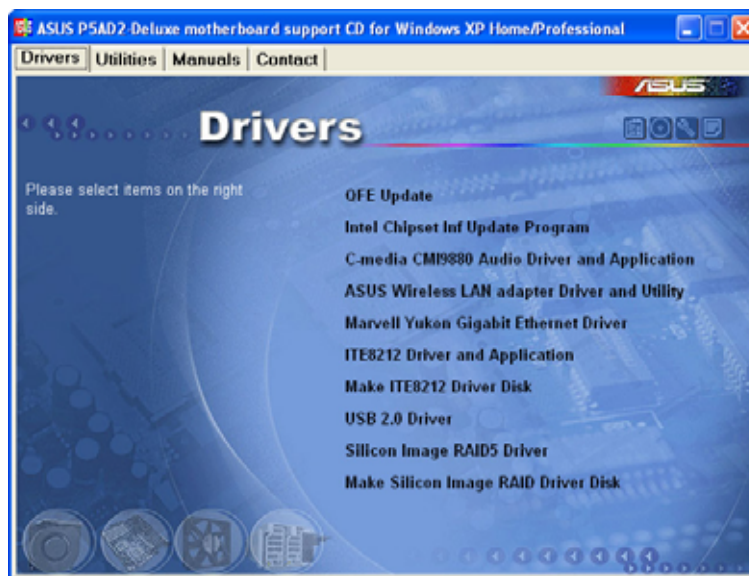

QFE Update

Installs the Quick Fix Engineering (QFE) driver updates.

Intel Chipset Inf Update Program

Installs the Intel® Chipset INF Update Program. This driver enables Plug-n-Play INF support for the Intel® chipset components on the motherboard. When installed to the target system, this driver provides the method for configuring the chipset components.

You can install this utility using three different modes: interactive, silent or unattended preload. Installing the driver in interactive mode requires user input during installation. User input is not required when installing the driver in silent or unattended preload modes. Refer to the online help or readme file that came with the utility for details.

C-MEDIA CMI9880 Audio Driver and Application

Installs the C-MEDIA® CMI9880 audio driver and application. See page 5-11 for details.

ASUS Wireless LAN adapter Driver and Utility

Installs the driver, utilities, and setup wizard for the ASUS WiFi-g™ wireless solution. Refer to the WiFi-g™ documentation for details.

Marvell Yukon Gigabit Ethernet Driver

Installs the driver for the Marvell® Yukon 88E8052 PCI Express Gigabit LAN.

IT8212 Driver and Application

Installs the driver for the IT8212 IDE RAID controller.

Make ITE8212 Driver Disk

Allows you to create a driver disk for the IT8212 IDE RAID setup. See page 5-38 for details.

USB 2.0 Driver

Installs the USB 2.0 driver.

Silicon Image RAID5 Driver

Installs the Silicon Image 3114R RAID5 driver.

Make Silicon Image RAID Driver Disk

Allows you to create a RAID 5 driver disk for the Silicon Image RAID 5 configuration. See page 5-38 for details.

5.2.3 Utilities menu

The **Utilities** menu displays the software applications and utilities that the motherboard supports. Click on an item to install.

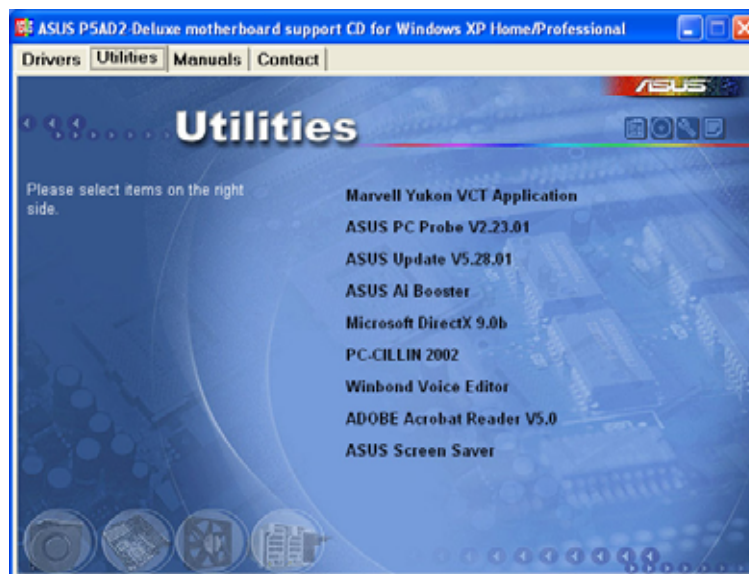

Marvell Yukon VCT Application

The Virtual Cable Tester (VCT) is a cable diagnostic application that analyzes and reports LAN cable faults and shorts. See page 5-10 for details.

ASUS PC Probe

This smart utility monitors the fan speed, CPU temperature, and system voltages, and alerts you of any detected problems. This utility helps you keep your computer in healthy operating condition.

ASUS Update

The ASUS Update utility that allows you to update the motherboard BIOS in Windows® environment. This utility requires an Internet connection either through a network or an Internet Service Provider (ISP). See page 4-8 for details.

AI Booster

The ASUS AI Booster application allows you to overclock the CPU speed in Windows® environment.

Microsoft DirectX 9.0b

The Microsoft DirectX® 9.0b is a multimedia technology that enhances computer graphics and sounds. DirectX® improves the multimedia features of your computer so you can enjoy watching TV and movies, capturing videos, or playing games in your computer.

Anti-virus application

The anti-virus application scans, identifies, and destroys computer worms and viruses attempting to damage your data. View the online help for detailed information.

Winbond Voice Editor

This Voice Editor application allows you to record and customize wave files for the ASUS POST Reporter™ utility. Use this program to change the default vocal POST messages. See section “3.2 Vocal POST Messages” for details.

ADOBE Acrobat Reader

The Adobe Acrobat® Reader V5.0 is for opening, viewing, and printing documents in Portable Document Format (PDF).

ASUS Screen Saver

Bring life to your idle screen by installing the ASUS screen saver.

5.2.4 Manuals menu

The **Manuals** menu contains the user manuals for third party components and applications.

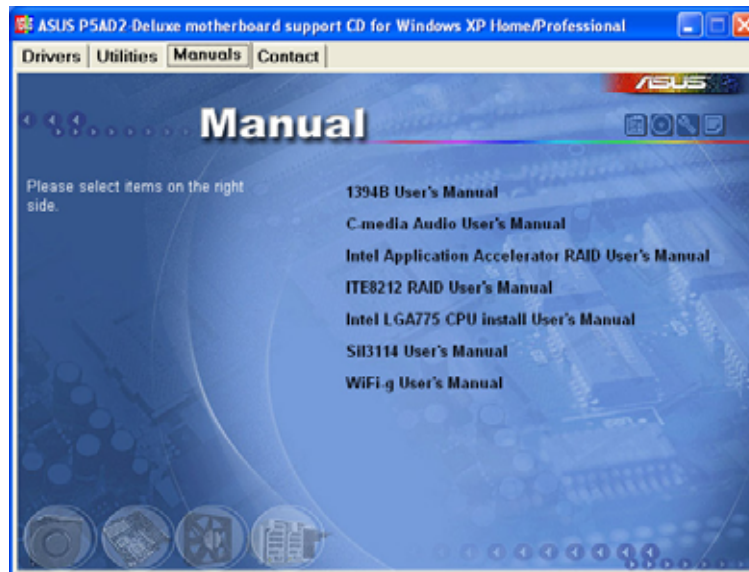

Most user manual files are in Portable Document Format (PDF). Install the Adobe Acrobat Reader application from the **Utilities** tab before opening a user manual file.

5.2.5 Contact information

Click the **Contact** tab to display the ASUS contact information. You can also find this information on the inside front cover of this user guide.



5.2.6 Other information

The icons on the top right corner of the screen provide additional information on the motherboard and the contents of the support CD. Click an icon to display the specified information.

Motherboard Info

Displays the general specifications of the motherboard.

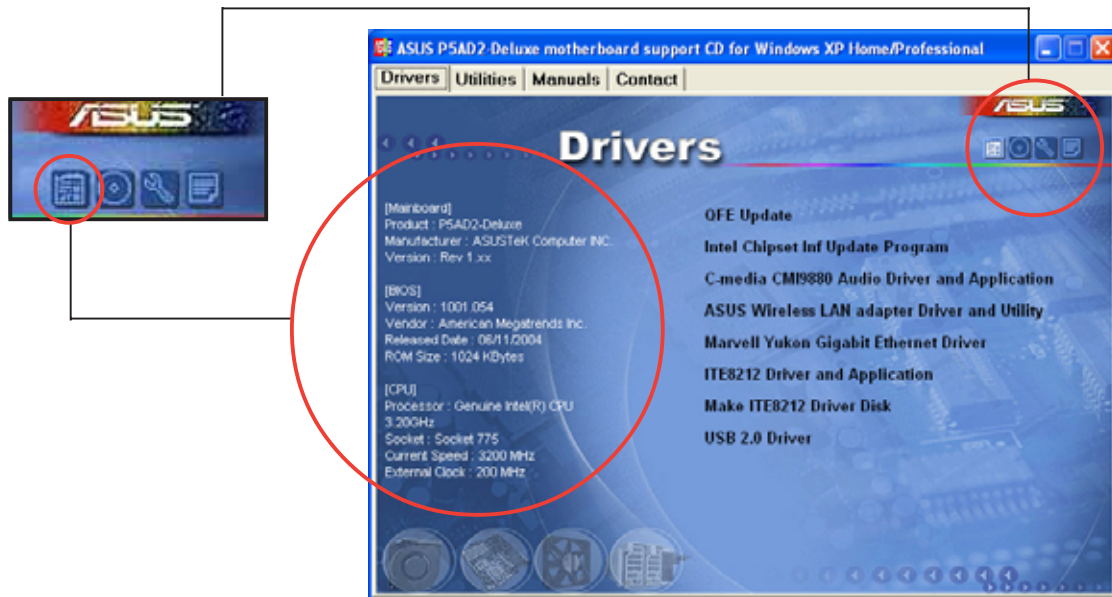

Browse this CD

Displays the contents of the support CD in graphical format.



Technical Support Form

Displays the ASUS Technical Support Request Form that you have to fill out when requesting technical support.

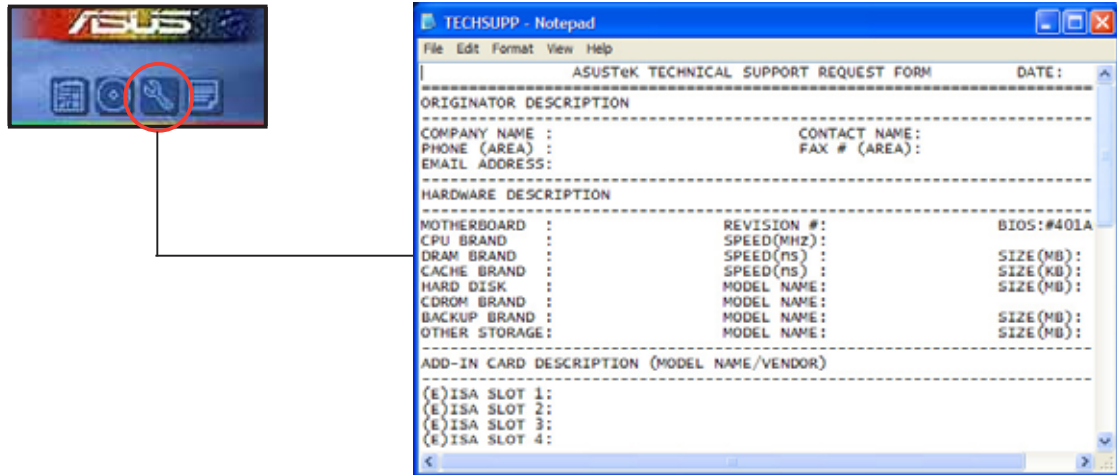

Filelist

Displays the contents of the support CD in text format.



5.3 Software information

Most of the applications in the support CD have wizards that will conveniently guide you through the installation. View the online help or readme file that came with the software application for more information.

5.3.1 ASUS MyLogo2™

The ASUS MyLogo2™ utility lets you customize the boot logo. The boot logo is the image that appears on screen during the Power-On-Self-Tests (POST). The ASUS MyLogo2™ is automatically installed when you install the **ASUS Update** utility from the support CD. See section “5.2.3 Utilities menu” for details.



- Before using the ASUS MyLogo2™, use the AFUDOS utility to make a copy of your original BIOS file, or obtain the latest BIOS version from the ASUS website. See section “4.1.2 AFUDOS utility”.
- Make sure that the BIOS item **Full Screen Logo** is set to [Enabled] if you wish to use ASUS MyLogo2. See section “4.6.2 Boot Settings Configuration”.
- You can create your own boot logo image in GIF, JPG, or BMP file formats.

To launch the ASUS MyLogo2™:

1. Launch the ASUS Update utility. Refer to section “4.1.4 ASUS Update utility” for details.
2. Select **Options** from the drop down menu, then click **Next**.
3. Check the option **Launch MyLogo to replace system boot logo before flashing BIOS**, then click **Next**.
4. Select **Update BIOS from a file** from the drop down menu, then click **Next**.
5. When prompted, locate the new BIOS file, then click **Next**. The ASUS MyLogo2 window appears.
6. From the left window pane, select the folder that contains the image you intend to use as your boot logo.



7. When the logo images appear on the right window pane, select an image to enlarge by clicking on it.



8. Adjust the boot image to your desired size by selecting a value on the **Ratio** box.



9. When the screen returns to the ASUS Update utility, flash the original BIOS to load the new boot logo.
10. After flashing the BIOS, restart the computer to display the new boot logo during POST.

5.3.2 AI NET2

The AI NET2 features the Marvell® Virtual Cable Tester™ (VCT). VCT is a cable diagnostic utility that reports LAN cable faults and shorts using the Time Domain Reflectometry (TDR) technology. The VCT detects and reports open and shorted cables, impedance mismatches, pair swaps, pair polarity problems, and pair skew problems of up to 64 ns at one meter accuracy.

The VCT feature reduces networking and support costs through a highly manageable and controlled network system. This utility can be incorporated in the network systems software for ideal field support as well as development diagnostics.

Using the Virtual Cable Tester™

To use the the Marvell® Virtual Cable Tester™ utility:

1. Launch the VCT utility from the Windows® desktop by clicking **Start > All Programs > Marvell > Virtual Cable Tester**.
2. Click **Virtual Cable Tester** from the menu to display the screen below.

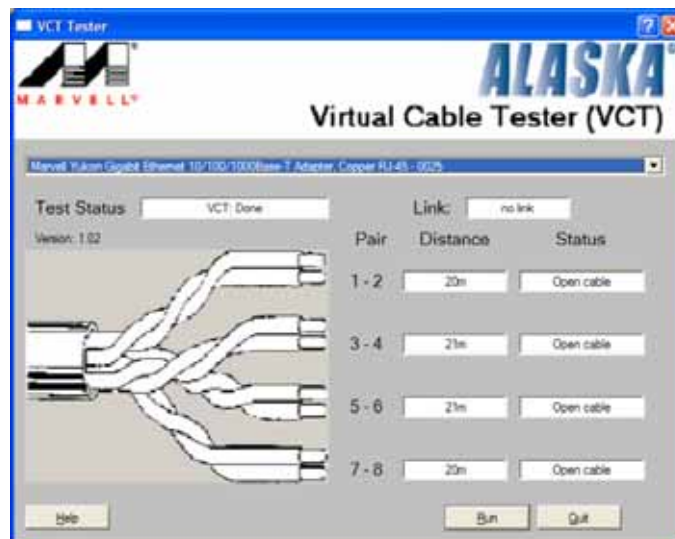

3. Click the **Run** button to perform a cable test.



- The VCT only runs on systems with Windows® XP or Windows® 2000 operating systems.
- The VCT utility only tests Ethernet cables connected to Gigabit LAN port(s).
- The **Run** button on the Virtual Cable Tester™ main window is disabled if no problem is detected on the LAN cable(s) connected to the LAN port(s).
- If you want the system to check the status of the LAN cable before entering the OS, enable the item **Post Check LAN Cable** in the BIOS Setup.

5.3.3 C-Media 3D audio configuration

The C-Media 3D Audio Configuration utility allows easy installation and set up of audio devices through a user-friendly interface. The utility is automatically installed when you install the C-Media CMI9880 audio driver and application from the motherboard support CD. Refer to section “5.2.2 Drivers menu.”

Launching the C-Media 3D Audio Configuration utility

Launch the C-Media 3D Audio Configuration utility by double clicking the C-Media icon on the Windows® taskbar.

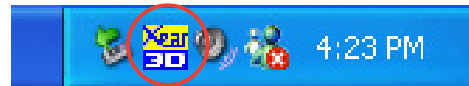

Using the C-Media 3D Audio Configuration utility

The C-Media 3D Audio Configuration interface has five tabs: Main Setting, Mixer, Effect, Device Setting, and Information. Click a tab to display the details.

Main Setting

The **Main Setting** tab allows you to check the audio system status, configure the audio ports, set the speaker and audio DSP modes, and test the speaker output.

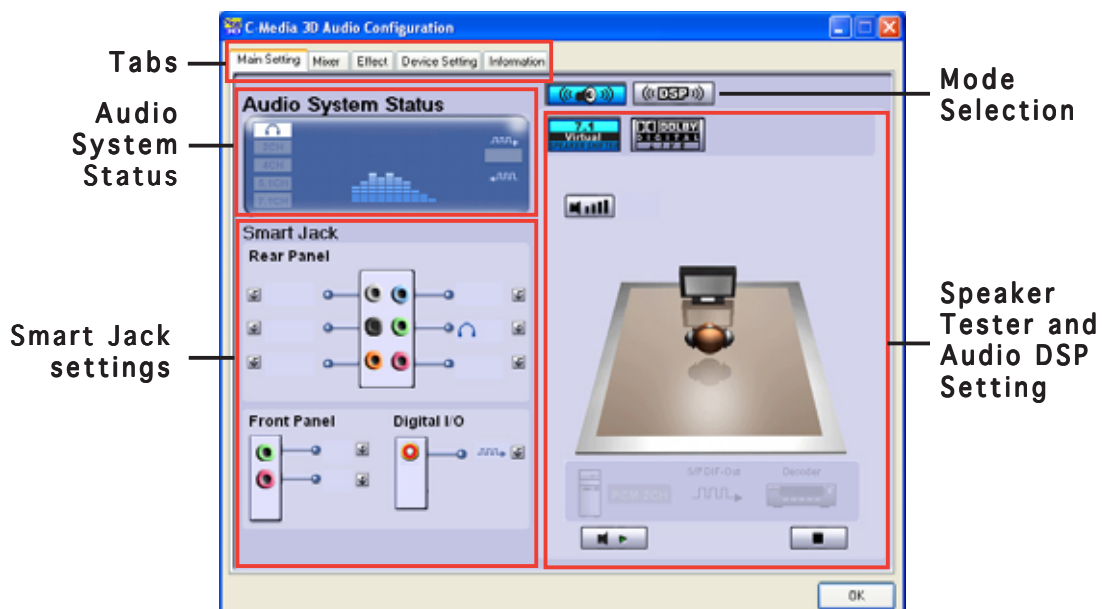

Audio System Status. This section displays the output mode status, the real-time audio playback spectrum, and the digital I/O status. The number of speakers configured in the system determines the output mode status.

Smart Jack Setting. You can configure the function of the rear panel, front panel, and digital I/O audio ports from this section. Click the  Smart Jack setting button that corresponds to the port that you wish to configure.

Mode Selection. This section allows you to set the Speaker Tester or the Digital Signal Processing (DSP). Click the button to change the audio modes.

Speaker Tester and Audio DSP Setting. You can configure your speaker setup and the audio DSP settings in this section. Click the **Play** or the **Stop** button to listen to the speakers or click the **Volume** button to adjust the speakers' volume.

Mixer

The **Mixer** tab allows you to adjust the audio input and the recording output volume of devices connected to the system rear panel and front panel audio ports.



Effect

The **Effect** tab allows you to control the environment emulation, set the environment size, and adjust the equalizer settings.

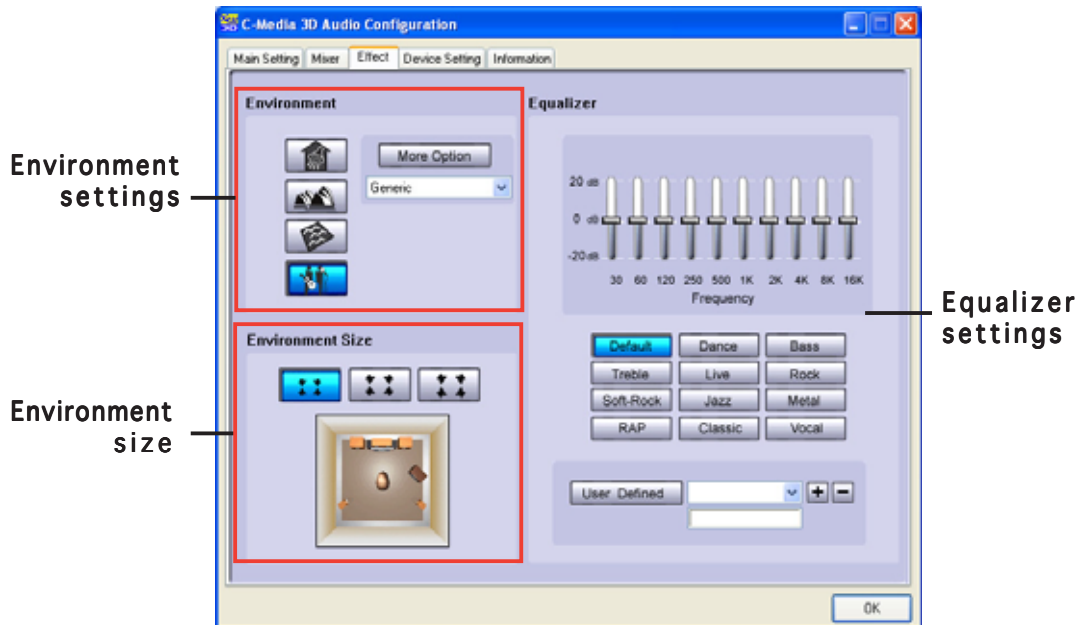

Environment. This section contains various pre-programmed environment emulations. There are four featured materials that emulate the bathroom, concert hall, underwater, and music pub environments. Click the corresponding button to set an environment emulation. To set other environment emulations, click the **More Option** list box.

Environment Size. This section allows you to select the size of your room for an appropriate audio output. There are three room size models provided for the environment size emulation. Click any of the environment size buttons to set.

Equalizer. The Equalizer section allows you to adjust the amplifier frequency. Use the 10-band equalizer to individually control the different frequency bands of your speaker system, or click a music style preset to load a pre-defined equalizer setting. Click the **User Defined** button to save or load your customized equalizer settings.

Device Setting

The **Device Setting** tab allows you to enable the audio CODEC multi-streaming feature, select a sound playback, and sound recording devices.

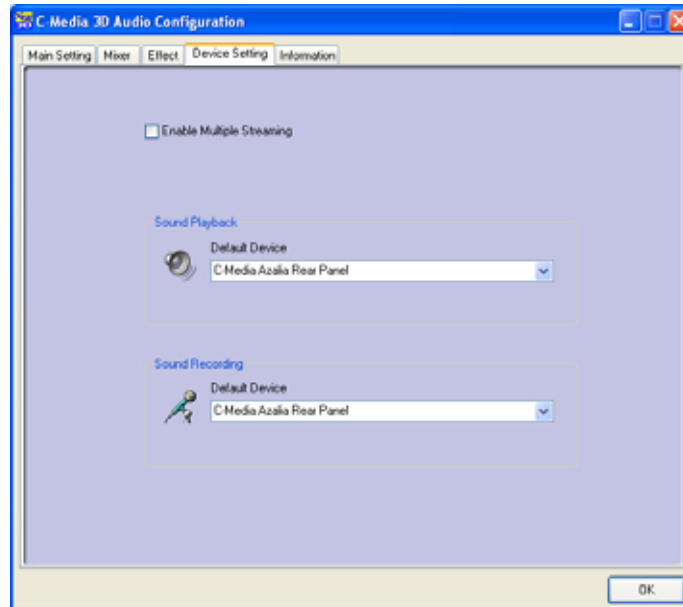

Information

The **Information** tab displays your 3D audio engine, audio CODEC, audio driver, audio controller, and DirectX information.



Using Dolby® Digital Live™

The Dolby® Digital Live™ technology encodes your computer's digital audio contents to real-time Dolby® Digital streams. Using the CODEC and the Sony/Philips Digital Interface (S/PDIF) ports on the motherboard, you can send the encoded Dolby® Digital streams to an AC-3 decoder for playback on a multi-channel speaker system.

Refer to the following illustrations when converting sounds to Dolby® Digital streams.

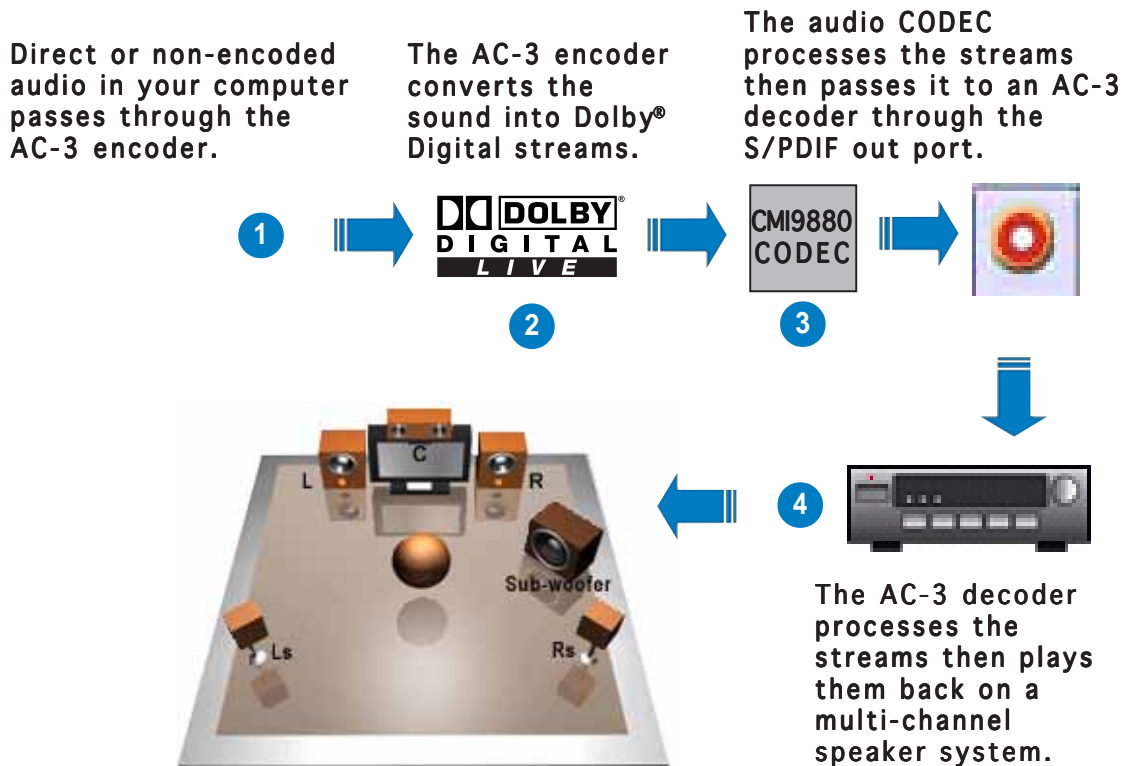

To enable the Dolby® Digital Live™:

1. Connect an AC-3 decoder to the coaxial/optical S/PDIF out port.
2. Connect the AC-3 decoder to the multi-channel speaker system.
3. Launch the C-Media 3D Audio Configuration utility by double clicking the C-Media icon on the Windows® taskbar.
4. Click the **Dolby Digital Live** button. You can now convert your computer's audio content to Dolby® Digital streams.



5.4 RAID configurations

The motherboard comes with the Silicon Image Sil3114, ITE 8212, and the Intel® ICH6R Southbridge RAID controllers that allow you to configure IDE and Serial ATA hard disk drives as RAID sets. The motherboard supports the following RAID configurations.

RAID 0 (*Data striping*) optimizes two identical hard disk drives to read and write data in parallel, interleaved stacks. Two hard disks perform the same work as a single drive but at a sustained data transfer rate, double that of a single disk alone, thus improving data access and storage. Use of two new identical hard disk drives is required for this setup.

RAID 1 (*Data mirroring*) copies and maintains an identical image of data from one drive to a second drive. If one drive fails, the disk array management software directs all applications to the surviving drive as it contains a complete copy of the data in the other drive. This RAID configuration provides data protection and increases fault tolerance to the entire system. Use two new drives or use an existing drive and a new drive for this setup. The new drive must be of the same size or larger than the existing drive.

RAID 0+1 is *data striping* and *data mirroring* combined without parity (redundancy data) having to be calculated and written. With the RAID 0+1 configuration you get all the benefits of both RAID 0 and RAID 1 configurations. Use four new hard disk drives or use an existing drive and three new drives for this setup.

RAID 5 stripes both data and parity information across three or more hard disk drives. Among the advantages of RAID 5 configuration include better HDD performance, fault tolerance, and higher storage capacity. The RAID 5 configuration is best suited for transaction processing, relational database applications, enterprise resource planning, and other business systems. Use a minimum of three identical hard disk drives for this setup.

RAID 10 is a striped configuration with RAID 1 segments whose segments are RAID 1 arrays. This configuration has the same fault tolerance as RAID 1, and has the same overhead for fault-tolerance as mirroring alone. RAID 10 achieves high input/output rates by striping RAID 1 segments. In some instances, a RAID 10 configuration can sustain multiple simultaneous drive failure. A minimum of four hard disk drives is required for this setup.

JBOD (*Spanning*) stands for **Just a Bunch of Disks** and refers to hard disk drives that are not yet configured as a RAID set. This configuration stores the same data redundantly on multiple disks that appear as a single disk on the operating system. Spanning does not deliver any advantage over using separate disks independently and does not provide fault tolerance or other RAID performance benefits.

Intel® Matrix Storage. The Intel® Matrix Storage technology supported by the ICH6R chip allows you to create a RAID 0 and a RAID 1 set using only two identical hard disk drives. The Intel® Matrix Storage technology creates two partitions on each hard disk drive to create a virtual RAID 0 and RAID 1 sets. This technology also allows you to change the hard disk drive partition size without losing any data.



If you want to boot the system from a hard disk drive included in a created RAID set, copy first the RAID driver from the support CD to a floppy disk before you install an operating system to the selected hard disk drive. Refer to section “5.5 Creating a RAID driver disk” for details.

5.4.1 Installing hard disks

The motherboard supports Ultra DMA /133/100/66 and Serial ATA hard disk drives. For optimal performance, install identical drives of the same model and capacity when creating a disk array.

Installing Parallel ATA hard disks

To install IDE hard disks for a RAID configuration:

1. Set the jumpers of each hard disk as Master/Master or Slave/Slave.
2. Install the hard disks into the drive bays.
3. Connect the HDD signal cables.
4. Connect a 4-pin power cable to the power connector on each drive.

Installing Serial ATA (SATA) hard disks

To install the SATA hard disks for a RAID configuration:

1. Install the SATA hard disks into the drive bays.
2. Connect the SATA signal cables.
3. Connect a SATA power cable to the power connector on each drive.



Refer to the RAID controllers user manual on the support CD for detailed information on RAID configurations.

5.4.2 Silicon Image RAID configurations

The Silicon Image RAID controller supports RAID 0, RAID 1, RAID 10, JBOD, and RAID 5 configurations. Use the Silicon Image RAID utility to configure a disk array.

Setting the BIOS RAID items

After installing the hard disk drives, make sure to set the necessary RAID items in the BIOS before setting your RAID configuration.

To set the BIOS RAID items:

1. Boot the system and press during the Power-On Self-Test (POST) to enter the BIOS Setup Utility.
2. From the **Advanced > Onboard Devices Configuration** menu item in the BIOS set the **Silicon Image Controller** item to RAID Mode.
3. Save your changes and Exit Setup.

Launching the Silicon Image Array Management Software

Launch the Silicon Image Array Management software from Windows® XP by clicking the **Start** button and selecting **All Programs > Silicon Image > Sam**



-
- For details on the Silicon Image SATARaid™ RAID configuration, refer to the “Sil3114 User’s Manual” in the motherboard support CD.
 - A RAID 5 configuration requires at least 1 GB of system memory and 3 GHz processor core speed for optimum performance.
 - You can only set the SATALink™ RAID 5 and JBOD configuration using the SATALink™ SATA RAID Management Software.
 - Make sure to install the Silicon Image SATA Link Sil 3114 driver and the Silicon Image RAID 5 Array Management Utility before using RAID 5 configuration.
-

Entering the Silicon Image BIOS RAID Configuration Utility

To enter the Silicon Image BIOS RAID configuration utility:

1. Boot up your computer.
2. During POST, press <Ctrl+S> or <F4>.



The RAID BIOS setup screens shown in this section are for reference only, and may not exactly match the items on your screen.

```
RAID Configuration Utility - Silicon Image Inc. Copyright (C) 2004

MAIN MENU
Create RAID set
Delete RAID set
Rebuild Raid1 set
Resolve Conflicts
Low Level Format
Logical Drive Info

HELP
Press "Enter" to create
RAID set

PHYSICAL DRIVE
0 XXXXXXXXXXXX XXXXXMB
1 XXXXXXXXXXXX XXXXXMB
2 XXXXXXXXXXXX XXXXXMB
3 XXXXXXXXXXXX XXXXXMB

LOGICAL DRIVE
STXXXXXXXXXX XXXXXMB
STXXXXXXXXXX XXXXXMB
STXXXXXXXXXX XXXXXMB
STXXXXXXXXXX XXXXXMB

↑↓:Select Menu  ESC:Previous Menu  Enter:Select  Ctrl-E:Exit
```

On the upper right corner of the screen is the Help message box. The message describes the function of each menu item. At the bottom of the screen is the legend box. The keys on the legend box allow you to navigate through the setup menu options. The following lists the keys found in the legend box and their corresponding functions.

↑, ↓	:	Select/Move to the next item
ESC	:	Previous Menu
Enter	:	Select
Ctrl-E	:	Exit

Creating a RAID 0 set (Striped)

To create a RAID set:

1. From the Silicon Image configuration utility main menu, select **Create RAID set** then press <Enter> to display an option menu.

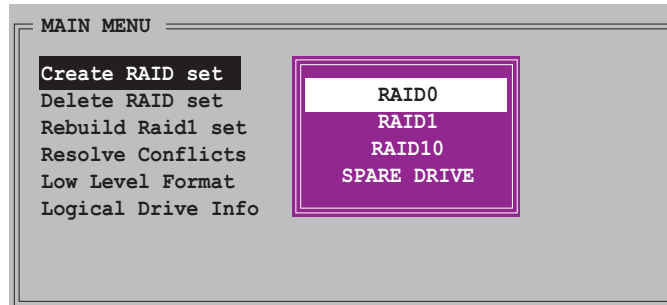

2. Select **RAID 0** then press <Enter> to display the following.

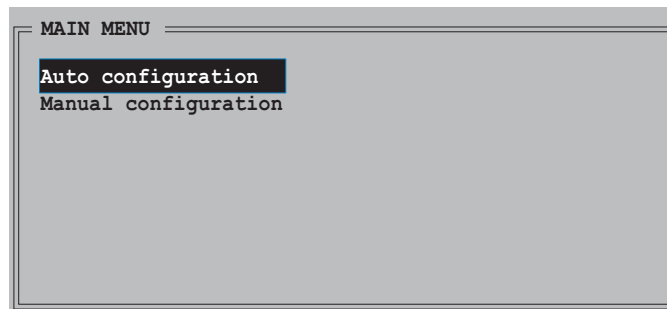

3. Select your desired method of configuration.
Auto configuration
 - a. Select Auto Configuration the press <Enter>.
 - b. The utility prompts a confirmation message, press <Y>.



By default, Auto configuration sets the stripe size to 64K and sets the logical drives based on the physical drives installed.

Manual configuration

- a. Select **Manual configuration** and press <Enter>. The following pop-up menu appears.

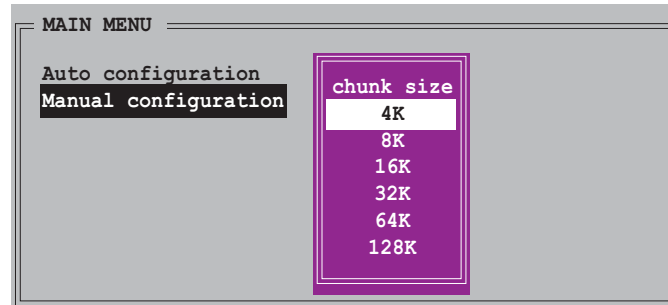

TIP: For server systems, use of a lower array block size is recommended. For multimedia computer systems used mainly for audio and video editing, a higher array block size is recommended for optimum performance.

- b. Use the up or down arrow keys to select a chunk size appropriate to your drive usage then press <Enter>. The selection bar moves to the Physical Drive menu.

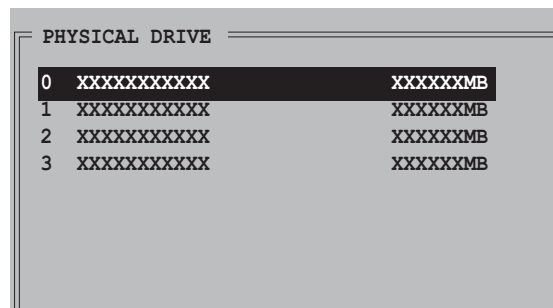

- c. Using the up or down arrow keys, select a drive then press <Enter> to set the first drive of the RAID set. Repeat the same procedure to set the second, third, and fourth drive. The number of available drives depend on the installed and enabled physical drives in the system.
- d. The utility prompts a confirmation message, press <Y> to confirm or <N> to return to the configuration Main Menu.

Creating a RAID 1 set (Mirrored)

To create a RAID 1 set:

1. From the Silicon Image configuration utility main menu, select **Create RAID set** then press <Enter>. The following sub-menu appears.

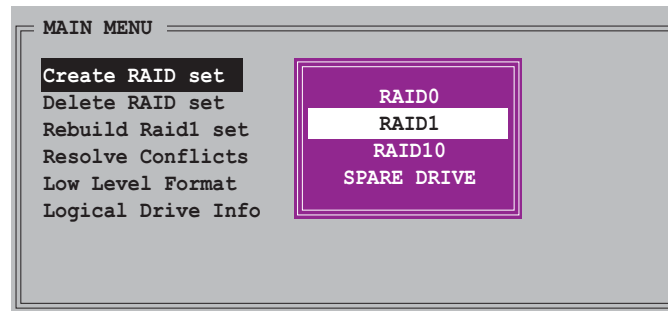

2. Select **RAID 1** then press <Enter> to display the following.

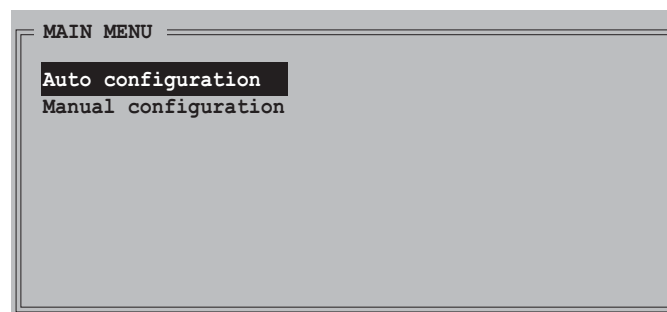

3. Select your desired method of configuration.
Auto configuration
 - a. Select Auto Configuration then press <Enter>.
 - b. The utility prompts a confirmation message. Press <Y> to confirm or <N> to return to the configuration Main Menu.



-
- Auto-configuration creates a RAID 1 set without backup copy.
 - When migrating a single hard disk drive to a RAID 1 set, use of the Manual configuration is recommended.
-

Manual configuration

- a. Select **Manual configuration** and press <Enter>. The selection bar moves to the Physical Drives menu.

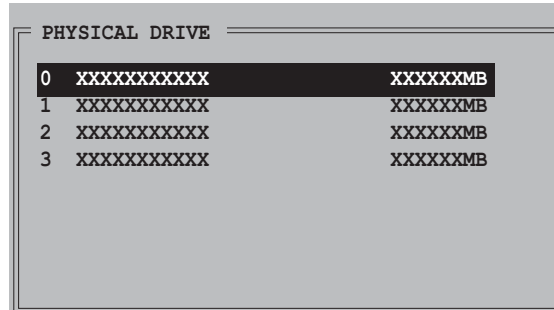

- b. Using the up or down arrow keys, select the *source drive* and press <Enter>.
- c. Repeat step b to select the *target drive*.
- d. After selecting the source and target drives, the following pop-up menu appears.

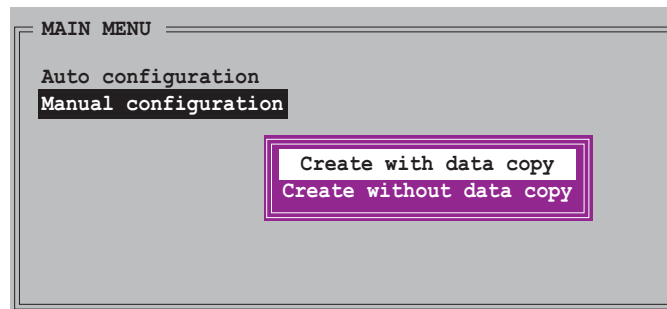

- The **Create with data copy** option allows you to copy the current data from the source drive to the mirror drive. The **Create without data copy** option disables the disk copy function of the Mirrored set.
- If you selected **Create without data copy**, the RAID 1 set must be repartitioned and reformatted to guarantee the consistency of its contents.
- Select **Create with data copy** if you have important data in your source drive.

- e. If you selected **Create with data copy**, the following pop-up menu appears.

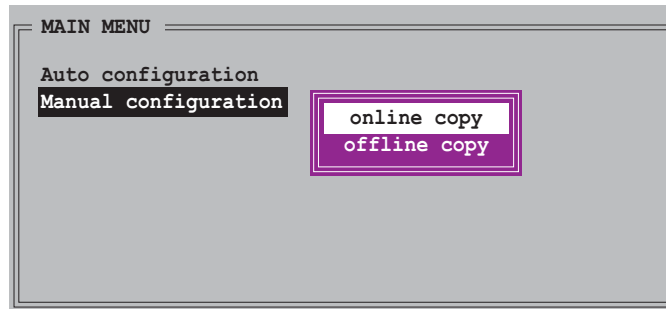

The **online copy** option automatically copies the data to the target drives on the background while writing to the source drives. The **offline copy** option allows you to copy the contents of the source drive to the target drives now.

- f. Use the up or down arrow keys to select desired copy method, then press <Enter>.
- g. The utility prompts a confirmation message. Press <Y> to confirm or <N> to return to the configuration Main Menu.



A copy progress appears if you previously selected offline copy.

Creating a RAID 10 set (Mirrored+Striped)

To create a RAID 10 set:

1. From the Silicon Image configuration utility main menu, select **Create RAID set** then press <Enter>. The following sub-menu appears.

To create a RAID 10 set:

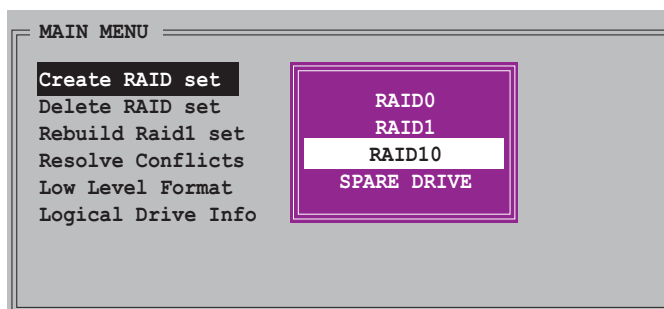

2. Select **RAID 10** then press <Enter> to display the following.

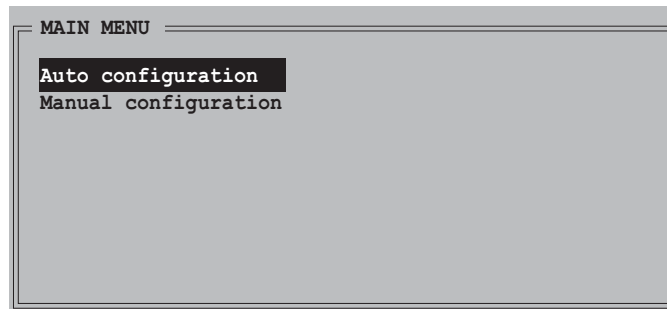

3. Select your desired method of configuration.

Auto configuration

- a. Select Auto Configuration then press <Enter>.
- b. The utility prompts a confirmation message. Press <Y> to confirm or <N> to return to the configuration Main Menu.



Auto-configuration creates a RAID 10 set without backup copy.

Manual configuration

- a. Select **Manual configuration** and press <Enter>. The following pop-up menu appears.

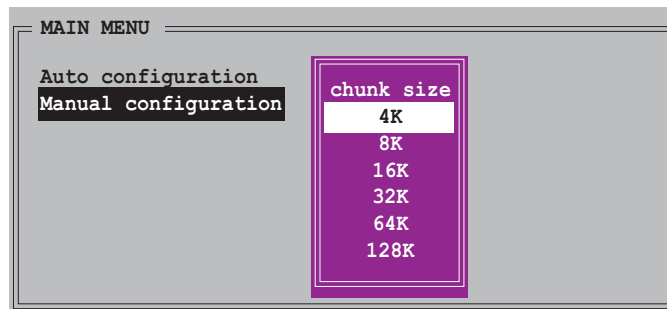

TIP: For server systems, use of a lower array block size is recommended. For multimedia computer systems used mainly for audio and video editing, a higher array block size is recommended for optimum performance.

- b. Use the up or down arrow keys to select a chunk size appropriate to your drive usage then press <Enter>. The selection bar moves to the Physical Drive menu.

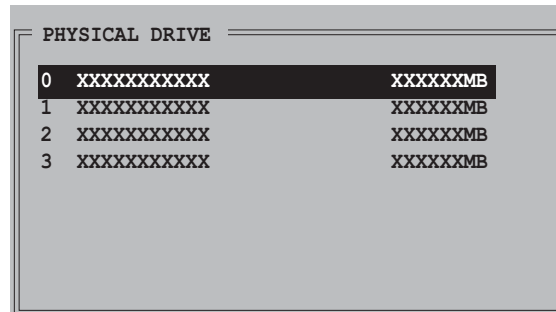

- c. Using the up or down arrow keys, select a drive then press <Enter> to set the first drive of the RAID set.
- d. Repeat step c to set the second, third, and fourth drive. The number of available drives depend on the installed and enabled physical drives in the system.
- e. After setting the RAID drives, the following pop-up menu appears.

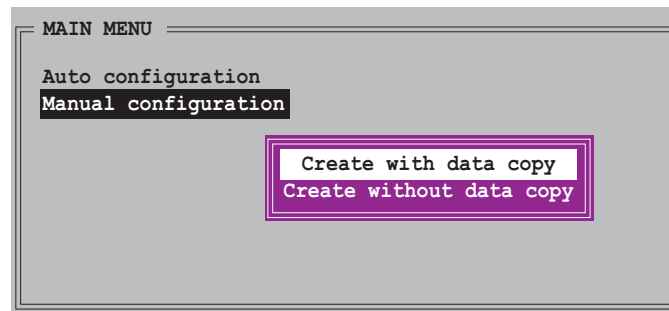

- The **Create with data copy** option allows you to copy the current data from the source drive to the mirror drive. The **Create without data copy** option disables the disk copy function of the Mirrored set.
- If you selected **Create without data copy**, the RAID 1 set must be repartitioned and reformatted to guarantee the consistency of its contents.
- Select **Create with data copy** if you have important data in your source drive.

- f. If you selected **Create with data copy**, the following pop-up menu appears.

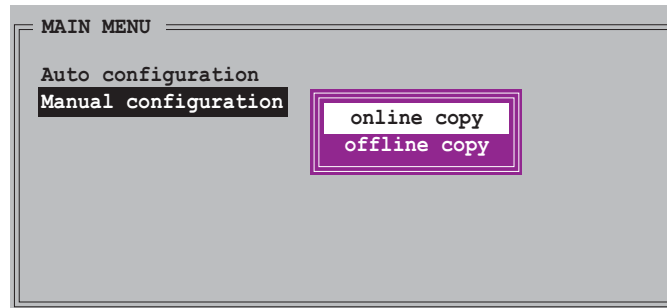

The **online copy** option automatically copies the data to the target drives on the background while writing to the source drives. The **offline copy** option allows you to copy the contents of the source drive to the target drives now.

- g. Use the up or down arrow keys to select desired copy method, then press <Enter>.
- h. The utility prompts a confirmation message. Press <Y> to confirm or <N> to return to the configuration Main Menu.



A copy progress appears if you previously selected offline copy.

Creating a RAID 5 or JBOD set

Use the Silicon Image Array Management software to create a RAID 5 or JBOD configuration on Windows® 2000/XP.

5.4.3 Intel® RAID configurations

This motherboard supports RAID 0, RAID 1, and Intel® Matrix Storage configurations for Serial ATA hard disks drives through the Intel® ICH6R chipset. Use the Intel® Application Accelerator RAID Option ROM utility to configure a disk array.

Setting the BIOS RAID items

After installing the hard disk drives, make sure to set the necessary RAID items in the BIOS before setting your RAID configuration.

To set the BIOS RAID items:

1. Boot the system and press during the Power-On Self-Test (POST) to enter the BIOS Setup Utility.
2. From the **Main > IDE Configuration** menu in the BIOS, the **Configure SATA As** item as RAID.
3. Set the **OnBoard Serial-ATA BOOTROM** item as Enabled.
4. Save your changes and exit Setup.

Entering the Intel® Application Accelerator RAID Option ROM utility

To enter the Intel® Application Accelerator RAID option ROM utility:

1. Boot up your computer.
2. During POST, press <Ctrl+I> to display the main menu of the utility.



The RAID BIOS setup screens shown in this section are for reference only, and may not exactly match the items on your screen.

```
Intel(R) Application Accelerator RAID Option ROM v4.0.0.6211
Copyright (C) 2003-04 Intel Corporation. All Rights Reserved.

[ MAIN MENU ]
1. Create RAID Volume
2. Delete RAID Volume
3. Reset Disks to Non-RAID
4. Exit

[ DISK/VOLUME INFORMATION ]

RAID Volumes:
None defined.

Non-RAID Disks:
Port Drive Model      Serial #      Size      Type/Status (Vol ID)
0 ST380013AS          xxxxxxxx     74.5GB    Non-RAID Disk
1 ST380013AS          xxxxxxxx     74.5GB    Non-RAID Disk

[ ↓↑ ] -Select      [ ESC ] Exit      [ Enter ] -Select Menu
```

At the bottom of the screen are the navigation keys. These keys allow you to move through and select menu options.



Creating a RAID Volume

To create a RAID volume:

1. From the Intel Application Accelerator RAID Option ROM utility main menu, select **1. Create RAID Volume** then press <Enter>. The following screen appears.

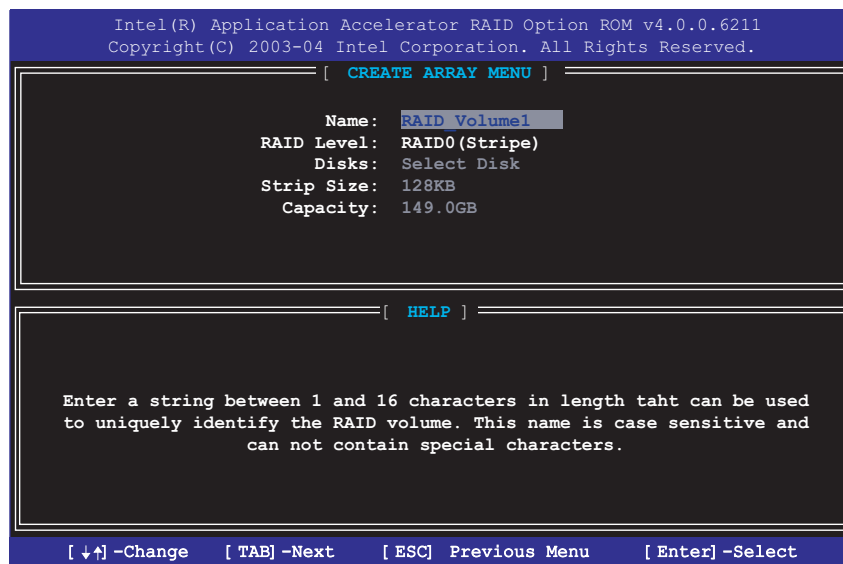

2. Key-in a unique name for your RAID volume then press <Enter>.
3. Use the up or down arrow keys to select your desired RAID Level then press <Enter>.
 - a. If you selected RAID 0 (Stripe), use the up or down arrow keys to select the stripe size for your RAID 0 array then press <Enter>.The available values range from 8 KB to 128 KB. The default selection is 128 KB. The strip value should be chosen based on the planned drive usage.
 - 8 /16 KB - low disk usage
 - 64 KB - typical disk usage
 - 128 KB - performance disk usage



TIP: For server systems, use of a lower array block size is recommended. For multimedia computer systems used mainly for audio and video editing, a higher array block size is recommended for optimum performance.

- b. If you selected RAID (Mirrored), the Create Volume prompt appears.
4. On the Create Volume prompt, press <Enter> to create the array. The utility prompts a confirmation message, press <Y>.

```
WARNING: ALL DATA ON SELECTED DISK WILL BE LOST.  
Are you sure you want to create this volume (Y/N)
```

5. Select **4. Exit** then press <Enter> to exit the RAID configuration utility. The utility prompts a confirmation message, press <Y>.

Deleting a RAID Volume



Take caution in using this option. All data on the RAID drives will be lost!

To delete a RAID Volume:

1. Select the option **2. Delete RAID Volume** then press <Enter> to display the following.

```
Intel(R) Application Accelerator RAID Option ROM v4.0.0.6211  
Copyright (C) 2003-04 Intel Corporation. All Rights Reserved.  
[ DELETE ARRAY MENU ]  
Name          Level          Drives  Capacity  Status  Bootable  
RAID Volumel  RAID0 (Stripe) 2        149.0GB  Normal  Yes  
  
[ HELP ]  
  
Deleting a volume will destroy the volume data on the drive(s) and  
cause any member disks to become available as non-RAID disks.  
  
WARNING: EXISTING DATA WITHIN THIS VOLUME WILL BE LOST AND NON-RECOVERABLE  
  
[ ↓↑ ] -Select  [ <ESC> ] -Previous Menu  [ <DEL> ] -Delete Volume
```

2. Press to delete the RAID volume. The following confirmation message appears.

```
[ VOLUME DELETE VERIFICATION ]  
  
ALL DATA IN THE VOLUME WILL BE LOST!!  
Are you sure you want to delete volume "RAID_Volume0"? (Y/N)
```

3. Press <Y> to confirm or <N> to return to the configuration Main Menu.

Resetting RAID Disks Drives



Take caution when resetting a RAID to non-RAID. Resetting all RAID data will remove any internal RAID structure from all RAID disks!

1. Select the option **3. Reset Disks to Non-RAID** then press <Enter>.

```
RESET RAID DATA  
  
Resetting RAID data will remove the internal RAID structures  
from the selected RAID disks. By removing these structures  
the drive will revert back to a Non-RAID disk.  
  
WARNING: Resetting a disk causes all data on the disk to be lost.  
  
Port Drive Model      Serial #      Size      Status  
0 STXXXXXXXXX         XXXXXXXX     XX.0GB    Member Disk  
1 STXXXXXXXXX         XXXXXXXX     XX.0GB    Member Disk  
  
Select the disk that should be reset  
  
[ ↓↑ ] -Previous/Next  [ Space ] -Selects  [ Enter ] -Selection Complete
```

2. Use the up or down arrow keys to highlight a RAID drive you wish to reset then press <Space>.
3. Repeat step 2 to select other RAID drives.
4. Press <Enter> to reset RAID drive.
5. The utility prompts a confirmation message, press <Y> to confirm or <N> to return to the configuration Main Menu.

5.4.4 ITE® 8212F RAID configurations

The ITE® 8212F IDE RAID controller supports RAID 0, RAID 1, RAID 0+1 and JBOD configurations. Use the IT8212 BIOS Setup Utility or the ATA RAID Manager application to configure a disk array.

Setting the BIOS RAID items

After installing the hard disk drives, make sure to set the necessary RAID items in the BIOS before setting your RAID configuration.

To set the BIOS RAID items:

1. Boot the system and press during the Power-On Self-Test (POST) to enter the BIOS Setup Utility.
2. From the **Advanced > Onboard Devices Configuration** menu in the BIOS, set the **ITE8212F Controller** item to RAID Mode.
3. Save your changes and exit Setup.

Entering the ITE® 8212F Setup Utility

To enter the ITE® 8212F Setup Utility:

1. Boot up your computer.
2. The ITE8212F controller scans for IDE devices attached on the IDE RAID ports. When prompted, press <Ctrl+F> or <Ctrl+E> to display the main menu of the utility.

```
IT8212 Setup Utility (C)Copyright 2002-2004 ITE, Inc.
-----[MAIN MENU]-----
Auto Configuration.....[ 1 ]
Define RAID.....[ 2 ]
Delete RAID.....[ 3 ]
Rebuild RAID.....[ 4 ]
RAID Card Configuration.....[ 5 ]

[1]..[5] Select                               [ESC] Exit
```

3. At the bottom of the screen are the navigation keys. These keys allow you to move through and select from the menu options.



4. Press the number of your selection or <Esc> to exit.

Auto-configuring a RAID array

This option allows you to select a supported RAID set for the utility to automatically configure.

To auto-configure a RAID set:

1. From the IT8212 Setup Utility screen, press <1>. The following screen appears.

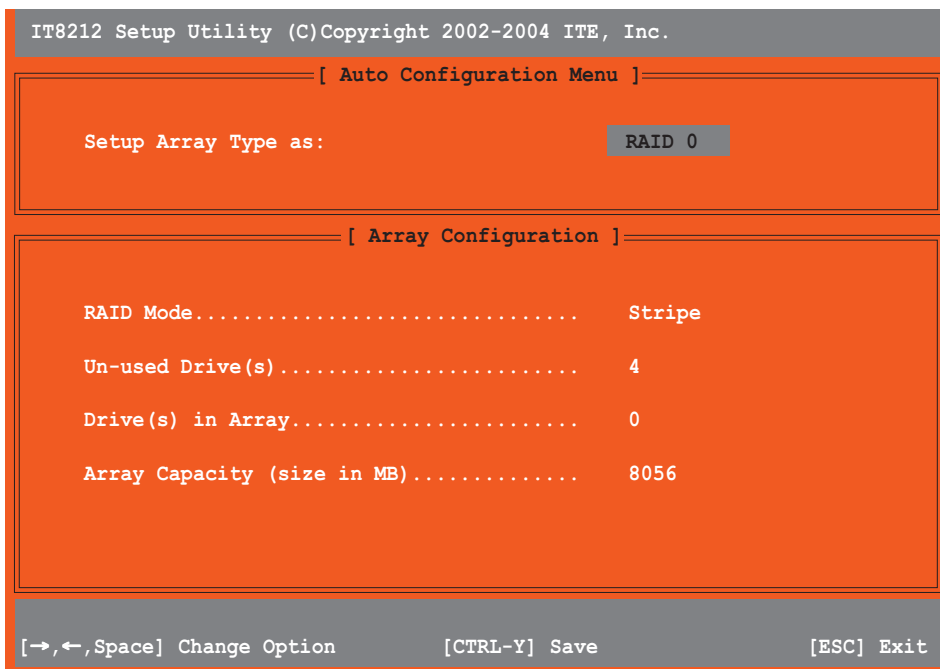

2. Use the left or right arrow keys or the space bar to select a RAID set. As you select an option, the screen displays the array configuration of the RAID based on the number of IDE devices installed.
3. Press <Ctrl+Y> to save your RAID set.
4. Press <Esc> to exit.

Defining a RAID array

This option allows you to define supported RAID arrays.

To define a RAID array:

1. From the IT8212 Setup Utility screen, press <2>. The following screen appears.

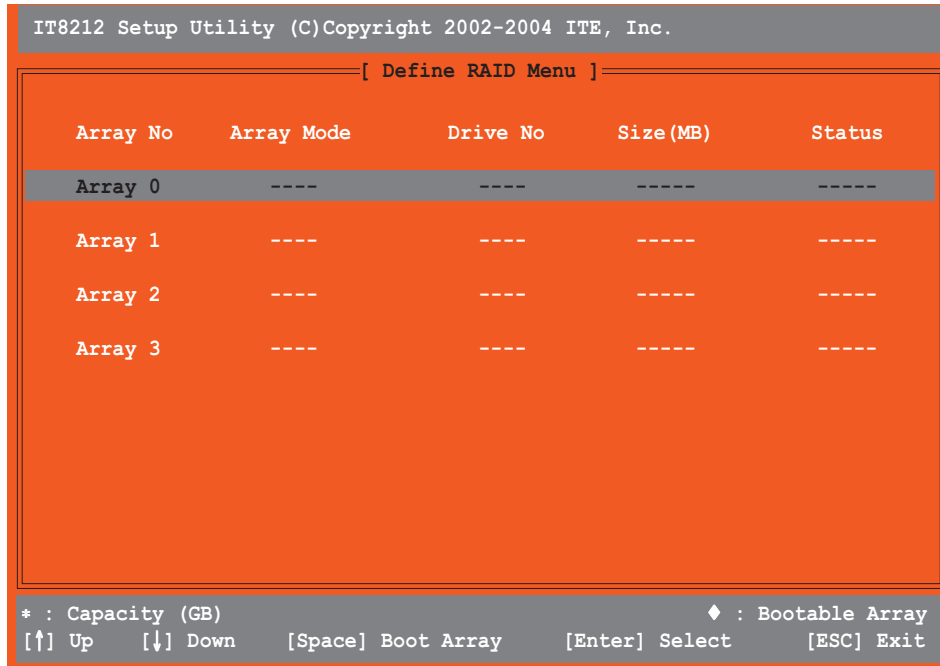

2. Use the up or down arrow keys or the space bar to select a RAID array, then press <Enter>. The following sub-menu appears.

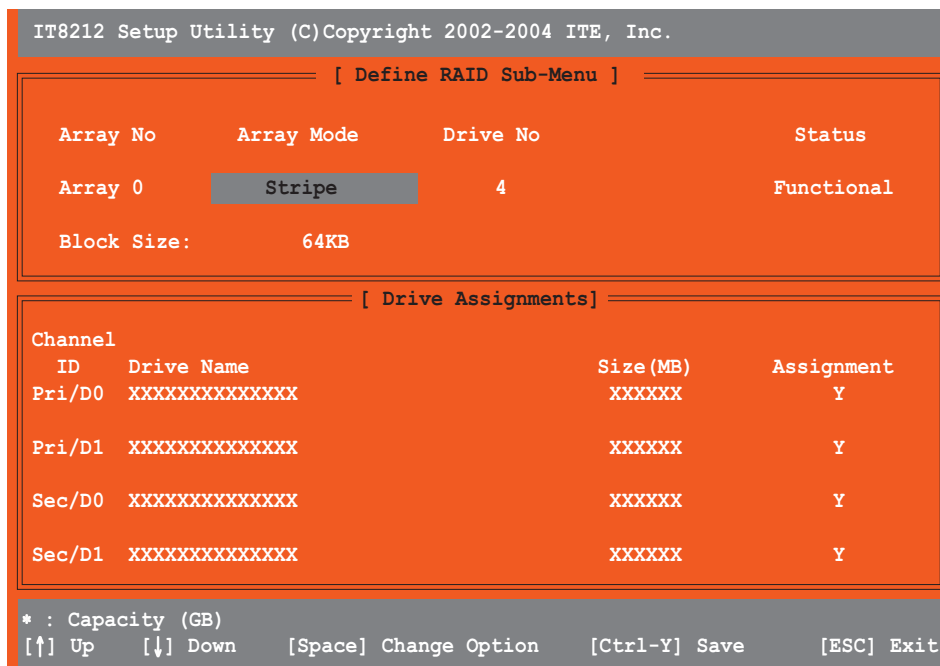

3. Use the up or down arrow keys to select editable fields.
4. Use the Space bar to change field values.
5. Press <Ctrl+Y> to save RAID array.
6. Press <Esc> to exit.

Deleting a RAID array

This option allows you to delete an existing RAID array.

To delete a RAID array:

1. From the IT8212 Setup Utility screen, press <3>. The following screen appears.

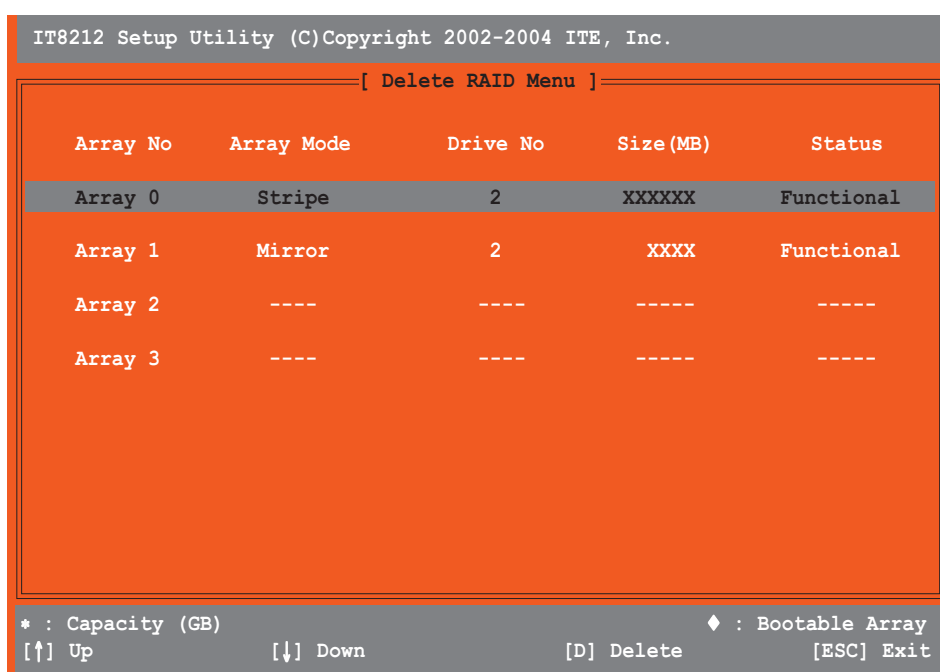

2. Use the up or down arrow keys to select a RAID array, then press <D> to delete.
3. Press <Esc> to exit.

Rebuilding a RAID array

This option allows you to reconstruct an existing RAID array. This option applies only to RAID1 (Mirrored) or RAID 0+1 (Striped+Mirrored) sets.

To rebuild a RAID array:

1. From the IT8212 Setup Utility screen, press <4>. The following screen appears.

Array No	Array Mode	Drive No	Size (MB)	Status
Array 0	Stripe	4	XXXXXX	Functional
Array 1	Mirror	2	XXXX	Functional
Array 2	----	----	----	----
Array 3	----	----	----	----

* : Capacity (GB) ♦ : Bootable Array
[↑] Up [↓] Down [Enter] Select [ESC] Exit

2. Use the up or down arrow keys to select a RAID array, then press <Enter> to rebuild. The following screen appears.

Channel ID	Drive Name	Size (MB)
Pri/D1	XXXXXXXXXX	XXXXX

Channel ID	Drive Name	Size (MB)
Sec/D1	XXXXXXXXXX	XXXXX

Channel ID	Drive Name	Size (MB)
Pri/D1	XXXXXXXXXX	XXXXX
Sec/D1	XXXXXXXXXX	XXXXX

* : Capacity (GB)
[↑] Up [↓] Down [Enter] Select [ESC] Exit

- Use the up or down arrow keys to select a drive, then press <Enter>. Follow succeeding screen instructions.
- Press <Esc> to exit.

Viewing your RAID configuration

This option allows you to view your RAID configuration. You can also enable or disable the Auto-rebuild function in this section.

To view your RAID configuration:

- From the IT8212 Setup Utility screen, press <5>. The following screen appears.

```

IT8212 Setup Utility (C)Copyright 2002-2004 ITE, Inc.
----- [ RAID Card Configuration ] -----
Auto-Rebuild:      Enable
----- [ RAID Card Resource ] -----
Channel 0          Interrupt: B      I/P Port: 0000AC00
Channel 1          Interrupt: B      I/P Port: 0000A800
----- [ Drive Status ] -----
Channel           Size           Drive
  ID  Drive Name  (MB)   Array No  Mode
Pri/D0 XXXXXXXXXXXX XXXXXX   Array 0   U5
Pri/D1 XXXXXXXXXXXX XXXXXX   Array 0   U2
Sec/D0 XXXXXXXXXXXX XXXXXX   Array 0   U4
Sec/D1 XXXXXXXXXXXX XXXXXX   Array 0   U6
* : Capacity (GB)           Drive Mode: P = PIO, D = DMA, U = UDMA
[→,←,Space] Change Option           [ESC] Exit

```

- Use the left or right keys or the space bar enable or disable the **Auto-rebuild** item.
- Press <Esc> to exit.

5.5 Creating a RAID driver disk

A floppy disk with the RAID driver is required when installing Windows® 2000/XP operating system on a hard disk drive that is included in a RAID set.

To create a RAID driver disk:

1. Place the motherboard support CD in the optical drive.
2. When the **Drivers** menu appears, select the RAID driver disk you wish to create:
 - Click **Make ITE8212 Driver Disk** to create an ITE® 8212F RAID driver disk.
 - Click **Make Silicon Image RAID Driver Disk** to create a Silicon Image SATAraid™ RAID driver disk

Or

Browse the contents of the support CD to locate the driver disk utility:

- **ITE8212 RAID Driver Disk:**
 \Drivers\ITE8212\MakeDisk
- **Silicon Image RAID Driver Disk:**
 \Drivers\Sil3114\RAID_Disk
- **Intel® RAID Driver Disk:**
 \Drivers\Chipset\Intel\IAA\F6 Install Floppy\F6flpy32



Refer to section “5.2.2 Drivers menu” for details.

3. Insert a formatted high-density floppy disk to the floppy disk drive.
4. Follow screen instructions to complete the process.
5. After creating a RAID driver disk, eject the floppy disk, then write-protect it to prevent computer virus infection.

To install the RAID driver:

1. Install an operating system to the selected hard disk drive. During installation, the computer prompts you to press the **F6** key if you are installing a third-party SCSI or RAID driver.
2. Press <F6>, then insert the RAID driver disk to the floppy disk drive.
3. Follow screen instructions to install the RAID drivers.