

**P5GC-MR**

**ASUS**<sup>®</sup>

**Motherboard**

E3429

First Edition  
September 2007

**Copyright © 2007 ASUSTeK COMPUTER INC. All Rights Reserved.**

No part of this manual, including the products and software described in it, may be reproduced, transmitted, transcribed, stored in a retrieval system, or translated into any language in any form or by any means, except documentation kept by the purchaser for backup purposes, without the express written permission of ASUSTeK COMPUTER INC. ("ASUS").

Product warranty or service will not be extended if: (1) the product is repaired, modified or altered, unless such repair, modification or alteration is authorized in writing by ASUS; or (2) the serial number of the product is defaced or missing.

ASUS PROVIDES THIS MANUAL "AS IS" WITHOUT WARRANTY OF ANY KIND, EITHER EXPRESS OR IMPLIED, INCLUDING BUT NOT LIMITED TO THE IMPLIED WARRANTIES OR CONDITIONS OF MERCHANTABILITY OR FITNESS FOR A PARTICULAR PURPOSE. IN NO EVENT SHALL ASUS, ITS DIRECTORS, OFFICERS, EMPLOYEES OR AGENTS BE LIABLE FOR ANY INDIRECT, SPECIAL, INCIDENTAL, OR CONSEQUENTIAL DAMAGES (INCLUDING DAMAGES FOR LOSS OF PROFITS, LOSS OF BUSINESS, LOSS OF USE OR DATA, INTERRUPTION OF BUSINESS AND THE LIKE), EVEN IF ASUS HAS BEEN ADVISED OF THE POSSIBILITY OF SUCH DAMAGES ARISING FROM ANY DEFECT OR ERROR IN THIS MANUAL OR PRODUCT.

SPECIFICATIONS AND INFORMATION CONTAINED IN THIS MANUAL ARE FURNISHED FOR INFORMATIONAL USE ONLY, AND ARE SUBJECT TO CHANGE AT ANY TIME WITHOUT NOTICE, AND SHOULD NOT BE CONSTRUED AS A COMMITMENT BY ASUS. ASUS ASSUMES NO RESPONSIBILITY OR LIABILITY FOR ANY ERRORS OR INACCURACIES THAT MAY APPEAR IN THIS MANUAL, INCLUDING THE PRODUCTS AND SOFTWARE DESCRIBED IN IT.

Products and corporate names appearing in this manual may or may not be registered trademarks or copyrights of their respective companies, and are used only for identification or explanation and to the owners' benefit, without intent to infringe.

# Contents

Notices.....	vi
Safety information .....	vii
About this guide .....	viii
P5GC-MR specifications summary .....	x

## Chapter 1: Product introduction

1.1	Welcome! .....	1-1
1.2	Package contents.....	1-1
1.3	Special features.....	1-2
1.3.1	Product highlights .....	1-2
1.3.2	Innovative ASUS features.....	1-4

## Chapter 2: Hardware information

2.1	Before you proceed .....	2-1
2.2	Motherboard overview.....	2-2
2.2.1	Placement direction .....	2-2
2.2.2	Screw holes .....	2-2
2.2.3	Motherboard layout.....	2-3
2.2.4	Layout contents.....	2-5
2.3	Central Processing Unit (CPU) .....	2-7
2.3.1	Installing the CPU .....	2-7
2.3.2	Installing the CPU heatsink and fan.....	2-10
2.3.3	Uninstalling the CPU heatsink and fan .....	2-12
2.4	System memory .....	2-14
2.4.1	Overview .....	2-14
2.4.2	Memory configurations.....	2-14
2.4.3	Installing a DIMM .....	2-16
2.4.4	Removing a DIMM .....	2-16
2.5	Expansion slots.....	2-17
2.5.1	Installing an expansion card .....	2-17
2.5.2	Configuring an expansion card .....	2-17
2.5.3	Interrupt assignments .....	2-18
2.5.4	PCI Express x16 slot (x16 link) .....	2-19
2.5.5	PCI Express x1 slot .....	2-19
2.5.6	PCI slots.....	2-20

# Contents

<b>2.6</b>	<b>Jumpers</b> .....	<b>2-21</b>
<b>2.7</b>	<b>Connectors</b> .....	<b>2-24</b>
2.7.1	Rear panel connectors .....	2-24
2.7.2	Internal connectors .....	2-25

## Chapter 3: Powering up

<b>3.1</b>	<b>Starting up for the first time</b> .....	<b>3-1</b>
<b>3.2</b>	<b>Powering off the computer</b> .....	<b>3-2</b>
3.2.1	Using the OS shut down function.....	3-2
3.2.2	Using the dual function power switch.....	3-2

## Chapter 4: BIOS setup

<b>4.1</b>	<b>Managing and updating your BIOS</b> .....	<b>4-1</b>
4.1.1	Creating a bootable floppy disk.....	4-1
4.1.2	AFUDOS utility .....	4-2
4.1.3	ASUS CrashFree BIOS 3 utility .....	4-5
4.1.4	ASUS Update utility .....	4-7
<b>4.2</b>	<b>BIOS setup program</b> .....	<b>4-10</b>
4.2.1	BIOS menu screen.....	4-11
4.2.2	Menu bar.....	4-11
4.2.3	Navigation keys.....	4-11
4.2.4	Menu items .....	4-12
4.2.5	Sub-menu items.....	4-12
4.2.6	Configuration fields .....	4-12
4.2.7	Pop-up window .....	4-12
4.2.8	Scroll bar.....	4-12
4.2.9	General help .....	4-12
<b>4.3</b>	<b>Main menu</b> .....	<b>4-13</b>
4.3.1	System Time [xx:xx:xx] .....	4-13
4.3.2	System Date [Day xx/xx/xxxx].....	4-13
4.3.3	Legacy Diskette A [1.44M, 3.5 in.].....	4-13
4.3.4	Primary, Third, Fourth IDE Master / Slave .....	4-14
4.3.5	IDE Configuration.....	4-15
4.3.6	System Information.....	4-17
<b>4.4</b>	<b>Advanced menu</b> .....	<b>4-18</b>
4.4.1	USB Configuration .....	4-18

# Contents

4.4.2	Remote Access Configuration.....	4-21
4.4.3	CPU Configuration.....	4-22
4.4.4	Chipset Configuration.....	4-24
4.4.5	Onboard Devices Configuration.....	4-27
4.4.6	PCI PnP.....	4-28
<b>4.5</b>	<b>Power Configuration.....</b>	<b>4-29</b>
4.5.2	APM Configuration.....	4-30
4.5.2	Hardware Monitor.....	4-31
<b>4.6</b>	<b>Boot menu.....</b>	<b>4-33</b>
4.6.1	Boot Device Priority.....	4-33
4.6.2	Boot Settings Configuration.....	4-34
4.6.3	Security.....	4-35
<b>4.7</b>	<b>Exit menu.....</b>	<b>4-38</b>

## Chapter 5: Driver installation

<b>5.1</b>	<b>LAN driver installation.....</b>	<b>5-1</b>
5.1.1	Windows® Server.....	5-1
5.1.2	SuSE® Linux.....	5-2
5.1.3	Red Hat® Linux.....	5-4
<b>5.2</b>	<b>VGA driver installation.....</b>	<b>5-6</b>
5.2.1	Windows® Server.....	5-6
5.2.2	Windows® 2003 Server.....	5-7
5.2.3	Red Hat® Enterprise.....	5-7
<b>5.3</b>	<b>Management applications and utilities installation.....</b>	<b>5-8</b>
5.3.1	Running the support CD.....	5-8
5.3.2	Drivers menu.....	5-8
5.3.3	Management Software menu.....	5-9
5.3.4	Utilities menu.....	5-9
5.3.5	Contact information.....	5-10

## Appendix A: Reference information

<b>A.1</b>	<b>P5GC-MR block diagram.....</b>	<b>A-1</b>
------------	-----------------------------------	------------

# Notices

## Federal Communications Commission Statement

This device complies with Part 15 of the FCC Rules. Operation is subject to the following two conditions:

- This device may not cause harmful interference, and
- This device must accept any interference received including interference that may cause undesired operation.

This equipment has been tested and found to comply with the limits for a Class B digital device, pursuant to Part 15 of the FCC Rules. These limits are designed to provide reasonable protection against harmful interference in a residential installation. This equipment generates, uses and can radiate radio frequency energy and, if not installed and used in accordance with manufacturer's instructions, may cause harmful interference to radio communications. However, there is no guarantee that interference will not occur in a particular installation. If this equipment does cause harmful interference to radio or television reception, which can be determined by turning the equipment off and on, the user is encouraged to try to correct the interference by one or more of the following measures:

- Reorient or relocate the receiving antenna.
- Increase the separation between the equipment and receiver.
- Connect the equipment to an outlet on a circuit different from that to which the receiver is connected.
- Consult the dealer or an experienced radio / TV technician for help.



---

The use of shielded cables for connection of the monitor to the graphics card is required to assure compliance with FCC regulations. Changes or modifications to this unit not expressly approved by the party responsible for compliance could void the user's authority to operate this equipment.

---

## Canadian Department of Communications Statement

This digital apparatus does not exceed the Class B limits for radio noise emissions from digital apparatus set out in the Radio Interference Regulations of the Canadian Department of Communications.

**This class B digital apparatus complies with Canadian ICES-003.**

# Safety information

## Electrical safety

- To prevent electrical shock hazard, disconnect the power cable from the electrical outlet before relocating the system.
- When adding or removing devices to or from the system, ensure that the power cables for the devices are unplugged before the signal cables are connected. If possible, disconnect all power cables from the existing system before you add a device.
- Before connecting or removing signal cables from the motherboard, ensure that all power cables are unplugged.
- Seek professional assistance before using an adapter or extension cord. These devices could interrupt the grounding circuit.
- Make sure that your power supply is set to the correct voltage in your area. If you are not sure about the voltage of the electrical outlet you are using, contact your local power company.
- If the power supply is broken, do not try to fix it by yourself. Contact a qualified service technician or your retailer.

## Operation safety

- Before installing the motherboard and adding devices on it, carefully read all the manuals that came with the package.
- Before using the product, make sure all cables are correctly connected and the power cables are not damaged. If you detect any damage, contact your dealer immediately.
- To avoid short circuits, keep paper clips, screws, and staples away from connectors, slots, sockets and circuitry.
- Avoid dust, humidity, and temperature extremes. Do not place the product in any area where it may become wet.
- Place the product on a stable surface.
- If you encounter technical problems with the product, contact a qualified service technician or your retailer.



---

The symbol of the crossed out wheeled bin indicates that the product (electrical and electronic equipment, Mercury-containing button cell battery) should not be placed in municipal waste. Check local regulations for disposal of electronic products.

---

# About this guide

This user guide contains the information you need when installing and configuring the motherboard.

## How this guide is organized

This manual contains the following parts:

- **Chapter 1: Product introduction**  
This chapter describes the features of the motherboard and the new technology it supports.
- **Chapter 2: Hardware information**  
This chapter lists the hardware setup procedures that you have to perform when installing system components. It includes description of the switches, jumpers, and connectors on the motherboard.
- **Chapter 3: Powering up**  
This chapter describes the power up sequence, the vocal POST messages, and ways of shutting down the system.
- **Chapter 4: BIOS setup**  
Tells how to change system settings through the BIOS Setup menus. Detailed descriptions of the BIOS parameters are also provided.
- **Chapter 5: Driver installation**  
This chapter provides information on VGA and LAN driver installation for this motherboard.
- **Appendix: Reference information**  
This appendix includes additional information that you may refer to when configuring the motherboard.

## Where to find more information

Refer to the following sources for additional information and for product and software updates.

1. **ASUS websites**  
The ASUS website provides updated information on ASUS hardware and software products. Refer to the ASUS contact information.
2. **Optional documentation**  
Your product package may include optional documentation, such as warranty flyers, that may have been added by your dealer. These documents are not part of the standard package.



## Conventions used in this guide

To make sure that you perform certain tasks properly, take note of the following symbols used throughout this manual.



**DANGER / WARNING:** Information to prevent injury to yourself when trying to complete a task.



**CAUTION:** Information to prevent damage to the components when trying to complete a task.



**IMPORTANT:** Instructions that you **MUST** follow to complete a task.



**NOTE:** Tips and additional information to help you complete a task.

## Typography

**Bold text**

Indicates a menu or an item to select.

*Italics*

Used to emphasize a word or a phrase.

<Key>

Keys enclosed in the less-than and greater-than sign means that you must press the enclosed key.

<Key1> + <Key2> + <Key3>

Example: <Enter> means that you must press the Enter or Return key.

If you must press two or more keys simultaneously, the key names are linked with a plus sign (+).

**Command**

Example: <Ctrl> + <Alt> +<Del>

Means that you must type the command exactly as shown, then supply the required item or value enclosed in brackets.

Example: At the DOS prompt, type the command line:

**format A:/S**

## P5GC-MR specifications summary

CPU	<p>Dual-Core Intel® Xeon™ 3000 series (65W)*            Dual-Core Intel® Core™ 2 Duo series (65W)*            Intel® Conroe-L 400 series            * Intel CPU over 65W is not supported            Supports Intel® Enhanced Memory 64 Technology (EM64T)            Supports Enhanced Intel SpeedStep® Technology (EIST)</p>
Chipset	<p>NorthBridge: Intel® 945GC MCH            SouthBridge: Intel® ICH7</p>
Front Side Bus	533 / 800 / 1066 MHz
Memory	<p>Dual-channel memory architecture            2 x 240-pin DIMM sockets support unbuffered            non-ECC DDR2-400 / 533 / 667 memory modules            Supports up to 4 GB system memory</p>
Expansion slots *	<p>1 x PCI-E X16 slot (x16 link)            1 x PCI-E X1 slot (x1 link)            ( This slot supports x16 Link only when connected to a PCIe            x16 graphics card.)            2 x PCI 33 MHz / 32-bit / 5V slots (PCI 2.2 Compatible)</p>
Storage	<p>Intel® ICH7 Southbridge supports:</p> <ul style="list-style-type: none"> <li>- 1 X IDE port supports two Ultra ATA 100 / 66 / 33 devices</li> <li>- 4 x Serial ATAII 300MB / s drivers</li> </ul>
Graphics	Integrated Intel® Graphics Media Accelerator 950
LAN	2 x Marvell 88E8056 Giga PCI-E LAN Controllers that comply with PCI Express 1.0a specifications
USB	<p>Intel ICH7 Southbridge supports:</p> <ul style="list-style-type: none"> <li>- 4 USB 2.0 ports (two on the rear panel, two on the board)</li> </ul>
Special features	<p>ASUS CrashFree BIOS 3            ASUS MyLogo2            Smart Fan I            ASWM2.0</p>

*(continued on the next page)*

## P5GC-MR specifications summary

BIOS features	AMI BIOS, 8 MB Flash ROM, Green, PnP, DMI, SMBIOS 2.5, WfM2.0, ACPI 2.0a
Rear panel	1 x PS / 2 keyboard port (purple) 1 x PS / 2 mouse port (green) 2 x USB 2.0 ports 1 x Serial port (COM1) 1 x VGA port 2 x LAN (RJ-45) ports
Internal connectors	1 x Floppy disk drive connector 1 x IDE connector 4 x Black Serial ATA connectors 1 x chassis fan connectors 1 x CPU fan connector 1 x 24-pin ATX power connector 1 x 4-pin ATX 12 V power connector 1 x USB connector for two additional USB1.1 and USB 2.0 ports 1 x 20 pin system panel auxiliary connector 1 x 20 pin system panel connector
Power Requirement	ATX power supply (with 24-pin and 4-pin 12 V plugs) ATX 12 V 2.0 compliant
Form Factor	uATX form factor: 9.6 in x 7.4 in
Support CD contents	Device drivers ASUS Live Update utility ASUS Server Web-based Management (ASWM 2.0)

*\*Specifications are subject to change without notice.*



This chapter describes the motherboard features and the new technologies it supports.

# 1 Product introduction

# Chapter summary



- 1.1 Welcome! ..... 1-1
- 1.2 Package contents..... 1-1
- 1.3 Special features..... 1-2

## 1.1 Welcome!

Thank you for buying an ASUS® P5GC-MR motherboard!

The motherboard delivers a host of new features and latest technologies, making it another standout in the long line of ASUS quality motherboards!

Before you start installing the motherboard, and hardware devices on it, check the items in your package with the list below.

## 1.2 Package contents

Check your motherboard package for the following items.

P5GC-MR			
		Gift Box Content	Bulk Pack Content
Cables	Serial ATA signal cable	4	-
	Serial ATA power cable	2	-
	2-in-1 cable set	1	-
	3-in-1 cable set	-	-
Accessories	I/O shield	1	10
Application CD	Support CD	1	10
Document	User guide	1	10
Packing Quantity		3 pieces per carton	10 pieces per carton



If any of the above items is damaged or missing, contact your retailer.

## 1.3 Special features

### 1.3.1 Product highlights

#### Intel® Core™ 2 Duo



This motherboard supports the latest powerful and energy efficient processors from Intel®. Intel® Core™ 2 Duo is based on the Intel® Core™ Microarchitecture and built on the 65-nanometer (nm) process technology with copper interconnect. Intel® Core™ 2 Duo allows users to step up to new levels of gaming experience and multi-tasking performance. Boosting performance is a shared and multi-core optimized L2 cache of 2 MB or 4 MB, guaranteeing enhanced user experience in the digital home and office. See page 1-8 for details.



---

Due to chipset limitation, Intel® Core™ 2 processors can only run at a maximum speed of 1066 MHz FSB on this motherboard.

---

#### Intel® EM64T



The motherboard supports Intel® LGA775 CPUs with the Intel® EM64T (Extended Memory 64 Technology). The Intel® EM64T feature allows your computer to run on 64-bit operating systems and access larger amounts of system memory for faster and more efficient computing.

#### Enhanced Intel SpeedStep® Technology (EIST)

The Enhanced Intel SpeedStep® Technology (EIST) intelligently manages the CPU resources by automatically adjusting the CPU voltage and core frequency depending on the CPU loading and system speed or power requirement.

#### Intel® 945GC chipset



The Intel® 945GC graphics memory controller hub (GMCH) and the ICH7 I/O controller hub provide the vital interfaces for the motherboard. The GMCH features the Intel® Graphics Media Accelerator 950, an integrated graphics engine for enhanced 3D, 2D, and video capabilities. The GMCH contains one 16-lane PCI Express port intended for an external PCI Express graphics card and provides the interface for a processor in the 775-land package with 1066/800 MHz front side bus (FSB), dual channel DDR2 at speeds of up to 667 MHz.

The Intel® ICH7 Southbridge represents the seventh generation I/O controller hub that provides the interface for PCI Express.





## DDR2 memory support

The motherboard supports DDR2 memory which features data transfer rates of 667/533 MHz to meet the higher bandwidth requirements of the latest 3D graphics, multimedia, and Internet applications. The dual-channel DDR2 architecture doubles the bandwidth of your system memory to boost system performance, eliminating bottlenecks with peak bandwidths of up to 10.6 GB/s. See pages 1-15 to 1-19 for details.



## PCI Express™ interface

The motherboard fully supports PCI Express, the latest I/O interconnect technology that speeds up the PCI bus. PCI Express features point-to-point serial interconnections between devices and allows higher clockspeeds by carrying data in packets. This high speed interface is software compatible with existing PCI or PCI-X specifications. See page 2-17 for details.



## Gigabit LAN solution

The motherboard comes with dual Gigabit LAN controllers and ports to provide a total solution for your networking needs. The two onboard Marvell 88E8056 Gigabit LAN controllers use the PCI Express interface and could achieve network throughput close to Gigabit bandwidth. See page 2-23 for details.



## USB 2.0 technology

The motherboard implements the Universal Serial Bus (USB) 2.0 specification, dramatically increasing the connection speed from the 12 Mbps bandwidth on USB 1.1 to a fast 480 Mbps on USB 2.0. USB 2.0 is backward compatible with USB 1.1. See pages 2-23 and 2-27 for details.

## Temperature, fan, and voltage monitoring

The CPU temperature is monitored by the ASIC (integrated in the Winbond hardware monitor) to prevent overheating and damage. The system fan rotations per minute (RPM) is monitored for timely failure detection. The ASIC monitors the voltage levels to ensure stable supply of current for critical components. See page 4-30 for details.

## 1.3.2 Innovative ASUS features



### CrashFree BIOS 3

This feature allows you to restore the original BIOS data from the Floppy or USB flash drive in case when the BIOS codes and data are corrupted. This protection eliminates the need to buy a replacement ROM chip. See page 4-5 for details.



### ASUS MyLogo2™

This new feature present in the motherboard allows you to personalize and add style to your system with customizable boot logos. See page 4-32 for details.

### ASUS Smart Fan technology I

The ASUS Smart Fan technology smartly adjusts the fan speeds according to the system loading to ensure quiet, cool, and efficient operation.

This chapter lists the hardware setup procedures that you have to perform when installing system components. It includes description of the jumpers and connectors on the motherboard.

# Hardware 2 information

2.1	Before you proceed .....	2-1
2.2	Motherboard overview.....	2-2
2.3	Central Processing Unit (CPU) .....	2-8
2.4	System memory .....	2-15
2.5	Expansion slots.....	2-17
2.6	Jumpers .....	2-20
2.7	Connectors .....	2-24

## 2.1 Before you proceed

Take note of the following precautions before you install motherboard components or change any motherboard settings.



- Unplug the power cord from the wall socket before touching any component.
- Use a grounded wrist strap or touch a safely grounded object or a metal object, such as the power supply case, before handling components to avoid damaging them due to static electricity.
- Hold components by the edges to avoid touching the ICs on them.
- Whenever you uninstall any component, place it on a grounded antistatic pad or in the bag that came with the component.
- **Before you install or remove any component, ensure that the ATX power supply is switched off or the power cord is detached from the power supply.** Failure to do so may cause severe damage to the motherboard, peripherals, or components, or all of the above articles.

### Onboard LED

The motherboard comes with a standby power LED. The green LED lights up to indicate that the system is ON, in sleep mode, or in soft-off mode. This is a reminder that you should shut down the system and unplug the power cable before removing or plugging in any motherboard component. The illustration below shows the location of the onboard LED.

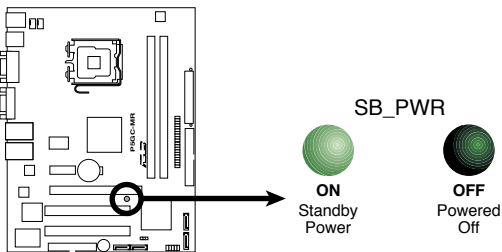

**P5GC-MR Onboard LED**

## 2.2 Motherboard overview

Before you install the motherboard, study the configuration of your chassis to ensure that the motherboard fits into it.

To optimize the motherboard features, we highly recommend that you install it in an **ATX 2.2 compliant chassis**.



Make sure to unplug the power cord before installing or removing the motherboard. Failure to do so can cause you physical injury and damage to the motherboard components.

### 2.2.1 Placement direction

When installing the motherboard, make sure that you place it into the chassis in the correct orientation. The edge with external ports goes to the rear part of the chassis as indicated in the image below.

### 2.2.2 Screw holes

Place six (6) screws into the holes indicated by circles to secure the motherboard to the chassis.



Do not overtighten the screws! Doing so can damage the motherboard.

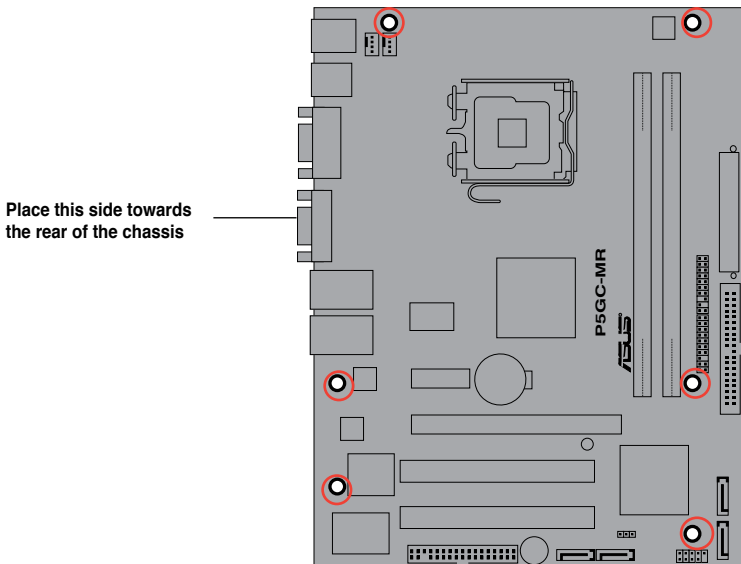

## 2.2.3 Motherboard layout

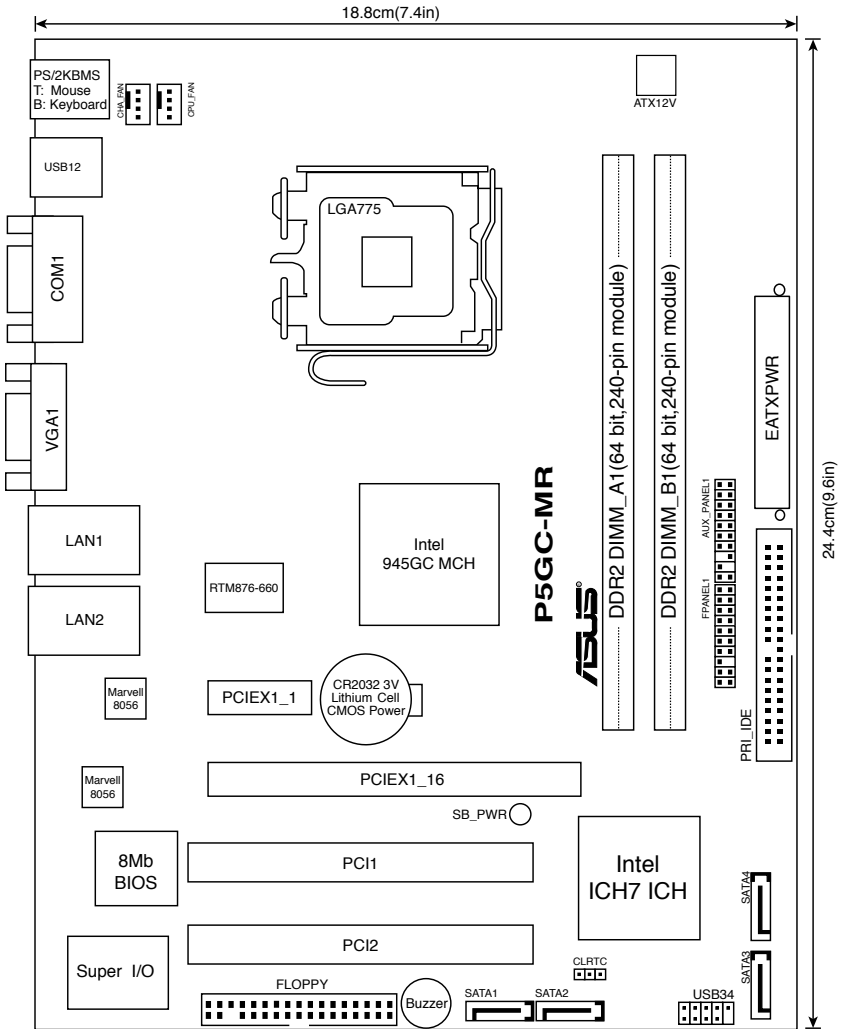

**P5GC-MR Layout**

## 2.2.4 Layout contents

Slots/Sockets		Page
1.	CPU socket	2-5
2.	DDR2 DIMM slots	2-11
3.	PCI/PCI Express slots	2-16

Jumpers		Page
1.	Clear RTC RAM (CLRTC1)	2-18

Rear panel connectors		Page
1.	PS/2 mouse port (green)	2-19
2.	LAN (RJ-45) port 2	2-19
3.	LAN (RJ-45) port 1	2-19
4.	VGA port	2-19
5.	Serial (COM1) port	2-19
6.	USB 2.0 ports 1 and 2	2-19
7.	PS/2 keyboard port (purple)	2-19

Internal connectors		Page
1.	Floppy disk drive connector (34-1 pin FLOPPY1)	2-20
2.	ICH7 primary IDE connector (40-1 pin PRI_IDE)	2-21
3.	Serial ATA connectors (7-pin SATA1, SATA2, SATA3, SATA4)	2-22
4.	USB connector (10-1 pin USB34)	2-23
5.	CPU and Chassis fan connector (4-pin CPU_FAN, CHA_FAN)	2-24
6.	ATX power connectors (24-pin ATXPWR1, 4-pin ATX12V1)	2-25
7.	System panel auxiliary connector (20-pin AUX_PANEL1)	2-26
8.	System panel connector (20-pin FPANEL1)	2-27



## 2.3 Central Processing Unit (CPU)

The motherboard comes with a surface mount LGA775 socket designed for the Intel® Xeon® 3000 series in the 775-land package.



- Upon purchase of the motherboard, make sure that the PnP cap is on the socket and the socket contacts are not bent. Contact your retailer immediately if the PnP cap is missing, or if you see any damage to the PnP cap/socket contacts/motherboard components. ASUS shoulders the repair cost only if the damage is shipment/transit-related.
- Keep the cap after installing the motherboard. ASUS will process Return Merchandise Authorization (RMA) requests only if the motherboard comes with the cap on the LGA775 socket.
- The product warranty does not cover damage to the socket contacts resulting from incorrect CPU installation/removal, or misplacement/loss/incorrect removal of the PnP cap.

### 2.3.1 Installing the CPU

To install a CPU:

1. Locate the CPU socket on the motherboard.

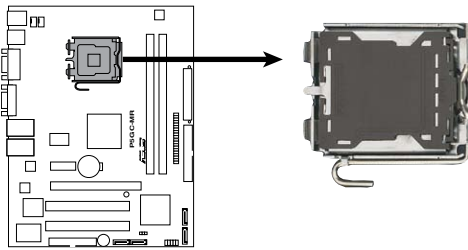

**P5GC-MR CPU Socket 775**



Before installing the CPU, make sure that the cam box is facing towards you and the load lever is on your left.

2. Press the load lever with your thumb (A), then move it to the left (B) until it is released from the retention tab.

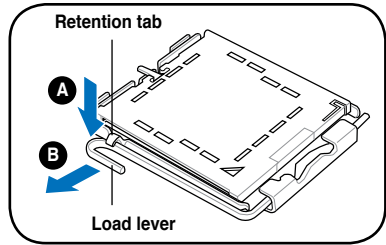

To prevent damage to the socket pins, do not remove the PnP cap unless you are installing a CPU.

3. Lift the load lever in the direction of the arrow to a 135° angle.
4. Lift the load plate with your thumb and forefinger to a 100° angle (4A), then push the PnP cap from the load plate window to remove (4B).

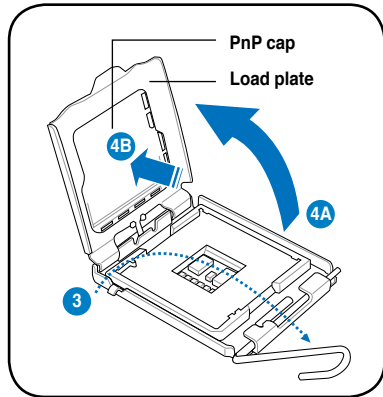

5. Position the CPU over the socket, making sure that the gold triangle is on the bottom-left corner of the socket. The socket alignment key should fit into the CPU notch.

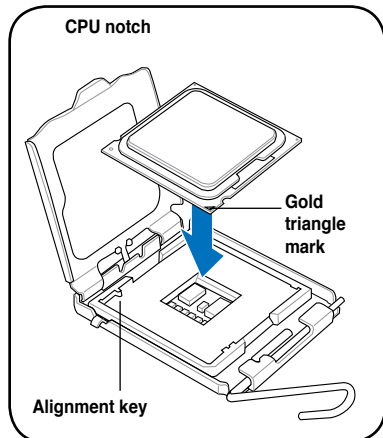



---

The CPU fits in only one correct orientation. **DO NOT** force the CPU into the socket to prevent bending the connectors on the socket and damaging the CPU!

---

6. Close the load plate (A), then push the load lever (B) until it snaps into the retention tab.

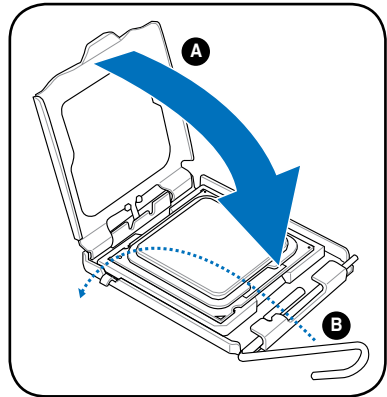

---

The motherboard supports Intel® LGA775 processors with the Intel® Enhanced Memory 64 Technology (EM64T), Enhanced Intel SpeedStep® Technology (EIST), and Hyper-Threading Technology. Refer to the Appendix for more information on these CPU features.

---

## 2.3.2 Installing the CPU heatsink and fan

The Intel® LGA775 processor requires a specially designed heatsink and fan assembly to ensure optimum thermal condition and performance.



- 
- When you buy a boxed Intel® processor, the package includes the CPU fan and heatsink assembly.
  - Your Intel® LGA775 heatsink and fan assembly comes in a push-pin design and requires no tool to install.
  - If you purchased a separate CPU heatsink and fan assembly, make sure that you have properly applied Thermal Interface Material to the CPU heatsink or CPU before you install the heatsink and fan assembly.
- 



- 
- Make sure that you use Intel®-certified multi-directional heatsink and fan only.
  - Make sure that you have installed the motherboard to the chassis before you install the CPU fan and heatsink assembly.
- 

To install the CPU heatsink and fan:

1. Place the heatsink on top of the installed CPU, ensuring that the four fasteners match the holes on the motherboard.



---

Orient the heatsink and fan assembly such that the CPU fan cable is closest to the CPU fan connector.

---



---

Make sure to orient each fastener with the narrow end of the groove pointing outward. (The illustration shows the groove shaded for emphasis.)

---

2. Push down two fasteners at a time in a diagonal sequence to secure the heatsink and fan assembly in place.

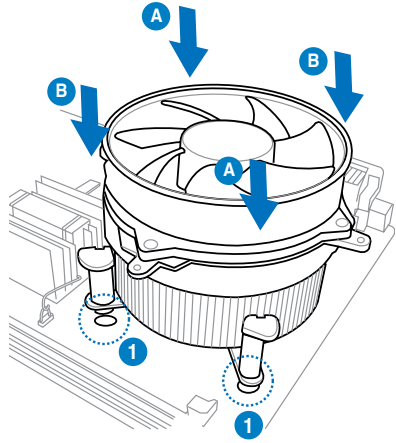
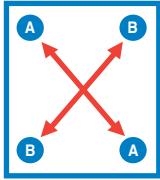

3. Connect the CPU fan cable to the connector on the motherboard labeled CPU\_FAN.

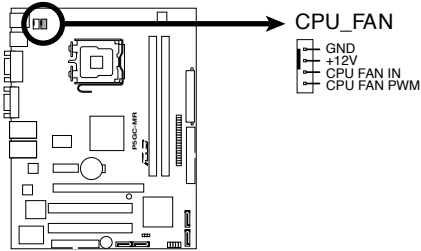

**P5GC-MR CPU Fan Connector**



Do not forget to connect the CPU fan connector! Hardware monitoring errors can occur if you fail to plug this connector.

### 2.3.3 Uninstalling the CPU heatsink and fan

To uninstall the CPU heatsink and fan:

1. Disconnect the CPU fan cable from the connector on the motherboard.
2. Rotate each fastener counterclockwise.

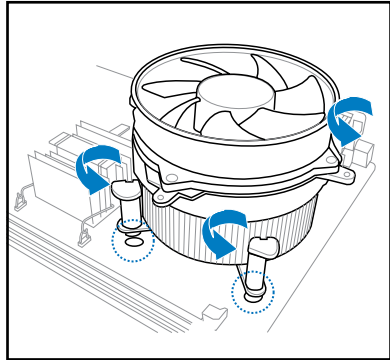

3. Pull up two fasteners at a time in a diagonal sequence to disengage the heatsink and fan assembly from the motherboard.

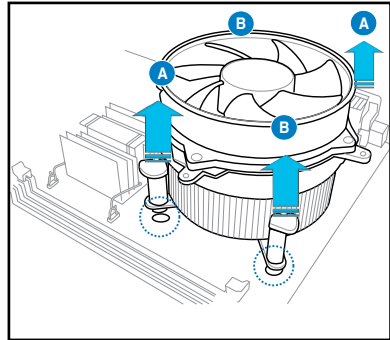
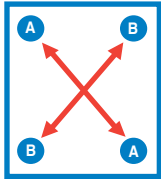

4. Carefully remove the heatsink and fan assembly from the motherboard.

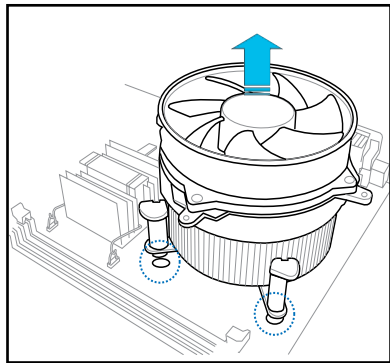

Refer to the documentation in the boxed or stand-alone CPU fan package for detailed information on CPU fan installation.

## 2.4 System memory

### 2.4.1 Overview

The motherboard comes with four Double Data Rate 2 (DDR2) Dual Inline Memory Modules (DIMM) sockets.

A DDR2 module has the same physical dimensions as a DDR DIMM but has a 240-pin footprint compared to the 184-pin DDR DIMM. DDR2 DIMMs are notched differently to prevent installation on a DDR DIMM socket.

The figure illustrates the location of the DDR2 DIMM sockets:

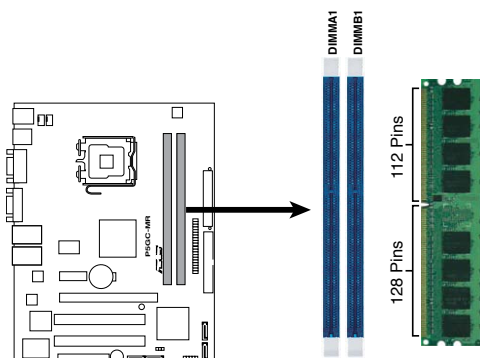

**P5GC-MR 240-pin DDR2 DIMM Sockets**

### 2.4.2 Memory configurations

You may install 256 MB, 512 MB, 1 GB, and 2 GB unbuffered ECC or non-ECC DDR2-400 / 533 / 667 DIMMs into the DIMM sockets.



- Always install DIMMs with the same CAS latency. For optimum compatibility, we recommend that you obtain memory modules from the same vendor. Refer to the DDR2 Qualified Vendors List on the ASUS web site.
- When installing one or two DIMMs, install the DIMM(s) to the blue slots

## Recommended memory configurations

Channel	Sockets
Channel A	DIMM_A1
Channel B	DIMM_B1



- For dual-channel configuration, the total size of memory module(s) installed per channel must be the same (DIMM\_A1 = DIMM\_B1).
-



## 2.4.3 Installing a DIMM



Unplug the power supply before adding or removing DIMMs or other system components. Failure to do so can cause severe damage to both the motherboard and the components.

To install a DIMM:

1. Unlock a DIMM socket by pressing the retaining clips outward.
2. Align a DIMM on the socket such that the notch on the DIMM matches the break on the socket.
3. Firmly insert the DIMM into the socket until the retaining clips snap back in place and the DIMM is properly seated.

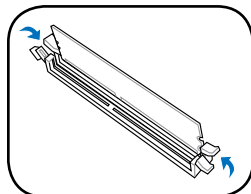
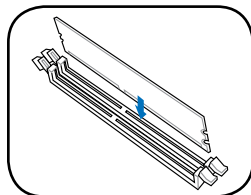
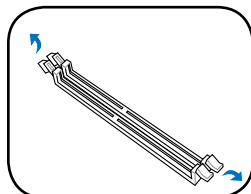

- A DDR2 DIMM is keyed with a notch so that it fits in only one direction. DO NOT force a DIMM into a socket to avoid damaging the DIMM.
- The DDR2 DIMM sockets do not support DDR DIMMs. DO NOT install DDR DIMMs to the DDR2 DIMM sockets.

## 2.4.4 Removing a DIMM

Follow these steps to remove a DIMM.

1. Simultaneously press the retaining clips outward to unlock the DIMM.



Support the DIMM lightly with your fingers when pressing the retaining clips. The DIMM might get damaged when it flips out with extra force.

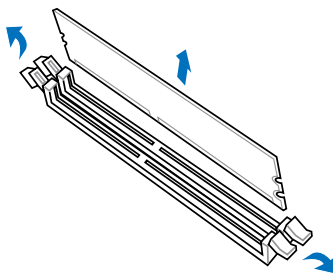

2. Remove the DIMM from the socket.

## 2.5 Expansion slots

In the future, you may need to install expansion cards. The following sub-sections describe the slots and the expansion cards that they support.



---

Make sure to unplug the power cord before adding or removing expansion cards. Failure to do so may cause you physical injury and damage to the motherboard components.

---

### 2.5.1 Installing an expansion card

To install an expansion card:

1. Before installing the expansion card, read the documentation that came with it and make the necessary hardware settings for the card.
2. Remove the system unit cover (if your motherboard is already installed in a chassis).
3. Remove the bracket opposite the slot that you intend to use. Keep the screw for later use.
4. Align the card connector with the slot and press firmly until the card is completely seated on the slot.
5. Secure the card to the chassis with the screw you removed earlier.
6. Replace the system cover.

### 2.5.2 Configuring an expansion card

After installing the expansion card, configure it by adjusting the software settings.

1. Turn on the system and change the necessary BIOS settings, if any. See Chapter 4 for information on BIOS setup.
2. Assign an IRQ to the card. Refer to the tables on the next page.
3. Install the software drivers for the expansion card.



---

When using PCI cards on shared slots, ensure that the drivers support “Share IRQ” or that the cards do not need IRQ assignments. Otherwise, conflicts will arise between the two PCI groups, making the system unstable and the card inoperable. Refer to the table on the next page for details.

---

## 2.5.3 Interrupt assignments

### Standard interrupt assignments

IRQ	Standard Function
0	System Timer
1	Keyboard Controller
4	Communications Port (COM1)*
6	Floppy Disk Controller
8	System CMOS/Real Time Clock
9	Microsoft ACPI-Compliant System
10	IRQ holder for PCI steering*
11	IRQ holder for PCI steering*
12	PS/2 Compatible Mouse Port*
13	Numeric Data Processor
14	Primary IDE Channel

\* These IRQs are usually available for ISA or PCI devices.

## PCI Bus Number, IDSEL, and IRQ assignments

Description	INTA	INTB	INTC	INTD	REQ#	GNT#
PCI-E X1 slot						
PCI-E X16 slot						
PCI1 slot	PIRQB#	PIROC#	PIRQD#	PIRQA#	REG0	GNT0
PCI2 slot	PIRQF#	PIROG#	PIRQH#	PIRQE#	REG1	GNT1
Onboard USB Controller1	IRQ3					
Onboard USB Controller2		IRQB				
Onboard USB Controller3			IRQA			
Onboard USB Controller4				IRQ7		
Onboard USB2.0 Controller	IRQ3					
Onboard LAN1	IRQA					
Onboard LAN2	IRQB					
Onboard VGA	IRQ5					

### 2.5.4 PCI Express x16 slot (x16 link)

This motherboard supports PCI Express x16 graphics cards that comply with the PCI Express specifications. The following figure shows a graphics card installed on the PCI Express x16 slot.

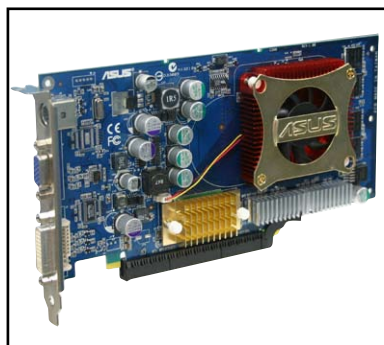

### 2.5.5 PCI Express x1 slot (x1 link)

This motherboard supports PCI Express x1 network cards, SCSI cards, and other cards that comply with PCI Express 1.0a specifications.

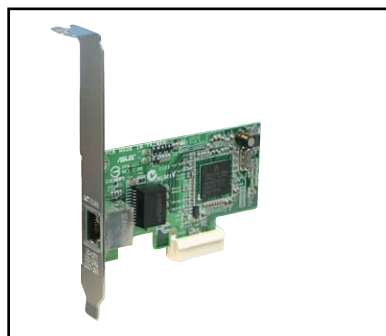

## 2.5.6 PCI slots

The PCI slots support cards such as a LAN card, SCSI card, USB card, and other cards that comply with PCI 2.2/PCI-X specifications. The figure shows a LAN card installed on a 32-bit PCI slot.

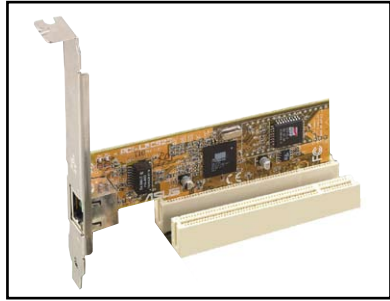

## 2.6 Jumpers

### 1. Clear RTC RAM (CLRRTC1)

This jumper allows you to clear the Real Time Clock (RTC) RAM in CMOS. You can clear the CMOS memory of date, time, and system setup parameters by erasing the CMOS RTC RAM data. The onboard button cell battery powers the RAM data in CMOS, which include system setup information such as system passwords.

To erase the RTC RAM:

1. Turn OFF the computer and unplug the power cord.
2. Remove the onboard battery.
3. Move the jumper cap from pins 1-2 (default) to pins 2-3. Keep the cap on pins 2-3 for about 5~10 seconds, then move the cap back to pins 1-2.
4. Re-install the battery.
5. Plug the power cord and turn ON the computer.
6. Hold down the <Del> key during the boot process and enter BIOS setup to re-enter data.



---

Except when clearing the RTC RAM, never remove the cap on CLRRTC jumper default position. Removing the cap will cause system boot failure!

---

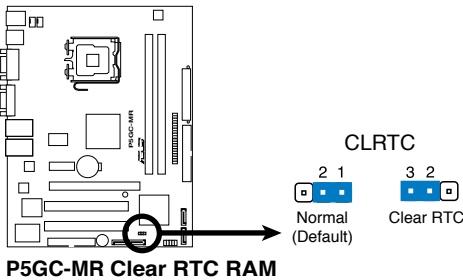

## 2.7 Connectors

### 2.7.1 Rear panel connectors

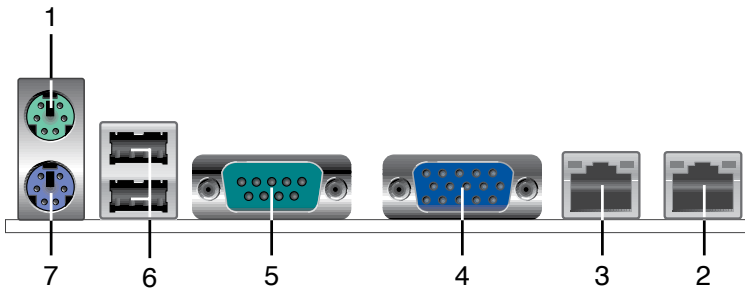

### P5GC-MR

1. **PS/2 mouse port (green).** This port is for a PS/2 mouse.
2. **LAN (RJ-45) port2.** These ports allow Gigabit connection to a Local Area Network (LAN) through a network hub.
3. **LAN (RJ-45) port1.** These ports allow Gigabit connection to a Local Area Network (LAN) through a network hub.

### LAN port LED indications

ACT/LINK LED		SPEED LED	
Status	Description	Status	Description
OFF	No link	OFF	No link
GREEN	Linked	YELLOW	100 Mbps connection
BLINKING	Data activity	GREEN	1 Gbps connection

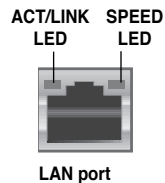

4. **VGA port.** This port is for a VGA monitor or other VGA-compatible devices.
5. **Serial (COM1) port.** This 9-pin communication port is for pointing devices or other serial devices.
6. **USB 2.0 ports 1 and 2.** These two 4-pin Universal Serial Bus (USB) ports are available for connecting USB 2.0 devices.
7. **PS/2 keyboard port (purple).** This port is for a PS/2 keyboard.

## 2.7.2 Internal connectors

### 1. Floppy disk drive connector (34-1 pin FLOPPY1)

This connector is for the provided Floppy Disk Drive (FDD) signal cable. Insert one end of the cable to this connector, then connect the other end to the signal connector at the back of the floppy disk drive.



---

Pin 5 on the connector is removed to prevent incorrect cable connection when using a FDD cable with a covered Pin 5.

---

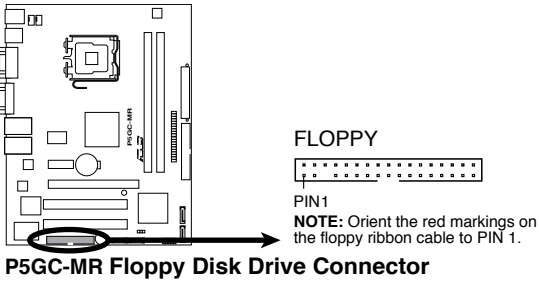



## 2. ICH7 primary IDE connector (40-pin PRI\_IDE1)

This connector is for an Ultra DMA 100/66 signal cable. The Ultra DMA 100/66 signal cable has three connectors: a blue connector for the primary IDE connector on the motherboard. If you install two hard disk drives, you must configure the second drive as a slave device by setting its jumper accordingly. Refer to the hard disk documentation for the jumper settings.

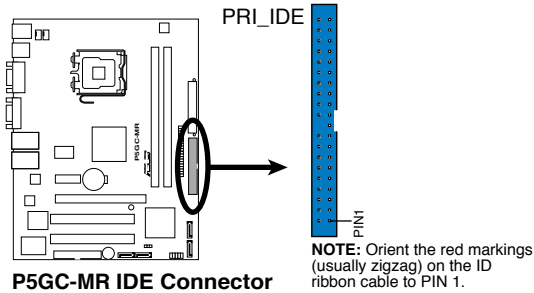

- Pin 20 on the IDE connector is removed to match the covered hole on the Ultra DMA cable connector. This prevents incorrect insertion when you connect the IDE cable.
- Use the 80-conductor IDE cable for Ultra DMA 100 / 66 IDE devices.

### 3. Serial ATA connectors (7-pin SATA1, SATA2, SATA3, SATA4)

These connectors are for the Serial ATA signal cables for Serial ATA hard disk drives.



---

These connectors are set **IDE** mode by default. In **IDE** mode, you can connect Serial ATA boot/data hard disk drives to these connectors.

---

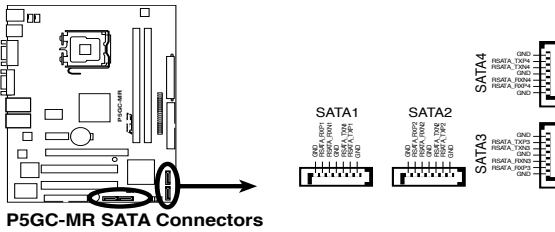

- When using the connectors in **IDE** mode, connect the primary (boot) hard disk drive to the SATA1 or SATA2 connector. Refer to the table below for the recommended SATA hard disk drive connections.

#### Serial ATA hard disk drive connection

Connector	Setting	Use
SATA1/SATA2	Master	Boot disk
SATA3/SATA4	Slave	Data disk

#### 4. USB connector (10-1 pin USB34)

This connector is for USB 2.0 ports. Connect the USB module cable to this connector, then install the module to a slot opening at the back of the system chassis. This USB connector complies with USB 2.0 specification that supports up to 480 Mbps connection speed.

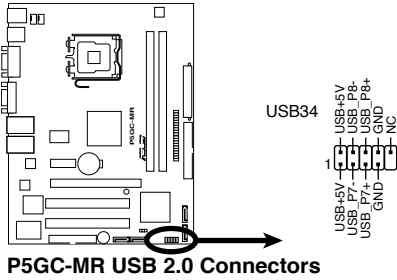

---

The USB port module is purchased separately.

---

### 5. CPU and Chassis fan connector (4-pin CPU\_FAN, CHA-FAN)

The fan connector supports cooling fan of 350 mA ~ 740 mA (8.88 W max.) at +12V. Connect the fan cables to the fan connectors on the motherboard, making sure that the black wire of each cable matches the ground pin of the connector.



Do not forget to connect the fan cables to the fan connectors. Insufficient air flow inside the system may damage the motherboard components. These are not jumpers! Do not place jumper caps on the fan connectors!

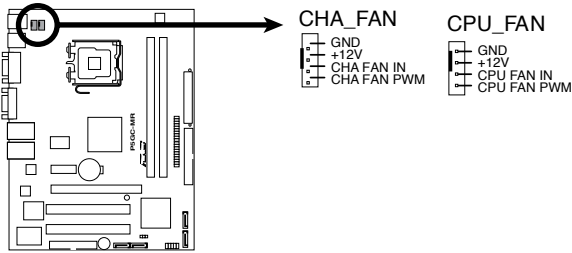

**P5GC-MR Fan Connectors**

## 6. ATX power connectors (24-pin ATXPWR1, 4-pin ATX12V1)

These connectors are for SSI power supply plugs. The power supply plugs are designed to fit these connectors in only one orientation. Find the proper orientation and push down firmly until the connectors completely fit.



- Use of an ATX 12 V Specification 2.0-compliant power supply unit (PSU) that provides a minimum power of 450 W is recommended for a fully-configured system.
- Do not forget to connect the 4-pin or 8-pin ATX +12 V power plug; otherwise, the system will not boot up.
- We recommend that you use a PSU with a higher power output when configuring a system with more power consuming devices. The system may become unstable or may not boot up if the power is inadequate.
- You must install a PSU with a higher power rating if you intend to install additional devices.

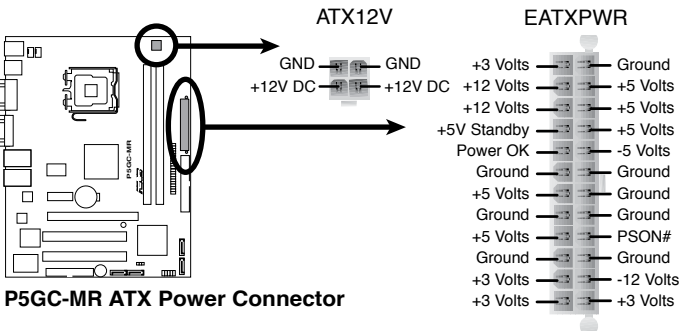

## 7. System panel auxiliary connector (20-pin AUX\_PANEL1)

This connector supports several server system functions.

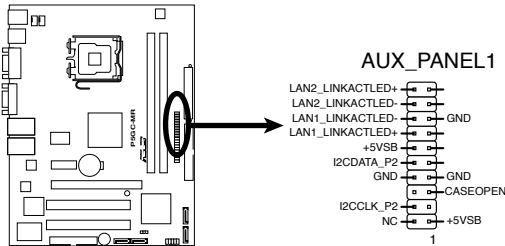

**P5GC-MR Auxiliary Panel Connector**

- **Chassis Intrusion connector (2-pin CASEOPEN)**  
This lead is for a chassis with an intrusion detection feature. This requires an external detection mechanism such as a chassis intrusion sensor or microswitch. When you remove any chassis component, the sensor triggers and sends a high-level signal to this lead to record a chassis intrusion event.
- **LAN1 link activity LED (2-pin LAN1\_LINKACTLED)**  
This 2-pin connector is for the LAN1 Activity LED. Connect the LAN1 Activity LED cable to this connector. This LED blinks during a network activity and is always lit when linked.
- **LAN2 link activity LED (2-pin LAN2\_LINKACTLED)**  
This 2-pin connector is for the LAN2 Activity LED. Connect the LAN2 Activity LED cable to this connector. This LED blinks during a network activity and lights up when linked.
- **Front Panel SMBus (6-1 pin)**  
This connector allows you to connect SMBus (System Management Bus) devices to the system front panel. Devices communicate with an SMBus host and/or other SMBus devices using the SMBus interface.

## 8. System panel connector (20-1 pin FPANEL1)

This connector supports several chassis-mounted functions.

- **System power LED (Green 2-pin PLED)**  
This 2-pin connector is for the system power LED. Connect the chassis power LED cable to this connector. The system power LED lights up when you turn on the system power, and blinks when the system is in sleep mode.
- **Message LED (Brown 2-pin MLED)**  
This connector is for the message LED cable that connects to the front message LED. The message LED indicates the booting status. The LED blinks when the system is in the boot process until the operating system is loaded.
- **Hard disk drive activity LED (Red 2-pin IDE\_LED)**  
This 2-pin connector is for the HDD Activity LED. Connect the HDD Activity LED cable to this connector. The IDE LED lights up or flashes when data is read from or written to the HDD.
- **System warning speaker (Orange 4-pin SPEAKER)**  
This 4-pin connector is for the chassis-mounted system warning speaker. The speaker allows you to hear system beeps and warnings.
- **ATX power button/soft-off button (Light Green 2-pin PWRSW)**  
This connector is for the system power button. Pressing the power button turns the system on or puts the system in sleep or soft-off mode depending on the BIOS settings. Pressing the power switch for more than four seconds while the system is ON turns the system OFF.
- **Reset button (Blue 2-pin RESET)**  
This 2-pin connector is for the chassis-mounted reset button for system reboot without turning off the system power.

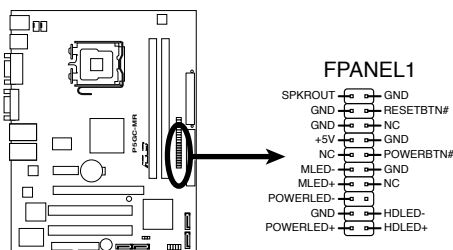

**P5GC-MR System Panel Connector**



The system panel connector is color-coded for easy connection.





This chapter describes the power up sequence, the vocal POST messages, and ways of shutting down the system.

# Powering up **3**

## Chapter summary

# 3

- 3.1 Starting up for the first time..... 3-1
- 3.2 Powering off the computer..... 3-2

## 3.1 Starting up for the first time

1. After making all the connections, replace the system case cover.
2. Be sure that all switches are off.
3. Connect the power cord to the power connector at the back of the system chassis.
4. Connect the power cord to a power outlet that is equipped with a surge protector.
5. Turn on the devices in the following order:
  - a. Monitor
  - b. External SCSI devices (starting with the last device on the chain)
  - c. System power
6. After applying power, the system power LED on the system front panel case lights up. For systems with ATX power supplies, the system LED lights up when you press the ATX power button. If your monitor complies with “green” standards or if it has a “power standby” feature, the monitor LED may light up or switch between orange and green after the system LED turns on.

The system then runs the Power-On Self-Test (POST). While the tests are running, the BIOS beeps or additional messages appear on the screen. If you do not see anything within 30 seconds from the time you turned on the power, the system may have failed a power-on test. Check the jumper settings and connections or call your retailer for assistance.
7. At power on, hold down the <Del> key to enter the BIOS Setup. Follow the instructions in Chapter 4.

### AMI BIOS beep codes

Beep Description	Error
One beep	Keyboard controller error Refresh Time error No master drive detected
Two continuous beeps followed by two short beeps	Floppy controller failure
Two continuous beeps followed by four short beeps	Hardware component failure

## 3.2 Powering off the computer

### 3.2.1 Using the OS shut down function

If you are using Windows® Server 2000:

1. Click the **Start** button then click **Shut Down...**
2. Make sure that the **Shut Down** option button is selected, then click the **OK** button to shut down the computer.
3. The power supply should turn off after Windows® shuts down.

If you are using Windows® Server 2003:

1. Click the **Start** button then select **Turn Off Computer**.
2. Click the **Turn Off** button to shut down the computer.
3. The power supply should turn off after Windows® shuts down

### 3.2.2 Using the dual function power switch

While the system is ON, pressing the power switch for less than four seconds puts the system to sleep mode or to soft-off mode, depending on the BIOS setting. Pressing the power switch for more than four seconds lets the system enter the soft-off mode regardless of the BIOS setting. Refer to section "4.5 Power Menu" in Chapter 4 for details

This chapter tells how to change the system settings through the BIOS Setup menus. Detailed descriptions of the BIOS parameters are also provided.

# BIOS setup 4

- 4.1 Managing and updating your BIOS ..... 4-1**
- 4.2 BIOS setup program ..... 4-10**
- 4.3 Main menu ..... 4-13**
- 4.4 Advanced menu ..... 4-18**
- 4.5 Power Configuration..... 4-27**
- 4.6 Boot menu ..... 4-31**
- 4.7 Exit menu..... 4-36**

## 4.1 Managing and updating your BIOS

The following utilities allow you to manage and update the motherboard Basic Input/Output System (BIOS) setup.

1. **ASUS AFUDOS** (Updates the BIOS in DOS mode using a bootable floppy disk.)
2. **ASUS CrashFree BIOS3** (Updates the BIOS using a bootable floppy disk or USB flash drive when the BIOS file fails or gets corrupted.)
3. **ASUS Update** (Updates the BIOS in Windows® environment.)

Refer to the corresponding sections for details on these utilities.



---

Save a copy of the original motherboard BIOS file to a bootable floppy disk in case you need to restore the BIOS in the future. Copy the original motherboard BIOS using the ASUS Update or AFUDOS utilities.

---

### 4.1.1 Creating a bootable floppy disk

1. Do either one of the following to create a bootable floppy disk.

#### DOS environment

- a. Insert a 1.44MB floppy disk into the drive.
- b. At the DOS prompt, type `format A: /S` then press <Enter>.

#### Windows® XP environment

- a. Insert a 1.44 MB floppy disk to the floppy disk drive.
- b. Click **Start** from the Windows® desktop, then select My Computer.
- c. Select the 3 1/2 Floppy Drive icon.
- d. Click File from the menu, then select Format. A Format 3 1/2 Floppy Disk window appears.
- e. Windows® XP users: Select Create an MS-DOS startup disk from the format options field, then click **Start**.

#### Windows® 2000 environment

To create a set of boot disks for Windows® 2000:

- a. Insert a formatted, high density 1.44 MB floppy disk into the drive.
  - b. Insert the Windows® 2000 CD to the optical drive.
  - c. Click **Start**, then select Run.
  - d. In the Open field, type `D:\bootdisk\makeboot a:` assuming that D is your optical drive letter.
  - e. Press <Enter>, then follow screen instructions to continue.
2. Copy the original or the latest motherboard BIOS file to the bootable floppy disk.

## 4.1.2 AFUDOS utility

The AFUDOS utility allows you to update the BIOS file in DOS environment using a bootable floppy disk with the updated BIOS file. This utility also allows you to copy the current BIOS file that you can use as backup when the BIOS fails or gets corrupted during the updating process.

### Copying the current BIOS

To copy the current BIOS file using the AFUDOS utility:



- Make sure that the floppy disk is not write-protected and has at least 1024 KB free space to save the file.
- The succeeding BIOS screens are for reference only. The actual BIOS screen displays may not be same as shown.

1. Copy the AFUDOS utility (afudos.exe) from the motherboard support CD to the bootable floppy disk you created earlier.
2. Boot the system in DOS mode, then at the prompt type:

```
afudos /o[filename]
```

where the [filename] is any user-assigned filename not more than eight alphanumeric characters for the main filename and three alphanumeric characters for the extension name.

```
A:\>afudos /oOLDBIOS1.rom
```

Main filename      Extension name

3. Press <Enter>. The utility copies the current BIOS file to the floppy disk.

```
A:\>afudos /oOLDBIOS1.rom
AMI Firmware Update Utility - Version 1.19(ASUS V2.07(03.11.24BB))
Copyright (C) 2002 American Megatrends, Inc. All rights reserved.
Reading flash ..... done
Write to file..... ok
A:\>
```

The utility returns to the DOS prompt after copying the current BIOS file.



## Updating the BIOS file

To update the BIOS file using the AFUDOS utility:

1. Visit the ASUS website ([www.asus.com](http://www.asus.com)) and download the latest BIOS file for the motherboard. Save the BIOS file to a bootable floppy disk.



---

Write the BIOS filename on a piece of paper. You need to type the exact BIOS filename at the DOS prompt.

---

2. Copy the AFUDOS utility (afudos.exe) from the motherboard support CD to the bootable floppy disk you created earlier.
3. Boot the system in DOS mode, then at the prompt type:

```
afudos /i[filename]
```

where [filename] is the latest or the original BIOS file on the bootable floppy disk.

```
A:\>afudos /iP5GCMR.ROM
```

4. The utility verifies the file and starts updating the BIOS.

```
A:\>afudos /iP5GCMR.ROM
AMI Firmware Update Utility - Version 1.19(ASUS V2.07(03.11.24BB))
Copyright (C) 2002 American Megatrends, Inc. All rights reserved.

WARNING!! Do not turn off power during flash BIOS
Reading file ..... done
Reading flash ..... done

Advance Check .....
Erasing flash ..... done
Writing flash ..... 0x0008CC00 (9%)
```



---

Do not shut down or reset the system while updating the BIOS to prevent system boot failure!

---

5. The utility returns to the DOS prompt after the BIOS update process is completed. Reboot the system from the hard disk drive.

```
A:\>afudos /iP5GCMR.ROM
AMI Firmware Update Utility - Version 1.19(ASUS V2.07(03.11.24BB))
Copyright (C) 2002 American Megatrends, Inc. All rights reserved.

WARNING!! Do not turn off power during flash BIOS
Reading file ..... done
Reading flash ..... done

Advance Check .....
Erasing flash ..... done
Writing flash ..... done
Verifying flash .... done

Please restart your computer

A:\>
```

### 4.1.3 ASUS CrashFree BIOS 3 utility

The ASUS CrashFree BIOS 3 is an auto recovery tool that allows you to restore the BIOS file when it fails or gets corrupted during the updating process. You can update a corrupted BIOS file using the USB flash drive or the floppy disk that contains the updated BIOS file.



- 
- Prepare the USB flash drive or the floppy disk containing the updated motherboard BIOS before using this utility.
  - Make sure that you rename the original or updated BIOS file to "P5GCMR.rom".
- 

### Recovering the BIOS from a floppy disk

To recover the BIOS from a floppy disk:

1. Turn on the system.
2. Insert the floppy disk with the original or updated BIOS file to the floppy disk drive.
3. The utility will automatically recover the BIOS. It will reset the system when the process finished.

## Recovering the BIOS from the USB flash drive

To recover the BIOS from the USB flash drive:

1. Remove any floppy disk from the floppy disk drive, then turn on the system.
2. Insert the USB flash drive with the original or updated BIOS file to one USB port.
3. The utility will automatically recover the BIOS. It will reset the system when the process finished.



---

The recovered BIOS may not be the latest BIOS version for this motherboard. Visit the ASUS website ([www.asus.com](http://www.asus.com)) to download the latest BIOS file.

---

#### 4.1.4 ASUS Update utility

The ASUS Update is a utility that allows you to manage, save, and update the motherboard BIOS in Windows® environment. The ASUS Update utility allows you to:

- Save the current BIOS file
- Download the latest BIOS file from the Internet
- Update the BIOS from an updated BIOS file
- Update the BIOS directly from the Internet, and
- View the BIOS version information.

This utility is available in the support CD that comes with the motherboard package.



---

ASUS Update requires an Internet connection either through a network or an Internet Service Provider (ISP).

---

#### Installing ASUS Update

To install ASUS Update:

1. Place the support CD in the optical drive. The **Drivers** menu appears.
2. Click the **Utilities** tab, then click **Install ASUS Update VX.XX.XX**.
3. The ASUS Update utility is copied to your system.



---

Quit all Microsoft® Windows® applications before you update the BIOS using this utility.

---

## Updating the BIOS through the Internet

To update the BIOS through the Internet:

1. Launch the ASUS Update utility from the Windows® desktop by clicking **Start > Programs > ASUS > ASUSUpdate > ASUSUpdate**. The ASUS Update main window appears.

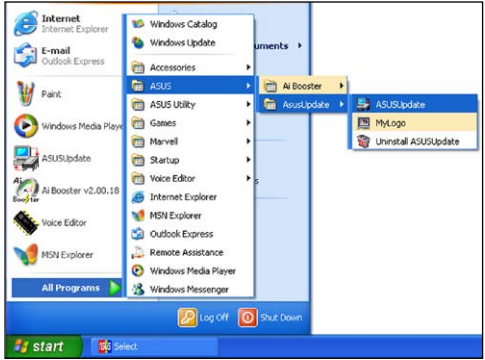

2. Select **Update BIOS from the Internet** option from the drop-down menu, then click **Next**.
3. Select the ASUS FTP site nearest you to avoid network traffic, or click **Auto Select**. Click **Next**.

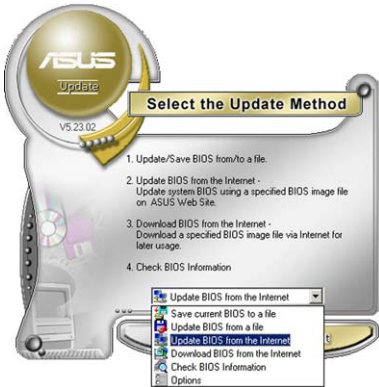

- From the FTP site, select the BIOS version that you wish to download. Click **Next**.
- Follow the screen instructions to complete the update process.



The ASUS Update utility is capable of updating itself through the Internet. Always update the utility to avail all its features.



## Updating the BIOS through a BIOS file

To update the BIOS through a BIOS file:

- Launch the ASUS Update utility from the Windows® desktop by clicking **Start > Programs > ASUS > ASUSUpdate > ASUSUpdate**. The ASUS Update main window appears.
- Select **Update BIOS from a file** option from the drop-down menu, then click **Next**.

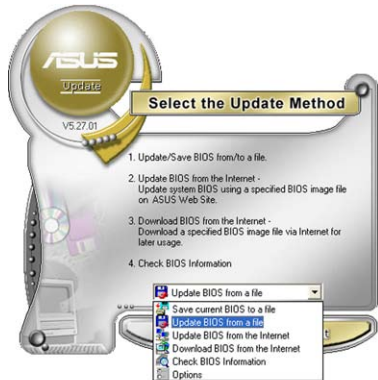

- Locate the BIOS file from the **Open** window, then click **Save**.
- Follow the screen instructions to complete the update process.

## 4.2 BIOS setup program

This motherboard supports a programmable firmware chip that you can update using the provided utility described in section “4.1 Managing and updating your BIOS”.

Use the BIOS Setup program when you are installing a motherboard, reconfiguring your system, or prompted to “Run Setup”. This section explains how to configure your system using this utility.

Even if you are not prompted to use the Setup program, you can change the configuration of your computer in the future. For example, you can enable the security password feature or change the power management settings. This requires you to reconfigure your system using the BIOS Setup program so that the computer can recognize these changes and record them in the CMOS RAM of the firmware hub.

The firmware hub on the motherboard stores the Setup utility. When you start up the computer, the system provides you with the opportunity to run this program. Press <Delete> during the Power-On Self-Test (POST) to enter the Setup utility; otherwise, POST continues with its test routines.

If you wish to enter Setup after POST, restart the system by pressing <Ctrl> + <Alt> + <Delete>, or by pressing the reset button on the system chassis. You can also restart by turning the system off and then back on. Do this last option only if the first two failed.

The Setup program is designed to make it as easy to use as possible. Being a menu-driven program, it lets you scroll through the various sub-menus and make your selections from the available options using the navigation keys.



- 
- The default BIOS settings for this motherboard apply for most conditions to ensure optimum performance. If the system becomes unstable after changing any BIOS settings, load the default settings to ensure system compatibility and stability. Select the **Load Setup Defaults** item under the Exit Menu. See section “4.7 Exit Menu.”
  - The BIOS setup screens shown in this section are for reference purposes only, and may not exactly match what you see on your screen.
  - Visit the ASUS website ([www.asus.com](http://www.asus.com)) to download the latest BIOS file for this motherboard.
-



## 4.2.1 BIOS menu screen

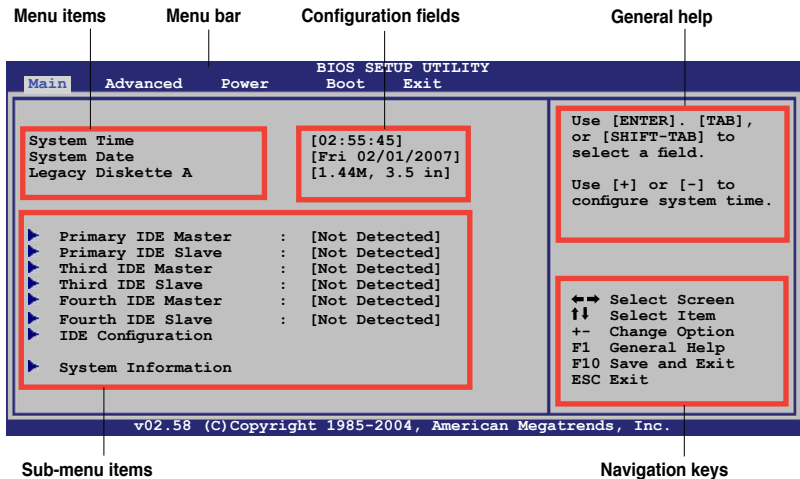

## 4.2.2 Menu bar

The menu bar on top of the screen has the following main items:

- Main** For changing the basic system configuration
- Advanced** For changing the advanced system settings
- Power** For changing the Advanced Power Management (APM) configuration
- Boot** For changing the system boot configuration
- Exit** For selecting the exit options and loading default settings

To select an item on the menu bar, press the right or left arrow key on the keyboard until the desired item is highlighted.

## 4.2.3 Navigation keys

At the bottom right corner of a menu screen are the navigation keys for that particular menu. Use the navigation keys to select items in the menu and change the settings.



Some of the navigation keys differ from one screen to another.

## 4.2.4 Menu items

The highlighted item on the menu bar displays the specific items for that menu. For example, selecting **Main** shows the Main menu items.

The other items (Advanced, Power, Boot, and Exit) on the menu bar have their respective menu items.

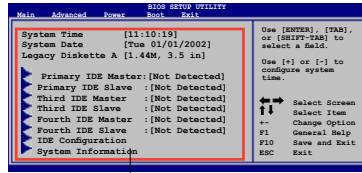

Main menu items

## 4.2.5 Sub-menu items

A solid triangle before each item on any menu screen means that the item has a sub-menu. To display the sub-menu, select the item and press <Enter>.

## 4.2.6 Configuration fields

These fields show the values for the menu items. If an item is user-configurable, you can change the value of the field opposite the item. You cannot select an item that is not user-configurable.

A configurable field is enclosed in brackets, and is highlighted when selected. To change the value of a field, select it then press <Enter> to display a list of options. Refer to “4.2.7 Pop-up window.”

## 4.2.7 Pop-up window

Select a menu item then press <Enter> to display a pop-up window with the configuration options for that item.

## 4.2.8 Scroll bar

A scroll bar appears on the right side of a menu screen when there are items that do not fit on the screen. Press the Up/Down arrow keys or <Page Up> /<Page Down> keys to display the other items on the screen.

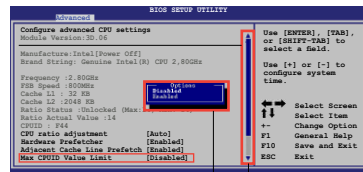

Pop-up window

Scroll bar

## 4.2.9 General help

At the top right corner of the menu screen is a brief description of the selected item.

## 4.3 Main menu

When you enter the BIOS Setup program, the **Main** menu screen appears, giving you an overview of the basic system information.



Refer to section “4.2.1 BIOS menu screen” for information on the menu screen items and how to navigate through them.

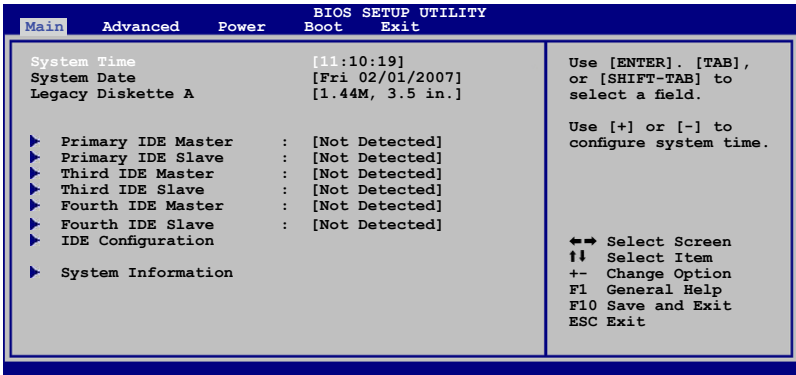

### 4.3.1 System Time [xx:xx:xx]

Allows you to set the system time.

### 4.3.2 System Date [Day xx/xx/xxxx]

Allows you to set the system date.

### 4.3.3 Legacy Diskette A [1.44M, 3.5 in.]

Sets the type of floppy drive installed. Configuration options: [Disabled] [360K, 5.25 in.] [1.2M , 5.25 in.] [720K , 3.5 in.] [1.44M, 3.5 in.] [2.88M, 3.5 in.]

### 4.3.4 Primary, Third, Fourth IDE Master/Slave

The BIOS automatically detects the connected IDE devices. There is a separate sub-menu for each IDE device. Select a device item, then press <Enter> to display the IDE device information.

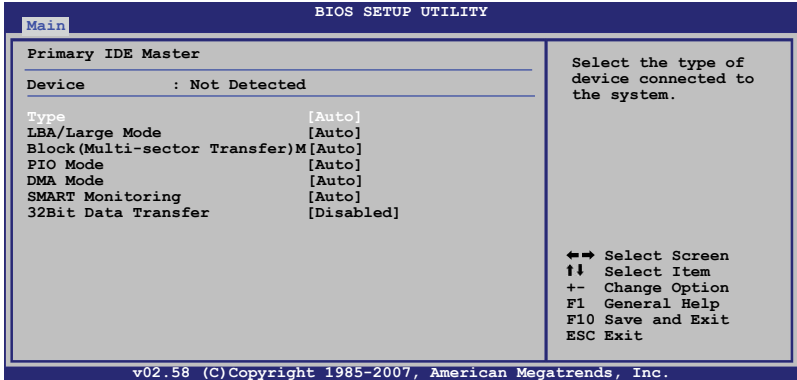

The BIOS automatically detects the values opposite the dimmed items (Device, Vendor, Size, LBA Mode, Block Mode, PIO Mode, Async DMA, Ultra DMA, and SMART monitoring). These values are not user-configurable. These items show N/A if no IDE device is installed in the system.

#### Type [Auto]

Selects the type of IDE drive. Setting to [Auto] allows automatic selection of the appropriate IDE device type. Select [CDROM] if you are specifically configuring a CD-ROM drive. Select [ARMD] (ATAPI Removable Media Device) if your device is either a ZIP, LS-120, or MO drive.

Configuration options: [Not Installed] [Auto] [CDROM] [ARMD]

#### LBA/Large Mode [Auto]

Enables or disables the LBA mode. Setting to [Auto] enables the LBA mode if the device supports this mode, and if the device was not previously formatted with LBA mode disabled. Configuration options: [Disabled] [Auto]

#### Block (Multi-sector Transfer) [Auto]

Enables or disables data multi-sectors transfers. When set to [Auto], the data transfer from and to the device occurs multiple sectors at a time if the device supports multi-sector transfer feature. When set to [Disabled], the data transfer from and to the device occurs one sector at a time. Configuration options:

[Disabled] [Auto]

### **PIO Mode [Auto]**

Selects the PIO mode. Configuration options: [Auto] [0] [1] [2] [3] [4]

### **DMA Mode [Auto]**

Selects the DMA mode. Configuration options: [Auto]

### **SMART Monitoring [Auto]**

Sets the Smart Monitoring, Analysis, and Reporting Technology.  
Configuration options: [Auto] [Disabled] [Enabled]

### **32Bit Data Transfer [Disabled]**

Enables or disables 32-bit data transfer. Configuration options: [Disabled] [Enabled]

## **4.3.5 IDE Configuration**

The items in this menu allow you to set or change the configurations for the IDE devices installed in the system. Select an item then press <Enter> if you wish to configure the item.

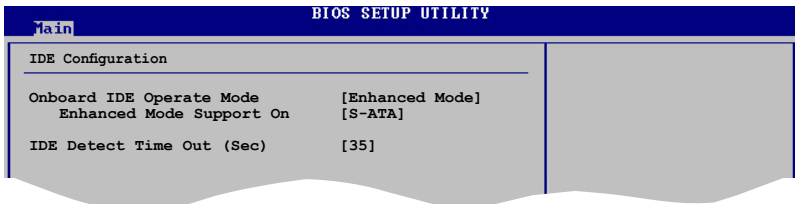

### **Onboard IDE Operate Mode [Enhanced Mode]**

Disables or allows selection of the IDE operation mode depending on the operating system (OS) that you installed. Set to Enhanced Mode if you are using native OS, such as Windows® 2000/XP/Vista.

Configuration options: [Disabled] [Compatible Mode] [Enhanced Mode]

### Enhanced Mode Support On [S-ATA]

The default setting S-ATA allows you to use native OS on Serial ATA and Parallel ATA ports. We recommend that you do not change the default setting for better OS compatibility. In this setting, you may use legacy OS, such as Windows® ME/98/NT and MS-DOS on the Parallel ATA ports only if you did not install any Serial ATA device.

The P-ATA+S-ATA and P-ATA options are for advanced users only. If you set to any of these options and encounter problems, revert to the default setting S-ATA. Configuration options: [S-ATA+P-ATA] [S-ATA] [P-ATA]

## **IDE Detect Time Out (Sec) [35]**

Selects the time out value for detecting ATA/ATAPI devices.

Configuration options: [0] [5] [10] [15] [20] [25] [30] [35]

## **4.3.6 System Information**

This menu gives you an overview of the general system specifications. The BIOS automatically detects the items in this menu.

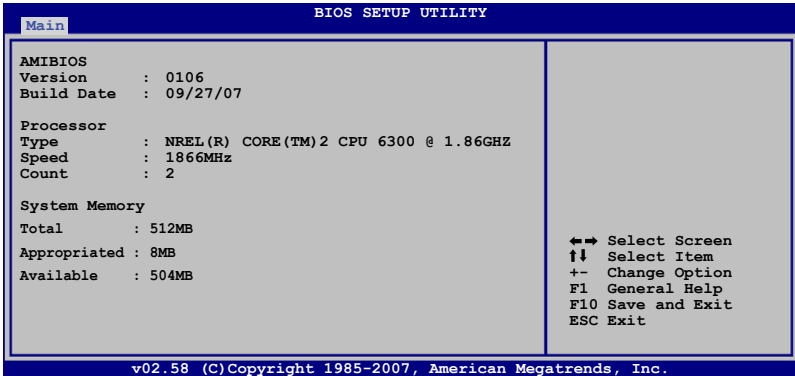

### **AMI BIOS**

Displays the auto-detected BIOS information.

### **Processor**

Displays the auto-detected CPU specification.

### **System Memory**

Displays the auto-detected total system memory.

## 4.4 Advanced menu

The Advanced menu items allow you to change the settings for the CPU and other system devices.



Take caution when changing the settings of the Advanced menu items. Incorrect field values can cause the system to malfunction.

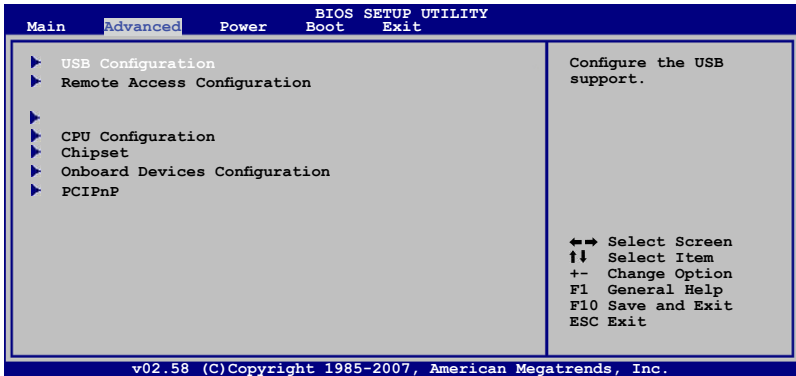

### 4.4.1 USB Configuration

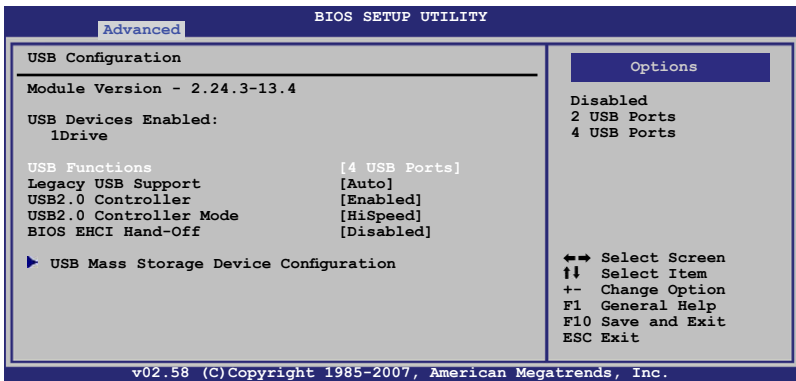

#### USB Function [4 USB Ports]

Allows you to enable a specific number of USB ports, or disable the USB function.

Configuration options: [Disabled] [2 USB Ports] [4 USB Ports]



When USB Function set to [2 USB Ports] [4 USB Ports] the following items appear.

#### *Legacy USB Support [Auto]*

Allows you to enable or disable support for legacy USB. The AUTO option disables legacy support if there is no USB device connected.

Configuration options: [Disabled] [Enabled] [Auto]

#### *USB 2.0 Controller [Enabled]*

Allows you to enable or disable the USB 2.0 controller.

Configuration options: [Enabled] [Disabled]

#### *USB2.0 Controller mode [HiSpeed]*

Allows you to select the USB2.0 controller mode.

Configuration options: [FullSpeed] [HiSpeed]

### **BIOS EHCI Hand-Off [Enabled]**

Allows you to enable or disable the BIOS EHCI Hand-Off support function.

Configuration options: [Disabled] [Enabled]

### **USB Mass Storage Device Configuration**

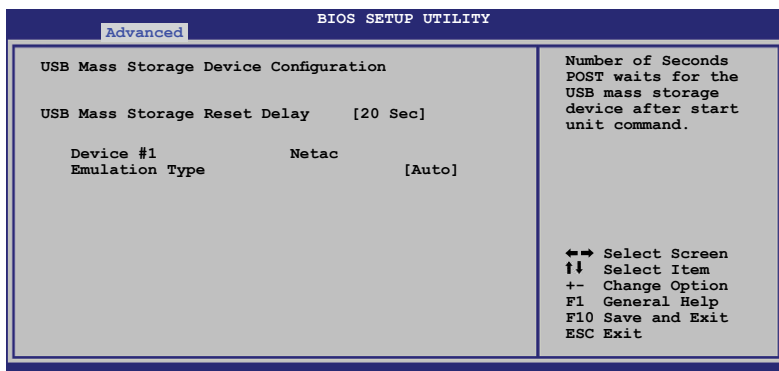

### **USB Mass Storage Reset Delay [20 Sec]**

Allows you to set the time that POST waits for the USB mass storage device after starting unit command. Configuration options: [10 Sec] [20 Sec] [30 Sec] [40 Sec]

### **Emulation Type [Auto]**

Allows you to select device emulation type. If set to Auto, the part of less than 530MB of USB devices is emulated as floppy disk, and the rest part is emulated as hard disk. Configuration options: [Auto] [Floppy] [Forced FDD] [Hard Disk] [CDROM]



## 4.4.2 Remote Access Configuration

The items in this menu allows you to configure the Remote Access features. Select an item then press <Enter> to display the configuration options.

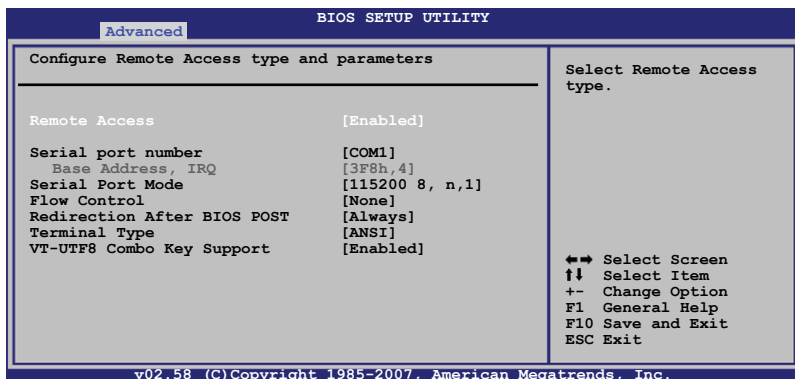

### Remote Access [Enabled]

Enables or disables the remote access feature.

Configuration options: [Disabled] [Enabled]



The following items appear only when the **Remote Access** item is set to [Enabled].

### Serial port number [COM1]

Allows you to select a serial port for console redirection.

Configuration options: [COM1]

### Serial Port Mode [115200 8, n, 1]

Allows you to select a serial port mode. Configuration options: [115200 8, n, 1] [57600 8, n, 1] [38400 8, n, 1] [19200 8, n, 1] [09600 8, n, 1]

### Flow Control [None]

Allows you to set the flow control for console redirection.

Configuration options: [None] [Hardware] [Software]

### Redirection After BIOS POST [Always]

Sets the redirection mode after the BIOS Power-On Self-Test (POST). Some operating systems may not work when this item is set to Always.

Configuration options: [Disabled] [Boot Loader] [Always]

## Terminal Type [ANSI]

Allows you to select the target terminal type. Configuration options: [ANSI] [VT100] [VT-UTF8]

## VT-UTF8 Combo Key Support [Enabled]

Allows you to enable or disable VT-UTF8 Combination Key Support for ANSI/VT100 terminals. Configuration options: [Enabled] [Disabled]

### 4.4.3 CPU Configuration

The items in this menu show the CPU-related information that the BIOS automatically detects.

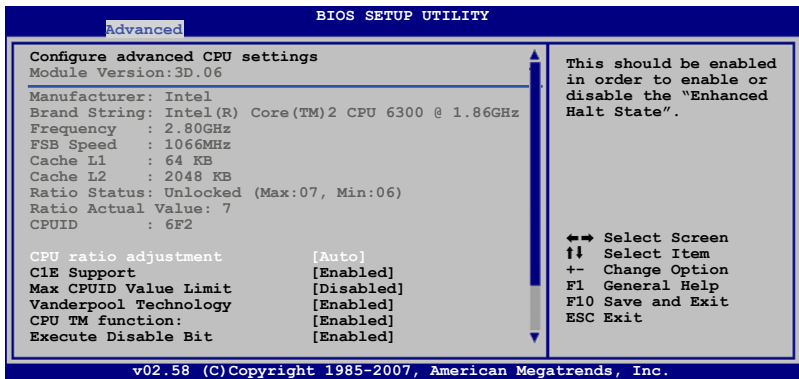

Use the arrow down key to display additional items.

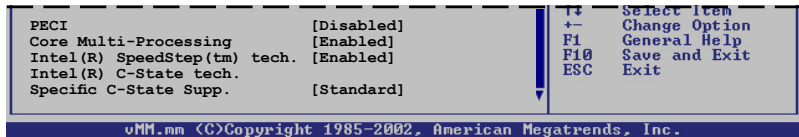

## CPU ratio adjustment [Auto]

Selects the CPU ratio adjustment mode. Configuration options: [Auto] [Manual]

The following items appear only when the **CPU ratio adjustment** item is set to [manual].

### *Ratio CMOS Setting [14]*

Sets the ratio between the CPU core clock and the Front Side Bus frequency. The BIOS auto detects the default value of this item. Use the <+> or <-> keys to adjust the values. Configuration options:[6]...[14]

You can only adjust the **CPU ratio adjustment** if you installed an unlocked CPU. Refer to the CPU documentation for details.

## C1E Support [Enabled]

Allows you to enable or disable the C1E support. Configuration options: [Disable] [Enable]



---

This item should be enabled in order to enable or disable the ‘Enhanced Halt State’.

---

## Max CPUID Value Limit [Disabled]

Setting this item to [Enabled] allows legacy operating systems to boot even without support for CPUs with extended CPUID functions.

Configuration options: [Disabled] [Enabled]

## Vanderpool Technology [Enabled]

When enabled and CPU support this function, this function will work.

Configuration options: [Disabled] [Enabled]

## CPU TM function: [Enabled]

When enabled and CPU support this function, this function will work.

Configuration options: [Disabled] [Enabled]

## Execute Disable Bit [Disabled]

When disabled, forces the XD feature flag to always return to 0.

Configuration options: [Disabled] [Enabled]



---

The following item appears only when you install an Intel® Core 2 Due (E6000, E4000) series processor.

---

## PECI [Disabled]

Allows you to enable or disable PECI interface.

## Core Multi-Processing [Enabled]

Allows you to enable or disable one execution core.

Configuration options: [Disabled] [Enabled]



---

The following item appears only when the CPU installed supports the C-State technology.

---

## Intel C-state tech.

### Specific C-State Supp. [Standard]

When set to [Standard], it runs in the conventional C-State. When set to [Enhanced], it runs in the enhanced C-State. Configuration options: [Disabled]

## 4.4.4 Chipset

The Chipset menu allows you to change the advanced chipset settings. Select an item then press <Enter> to display the sub-menu.

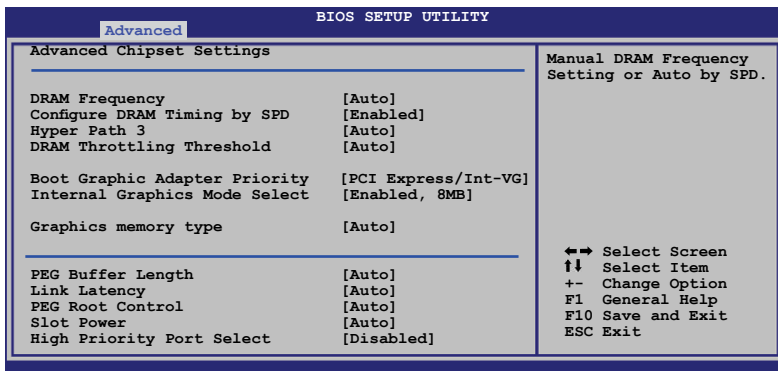

### DRAM Frequency [Auto]

When Configure DRAM Timing by SPD is enabled, you are not allowed change the setting of this item. The motherboard automatically sets the DDR operating frequency according to the DRAM SPD. When Configure DRAM Timing by SPD is disabled, this items allows you to set the DDR operating frequency manually. Configuration options: [Auto] [533 MHz] [667 MHz]

### Configure DRAM Timing by SPD [Enabled]

When this item is enabled, the DRAM timing parameters are set according to the DRAM SPD (Serial Presence Detect). When disabled, you can manually set the DRAM timing parameters through the DRAM sub-items. The following sub-items appear when this item is disabled. Configuration options: [Disabled] [Enabled]

#### DRAM CAS# Latency [5]

Controls the latency between the SDRAM read command and the time the data actually becomes available. Configuration options: [3] [4] [5] [6]

#### DRAM RAS# to CAS# Delay [6 DRAM Clocks]

Controls the latency between the DDR SDRAM active command and the read/write command. Configuration options: [3 DRAM Clocks] [4 DRAM Clocks] [5 DRAM Clocks] [6 DRAM Clocks]

DRAM RAS# Precharge [6 DRAM Clocks]

Controls the idle clocks after issuing a precharge command to the DDR SDRAM. Configuration options: [3 DRAM Clocks] [4 DRAM Clocks] [5 DRAM Clocks] [6 DRAM Clocks]

DRAM RAS# Activate to Precharge Delay [15 DRAM Clocks]

Configuration options: [9 DRAM Clocks] [10 DRAM Clocks] ~ [15 DRAM Clocks]

DRAM Write Recovery Time [4 clocks]

Configuration options: [2 Clocks] [3 Clocks] [4 Clocks] [5 Clocks] [6 Clocks]

### **Hyper Path 3 [Auto]**

Sets this item to enabled to reduce bottlenecks of memory bandwidth. Sets it to disabled for safe mode. Configuration options: [Disabled] [Enabled] [Auto]

### **DRAM Throttling Threshold [Auto]**

Allows you to enable DRAM Thermal Throttling to make your system more stable. Configuration options: [Disabled] [Auto]

### **Boot Graphic Adapter Priority [PCI Express/Int-VGA]**

Allows selection of the graphics controller to use as primary boot device.

Configuration options: [Internal VGA] [PCI Express/Int-VGA] [PCI Express/PCI] [PCI/PCI Express] [PCI/Int-VGA]

### **Internal Graphics Mode Select [Enabled, 8MB]**

Sets the internal graphics mode.

Configuration options: [Disabled] [Enabled, 1MB] [Enabled, 8MB]

### **Graphics memory type [Auto]**

Sets the graphics memory type.

Configuration options: [Auto] [DVMT] [DVMT+FIX]

DVMT/DVMT+FIX Memory [56MB]

Configuration options: [56MB] [120MB] [216]

### **PEG Buffer Length [Auto]**

Sets PCIEX graphics card buffer length. Configuration options: [Auto] [Long] [Short]

### **Link Latency [Auto]**

Sets link latency. Configuration options: [Auto] [Slow] [Normal]

### **PEG Root Control [Auto]**

Enables, disables or set to Auto of the link latency.

Configuration options: [Auto] [Disabled] [Enabled]

**Slot Power [Auto]**

Sets the slot power. Configuration options: [Auto] [Light] [Normal] [Heavy] [Heavier]

**High Priority Port Select [Disabled]**

Selects the high priority port. Configuration options: [Disabled]  
[PCI Express Port 2] [PCI Express Port 3]

## 4.4.4 Onboard Devices Configuration

The Onboard Devices Configuration menu allows you to change the onboard devices settings. Select an item then press <Enter> to display the sub-menu.

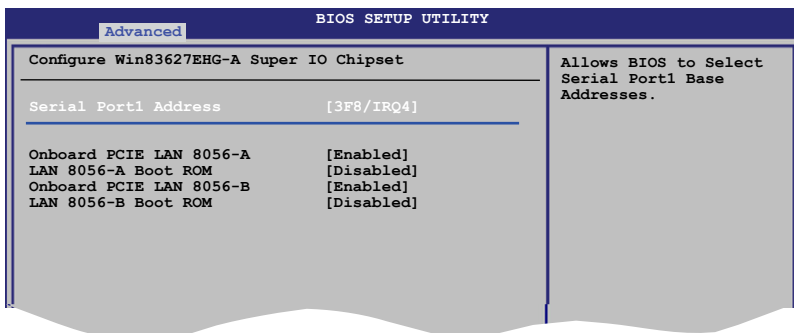

### Serial Port1 Address [3F8/IRQ4]

Allows you to select the Serial Port1 base address.

Configuration options: [Disabled] [3F8/IRQ4] [2F8/IRQ3] [3E8/IRQ4] [2E8/IRQ3]

### Onboard PCIE LAN 8056-A/ LAN 8056-B [Enabled]

Allows you to enable LAN 8056-A/8056-B. Configuration options: [Disabled] [Enabled]

### LAN 8056-A/ LAN 8056-B Boot ROM [Disabled]

Allows you to Configure LAN 8056-A/8056-B Boot ROM.

Configuration options: [Disabled] [Enabled]

## 4.4.5 PCI PnP

The PCI PnP menu items allow you to change the advanced settings for PCI/PnP devices. The menu includes setting IRQ and DMA channel resources for either PCI/PnP or legacy ISA devices, and setting the memory size block for legacy ISA devices.



Take caution when changing the settings of the PCI PnP menu items. Incorrect field values can cause the system to malfunction.

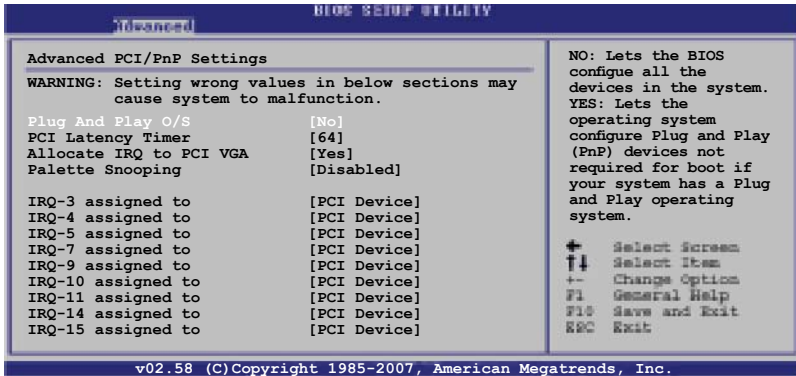

### Plug And Play O/S [No]

When set to [No], BIOS configures all the devices in the system. When set to [Yes] and if you install a Plug and Play operating system, the operating system configures the Plug and Play devices not required for boot.

Configuration options: [No] [Yes]

### PCI Latency Timer [64]

Allows you to select the value in units of PCI clocks for the PCI device latency timer register. Configuration options: [32] [64] [96] [128] [160] [192] [224] [248]

### Allocate IRQ to PCI VGA [Yes]

When set to [Yes], BIOS assigns an IRQ to PCI VGA card if the card requests for an IRQ. When set to [No], BIOS does not assign an IRQ to the PCI VGA card even if requested. Configuration options: [No] [Yes]

### Palette Snooping [Disabled]

When set to [Enabled], the palette snooping feature informs the PCI devices that an ISA graphics device is installed in the system so that the latter can function correctly. Configuration options: [Disabled] [Enabled]



## IRQ-xx assigned to [PCI Device]

When set to [PCI Device], the specific IRQ is free for use of PCI/PnP devices.  
When set to [Reserved], the IRQ is reserved for legacy ISA devices.  
Configuration options: [PCI Device] [Reserved]

## 4.5 Power Configuration

The Power Configuration menu items allow you to change the settings for the ACPI and Advanced Power Management (APM) features. Select an item then press <Enter> to display the configuration options.

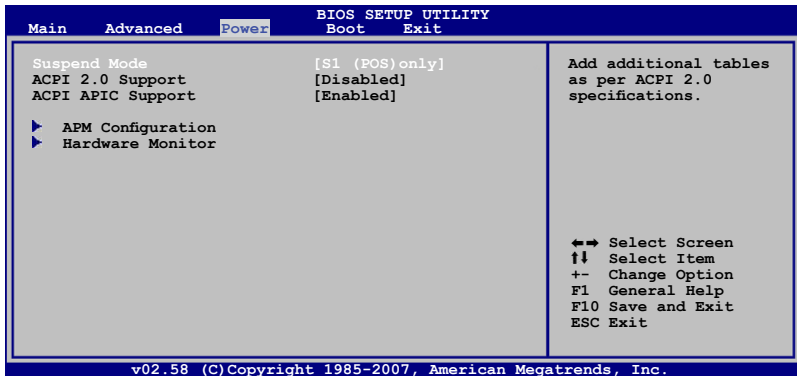

### Suspend Mode [S1 (POS) Only]

Allows you to select the Advanced Configuration and Power Interface (ACPI) state to be used for system suspend.  
Configuration options: [S1 (POS) Only]

### ACPI 2.0 Support [Disabled]

Allows you to enable or disable the Advanced Configuration and Power Interface (ACPI) 2.0 Support. Configuration options: [Disabled] [Enabled]

### ACPI APIC Support [Enabled]

Allows you to enable or disable the Advanced Configuration and Power Interface (ACPI) support in the Advanced Programmable Interrupt Controller (APIC). When set to Enabled, the ACPI APIC table pointer is included in the RSDT pointer list.  
Configuration options: [Disabled] [Enabled]

## 4.5.1 APM Configuration

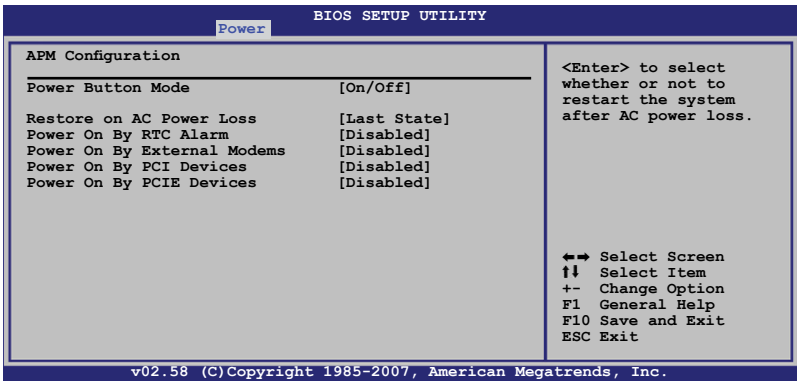

### Power Button Mode [On/Off]

Allows the system to go into On/Off mode or suspend mode when the power button is pressed. Configuration options: [On/Off] [Suspend]

### Restore on AC Power Loss [Last State]

When set to Power Off, the system goes into off state after an AC power loss. When set to Power On, the system goes on after an AC power loss. When set to Last State, the system goes into either off or on state, whatever the system state was before the AC power loss.

Configuration options: [Power Off] [Power On] [Last State]

### Power On By RTC Alarm [Disabled]

Allows you to enable or disable RTC to generate a wake event. When this item is set to Enabled, the items RTC Alarm Date, RTC Alarm Hour, RTC Alarm Minute, and RTC Alarm Second appear with set values. Configuration options: [Disabled] [Enabled]

### Power On By External Modems [Disabled]

This allows either settings of [Enabled] or [Disabled] for powering up the computer when the external modem receives a call while the computer is in Soft-off mode.

Configuration options: [Disabled] [Enabled]



The computer cannot receive or transmit data until the computer and applications are fully running. Thus, connection cannot be made on the first try. Turning an external modem off and then back on while the computer is off causes an initialization string that turns the system power on.

## Power On By PCI Devices [Disabled]

When set to [Enabled], this parameter allows you to turn on the system through a PCI LAN or modem card. This feature requires an ATX power supply that provides at least 1A on the +5VSB lead.

Configuration options: [Disabled] [Enabled]

## Power On By PCIE Devices [Disabled]

When set to [Enabled], this parameter allows you to turn on the system through a PCI Express LAN card. This feature requires an ATX power supply that provides at least 1A on the +5VSB lead.

Configuration options: [Disabled] [Enabled]

## 4.5.2 Hardware Monitor

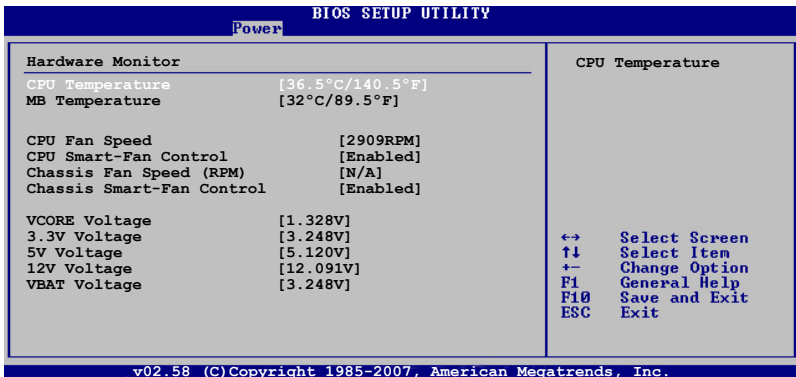

### CPU Temperature [xxx°C/xxx°F]

### MB Temperature [xxx°C/xxx°F]

The onboard hardware monitor automatically detects and displays the motherboard and CPU temperatures. Select [Ignored] if you do not wish to display the detected temperatures.

### CPU Fan Speed [xxxxRPM] or [N/A] or [Ignored]

The onboard hardware monitor automatically detects and displays the CPU fan speed in rotations per minute (RPM). If the fan is not connected to the motherboard, the field shows N/A.

Configuration options: [Ignored] [xxxRPM]

### CPU Smart-Fan Control [Enabled]

Allows you to enable or disable the ASUS Smart-Fan feature that smartly adjusts the fan speeds for more efficient system operation.

Configuration options: [Disabled] [Enabled]

### Chassis Fan Speed(RPM) [xxxx] or [N/A] or [Ignored]

The onboard hardware monitor automatically detects and displays the chassis fan speed in rotations per minute (RPM). If the fan is not connected to the chassis, the specific field shows N/A.

Configuration options: [Ignored] [N/A]

### Chassis Smart-Fan Control [Enabled]

Allows you to enable or disable the ASUS Smart-Fan feature that smartly adjusts the fan speeds for more efficient system operation.

Configuration options: [Disabled] [Enabled]

### VCORE Voltage, 3.3V Voltage, 5V Voltage, 12V Voltage

The onboard hardware monitor automatically detects the voltage output through the onboard voltage regulators.

## 4.6 Boot menu

The Boot menu items allow you to change the system boot options. Select an item then press <Enter> to display the sub-menu.

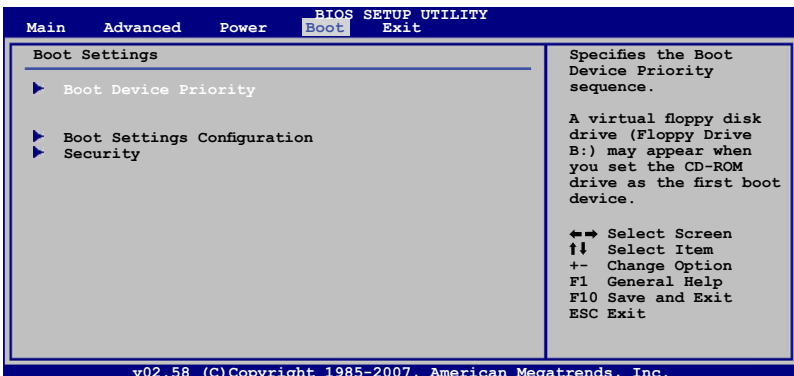

## 4.6.1 Boot Device Priority

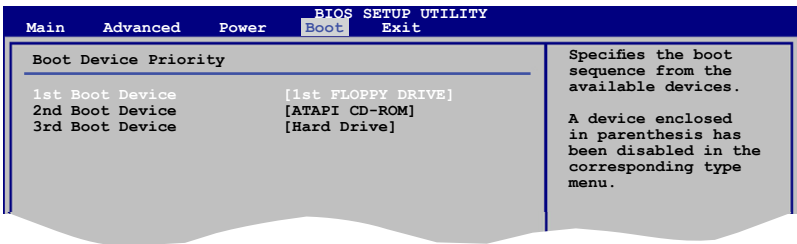

**1st Boot Device [1st FLOPPY DRIVE]**

**2nd Boot Device [ATAPI CD-ROM]**

**3rd Boot Device [Hard Drive]**

These items specify the boot device priority sequence from the available devices. Configuration options: [1st FLOPPY DRIVE] [ATAPI CD-ROM] [Hard Drive] [Disabled]

## 4.6.2 Boot Settings Configuration

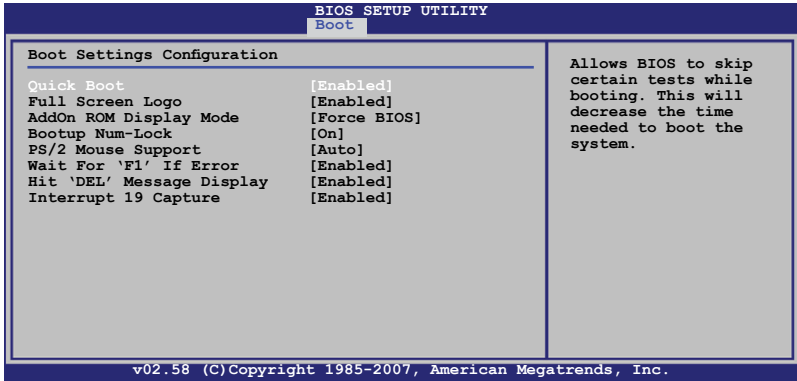

### Quick Boot [Enabled]

Enabling this item allows the BIOS to skip some power on self tests (POST) while booting to decrease the time needed to boot the system. When set to [Disabled], BIOS performs all the POST items.

Configuration options: [Disabled] [Enabled]

### Full Screen Logo [Enabled]

Allows you to enable or disable the full screen logo display feature. Configuration options: [Disabled] [Enabled]



Set this item to [Enabled] to use the ASUS MyLogo2™ feature.

### AddOn ROM Display Mode [Force BIOS]

Allows you to set display mode for optional ROM. Configuration options: [Force BIOS] [Keep Current]

### Bootup Num-Lock [On]

Allows you to select the power-on state for the NumLock.

Configuration options: [Off] [On]

### PS/2 Mouse Support [Auto]

Allows you to enable or disable support for PS/2 mouse.

Configuration options: [Disabled] [Auto]

### Wait for 'F1' If Error [Enabled]

When set to Enabled, the system waits for the F1 key to be pressed when error occurs. Configuration options: [Disabled] [Enabled]

## Hit 'DEL' Message Display [Enabled]

When set to Enabled, the system displays the message "Press DEL to run Setup" during POST. Configuration options: [Disabled] [Enabled]

## Interrupt 19 Capture [Enabled]

When set to [Enabled], this function allows the option ROMs to trap Interrupt 19. Configuration options: [Disabled] [Enabled]

### 4.6.3 Security

The Security menu items allow you to change the system security settings. Select an item then press <Enter> to display the configuration options.

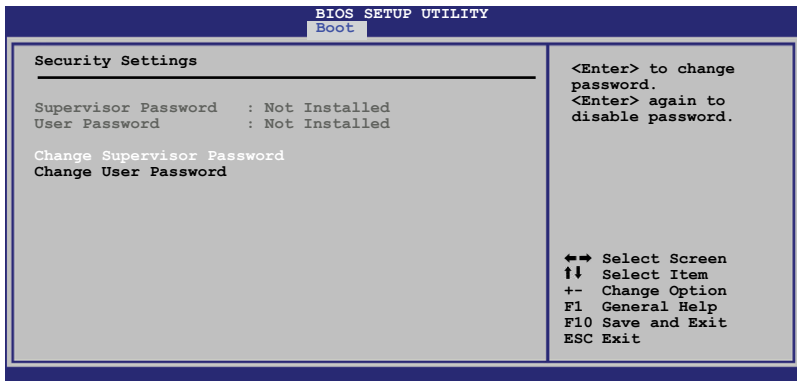

#### Change Supervisor Password

Select this item to set or change the supervisor password. The Supervisor Password item on top of the screen shows the default **Not Installed**. After you set a password, this item shows **Installed**.

To set a Supervisor Password:

1. Select the **Change Supervisor Password** item, then press <Enter>.
2. From the password box, type a password composed of at least six letters and/or numbers, then press <Enter>.
3. Confirm the password when prompted.

The message "Password Installed" appears after you successfully set your password.

To change the supervisor password, follow the same steps as in setting a user password.

To clear the supervisor password, select the **Change Supervisor Password** then press <Enter>. The message “Password Uninstalled” appears.



If you forget your BIOS password, you can clear it by erasing the CMOS Real Time Clock (RTC) RAM. See section “2.6 Jumpers” for information on how to erase the RTC RAM.

After you have set a supervisor password, the other items appear to allow you to change other security settings.

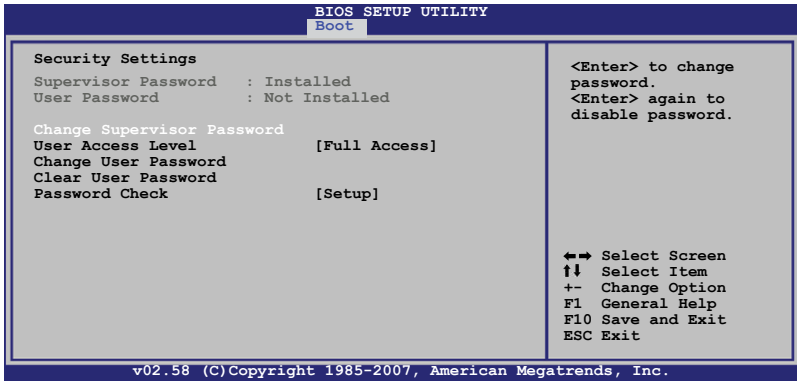

### User Access Level [Full Access]

This item allows you to select the access restriction to the Setup items. Configuration options: [No Access] [View Only] [Limited] [Full Access]

**No Access** prevents user access to the Setup utility.

**View Only** allows access but does not allow change to any field.

**Limited** allows changes only to selected fields, such as Date and Time.

**Full Access** allows viewing and changing all the fields in the Setup utility.

### Change User Password

Select this item to set or change the user password. The User Password item on top of the screen shows the default **Not Installed**. After you set a password, this item shows **Installed**.

To set a User Password:

1. Select the **Change User Password** item and press <Enter>.



2. On the password box that appears, type a password composed of at least six letters and/or numbers, then press <Enter>.
3. Confirm the password when prompted.

The message "Password Installed" appears after you set your password successfully.

To change the user password, follow the same steps as in setting a user password.

### **Clear User Password**

Select this item to clear the user password.

### **Password Check [Setup]**

When set to [Setup], BIOS checks for user password when accessing the Setup utility. When set to [Always], BIOS checks for user password both when accessing Setup and booting the system. Configuration options: [Setup] [Always]

## 4.7 Exit menu

The Exit menu items allow you to load the optimal or failsafe default values for the BIOS items, and save or discard your changes to the BIOS items.

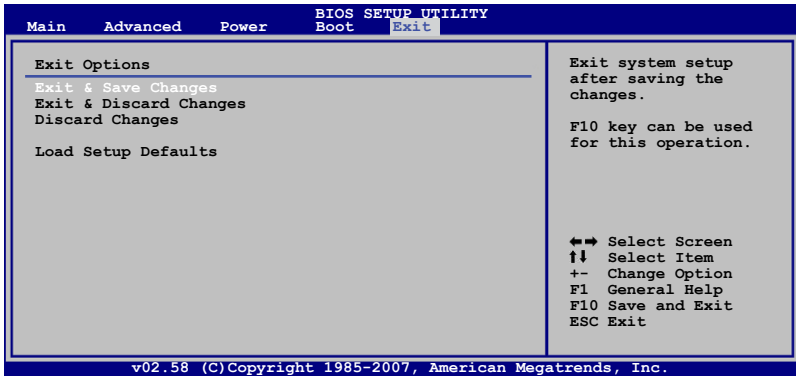

If you made changes to any of the settings in the menus, pressing <Esc> does not immediately exit this menu. A confirmation window appears and prompts you to either save your changes or cancel the command. Select one of the options from this menu to exit.

### Exit & Save Changes

Select this option then press <Enter>, or simply press <F10>, to save your changes to CMOS before exiting the Setup utility.

When a confirmation window appears, select [OK] then press <Enter> to save your changes and exit Setup. If you wish to cancel the command, select [Cancel] then press <Enter> to return to the Exit menu.

### Exit & Discard Changes

Select this option then press <Enter> to exit the Setup utility without saving your changes.

When a confirmation window appears, select [OK] then press <Enter> to discard your changes and exit Setup. If you wish to cancel the command, select [Cancel] then press <Enter> to return to the Exit menu.

### Discard Changes

Select this option then press <Enter> to discard the changes that you made, and restore the previously saved settings.

When a confirmation window appears, select [OK] then press <Enter> to discard the changes, and load the previously saved settings. If you wish to cancel the command, select [Cancel] then press <Enter> to return to the Exit menu.

### **Load Setup Defaults**

Select this option then press <Enter> to load the optimized settings for each of the Setup menu items.

When a confirmation window appears, select [OK] then press <Enter> to load the default settings. If you wish to cancel the command, select [Cancel] then press <Enter> to return to the Exit menu.

This chapter provides instructions for installing the necessary drivers for different system components.

# 5 Driver installation

- 5.1 LAN driver installation..... 6-11**
- 5.2 VGA driver installation..... 6-13**
- 5.3 Management applications and utilities installation ..... 6-15**

## 5.1 LAN driver installation

This section provides instructions on how to install the Marvell® 88E8056 LAN controller driver.

### 5.1.1 Windows® Server

To install the Marvell® 88E8056 LAN controller driver on a Windows® Server OS:

1. Restart the computer, then log on with **Administrator** privileges.
2. Insert the motherboard/system support CD to the optical drive. The CD automatically displays the **Drivers** menu if Autorun is enabled in your computer.



- Windows® automatically detects the LAN controllers and displays a **New Hardware Found** window. Click **Cancel** to close this window.
- If Autorun is NOT enabled in your computer, browse the contents of the support CD to locate the file ASSETUP.EXE from the BIN folder. Double-click the **ASSETUP.EXE** to run the CD.

3. Click the **Marvell LAN CPA Config tool** option to begin installation.

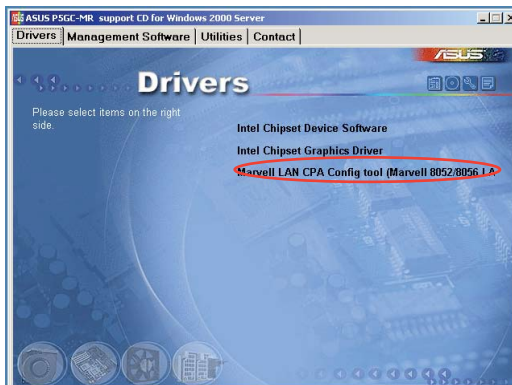

4. Click **Next** when the InstallShield Wizard window appears. Follow screen instructions to continue installation.

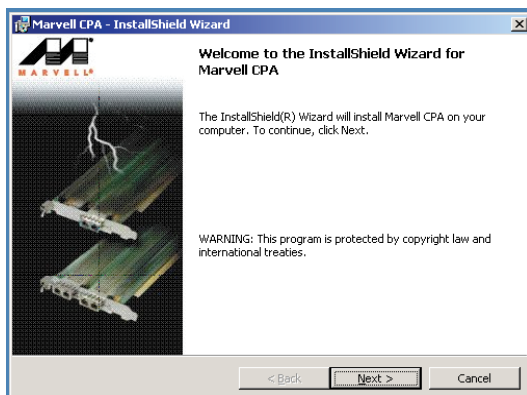

## 5.1.2 SuSE® Linux

Follow these instructions when installing the Marvell® 88E8056 LAN controller base driver for the SuSE® Linux operating system.



---

The following instructions are for Marvell® 88E8056 Linux LAN driver V10.22.4.1 or above. Visit <http://support.asus.com> for the latest Linux LAN driver before continuing the driver installation.

---

### Building the driver



---

Install first the Kernel Development tools before building the driver from the TAR file.

---

To build the driver:

1. Copy the Lan Driver from the SCD to local disk.  
**cp install\_vxx.xx.x.x.tar.bz2 /**
2. Decompress the file.  
**tar xfvj install\_vxx.xx.x.x.tar.bz2**
3. Change to the driver source directory.  
**cd /DriverInstall/**
4. In the **DriverInstall** directory, install the LAN driver.  
**sh install.sh**
5. In the next step, enter **1** to continue.

```
Installation script for sk98lin driver.
Version xx.xx.x.x (Oct-19-2007)
(C)Copyright 2003-2007 Marvell(R).
=====
Add to your trouble-report the logfile install.log
which is located in the DriverInstall directory.
=====
1) installation
2) generate patch
3) exit
Choose your favorite installation method:
```

6. Read the message on the screen and enter **Y** to continue.

```
Please read this carefully!

This script will automatically compile and load the sk98lin
driver on your host system. Before performing both compilation
and loading, it is necessary to shutdown any device using the
sk98lin kernel module and to unload the old sk98lin kernel
module. This script will do this automatically per default.

Please plug a card into your machine. Without a card we aren't
able to check the full driver functionality.

Do you want proceed? (y/N)
```

7. Confirm the installed driver version. For example, enter:  
**dmesg |grep sk98lin**
8. Refer to SuSE distribution documentation to configure the network protocol and address.



## 5.1.3 Red Hat® Linux

Follow these instructions when installing the Marvell® 88E8056 LAN controller base driver for the Red Hat® Linux OS:

### Building the driver



---

Install first the Kernel Development tools before building the driver from the TAR file.

---

To build the driver:

1. Copy the Lan Driver from the SCD to local disk.  
**cp install\_vxx.xx.x.x.tar.bz2 /**
2. Decompress the file.  
**tar xfvj install\_vxx.xx.x.x.tar.bz2**
3. Change to the driver source directory.  
**cd /DriverInstall/**
4. In the DriverInstall directory, install the LAN driver.  
**sh install.sh**
5. In the next step, enter **1** to continue.

```
Installation script for sk98lin driver.
Version xx.xx.x.x (Oct-19-2007)
(C) Copyright 2003-2007 Marvell(R).
=====
Add to your trouble-report the logfile install.log
which is located in the DriverInstall directory.
=====
1) installation
2) generate patch
3) exit
Choose your favorite installation method:
```

6. Read the message on the screen and enter **Y** to continue.

```
Please read this carefully!

This script will automatically compile and load the sk98lin
driver on your host system. Before performing both compilation
and loading, it is necessary to shutdown any device using the
sk98lin kernel module and to unload the old sk98lin kernel
module. This script will do this automatically per default.

Please plug a card into your machine. Without a card we aren't
able to check the full driver functionality.

Do you want proceed? (y/N)
```

7. Press any key to continue.

```
IMPORTANT INFORMATION!

We found an alternative driver for your Marvell product on this system.
The alternative driver is NOT directly supported by Marvell and does
not include all features provided by your device. If you want to use the
sk98lin driver developed by Marvell, you may choose either to deactivate
or remove the alternative driver.

[ PKRECY SFS OAR NFYURTHER INSTRUCTIONS]
```

8. The system prompts you to remove the old LAN driver and use the new driver instead. Enter **3** to continue.

```
Do nothing:
- The sk98lin will be installed
NOTE: It may happen that the alternative driver will be loaded on
the next boot process. In this case the Marvell driver WON'T be
loaded.

Deactivate driver:
- The alternative driver will be renamed to skge.ko or sky2.ko
- All references in the /etc/modprobe.conf file will be changed to
the sk98lin driver
- The alternative driver will be unloaded
- The sk98lin driver will be installed

Remove driver (recommended):
- The alternative driver will be removed from your system
- All references in the /etc/modprobe.conf file will be changed to
the sk98lin driver
- The alternative driver will be unloaded
- The sk98lin driver will be installed

1) Do nothing
2) Deactivate driver
3) Remove driver

Action:
```

9. Confirm the installed driver version. For example, enter:  
**dmesg |grep sk98lin**
10. Refer to Red Hat distribution documentation to configure the network protocol and address.

## 5.2 VGA driver installation

This section provides instructions on how to install the Internal VGA driver.

### 5.2.1 Windows® Server

You need to manually install the Internal VGA driver on a Windows® Server operating system.

To install the Internal VGA driver:

1. Restart the computer, then log on with **Administrator** privileges.
2. Insert the motherboard/system support CD to the optical drive. The support CD automatically displays the **Drivers** menu if Autorun is enabled in your computer.



Windows® automatically detects the VGA controller and displays a **New Hardware Found** window. Click **Cancel** to close this window.

3. Click the item **Intel Chipset Graphics Driver** from the Drivers menu.

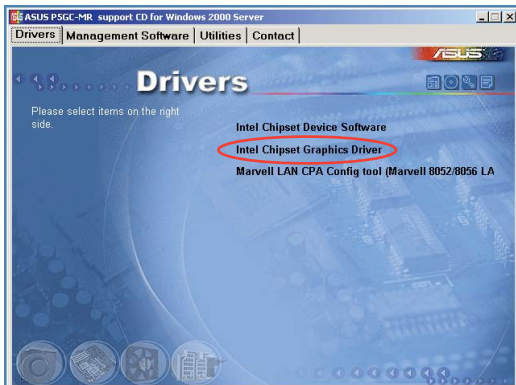

4. The **Intel Chipset Graphics Driver** window appears. Click **Next**. Follow screen instructions to complete installation.

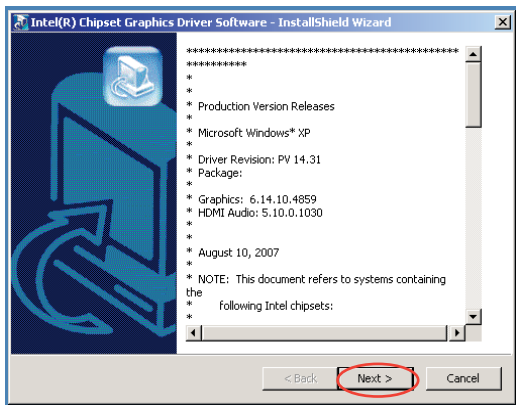

### **5.2.2 Windows® 2003 Server**

The Windows® 2003 Server operating system automatically recognizes the Internal VGA driver during system installation. There is no need to install an additional driver(s) to support the onboard VGA.

### **5.2.3 Red Hat® Enterprise**

The Red Hat® Enterprise operating system automatically recognizes the Internal VGA driver during system installation. There is no need to install an additional driver(s) to support the Internal VGA.

## 5.3 Management applications and utilities installation

The support CD that came with the motherboard package contains the drivers, management applications, and utilities that you can install to avail all motherboard features.



The contents of the support CD are subject to change at any time without notice. Visit the ASUS website ([www.asus.com](http://www.asus.com)) for updates.

### 5.3.1 Running the support CD

Place the support CD to the optical drive. The CD automatically displays the Drivers menu if Autorun is enabled in your computer.



If Autorun is NOT enabled in your computer, browse the contents of the support CD to locate the file **ASSETUP.EXE** from the BIN folder. Double-click the **ASSETUP.EXE** to run the CD.

### 5.3.2 Drivers menu

The Drivers menu shows the available device drivers if the system detects installed devices. Install the necessary drivers to activate the devices.



The screen display and driver options vary under different operating system versions.



### 5.3.3 Management Software menu

The **Management Software** menu displays the available network and server monitoring application. Click on an item to install.

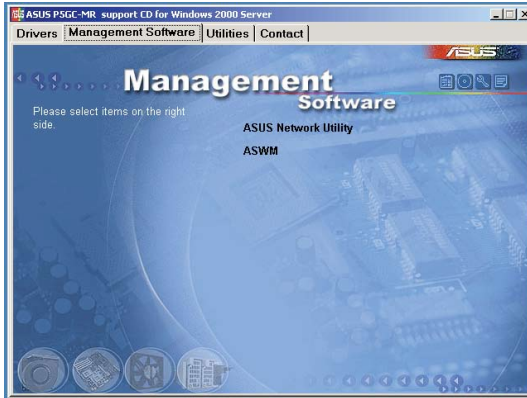

### 5.3.4 Utilities menu

The **Utilities** menu displays the software applications and utilities that the motherboard supports. Click on an item to install.

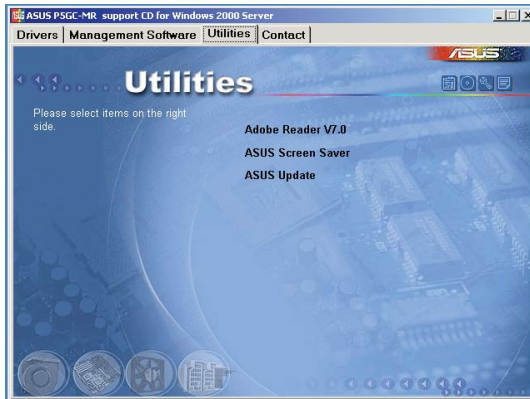

### 5.3.5 Contact information

Click the **Contact** tab to display the ASUS contact information. You can also find this information on the inside front cover of this user guide.

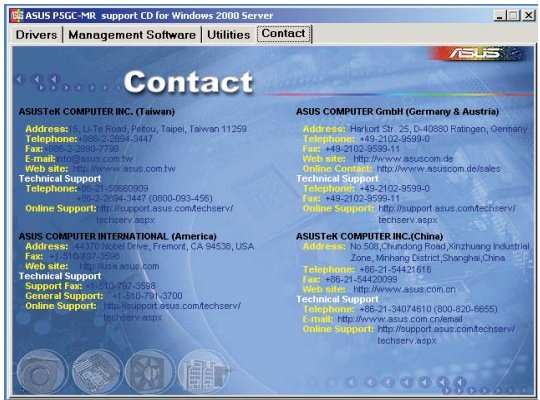





This appendix includes additional information that you may refer to when configuring the motherboard.

# Reference information

# Chapter summary



A.1 P5GC-MR block diagram .....A-1

# A.1 P5GC-MR block diagram

