



# **P5MT**

*Series*

**P5MT**  
**P5MT/SCSI**

# Motherboard

**E2059**

**First Edition V1  
August 2005**

**Copyright © 2005 ASUSTeK COMPUTER INC. All Rights Reserved.**

No part of this manual, including the products and software described in it, may be reproduced, transmitted, transcribed, stored in a retrieval system, or translated into any language in any form or by any means, except documentation kept by the purchaser for backup purposes, without the express written permission of ASUSTeK COMPUTER INC. (“ASUS”).

Product warranty or service will not be extended if: (1) the product is repaired, modified or altered, unless such repair, modification or alteration is authorized in writing by ASUS; or (2) the serial number of the product is defaced or missing.

ASUS PROVIDES THIS MANUAL “AS IS” WITHOUT WARRANTY OF ANY KIND, EITHER EXPRESS OR IMPLIED, INCLUDING BUT NOT LIMITED TO THE IMPLIED WARRANTIES OR CONDITIONS OF MERCHANTABILITY OR FITNESS FOR A PARTICULAR PURPOSE. IN NO EVENT SHALL ASUS, ITS DIRECTORS, OFFICERS, EMPLOYEES OR AGENTS BE LIABLE FOR ANY INDIRECT, SPECIAL, INCIDENTAL, OR CONSEQUENTIAL DAMAGES (INCLUDING DAMAGES FOR LOSS OF PROFITS, LOSS OF BUSINESS, LOSS OF USE OR DATA, INTERRUPTION OF BUSINESS AND THE LIKE), EVEN IF ASUS HAS BEEN ADVISED OF THE POSSIBILITY OF SUCH DAMAGES ARISING FROM ANY DEFECT OR ERROR IN THIS MANUAL OR PRODUCT.

SPECIFICATIONS AND INFORMATION CONTAINED IN THIS MANUAL ARE FURNISHED FOR INFORMATIONAL USE ONLY, AND ARE SUBJECT TO CHANGE AT ANY TIME WITHOUT NOTICE, AND SHOULD NOT BE CONSTRUED AS A COMMITMENT BY ASUS. ASUS ASSUMES NO RESPONSIBILITY OR LIABILITY FOR ANY ERRORS OR INACCURACIES THAT MAY APPEAR IN THIS MANUAL, INCLUDING THE PRODUCTS AND SOFTWARE DESCRIBED IN IT.

Products and corporate names appearing in this manual may or may not be registered trademarks or copyrights of their respective companies, and are used only for identification or explanation and to the owners’ benefit, without intent to infringe.

# Contents

Notices .....	vi
Safety information .....	vii
About this guide .....	viii
P5MT Series specifications summary .....	x

## Chapter 1: Product introduction

1.1	Welcome! .....	1-1
1.2	Package contents .....	1-1
1.3	Special features .....	1-2
1.3.1	Product highlights .....	1-2
1.3.2	Innovative ASUS features .....	1-4

## Chapter 2: Hardware information

2.1	Before you proceed .....	2-1
2.2	Motherboard overview .....	2-2
2.2.1	Placement direction .....	2-2
2.2.2	Screw holes .....	2-2
2.2.3	Motherboard layouts .....	2-3
2.2.4	Layout contents .....	2-5
2.3	Central Processing Unit (CPU) .....	2-7
2.3.1	Installing the CPU .....	2-7
2.3.2	Installing the CPU heatsink and fan .....	2-10
2.3.3	Uninstalling the CPU heatsink and fan .....	2-12
2.4	System memory .....	2-13
2.4.1	Overview .....	2-13
2.4.2	Memory configurations .....	2-13
2.4.3	Installing a DIMM .....	2-14
2.4.4	Removing a DIMM .....	2-14
2.5	Expansion slots .....	2-15
2.5.1	Installing an expansion card .....	2-15
2.5.2	Configuring an expansion card .....	2-15
2.5.3	Interrupt assignments .....	2-16
2.5.4	PCI/PCI-X slots .....	2-17
2.5.5	PCI Express x16 slot .....	2-17
2.6	Jumpers .....	2-18
2.7	Connectors .....	2-23
2.7.1	Rear panel connectors .....	2-23
2.7.2	Internal connectors .....	2-24

# Contents

## Chapter 3: Powering up

- 3.1 Starting up for the first time ..... 3-1
- 3.2 Powering off the computer ..... 3-2
  - 3.2.1 Using the OS shut down function ..... 3-2
  - 3.2.2 Using the dual function power switch ..... 3-2

## Chapter 4: BIOS setup

- 4.1 Managing and updating your BIOS ..... 4-1
  - 4.1.1 Creating a bootable floppy disk ..... 4-1
  - 4.1.2 AFUDOS utility ..... 4-2
  - 4.1.3 ASUS CrashFree BIOS 2 utility ..... 4-5
  - 4.1.4 ASUS Update utility ..... 4-7
- 4.2 BIOS setup program ..... 4-10
  - 4.2.1 BIOS menu screen ..... 4-11
  - 4.2.2 Menu bar ..... 4-11
  - 4.2.3 Navigation keys ..... 4-11
  - 4.2.4 Menu items ..... 4-12
  - 4.2.5 Sub-menu items ..... 4-12
  - 4.2.6 Configuration fields ..... 4-12
  - 4.2.7 Pop-up window ..... 4-12
  - 4.2.8 Scroll bar ..... 4-12
  - 4.2.9 General help ..... 4-12
- 4.3 Main menu ..... 4-13
  - 4.3.1 System Time ..... 4-13
  - 4.3.2 System Date ..... 4-13
  - 4.3.3 Legacy Diskette A ..... 4-13
  - 4.3.4 IDE Configuration ..... 4-14
  - 4.3.5 Primary/Secondary/Third IDE Master/Slave ..... 4-15
  - 4.3.6 System Information ..... 4-17
- 4.4 Advanced menu ..... 4-18
  - 4.4.1 MPS Configuration ..... 4-18
  - 4.4.2 Remote Access Configuration ..... 4-19
  - 4.4.3 CPU Configuration ..... 4-20
  - 4.4.4 Chipset Configuration ..... 4-22
  - 4.4.5 Onboard Devices Configuration ..... 4-26
  - 4.4.6 PCI/PnP Configuration ..... 4-27

# Contents

4.5	Power menu .....	4-28
4.5.1	APM Configuration .....	4-28
4.5.2	Hardware Monitor .....	4-31
4.6	Boot menu .....	4-33
4.6.1	Boot Device Priority .....	4-33
4.6.2	Boot Settings Configuration .....	4-34
4.6.3	Security .....	4-35
4.7	Exit menu .....	4-38

## Chapter 5: RAID configuration

5.1	Setting up RAID .....	5-1
5.1.1	RAID definitions .....	5-1
5.1.2	Installing hard disk drives .....	5-2
5.1.3	Setting the RAID item in BIOS .....	5-2
5.1.4	RAID configuration utilities .....	5-3
5.2	LSI Logic Embedded SATA RAID Setup Utility .....	5-4
5.2.1	Creating a RAID 0 or RAID 1 set .....	5-5
5.2.2	Creating a RAID 10 set .....	5-11
5.2.3	Adding or viewing a RAID configuration .....	5-15
5.2.4	Initializing the logical drives .....	5-18
5.2.5	Rebuilding failed drives .....	5-23
5.2.6	Checking the drives for data consistency .....	5-25
5.2.7	Deleting a RAID configuration .....	5-28
5.2.8	Selecting the boot drive from a RAID set .....	5-29
5.2.9	Enabling the WriteCache .....	5-30
5.3	Global Array Manager .....	5-30
5.4	LSI Logic Configuration Utility .....	5-31
5.4.1	Boot Adapter List .....	5-32
5.4.2	Global Properties .....	5-33
5.4.3	Adapter Properties .....	5-35
5.4.4	Creating a RAID 1 (Mirror) set .....	5-42
5.4.5	Creating a RAID 0 (Stripe) set .....	5-44
5.4.6	Running the Diagnostic Mode .....	5-44
5.4.7	Managing arrays .....	5-46

# Contents

## Chapter 6: Driver installation

6.1	RAID driver installation .....	6-1
6.1.1	Creating a RAID driver disk .....	6-1
6.1.2	Installing the RAID controller driver .....	6-2
6.2	LAN driver installation .....	6-11
6.2.1	Windows® 2000/2003 Server .....	6-11
6.2.2	Red Hat® Enterprise ver. 3.0 .....	6-12
6.3	VGA driver installation .....	6-13
6.3.1	Windows® 2000 Server .....	6-13
6.3.2	Windows® 2003 Server .....	6-14
6.3.3	Red Hat® Enterprise ver. 3.0 .....	6-14
6.4	Management applications and utilities installation .....	6-15
6.4.1	Running the support CD .....	6-15
6.4.2	Drivers menu .....	6-15
6.4.3	Management Software menu .....	6-16
6.4.4	Utilities menu .....	6-16
6.4.5	Contact information .....	6-16

## Appendix: Reference information

A.1	Intel® EM64T .....	A-1
A.2	Enhanced Intel SpeedStep® Technology (EIST) .....	A-1
A.2.1	System requirements .....	A-1
A.2.2	Using the EIST .....	A-2
A.3	Intel® Hyper-Threading Technology .....	A-3
A.4	Block diagrams .....	A-4
A.4.1	P5MT model .....	A-4
A.4.2	P5MT/SCSI model .....	A-5

# Notices

## Federal Communications Commission Statement

This device complies with Part 15 of the FCC Rules. Operation is subject to the following two conditions:

- This device may not cause harmful interference, and
- This device must accept any interference received including interference that may cause undesired operation.

This equipment has been tested and found to comply with the limits for a Class B digital device, pursuant to Part 15 of the FCC Rules. These limits are designed to provide reasonable protection against harmful interference in a residential installation. This equipment generates, uses and can radiate radio frequency energy and, if not installed and used in accordance with manufacturer's instructions, may cause harmful interference to radio communications. However, there is no guarantee that interference will not occur in a particular installation. If this equipment does cause harmful interference to radio or television reception, which can be determined by turning the equipment off and on, the user is encouraged to try to correct the interference by one or more of the following measures:

- Reorient or relocate the receiving antenna.
- Increase the separation between the equipment and receiver.
- Connect the equipment to an outlet on a circuit different from that to which the receiver is connected.
- Consult the dealer or an experienced radio/TV technician for help.



---

The use of shielded cables for connection of the monitor to the graphics card is required to assure compliance with FCC regulations. Changes or modifications to this unit not expressly approved by the party responsible for compliance could void the user's authority to operate this equipment.

---

## Canadian Department of Communications Statement

This digital apparatus does not exceed the Class B limits for radio noise emissions from digital apparatus set out in the Radio Interference Regulations of the Canadian Department of Communications.

**This class B digital apparatus complies with Canadian ICES-003.**

# Safety information

## Electrical safety

- To prevent electrical shock hazard, disconnect the power cable from the electrical outlet before relocating the system.
- When adding or removing devices to or from the system, ensure that the power cables for the devices are unplugged before the signal cables are connected. If possible, disconnect all power cables from the existing system before you add a device.
- Before connecting or removing signal cables from the motherboard, ensure that all power cables are unplugged.
- Seek professional assistance before using an adapter or extension cord. These devices could interrupt the grounding circuit.
- Make sure that your power supply is set to the correct voltage in your area. If you are not sure about the voltage of the electrical outlet you are using, contact your local power company.
- If the power supply is broken, do not try to fix it by yourself. Contact a qualified service technician or your retailer.

## Operation safety

- Before installing the motherboard and adding devices on it, carefully read all the manuals that came with the package.
- Before using the product, make sure all cables are correctly connected and the power cables are not damaged. If you detect any damage, contact your dealer immediately.
- To avoid short circuits, keep paper clips, screws, and staples away from connectors, slots, sockets and circuitry.
- Avoid dust, humidity, and temperature extremes. Do not place the product in any area where it may become wet.
- Place the product on a stable surface.
- If you encounter technical problems with the product, contact a qualified service technician or your retailer.



# About this guide

This user guide contains the information you need when installing and configuring the motherboard.

## How this guide is organized

This guide contains the following parts:

- **Chapter 1: Product introduction**  
This chapter describes the features of the motherboard and the new technologies it supports.
- **Chapter 2: Hardware information**  
This chapter lists the hardware setup procedures that you have to perform when installing system components. It includes description of the switches, jumpers, and connectors on the motherboard.
- **Chapter 3: Powering up**  
This chapter describes the power up sequence and ways of shutting down the system.
- **Chapter 4: BIOS setup**  
This chapter tells how to change system settings through the BIOS Setup menus. Detailed descriptions of the BIOS parameters are also provided.
- **Chapter 5: RAID configuration**  
This chapter tells how to change system settings through the BIOS Setup menus. Detailed descriptions of the BIOS parameters are also provided.
- **Chapter 6: Driver installation**  
This chapter provides instructions for installing the necessary drivers for different system components.
- **Appendix: Reference information**  
This appendix includes additional information that you may refer to when configuring the motherboard.

## Where to find more information

Refer to the following sources for additional information and for product and software updates.

### 1. ASUS websites

The ASUS website provides updated information on ASUS hardware and software products. Refer to the ASUS contact information.

### 2. Optional documentation

Your product package may include optional documentation, such as warranty flyers, that may have been added by your dealer. These documents are not part of the standard package.

## Conventions used in this guide

To make sure that you perform certain tasks properly, take note of the following symbols used throughout this manual.



**DANGER/WARNING:** Information to prevent injury to yourself when trying to complete a task.



**CAUTION:** Information to prevent damage to the components when trying to complete a task.



**IMPORTANT:** Instructions that you **MUST** follow to complete a task.



**NOTE:** Tips and additional information to help you complete a task.

## Typography

**Bold text**

Indicates a menu or an item to select.

*Italics*

Used to emphasize a word or a phrase.

<Key>

Keys enclosed in the less-than and greater-than sign means that you must press the enclosed key.

Example: <Enter> means that you must press the Enter or Return key.

<Key1+Key2+Key3>

If you must press two or more keys simultaneously, the key names are linked with a plus sign (+).

Example: <Ctrl+Alt+D>

**Command**

Means that you must type the command exactly as shown, then supply the required item or value enclosed in brackets.

Example: At the DOS prompt, type the command line: **format A:/S**

## P5MT Series specifications summary

<b>CPU</b>	LGA775 socket for Intel® Pentium® 4 processor Compatible with Intel® PCG 05B/05A and 04B/04A and the latest Intel® Smithfield dual-core processor Supports Intel® Enhanced Memory 64 Technology (EM64T) Supports Enhanced Intel SpeedStep® Technology (EIST) Supports Intel® Hyper-Threading Technology
<b>Chipset</b>	Northbridge : Intel® E7230 Southbridge : Intel® ICH7R I/O bridge : Intel® 6702 PXH-V
<b>Front Side Bus</b>	1066/800/533 MHz
<b>Memory</b>	Dual-channel memory architecture 4 x 240-pin DIMM sockets support unbuffered ECC/non-ECC DDR2-533/667 memory modules Supports 256 MB up to 8 GB system memory
<b>Expansion slots*</b>	1 x PCI Express x16 slot (x8 link, PCI Express 1.0a) 1 x PCI-X 100 MHz/64-bit slot (PCI-X 1.0) <i>(supports Zero-Channel RAID card, colored green on P5MT/SCSI model)</i> 1 x PCI-X 100 MHz/64-bit slot (PCI-X 1.0) 1 x PCI 33 MHz/32-bit/5V slot (PCI 2.3) 1 x mini-PCI socket for ASUS® Server Management Board
<b>Storage P5MT</b>	Intel® ICH7R Southbridge supports: <ul style="list-style-type: none"> <li>- 2 x Ultra ATA 100/66/33 hard disk drives</li> <li>- 4 x SATA-300 hard disk drives with RAID functionality using the Intel® Matrix Storage Manager or IMSM (RAID 0, RAID 1, RAID 10, and software RAID 5), or the LSI Logic Embedded SATA RAID controller (RAID 0, RAID 1, RAID 10)</li> </ul>
<b>P5MT/SCSI</b>	P5MT storage + LSI53C1020A PCI-X SCSI controller supports: <ul style="list-style-type: none"> <li>- 1 x Ultra-320 SCSI channel with RAID 0, RAID 1, and RAID 1-E configuration</li> <li>- Zero-Channel RAID card (optional)</li> </ul>



### \*Important notes:

- A PCI Express x16 graphics card inserted to the PCI Express x16 slot may run only at x1 speed (Intel spec).
- For P5MT model: When one PCI-X slot is occupied, the PCI-X frequency is 133 MHz. When two PCI-X slots are occupied, the PCI-X frequency is 100 MHz.
- For P5MT/SCSI model: When one PCI-X slot is occupied, the PCI-X frequency is 100 MHz. When two PCI-X slots are occupied, the PCI-X frequency is 66 MHz.

*(continued on the next page)*

## P5MT Series specifications summary

<b>Graphics</b>	ATI® RAGE-XL PCI-based VGA controller
<b>LAN</b>	LAN 1: Broadcom BCM5721 Gigabit LAN controller LAN 2: Broadcom BCM5721 Gigabit LAN controller Complies with PCI Express 1.0a specifications
<b>USB</b>	Intel® ICH7R Southbridge supports: - 4 USB 2.0 ports (2 on the rear panel, 2 on the front panel)
<b>Special features</b>	ASUS Smart Fan ASUS CrashFree BIOS 2 ASUS MyLogo2
<b>BIOS features</b>	AMI BIOS, 8 MB Flash ROM, Green, PnP, DMI, SMBIOS 2.3, WfM2.0, ACPI 2.0a
<b>Rear panel</b>	PS/2 keyboard port (purple) PS/2 mouse port (green) 2 x USB 2.0 ports Printer port Serial port (COM1) VGA port 2 x LAN (RJ-45) ports
<b>Internal connectors</b>	Floppy disk drive connector IDE connector 4 x Serial ATA connectors 2 x CPU fan connectors 4 x system fan 24-pin SSI power connector 8-pin ATX 12V power connector USB 2.0 connectors Backplane SMBus connector Power SMBus connector System panel connector Auxiliary panel connector Hard disk activity LED connector Ambient thermal sensor connector Serial port (COM2) connector Chassis intrusion connector ASUS server management (BMC) connector Ultra-320 SCSI connector ( <i>P5MT/SCSI model only</i> )
<b>Power Requirement</b>	SSI power supply (with 24-pin and 8-pin 12V plugs) ATX 12V 2.0 compliant
<b>Form Factor</b>	ATX form factor: 12 in x 9.8 in (30.5 cm x 24.9 cm)
<b>Support CD contents</b>	Device drivers ASUS Live Update Utility ASUS Server Web-based Management (ASWM) Anti-virus software

*\*Specifications are subject to change without notice.*

This chapter describes the motherboard features and the new technologies it supports.

# Product introduction



# Chapter summary



1.1	Welcome! .....	1-1
1.2	Package contents .....	1-1
1.3	Special features .....	1-2

## 1.1 Welcome!

**Thank you for buying an ASUS® P5MT Series motherboard!**

The motherboard delivers a host of new features and latest technologies, making it another standout in the long line of ASUS quality motherboards!

Before you start installing the motherboard, and hardware devices on it, check the items in your package with the list below.

## 1.2 Package contents

Check your motherboard package for the following items.

<b>Motherboard</b>	ASUS P5MT or P5MT/SCSI motherboard
<b>Cables</b>	4 x Serial ATA signal cables 2 x Serial ATA power cables 1 x SCSI Ultra320 cable (P5MT/SCSI model only) 80-conductor IDE cable 3-in-1 Floppy/Ultra ATA disk drive cable
<b>Accessories</b>	I/O shield
<b>Application CDs</b>	ASUS motherboard support CD
<b>Documentation</b>	P5MT Series user guide



If any of the above items is damaged or missing, contact your retailer.

## 1.3 Special features

### 1.3.1 Product highlights

#### Latest processor technology

The motherboard comes with a 775-pin surface mount Land Grid Array (LGA) socket designed for the Intel® Pentium® 4 processor in the 775-land package. The motherboard supports the Intel® Pentium® 4 processor with 1066/800/533 MHz Front Side Bus (FSB). The motherboard also supports the Intel® Hyper-Threading Technology and is fully compatible with Intel® 05B/05A or 04B/04A processors. See page 2-7 for details.

#### Intel® EM64T

The motherboard supports Intel® Pentium® 4 CPUs with the Intel® EM64T (Extended Memory 64 Technology). The Intel® EM64T feature allows your computer to run on 64-bit operating systems and access larger amounts of system memory for faster and more efficient computing. See the Appendix for details.

#### Enhanced Intel SpeedStep® Technology (EIST)

The Enhanced Intel SpeedStep® Technology (EIST) intelligently manages the CPU resources by automatically adjusting the CPU voltage and core frequency depending on the CPU loading and system speed or power requirement. See page 4-21 and the Appendix for details.

#### Intel® E7230 and Intel® ICH7R chipset

The Intel® E7230 Memory Controller Hub (MCH) and the Intel® ICH7R (I/O controller hub) provide the vital interfaces for the motherboard.

The MCH provides the processor, dual-channel DDR2-533/667 memory, and PCI Express interfaces. The ICH is a new generation server class I/O controller hub that provides the interface for PCI 2.3, USB 2.0, and SATA among others.

#### DDR2-667 memory support

The motherboard supports DDR2 memory which features data transfer rates of up to 667 MHz to meet the higher bandwidth requirements of the latest server applications. The dual-channel memory architecture doubles the bandwidth of your system memory to boost system performance, eliminating bottlenecks with peak bandwidths of up to 10.7 GB/s.

#### PCI Express™ interface

The motherboard fully supports PCI Express, the latest I/O interconnect technology that speeds up the PCI bus. PCI Express features point-to-point serial interconnections between devices and allows higher clockspeeds by carrying data in packets. This high speed interface is software compatible with existing PCI or PCI-X specifications. See page 2-17 for details.



## Ultra320 SCSI feature (*P5MT/SCSI model only*)

The LSI53C1020A PCI-X SCSI controller is onboard to support one 68-pin Ultra320 SCSI connector, that can connect up to 15 SCSI devices. See page 2-27 and Chapter 5 for details.

## Zero-Channel RAID (ZCR) card solution

The motherboard comes with a PCI-X slot (green slot in P5MT/SCSI model) that supports an optional Zero-Channel RAID card. The Zero-Channel RAID card allows you to create all types of RAID configurations for your storage devices. The ZCR capability provides a cost-effective, high-performance, and added reliability for your server system.

## Gigabit LAN solution

The motherboard comes with dual Gigabit LAN controllers and ports to provide a total solution for your networking needs. The onboard Broadcom® BCM5721 Gigabit LAN controllers use the PCI Express interface and could achieve network throughput close to Gigabit bandwidth. See page 2-23 for details.

## Serial ATA II technology

The motherboard supports the Serial ATA II technology through the Serial ATA interfaces controlled by the Intel® ICH7R. The SATA specification allows for thinner, more flexible cables with lower pin count, reduced voltage requirement, and up to 300 MB/s data transfer rate.

## Built-in SATA RAID solution

The Intel® ICH7R allows RAID 0, RAID 1, RAID 0+1, and software RAID 5 configuration for SATA hard disk drives via the Intel® Matrix Storage Manager or the LSI Logic Embedded SATA RAID Setup Utility (no RAID 5). See page 2-25 and Chapter 5 for details.

## USB 2.0 technology

The motherboard implements the Universal Serial Bus (USB) 2.0 specification, dramatically increasing the connection speed from the 12 Mbps bandwidth on USB 1.1 to a fast 480 Mbps on USB 2.0. USB 2.0 is backward compatible with USB 1.1. See pages 2-23 and 2-26 for details.

## Temperature, fan, and voltage monitoring

The CPU temperature is monitored by the ASIC (integrated in the Winbond hardware monitor) to prevent overheating and damage. The system fan rotations per minute (RPM) is monitored for timely failure detection. The ASIC monitors the voltage levels to ensure stable supply of current for critical components. See page 4-31 for details.

### 1.3.2 Innovative ASUS features

#### CrashFree BIOS 2

This feature allows you to restore the original BIOS data from the support CD in case when the BIOS codes and data are corrupted. This protection eliminates the need to buy a replacement ROM chip. See page 4-5 for details.

#### ASUS Smart Fan technology

The ASUS Smart Fan technology smartly adjusts the fan speeds according to the system loading to ensure quiet, cool, and efficient operation. See page 4-31 for details.

#### ASUS MyLogo2™

This new feature present in the motherboard allows you to personalize and add style to your system with customizable boot logos. See page 4-34 for details.

This chapter lists the hardware setup procedures that you have to perform when installing system components. It includes description of the jumpers and connectors on the motherboard.

# Hardware information



## Chapter summary



2.1	Before you proceed .....	2-1
2.2	Motherboard overview .....	2-2
2.3	Central Processing Unit (CPU) .....	2-7
2.4	System memory .....	2-13
2.5	Expansion slots .....	2-15
2.6	Jumpers .....	2-18
2.7	Connectors .....	2-23

## 2.1 Before you proceed

Take note of the following precautions before you install motherboard components or change any motherboard settings.



- Unplug the power cord from the wall socket before touching any component.
- Use a grounded wrist strap or touch a safely grounded object or to a metal object, such as the power supply case, before handling components to avoid damaging them due to static electricity.
- Hold components by the edges to avoid touching the ICs on them.
- Whenever you uninstall any component, place it on a grounded antistatic pad or in the bag that came with the component.
- **Before you install or remove any component, ensure that the power supply is switched off or the power cord is detached from the power supply.** Failure to do so may cause severe damage to the motherboard, peripherals, and/or components.

### Onboard LED

The motherboard comes with a standby power LED. The green LED lights up to indicate that the system is ON, in sleep mode, or in soft-off mode. This is a reminder that you should shut down the system and unplug the power cable before removing or plugging in any motherboard component. The illustration below shows the location of the onboard LED.

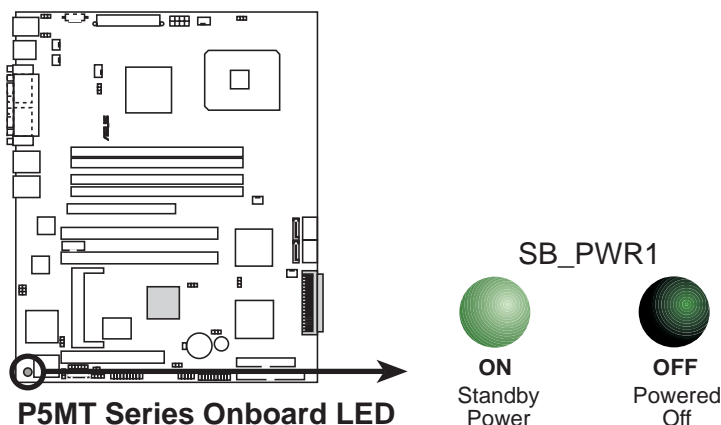

## 2.2 Motherboard overview

Before you install the motherboard, study the configuration of your chassis to ensure that the motherboard fits into it.

To optimize the motherboard features, we highly recommend that you install it in an **SSI EEB 3.5 compliant chassis**.



Make sure to unplug the chassis power cord before installing or removing the motherboard. Failure to do so can cause you physical injury and damage motherboard components!

### 2.2.1 Placement direction

When installing the motherboard, make sure that you place it into the chassis in the correct orientation. The edge with external ports goes to the rear part of the chassis as indicated in the image below.

### 2.2.2 Screw holes

Place nine (9) screws into the holes indicated by circles to secure the motherboard to the chassis.



Do not overtighten the screws! Doing so can damage the motherboard.

Place this side towards the rear of the chassis

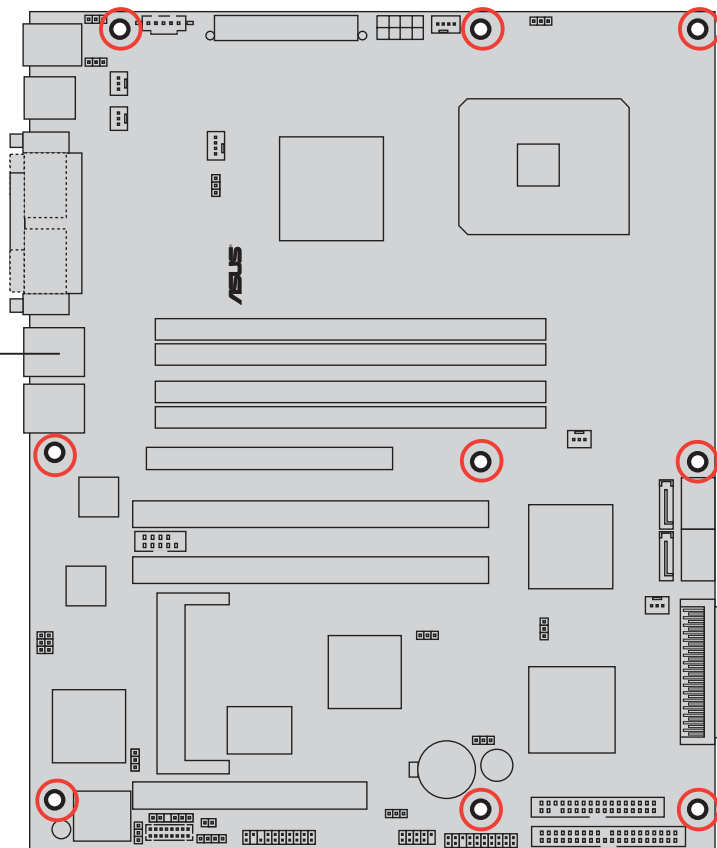

## 2.2.3 Motherboard layouts

### P5MT model

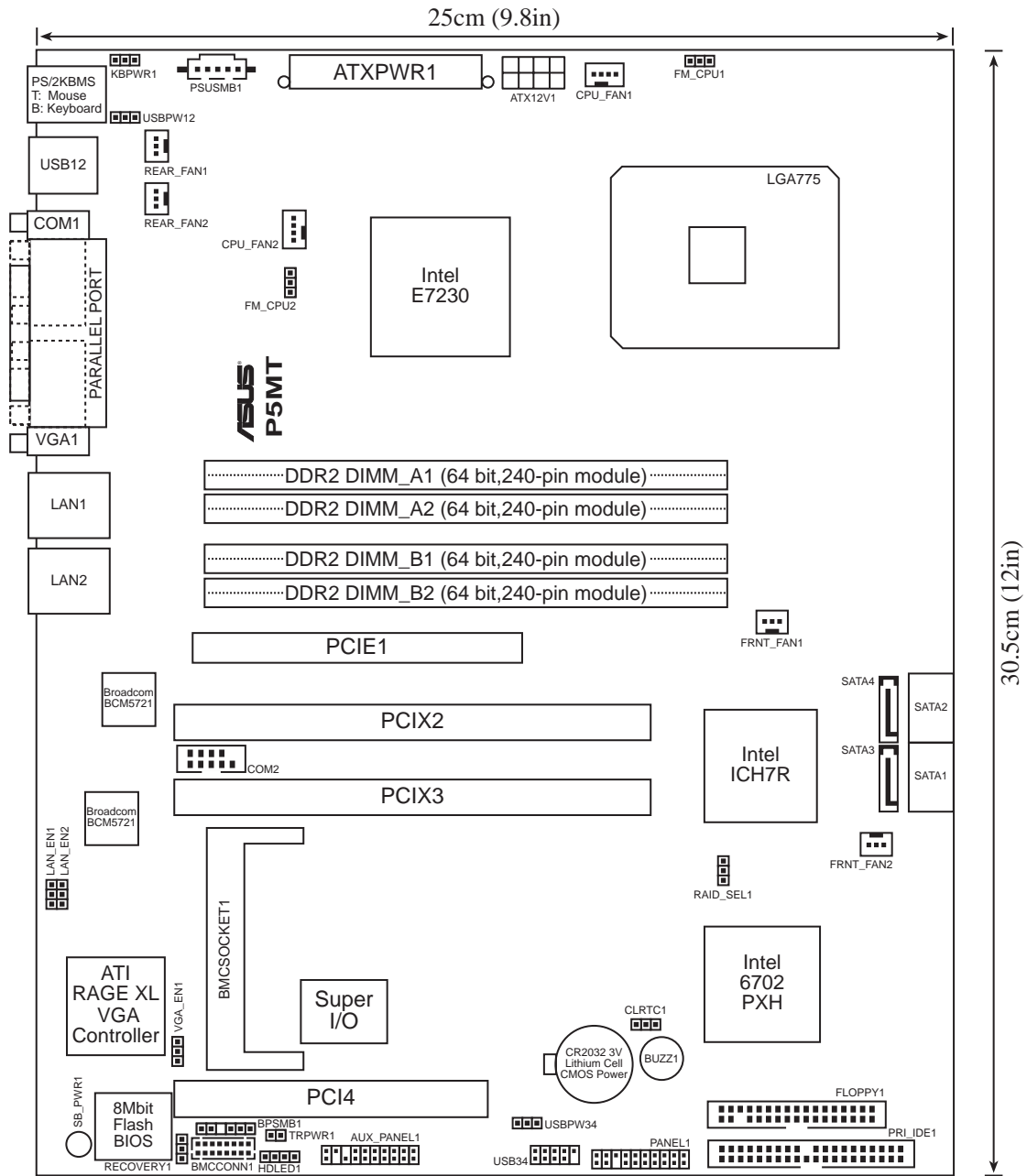

# P5MT/SCSI model

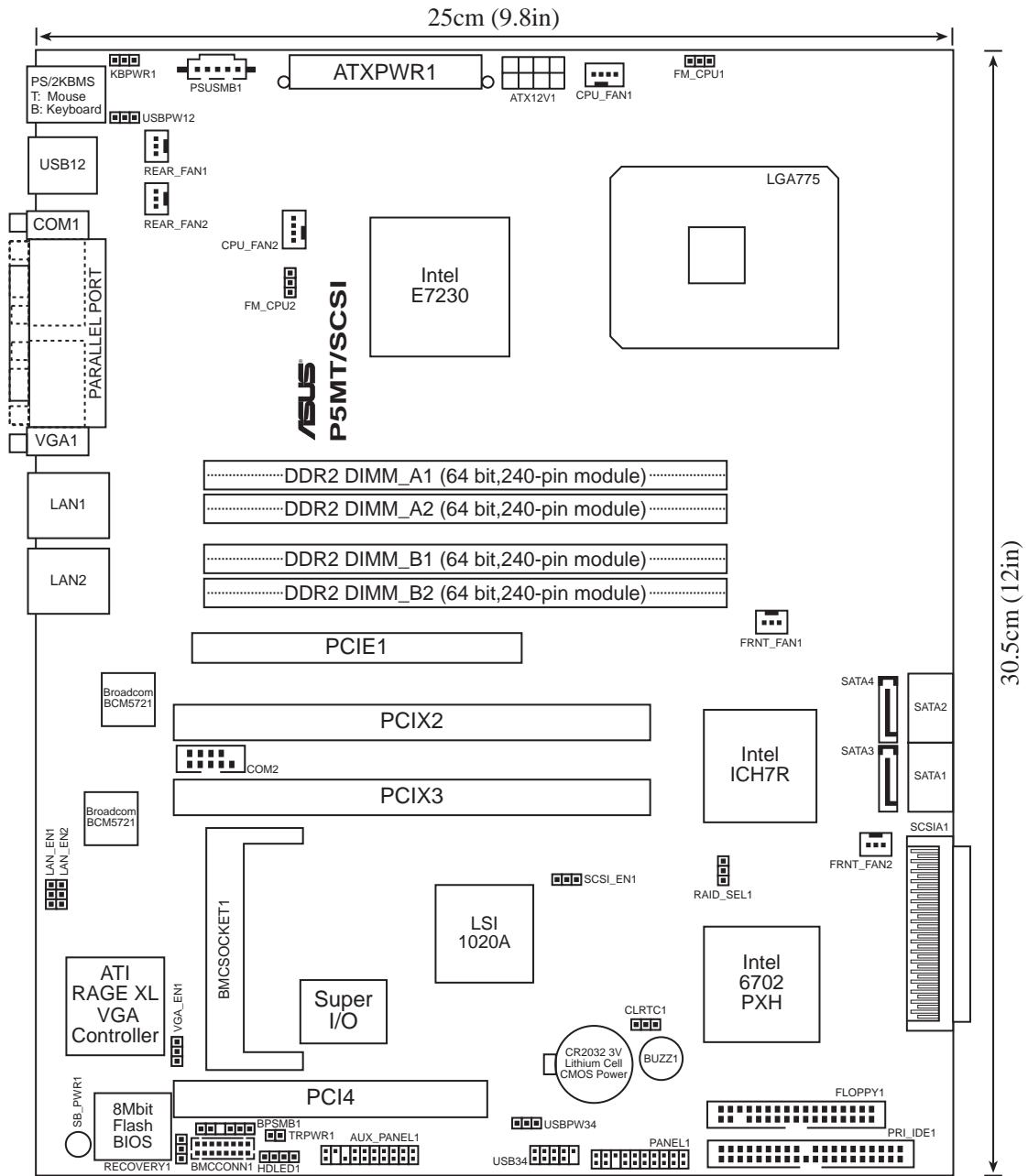



## 2.2.4 Layout contents

Slots/Sockets	Page
1. CPU sockets	2-11
2. DDR2 DIMM sockets	2-15
3. PCI/PCI-X/PCI Express slots	2-20
4. Zero-Channel RAID socket	2-20

Jumpers	Page
1. Clear RTC RAM (CLRTC1)	2-18
2. CPU fan pin selection (3-pin FM_CPU1, FM_CPU2)	2-19
3. USB device wake-up (3-pin USBPW1, USBPW2)	2-19
4. Keyboard power (3-pin KBPWR1)	2-20
5. VGA controller setting (3-pin VGA_EN1)	
6. Gigabit LAN controller setting (3-pin LAN_EN1; LAN_EN2)	2-21
7. RAID controller selection (3-pin RAID_SEL1)	2-21
8. SCSI controller setting (3-pin SCSI_EN1) (P5MT/SCSI model only)	2-22
9. Force BIOS recovery setting (3-pin RECOVERY1)	2-22

Rear panel connectors	Page
1. PS/2 mouse port (green)	2-23
2. Parallel port	2-23
3. PS/2 keyboard port (purple)	2-23
4. USB 2.0 ports 1 and 2	2-23
5. Serial (COM1) port	2-23
6. VGA port	2-23
7. Gigabit LAN1 (RJ-45) port	2-23
8. Gigabit LAN2 (RJ-45) port	2-23

Internal connectors	Page
1. Floppy disk drive connector (34-pin FLOPPY1)	2-24
2. Primary IDE connectors (40-pin PRI_IDE1)	2-24
3. Serial ATA connectors (7-pin SATA1, SATA2, SATA3, SATA4)	2-25
4. Hard disk activity LED connector (4-pin HDLED1)	2-26
5. USB connector (10-pin USB34)	2-26
6. Ultra320 SCSI connectors (one 68-pin SCSEA1) (present in P5MT/SCSI model only)	2-27
7. Serial port connector (10-pin COM2)	2-28
8. BMC connector (16-pin BMCCONN1)	2-28
9. Ambient thermal sensor (2-pin TRPWR1)	2-28
10. CPU and system fan connectors (3-pin CPU_FAN1/2, REAR_FAN1/2, FRNT_FAN1/2)	2-29
11. Backplane SMBus connector (6-pin BPSMB1)	2-29
12. Power supply SMBus connector (5-pin PSUSMB1)	2-30
13. ATX power connectors (24-pin ATXPWR1, 4-pin ATX12V1)	2-30
14. System panel connector (20-pin PANEL1)	2-31
15. Auxiliary panel connector (20-pin AUX_PANEL1)	2-32

## 2.3 Central Processing Unit (CPU)

The motherboard comes with a surface mount LGA775 socket designed for the Intel® Pentium® 4 processor in the 775-land package



- Upon purchase of the motherboard, make sure that the PnP cap is on the socket and the socket contacts are not bent. Contact your retailer immediately if the PnP cap is missing, or if you see any damage to the PnP cap/socket contacts/motherboard components. ASUS will shoulder the cost of repair only if the damage is shipment/transit-related.
- Keep the cap after installing the motherboard. ASUS will process Return Merchandise Authorization (RMA) requests only if the motherboard comes with the cap on the LGA775 socket.
- The product warranty does not cover damage to the socket contacts resulting from incorrect CPU installation/removal, or misplacement/loss/incorrect removal of the PnP cap.

### 2.3.1 Installing the CPU

To install a CPU:

1. Locate the CPU socket on the motherboard.

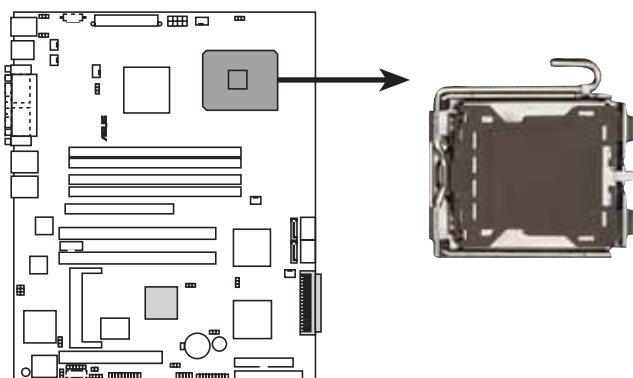

**P5MT Series CPU Socket 775**



Before installing the CPU, make sure that the cam box is facing towards you and the load lever is on your left.

2. Press the load lever with your thumb (A), then move it to the left (B) until it is released from the retention tab.

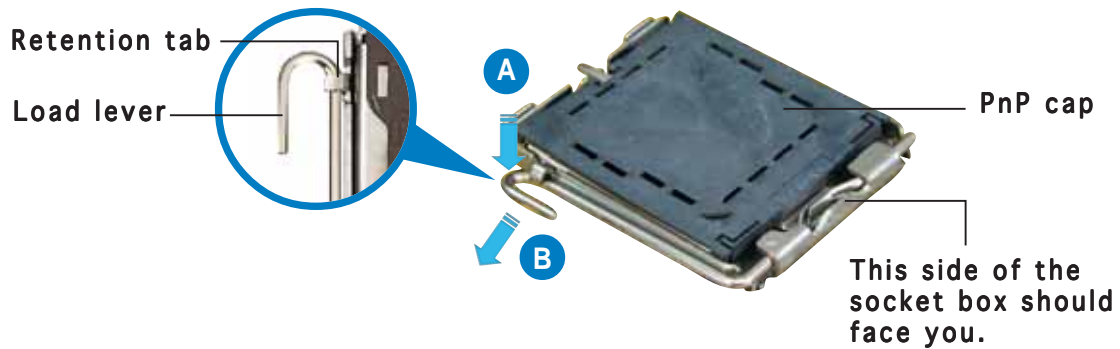

To prevent damage to the socket pins, do not remove the PnP cap unless you are installing a CPU.

3. Lift the load lever in the direction of the arrow to a 135° angle.

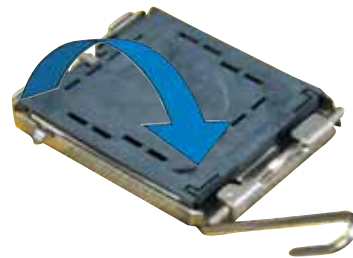

4. Lift the load plate with your thumb and forefinger to a 100° angle (A), then push the PnP cap from the load plate window to remove (B).

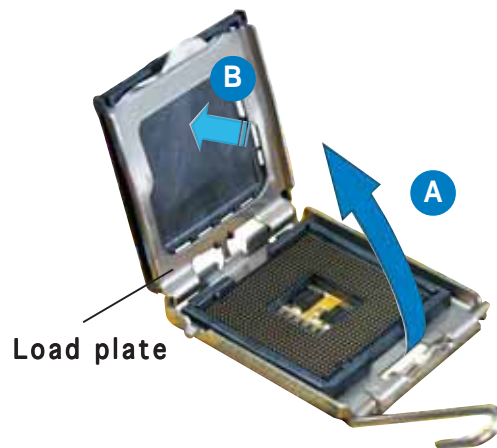

5. Position the CPU over the socket, making sure that the gold triangle is on the bottom-left corner of the socket. The socket alignment key should fit into the CPU notch.

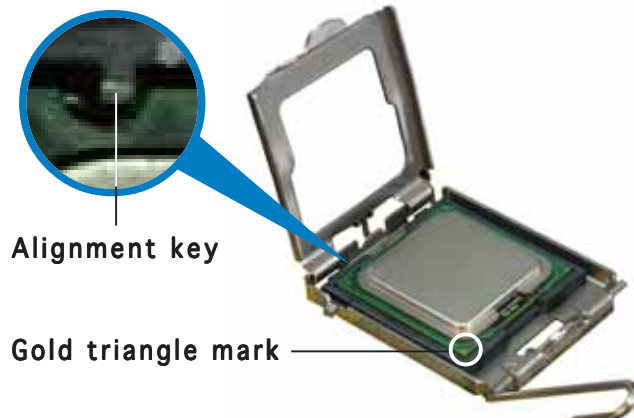



---

The CPU fits in only one correct orientation. DO NOT force the CPU into the socket to prevent bending the connectors on the socket and damaging the CPU!

---

6. Close the load plate (A), then push the load lever (B) until it snaps into the retention tab.



---

The motherboard supports Intel® Pentium® 4 LGA775 processors with the Intel® Enhanced Memory 64 Technology (EM64T), Enhanced Intel SpeedStep® Technology (EIST), and Hyper-Threading Technology. Refer to the Appendix for more information on these CPU features.

---

## 2.3.2 Installing the CPU heatsink and fan

The Intel® Pentium® 4 LGA775 processor requires a specially designed heatsink and fan assembly to ensure optimum thermal condition and performance.



- When you buy a boxed Intel® Pentium® 4 processor, the package includes the CPU fan and heatsink assembly. If you buy a CPU separately, make sure that you use only Intel®-certified multi-directional heatsink and fan.
- Your Intel® Pentium® 4 LGA775 heatsink and fan assembly comes in a push-pin design and requires no tool to install.
- If you purchased a separate CPU heatsink and fan assembly, make sure that you have properly applied Thermal Interface Material to the CPU heatsink or CPU before you install the heatsink and fan assembly.



Make sure that you have installed the motherboard to the chassis before you install the CPU fan and heatsink assembly.

To install the CPU heatsink and fan:

1. Place the heatsink on top of the installed CPU, making sure that the four fasteners match the holes on the motherboard.



Orient the heatsink and fan assembly such that the CPU fan cable is closest to the CPU fan connector.

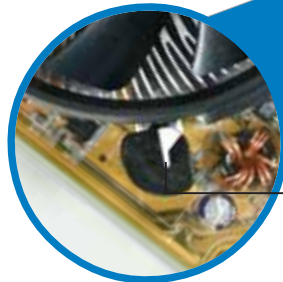

Narrow end  
of the groove

Fastener

Motherboard hole



Make sure to orient each fastener with the narrow end of the groove pointing outward. (The photo shows the groove shaded for emphasis.)

2. Push down two fasteners at a time in a diagonal sequence to secure the heatsink and fan assembly in place.

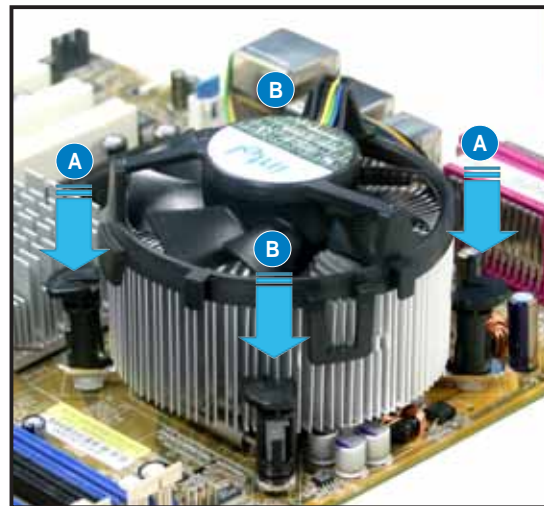
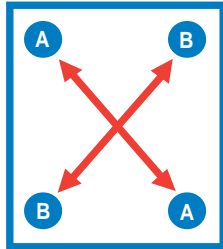

3. Connect the CPU fan cable to the connector on the motherboard labeled CPU\_FAN.

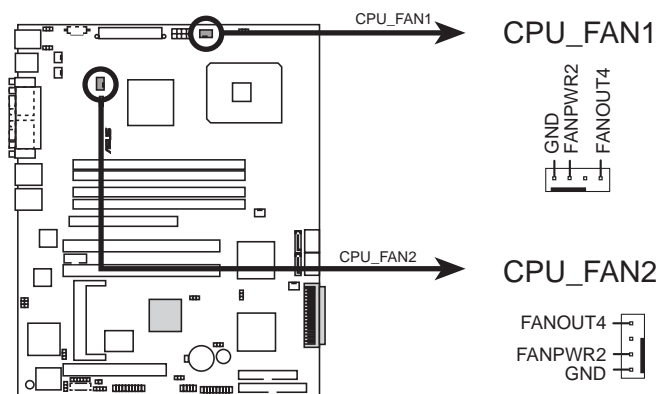

**P5MT Series CPU fan connectors**



Do not forget to connect the CPU fan connector! Hardware monitoring errors can occur if you fail to plug this connector.

### 2.3.3 Uninstalling the CPU heatsink and fan

To uninstall the CPU heatsink and fan:

1. Disconnect the CPU fan cable from the connector on the motherboard.
2. Rotate each fastener counterclockwise.



3. Pull up two fasteners at a time in a diagonal sequence to disengage the heatsink and fan assembly from the motherboard.

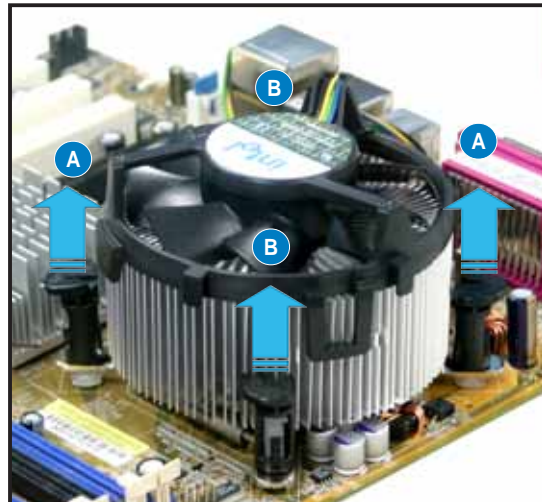
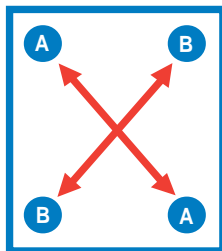

4. Carefully remove the heatsink and fan assembly from the motherboard.





## 2.4 System memory

### 2.4.1 Overview

The motherboard comes with four Double Data Rate II (DDR2) Dual Inline Memory Modules (DIMM) sockets to support 240-pin DDR modules.

The figure illustrates the location of the DDR DIMM sockets:

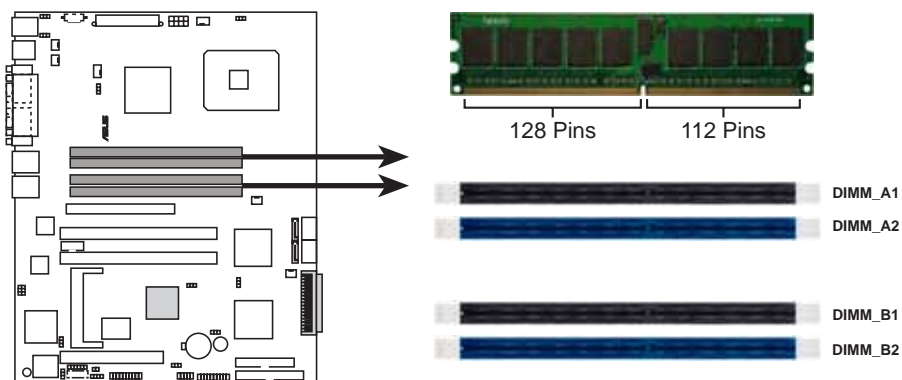

**P5MT Series 240-pin DDR2 DIMM sockets**

### 2.4.2 Memory configurations

You may install 256 MB, 512 MB, 1 GB, and 2 GB unbuffered ECC or non-ECC DDR2-533/667 DIMMs into the DIMM sockets.



- Always install DIMMs with the same CAS latency. For optimum compatibility, it is recommended that you obtain memory modules from the same vendor. Refer to the DDR2 Qualified Vendors List at the ASUS web site.
- When installing one or two DIMMs, install the DIMM(s) to the blue slots (DIMM\_A2/DIMM\_B2).
- Three DDR DIMMs installed into any three memory sockets will function in single-channel mode.

## 2.4.3 Installing a DIMM



Make sure to unplug the power supply before adding or removing DIMMs or other system components. Failure to do so may cause severe damage to both the motherboard and the components.

To install a DIMM:

1. Unlock a DIMM socket by pressing the retaining clips outward.
2. Align a DIMM on the socket such that the notch on the DIMM matches the break on the socket.
3. Firmly insert the DIMM into the socket until the retaining clips snap back in place and the DIMM is properly seated.

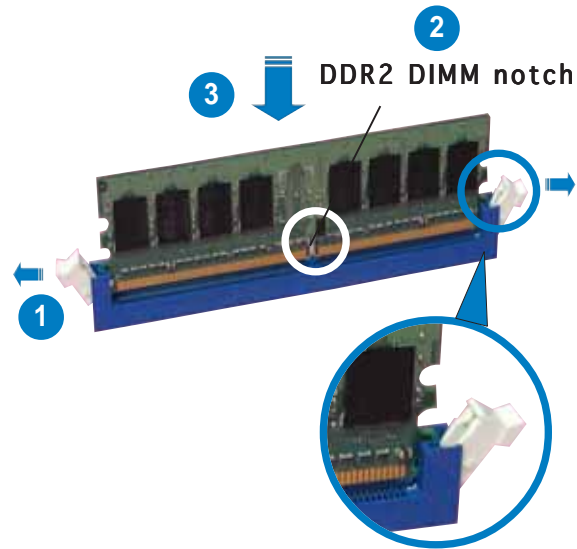

Unlocked retaining clip



- A DDR2 DIMM is keyed with a notch so that it fits in only one direction. Do not force a DIMM into a socket to avoid damaging the DIMM.
- The DDR2 DIMM sockets do not support DDR DIMMs. DO NOT install DDR DIMMs to the DDR2 DIMM sockets.

## 2.4.4 Removing a DIMM

Follow these steps to remove a DIMM.

1. Simultaneously press the retaining clips outward to unlock the DIMM.



Support the DIMM lightly with your fingers when pressing the retaining clips. The DIMM might get damaged when it flips out with extra force.

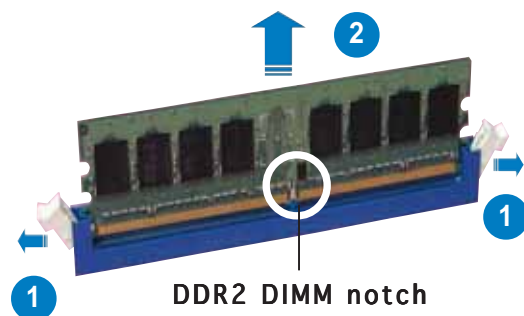

2. Remove the DIMM from the socket.

## 2.5 Expansion slots

In the future, you may need to install expansion cards. The following sub-sections describe the slots and the expansion cards that they support.



---

Make sure to unplug the power cord before adding or removing expansion cards. Failure to do so may cause you physical injury and damage motherboard components.

---

### 2.5.1 Installing an expansion card

To install an expansion card:

1. Before installing the expansion card, read the documentation that came with it and make the necessary hardware settings for the card.
2. Remove the system unit cover (if your motherboard is already installed in a chassis).
3. Remove the bracket opposite the slot that you intend to use. Keep the screw for later use.
4. Align the card connector with the slot and press firmly until the card is completely seated on the slot.
5. Secure the card to the chassis with the screw you removed earlier.
6. Replace the system cover.

### 2.5.2 Configuring an expansion card

After installing the expansion card, configure it by adjusting the software settings.

1. Turn on the system and change the necessary BIOS settings, if any. See Chapter 4 for information on BIOS setup.
2. Assign an IRQ to the card. Refer to the tables on the next page.
3. Install the software drivers for the expansion card.



---

When using PCI cards on shared slots, ensure that the drivers support “Share IRQ” or that the cards do not need IRQ assignments. Otherwise, conflicts will arise between the two PCI groups, making the system unstable and the card inoperable.

---

## 2.5.3 Interrupt assignments

### Standard interrupt assignments

IRQ	Priority	Standard Function
0	1	System Timer
1	2	Keyboard Controller
2	—	Re-direct to IRQ#9
3	11	Communications Port (COM2)*
4	12	Communications Port (COM1)*
5	13	IRQ holder for PCI steering*
6	14	Floppy Disk Controller
7	15	Printer Port (LPT1)*
8	3	System CMOS/Real Time Clock
9	4	IRQ holder for PCI steering*
10	5	IRQ holder for PCI steering*
11	6	IRQ holder for PCI steering*
12	7	PS/2 Compatible Mouse Port*
13	8	Numeric Data Processor
14	9	Primary IDE Channel
15	10	Secondary IDE Channel

\* These IRQs are usually available for ISA or PCI devices.

### PCI Bus Number, IDSEL, and IRQ assignments

Description	INTA	INTB	INTC	INTD	REQ#	GNT#
PATA Controller	PIRQA#	—	—	—	—	—
SATA Controller	PIRQD#	—	—	—	—	—
SMBus Controller	PIRQB#	—	—	—	—	—
USB1 UHCI Controller #1	PIRQH#	—	—	—	—	—
USB1 UHCI Controller #2	PIRQD#	—	—	—	—	—
USB 2.0 EHCI Controller	PIRQH#	—	—	—	—	—
BMC5721 #1	PIRQA#	—	—	—	—	—
BMC5721 #2	PIRQB#	—	—	—	—	—
ATI RAGE XL	PIRQD#	—	—	—	REQ1#	GNT1#
LSI 53C1020A (SCSI model)	PXIRQ2	—	—	—	X_REQ2	X_GNT2
PCI Express Slot 1 (x16)	PIRQA#	—	—	—	—	—
PCIX Slot 2 (64-bit)	PXIRQ0	PXIRQ1	PXIRQ2	PXIRQ3	X_REQ0	X_GNT0
PCIX Slot 3 (64-bit)	PXIRQ4	PXIRQ5	PXIRQ6	PXIRQ7	X_REQ1	X_GNT1
PCIX Slot 4 (32-bit)	PIRQE#	PIRQF#	PIRQG#	PIRQH#	REQ0#	GNT0#

## 2.5.4 PCI/PCI-X slots

The PCI and PCI-X slots support cards such as a LAN card, SCSI card, USB card, and other cards that comply with PCI/PCI-X specifications.

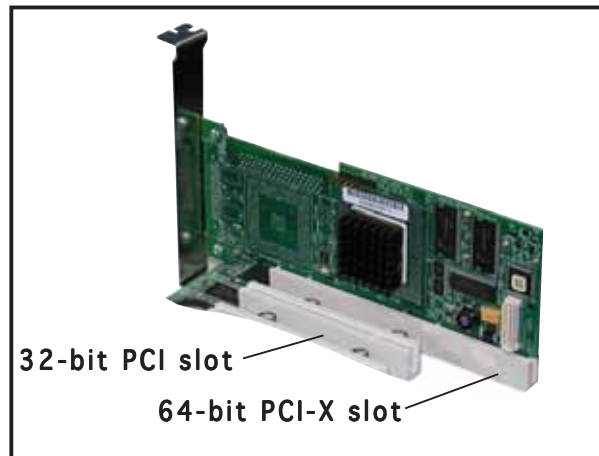

---

When installing an optional ZCR card, install the card on PCI\_X2 slot (colored green on P5MT/SCSI model).

---

## 2.5.5 PCI Express x16 slot

This motherboard supports PCI Express x16 I/O, and graphic cards that comply with the PCI Express specifications. The following figure shows a graphics card installed on the PCI Express x16 slot.



---

A PCI Express graphics card may run only at x1 speed due to chipset limitation. PCI Express I/O cards may only run at x8 or x4 speed.

---

## 2.6 Jumpers



The grayed out components in the illustrations may not be present in certain models.

### 1. Clear RTC RAM (CLRTC1)

This jumper allows you to clear the Real Time Clock (RTC) RAM in CMOS. You can clear the CMOS memory of date, time, and system setup parameters by erasing the CMOS RTC RAM data. The onboard button cell battery powers the RAM data in CMOS, which include system setup information such as system passwords.

To erase the RTC RAM:

1. Turn OFF the computer and unplug the power cord.
2. Remove the onboard battery.
3. Move the jumper cap from pins 1-2 (default) to pins 2-3. Keep the cap on pins 2-3 for about 5~10 seconds, then move the cap back to pins 1-2.
4. Re-install the battery.
5. Plug the power cord and turn ON the computer.
6. Hold down the <Del> key during the boot process and enter BIOS setup to re-enter data.



Except when clearing the RTC RAM, never remove the cap on CLRTC jumper default position. Removing the cap will cause system boot failure!

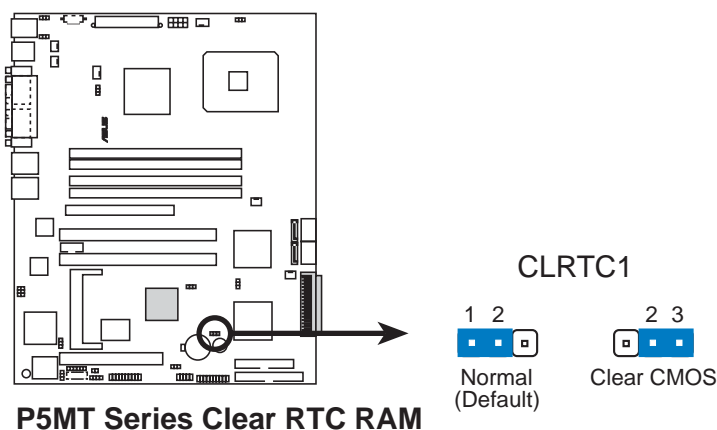

## 2. CPU fan pin selection (3-pin FM\_CPU1, FM\_CPU2)

These jumpers allow you to connect either a 3-pin or a 4-pin fan cable plug to the CPU fan connectors (CPU\_FAN1, CPU\_FAN2). Set these jumpers to pins 1-2 if you are using a 3-pin fan cable plug, or to pins 2-3 if you are using a 4-pin plug.

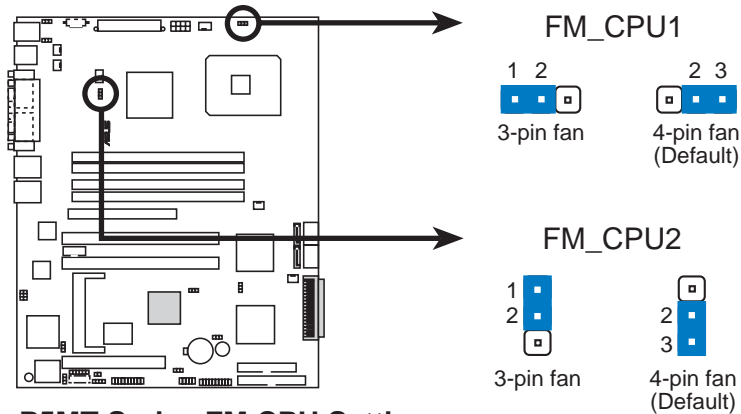

**P5MT Series FM CPU Setting**

## 3. USB device wake-up (3-pin USBPW12, USBPW34)

Set these jumpers to +5V to wake up the computer from S1 sleep mode (CPU stopped, DRAM refreshed, system running in low power mode) using the connected USB devices. Set to +5VSB to wake up from S4 sleep mode (no power to CPU, DRAM in slow refresh, power supply in reduced power mode).

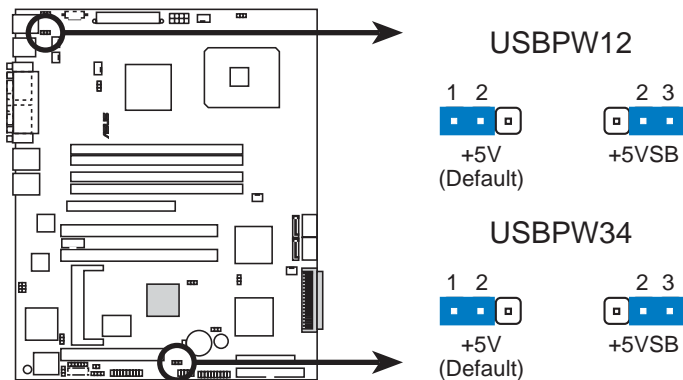

**P5MT Series USB device wake-up**



- The USB device wake-up feature requires a power supply that can provide 500mA on the +5VSB lead for each USB port; otherwise, the system would not power up.
- If you are using Windows 2000, you need to install Service Pack 4 to wake up the system from S4 sleep mode.
- The total current consumed must NOT exceed the power supply capability (+5VSB) whether under normal condition or in sleep mode.

#### 4. Keyboard power (3-pin KBPWR1)

This jumper allows you to enable or disable the keyboard wake-up feature. Set this jumper to pins 2-3 (+5VSB) to wake up the computer when you press a key on the keyboard (the default is the Space Bar). This feature requires an ATX power supply that can supply at least 1A on the +5VSB lead, and a corresponding setting in the BIOS.

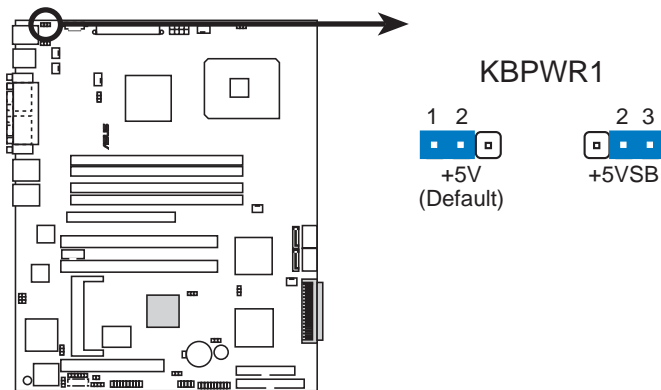

**P5MT Series Keyboard power setting**

#### 5. VGA controller setting (3-pin VGA\_EN1)

These jumpers allow you to enable or disable the onboard ATI® RAGE-XL PCI VGA controller. Set to pins 1-2 to activate the VGA feature.

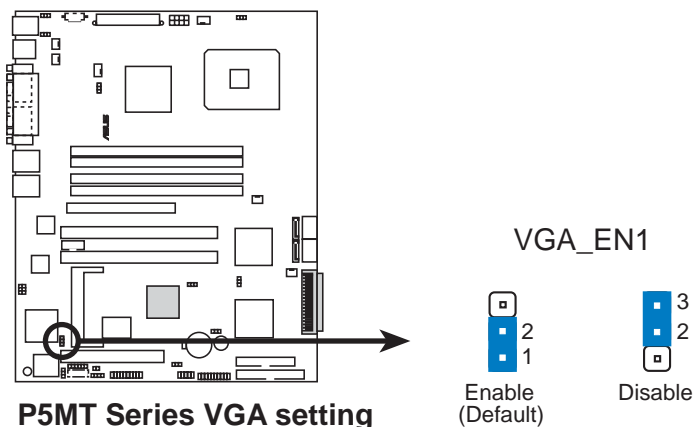

**P5MT Series VGA setting**



## 6. Gigabit LAN controller setting (3-pin LAN\_EN1, LAN\_EN2)

These jumpers allow you to enable or disable the onboard Broadcom® BCM5721 Gigabit LAN1 or LAN2 controller. Set to pins 1-2 to activate the Gigabit LAN controller.

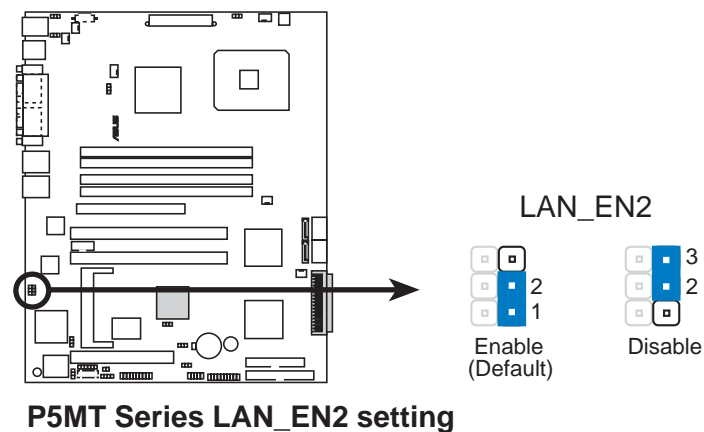
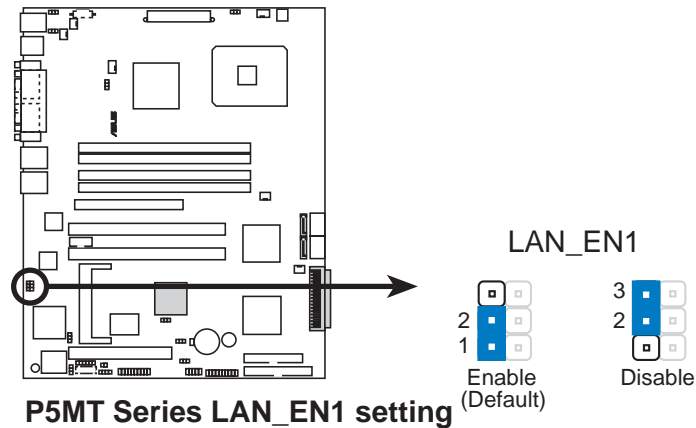

## 7. RAID controller selection (3-pin RAID\_SEL1)

This jumper allows you to select the RAID configuration utility to use when you create disk arrays. Place the jumper caps over pins 1-2 if you want to use the LSI Logic Embedded SATA RAID Setup Utility (default); otherwise, place the jumper caps to pins 2-3 to use the Intel® Matrix Storage Manager.

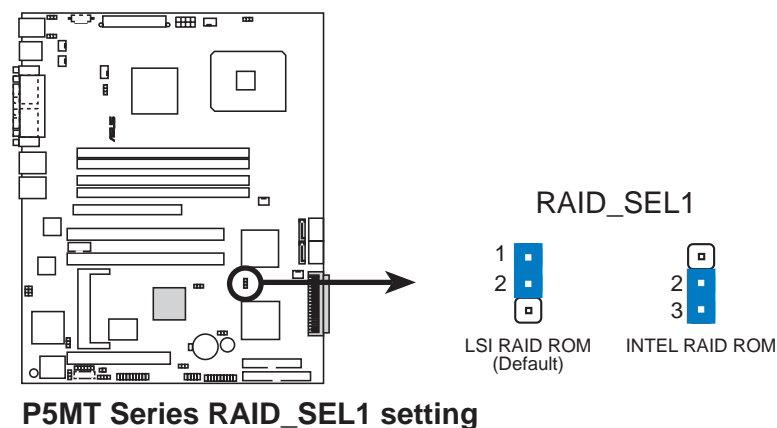

## 8. SCSI controller setting (3-pin SCSI\_EN1) (P5MT/SCSI model only)

This jumper allows you to enable or disable the onboard LSI 53C1020A PCI-X SCSI controller. Set to pins 1-2 to activate the SCSI feature, and support RAID configurations.

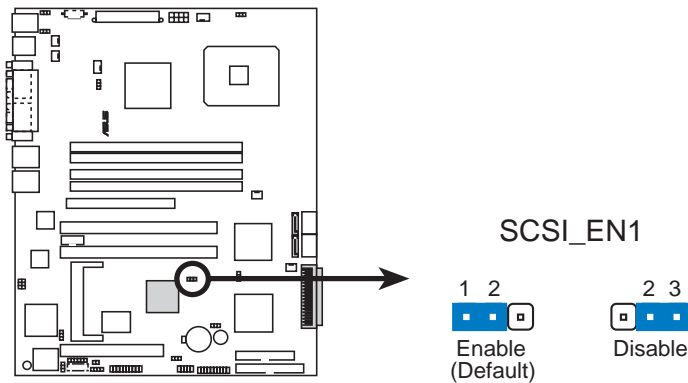

**P5MT Series SCSI\_EN1 setting**

## 9. Force BIOS recovery setting (3-pin RECOVERY1)

This jumper allows you to quickly update or recover the BIOS settings when it becomes corrupted.

To update the BIOS:

1. Prepare a floppy disk that contains the latest BIOS for the motherboard (xxxx-xxx.ROM) and the AFUDOS.EXE utility.
2. Set the jumper to pins 2-3.
3. Insert the floppy disk then turn on the system to update the BIOS.
4. Shut down the system.
5. Set the jumper back to pins 1-2.
6. Turn on the system.

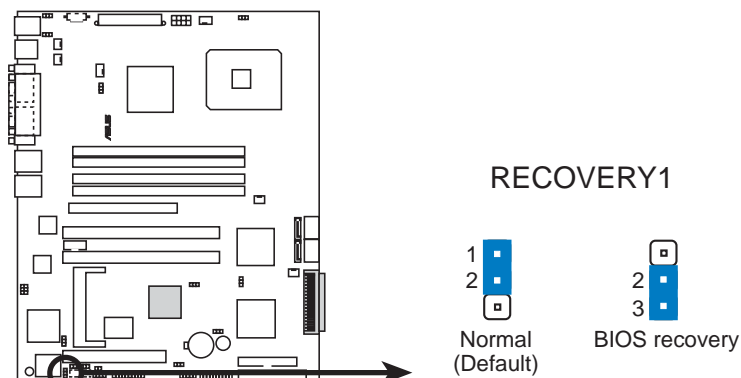

**P5MT Series BIOS recovery setting**

## 2.7 Connectors

### 2.7.1 Rear panel connectors

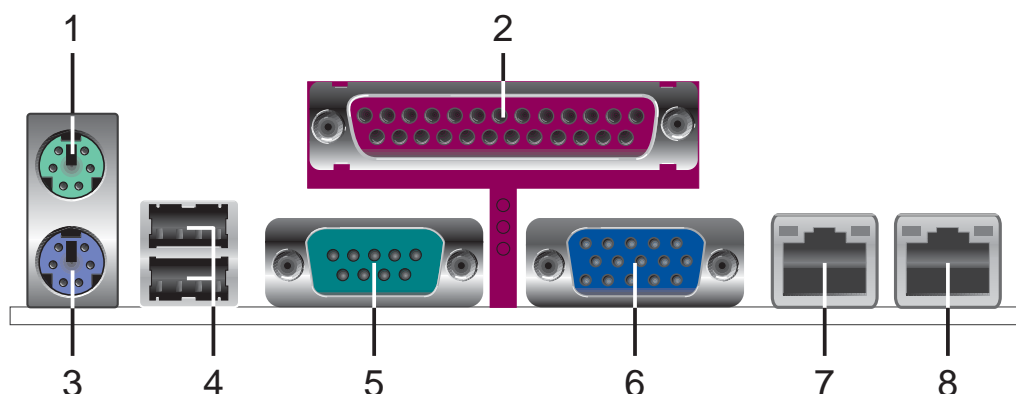

1. **PS/2 mouse port (green).** This port is for a PS/2 mouse.
2. **Parallel port.** This 25-pin port connects a parallel printer, a scanner, or other devices.
3. **PS/2 keyboard port (purple).** This port is for a PS/2 keyboard.
4. **USB 2.0 ports 1 and 2.** These two 4-pin Universal Serial Bus (USB) ports are available for connecting USB 2.0 devices.
5. **Serial (COM1) port.** This 9-pin communication port is for pointing devices or other serial devices.
6. **VGA port.** This port is for a VGA monitor or other VGA-compatible devices.
7. **Gigabit LAN1 (RJ-45) port.** This ports allow Gigabit connection to a Local Area Network (LAN) through a network hub. Refer to the table below for the LAN port LED indications.
8. **Gigabit LAN2 (RJ-45) port.** This ports allow Gigabit connection to a Local Area Network (LAN) through a network hub. Refer to the table below for the LAN port LED indications.

### LAN port LED indications

ACT/LINK LED		SPEED LED	
Status	Description	Status	Description
OFF	No link	OFF	10 Mbps connection
GREEN	Linked	ORANGE	100 Mbps connection
BLINKING	Data activity	GREEN	1000 Mbps connection

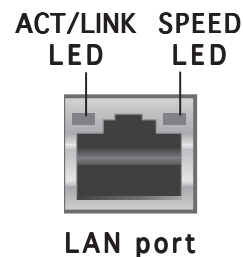

## 2.7.2 Internal connectors

### 1. Floppy disk drive connector (34-1 pin FLOPPY1)

This connector is for the provided floppy disk drive (FDD) signal cable. Insert one end of the cable to this connector, then connect the other end to the signal connector at the back of the floppy disk drive.



Pin 5 on the connector is removed to prevent incorrect cable connection when using a FDD cable with a covered Pin 5.

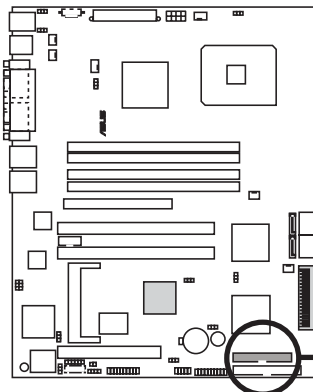

**NOTE:** Orient the red markings on the floppy ribbon cable to PIN 1.

**P5MT Series Floppy disk drive connector**

### 2. Primary IDE connector (40-1 pin PRI\_IDE1)

This connector is for an Ultra ATA100/66/33 signal cable. The Ultra ATA 100/66/33 signal cable has three connectors: a blue connector for the primary IDE connector on the motherboard, a black connector for an Ultra ATA 100/66/33 IDE slave device (optical drive/hard disk drive), and a gray connector for an Ultra ATA 100/66/33 IDE master device (hard disk drive). If you install two hard disk drives, you must configure the second drive as a slave device by setting its jumper accordingly. Refer to the hard disk documentation for the jumper settings.



- Pin 20 on the IDE connector is removed to match the covered hole on the Ultra ATA cable connector. This prevents incorrect insertion when you connect the IDE cable.
- Use the 80-conductor IDE cable for Ultra ATA 100/66/33 IDE devices.

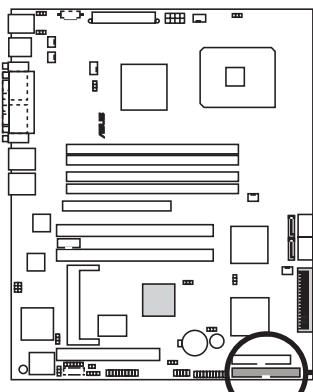

**NOTE:** Orient the red markings (usually zigzag) on the IDE ribbon cable to PIN 1.

**P5MT Series IDE connector**

### 3. Serial ATA connectors (7-pin SATA1, SATA2, SATA3, SATA4)

These connectors are for the Serial ATA signal cables for Serial ATA hard disk drives.

If you installed Serial ATA hard disk drives, you can create a RAID 0, RAID 1, RAID 0+1, and software RAID 5 configuration using the Intel® Matrix Storage Technology or RAID 0, RAID 1 and RAID 0+1 configuration using the LSI MegaRAID® utility embedded on the Intel® ICH7R Southbridge.



These connectors are set **IDE** mode by default. In **IDE** mode, you can connect Serial ATA boot/data hard disk drives to these connectors. If you intend to create a Serial ATA RAID set using these connectors, set the **Configure SATA as** item in the BIOS to [RAID]. See section “4.3.4 IDE Configuration” for details.

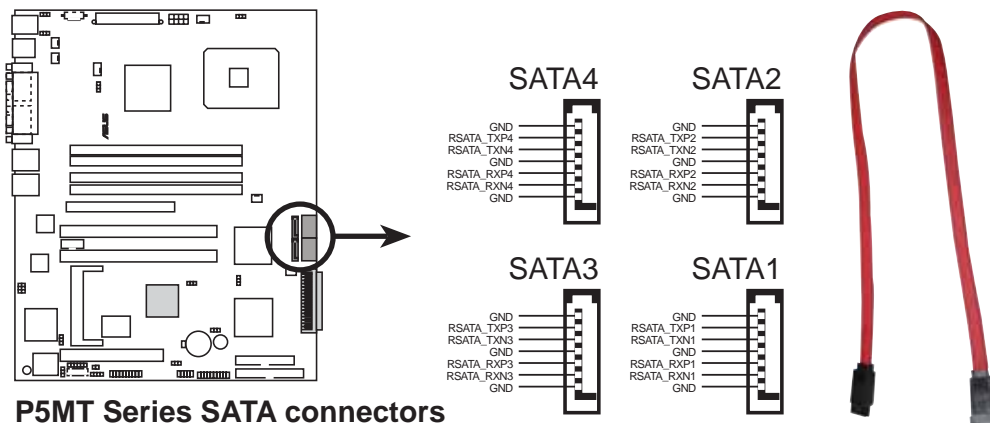

P5MT Series SATA connectors



#### Important notes on Serial ATA

- You must install Windows® 2000 Service Pack 4 or Windows® 2003 before using Serial ATA hard disk drives. The Serial ATA RAID feature (RAID 0/RAID 1) is available only if you are using Windows® 2000/2003.
- Use only two Serial ATA RAID connectors for each RAID 0 or RAID 1 set.
- When using the connectors in **IDE** mode, connect the primary (boot) hard disk drive to the SATA1 or SATA2 connector. Refer to the table below for the recommended SATA hard disk drive connections.

#### Serial ATA hard disk drive connection

Connector	Setting	Use
SATA1/SATA2	Master	Boot disk
SATA3/SATA4	Slave	Data disk

#### 4. Hard disk activity LED connector (4-pin HDLED1)

This connector supplies power to the hard disk activity LED. The read or write activities of any device connected to the SCSI connectors or the SATA connectors cause this LED to light up.

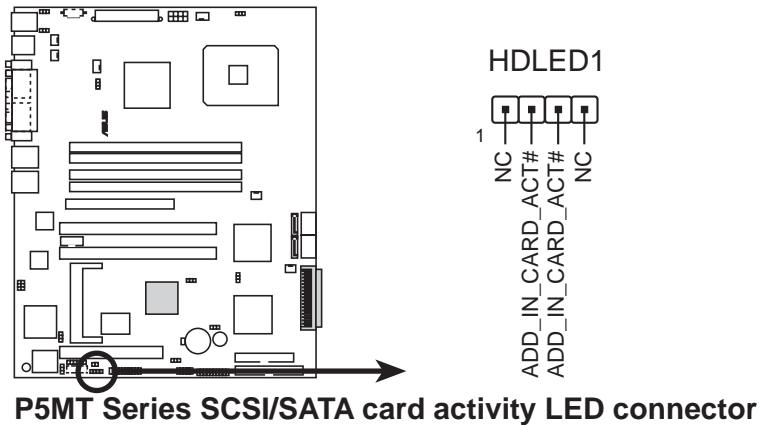

#### 5. USB connector (10-1 pin USB34)

This connector is for USB 2.0 ports. Connect the USB module cable to this connector, then install the module to a slot opening at the back of the system chassis. This USB connector complies with USB 2.0 specification that supports up to 480 Mbps connection speed.

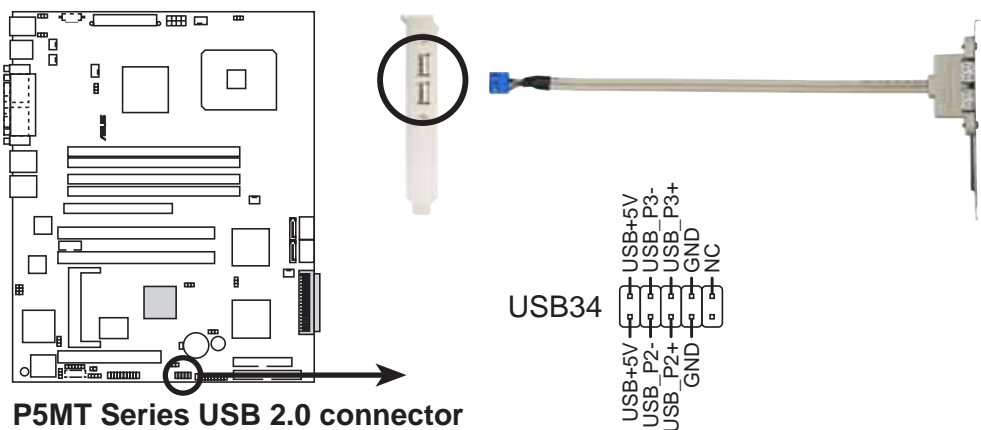

The USB port module is purchased separately.

## 6. Ultra320 SCSI connectors (one 68-pin SCSI A1) (P5MT/SCSI model only)

This motherboard comes with the LSI53C1020A PCI-X SCSI U320 controller that supports one 68-Pin Ultra320 SCSI connector. The SCSI channel can support a maximum of 15 SCSI devices as specified by Ultra320 standards.

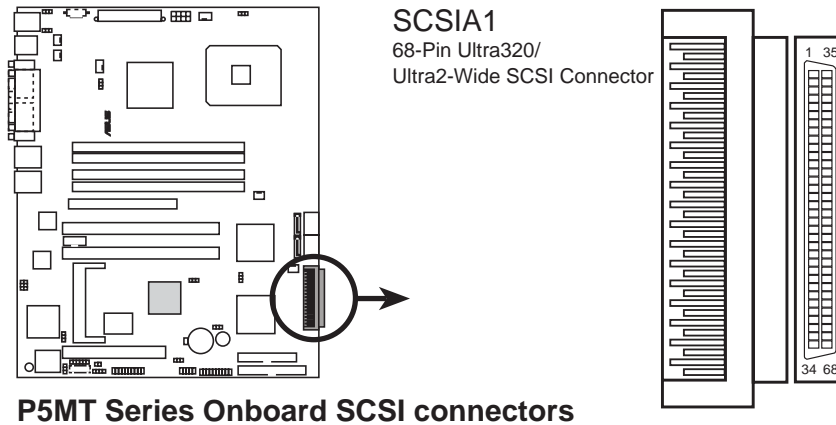

### SCSI Connection Notes

This motherboard has a 68-Pin Ultra320 SCSI connector.

The onboard SCSI chipset incorporates an advanced multimode I/O cell that supports both single-ended (SE), Ultra2, Ultra160, and Ultra320 devices. With Ultra320 devices, the SCSI bus platform performs at full Ultra320 speeds (up to 320MB/s) and extended cabling 12m (or 25m in a point-to-point configuration). When an SE device is attached, the bus defaults to an SE speed and 1.5m cable length.



---

Connect SCSI devices as specified. A SCSI channel should have only one type of SCSI standard (e.g. Ultra320, Ultra160, Ultra2, Ultra-Wide). Mixing SCSI devices on a single channel decreases performance of the slower device.

---

## 7. Serial port connector (10-1 pin COM2)

This connector is for a serial (COM) port. Connect the serial port module cable to this connector, then install the module to a slot opening at the back of the system chassis. The serial port module is purchased separately.

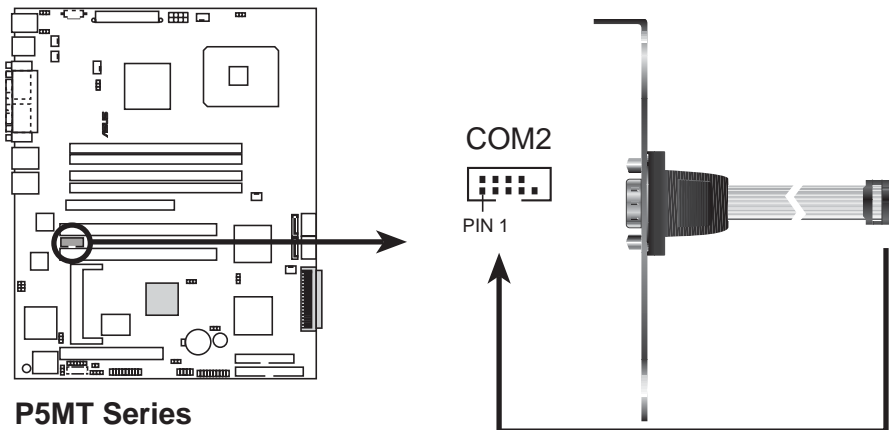

**P5MT Series  
Serial port2 (COM2) connector**

## 8. BMC connector (16-pin BMCCONN1)

This connector is for the ASUS server management card, if available.

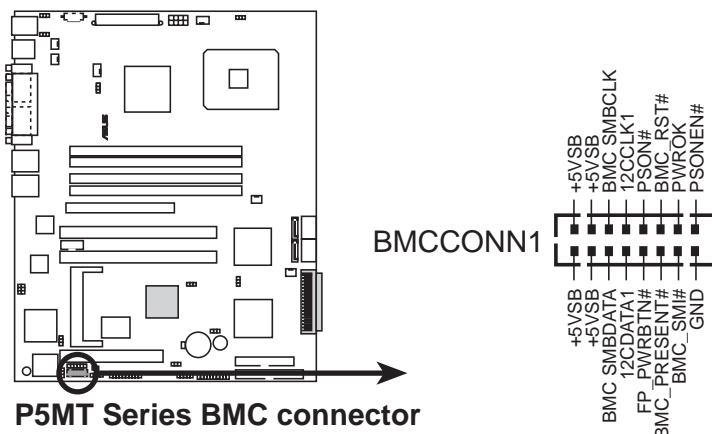

**P5MT Series BMC connector**

## 9. Ambient thermal sensor (2-pin TRPWR1)

If you want additional thermal monitoring, connect the thermal sensor cable with thermistor (of 1°K or at 25°C, B=3435) to this connector.

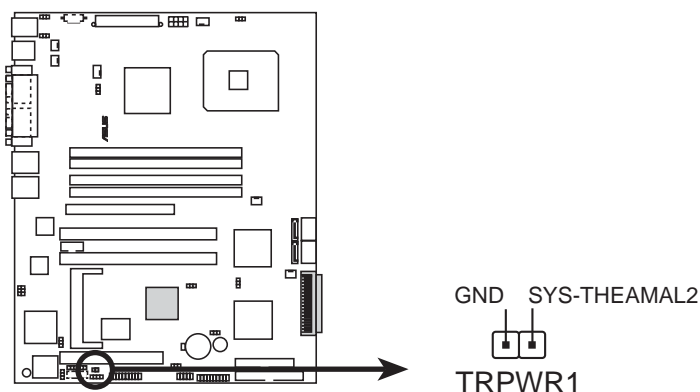

**P5MT Series TRPWR connector**



## 10. CPU and system fan connectors (3-pin CPU\_FAN1/2, REAR\_FAN1/2, FRNT\_FAN1/2)

The fan connectors support cooling fans of 350 mA ~ 740 mA (8.88 W max.) or a total of 2.1 A ~ 4.44 A (53.28 W max.) at +12V. Connect the fan cables to the fan connectors on the motherboard, making sure that the black wire of each cable matches the ground pin of the connector.



Do not forget to connect the fan cables to the fan connectors. Insufficient air flow inside the system may damage the motherboard components. These are not jumpers! Do not place jumper caps on the fan connectors!

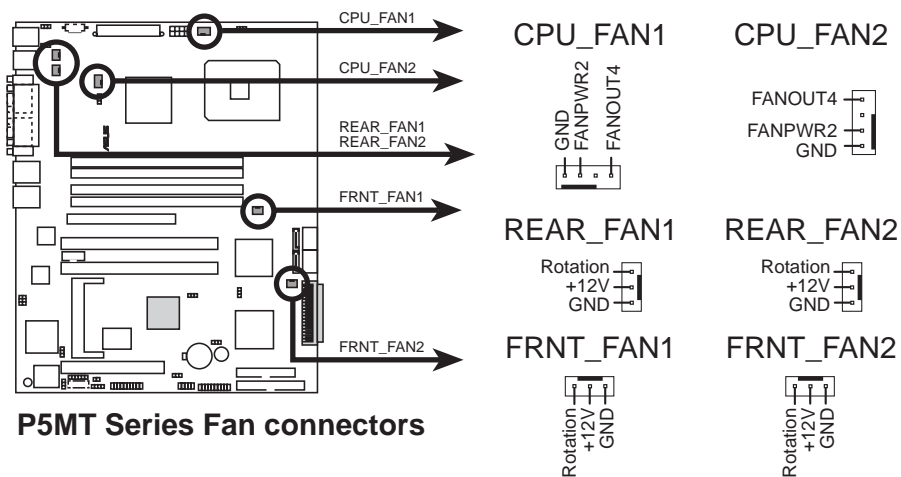

## 11. Backplane SMBus connector (6-1 pin BPSMB1)

This connector allows you to connect SMBus (System Management Bus) devices. Devices communicate with an SMBus host and/or other SMBus devices using the SMBus interface.

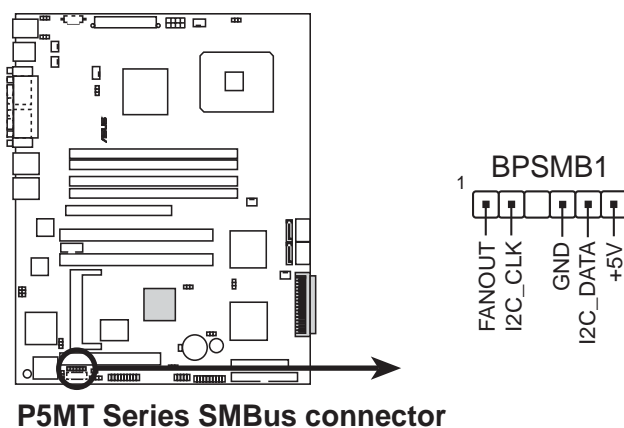

## 12. Power supply SMBus connector (5-pin PSUSMB1)

This connector is for the power supply SMB cable, if your power supply supports the SMBus function.

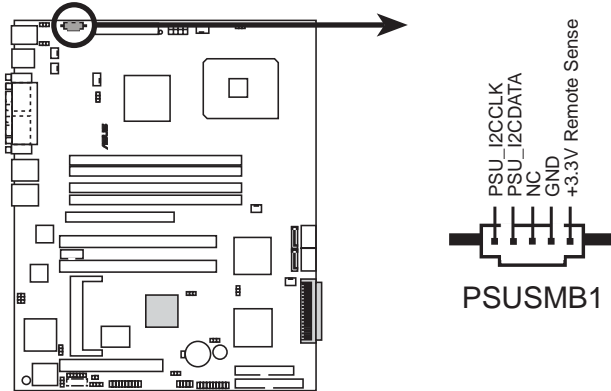

**P5MT Series Power supply SMBus connector**

## 13. SSI power connectors (24-pin ATXPWR1, 8-pin ATX12V2)

These connectors are for SSI power supply plugs. The power supply plugs are designed to fit these connectors in only one orientation. Find the proper orientation and push down firmly until the connectors completely fit.



- Use of an SSI 12 V Specification 2.0-compliant power supply unit (PSU) that provides a minimum power of 450 W is recommended for a fully-configured system.
- By default, four ATX12V2 connector pins are covered to prevent incorrect insertion of a 4-pin ATX +12V power plug. Remove this cover when using a PSU with an 8-pin ATX +12V power plug.
- Do not forget to connect the 4-pin or 8-pin ATX +12 V power plug; otherwise, the system will not boot up.
- Use of a PSU with a higher power output is recommended when configuring a system with more power consuming devices. The system may become unstable or may not boot up if the power is inadequate.
- You must install a PSU with a higher power rating if you intend to install additional devices.

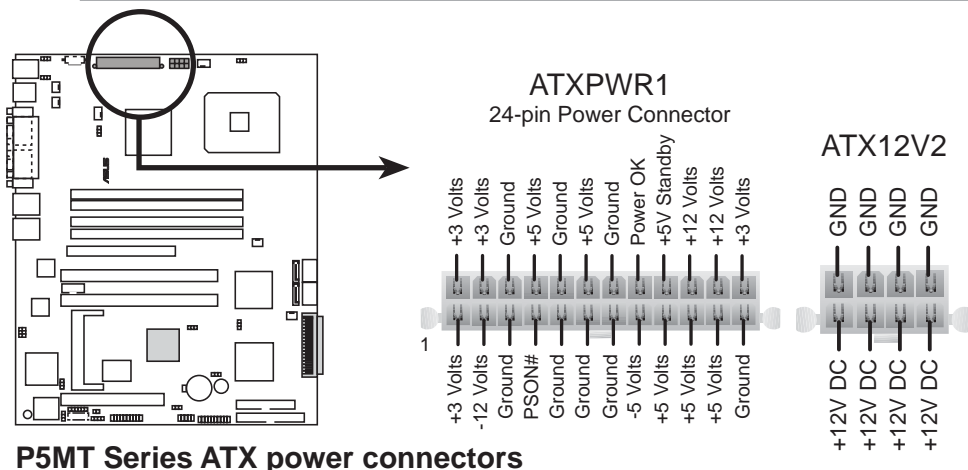

**P5MT Series ATX power connectors**

## 14. System panel connector (20-pin PANEL1)

This connector supports several chassis-mounted functions.

- **System power LED (Green 3-pin PLED)**  
This 3-pin connector is for the system power LED. Connect the chassis power LED cable to this connector. The system power LED lights up when you turn on the system power, and blinks when the system is in sleep mode.
- **Hard disk drive activity LED (Red 2-pin IDE\_LED)**  
This 2-pin connector is for the HDD Activity LED. Connect the HDD Activity LED cable to this connector. The IDE LED lights up or flashes when data is read from or written to the HDD.
- **System warning speaker (Orange 4-pin SPEAKER)**  
This 4-pin connector is for the chassis-mounted system warning speaker. The speaker allows you to hear system beeps and warnings.
- **ATX power button/soft-off button (Light Green 2-pin PWRSW)**  
This connector is for the system power button. Pressing the power button turns the system on or puts the system in sleep or soft-off mode depending on the BIOS settings. Pressing the power switch for more than four seconds while the system is ON turns the system OFF.
- **Reset button (Blue 2-pin RESET)**  
This 2-pin connector is for the chassis-mounted reset button for system reboot without turning off the system power.

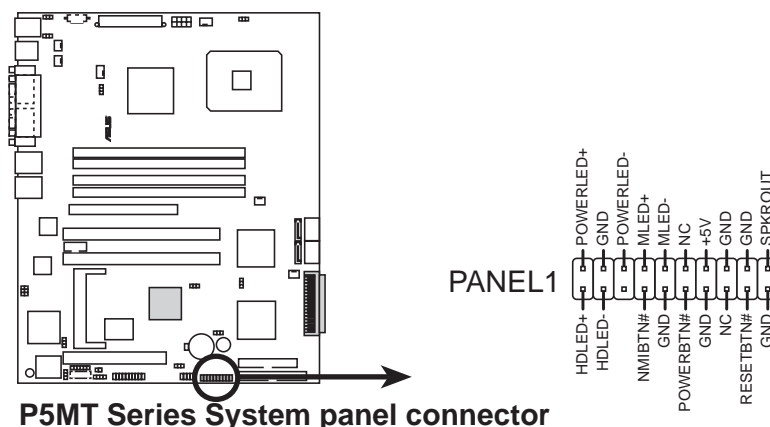

**P5MT Series System panel connector**



The system panel connector is color-coded for easy connection.

## 15. Auxiliary panel connector (20-pin AUX\_PANEL1)

This connector is for additional front panel features including front panel SMB, locator LED and switch, chassis intrusion, and LAN LEDs.

- **Front panel SMB (6-1 pin FPSMB)**  
These leads connect the front panel SMBus cable.
- **LAN activity LED (2-pin LAN1\_LED, LAN2\_LED)**  
These leads are for Gigabit LAN activity LEDs on the front panel.
- **Chassis intrusion (2-pin CHASSIS)**  
These leads are for the intrusion detection feature for chassis with intrusion sensor or microswitch. When you remove any chassis component, the sensor triggers and sends a high-level signal to these leads to record a chassis intrusion event.
- **Locator LED (6-pin LOCATOR)**  
These leads are for the locator switch and LED on the front panel.

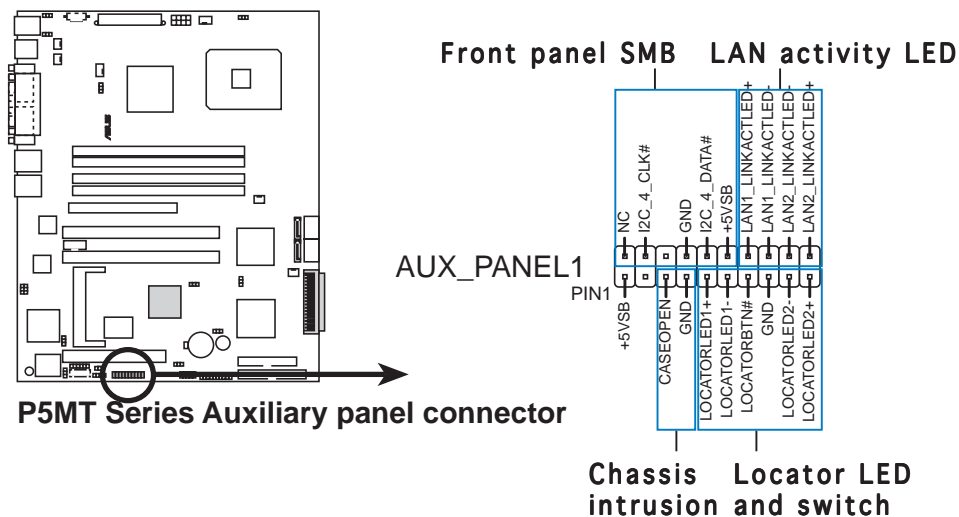

This chapter describes the power up sequence, and ways of shutting down the system.

# Powering up

## Chapter summary

# 3

3.1	Starting up for the first time .....	3-1
3.2	Powering off the computer .....	3-2

## 3.1 Starting up for the first time

1. After making all the connections, replace the system case cover.
2. Be sure that all switches are off.
3. Connect the power cord to the power connector at the back of the system chassis.
4. Connect the power cord to a power outlet that is equipped with a surge protector.
5. Turn on the devices in the following order:
  - a. Monitor
  - b. External SCSI devices (starting with the last device on the chain)
  - c. System power
6. After applying power, the system power LED on the system front panel case lights up. For systems with ATX power supplies, the system LED lights up when you press the ATX power button. If your monitor complies with “green” standards or if it has a “power standby” feature, the monitor LED may light up or switch between orange and green after the system LED turns on.

The system then runs the power-on self tests or POST. While the tests are running, the BIOS beeps (see BIOS beep codes table below) or additional messages appear on the screen. If you do not see anything within 30 seconds from the time you turned on the power, the system may have failed a power-on test. Check the jumper settings and connections or call your retailer for assistance.

### AMI BIOS beep codes

Beep Description	Error
One beep	Keyboard controller error Refresh Time error No master drive detected
Two continuous beeps followed by two short beeps	Floppy controller failure
Two continuous beeps followed by four short beeps	Hardware component failure

7. At power on, hold down the <Delete> key to enter the BIOS Setup. Follow the instructions in Chapter 4.

## 3.2 Powering off the computer

### 3.2.1 Using the OS shut down function

If you are using Windows® 2000:

1. Click the **Start** button then click **Shut Down...**
2. Make sure that the **Shut Down** option button is selected, then click the **OK** button to shut down the computer.
3. The power supply should turn off after Windows® shuts down.

If you are using Windows® XP:

1. Click the **Start** button then select **Turn Off Computer.**
2. Click the **Turn Off** button to shut down the computer.
3. The power supply should turn off after Windows® shuts down.

### 3.2.2 Using the dual function power switch

While the system is ON, pressing the power switch for less than four seconds puts the system to sleep mode or to soft-off mode, depending on the BIOS setting. Pressing the power switch for more than four seconds lets the system enter the soft-off mode regardless of the BIOS setting. Refer to section “4.5 Power Menu” in Chapter 4 for details.



This chapter tells how to change the system settings through the BIOS Setup menus. Detailed descriptions of the BIOS parameters are also provided.

# BIOS setup

4.1	Managing and updating your BIOS .....	4-1
4.2	BIOS setup program .....	4-10
4.3	Main menu .....	4-13
4.4	Advanced menu .....	4-18
4.5	Power menu .....	4-28
4.6	Boot menu .....	4-33
4.7	Exit menu .....	4-38

## 4.1 Managing and updating your BIOS

The following utilities allow you to manage and update the motherboard Basic Input/Output System (BIOS) setup.

1. **ASUS AFUDOS** (Updates the BIOS in DOS mode using a bootable floppy disk.)
2. **ASUS CrashFree BIOS 2** (Updates the BIOS using a bootable floppy disk or the motherboard support CD when the BIOS file fails or gets corrupted.)
3. **ASUS Update** (Updates the BIOS in Windows® environment.)

Refer to the corresponding sections for details on these utilities.



---

Save a copy of the original motherboard BIOS file to a bootable floppy disk in case you need to restore the BIOS in the future. Copy the original motherboard BIOS using the ASUS Update or AFUDOS utilities.

---

### 4.1.1 Creating a bootable floppy disk

1. Do either one of the following to create a bootable floppy disk.

#### *DOS environment*

- a. Insert a 1.44MB floppy disk into the drive.
- b. At the DOS prompt, type **format A:/S** then press <Enter>.

#### *Windows® XP environment*

- a. Insert a 1.44 MB floppy disk to the floppy disk drive.
  - b. Click **Start** from the Windows® desktop, then select **My Computer**.
  - c. Select the 3 1/2 Floppy Drive icon.
  - d. Click **File** from the menu, then select **Format**. A **Format 3 1/2 Floppy Disk** window appears.
  - e. **Windows® XP users:** Select **Create an MS-DOS startup disk** from the format options field, then click **Start**.
2. Copy the original or the latest motherboard BIOS file to the bootable floppy disk.

## 4.1.2 AFUDOS utility

The AFUDOS utility allows you to update the BIOS file in DOS environment using a bootable floppy disk with the updated BIOS file. This utility also allows you to copy the current BIOS file that you can use as backup when the BIOS fails or gets corrupted during the updating process.

### Copying the current BIOS

To copy the current BIOS file using the AFUDOS utility:



- 
- Make sure that the floppy disk is not write-protected and has at least 1024 KB free space to save the file.
  - The succeeding BIOS screens are for reference only. The actual BIOS screen displays may not be the same as shown.
- 

1. Copy the AFUDOS utility (afudos.exe) from the motherboard support CD to the bootable floppy disk you created earlier.
2. Boot the system in DOS mode, then at the prompt type:

```
afudos /o[filename]
```

where the [filename] is any user-assigned filename not more than eight alphanumeric characters for the main filename and three alphanumeric characters for the extension name.

```
A:\>afudos /oOLDBIOS1.rom
```

Main filename      Extension name

3. Press <Enter>. The utility copies the current BIOS file to the floppy disk.

```
A:\>afudos /oOLDBIOS1.rom
AMI Firmware Update Utility - Version 1.19(ASUS V2.07(03.11.24BB))
Copyright (C) 2002 American Megatrends, Inc. All rights reserved.
  Reading flash ..... done
  Write to file..... ok
A:\>
```

The utility returns to the DOS prompt after copying the current BIOS file.

## Updating the BIOS file

To update the BIOS file using the AFUDOS utility:

1. Visit the ASUS website ([www.asus.com](http://www.asus.com)) and download the latest BIOS file for the motherboard. Save the BIOS file to a bootable floppy disk.



---

Write the BIOS filename on a piece of paper. You need to type the exact BIOS filename at the DOS prompt.

---

2. Copy the AFUDOS utility (afudos.exe) from the motherboard support CD to the bootable floppy disk you created earlier.
3. Boot the system in DOS mode, then at the prompt type:

```
afudos /i[filename] /pbnc
```

where [filename] is the latest or the original BIOS file on the bootable floppy disk.

```
A:\>afudos /iP5MT.rom
```



---

Use the appropriate BIOS file depending on your motherboard model (e.g. P5MT.ROM or P5MTSCSI.ROM)

---

4. The utility verifies the file and starts updating the BIOS.

```
A:\>afudos /iP5MT.ROM
AMI Firmware Update Utility - Version 1.19 (ASUS V2.07(03.11.24BB))
Copyright (C) 2002 American Megatrends, Inc. All rights reserved.

WARNING!! Do not turn off power during flash BIOS
Reading file ..... done
Reading flash ..... done

Advance Check .....
Erasing flash ..... done
Writing flash ..... 0x0008CC00 (9%)
```



---

Do not shut down or reset the system while updating the BIOS to prevent system boot failure!

---

5. The utility returns to the DOS prompt after the BIOS update process is completed. Reboot the system from the hard disk drive.

```
A:\>afudos /iP5MT.ROM
AMI Firmware Update Utility - Version 1.19(ASUS V2.07(03.11.24BB))
Copyright (C) 2002 American Megatrends, Inc. All rights reserved.

WARNING!! Do not turn off power during flash BIOS
Reading file ..... done
Reading flash ..... done

Advance Check .....
Erasing flash ..... done
Writing flash ..... done
Verifying flash .... done

Please restart your computer

A:\>
```

### 4.1.3 ASUS CrashFree BIOS 2 utility

The ASUS CrashFree BIOS 2 is an auto recovery tool that allows you to restore the BIOS file when it fails or gets corrupted during the updating process. You can update a corrupted BIOS file using the motherboard support CD or the floppy disk that contains the updated BIOS file.



- Prepare the motherboard support CD or the floppy disk containing the updated motherboard BIOS before using this utility.
- Make sure that you rename the original or updated BIOS file in the floppy disk according the exact name of your motherboard, e.g. **P5MT.ROM** or **P5MTSCSI.ROM**.

### Recovering the BIOS from a floppy disk

To recover the BIOS from a floppy disk:

1. Turn on the system.
2. Insert the floppy disk with the original or updated BIOS file to the floppy disk drive.
3. The utility displays the following message and automatically checks the floppy disk for the original or updated BIOS file.

```
Bad BIOS checksum. Starting BIOS recovery...
Checking for floppy...
```

When found, the utility reads the BIOS file and starts flashing the corrupted BIOS file.

```
Bad BIOS checksum. Starting BIOS recovery...
Checking for floppy...
Floppy found!
Reading file "P5MT.ROM". Completed.
Start flashing...
```



DO NOT shut down or reset the system while updating the BIOS! Doing so can cause system boot failure!

4. Restart the system after the utility completes the updating process.

## Recovering the BIOS from the support CD

To recover the BIOS from the support CD:

1. Remove any floppy disk from the floppy disk drive, then turn on the system.
2. Insert the support CD to the optical drive.
3. The utility displays the following message and automatically checks the floppy disk for the original or updated BIOS file.

```
Bad BIOS checksum. Starting BIOS recovery...  
Checking for floppy...
```

When no floppy disk is found, the utility automatically checks the optical drive for the original or updated BIOS file. The utility then updates the corrupted BIOS file.

```
Bad BIOS checksum. Starting BIOS recovery...  
Checking for floppy...  
Floppy not found!  
Checking for CD-ROM...  
CD-ROM found!  
Reading file "P5MT.ROM". Completed.  
Start flashing...
```



---

DO NOT shut down or reset the system while updating the BIOS! Doing so can cause system boot failure!

---

4. Restart the system after the utility completes the updating process.



---

The recovered BIOS may not be the latest BIOS version for this motherboard. Visit the ASUS website ([www.asus.com](http://www.asus.com)) to download the latest BIOS file.

---



## 4.1.4 ASUS Update utility

The ASUS Update is a utility that allows you to manage, save, and update the motherboard BIOS in Windows® environment. The ASUS Update utility allows you to:

- Save the current BIOS file
- Download the latest BIOS file from the Internet
- Update the BIOS from an updated BIOS file
- Update the BIOS directly from the Internet, and
- View the BIOS version information.

This utility is available in the support CD that comes with the motherboard package.



---

ASUS Update requires an Internet connection either through a network or an Internet Service Provider (ISP).

---

## Installing ASUS Update

To install ASUS Update:

1. Place the support CD in the optical drive. The **Drivers** menu appears.
2. Click the **Utilities** tab, then click **Install ASUS Update VX.XX.XX**.
3. The ASUS Update utility is copied to your system.



---

Quit all Microsoft® Windows® applications before you update the BIOS using this utility.

---

## Updating the BIOS through the Internet

To update the BIOS through the Internet:

1. Launch the ASUS Update utility from the Windows® desktop by clicking **Start > Programs > ASUS > ASUSUpdate > ASUSUpdate**. The ASUS Update main window appears.

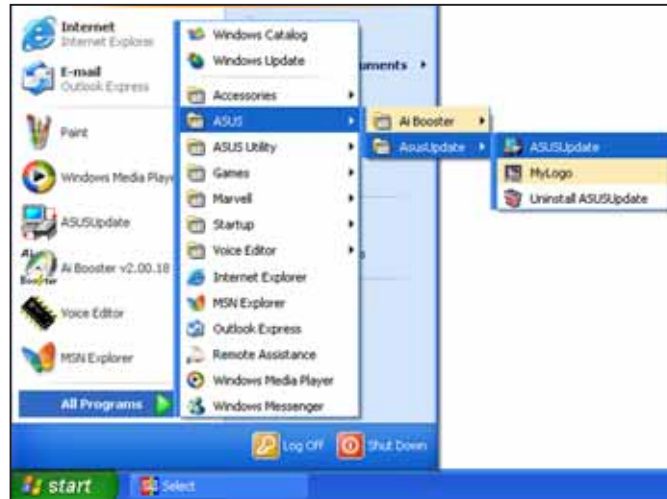

2. Select **Update BIOS from the Internet** option from the drop-down menu, then click **Next**.
3. Select the ASUS FTP site nearest you to avoid network traffic, or click **Auto Select**. Click **Next**.

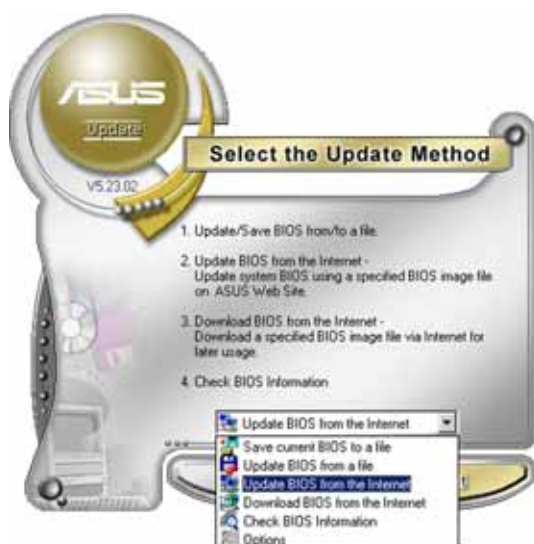

- From the FTP site, select the BIOS version that you wish to download. Click Next.
- Follow the screen instructions to complete the update process.



The ASUS Update utility is capable of updating itself through the Internet. Always update the utility to avail all its features.



## Updating the BIOS through a BIOS file

To update the BIOS through a BIOS file:

- Launch the ASUS Update utility from the Windows® desktop by clicking **Start > Programs > ASUS > ASUSUpdate > ASUSUpdate**. The ASUS Update main window appears.
- Select **Update BIOS from a file** option from the drop-down menu, then click **Next**.



- Locate the BIOS file from the **Open** window, then click **Save**.
- Follow the screen instructions to complete the update process.

## 4.2 BIOS setup program

This motherboard supports a programmable firmware chip that you can update using the provided utility described in section “4.1 Managing and updating your BIOS.”

Use the BIOS Setup program when you are installing a motherboard, reconfiguring your system, or prompted to “Run Setup”. This section explains how to configure your system using this utility.

Even if you are not prompted to use the Setup program, you can change the configuration of your computer in the future. For example, you can enable the security password feature or change the power management settings. This requires you to reconfigure your system using the BIOS Setup program so that the computer can recognize these changes and record them in the CMOS RAM of the firmware hub.

The firmware hub on the motherboard stores the Setup utility. When you start up the computer, the system provides you with the opportunity to run this program. Press <Del> during the Power-On-Self-Test (POST) to enter the Setup utility; otherwise, POST continues with its test routines.

If you wish to enter Setup after POST, restart the system by pressing <Ctrl+Alt+Delete>, or by pressing the reset button on the system chassis. You can also restart by turning the system off and then back on. Do this last option only if the first two failed.

The Setup program is designed to make it as easy to use as possible. Being a menu-driven program, it lets you scroll through the various sub-menus and make your selections from the available options using the navigation keys.



- 
- The default BIOS settings for this motherboard apply for most conditions to ensure optimum performance. If the system becomes unstable after changing any BIOS settings, load the default settings to ensure system compatibility and stability. Select the **Load Setup Defaults** item under the Exit Menu. See section “4.7 Exit Menu.”
  - The BIOS setup screens shown in this section are for reference purposes only, and may not exactly match what you see on your screen.
  - Visit the ASUS website ([www.asus.com](http://www.asus.com)) to download the latest BIOS file for this motherboard.
-

## 4.2.1 BIOS menu screen

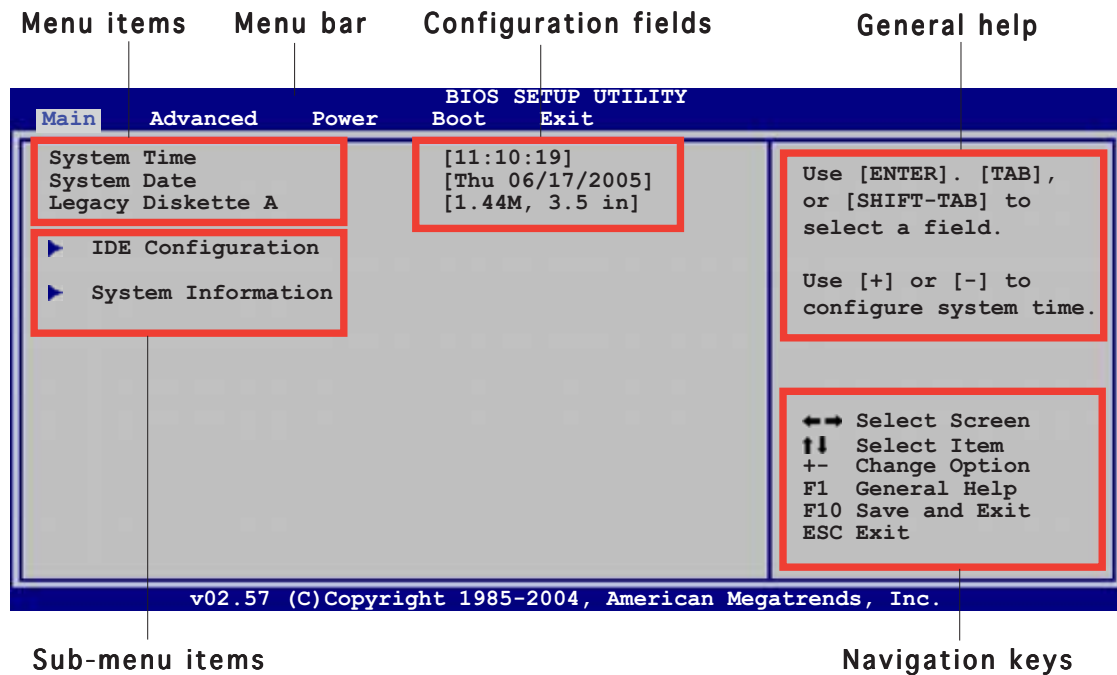

## 4.2.2 Menu bar

The menu bar on top of the screen has the following main items:

- Main** For changing the basic system configuration
- Advanced** For changing the advanced system settings
- Power** For changing the advanced power management (APM) configuration
- Boot** For changing the system boot configuration
- Exit** For selecting the exit options and loading default settings

To select an item on the menu bar, press the right or left arrow key on the keyboard until the desired item is highlighted.

## 4.2.3 Navigation keys

At the bottom right corner of a menu screen are the navigation keys for that particular menu. Use the navigation keys to select items in the menu and change the settings.



Some of the navigation keys differ from one screen to another.

## 4.2.4 Menu items

The highlighted item on the menu bar displays the specific items for that menu. For example, selecting **Main** shows the Main menu items.

The other items (Advanced, Power, Boot, and Exit) on the menu bar have their respective menu items.

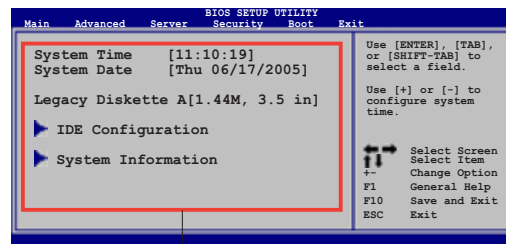

Main menu items

## 4.2.5 Sub-menu items

A solid triangle before each item on any menu screen means that the item has a sub-menu. To display the sub-menu, select the item and press <Enter>.

## 4.2.6 Configuration fields

These fields show the values for the menu items. If an item is user-configurable, you can change the value of the field opposite the item. You cannot select an item that is not user-configurable.

A configurable field is enclosed in brackets, and is highlighted when selected. To change the value of a field, select it then press <Enter> to display a list of options. Refer to “4.2.7 Pop-up window.”

## 4.2.7 Pop-up window

Select a menu item then press <Enter> to display a pop-up window with the configuration options for that item.

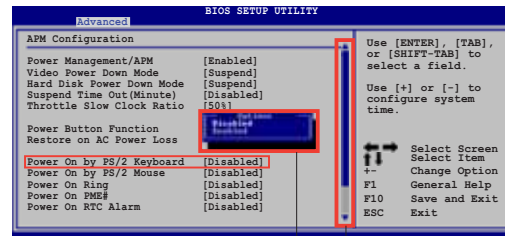

Pop-up window

Scroll bar

## 4.2.8 Scroll bar

A scroll bar appears on the right side of a menu screen when there are items that do not fit on the screen. Press the Up/Down arrow keys or <Page Up> / <Page Down> keys to display the other items on the screen.

## 4.2.9 General help

At the top right corner of the menu screen is a brief description of the selected item.

## 4.3 Main menu

When you enter the BIOS Setup program, the **Main** menu screen appears, giving you an overview of the basic system information.



Refer to section “4.2.1 BIOS menu screen” for information on the menu screen items and how to navigate through them.

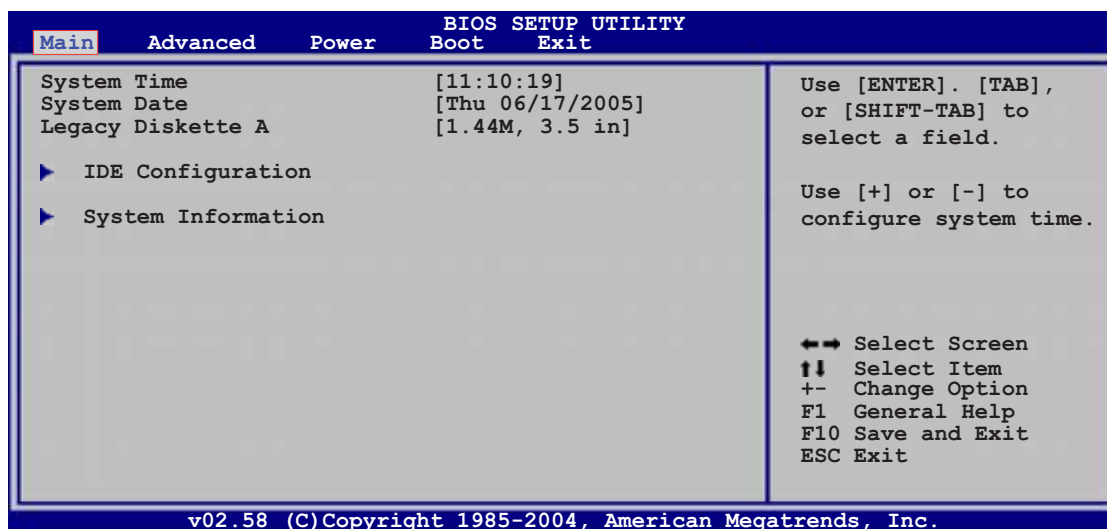

### 4.3.1 System Time [xx:xx:xx]

Allows you to set the system time.

### 4.3.2 System Date [Day xx/xx/xxxx]

Allows you to set the system date.

### 4.3.3 Legacy Diskette A [1.44M, 3.5 in.]

Sets the type of floppy drive installed. Configuration options: [Disabled] [360K, 5.25 in.] [1.2M, 5.25 in.] [720K, 3.5 in.] [1.44M, 3.5 in.] [2.88M, 3.5 in.]

## 4.3.4 IDE Configuration

The items in this menu allow you to set or change the configurations for the IDE devices installed in the system. Select an item then press <Enter> if you want to configure the item.

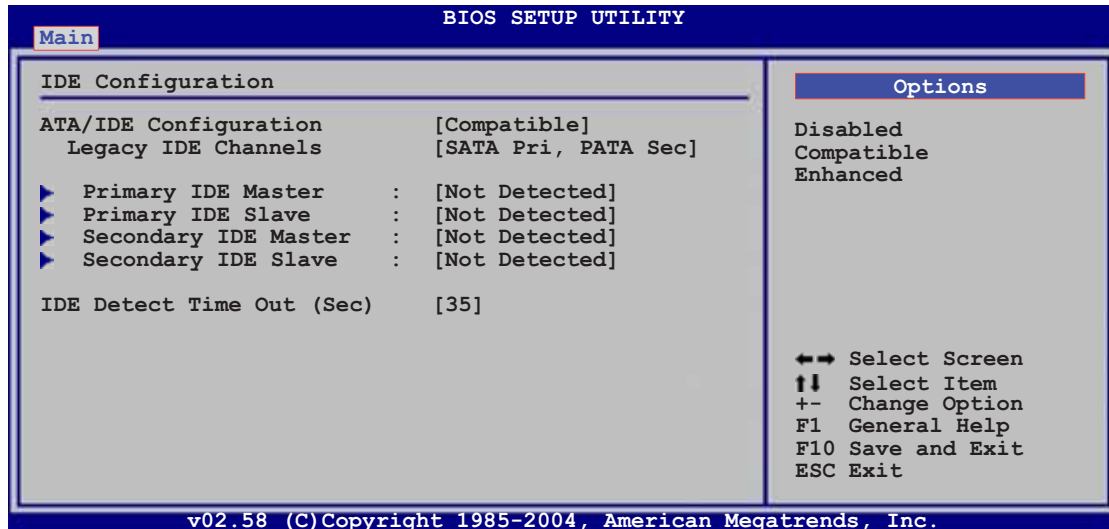

### ATA/IDE Configuration [Compatible Mode]

Allows selection of the IDE operation mode depending on the installed operating system (OS). Set to [Enhanced Mode] if you are using native OS, e.g. Windows® 2000/XP. Set to [Compatible Mode] if you are using legacy OS, e.g. Windows ME/98/NT, MS-DOS. Configuration options: [Disabled] [Compatible Mode] [Enhanced Mode]



The **Configure SATA as** and **Third IDE Master/Slave** options appear only when you set the ATA/IDE Configuration to [Enhanced Mode].

#### Configure SATA As [IDE]

Sets the configuration for the Serial ATA connectors supported by the Southbridge chip.

If you want to use the Serial ATA hard disk drives as Parallel ATA physical storage devices, set this item to [IDE].

Set this item to [RAID] if you want to create a RAID 0, RAID 1, RAID 0+1, or software RAID 5 configuration using the Intel® Matrix Storage Manager or if you want to create a RAID 0, RAID 1, RAID 0+1 configuration using the LSI Logic Embedded SATA RAID Setup Utility.

The AHCI allows the onboard storage driver to enable advanced Serial ATA features that increases storage performance on random workloads by allowing the drive to internally optimize the order of commands.



If you want the Serial ATA hard disk drives to use the Advanced Host Controller Interface (AHCI), set this item to [AHCI]. For details on AHCI, go to: [www.intel.com/support/chipsets/imst/sb/CS-012304.htm](http://www.intel.com/support/chipsets/imst/sb/CS-012304.htm)  
[www.intel.com/support/chipsets/imst/sb/CS-012305.htm](http://www.intel.com/support/chipsets/imst/sb/CS-012305.htm)

The SATA controller is set to Native mode when this item is set to [RAID] or [AHCI].

#### Legacy IDE Channels [SATA Pri, PATA Sec]

Allows you to set Serial ATA, Parallel ATA, or both, to native mode.  
 Configuration options: [SATA Only] [PATA Pri, SATA Sec]  
 [SATA Pri, PATA Sec] [ PATA Only]

### IDE Detect Time Out (Sec) [35]

Selects the time our value (in seconds) for detecting ATA/ATAPI devices.  
 Configuration options: [0] [5] [10] [15] [20] [25] [30] [35]

### 4.3.5 Primary/Secondary/Third IDE Master/Slave

The BIOS automatically detects the connected IDE devices. There is a separate sub-menu for each IDE device. Select a device item, then press <Enter> to display the IDE device information.

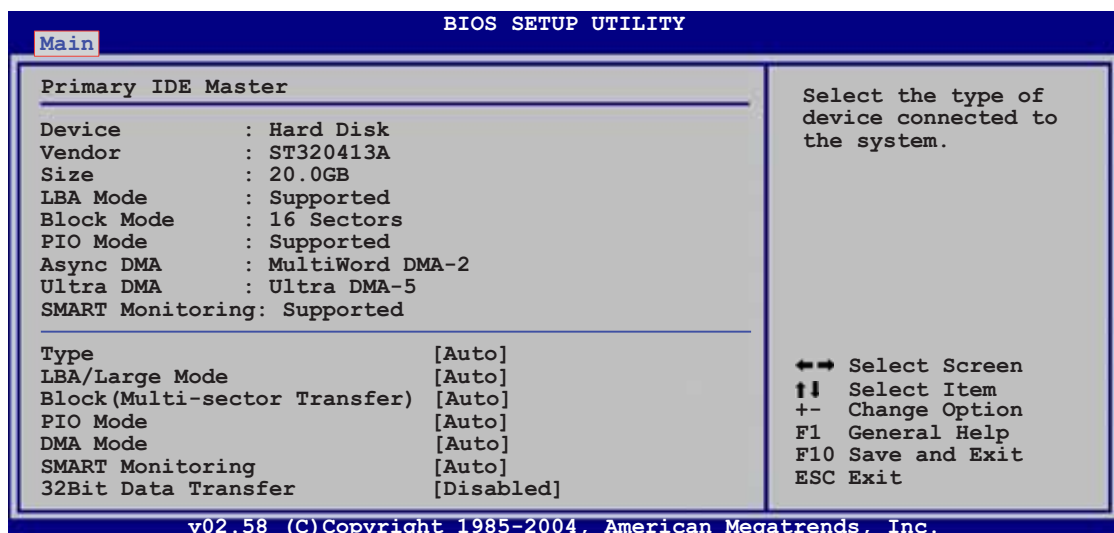

The BIOS automatically detects the values opposite the dimmed items (Device, Vendor, Size, LBA Mode, Block Mode, PIO Mode, Async DMA, Ultra DMA, and SMART monitoring). These values are not user-configurable. These items show N/A if no IDE device is installed in the system.

### **Type [Auto]**

Selects the type of IDE drive. Setting to [Auto] allows automatic selection of the appropriate IDE device type. Select [CDROM] if you are specifically configuring a CD-ROM drive. Select [ARMD] (ATAPI Removable Media Device) if your device is either a ZIP, LS-120, or MO drive.

Configuration options: [Not Installed] [Auto] [CDROM] [ARMD]

### **LBA/Large Mode [Auto]**

Enables or disables the LBA mode. Setting to [Auto] enables the LBA mode if the device supports this mode, and if the device was not previously formatted with LBA mode disabled. Configuration options: [Disabled] [Auto]

### **Block (Multi-sector Transfer) [Auto]**

Enables or disables data multi-sectors transfers. When set to [Auto], the data transfer from and to the device occurs multiple sectors at a time if the device supports multi-sector transfer feature. When set to [Disabled], the data transfer from and to the device occurs one sector at a time.

Configuration options: [Disabled] [Auto]

### **PIO Mode [Auto]**

Selects the PIO mode. Configuration options: [Auto] [0] [1] [2] [3] [4]

### **DMA Mode [Auto]**

Selects the DMA mode. Configuration options: [Auto] [SWDMA0] [SWDMA1] [SWDMA2] [MWDMA0] [MWDMA1] [MWDMA2] [UDMA0] [UDMA1] [UDMA2]

### **SMART Monitoring [Auto]**

Sets the Smart Monitoring, Analysis, and Reporting Technology.

Configuration options: [Auto] [Disabled] [Enabled]

### **32Bit Data Transfer [Disabled]**

Enables or disables 32-bit data transfer.

Configuration options: [Disabled] [Enabled]

## 4.3.6 System Information

This menu gives you an overview of the general system specifications. The BIOS automatically detects the items in this menu.

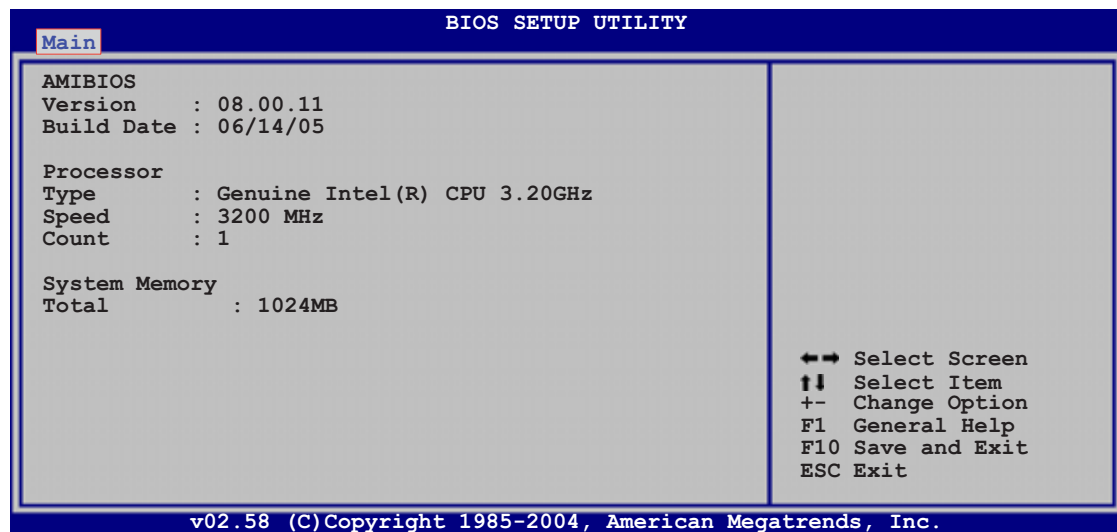

### AMI BIOS

Displays the auto-detected BIOS information.

### Processor

Displays the auto-detected CPU specification.

### System Memory

Displays the auto-detected total system memory.

## 4.4 Advanced menu

The Advanced menu items allow you to change the settings for the CPU and other system devices.



Take caution when changing the settings of the Advanced menu items. Incorrect field values can cause the system to malfunction.

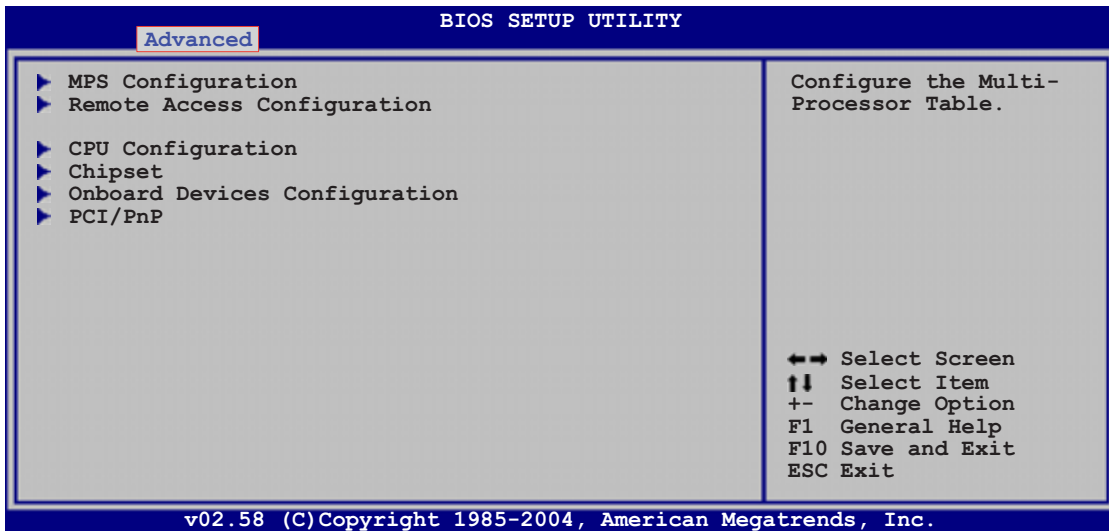

### 4.4.1 MPS Configuration

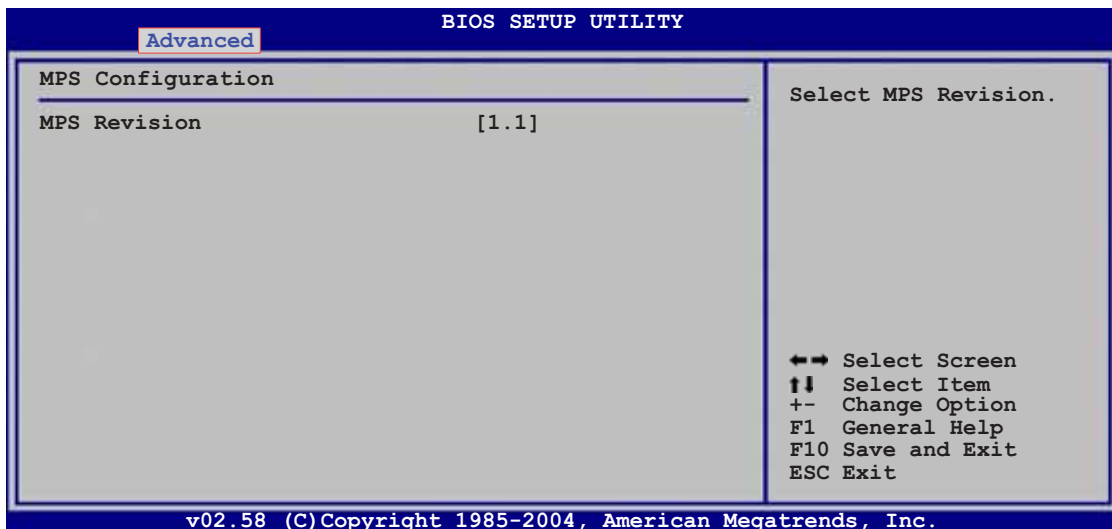

#### MPS Revision [1.4]

Allows you to select the multi-processor system version.

Configuration options: [1.1] [1.4]

## 4.4.2 Remote Access Configuration

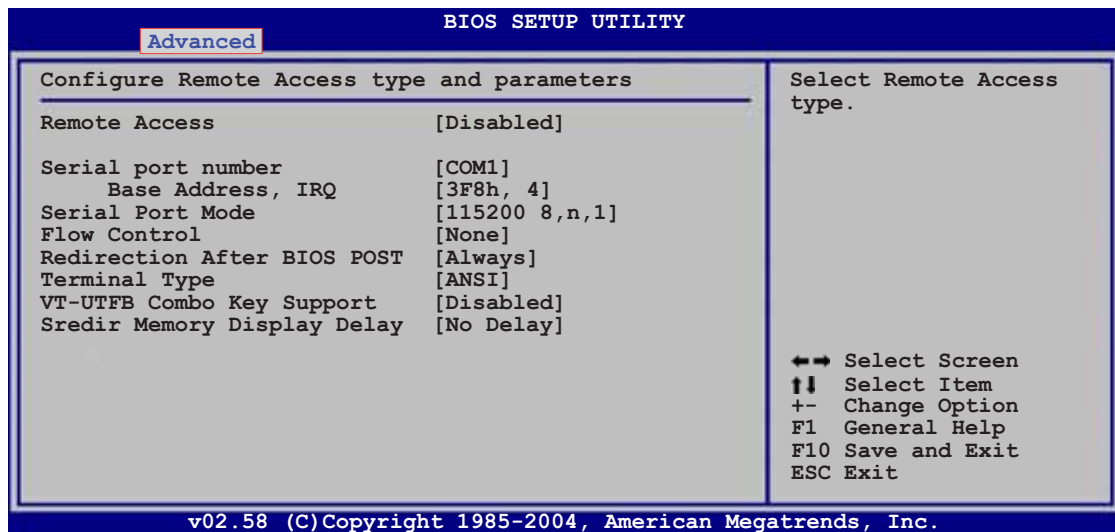

### Remote Access [Disabled]

Allows you to enable or disable remote access.

Configuration options: [Disabled] [Enabled]



When the **Remote Access** item is set to [Disabled], all other items do not appear.

### Serial port number [COM1]

Enables or disables the remote access feature.

Configuration options: [Disabled] [Enabled]

### Serial Port Mode [115200 8,n,1]

Sets the Serial port mode.

Configuration options: [115200 8,n,1] [57600 8,n,1] [38400 8,n,1] [19200 8,n,1] [09600 8,n,1]

### Flow Control [None]

Allows you to select the flow control for console redirection.

Configuration options: [None] [Hardware] [Software]

### Redirection After BIOS POST [Always]

Sets the redirection mode after the BIOS Power-On Self-Test (POST). Some operating systems may not work when this item is set to Always.

Configuration options: [Disabled] [Boot Loader] [Always]

### Terminal Type [ANSI]

Allows you to select the target terminal type.

Configuration options: [ANSI] [VT100] [VT-UTF8]

## VT-UTF8 Combo Key Support [Disabled]

Enables or disables the VT-UTF8 combo key support for ANSI or VT100 terminals. Configuration options: [Disabled] [Enabled]

## Sredir Memory Display Delay [No Delay]

Allows you to set the delay to display the memory information. Configuration options: [No Delay] [Delay 1 Sec] [Delay 2 Sec] [Delay 4 Sec]

### 4.4.3 CPU Configuration

The items in this menu show the CPU-related information that the BIOS automatically detects.

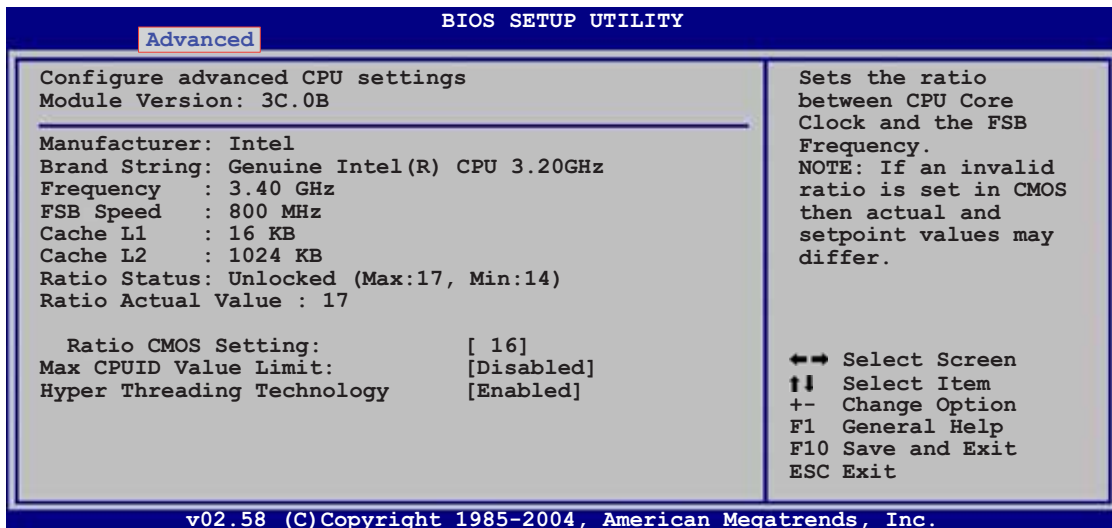

## Ratio CMOS Setting [16]

Sets the ratio between the CPU core clock and the Front Side Bus frequency. The BIOS auto-detects the default value of this item. Use the <+> or <-> keys to adjust the values. Configuration options: [ 8]...[28]



You can only adjust the **Ratio CMOS** if you installed an unlocked CPU. Refer to the CPU documentation for details.

## Max CPUID Value Limit [Disabled]

Setting this item to [Enabled] allows legacy operating systems to boot even without support for CPUs with extended CPUID functions. Configuration options: [Disabled] [Enabled]



---

The Hyper-Threading Technology item appears only when you installed an Intel® Pentium® 4 CPU that supports the Hyper-Threading Technology. Hyper-Threading is not supported when you installed a dual-core CPU.

---

## Hyper-Threading Technology [Enabled]

Allows you to enable or disable the processor Hyper-Threading Technology. Refer to the Appendix for more information on the Hyper-Threading Technology. Configuration options: [Disabled] [Enabled]



---

The following items appear only when you installed an Intel® Pentium® 4 dual-core CPU.

---

## Execute Disable Bit [Enabled]

When this item is set to [Disabled], the BIOS forces the XD feature flag to always return to (0). Configuration options: [Enabled] [Disabled]

## C1E Support [Disabled]

When set to [Enabled], the BIOS will automatically check the CPU's capability to enable the C1E support. In C1E mode, the CPU power consumption is lower when idle. Configuration options: [Disabled] [Enabled]

## Single Logical Processor Mode [Disabled]

Allows you to enable or disable the single logical processor mode for dual-core CPUs. Configuration options: [Disabled] [Enabled]

## Intel(R) SpeedStep Technology [Automatic]

Allows you to use the Enhanced Intel SpeedStep® Technology. When set to [Automatic], you can adjust the system power settings in the operating system to use the EIST feature.

Set this item to [Disabled] if you do not want to use the EIST.

Configuration options: [Automatic] [Disabled]



- 
- Refer to the Appendix for details on how to use the EIST feature.
  - The motherboard comes with a BIOS file that supports EIST.
-

## 4.4.4 Chipset Configuration

The Chipset Configuration menu allows you to change the advanced chipset settings. Select an item then press <Enter> to display the sub-menu.

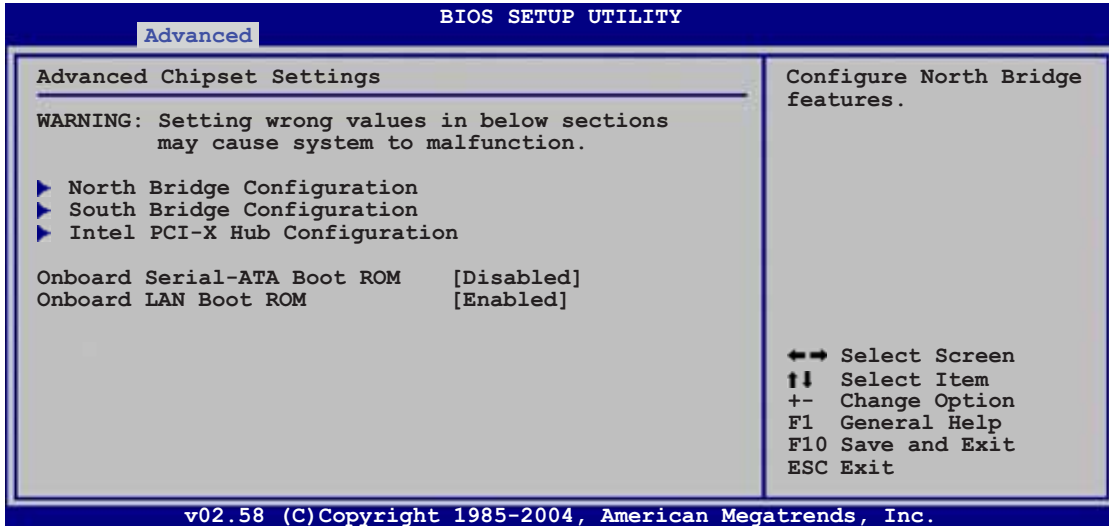

### Onboard Serial-ATA Boot ROM [Disabled]

Allows you to enable or disable the option ROM in the onboard Serial-ATA controller. Configuration options: [Disabled] [Enabled]

### Onboard LAN Boot ROM [Enabled]

Allows you to enable or disable the option ROM in the onboard LAN controller. Configuration options: [Disabled] [Enabled]



## NorthBridge Configuration

The NorthBridge Configuration menu allows you to change the Northbridge related settings.

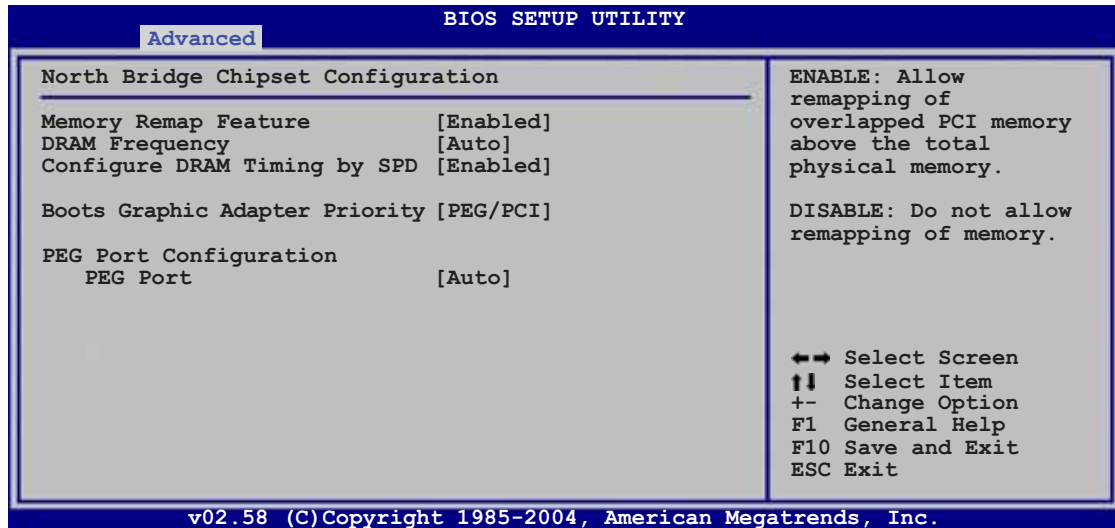

### Memory Remap Feature [Enabled]

Allows you to remap the overlap PCI memory over the total physical memory. Configuration options: [Disabled] [Enabled]

### DRAM Frequency [Auto]

Allows you to set the DDR operating frequency. Configuration options: [Auto] [533 MHz] [667 Mhz]

### Configure DRAM Timing by SPD [Enabled]

When this item is enabled, the DRAM timing parameters are set according to the DRAM SPD (Serial Presence Detect). When disabled, you can manually set the DRAM timing parameters through the DRAM sub-items. The following sub-items appear when this item is Disabled. Configuration options: [Disabled] [Enabled]

#### DRAM CAS# Latency [5 Clocks]

Controls the latency between the SDRAM read command and the time the data actually becomes available. Configuration options: [5] [4] [3]

#### DRAM RAS# to CAS# Delay [6 DRAM Clocks]

Controls the latency between the DDR SDRAM active command and the read/write command. Configuration options: [2 DRAM Clocks] [3 DRAM Clocks] [4 DRAM Clocks] [5 DRAM Clocks] [6 DRAM Clocks]

### DRAM RAS# Precharge [6 DRAM Clocks]

Controls the idle clocks after issuing a precharge command to the DDR SDRAM. Configuration options: [2 DRAM Clocks] [3 DRAM Clocks] [4 DRAM Clocks] [5 DRAM Clocks] [6 DRAM Clocks]

### DRAM RAS# Activate to Precharge [15 DRAM Clocks]

Configuration options: [4 DRAM Clocks] [5 DRAM Clocks] ~ [15 DRAM Clocks]

## **Boots Graphic Adapter Priority [PEG/PCI]**

Allows selection of the graphics controller to use as primary boot device. Configuration options: [PCI/PEG] [PEG/PCI]

## **PEG Port Configuration**

### PEG Port [Auto]

Allows you to set or disable the PCI Express Graphic port. Configuration options: [Auto] [Disabled]

## **SouthBridge Configuration**

The SouthBridge Configuration menu allows you to change the Southbridge related settings.

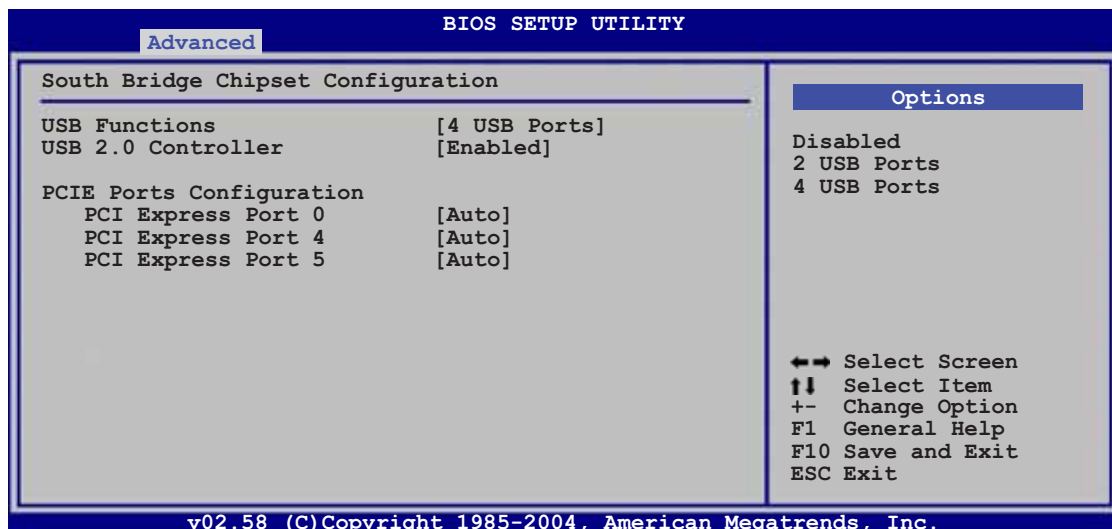

## **USB Function [4 USB Ports]**

Allows you to enable a specific number of USB ports, or disable the USB function. Configuration options: [Disabled] [2 USB Ports] [4 USB Ports]

## **USB 2.0 Controller [Enabled]**

Allows you to enable or disable the USB 2.0 controller. Configuration options: [Enabled] [Disabled]

## PCI Express Port Configuration

### PCI Express Port 0 [Auto]

Allows you to set or disable the PCI Express Port 0.  
Configuration options: [Auto] [Disabled]

### PCI Express Port 4 [Auto]

Allows you to set or disable the PCI Express Port 4.  
Configuration options: [Auto] [Disabled]

### PCI Express Port 5 [Auto]

Allows you to set or disable the PCI Express Port 5.  
Configuration options: [Auto] [Disabled]

## Intel PCI-X Hub Configuration

The Intel PCI-X Hub Configuration menu allows you to change the Intel PCI Express controller related settings.

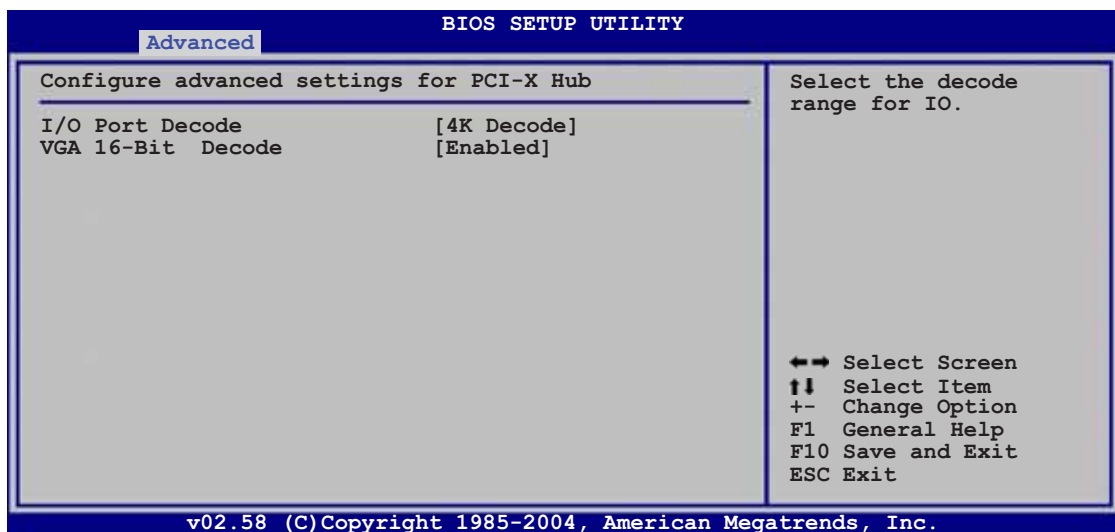

### **I/O Port Decode [4K Decode]**

Allows you to set the decode range for the I/O controller.  
Configuration options: [4K Decode] [1K Decode]

### **VGA 16-Bit Decode [Enabled]**

Allows you to enable or disable the decode for the VGA controller.  
Configuration options: [Disabled] [Enabled]

## 4.4.5 Onboard Devices Configuration

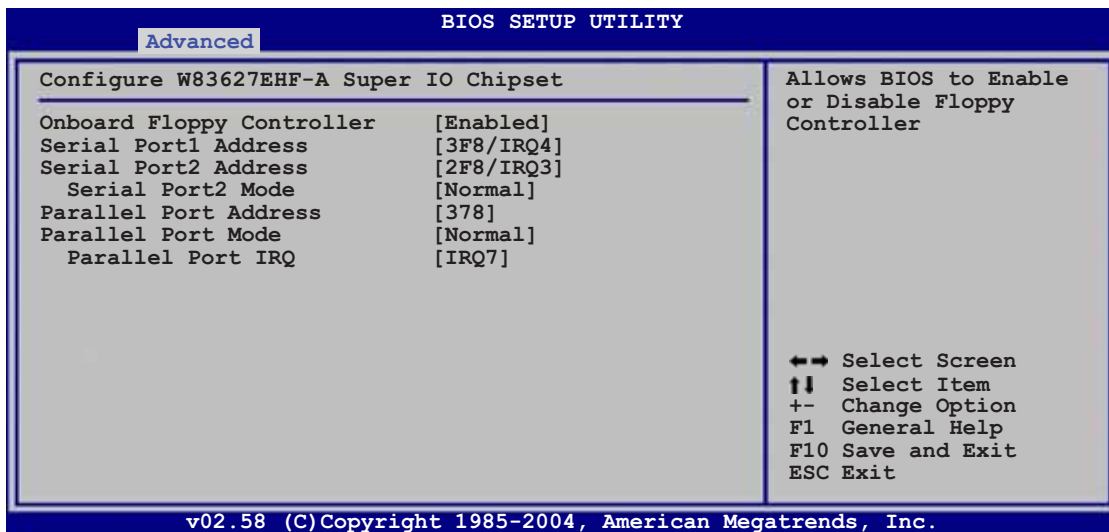

### Onboard Floppy Controller [Enabled]

Allows you to enable the onboard floppy disk drive controller.  
Configuration options: [Disabled] [Enabled]

### Serial Port1 Address [3F8/IRQ4]

Allows you to select the Serial Port1 base address.  
Configuration options: [Disabled] [3F8/IRQ4] [3E8/IRQ4] [2E8/IRQ3]

### Serial Port2 Address [2F8/IRQ3]

Allows you to select the Serial Port2 base address.  
Configuration options: [Disabled] [2F8/IRQ3] [3E8/IRQ4] [2E8/IRQ3]

#### *Serial Port2 Mode [Normal]*

Allows you to select the Serial Port2 mode.  
Configuration options: [Normal] [IrDA] [ASK IR]

### Parallel Port Address [378]

Allows you to select the Parallel Port base addresses.  
Configuration options: [Disabled] [378] [278] [3BC]

### Parallel Port Mode [Normal]

Allows you to select the Parallel Port mode.  
Configuration options: [Normal] [Bi-directional] [EPP] [ECP]

#### *Parallel Port IRQ [IRQ7]*

Allows you to specify the Parallel Port IRQ.  
Configuration options: [IRQ5] [IRQ7]

## 4.4.6 PCI/PnP Configuration

The PCI/PnP Configuration menu items allow you to change the advanced settings for PCI/PnP devices. The menu includes setting the IRQ and DMA channel resources for either PCI/PnP or legacy ISA devices, and setting the memory size block for legacy ISA devices.



Take caution when changing the settings of the PCI PnP menu items. Incorrect field values can cause the system to malfunction!

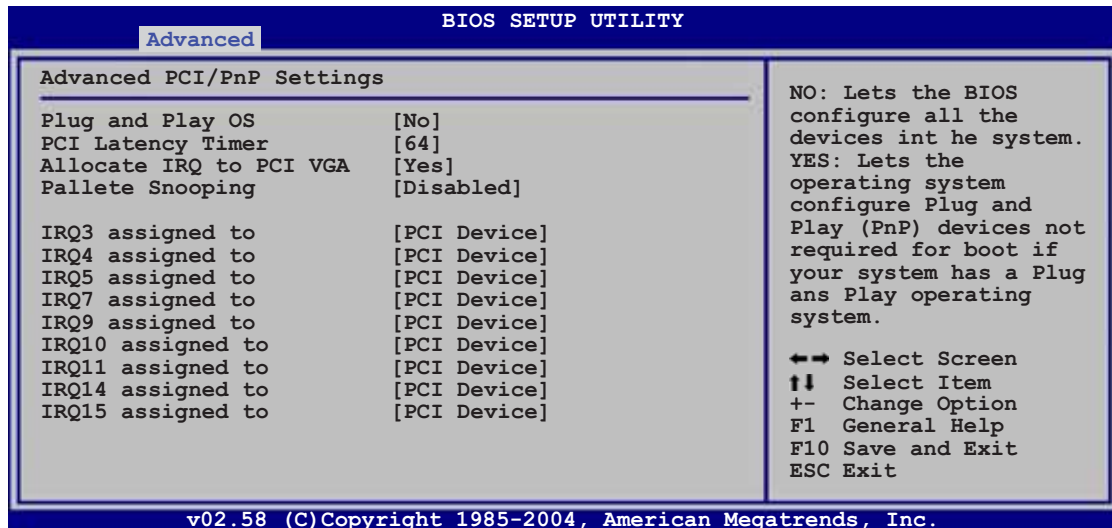

### Plug And Play O/S [No]

When set to [No], BIOS configures all the devices in the system. When set to [Yes] and if you install a Plug and Play operating system, the operating system configures the Plug and Play devices not required for boot.

Configuration options: [No] [Yes]

### PCI Latency Timer [64]

Allows you to select the value in units of PCI clocks for the PCI device latency timer register. Configuration options: [32] [64] [96] [128] [160] [192] [224] [248]

### Allocate IRQ to PCI VGA [Yes]

When set to [Yes], BIOS assigns an IRQ to PCI VGA card if the card requests for an IRQ. When set to [No], BIOS does not assign an IRQ to the PCI VGA card even if requested. Configuration options: [Yes] [No]

### Palette Snooping [Disabled]

When set to [Enabled], the palette snooping feature informs the PCI devices that an ISA graphics device is installed in the system so that the latter can function correctly. Configuration options: [Disabled] [Enabled]

### IRQXX assigned to [PCI Device]

When set to [PCI Device], the specific IRQ is free for use of PCI/PnP devices. When set to [Reserved], the IRQ is reserved for legacy devices. Configuration options: [PCI Device] [Reserved]

## 4.5 Power menu

The Power menu items allow you to change the settings for the ACPI and Advanced Power Management (APM) features. Select an item then press <Enter> to display the configuration options.

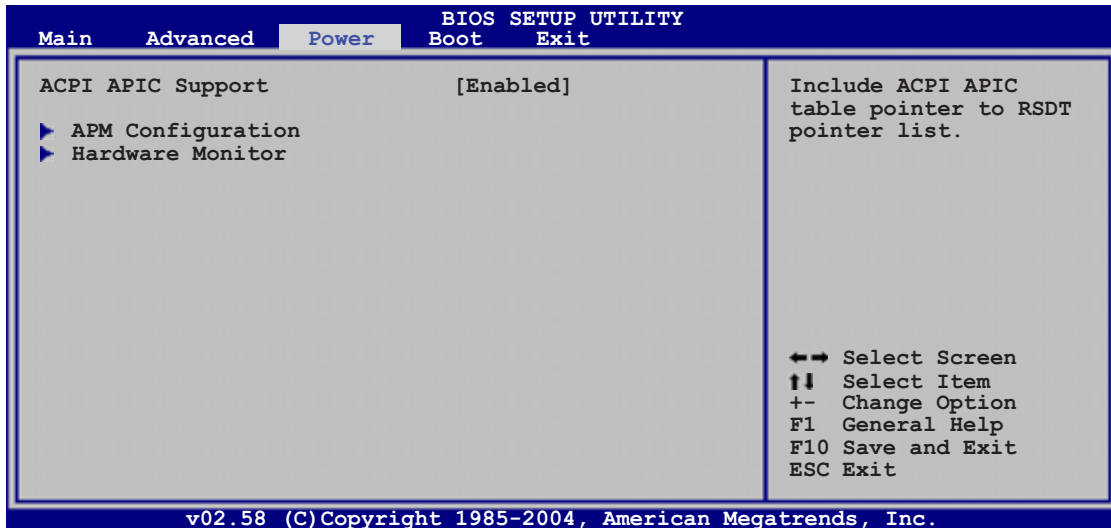

### ACPI APIC Support [Enabled]

Allows you to enable or disable the Advanced Configuration and Power Interface (ACPI) support in the Application-Specific Integrated Circuit (ASIC). When set to Enabled, the ACPI APIC table pointer is included in the RSDT pointer list. Configuration options: [Disabled] [Enabled]

### 4.5.1 APM Configuration

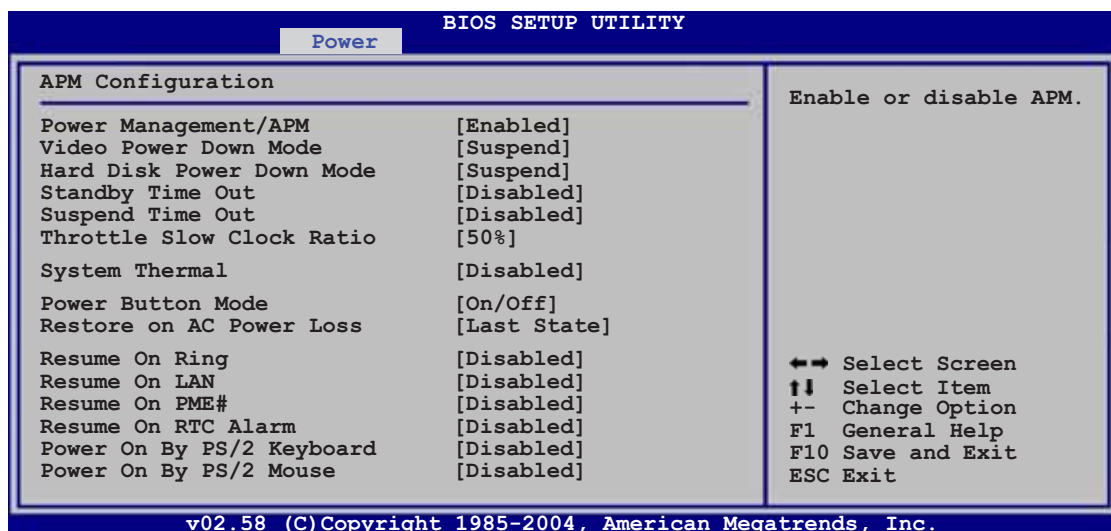

### Power Management [Enabled]

Allows you to enable or disable the motherboard Advance Power Management (APM) feature. Configuration options: [Enabled] [Disabled]

## **Video Power Down Mode [Suspend]**

Allows you to select the video power down mode  
Configuration options: [Disabled] [Standby] [Suspend]

## **Hard Disk Power Down Mode [Suspend]**

Allows you to select the hard disk power down mode  
Configuration options: [Disabled] [Standby] [Suspend]

## **Suspend Time Out (Minute) [Disabled]**

Allows you to select the specified time at which the system goes on suspend mode. Configuration options: [Disabled] [1 Min] [2 Min] [4 Min] [8 Min] [10 Min] [20 Min] [30 Min] [40 Min] [50 Min] [60 Min]

## **Throttle Slow Clock Ratio [50%]**

Allows you to select duty cycle in throttle mode.  
Configuration options: [87.5%] [75.0%] [62.5%] [50.0%] [37.5%] [25.0%] [12.5%]

## **System Thermal [Disabled]**

Allows you to enable or disable the system thermal control feature.  
Configuration options: [Disabled] [Enabled]



---

The **Thermal Active Temperature** and **Thermal Slow Clock Ratio** items appear only when the **System Thermal** item is set to Enabled.

---

## **Thermal Active Temperature [60°C/140°F]**

Allows you to specify the system thermal control activating temperature.  
Configuration options: [40°C/104°F] [45°C/111°F] [50°C/122°F] [55°C/131°F] [60°C/140°F] [65°C/149°F] [70°C/158°F] [75°C/167°F]

## **Thermal Slow Clock Ratio [50%]**

Allows you to select the duty cycle in throttle when a thermal override condition occurs. Configuration options: [87.5%] [75.0%] [62.5%] [50%] [37.5%] [25%] [12.5%]

## **Power Button Mode [On/Off]**

Allows the system to go into On/Off mode or suspend mode when the power button is pressed. Configuration options: [On/Off] [Suspend]

## Restore on AC Power Loss [Last State]

When set to Power Off, the system goes into off state after an AC power loss. When set to Power On, the system goes on after an AC power loss. When set to Last State, the system goes into either off or on state, whatever the system state was before the AC power loss.  
Configuration options: [Power Off] [Power On] [Last State]

## Resume On Ring [Disabled]

When set to [Enabled], the system enables the RI to generate a wake event while the computer is in Soft-off mode.  
Configuration options: [Disabled] [Enabled]

## Resume On LAN [Disabled]

When set to [Enabled], the system enables the LAN to generate a wake event while the computer is in Soft-off mode.  
Configuration options: [Disabled] [Enabled]

## Resume On PME# [Disabled]

When set to [Enabled], the system enables the PME to generate a wake event while the computer is in Soft-off mode.  
Configuration options: [Disabled] [Enabled]

## Resume On RTC Alarm [Disabled]

Allows you to enable or disable RTC to generate a wake event.  
Configuration options: [Disabled] [Enabled]



---

The following items appear when the **Power On RTC Alarm** item is set to Enabled.

---

### RTC Alarm Date (Days)

To set the alarm date, highlight this item and press the <+> or <-> key to make the selection. Configuration options: [Everyday] [1] [2] [3]... ~ [31]

### System Time

To set the alarm hour, highlight this item and press the <+> or <-> key to make the selection. Configuration options: [00] [1]... ~ [23]



## Power On By PS/2 Keyboard [Disabled]

Allows you to use specific keys on the keyboard to turn on the system. This feature requires an ATX power supply that provides at least 1A on the +5VSB lead. Configuration options: [Disabled] [Enabled]

## Power On By PS/2 Mouse [Disabled]

When set to [Enabled], this parameter allows you to use the PS/2 mouse to turn on the system. This feature requires an ATX power supply that provides at least 1A on the +5VSB lead. Configuration options: [Disabled] [Enabled]

## 4.5.2 Hardware Monitor

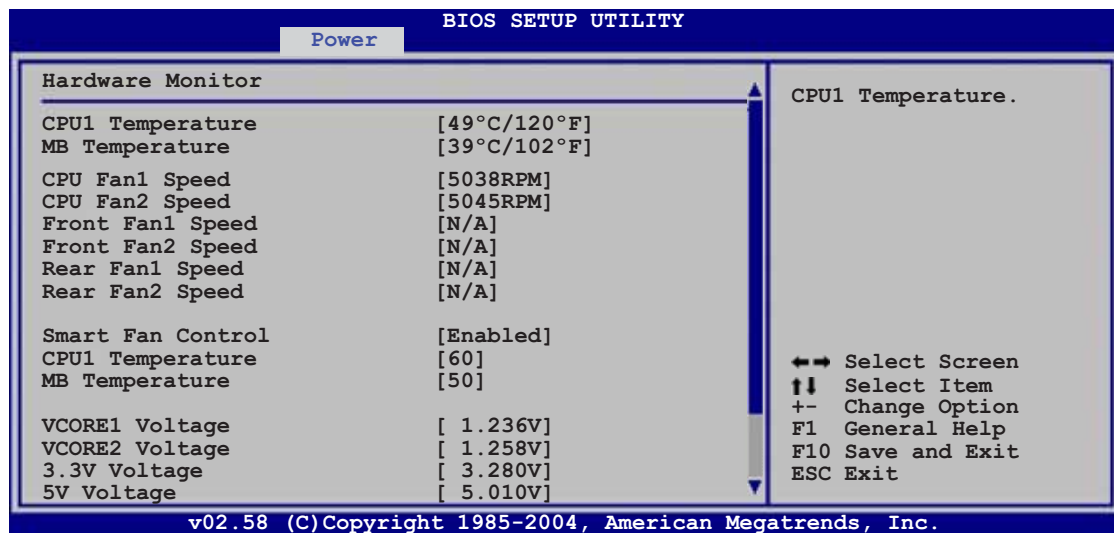

Use the down arrow key to display additional items.

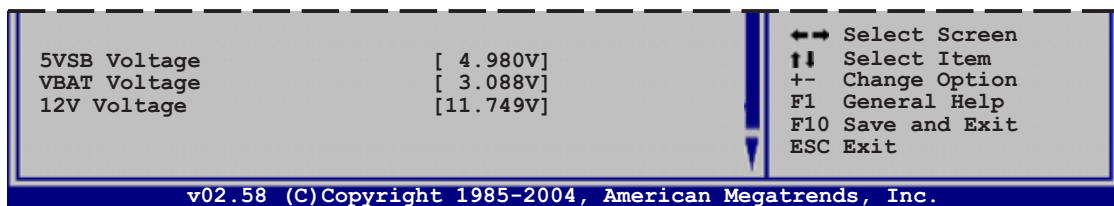

## CPU1 Temperature [xxx°C/xxx°F]

## MB Temperature [xxx°C/xxx°F]

The onboard hardware monitor automatically detects and displays the motherboard and CPU temperatures. Select [Disabled] if you do not wish to display the detected temperatures.

**CPU Fan1/2 Speed [xxxxRPM] or [N/A]**  
**Front Fan1/2 Speed [xxxxRPM] or [N/A]**  
**Rear Fan1/2 Speed [xxxxRPM] or [N/A]**

The onboard hardware monitor automatically detects and displays the CPU, front, and rear fan speeds in rotations per minute (RPM). If a fan is not connected to the connector on the motherboard, the field shows N/A.

### **Smart Fan Control [Enabled]**

Allows you to enable or disable the ASUS Q-Fan feature that smartly adjusts the fan speeds for more efficient system operation.

Configuration options: [Disabled] [Enabled]



---

The **CPU1 Temperature** and **MB Temperature** items do not appear when you disable the **Smart Fan Control** feature.

---

**CPU1 Temperature [XXX]**  
**MB Temperature [XXX]**

Displays the detected CPU and system threshold temperatures when the Smart Fan Control feature is enabled.

**VCORE1 Voltage, VCORE2 Voltage, 3.3V Voltage, 5V Voltage, 5VSB Voltage, VBAT Voltage, 12V Voltage**

The onboard hardware monitor automatically detects the voltage outputs through the onboard voltage regulators.

## 4.6 Boot menu

The Boot menu items allow you to change the system boot options. Select an item then press <Enter> to display the sub-menu.

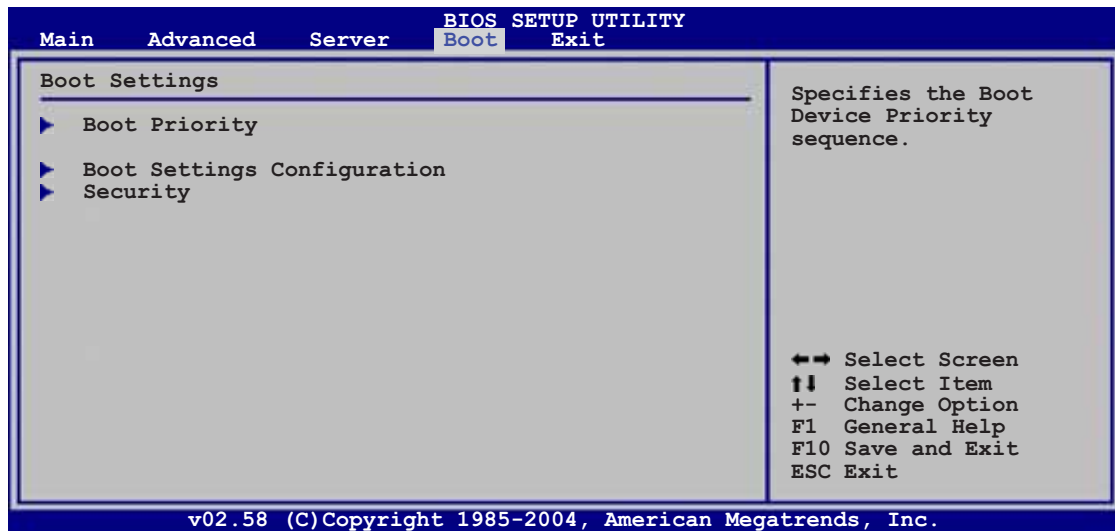

### 4.6.1 Boot Device Priority

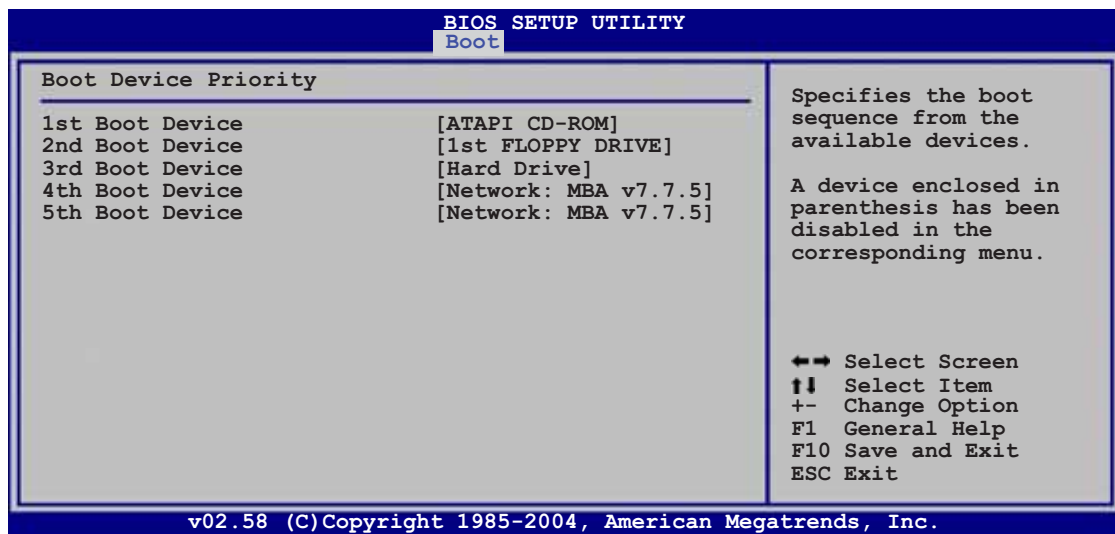

**1st Boot Device [ATAPI CD-ROM]**  
**2nd Boot Device [1st FLOPPY DRIVE]**  
**3rd Boot Device [Hard Drive]**  
**4th Boot Device [Network: MBA v7.7.5]**  
**5th Boot Device [Network: MBA v7.7.5]**

These items specify the boot device priority sequence from the available devices. Configuration options: [1st FLOPPY DRIVE] [ATAPI CD-ROM] [Hard Drive] [Network: MBA v7.7.5 Slot 0400] [Network: MBA v7.7.5 Slot 0300] [Disabled]

## 4.6.2 Boot Settings Configuration

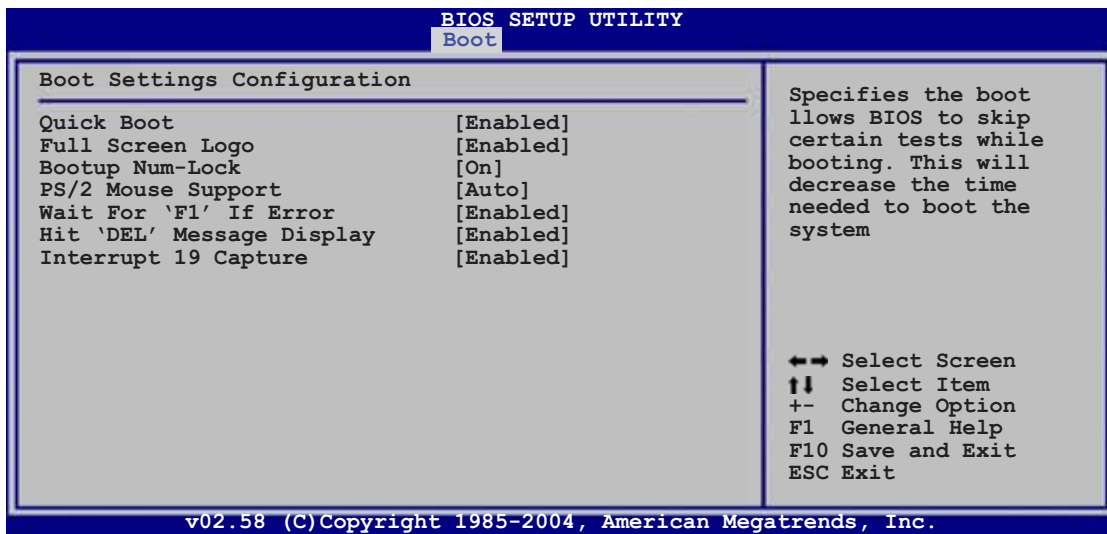

### Quick Boot [Enabled]

Enabling this item allows the BIOS to skip some power on self tests (POST) while booting to decrease the time needed to boot the system. When set to [Disabled], BIOS performs all the POST items.

Configuration options: [Disabled] [Enabled]

### Full Screen Logo [Enabled]

Allows you to enable or disable the full screen logo display feature.

Configuration options: [Disabled] [Enabled]



Set this item to [Enabled] to use the ASUS MyLogo2™ feature.

### Bootup Num-Lock [On]

Allows you to select the power-on state for the NumLock.

Configuration options: [Off] [On]

### PS/2 Mouse Support [Auto]

Allows you to enable or disable support for PS/2 mouse.

Configuration options: [Disabled] [Enabled] [Auto]

### Wait for 'F1' If Error [Enabled]

When set to Enabled, the system waits for the F1 key to be pressed when error occurs. Configuration options: [Disabled] [Enabled]

### Hit 'DEL' Message Display [Enabled]

When set to Enabled, the system displays the message "Press DEL to run Setup" during POST. Configuration options: [Disabled] [Enabled]

### Interrupt 19 Capture [Enabled]

When set to [Enabled], this function allows the option ROMs to trap Interrupt 19. Configuration options: [Disabled] [Enabled]

### 4.6.3 Security

The Security menu items allow you to change the system security settings. Select an item then press <Enter> to display the configuration options.

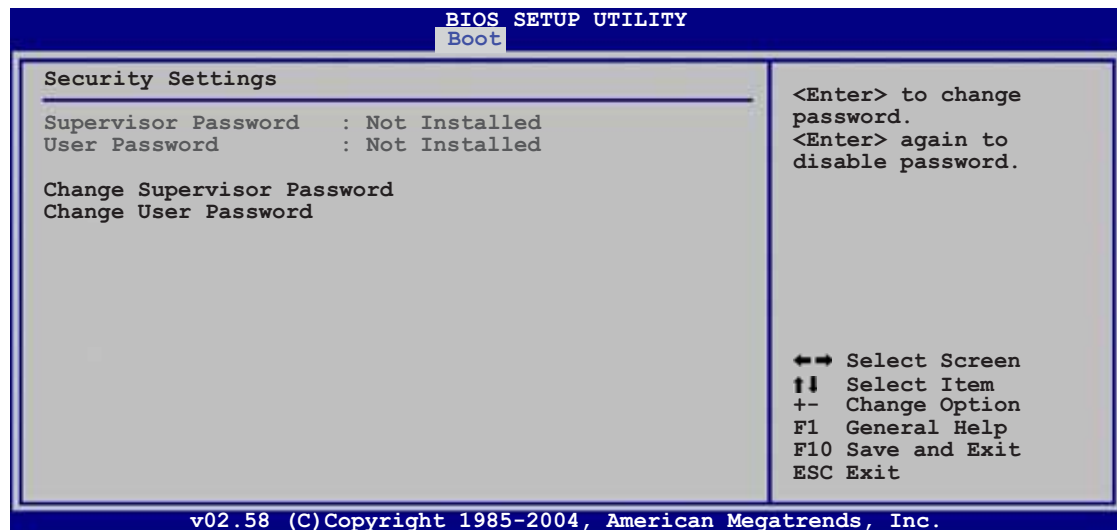

#### Change Supervisor Password

Select this item to set or change the supervisor password. The Supervisor Password item on top of the screen shows the default **Not Installed**. After you set a password, this item shows **Installed**.

To set or change a supervisor password:

1. Select the **Change Supervisor Password** item, then press <Enter>.
2. From the password box, type a password composed of at least six letters and/or numbers, then press <Enter>.
3. Confirm the password when prompted.

The message "Password Installed" appears after you successfully set your password.

To change the supervisor password, follow the same steps as in setting a user password.

#### To clear the supervisor password:

Select the **Change Supervisor Password** then press <Enter>. The message "Password Uninstalled" appears.



If you forget your BIOS password, you can clear it by erasing the CMOS Real Time Clock (RTC) RAM. See section "2.6 Jumpers" for information on how to erase the RTC RAM.

After you have set a supervisor password, the other items appear to allow you to change other security settings.

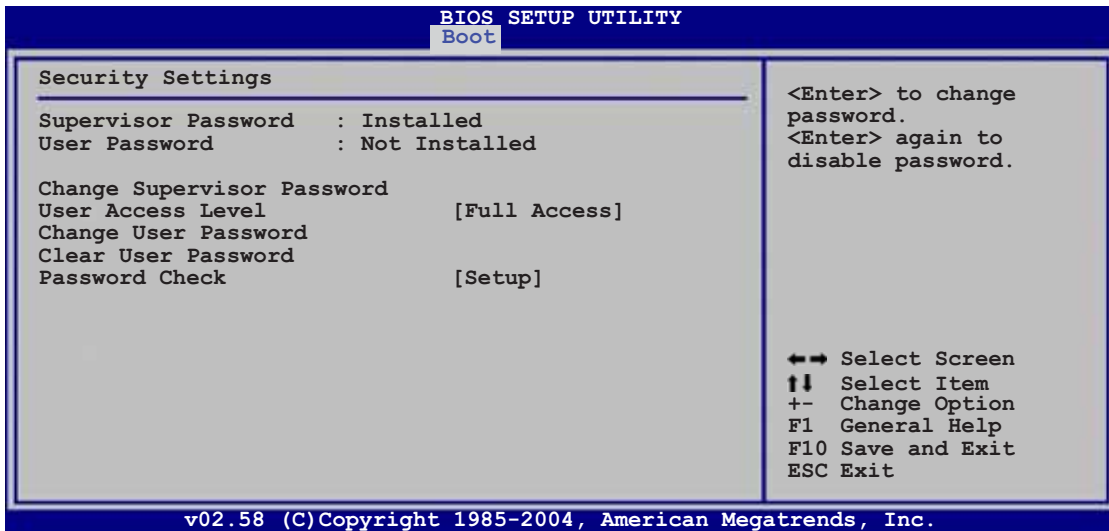

## User Access Level [Full Access]

This item allows you to select the access restriction to the Setup items. Configuration options: [No Access] [View Only] [Limited] [Full Access]

**No Access** prevents user access to the Setup utility.

**View Only** allows access but does not allow change to any field.

**Limited** allows changes only to selected fields, such as Date and Time.

**Full Access** allows viewing and changing all the fields in the Setup utility.

## Change User Password

Select this item to set or change the user password. The **User Password** item on top of the screen shows the default **Not Installed**. After you set a password, this item shows **Installed**.

To set a user password:

1. Select the Change User Password item and press <Enter>.
2. On the password box that appears, type a password composed of at least six letters and/or numbers, then press <Enter>.
3. Confirm the password when prompted.

The message “Password Installed” appears after you set your password successfully.

To change the user password, follow the same steps as in setting a user password.

## **Clear User Password**

Select this item to clear the user password.

## **Password Check [Setup]**

When set to [Setup], BIOS checks for user password when accessing the Setup utility. When set to [Always], BIOS checks for user password both when accessing Setup and booting the system.

Configuration options: [Setup] [Always]

## 4.7 Exit menu

The Exit menu items allow you to load the optimal or failsafe default values for the BIOS items, and save or discard your changes to the BIOS items.

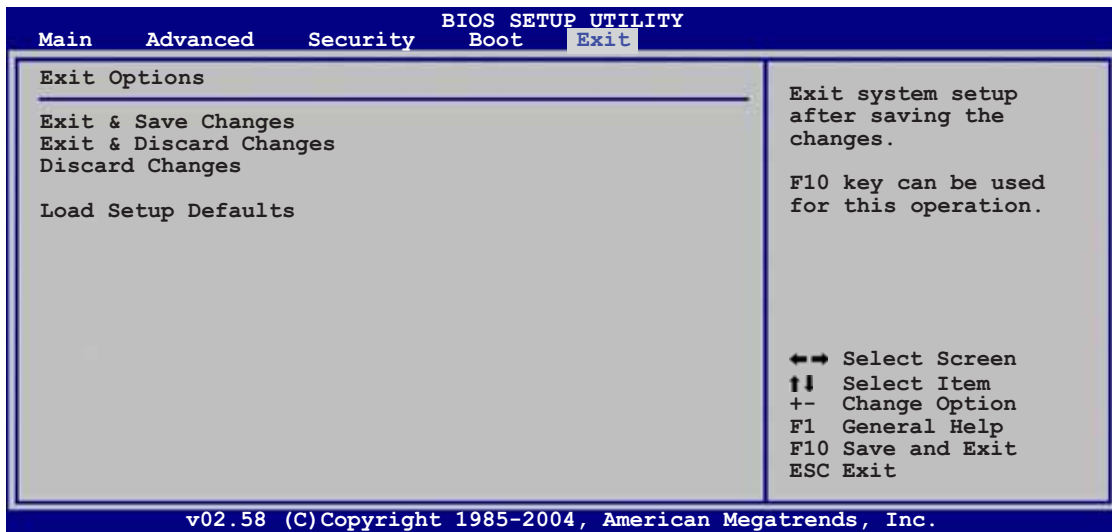

If you made changes to any of the settings in the menus, pressing <Esc> does not immediately exit this menu. A confirmation window appears and prompts you to either save your changes or cancel the command. Select one of the options from this menu to exit.

### Exit & Save Changes

Select this option then press <Enter>, or simply press <F10>, to save your changes to CMOS before exiting the Setup utility.

When a confirmation window appears, select [OK] then press <Enter> to save your changes and exit Setup. If you wish to cancel the command, select [Cancel] then press <Enter> to return to the Exit menu.

### Exit & Discard Changes

Select this option then press <Enter> to exit the Setup utility without saving your changes.

When a confirmation window appears, select [OK] then press <Enter> to discard your changes and exit Setup. If you wish to cancel the command, select [Cancel] then press <Enter> to return to the Exit menu.

### Discard Changes

Select this option then press <Enter> to discard the changes that you made, and restore the previously saved settings.

When a confirmation window appears, select [OK] then press <Enter> to discard the changes, and load the previously saved settings. If you wish to cancel the command, select [Cancel] then press <Enter> to return to the Exit menu.



## **Load Setup Defaults**

Select this option then press <Enter> to load the optimized settings for each of the Setup menu items.

When a confirmation window appears, select [OK] then press <Enter> to load the default settings. If you wish to cancel the command, select [Cancel] then press <Enter> to return to the Exit menu.



This chapter provides instructions for setting up, creating, and configuring RAID sets using the available utilities.

# 5 RAID configuration

5.1	Setting up RAID .....	5-1
5.2	LSI Logic Embedded SATA RAID Setup Utility .....	5-4
5.3	Global Array Manager .....	5-30
5.4	LSI Logic Configuration Utility .....	5-31

## 5.1 Setting up RAID

The motherboard comes with the following RAID solutions:

### P5MT model

- **LSI Logic Embedded SATA RAID** technology embedded in the Intel® ICH7R Southbridge supports up to two SATA hard disk drives and RAID 0, RAID 1, and RAID 10 configurations.

### P5MT/SCSI model

- **LSI Logic Embedded SATA RAID**
- **LSI53C1020A PCI-X SCSI controller** supports SCSI hard disk drives and RAID 0, RAID 1, RAID 1-E configurations.

### 5.1.1 RAID definitions

**RAID 0** (*Data striping*) optimizes two identical hard disk drives to read and write data in parallel, interleaved stacks. Two hard disks perform the same work as a single drive but at a sustained data transfer rate, double that of a single disk alone, thus improving data access and storage. Use of two new identical hard disk drives is required for this setup.

**RAID 1** (*Data mirroring*) copies and maintains an identical image of data from one drive to a second drive. If one drive fails, the disk array management software directs all applications to the surviving drive as it contains a complete copy of the data in the other drive. This RAID configuration provides data protection and increases fault tolerance to the entire system. Use two new drives or use an existing drive and a new drive for this setup. The new drive must be of the same size or larger than the existing drive.

**RAID 1-E** (*Enhanced RAID 1*) has a striped layout with each stripe unit having a secondary (or alternate) copy stored on a different disk. You can use three or more hard disk drives for this configuration.

**RAID 0+1** is *data striping* and *data mirroring* combined without parity (redundancy data) having to be calculated and written. With the RAID 0+1 configuration you get all the benefits of both RAID 0 and RAID 1 configurations. Use four new hard disk drives or use an existing drive and three new drives for this setup.

**JBOD** (*Spanning*) stands for **Just a Bunch of Disks** and refers to hard disk drives that are not yet configured as a RAID set. This configuration stores the same data redundantly on multiple disks that appear as a single disk on the operating system. Spanning does not deliver any advantage over using separate disks independently and does not provide fault tolerance or other RAID performance benefits.



---

If you want to boot the system from a hard disk drive included in a created RAID set, copy first the RAID driver from the support CD to a floppy disk before you install an operating system to the selected hard disk drive. Refer to Chapter 6 for details.

## 5.1.2 Installing hard disk drives

The motherboard supports Serial ATA (both models) and SCSI hard disk drives (P5MT/SCSI model only) for RAID set configuration. For optimal performance, install identical drives of the same model and capacity when creating a disk array.

To install the SATA hard disks for RAID configuration:

1. Install the SATA hard disks into the drive bays following the instructions in the system user guide.
2. Connect a SATA signal cable to the signal connector at the back of each drive and to the SATA connector on the motherboard.
3. Connect a SATA power cable to the power connector on each drive.

To install the SCSI hard disks for RAID configuration:

1. Install the SCSI hard disks into the drive bays following the instructions in the system user guide.
2. Connect the SCSI interface cable connectors at the back of the SCSI drives.
3. Connect the other end of the SCSI interface cable to the SCSI connector on the motherboard.

## 5.1.3 Setting the RAID item in BIOS

You must set the RAID item in the BIOS Setup before you can create a RAID set from SATA hard disk drives attached to the SATA connectors supported by the Intel® ICH7R Southbridge chip. To do this:

1. Enter the BIOS Setup during POST.
2. Go to the **Main Menu**, select **IDE Configuration**, then press <Enter>.
3. Set the **ATA/IDE Configuration** item to [Enhanced Mode], then press <Enter>.
4. Set the **Configure SATA As** item to [RAID].
5. Save your changes, then exit the BIOS Setup.



---

Refer to Chapter 4 for details on entering and navigating through the BIOS Setup.

---

## 5.1.4 RAID configuration utilities

Depending on the RAID connectors that you use, you can create a RAID set using the utilities embedded in each RAID controller. For example, use the **LSI Logic Embedded SATA RAID Setup Utility** if you installed SATA hard disk drives on the SATA connectors supported by the Intel® ICH7R Southbridge and/or the **LSI Logic Configuration Utility** if you installed SCSI hard disk drives to the SCSI connector(s) supported by the LSI53C1020A PCI-X SCSI controller (P5MT/SCSI model only). Refer to the succeeding sections for details on how to use each RAID configuration utility.







- The **ARRAY SELECTION MENU** displays the available drives connected to the SATA ports. Select the drives you want to include in the RAID set, then press <SpaceBar>. When selected, the drive indicator changes from **READY** to **ONLIN A[X]-[Y]**, where X is the array number, and Y is the drive number.

```
-----Easy Configuration - ARRAY SELECTION MENU-----
Management
Configure
Initialize
Objects
Rebuild
Check Consis
-----
PORT #
0-READY
1-READY
-----
Port # 0 DISK 114376MB HDS722512VLSA80 V330A6MA
SPACE-Sel ENTER-EndArray F10-Configure F2-Drv. Info F3-Logical Drives
```



The information of the selected hard disk drive displays at the bottom of the screen.

- Select all the drives required for the RAID set, then press <Enter>. The configurable array appears on screen.

```
-----Easy Configuration - ARRAY SELECTION MENU-----
Management
Configure
Initialize
Objects
Rebuild
Check Consis
-----
PORT #
0-ONLIN A00-00
1-ONLIN A00-01
-----
Port # 1 DISK 114376MB HDS722512VLSA80 V330A6MA
SPACE-Sel ENTER-EndArray F10-Configure F2-Drv. Info F3-Logical Drives
```



6. Select **RAID** from the **Logical Drive** menu, then press <Enter>.
7. Select the RAID level from the menu, then press <Enter>.



---

You need at least two identical hard disk drives when creating a RAID 1 set.

---

```

***** Logical Drive(s) Configured *****
***** L.D   RAID   Size   #Stripes   StripeSz   Status *****
***** 0     1     114376MB  2         64 KB     ONLINE *****
-- Management --
-- Configure --
-- Initialize --
-- Objects --
-- Rebuild --
-- Check Con --
*****

***** Logical Drive 0 *****
RAID = 1
Size = 114376MB
Stripe Size
Accept
SPAN = NO

***** RAID Level *****
RAID 0
RAID 1
*****

***** Choose RAID Level For This Logical Drive *****
Use Cursor Keys To Navigate Between Items And Press Enter To Select An Option

```

8. When creating a RAID 1 set, select **Stripe Size** from the **Logical Drive** menu, then press <Enter>.  
When creating a RAID 0 set, proceed to step 10.
9. Key-in the stripe size, then press <Enter>.

```

***** Logical Drive(s) Configured *****
***** L.D   RAID   Size   #Stripes   StripeSz   Status *****
***** 0     1     114376MB  2         64 KB     ONLINE *****
-- Management --
-- Configure --
-- Initialize --
-- Objects --
-- Rebuild --
-- Check C --
***** Enter Stripe Size In KB (4,8,16,32,64,128)? :64 *****
***** Logical Drive 0 *****
RAID = 1
Size = 114376MB
Stripe Size
Accept
SPAN = NO

***** Enter Stripe Size In KB (4,8,16,32,64,128)? :
Use Cursor Keys To Navigate Between Items And Press Enter To Select An Option

```



---

For server systems, we recommend that you use a lower array block size. For multimedia computer systems used mainly for audio and video editing, we recommend a higher array block size for optimum performance.

---

- When finished setting the selected logical drive configuration, select **Accept** from the menu, then press <Enter>.

```

***** Logical Drive(s) Configured *****
***** LD   RAID   Size   #Stripes   StripeSz   Status *****
***** 0     1     114376MB   2           64 KB     ONLINE *****
Management
Configure
Initialize
Objects
Rebuild
Check Con
*****

***** Logical Drive 0 *****
RAID = 1
Size = 114376MB
Stripe Size
Accept
SPAN = NO
*****

Accept This Logical Drive Configuration And Go To Next Logical Drive
Use Cursor Keys To Navigate Between Items And Press Enter To Select An Option

```

- When finished setting the selected logical drive configuration, select **Accept** from the menu, then press <Enter>.
- Follow steps 5 to 10 to configure additional logical drives.
- When prompted, save the configuration, then press <Esc> to return to the Management Menu.

```

***** Configuration Menu ***** Save Configuration ? *****
Easy Configuration ***** Yes *****
New Configuration ***** No *****
View/Add Configuration *****
***** Logical Drive(s) Configured *****
***** LD   RAID   Size   #Stripes   StripeSz   Status *****
***** 0     1     114376MB   2           64 KB     ONLINE *****
*****

***** Select YES Or NO *****
Use Cursor Keys To Navigate Between Items And Press Enter To Select An Option

```



## 5.2.2 Creating a RAID 10 set

You can create a RAID 10 set using four identical hard disk drives.

To create a RAID 10 set using the **Easy Configuration** option:

1. From the utility main menu, highlight **Configure**, then press <Enter>.
2. Use the arrow keys to select **Easy Configuration**, then press <Enter>.

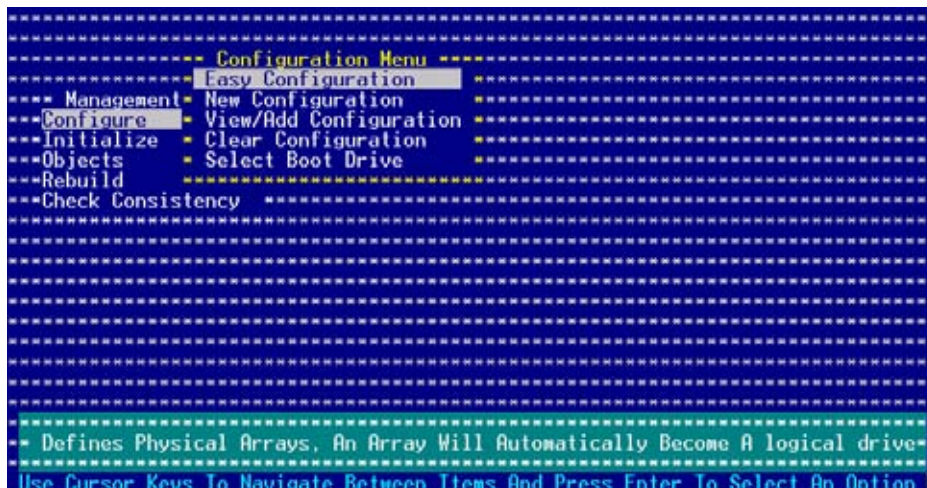

3. The **ARRAY SELECTION MENU** displays the available drives connected to the SATA ports. Select the drive(s) you want to include in the RAID set, then press <SpaceBar>. When selected, the drive indicator changes from **READY** to **ONLIN A[X]-[Y]**, where X is the array number, and Y is the drive number.

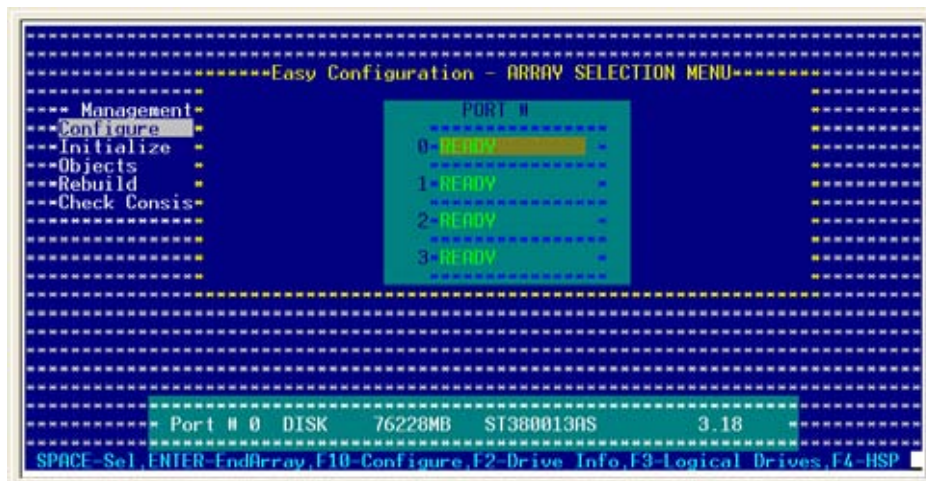

The information of the selected hard disk drive displays at the bottom of the screen.

4. Select all the drives required for the RAID 10 set, then press <Enter>. The configurable array appears on screen.

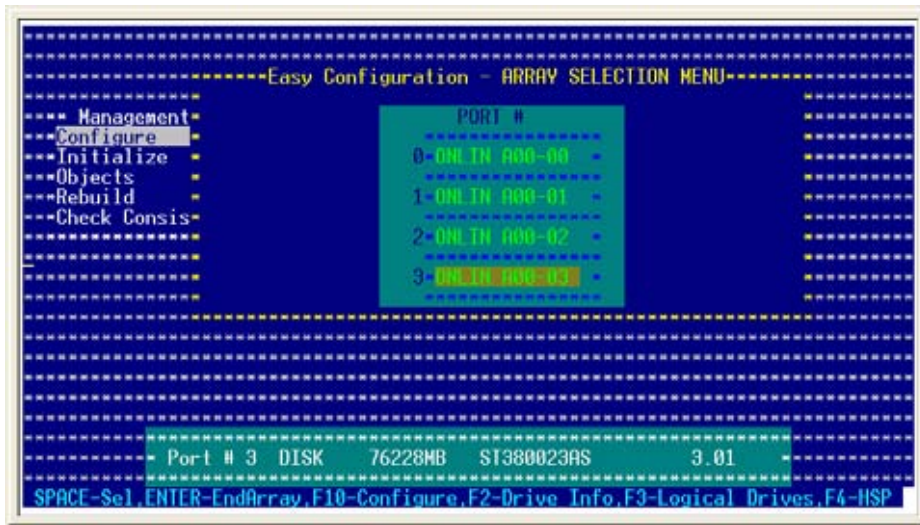

5. Press <F10>, select the configurable array, then press <SpaceBar>.

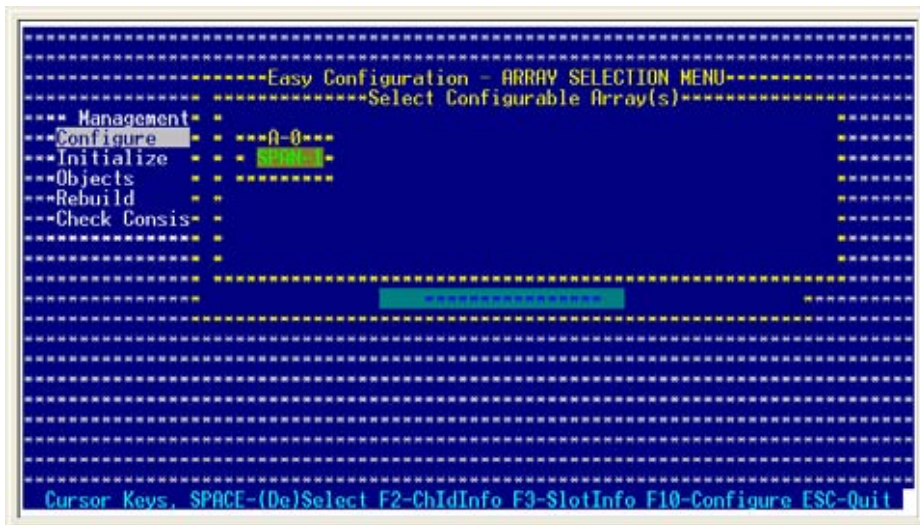

The logical drive information appears including a Logical Drive menu that allows you to change the logical drive parameters.



6. Select **RAID** from the **Logical Drive** menu, then press <Enter>.
7. Select RAID 10 from the menu, then press <Enter>.



You need at least four identical hard disk drives when creating a RAID 10 set.

```

***** Logical Drive(s) Configured *****
***** LD  RAID    Size    #Stripes  StripeSz  Status *****
***** 0      0      304912MB  4         64 KB    ONLINE *****
***** Manage *****
***** Config *****
***** Initializ *****
***** Objects *****
***** Rebuild *****
***** Check Con *****
*****
***** Logical Drive 0 ***** RAID Level *****
***** RAID 0 ***** RAID 0 *****
***** Size = 304912MB ***** RAID 10 *****
***** Stripe Size *****
***** Accept *****
***** SPAN = NO *****
*****
***** Choose RAID Level For This Logical Drive *****
***** Use Cursor Keys To Navigate Between Items And Press Enter To Select An Option *****

```

8. Select **Stripe Size** from the **Logical Drive** menu, then press <Enter>.
9. Key-in the stripe size, then press <Enter>.

```

***** Logical Drive(s) Configured *****
***** LD  RAID    Size    #Stripes  StripeSz  Status *****
***** 0      0      304912MB  4         64 KB    ONLINE *****
***** Manage *****
***** Config *****
***** Initializ *****
***** Objects *****
***** Rebuild *****
***** Check C *****
*****
***** Enter Stripe Size In KB (8,16,32,64,128)? :64 *****
*****
***** Logical Drive 0 ***** RAID Level *****
***** RAID = 10 ***** *****
***** Size = 152456MB *****
***** Stripe Size *****
***** Accept *****
***** SPAN = YES *****
*****
***** Enter Stripe Size In KB (8,16,32,64,128)? : *****
***** Use Cursor Keys To Navigate Between Items And Press Enter To Select An Option *****

```



For server systems, we recommend that you use a lower array block size. For multimedia computer systems used mainly for audio and video editing, we recommend a higher array block size for optimum performance.

- When finished setting the selected logical drive configuration, select **Accept** from the menu, then press <Enter>.

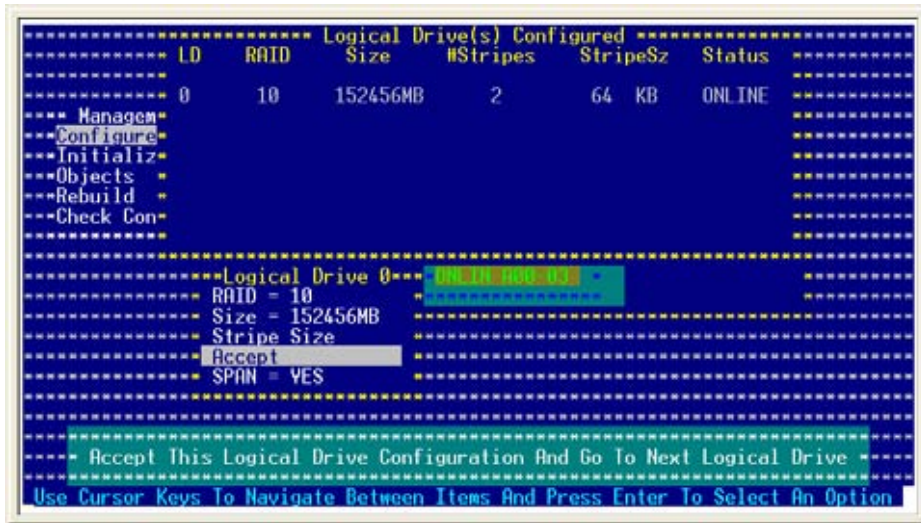

- When prompted, save the configuration, then press <Esc> to return to the Management Menu.

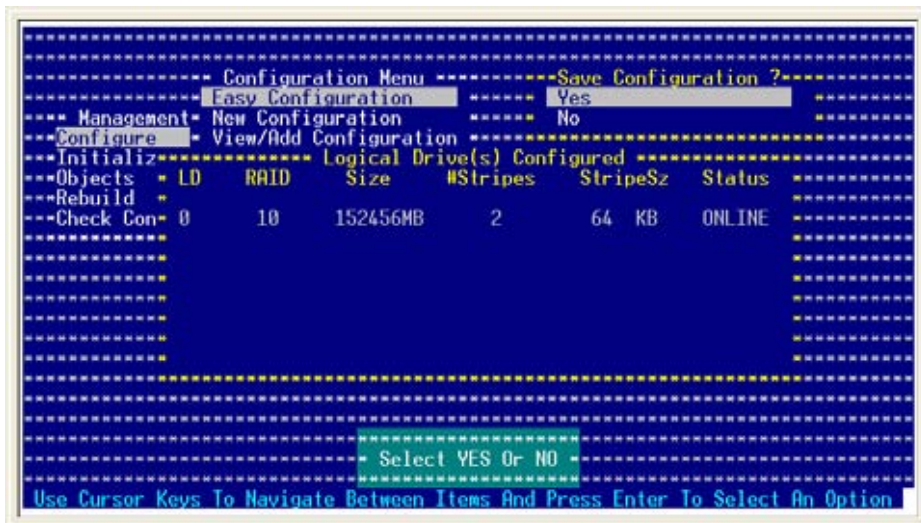

### 5.2.3 Adding or viewing a RAID configuration

You can add a new RAID configuration or view an existing configuration using the **View/Add Configuration** command.

#### Adding a new RAID configuration

To add a new RAID configuration:

1. From the Management Menu, highlight **Configure**, then press <Enter>.
2. Use the arrow keys to select **View/Add Configuration**, then press <Enter>.

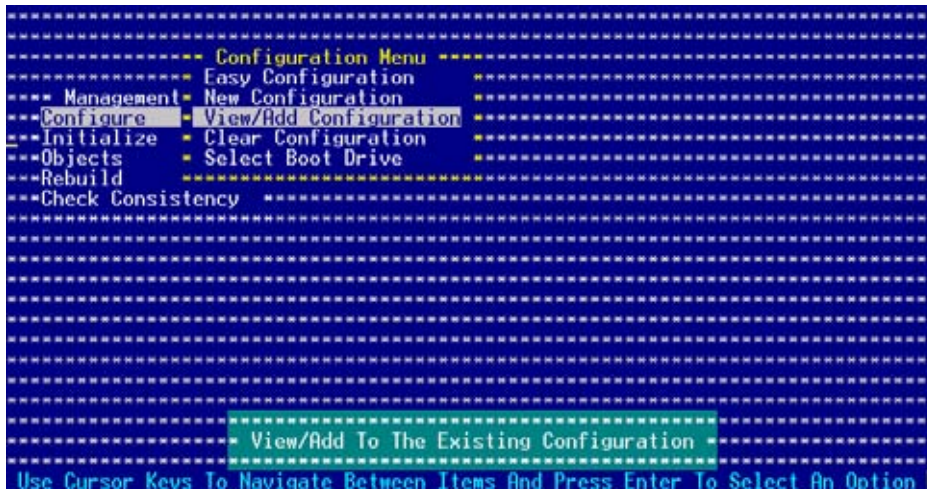

3. The **ARRAY SELECTION MENU** displays the available drives connected to the SATA ports. Select the drive(s) you want to include in the RAID set, then press <SpaceBar>. When selected, the drive indicator changes from **READY** to **ONLIN A[X]-[Y]**, where X is the array number, and Y is the drive number.



The information of the selected hard disk drive displays at the bottom of the screen.

- Select all the drives required for the RAID set, then press <Enter>. The configurable array appears on screen.

```

*****View/Add Configuration - ARRAY SELECTION MENU*****
Management
Configure
Initialize
Objects
Rebuild
Check Consis
Port #
0-ONLINE 000-00
1-ONLINE 0000-011
Port # 1 DISK 114376MB HDS722512VL SN80 V330A6MA
SPACE-Sel ENTER-EndArray F10-Configure F2-Drv. Info F3-Logical Drives

```

- Press <F10>, select the configurable array, then press <SpaceBar>.

```

*****View/Add Configuration - ARRAY SELECTION MENU*****
*****Select Configurable Array(s)*****
Management
Configure
Initialize
Objects
Rebuild
Check Consis
a-0
SCAN
Cursor Keys, SPACE-(De)Select F2-ChIdInfo F3-SlotInfo F10-Configure F5C-Quit

```

The logical drive information appears including a Logical Drive menu that allows you to change the logical drive parameters.

```

***** Logical Drive(s) Configured *****
LD RAID Size #Stripes StripeSz Status
0 1 114376MB 2 64 KB ONLINE
Management
Configure
Initialize
Objects
Rebuild
Check Con
*****
-Logical Drive 0-
RAID = 1
Size = 114376MB
Stripe Size
Accept
SPAN = NO
*****
Choose RAID Level For This Logical Drive
Use Cursor Keys To Navigate Between Items And Press Enter To Select An Option

```

6. Follow steps 6 to 7 of the **Creating a RAID set: Using Easy Configuration** section.
7. Select **Size** from the **Logical Drive** menu, then press <Enter>.
8. Key-in the desired logical drive size, then press <Enter>.

```

***** Logical Drive(s) Configured *****
***** LD   RAID   Size   #Stripes   StripeSz   Status *****
***** 0     1     114376MB   2          64 KB     ONLINE *****
***** Managem*****
***** Configure*****
***** Initializ*****
***** Objects *****
***** Rebuild *****
***** Check C*****
***** Enter Logical Drive Size (MB) :114376 *****
***** Logical Drive 0*****
***** RAID = 1 *****
***** Size = 114376MB *****
***** Stripe Size *****
***** Accept *****
***** SPAN = NO *****
***** Enter Logical Drive Size (MB) :*****
Use Cursor Keys To Navigate Between Items And Press Enter To Select An Option

```

9. Follow steps 8 to 13 of the **Creating a RAID set: Using Easy Configuration** section to add the new RAID configuration.

## 5.2.4 Initializing the logical drives

After creating the RAID set(s), you must initialize the logical drives. You may initialize the logical drives of a RAID set(s) using the **Initialize** or **Objects** command on the Management Menu.

### Using the Initialize command

To initialize the logical drive using the **Initialize** command:

1. From the Management Menu, highlight **Initialize**, then press <Enter>.

```
***** Management Menu *****
-- Configure
-- Initialize
-- Objects
-- Rebuild
-- Check Consistency
*****

***** Initialize Logical Drive(s) *****
Use Cursor Keys To Navigate Between Items And Press Enter To Select An Option
```

2. The screen displays the available RAID set(s) and prompts you to select the logical drive to initialize. Use the arrow keys to select the logical drive from the **Logical Drive** selection, then press <Enter>.

```
***** Logical Drive(s) Configured *****
-- Management Menu -- LD  RAID  Size  #Stripes  StripeSz  Status
-- Configure
-- Initialize
-- Objects
-- Rebuild
-- Check Consistency
*****

***** Logical Drives *****
-- Logical Drive 0
*****

***** Select Logical Drive *****
SPACE-(0c)Select, F10-Initialize
```







2. Select **Logical Drive** from the **Objects** sub-menu, then press <Enter>.

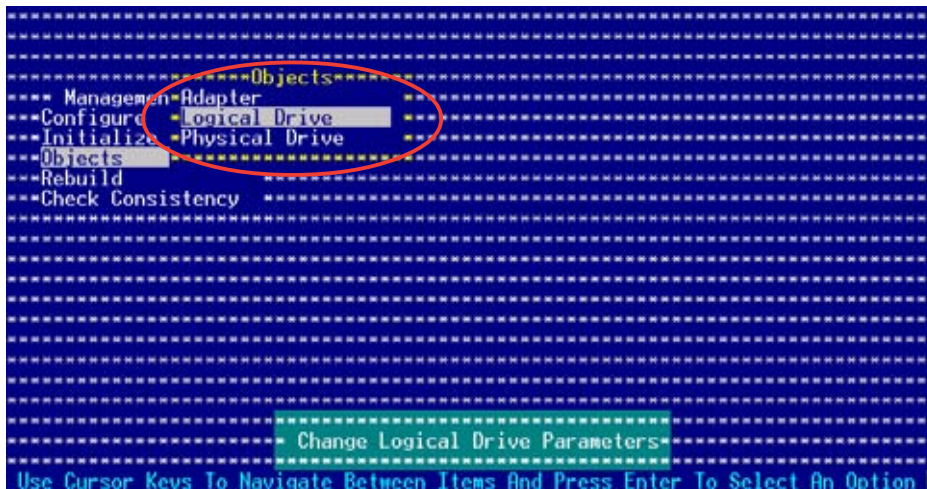

3. Select the logical drive to initialize from the **Logical Drives** sub-menu, then press <Enter>.

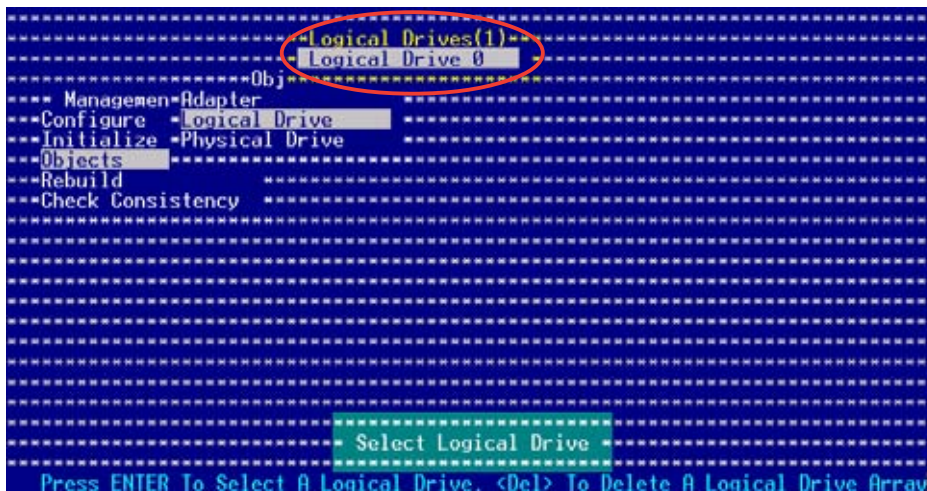

4. Select Initialize from the pop-up menu, then press <Enter> to start initialization.

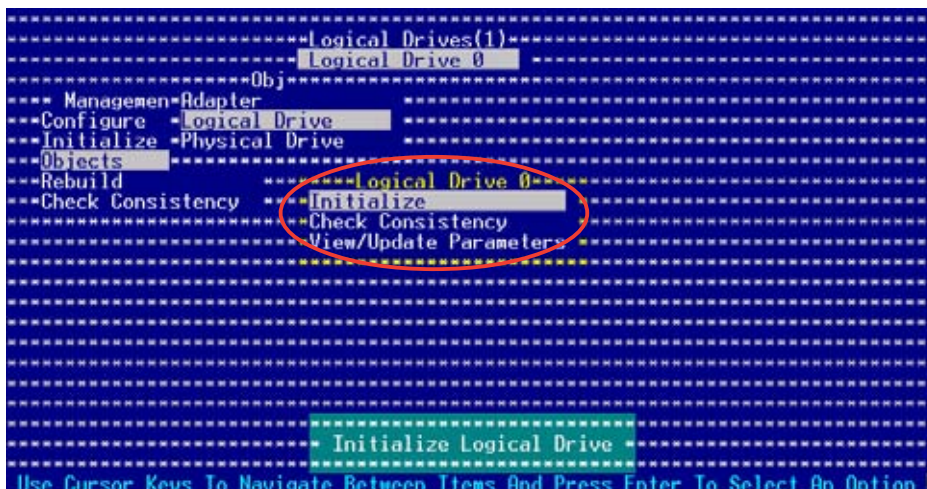



## 5.2.5 Rebuilding failed drives

You can manually rebuild failed hard disk drives using the **Rebuild** command in the Management Menu.

To rebuild a failed hard disk drive:

1. From the Management Menu, highlight **Rebuild**, then press <Enter>.

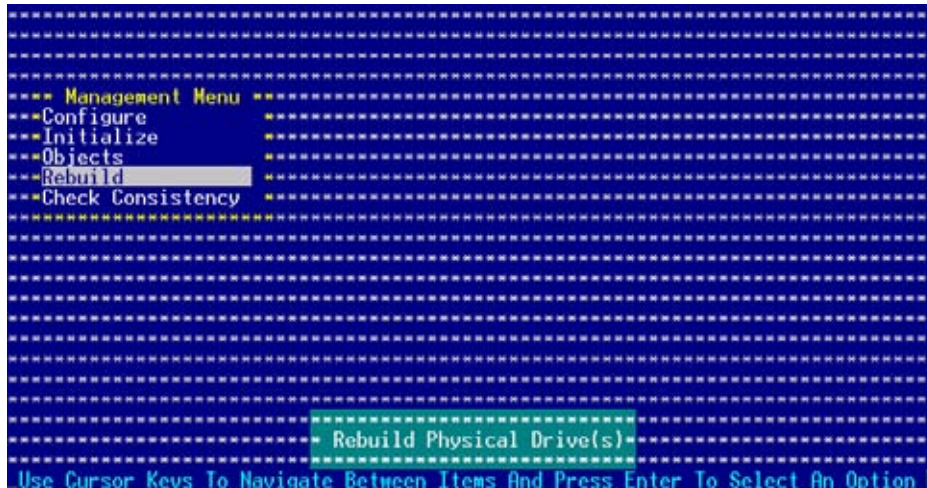

2. The **PHYSICAL DRIVES SELECTION MENU** displays the available drives connected to the SATA ports. Select the drive you want to rebuild, then press <SpaceBar>.

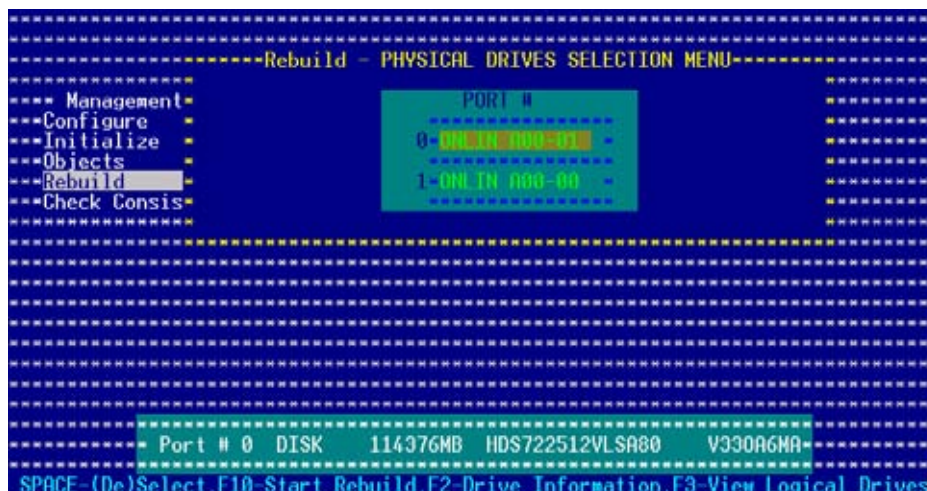

3. After selecting the drive to rebuild, press <F10>. The indicator for the selected drive now shows **RBLD**.

```
-----Rebuild - PHYSICAL DRIVES SELECTION MENU-----
Management
Configure
Initialize
Objects
Rebuild
Check Consis

PORT #
0-RBLD 000-01
1-ON LN 000-00

Port # 0 DISK 114376MB HDS722512VLSA80 V330A6MA
SPACE (Del)Select F10-Start Rebuild F2-Drive Information F3-View Logical Drives
```

4. When prompted, press <Y> to to rebuild the drive.

```
-----Rebuild - PHYSICAL DRIVES SELECTION MENU-----
Management
Configure
Initialize
Objects

Rebuilding Drive Will Take Few Minutes. Start Rebuilding Drive (Y/N)?

Port # 0 DISK 114376MB HDS722512VLSA80 V330A6MA
SPACE (Del)Select F10-Start Rebuild F2-Drive Information F3-View Logical Drives
```

5. When rebuild is complete, press any key to continue.

## 5.2.6 Checking the drives for data consistency

You can check and verify the accuracy of data redundancy in the selected logical drive. The utility can automatically detect and/or detect and correct any differences in data redundancy depending on the selected option in the **Objects** > **Adapter** menu.



---

The Check Consistency command is available only for logical drives included in a RAID 1 set.

---

### Using the Check Consistency

To check data consistency using the **Check Consistency** command:

1. From the Management Menu, select **Check Consistency**, then press <Enter>.

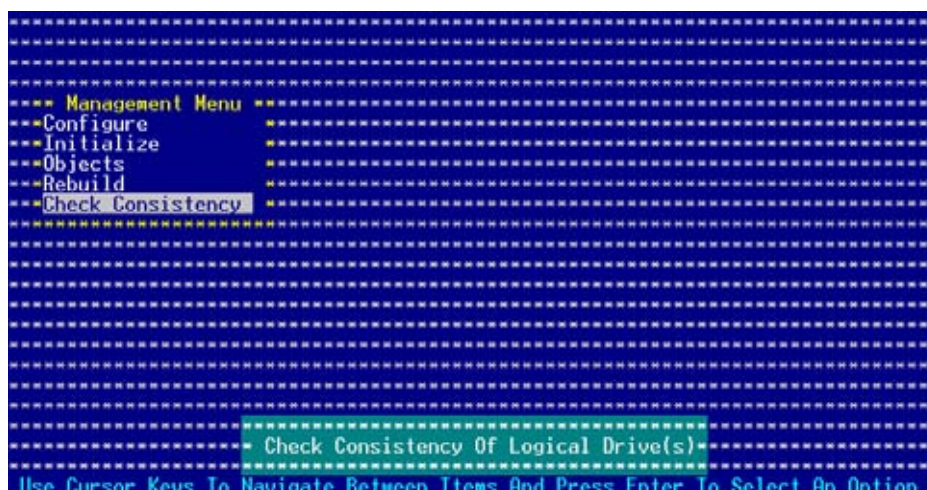

2. The screen displays the available RAID set(s) and prompts you to select the logical drive to check. Use the arrow keys to select the logical drive from the **Logical Drive** selection, then press <Enter>.

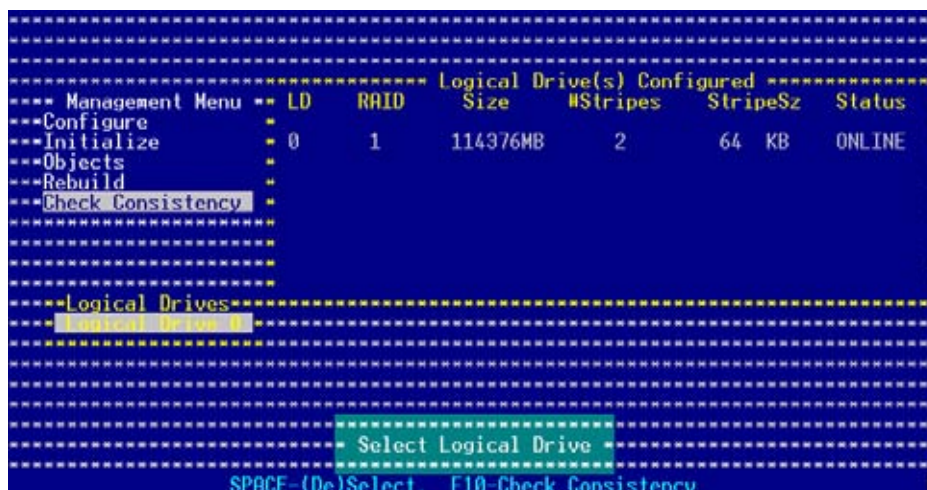

- When prompted, press the <SpaceBar> to select **Yes** from the **Consistency Check** dialog box, then press <Enter>. You may also press <F10> to check the drive consistency.

```
***** Logical Drive(s) Configured *****
Management Menu ** LD  RAID  Size  #Stripes  StripeSz  Status
--Configure
--Initialize      * 0   1   114376MB  2         64 KB   ONLINE
--Objects
--Rebuild
--Check Consistency
***** Consistency Check *****
* Yes
* No
*****
--Logical Drives
--Logical Drive 0
*****
-- Select Logical Drive
SPACE-(De)Select, F10-Check Consistency
```

A progress bar appears on screen.

```
***** Logical Drive(s) Configured *****
Management Menu ** LD  RAID  Size  #Stripes  StripeSz  Status
--Configure
--Initial          ***** Consistency Check ***** ONLINE
--Objects
--Rebuild+        Consistency Check Under Progress. Press ESC to ABORT.
--Check C
*****
/ 0 % Completed
*****
--Logica
--Logical Drive 0
*****
SPACE-(De)Select, F10-Check Consistency
```

- While checking the disk consistency, press <Esc> to display the following options.
  - Stop - Stops the consistency check. The utility stores the percentage of disk checked, When you restart checking, it continues from the last percentage completed rather than from zero percent.
  - Continue - Continues the consistency check.
  - Abort - Aborts the consistency check. When you restart checking, it continues from zero percent.
- When checking is complete, press any key to continue.

## Using the Objects command

To check data consistency using the **Objects** command:

1. From the Management Menu, select **Objects**, then select **Logical Drive** from the menu.
2. Use the arrow keys to select the logical drive you want to check, then press <Enter>.
3. Select **Check Consistency** from the pop-up menu, then press <Enter>.
4. When prompted, press <Y> to to check the drive.
5. When checking is complete, press any key to continue.





## 5.2.8 Selecting the boot drive from a RAID set

You must have created a new RAID configuration before you can select the boot drive from a RAID set. Refer to the **Creating a RAID set: Using New Configuration** section for details.

To select the boot drive from a RAID set:

1. From the Management Menu, select **Configure > Select Boot Drive**, then press <Enter>.

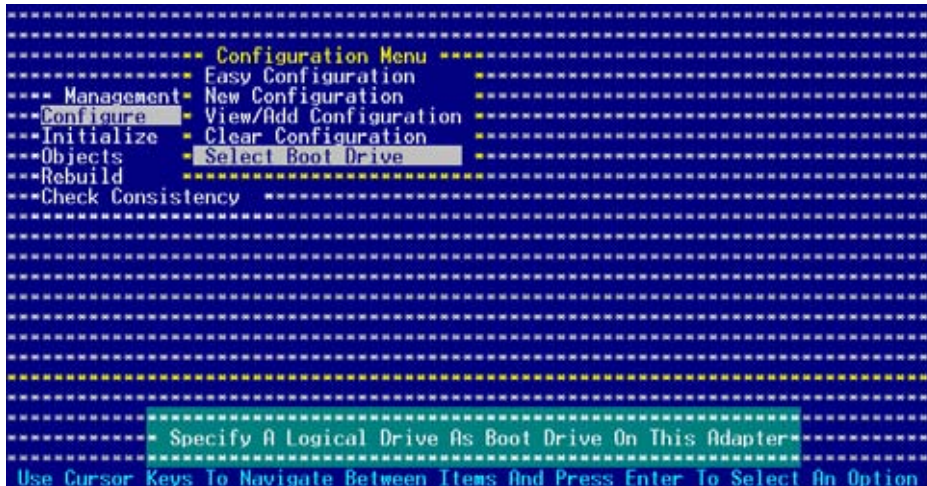

2. When prompted, press the <SpaceBar> to select the bootable logical drive from the list, then press <Enter>.

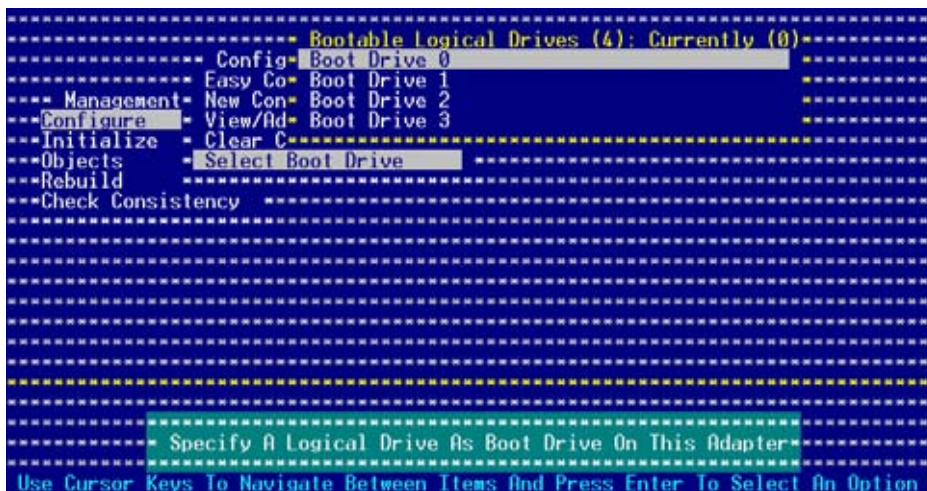

3. The logical drive is selected as boot drive. Press any key to continue.

## 5.2.9 Enabling the WriteCache

You may enable the RAID controller's **WriteCache** option to improve the data transmission performance.



When you enable WriteCache, you may lose data when a power interruption occurs while transmitting or exchanging data among the drives.

To enable WriteCache:

1. From the Management Menu, select **Objects > Adapter**, then press <Enter> to display the adapter properties.
2. Select **WriteCache**, then press <Enter> to turn the option **On** (enabled).

```
***** Adapter 0 *****
*****
***** RbldRate      = 80 *****
***** BiosState     = Enable *****
***** StopOnError   = No *****
***** NewDevice     = Auto Configuration *****
***** FastInit      = Enable *****
***** ChkConState   = Report Only *****
***** WriteCache    = Off *****
***** ReadAhead     = On *****
***** Auto Rebuild  = On *****
***** AutoResume    = Enable *****
***** DiskCoercion = 10 GB *****
***** Factory Default *****
*****
*****
***** Write Cache *****
Use Cursor Keys To Navigate Between Items And Press Enter To Select An Option
```

3. When finished, press any key to continue.

## 5.3 Global Array Manager

You may also create a RAID set(s) in Windows® operating environment using the Global Array Manager (GAM) application. The GAM application is available from the motherboard support CD.



Refer to the GAM user guide in the motherboard support CD for details.

## 5.4 LSI Logic Configuration Utility

The LSI Logic Configuration Utility allows you to create RAID 0, RAID 1, and RAID-1E from SCSI hard disk drives connected to the SCSI connectors supported by the LSI53C1020A PCI-X SCSI controller.

To enter the LSI Logic Configuration Utility:

1. Turn on the system after installing all the SATA hard disk drives.
2. During POST, Press <Ctrl> + <C> to enter the LSI Logic Configuration Utility.

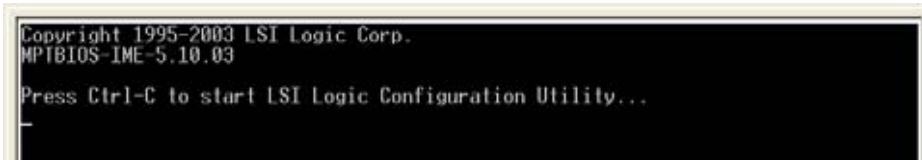

The LSI Logic Configuration Utility main menu appears.

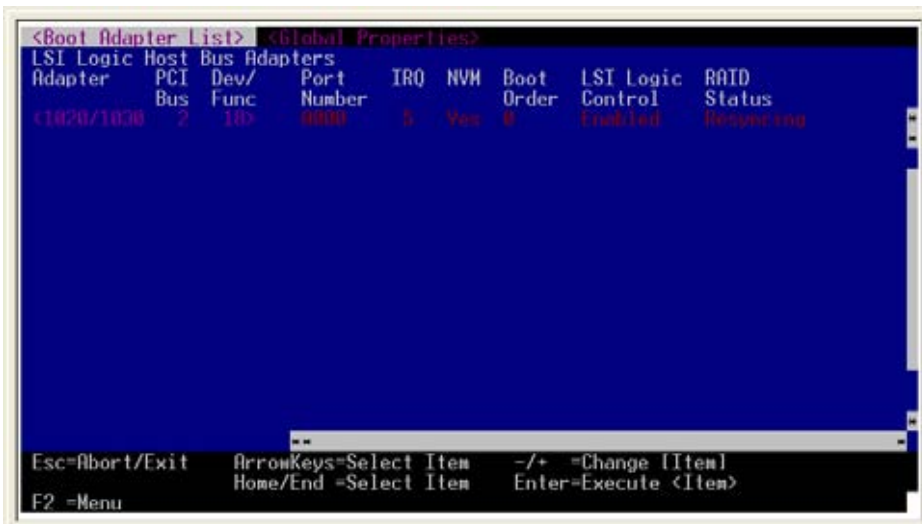

The LSI Logic Configuration Utility has two tabbed menus that you can select by pressing <F2>. Refer to the next section for details.

## 5.4.1 Boot Adapter List

The **Boot Adapter List** tab allows you to select and configure the SCSI controller, create arrays, and arrange the sequence of available boot adapters.

### Changing the adapter boot sequence

To change the adapter boot sequence:

1. Select the adapter from the list (1020/1030), then press <Insert>. The screen displays the selected adapter's properties. Refer to the table below for a description of the properties.
2. Move the selection to the **Boot Order** column, then press the <+> or <-> key to adjust the adapter boot sequence.

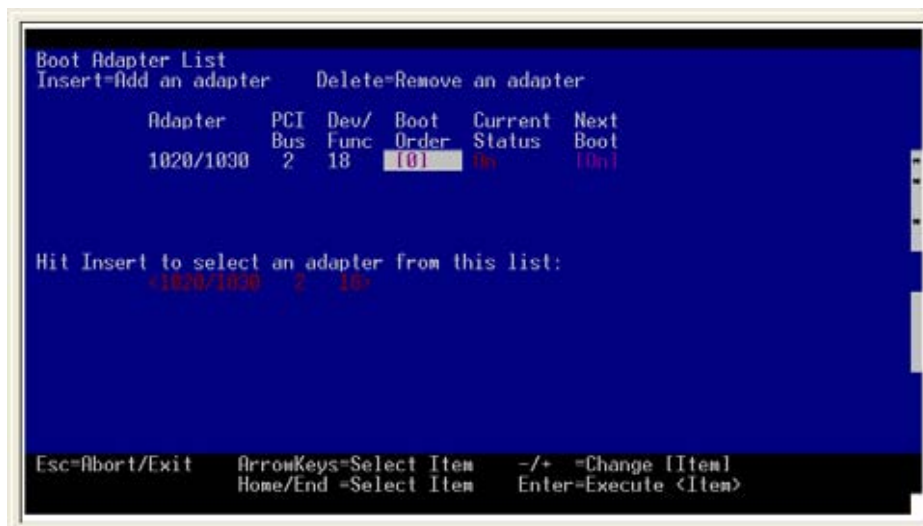

Property	Description
<b>Adapter</b>	Identifies the specific family of LSI Logic Host Adapters.
<b>PCI Bus</b>	Identifies the PCI Bus number assigned by the system BIOS to an adapter (range 0x00 - 0xFF, 0 - 255 decimal).
<b>Dev/Func</b>	Identifies the PCI Device/Function assigned by the system BIOS to the selected adapter.
<b>Boot Order</b>	Identifies the relative boot order (0 to 3) of an adapter. The Fusion-MPT SCSI BIOS traverses up to four adapters in the specified order in search of bootable media. Access the "Boot Adapter List" Menu to modify this item.

3. When finished, press <Enter> to open the **Adapter Properties** screen; otherwise, press <Esc> to exit the utility.

## 5.4.2 Global Properties

The **Global Properties** tab allows you to configure the general adapter properties. To access the general properties screen, select the adapter from the list, then press <Enter>.

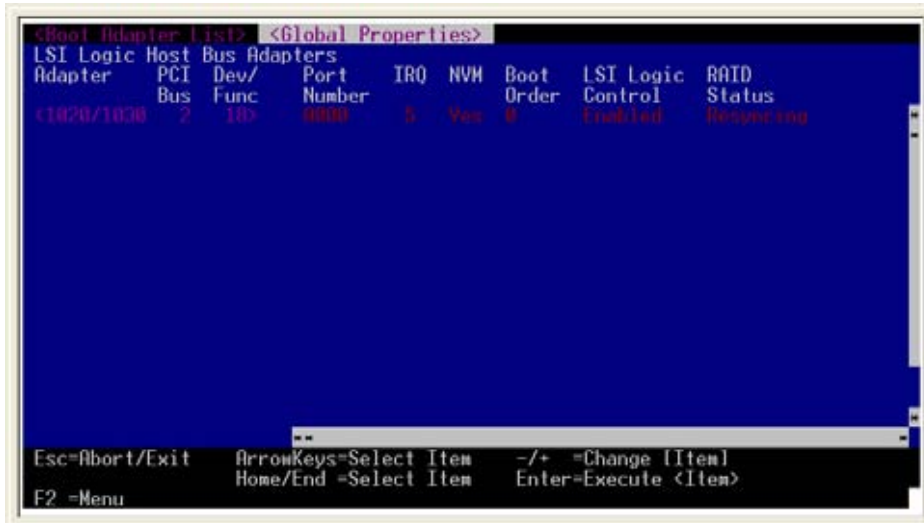

### Changing the general adapter properties

To change the general adapter properties:

1. Select an item from the Global Properties screen, then press <+> or <-> change the value.

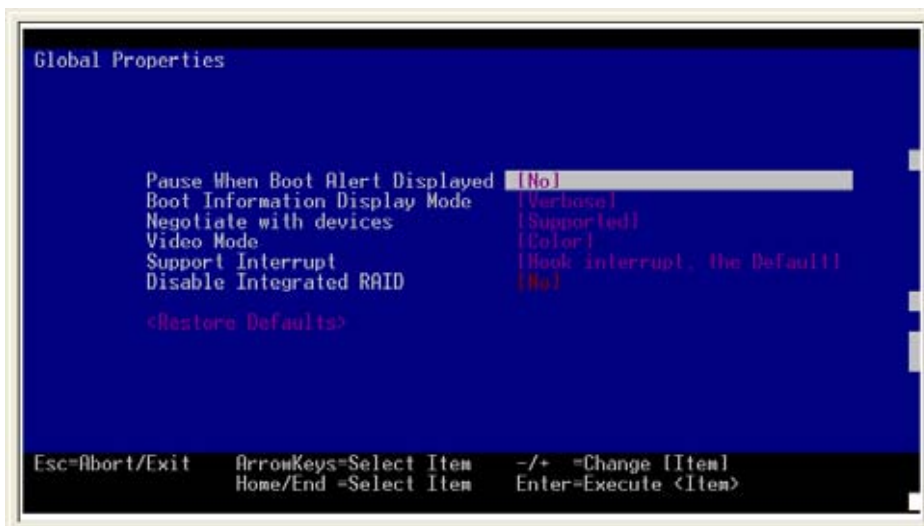

### Pause When Boot Alert Displayed

This option specifies whether to pause for user acknowledgement after displaying an alert message during boot. If you want the user to press any key after displaying the alert message, set this item to [Yes]. Set this item to [No] to continue the boot after displaying the alert message.

### **Boot Information Display Mode**

Allows you to specify the amount of displayed information for the adapters and devices during POST. To display minimum information, set this item to [Terse]. To display detailed information, select [Verbose]

### **Negotiate with devices**

Sets the default value for synchronous and wide negotiations with specified devices. Configuration options: [All] [None] [Supported].

### **Video Mode**

Specifies the default video mode for the Configuration Utility. You can set the Video Mode to [Color] or [Monochrome]. Set this item to [Monochrome] for better screen readability when using a monochrome monitor.

### **Support Interrupt**

Allows you to prevent a hook on INT40, if required.

### **Disable Integrated RAID**

Allows you to disable bus scan search for RAID member devices. This item also allows you to disable configuration of RAID arrays in the BIOS.

### **<Restore Defaults>**

Allows you to load the default settings. Select this item, then press <Enter> to revert to the default settings.

### 5.4.3 Adapter Properties

The **Adapter Properties** page allows you to configure the device and RAID properties. To access the adapter properties screen, select the adapter from the Boot Adapter List, then press <Enter>.



The **Adapter Properties** page appears.

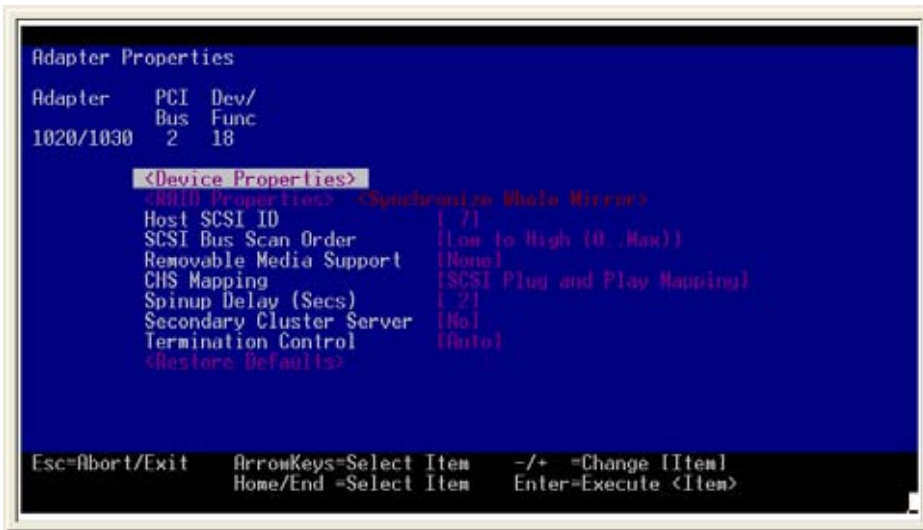

The **Adapter Properties** page allows you to go to the **Device Properties** page or the **RAID Properties** page. Refer to the corresponding sections for details.

## Changing the adapter properties

To change the adapter properties, select an item from the Global Properties screen, then press <+> or <-> change the value. Refer to the items description below.

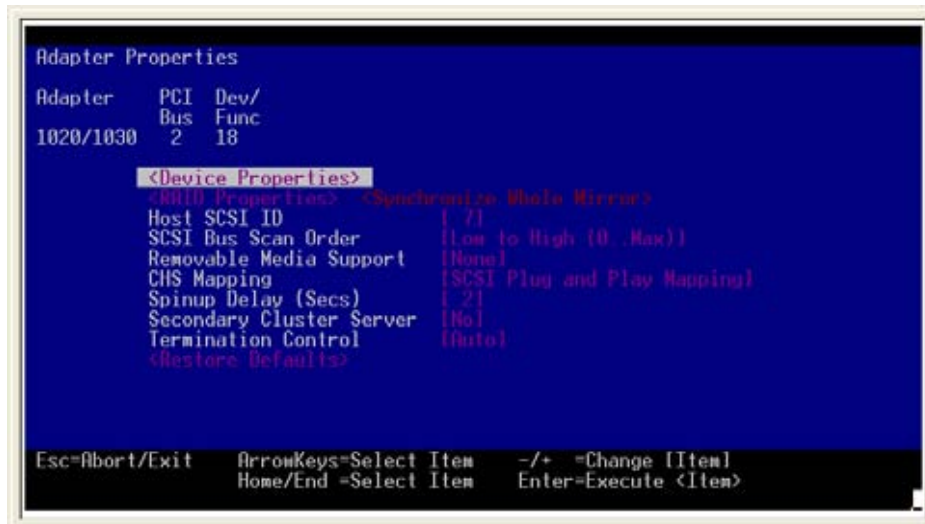

### Pause When Boot Alert Displayed

This option specifies whether to pause for user acknowledgement after displaying an alert message during boot. If you want the user to press any key after displaying the alert message, set this item to [Yes]. Set this item to [No] to continue the boot after displaying the alert message.

#### <Device Properties>

Allows you to view and modify the device properties. Press <Enter> to display the **Device Properties** page.

#### <RAID Properties>

Allows you to view, create, delete, and/or configure RAID arrays. Press <Enter> to display the **RAID Properties** page.

#### <Synchronize Whole Mirror>

Allows you to copy the data from the mirrored array primary copy to the secondary copy.

#### Host SCSI ID

Indicates the SCSI identifier of an adapter [0-7] or [0-15]. It is recommended to set this item to the highest priority SCSI identifier, which is 7.



---

8-bit SCSI devices can not see identifiers greater than 7.

---



## SCSI Bus Scan Order

Indicates the order in which to scan SCSI identifiers on an adapter. Changing this item will affect drive letter assignment(s) if more than one device is attached to an adapter.



---

Changing this item may conflict with an operating system that automatically assigns drive order.

---

## Removable Media Support

Allows you to specify the removable media support option for an adapter. Select [None] to disable removable media support whether the drive is selected as first (BBS), or is first in the scan order (non-BBS). Set this item to [Boot Drive Only] to enable removable media support for a removable hard drive if it is first in the scan order. Select [With Media Installed] to enable support for removable media regardless of the drive ordering.

## CHS Mapping

Defines how the Cylinder Head Sector values are mapped into a disk without pre-existing partition information. CHS Mapping allows either **SCSI Plug and Play Mapping** (default value) or **Alternate CHS Mapping**.

SCSI Plug and Play Mapping automatically determines the most efficient and compatible mapping.

Alternate CHS Mapping uses an alternate, possibly less efficient mapping that may be required if a device is moved between adapters from different vendors.



---

These options has no effect after a disk has been partitioned using the FDISK command. To change the CHS Mapping on a partitioned disk, use FDISK command to delete all partitions, then reboot the system to clear memory. If not, the old partitioning data will be reused, thus nullifying the previous operation.

---



---

Ensure that the correct disk is the target of an FDISK command.

---

## Spinup Delay (Secs)

Determines the waiting time (in seconds) between spinups of devices attached to an adapter. Staggered spinups will balance the total electrical current load on the system during boot. The default value is 2 seconds. Configuration options: 1 ~ 10 seconds

## Secondary Cluster Server

Specifies whether an adapter has one or more devices that are attached or are shared with another adapter(s). When you set this option to [Yes] the Fusion-MPT PCI SCSI BIOS avoids SCSI Bus resets as much as possible when two or more devices are shared with the other adapter.

This option allows you to enable an adapter to join a cluster of adapters without doing any SCSI bus resets. This is a requirement for the Microsoft Cluster Server. The default value is [No].

## Termination Control

Indicates whether an adapter has automatic termination control, and displays the current termination control status, if any. When set to [Auto], the adapter automatically determines whether it should enable or disable its termination. Set to [Off] allows the devices at the ends of the SCSI bus to terminate the bus.



---

When the option [Auto] is grayed out, termination is automatic and is non-configurable.

---

## Restore Defaults

Select this option, then press <Enter> to load the default settings.

## Device Properties

The **Device Properties** page allows you update and view individual devices connected to the adapter. To open the device properties screen, select the **<Device Properties>** from the Adapter Properties window, then press **<Enter>**. The Device Properties screen appears.

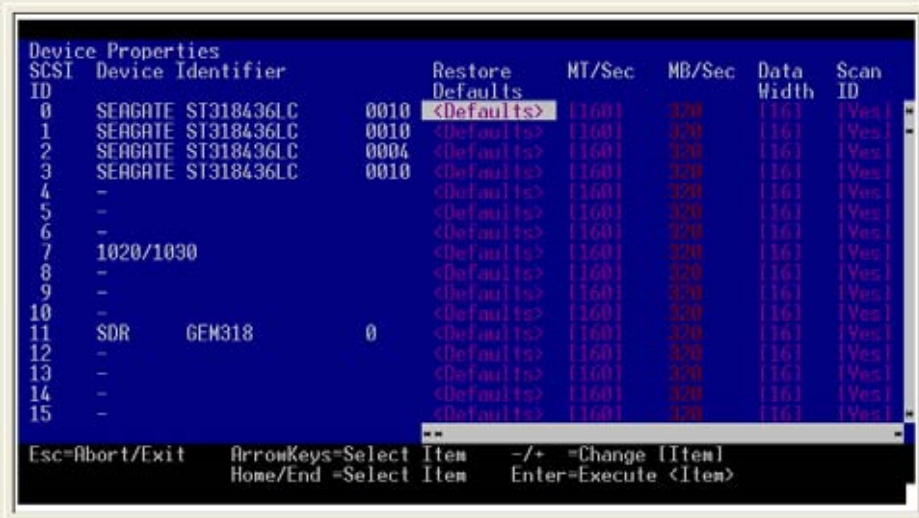

The screenshot shows a terminal window titled "Device Properties" with a table of SCSI device settings. The table has columns for SCSI ID, Device Identifier, Restore Defaults, MT/Sec, MB/Sec, Data Width, and Scan ID. The first four rows show SEAGATE ST318436LC devices with various Restore Defaults values (0010, 0010, 0004, 0010). The remaining rows show dashes for Device Identifier and Restore Defaults, and "1020/1030" for MT/Sec. The Scan ID column is consistently [Yes]. At the bottom, there are control instructions: Esc=Abort/Exit, ArrowKeys=Select Item, Home/End =Select Item, +/- =Change [Item], and Enter=Execute <Item>.

SCSI ID	Device Identifier	Restore Defaults	MT/Sec	MB/Sec	Data Width	Scan ID
0	SEAGATE ST318436LC	0010	<Defaults>	320	166	[Yes]
1	SEAGATE ST318436LC	0010	<Defaults>	320	166	[Yes]
2	SEAGATE ST318436LC	0004	<Defaults>	320	166	[Yes]
3	SEAGATE ST318436LC	0010	<Defaults>	320	166	[Yes]
4	-	<Defaults>	1160	320	166	[Yes]
5	-	<Defaults>	1160	320	166	[Yes]
6	-	<Defaults>	1160	320	166	[Yes]
7	1020/1030	<Defaults>	1160	320	166	[Yes]
8	-	<Defaults>	1160	320	166	[Yes]
9	-	<Defaults>	1160	320	166	[Yes]
10	-	<Defaults>	1160	320	166	[Yes]
11	SDR GEM318	0	<Defaults>	320	166	[Yes]
12	-	<Defaults>	1160	320	166	[Yes]
13	-	<Defaults>	1160	320	166	[Yes]
14	-	<Defaults>	1160	320	166	[Yes]
15	-	<Defaults>	1160	320	166	[Yes]

### SCSI ID

Displays the SCSI identifier of each device connected to the adapter.

### Device Identifier

Displays the ASCII device identifier string extracted from the device's Inquiry Data.

### Sync Rate

Displays the maximum synchronous data transfer rate, in Mega Transfers per second.

### Data Width

Displays the maximum data width in bits.

### Scan ID

Specifies whether to scan for the SCSI device during boot. Set this item to [No] when:

- You want the system to ignore a device and decrease boot time.
- You do not want the device to be available to the system.
- Disable scan on a bus with only a few attached devices.

## **Scan LUNs > 0**

Allows you to scan for LUNs greater than zero for a device. LUN zero is always queried. Use this option if a multi-LUN device responds to unoccupied LUNs or if it is desired to reduce the visibility of a multi-LUN device to LUN zero only.

Set this option to [No] if you have problems with a device that responds to all LUNs whether they are occupied or not. Also, set this item to [No] if a SCSI device with multiple LUNs exists on your system but you do not want all of those LUNs to be available. This will limit the scan to LUN 0 only.

## **Disconnect**

Displays whether to allow a device to disconnect during SCSI operations. Some (mostly newer) devices may run faster when you enable this option, while some (mostly older) devices may run faster when you disable this option.

## **SCSI Timeout**

This field indicates the maximum amount of time [0 to 9999 seconds] to wait for a SCSI operation to complete. While timeouts provide a safeguard that allows the system to recover should an operation fail, it is recommended that you use a value greater than zero. A value of zero allows unlimited time for an operation to complete and could result in the system hanging should an operation fail.

Press <Enter>, type in a value, and then press <Enter> again to set a new timeout value.

## **Queue Tags**

Allows you to use queue tags for a device. Currently, the BIOS does not use queue tags. This item specifies queue tag control to higher level device drivers.

## RAID Properties

The **RAID Properties** page allows you update and view individual devices connected to the adapter. To open the device properties screen, select the **<Device Properties>** from the Adapter Properties window, then press **<Enter>**. The Device Properties screen appears.

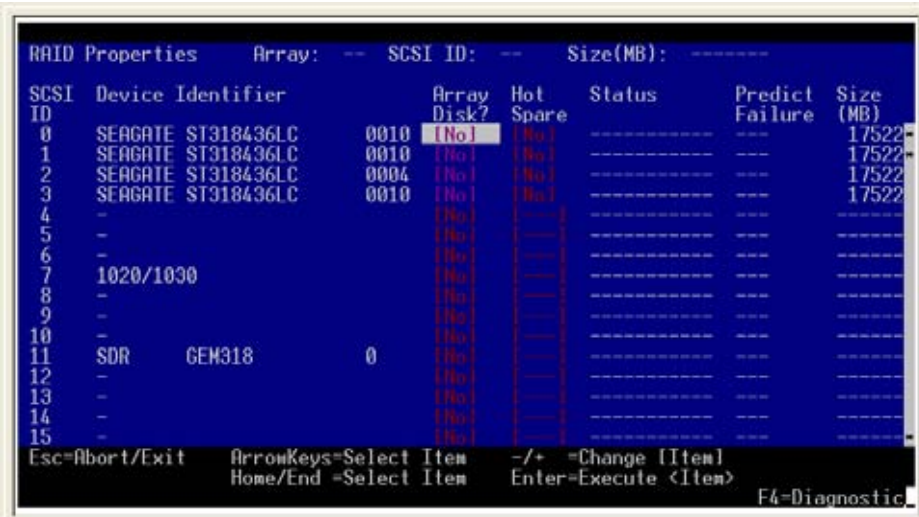

The screenshot shows the RAID Properties screen with the following data:

SCSI ID	Device Identifier	Array	SCSI ID	Size(MB)	Array Disk?	Hot Spare	Status	Predict Failure	Size (MB)
0	SEAGATE ST318436LC	0010	[No]	[No]	[No]	[No]	-----	---	17522
1	SEAGATE ST318436LC	0010	[No]	[No]	[No]	[No]	-----	---	17522
2	SEAGATE ST318436LC	0004	[No]	[No]	[No]	[No]	-----	---	17522
3	SEAGATE ST318436LC	0010	[No]	[No]	[No]	[No]	-----	---	17522
4	-	-	[No]	[No]	[No]	[No]	-----	---	-----
5	-	-	[No]	[No]	[No]	[No]	-----	---	-----
6	-	-	[No]	[No]	[No]	[No]	-----	---	-----
7	1020/1030	-	[No]	[No]	[No]	[No]	-----	---	-----
8	-	-	[No]	[No]	[No]	[No]	-----	---	-----
9	-	-	[No]	[No]	[No]	[No]	-----	---	-----
10	-	-	[No]	[No]	[No]	[No]	-----	---	-----
11	SDR GEM318	0	[No]	[No]	[No]	[No]	-----	---	-----
12	-	-	[No]	[No]	[No]	[No]	-----	---	-----
13	-	-	[No]	[No]	[No]	[No]	-----	---	-----
14	-	-	[No]	[No]	[No]	[No]	-----	---	-----
15	-	-	[No]	[No]	[No]	[No]	-----	---	-----

At the bottom of the screen, there are navigation instructions: Esc=Abort/Exit, ArrowKeys=Select Item, Home/End =Select Item, +/- =Change [Item], Enter=Execute <Item>, and F4=Diagnostic.

### SCSI ID

Displays the SCSI ID that the operating system or application addresses the array.

### Size(MB)

Displays the size of the array.

### Array Disk?

Select [Yes] to include the drive in a disk array. You can select a minimum of two drives and a maximum of six drives. Select a maximum of five drives when you select a hot spare.

### Hot Spare

Sets the drive as a hot spare. You can select a single hot spare. The Hot Spare disk provides additional protection by automatically replacing an array member when it fails.

### Status

Displays the status of each physical disk in the array.

### Predict Failure

Tells whether SMART has determined that the disk will fail in the future.

### Size

Shows the physical size of the drive. When the drive is part of an array, this shows the size used for the array.

## 5.4.4 Creating a RAID 1 (Mirror) set

You can create two types of mirrored configuration using the LSI Logic Configuration Utility: Integrated Mirroring (IM) or RAID 1-E. See section 5.1.1 for RAID definitions.

To create an RAID 1 set:

1. From the **RAID Properties** screen, select the drives that you want to include in the RAID 1 set.



For Integrated Mirrored array, select first the drive with data that you want to retain. This drive will become the primary copy of the array.

- Integrated Mirrored array - Select a minimum of two drives
- RAID-1E - Select a minimum of four drives

The **Array** label on top of the screen changes to IM or 1E depending on the number of selected hard disk drives.

```
RAID Properties   Array: IM   SCSI ID: 0   Size(MB): 17398
SCSI Device Identifier
ID              SEAGATE ST318436LC   Array Disk?   Hot Spare   Status   Predict Failure   Size (MB)
0               SEAGATE ST318436LC   0010 [Yes]       [No]         -----
1               SEAGATE ST318436LC   0010 [Yes]       [No]         -----
2               SEAGATE ST318436LC   0004 [No]        [No]         -----
3               SEAGATE ST318436LC   0010 [No]        [No]         -----
4               -                    -            -            -            -----
5               -                    -            -            -            -----
6               -                    -            -            -            -----
7               1020/1030            -            -            -            -----
8               -                    -            -            -            -----
9               -                    -            -            -            -----
10              -                    -            -            -            -----
11              SDR    GEM318           0           [No]         -----
12              -                    -            -            -            -----
13              -                    -            -            -            -----
14              -                    -            -            -            -----
15              -                    -            -            -            -----
Esc=Abort/Exit  ArrowKeys=Select Item  -/+ =Change [Item]
Home/End =Select Item  Enter=Execute <Item>
F4=Diagnostic
```

Integrated Mirroring

```
RAID Properties   Array: 1E   SCSI ID: 0   Size(MB): 34796
SCSI Device Identifier
ID              SEAGATE ST318436LC   Array Disk?   Hot Spare   Status   Predict Failure   Size (MB)
0               SEAGATE ST318436LC   0010 [Yes]       [No]         -----
1               SEAGATE ST318436LC   0010 [Yes]       [No]         -----
2               SEAGATE ST318436LC   0004 [Yes]       [No]         -----
3               SEAGATE ST318436LC   0010 [Yes]       [No]         -----
4               -                    -            -            -            -----
5               -                    -            -            -            -----
6               -                    -            -            -            -----
7               1020/1030            -            -            -            -----
8               -                    -            -            -            -----
9               -                    -            -            -            -----
10              -                    -            -            -            -----
11              SDR    GEM318           0           [No]         -----
12              -                    -            -            -            -----
13              -                    -            -            -            -----
14              -                    -            -            -            -----
15              -                    -            -            -            -----
Esc=Abort/Exit  ArrowKeys=Select Item  -/+ =Change [Item]
Home/End =Select Item  Enter=Execute <Item>
F4=Diagnostic
```

RAID-1E

2. After selecting the drives, press <Esc>.
3. When prompted, select <Save changes, then exit this menu>, then press <Enter> to create the RAID 1 set.

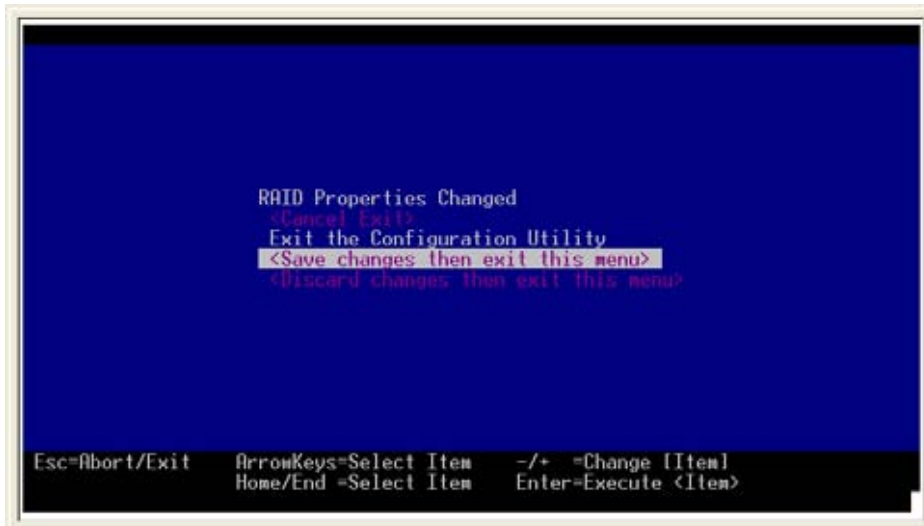

## 5.4.5 Creating a RAID 0 (Stripe) set

You can create a striped array using the LSI Logic Configuration Utility.

To create a RAID 0 set:

1. From the **RAID Properties** screen, select the drives that you want to include in the RAID 0 set.

The **Array** label on top of the screen changes to IS (Integrated Striping).

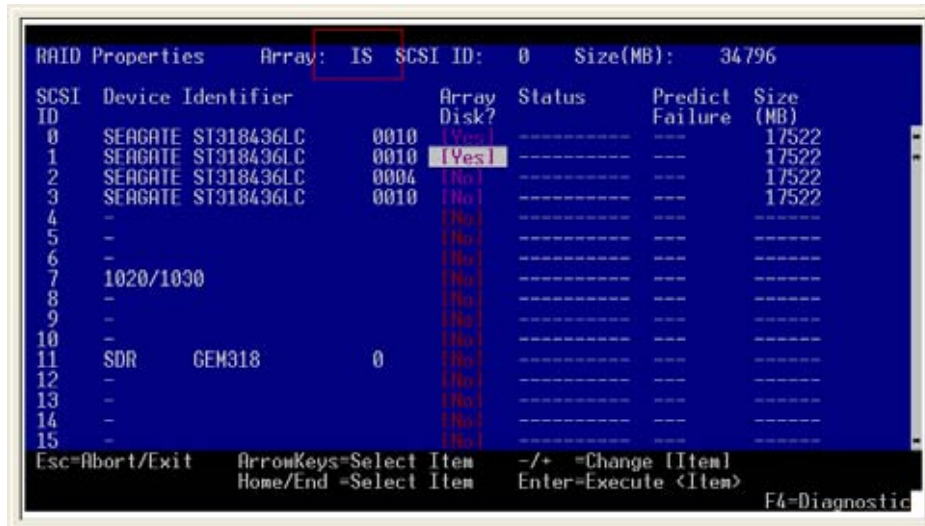

2. After selecting the drives, press <Esc>.
3. When prompted, select <Save changes, then exit this menu>, then press <Enter> to create the RAID 0 set.

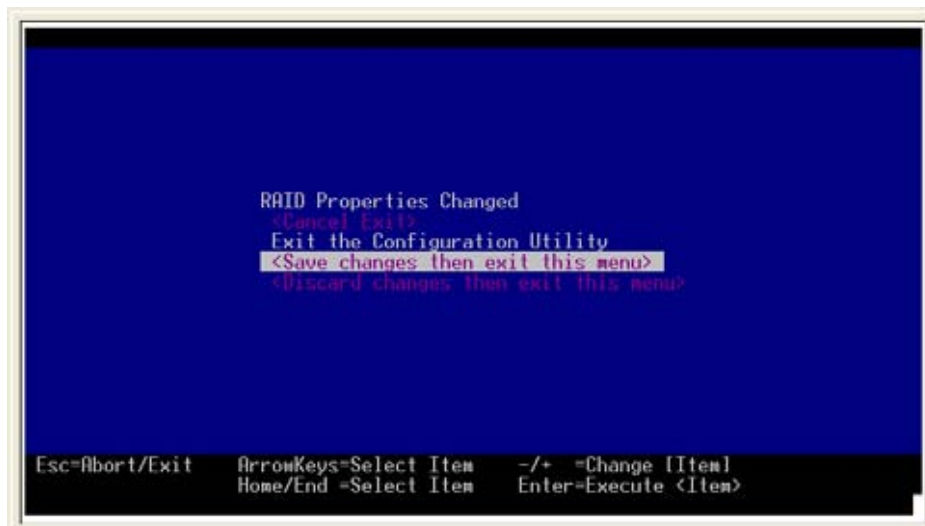



## 5.4.6 Running the Diagnostic Mode

Before creating the array, you may press <F4> to run a diagnostic tool on each drive in the system. After checking the drives, the diagnostic tool displays a code under the **Size** column of the RAID Properties screen. Refer to the table below for the description of the diagnostic codes.

Code	Description
1	Problem with reading disk serial number
2	Disk does not support SMART
3	Unused
4	Disk does not support wide data, synchronous mode, or queue tagging
5	User disabled, disconnects, or queue tags for device (Device Properties)
6	Unused
7	Disk not big enough to mirror primary disk
8	Unused
9	Unused
10	Disk does not have 512 byte sector size
11	Incorrect device type
12	Hot Spare selection not big enough to be used as an array disk
13	Maximum disks already specified or Maximum array size would be exceeded

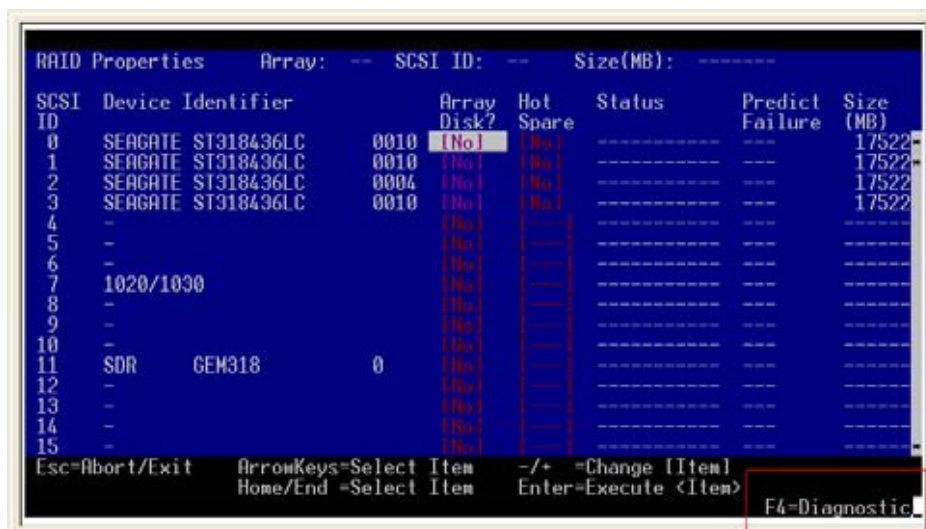

Diagnostic Mode

## 5.4.7 Managing arrays

After creating the array, return to the **Boot Adapter List** screen, select the adapter, then press <Enter>.

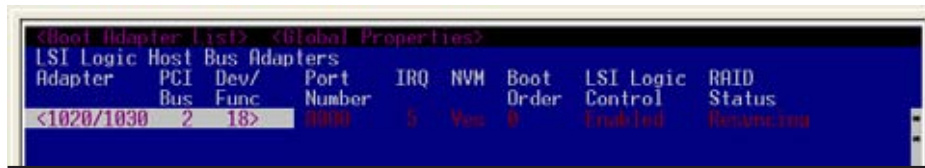

Select <RAID Properties> from the Adapter Properties screen, then press <Enter>.

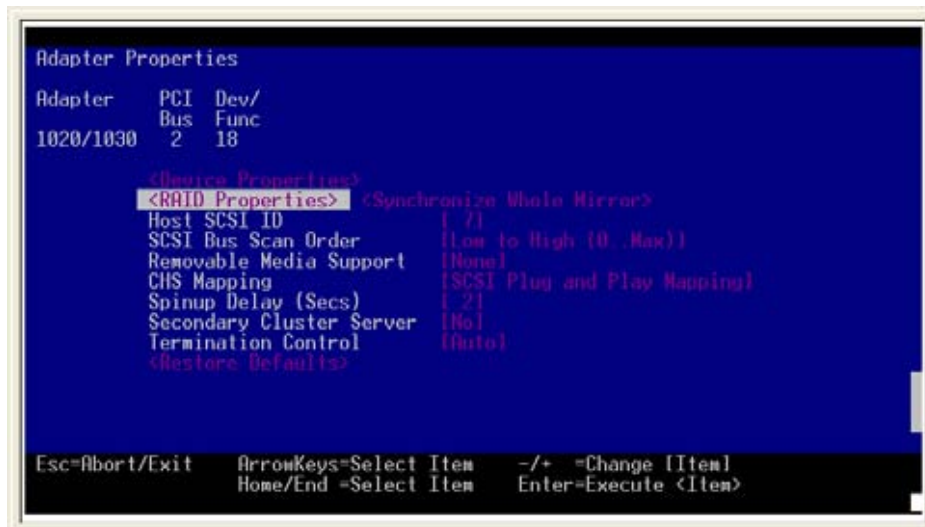

A tabbed menu appears on the top panel of the RAID Properties screen. You can now delete, add/delete hot spare drives, and/or activate arrays using the tabbed menus. Press <F2> to switch tabbed menus.

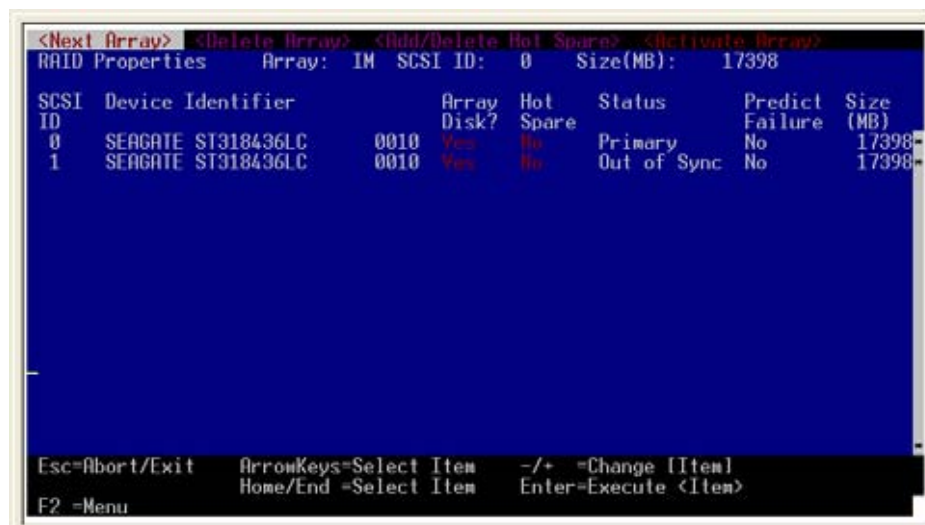

## Deleting arrays

To delete an array:

1. Press <F2> to select **<Delete Array>**.
2. Use the arrow keys to select the array you want to delete, then press <Enter>.
3. Press <Esc>.

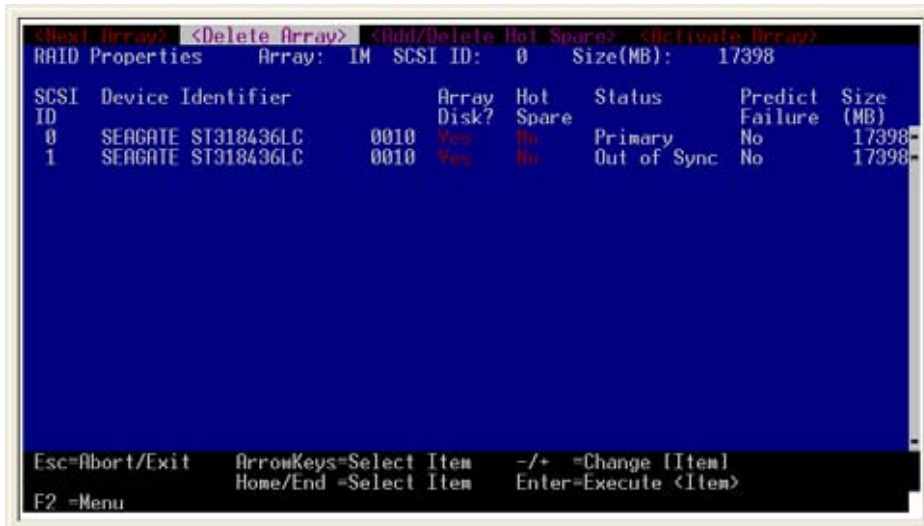

4. When prompted, select **<Save changes, then exit this menu>**, then press <Enter>.

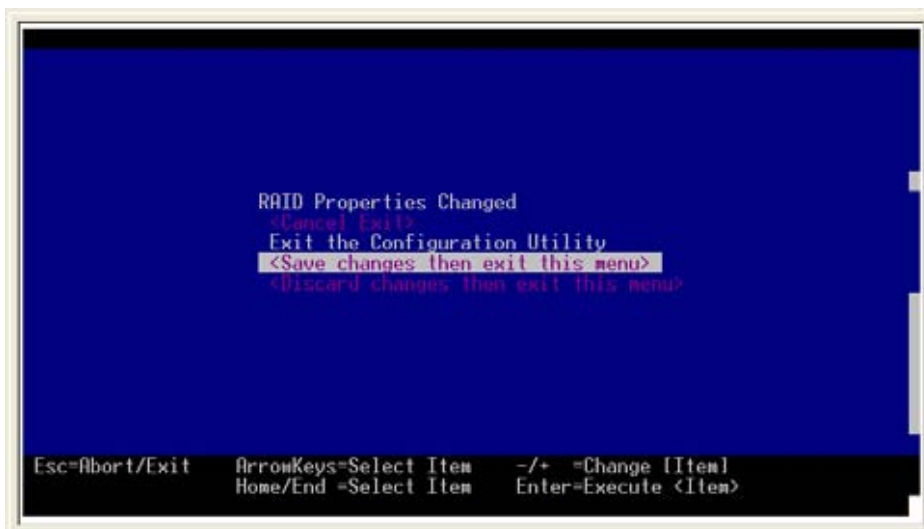

## Adding or deleting a hot spare drive

To add a hot spare drive assigned to a RAID set:

1. From the RAID Properties screen, press <F2> to select **<Add/Delete Hot Spare>**.

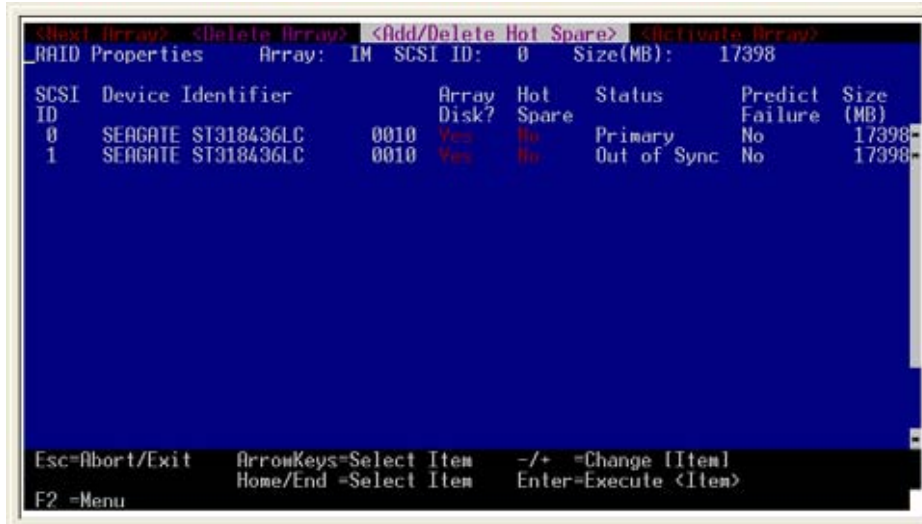

2. Use the arrow keys to select the drive you want to assign as spare.
3. Move the selection to the **Hot Spare** column, then press <Enter>.

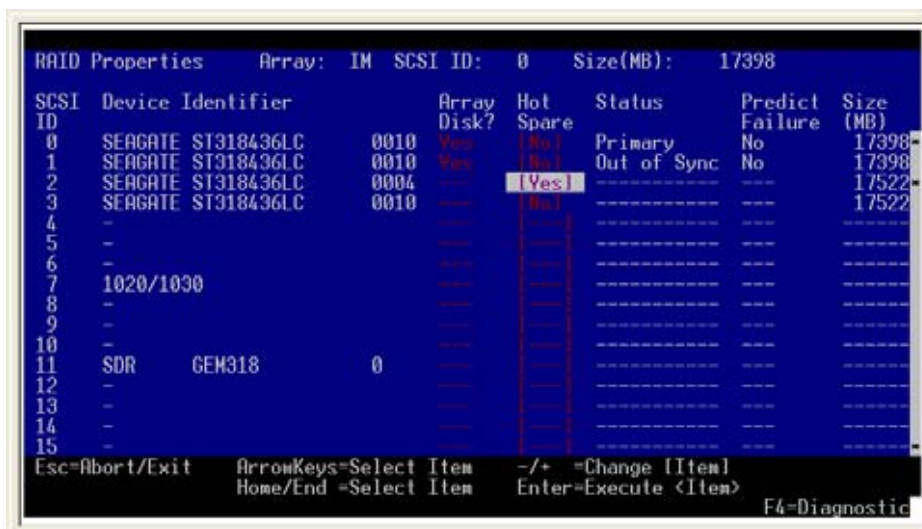

4. Press <Esc>.
5. When prompted, select **<Save changes, then exit this menu>**, then press <Enter>.

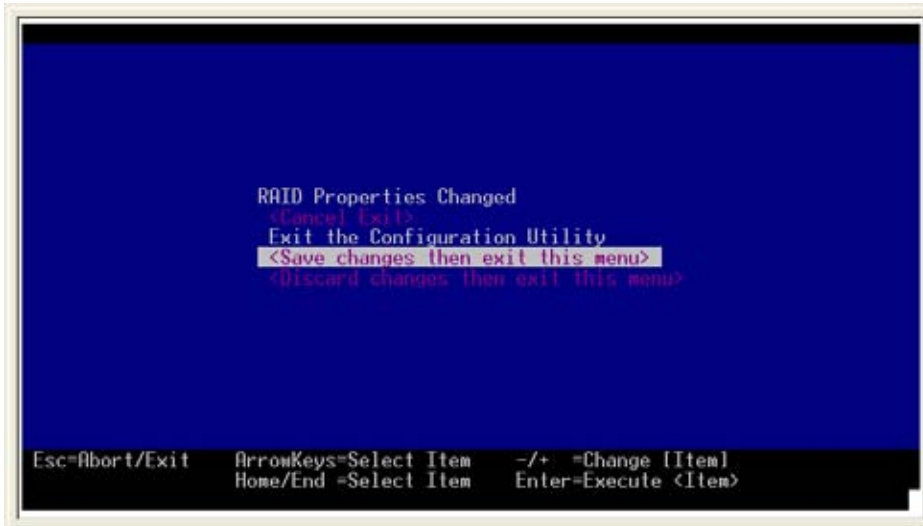

To delete a hot spare drive assigned to a RAID set:

1. From the RAID Properties screen, press <F2> to select **<Add/Delete Hot Spare>**.
2. Use the arrow keys to select the spare drive you want to delete.
3. Move the selection to the **Hot Spare** column, then press <Enter> to change the Hot Spare status to **[No]**.
4. Press <Esc>.
5. When prompted, select **<Save changes, then exit this menu>**, then press <Enter>.

## Next Array

The Next Array menu allows you to select the other array on the physical adapter. This screen is enabled when there are more than one array on a physical adapter. The RAID Properties screen allows display of one array at a time. This menu allows you to display and operate on the other array(s) detected.

## Activate Array

When there are two arrays on a physical adapter, this menu allows you to instruct the RAID firmware to activate a selected array. Only one array may be activated at a time for each physical adapter. For a physical adapter with multiple arrays, activating one array disables all the remaining arrays.



This chapter provides instructions for installing the necessary drivers for different system components.

# 6 Driver installation

## Chapter summary



6.1	RAID driver installation .....	6-1
6.2	LAN driver installation .....	6-11
6.3	VGA driver installation .....	6-13
6.4	Management applications and utilities installation .....	6-15



## 6.1 RAID driver installation

After creating the RAID sets for your server system, you are now ready to install an operating system to the independent hard disk drive or bootable array. This part provides instructions on how to install the RAID controller drivers during OS installation.

### 6.1.1 Creating a RAID driver disk



---

You may have to use another system to create the RAID driver disk from the system/motherboard support CD or from the Internet.

---

A floppy disk with the RAID driver is required when installing Windows® 2000/XP or Red Hat® Enterprise ver. 3.0/SuSE operating system on a hard disk drive that is included in a RAID set. You can create a RAID driver disk in DOS (using the Makedisk application in the support CD).

To create a RAID driver disk in DOS environment:

1. Place the motherboard support CD in the optical drive.
2. Restart the computer, then enter the BIOS Setup.
3. Select the optical drive as the first boot priority to boot from the support CD. Save your changes, then exit the BIOS Setup.
4. Restart the computer.
5. Press any key when prompted to boot from CD.

```
Loading FreeDOS FAT KERNEL GO!  
Press any key to boot from CDROM...
```

The Makedisk menu appears.

```
b) Create ICH7R LSI MegaRAID IDE Driver for RHEL4 Driver Disk  
c) Create ICH7R LSI MegaRAID IDE Driver for RHEL4 64 bit Driver Disk  
d) Create ICH7R LSI MegaRAID IDE Driver for SLES9 SP1 Driver Disk  
e) Create ICH7R LSI MegaRAID IDE Driver for SLES9 SP1 64 bit Driver Disk  
f) Create ICH7R LSI MegaRAID IDE Driver for SUSE93 Driver Disk  
g) Create ICH7R LSI MegaRAID IDE Driver for Win 32/64 bit Driver Disk  
h) Create ICH7R Intel Matrix Storage for Win32 driver disk  
i) Create ICH7R Intel Matrix Storage for Win64 driver disk  
j) Create LSI Logic Fusion-MPT MiniPort for Win2K 32 bit driver  
k) Create LSI Logic Fusion-MPT MiniPort for Win2K3 32/64 bit driver  
l) Create LSI Logic Fusion-MPT MiniPort for RH3.0AS driver  
m) Broadcom Firmware Update  
Please choose a ~ m:
```

6. Place a blank, high-density floppy disk to the floppy disk drive, then select the type of RAID driver disk you want to create by typing the number before the option
7. Press <Enter>.
8. Follow screen instructions to create the driver disk.



---

For systems with Red Hat® Enterprise versions that are not listed in the Makedisk menu, explore the support CD and copy the RAID driver disk from the following path: **\Drivers\Chipset\ICH\LSI\Driver\Linux**.

---

## 6.1.2 Installing the RAID controller driver

### Windows® 2000/2003 Server OS

#### During Windows® 2000/2003 Server OS installation

To install the RAID controller driver when installing Windows® 2000/2003 Server OS:

1. Boot the computer using the Windows® 2000/2003 Server installation CD. The **Windows® 2000/2003 Setup** starts.



2. Press <F6> when the message “**Press F6 if you need to install a third party SCSI or RAID driver...**” appears at the bottom of the screen.
3. When prompted, press <S> to specify an additional device.



4. Insert the RAID driver disk you created earlier to the floppy disk drive, then press <Enter>.



5. Select the RAID controller driver from the list, then press <Enter>.

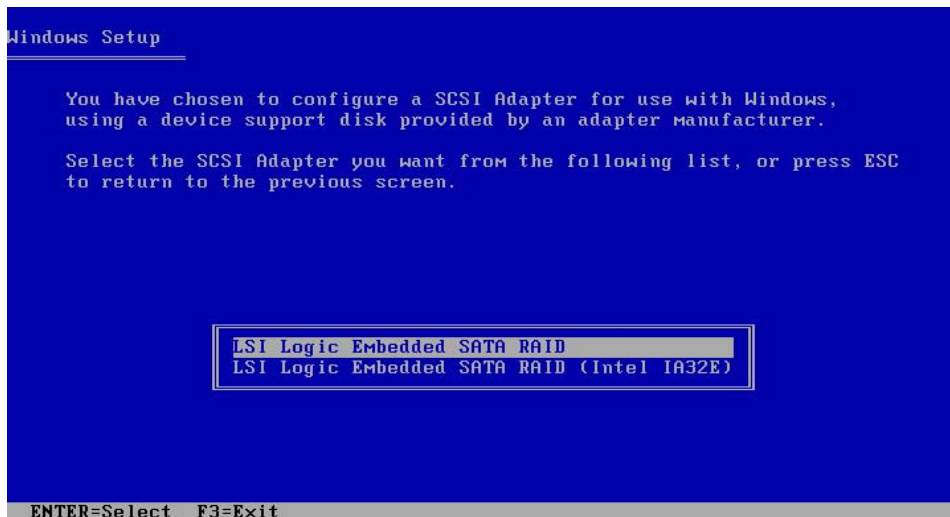

- For Intel® ICH7R LSI Logic Embedded SATA RAID driver, select LSI Logic Embedded SATA RAID.
  - For LSI53C1020A PCI-X SCSI controller driver, select LSI Logic PCI/SCSI/FC MPI Miniport Driver (P5MT/SCSI model only).
6. The Windows® 2000/2003 Setup loads the RAID controller drivers from the RAID driver disk. When prompted, press <Enter> to continue installation.
  7. Setup then proceeds with the OS installation. Follow screen instructions to continue.

## To an existing Windows® 2000/2003 Server OS

To install the RAID controller driver on an existing Windows® 2000/2003 Server OS:

1. Restart the computer, then log in with **Administrator** privileges.
2. Windows® automatically detects the RAID controller and displays a **New Hardware Found** window. Click **Cancel**.
3. Right-click the **My Computer** icon on the Windows® desktop , then select **Properties** from the menu.
4. Click the **Hardware** tab, then click the **Device Manager** button to display the list of devices installed in the system.

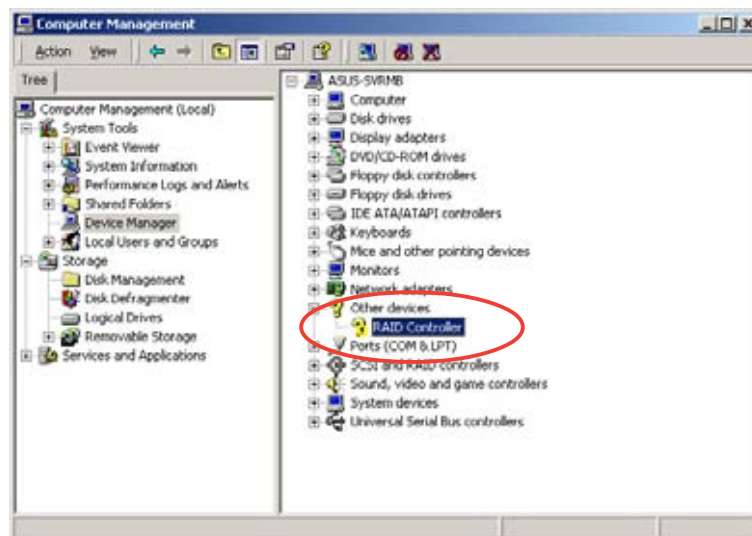

5. Right-click the **RAID controller** item, then select **Properties**.
6. Click the **Driver** tab, then click the **Update Driver** button.
7. The **Upgrade Device Driver Wizard** window appears. Click **Next**.
8. Insert the RAID driver disk you created earlier to the floppy disk drive.
9. Select the option “**Search for a suitable driver for my device (recommended)**”, then click **Next**.
10. The wizard searches the RAID controller drivers. When found, click **Next** to install the drivers.
11. Click **Finish** after the driver installation is done.

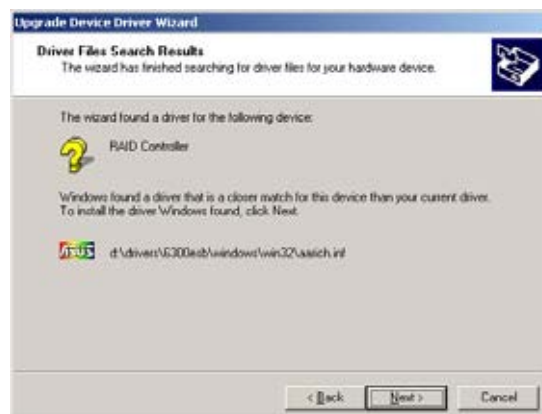

To verify the RAID controller driver installation:

1. Right-click the **My Computer** icon on the Windows® desktop , then select **Properties** from the menu.
2. Click the **Hardware** tab, then click the **Device Manager** button.
3. Click the “+” sign before the item **SCSI and RAID controllers**.

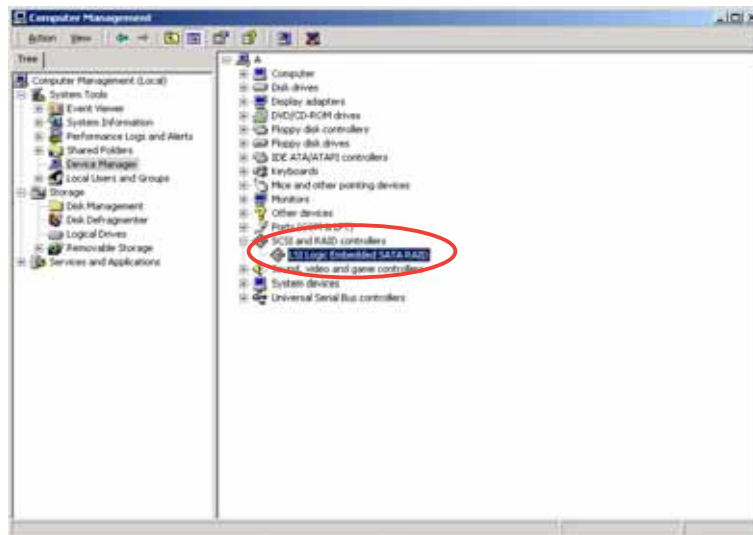

- For P5MT model, the **LSI Logic Embedded SATA RAID** item should appear.
  - For P5MT/SCSI model, the **LSI Logic Embedded SATA RAID** item and the **LSI Logic PCI/SCSI/FC MPI Miniport Driver** items should appear.
4. Right-click the RAID controller driver item, then select **Properties** from the menu.
  5. Click the **Driver** tab, then click the **Driver Details** button to display the RAID controller drivers.
  6. Click **OK** when finished.

## Red Hat® Enterprise ver. 3.0

To install the Intel® ICH7R LSI Logic Embedded SATA RAID controller driver when installing Red Hat® Enterprise ver. 3.0 OS:

1. Boot the system from the Red Hat® Installation CD.



2. At the `boot:`, type `linux dd` , then press <Enter>.

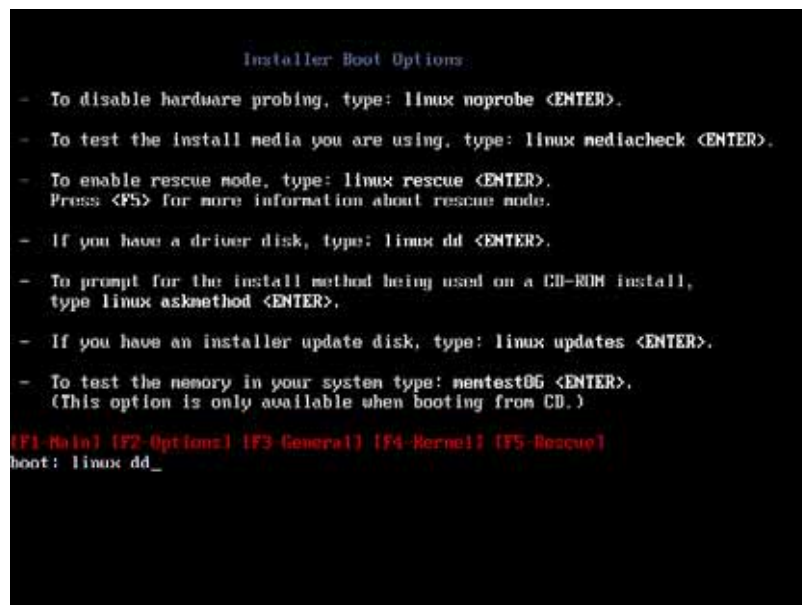

3. Select **Yes** using the <Tab> key when asked if you have the driver disk. Press <Enter>

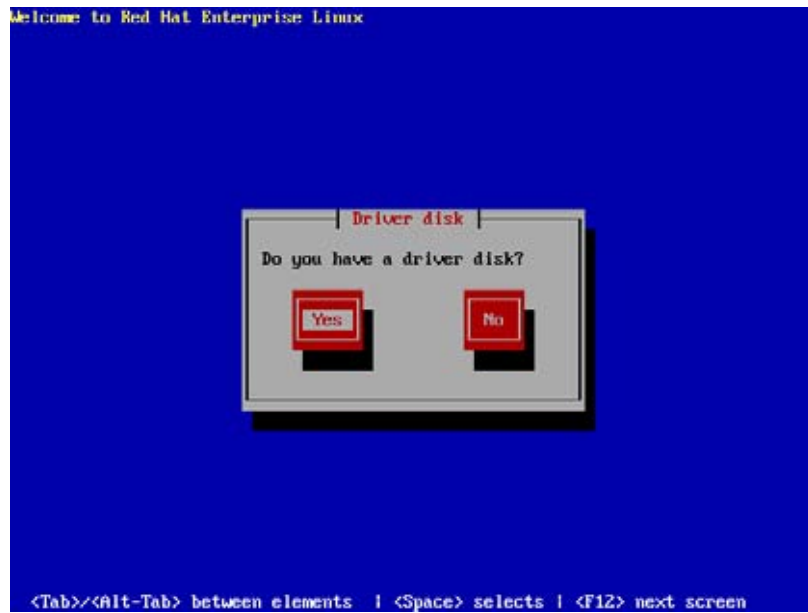

4. Select **fd0** using the <Tab> key when asked to select the driver disk source. Press <Tab> to move the cursor to **OK**, then press <Enter>.

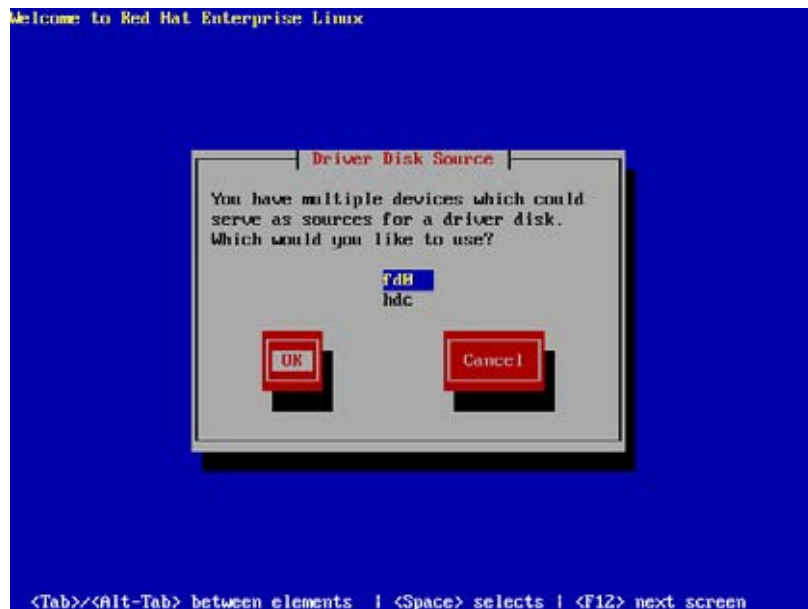

5. When prompted, insert the Red Hat® Enterprise ver. 3.0 RAID driver disk to the floppy disk drive, select **OK**, then press <Enter>.

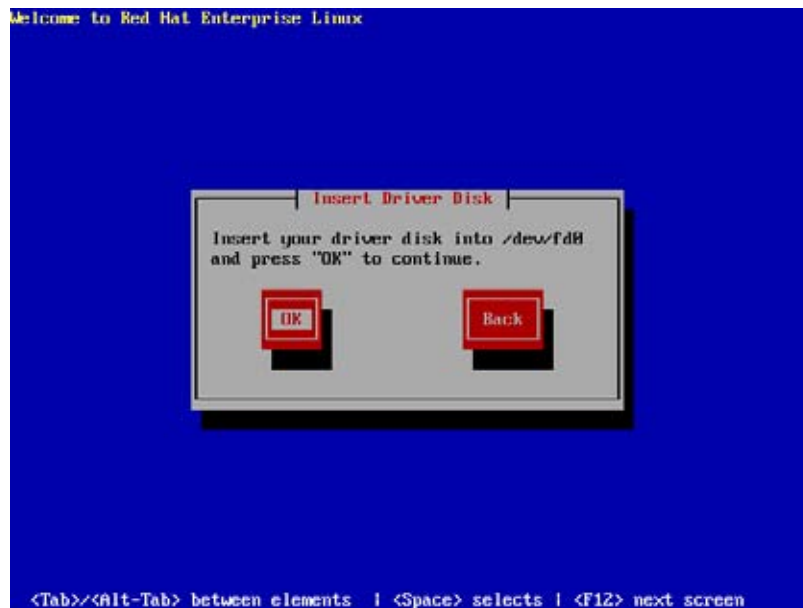

The drivers for the RAID controller are installed to the system.

6. When asked if you will load additional RAID controller drivers:
  - For P5MT model, select **No**, then press <Enter>
  - For P5MT/SCSI model, select **Yes**, then install the additional RAID controller drivers (for LSI53C1020A PCI-X SCSI controller).

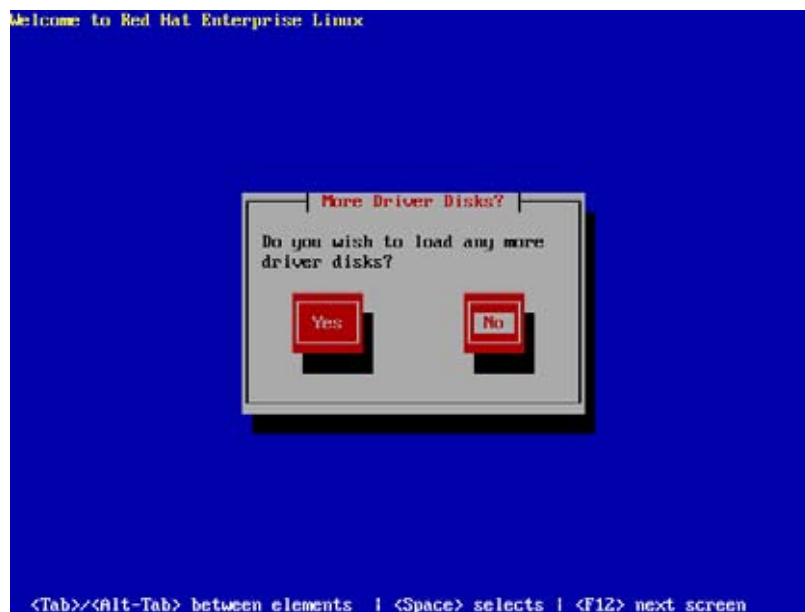

7. Follow screen instructions to continue the OS installation.



## SuSE Linux

To install the RAID controller driver when installing SuSE Linux OS:

1. Boot the system from the SuSE Installation CD.
2. Select Installation from the **Boot Options** menu, then press <Enter>.

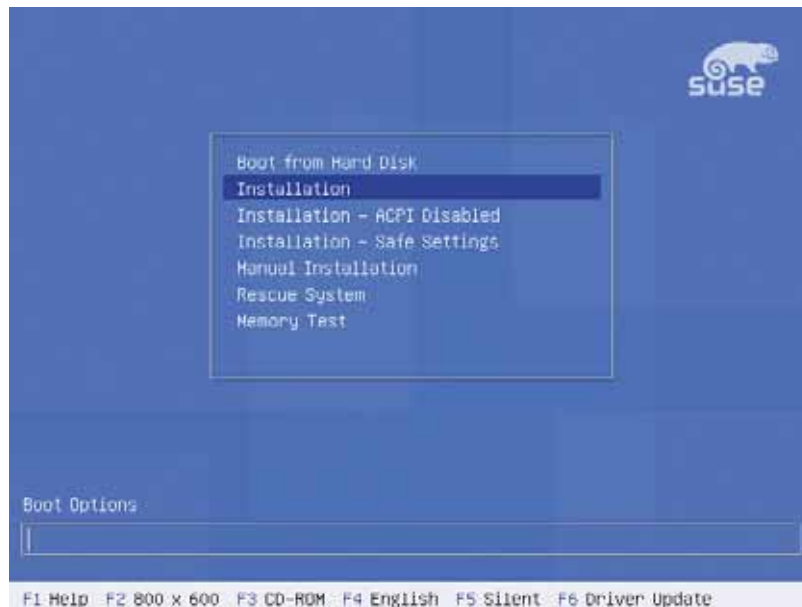

3. A message instructs you to prepare the RAID driver disk. Press <F6>.

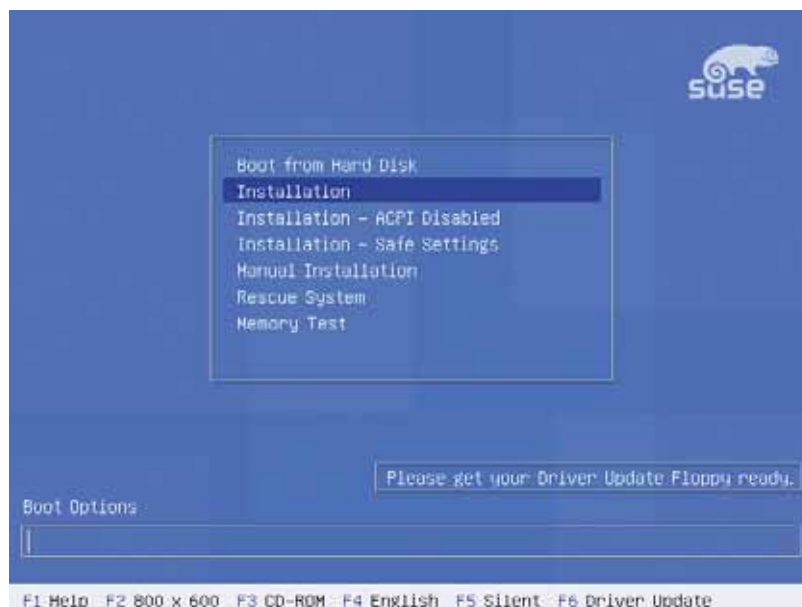

- When prompted, insert the RAID driver disk to the floppy disk drive, then press <Enter>.

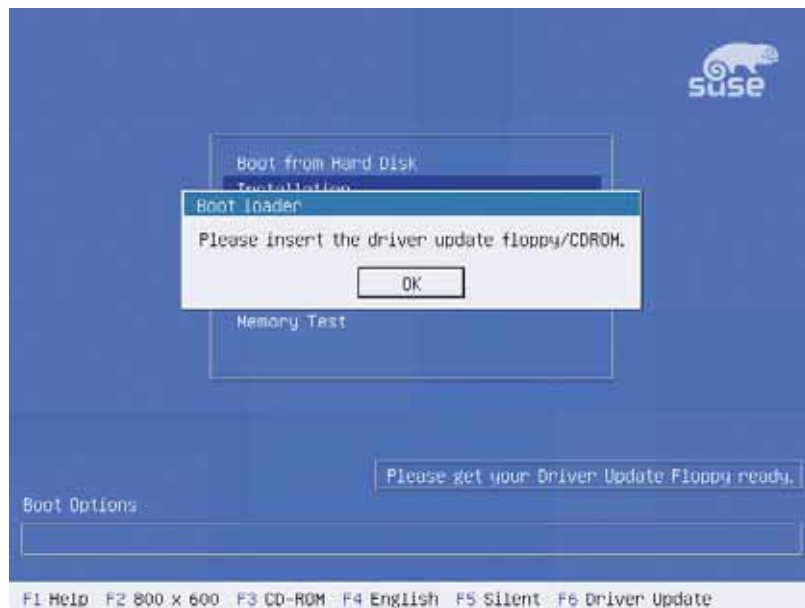

- When prompted, select the floppy disk drive (fd0) as the driver update medium, select OK, then press <Enter>.

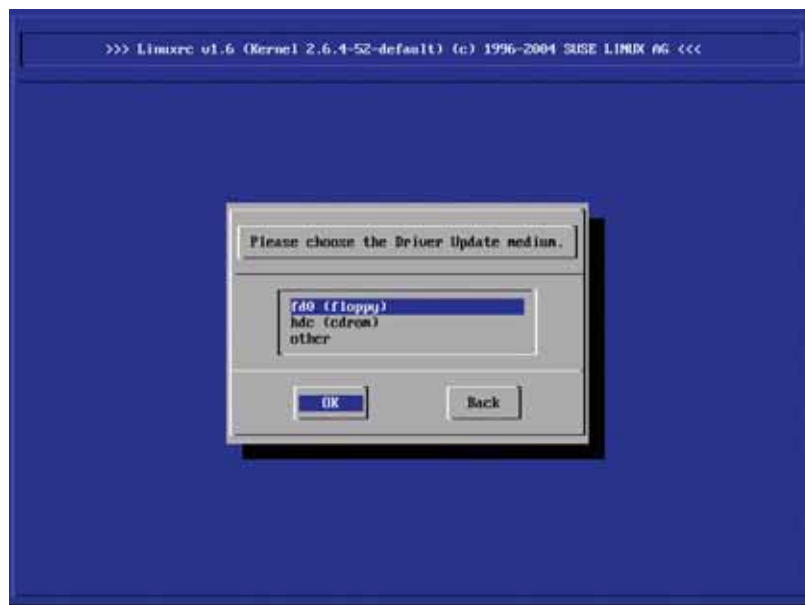

The drivers for the RAID controller are installed to the system.

## 6.2 LAN driver installation

This section provides instructions on how to install the Broadcom® Gigabit LAN controller drivers.

### 6.2.1 Windows® 2000/2003 Server

To install the Broadcom® Gigabit LAN controller driver on a Windows® 2000/2003 Server OS:

1. Restart the computer, then log on with **Administrator** privileges.
2. Insert the motherboard/system support CD to the optical drive. The CD automatically displays the **Drivers** menu if Autorun is enabled in your computer.



- 
- Windows® automatically detects the LAN controllers and displays a **New Hardware Found** window. Click **Cancel** to close this window.
  - If **Autorun** is NOT enabled in your computer, browse the contents of the support CD to locate the file ASSETUP.EXE from the BIN folder. Double-click the **ASSETUP.EXE** to run the CD.
- 

3. Click the **Broadcom Lan Driver** option to begin installation.

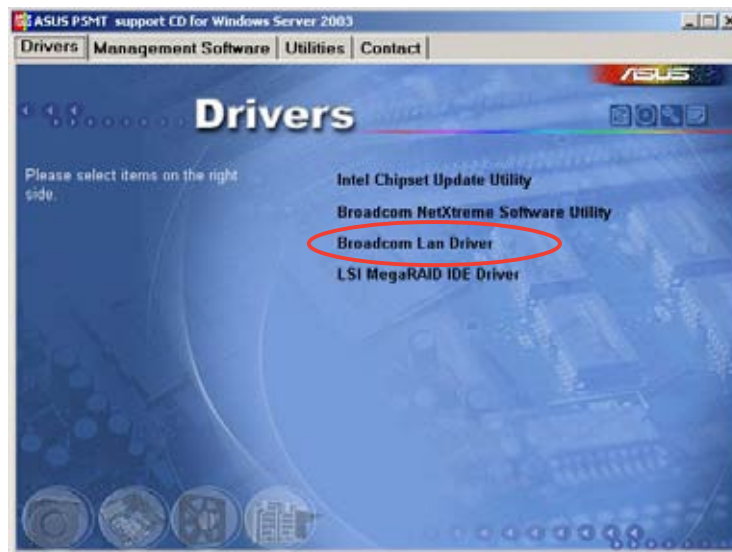

4. Click **Next** when the InstallShield Wizard window appears. Follow screen instructions to continue installation.

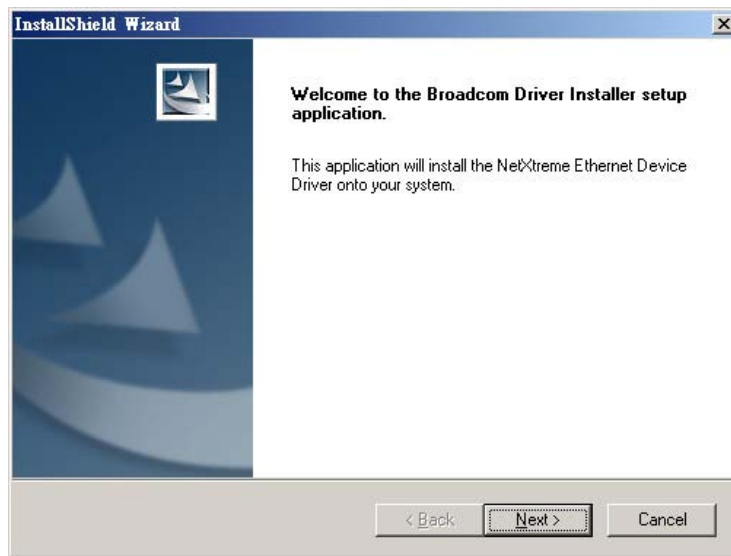

## 6.2.2 Red Hat® Enterprise ver. 3.0

Follow these instructions when installing the Broadcom® Gigabit LAN controller base driver for the Red Hat® Enterprise ver. 3.0 operating system.

### Building the driver from the TAR file



---

Install first the **Kernel Development** tools before building the driver from the TAR file.

---

To build the driver from the TAR file:

1. Create a directory and extract the TAR files:  
`tar xvzf bcm5700-<version>.tar.gz`
2. Build the driver `bcm5700.o` as a loadable module for the running kernel:  
`cd bcm5700-<version>/src`  
`make`
3. Test the driver by loading it:  
`insmod bcm5700.o`
4. Install the driver and man page:  
`make install`
5. Refer to Red Hat distribution documentation to configure the network protocol and address.

## 6.3 VGA driver installation

This section provides instructions on how to install the ATI® RAGE XL Video Graphics Adapter (VGA) driver.

### 6.3.1 Windows® 2000 Server

You need to manually install the ATI® RAGE XL VGA driver on a Windows® 2000 Server operating system.

To install the ATI® RAGE XL VGA driver:

1. Restart the computer, then log on with **Administrator** privileges.
2. Insert the motherboard/system support CD to the optical drive. The support CD automatically displays the **Drivers** menu if Autorun is enabled in your computer.



Windows® automatically detects the LAN controller and displays a **New Hardware Found** window. Click **Cancel** to close this window.

3. Click the item **ATI Rage XL Display Driver** from the **Drivers** menu.

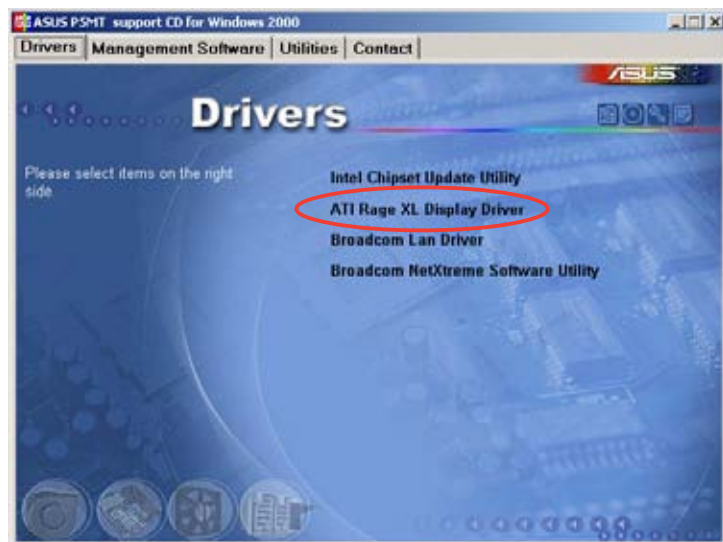

4. The **ATI Windows 2000 Driver** window appears. Click **Next**. Follow screen instructions to complete installation.

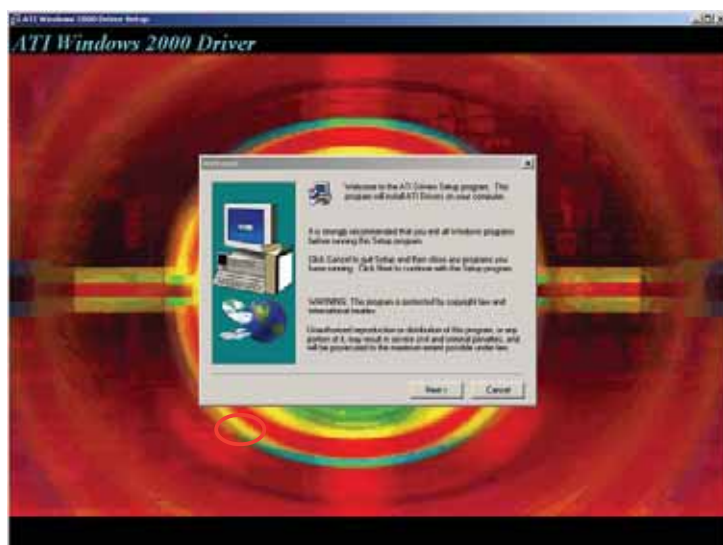

### **6.3.2 Windows® 2003 Server**

The Windows® 2003 Server operating system automatically recognizes the ATI® RAGE XL VGA driver during system installation. There is no need to install an additional driver(s) to support the onboard VGA.

### **6.3.3 Red Hat® Enterprise ver. 3.0**

The Red Hat® Enterprise ver. 3.0 operating system automatically recognizes the ATI® RAGE XL VGA driver during system installation. There is no need to install an additional driver(s) to support the onboard VGA.

## 6.4 Management applications and utilities installation

The support CD that came with the motherboard package contains the drivers, management applications, and utilities that you can install to avail all motherboard features.



---

The contents of the support CD are subject to change at any time without notice. Visit the ASUS website ([www.asus.com](http://www.asus.com)) for updates.

---

### 6.4.1 Running the support CD

Place the support CD to the optical drive. The CD automatically displays the **Drivers** menu if Autorun is enabled in your computer.



---

If **Autorun** is NOT enabled in your computer, browse the contents of the support CD to locate the file **ASSETUP.EXE** from the BIN folder. Double-click the **ASSETUP.EXE** to run the CD.

---

### 6.4.2 Drivers menu

The **Drivers** menu shows the available device drivers if the system detects installed devices. Install the necessary drivers to activate the devices.



---

The screen display and driver options vary under different operating system versions.

---



### 6.4.3 Management Software menu

The **Management Software** menu displays the available network and server monitoring applications. Click on an item to install.



### 6.4.4 Utilities menu

The **Utilities** menu displays the software applications and utilities that the motherboard supports. Click on an item to install.



### 6.4.5 Contact information

Click the **Contact** tab to display the ASUS contact information. You can also find this information on the inside front cover of this user guide.



This appendix includes additional information that you may refer to when configuring the motherboard.

# Reference information

## Appendix summary



A.1	Intel® EM64T .....	A-1
A.2	Enhanced Intel SpeedStep® Technology (EIST) .....	A-1
A.3	Intel® Hyper-Threading Technology .....	A-3
A.4	Block diagrams .....	A-4

## A.1 Intel® EM64T



- 
- The motherboard is fully compatible with Intel® Pentium® 4 LGA775 processors running on 32-bit operating systems.
  - The motherboard comes with a BIOS file that supports EM64T. You can download the latest BIOS file from the ASUS website ([www.asus.com/support/download/](http://www.asus.com/support/download/)) if you need to update the BIOS file. See Chapter 4 for details.
  - Visit [www.intel.com](http://www.intel.com) for more information on the EM64T feature.
  - Visit [www.microsoft.com](http://www.microsoft.com) for more information on Windows® 64-bit OS.
- 

### Using the Intel® EM64T feature

To use the Intel® EM64T feature:

1. Install an Intel® Pentium® 4 CPU that supports the Intel® EM64T.
2. Install a 64-bit operating system (Windows® XP Professional x64 Edition or Windows® Server 2003 x64 Edition).
3. Install the 64-bit drivers for the motherboard components and devices from the support CD.
4. Install the 64-bit drivers for expansion cards or add-on devices, if any.



---

Refer to the expansion card or add-on device(s) documentation, or visit the related website, to verify if the card/device supports a 64-bit system.

---

## A.2 Enhanced Intel SpeedStep® Technology (EIST)



- 
- The motherboard comes with a BIOS file that supports EIST. You can download the latest BIOS file from the ASUS website ([www.asus.com/support/download/](http://www.asus.com/support/download/)) if you need to update the BIOS. See Chapter 4 for details.
  - Visit [www.intel.com](http://www.intel.com) for more information on the EIST feature.
- 

### A.2.1 System requirements

Before using EIST, check your system if it meets the following requirements:

- Intel® Pentium® 4 processor with EIST support
- BIOS file with EIST support
- Operating system with EIST support (Windows® XP SP2/Windows® Server 2003 SP1/Linux 2.6 kernel or later versions)

## A.2.2 Using the EIST

To use the EIST feature:

1. Turn on the computer, then enter the BIOS Setup.
2. Go to the **Advanced Menu**, highlight **CPU Configuration**, then press <Enter>.
3. Set the **Intel(R) SpeedStep Technology** item to [Automatic], then press <Enter>. See page 4-21 for details.
4. Press <F10> to save your changes and exit the BIOS setup.
5. After the computer restarts, right click on a blank space on the desktop, then select **Properties** from the pop-up menu.
6. When the **Display Properties** window appears, click the **Screen Saver** tab.
7. Click the **Power** button on the Monitor power section to open the **Power Options Properties** window.

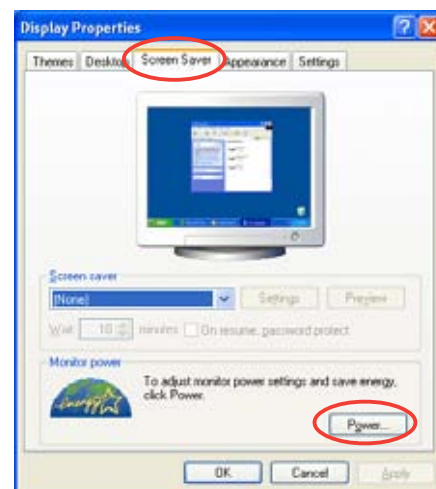

8. On the **Power schemes** section, click , then select any option **except Home/Office Desktop or Always On**.
9. Click **Apply**, then click **OK**.
10. Close the **Display Properties** window.

After you adjust the power scheme, the CPU internal frequency slightly decreases when the CPU loading is low.

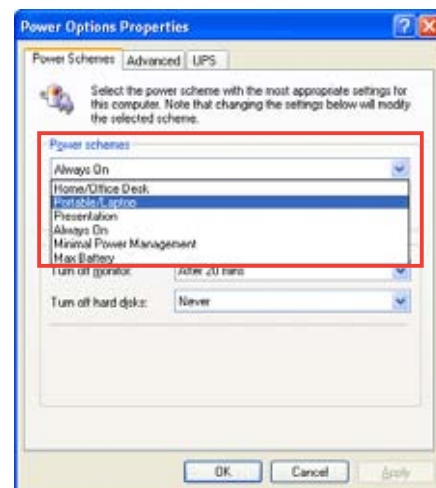

The screen displays and procedures may vary depending on the operating system.

## A.3 Intel® Hyper-Threading Technology



- The motherboard supports Intel® Pentium® 4 LGA775 processors with Hyper-Threading Technology.
- Hyper-Threading Technology is supported under Windows® XP/2003 Server and Linux 2.4.x (kernel) and later versions only. Under Linux, use the Hyper-Threading compiler to compile the code. If you are using any other operating systems, disable the Hyper-Threading Technology item in the BIOS to ensure system stability and performance.
- Installing Windows® XP Service Pack 1 or later version is recommended.
- Make sure to enable the Hyper-Threading Technology item in BIOS before installing a supported operating system.
- For more information on Hyper-Threading Technology, visit [www.intel.com/info/hyperthreading](http://www.intel.com/info/hyperthreading).

### Using the Hyper-Threading Technology

To use the Hyper-Threading Technology:

1. Install an Intel® Pentium® 4 CPU that supports Hyper-Threading Technology.
2. Power up the system and enter the BIOS Setup. Under the **Advanced Menu**, make sure that the item **Hyper-Threading Technology** is set to **Enabled**. See page 4-21 for details.  
The BIOS item appears only if you installed a CPU that supports Hyper-Threading Technology.
3. Restart the computer.

# A.4 Block diagrams

## A.4.1 P5MT model

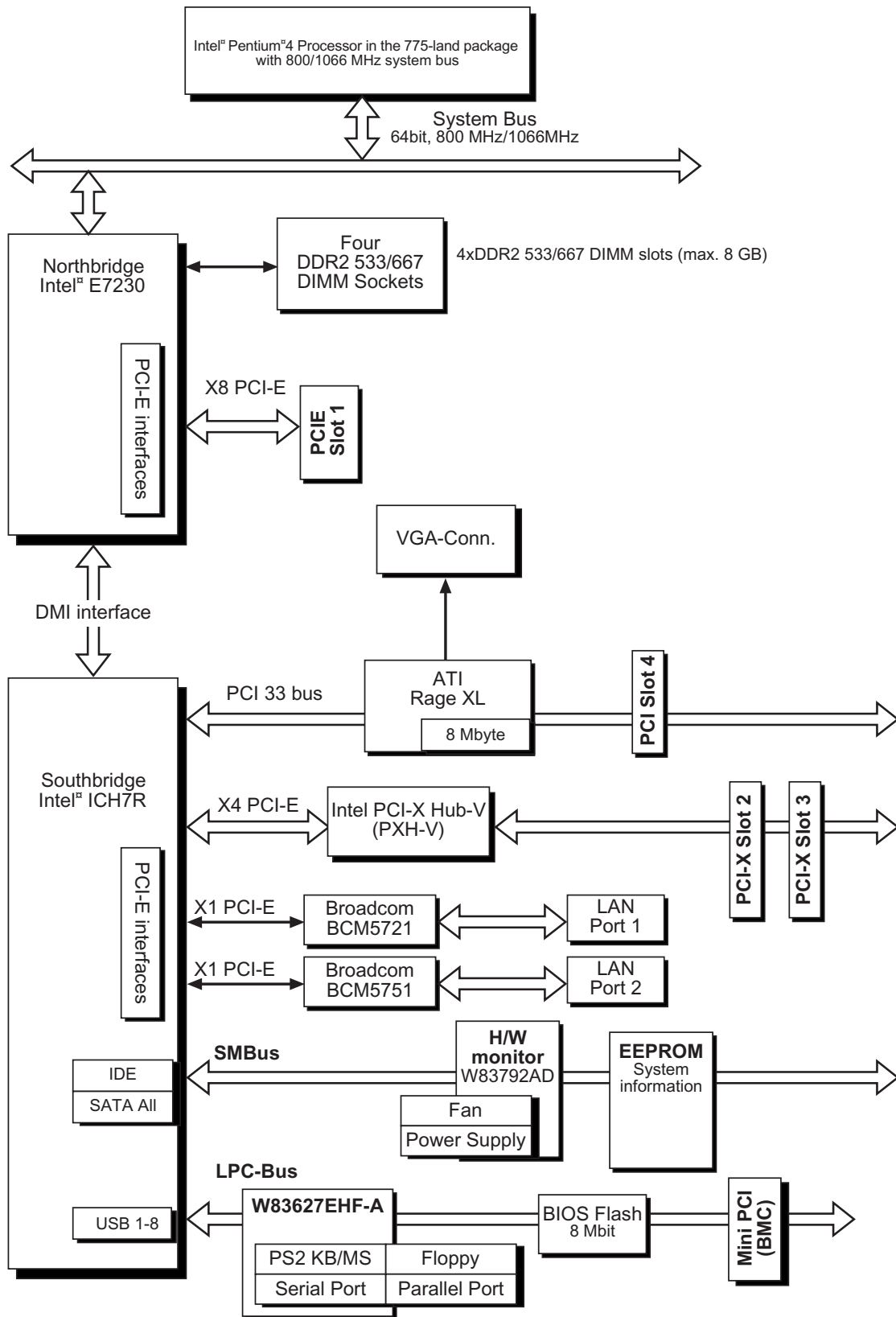

## A.4.2 P5MT/SCSI model

