

**P5N32-SLI**  
*Deluxe*

**ASUS**<sup>®</sup>

**Motherboard**

**E2274**

**Revised Edition V2  
September 2005**

**Copyright © 2005 ASUSTeK COMPUTER INC. All Rights Reserved.**

No part of this manual, including the products and software described in it, may be reproduced, transmitted, transcribed, stored in a retrieval system, or translated into any language in any form or by any means, except documentation kept by the purchaser for backup purposes, without the express written permission of ASUSTeK COMPUTER INC. ("ASUS").

Product warranty or service will not be extended if: (1) the product is repaired, modified or altered, unless such repair, modification or alteration is authorized in writing by ASUS; or (2) the serial number of the product is defaced or missing.

ASUS PROVIDES THIS MANUAL "AS IS" WITHOUT WARRANTY OF ANY KIND, EITHER EXPRESS OR IMPLIED, INCLUDING BUT NOT LIMITED TO THE IMPLIED WARRANTIES OR CONDITIONS OF MERCHANTABILITY OR FITNESS FOR A PARTICULAR PURPOSE. IN NO EVENT SHALL ASUS, ITS DIRECTORS, OFFICERS, EMPLOYEES OR AGENTS BE LIABLE FOR ANY INDIRECT, SPECIAL, INCIDENTAL, OR CONSEQUENTIAL DAMAGES (INCLUDING DAMAGES FOR LOSS OF PROFITS, LOSS OF BUSINESS, LOSS OF USE OR DATA, INTERRUPTION OF BUSINESS AND THE LIKE), EVEN IF ASUS HAS BEEN ADVISED OF THE POSSIBILITY OF SUCH DAMAGES ARISING FROM ANY DEFECT OR ERROR IN THIS MANUAL OR PRODUCT.

SPECIFICATIONS AND INFORMATION CONTAINED IN THIS MANUAL ARE FURNISHED FOR INFORMATIONAL USE ONLY, AND ARE SUBJECT TO CHANGE AT ANY TIME WITHOUT NOTICE, AND SHOULD NOT BE CONSTRUED AS A COMMITMENT BY ASUS. ASUS ASSUMES NO RESPONSIBILITY OR LIABILITY FOR ANY ERRORS OR INACCURACIES THAT MAY APPEAR IN THIS MANUAL, INCLUDING THE PRODUCTS AND SOFTWARE DESCRIBED IN IT.

Products and corporate names appearing in this manual may or may not be registered trademarks or copyrights of their respective companies, and are used only for identification or explanation and to the owners' benefit, without intent to infringe.

# Contents

Notices .....	vii
Safety information .....	viii
About this guide .....	ix
P5N32-SLI Deluxe specifications summary .....	xi

## Chapter 1: Product introduction

1.1	Welcome! .....	1-1
1.2	Package contents .....	1-1
1.3	Special features .....	1-2
1.3.1	Product highlights .....	1-2
1.3.2	ASUS AI Life features .....	1-6
1.3.3	Innovative ASUS features .....	1-7

## Chapter 2: Hardware information

2.1	Before you proceed .....	2-1
2.2	Motherboard overview .....	2-2
2.2.1	Placement direction .....	2-2
2.2.2	Screw holes .....	2-2
2.2.3	ASUS Stack Cool 2 .....	2-3
2.2.3	Motherboard layout .....	2-4
2.2.4	Layout contents .....	2-5
2.3	Central Processing Unit (CPU) .....	2-7
2.3.1	Installing the CPU .....	2-8
2.3.2	Installing the CPU heatsink and fan .....	2-10
2.3.3	Uninstalling the CPU heatsink and fan .....	2-12
2.4	System memory .....	2-14
2.4.1	Overview .....	2-14
2.4.2	Memory configurations .....	2-15
2.4.3	Installing a DIMM .....	2-20
2.4.4	Removing a DIMM .....	2-20
2.5	Expansion slots .....	2-21
2.5.1	Installing an expansion card .....	2-21
2.5.2	Configuring an expansion card .....	2-21
2.5.3	Interrupt assignments .....	2-22

# Contents

2.5.4	PCI slots .....	2-23
2.5.5	PCI Express x1 slotS .....	2-23
2.5.6	PCI Express x4 slot .....	2-23
2.5.7	Two PCI Express x16 slots .....	2-24
2.6	Jumper .....	2-25
2.7	Connectors .....	2-26
2.7.1	Rear panel connectors .....	2-26
2.7.2	Internal connectors .....	2-29

## Chapter 3: Powering up

3.1	Starting up for the first time .....	3-1
3.2	Powering off the computer .....	3-2
3.2.1	Using the OS shut down function .....	3-2
3.2.2	Using the dual function power switch .....	3-2

## Chapter 4: BIOS setup

4.1	Managing and updating your BIOS .....	4-1
4.1.1	Creating a bootable floppy disk .....	4-1
4.1.2	AFUDOS utility .....	4-2
4.1.3	ASUS CrashFree BIOS 2 utility .....	4-5
4.1.4	ASUS EZ Flash utility .....	4-7
4.1.5	ASUS Update utility .....	4-8
4.2	BIOS setup program .....	4-11
4.2.1	BIOS menu screen .....	4-12
4.2.2	Menu bar .....	4-12
4.2.3	Navigation keys .....	4-12
4.2.4	Menu items .....	4-13
4.2.5	Sub-menu items .....	4-13
4.2.6	Configuration fields .....	4-13
4.2.7	Pop-up window .....	4-13
4.2.8	Scroll bar .....	4-13
4.2.9	General help .....	4-13
4.3	Main menu .....	4-14
4.3.1	System Time .....	4-14
4.3.2	System Date .....	4-14
4.3.3	Legacy Diskette A .....	4-14

# Contents

4.3.4	Language .....	4-14
4.3.5	Primary and Secondary IDE Master/Slave .....	4-15
4.3.6	First, Second, Third, and Fourth SATA Device .....	4-16
4.3.7	IDE Configuration .....	4-18
4.3.8	System Information .....	4-19
4.4	Advanced menu .....	4-20
4.4.1	JumperFree Configuration .....	4-20
4.4.2	USB Configuration .....	4-26
4.4.3	LAN2 Cable Status .....	4-27
4.4.4	CPU Configuration .....	4-28
4.4.5	Chipset .....	4-30
4.4.6	Onboard Devices Configuration .....	4-31
4.4.7	PCI PnP .....	4-33
4.5	Power menu .....	4-34
4.5.1	Suspend Mode .....	4-34
4.5.2	Repost Video on S3 Resume .....	4-34
4.5.3	ACPI 2.0 Support .....	4-35
4.5.4	ACPI APIC Support .....	4-35
4.5.5	APM Configuration .....	4-35
4.5.6	Hardware Monitor .....	4-37
4.6	Boot menu .....	4-39
4.6.1	Boot Device Priority .....	4-39
4.6.2	Boot Settings Configuration .....	4-40
4.6.3	Security .....	4-41
4.7	Exit menu .....	4-43

## Chapter 5: Software support

5.1	Installing an operating system .....	5-1
5.2	Support CD information .....	5-1
5.2.1	Running the support CD .....	5-1
5.2.2	Drivers menu .....	5-2
5.2.3	Utilities menu .....	5-3
5.2.4	Make Disk menu .....	5-4
5.2.5	Manuals menu .....	5-6
5.2.6	ASUS Contact information .....	5-7
5.2.7	Other information .....	5-7

5.3	Software information .....	5-10
5.3.1	ASUS MyLogo2™ .....	5-10
5.3.2	AI NET 2 .....	5-12
5.3.3	Audio configurations .....	5-13
5.3.4	Using the NVIDIA® Firewall™ .....	5-19
5.3.5	Using the Wireless LAN module .....	5-22
5.4	RAID configurations .....	5-26
5.4.1	Installing hard disks .....	5-27
5.4.2	NVIDIA® RAID configurations .....	5-28
5.4.3	Silicon Image RAID configurations .....	5-35
5.5	Creating a RAID driver disk .....	5-42

## **Chapter 6: NVIDIA® SLI™ technology support**

6.1	Overview .....	6-1
6.2	Dual graphics card setup .....	6-2
6.2.1	Installing SLI-ready graphics cards .....	6-2
6.2.2	Installing the device drivers .....	6-6
6.2.3	Enabling the multi-GPU feature in Windows® .....	6-6

## **Appendix: CPU features**

A.1	Intel® EM64T .....	A-1
A.2	Enhanced Intel SpeedStep® Technology (EIST) .....	A-1
A.2.1	System requirements .....	A-1
A.2.2	Using the EIST .....	A-2
A.3	Intel® Hyper-Threading Technology .....	A-3

# Notices

## Federal Communications Commission Statement

This device complies with Part 15 of the FCC Rules. Operation is subject to the following two conditions:

- This device may not cause harmful interference, and
- This device must accept any interference received including interference that may cause undesired operation.

This equipment has been tested and found to comply with the limits for a Class B digital device, pursuant to Part 15 of the FCC Rules. These limits are designed to provide reasonable protection against harmful interference in a residential installation. This equipment generates, uses and can radiate radio frequency energy and, if not installed and used in accordance with manufacturer's instructions, may cause harmful interference to radio communications. However, there is no guarantee that interference will not occur in a particular installation. If this equipment does cause harmful interference to radio or television reception, which can be determined by turning the equipment off and on, the user is encouraged to try to correct the interference by one or more of the following measures:

- Reorient or relocate the receiving antenna.
- Increase the separation between the equipment and receiver.
- Connect the equipment to an outlet on a circuit different from that to which the receiver is connected.
- Consult the dealer or an experienced radio/TV technician for help.



---

The use of shielded cables for connection of the monitor to the graphics card is required to assure compliance with FCC regulations. Changes or modifications to this unit not expressly approved by the party responsible for compliance could void the user's authority to operate this equipment.

---

## Canadian Department of Communications Statement

This digital apparatus does not exceed the Class B limits for radio noise emissions from digital apparatus set out in the Radio Interference Regulations of the Canadian Department of Communications.

**This class B digital apparatus complies with Canadian ICES-003.**

# Safety information

## Electrical safety

- To prevent electrical shock hazard, disconnect the power cable from the electrical outlet before relocating the system.
- When adding or removing devices to or from the system, ensure that the power cables for the devices are unplugged before the signal cables are connected. If possible, disconnect all power cables from the existing system before you add a device.
- Before connecting or removing signal cables from the motherboard, ensure that all power cables are unplugged.
- Seek professional assistance before using an adapter or extension cord. These devices could interrupt the grounding circuit.
- Make sure that your power supply is set to the correct voltage in your area. If you are not sure about the voltage of the electrical outlet you are using, contact your local power company.
- If the power supply is broken, do not try to fix it by yourself. Contact a qualified service technician or your retailer.

## Operation safety

- Before installing the motherboard and adding devices on it, carefully read all the manuals that came with the package.
- Before using the product, make sure all cables are correctly connected and the power cables are not damaged. If you detect any damage, contact your dealer immediately.
- To avoid short circuits, keep paper clips, screws, and staples away from connectors, slots, sockets and circuitry.
- Avoid dust, humidity, and temperature extremes. Do not place the product in any area where it may become wet.
- Place the product on a stable surface.
- If you encounter technical problems with the product, contact a qualified service technician or your retailer.



# About this guide

This user guide contains the information you need when installing and configuring the motherboard.

## How this guide is organized

This guide contains the following parts:

- **Chapter 1: Product introduction**  
This chapter describes the features of the motherboard and the new technology it supports.
- **Chapter 2: Hardware information**  
This chapter lists the hardware setup procedures that you have to perform when installing system components. It includes description of the switches, jumpers, and connectors on the motherboard.
- **Chapter 3: Powering up**  
This chapter describes the power up sequence, the vocal POST messages, and ways of shutting down the system.
- **Chapter 4: BIOS setup**  
This chapter tells how to change system settings through the BIOS Setup menus. Detailed descriptions of the BIOS parameters are also provided.
- **Chapter 5: Software support**  
This chapter describes the contents of the support CD that comes with the motherboard package.
- **Chapter 6: NVIDIA® SLI™ technology support**  
This chapter tells how to install SLI-ready PCI Express graphics cards.
- **Appendix: CPU features**  
The Appendix describes the CPU features that the motherboard supports.

## Where to find more information

Refer to the following sources for additional information and for product and software updates.

### 1. ASUS websites

The ASUS website provides updated information on ASUS hardware and software products. Refer to the ASUS contact information.

### 2. Optional documentation

Your product package may include optional documentation, such as warranty flyers, that may have been added by your dealer. These documents are not part of the standard package.

## Conventions used in this guide

To make sure that you perform certain tasks properly, take note of the following symbols used throughout this manual.



**DANGER/WARNING:** Information to prevent injury to yourself when trying to complete a task.



**CAUTION:** Information to prevent damage to the components when trying to complete a task.



**IMPORTANT:** Instructions that you **MUST** follow to complete a task.



**NOTE:** Tips and additional information to help you complete a task.

## Typography

### **Bold text**

Indicates a menu or an item to select.

### *Italics*

Used to emphasize a word or a phrase.

### <Key>

Keys enclosed in the less-than and greater-than sign means that you must press the enclosed key.

Example: <Enter> means that you must press the Enter or Return key.

### <Key1+Key2+Key3>

If you must press two or more keys simultaneously, the key names are linked with a plus sign (+).

Example: <Ctrl+Alt+D>

### **Command**

Means that you must type the command exactly as shown, then supply the required item or value enclosed in brackets.

Example: At the DOS prompt, type the command line:

```
afudos /i[filename]  
afudos /iP5N32SP.ROM
```

## P5N32-SLI Deluxe specifications summary

<b>CPU</b>	<p>LGA775 socket for Intel® Pentium® Processor Extreme Edition/Intel® Pentium® D/Intel® Pentium® 4/Intel® Celeron® processors</p> <p>Compatible with Intel® PCG 05B/05A and 04B/04A processors</p> <p>Supports Intel® Enhanced Memory 64 Technology (EM64T)</p> <p>Supports Enhanced Intel SpeedStep® Technology (EIST)</p> <p>Supports Intel® Hyper-Threading Technology</p> <p><b>(Note:</b> Visit the ASUS website at <a href="http://www.asus.com">www.asus.com</a> for the Intel® Pentium® D CPU and EIST support list.)</p>
<b>Chipset</b>	<p>Northbridge: NVIDIA® nForce™ 4 SLI - Intel® Edition</p> <p>Southbridge: NVIDIA® nForce™ 4 SLI</p>
<b>Front Side Bus</b>	1066/800/533 MHz
<b>Memory</b>	<p>Dual-channel memory architecture</p> <p>4 x 240-pin DIMM sockets support unbuffered non-ECC DDR2-667/DDR2-533 memory modules</p> <p>Supports up to 16 GB system memory</p> <p>Supports the NVIDIA® Dynamic Adaptive Speculative Preprocessor (DASP) and QuickSync feature</p>
<b>Expansion slots</b>	<p>2 x PCI Express™ x16 slots with Scalable Link Interface (SLI™) support at full x16, x16 mode</p> <p>1 x PCI Express™ x4 slot</p> <p>2 x PCI Express™ x1 slots</p> <p>2 x PCI slots (PCI 2.2)</p>
<b>Scalable Link Interface (SLI™)</b>	<p>SLI™ mode supports:</p> <ul style="list-style-type: none"> <li>- 2 x identical SLI™-ready PCI Express™ x16 graphics cards <b>(Note:</b> In SLI mode, the PCI Express x16 slots work at the full bandwidth of x16 each, for a combined bandwidth of x32.)</li> </ul> <p>ASUS SLI Bridge</p> <p>ASUS EZ Plug™</p> <p>ASUS PEG Link for dual PCI Express graphics cards</p> <p>ASUS Two-slot thermal design</p>
<b>AI Audio</b>	<p>Realtek® ALC850 8-channel CODEC</p> <p>1 x Coaxial S/PDIF out port</p> <p>1 x Optical S/PDIF out port</p> <p>Supports Universal Audio Jack (UAJ®) Technology</p> <p>Supports Audio Sensing and Enumeration Technology</p>

(continued on the next page)

## P5N32-SLI Deluxe specifications summary

<b>Storage</b>	<p>NVIDIA® nForce™ SLI supports:</p> <ul style="list-style-type: none"> <li>- 2 x Ultra DMA 133/100/66/33</li> <li>- 4 x Serial ATA 3Gb/s devices</li> <li>- NVRAID for RAID 0, RAID 1, RAID 0+1, RAID 5, and JBOD configuration</li> <li>- Up to 8 hard disk drives of Multi-RAID configuration</li> </ul> <p>Silicon Image 3132 SATA controller supports:</p> <ul style="list-style-type: none"> <li>- 1 x Internal Serial ATA 3Gb/s hard disk drive</li> <li>- 1 x External Serial ATA 3Gb/s (SATA On-The-Go)</li> <li>- RAID 0, RAID 1, and JBOD configuration</li> </ul>
<b>Dual Gigabit LAN</b>	<p>AI NET2          Marvell® 88E8053 Gigabit LAN controller          Marvell® 88E1115 Gigabit LAN PHY          NVIDIA® nForce™ 4 SLI built-in Gigabit MAC with external Marvell® PHY supports:</p> <ul style="list-style-type: none"> <li>- NV ActiveArmor</li> <li>- NV Firewall</li> </ul>
<b>Wireless LAN (optional)</b>	<p>Realtek® RTL8187L supports IEEE 802.11 b/g standards</p>
<b>USB</b>	<p>Supports up to 9 USB 2.0 ports (<i>Wi-Fi Edition supports up to 10 USB 2.0 ports</i>)</p>
<b>IEEE 1394</b>	<p>TI 1394a controller supports:</p> <ul style="list-style-type: none"> <li>- 2 x IEEE 1394a connectors at midboard</li> </ul>
<b>ASUS Exclusive Overclocking features</b>	<p>Intelligent overclocking tools:</p> <ul style="list-style-type: none"> <li>- AI NOS™ (Non-delay Overclocking System)</li> <li>- AI Overclocking (intelligent CPU frequency tuner)</li> <li>- ASUS PEG Link (automatic performance tuning for single/dual graphics cards)</li> <li>- ASUS CPU Lock Free</li> <li>- ASUS AI Booster Utility</li> </ul> <p>Precision Tweaker supports:</p> <ul style="list-style-type: none"> <li>- DIMM voltage: 8-step DRAM voltage control</li> <li>- Core voltage: Adjustable CPU voltage at 0.0125 V increment</li> </ul> <p>Stepless Frequency Selection(SFS) allows:</p> <ul style="list-style-type: none"> <li>- FSB tuning up to 1600 MHz at 1 MHz increment, depending on CPU frequency</li> <li>- Memory tuning from 400 MHz to 1600 MHz</li> <li>- PCI Express frequency tuning from 100 MHz to 148 MHz at 1 MHz increment</li> </ul> <p>Overclocking protection:</p> <ul style="list-style-type: none"> <li>- ASUS C.P.R. (CPU Parameter Recall)</li> </ul>

(continued on the next page)

## P5N32-SLI Deluxe specifications summary

<b>ASUS AI Life features</b>	ASUS SATA On-The-Go (External Serial ATA port on the rear panel) Stack Cool 2 patented fanless cooling technology
<b>Other ASUS special features</b>	Fanless design AI NET2 network diagnosis before entering the operating system ASUS CrashFree BIOS 2 ASUS Q-Fan2 ASUS MyLogo2 ASUS EZ Flash ASUS Multi-language BIOS
<b>BIOS features</b>	8 Mb Flash ROM, AMI BIOS, PnP, DMI2.44, SM BIOS 2.33, WfM2.0
<b>Rear panel</b>	1 x Parallel port 2 x LAN (RJ-45) ports 4 x USB 2.0 ports (5 x USB ports optional for Wi-Fi edition) 1 x Wireless LAN port (IEEE 802.11 b/g) [optional] 1 x External Serial ATA port 1 x Optical S/PDIF Out port 1 x Coaxial S/PDIF Out port 1 x PS/2 keyboard port (purple) 1 x PS/2 mouse port (green) 8-channel audio ports
<b>Internal connectors</b>	1 x Floppy disk drive connector 2 x IDE connectors 4 x NVIDIA® nForce™ 4 Serial ATA connectors 1 x Silicon Image® Serial ATA connector 1 x 24-pin EATX power connector 1 x 8-pin EATX 12 V power connector 1 x 4-pin ASUS EZ Plug™ connector 2 x USB connectors for 4 additional USB 2.0 ports 1 x Internal audio connectors (CD/AUX) 2 x IEEE 1394a connectors 1 x GAME/MIDI connector 1 x Chassis intrusion connector 1 x Front panel audio connector CPU (x1), Chassis (x2), Chipset (x2), Power (x1) fan connectors System panel connector

*(continued on the next page)*

## P5N32-SLI Deluxe specifications summary

<b>Power Requirement</b>	ATX power supply (with 24-pin and 8-pin 12 V plugs) ATX 12 V 2.0 compliant ASUS EZ Plug ( <i>When using two graphics cards and a 20-pin ATX PSU or, if the two graphics cards do not have auxiliary power.</i> )
<b>Support CD contents</b>	Device drivers ASUS PC Probe II ASUS Update ASUS AI Booster NVIDIA® NV Firewall NVIDIA® NV RAID NVIDIA® NV RIS (Remote Installation Service) Anti-Virus Utility (OEM version)
<b>Form Factor</b>	ATX form factor: 12 in x 9.6 in (30.5 cm x 24.5 cm)

\*Specifications are subject to change without notice.

This chapter describes the motherboard features and the new technologies it supports.

# Product introduction



# Chapter summary



1.1	Welcome! .....	1-1
1.2	Package contents .....	1-1
1.3	Special features .....	1-2



## 1.1 Welcome!

Thank you for buying an ASUS® P5N32-SLI Deluxe motherboard!

The motherboard delivers a host of new features and latest technologies, making it another standout in the long line of ASUS quality motherboards!

Before you start installing the motherboard, and hardware devices on it, check the items in your package with the list below.

## 1.2 Package contents

Check your motherboard package for the following items.

<b>Motherboard</b>	ASUS P5N32-SLI Deluxe motherboard
<b>I/O modules</b>	1 x IEEE1394a module 1 x Serial port module 1 x 2-port USB 2.0/GAME module
<b>Cables</b>	4 x Serial ATA cables 2 x Serial ATA power cables (dual plugs) 1 x Ultra DMA 133/100/66 cable 1 x IDE cable 1 x Floppy disk drive cable
<b>Accessories</b>	I/O shield 1 x ASUS SLI Bridge
<b>Application CDs</b>	ASUS motherboard support CD
<b>Documentation</b>	User guide



If any of the above items is damaged or missing, contact your retailer.

## 1.3 Special features

### 1.3.1 Product highlights

#### Latest processor technology

The motherboard comes with a 775-pin surface mount Land Grid Array (LGA) socket designed for the Intel® Pentium® Processor Extreme Edition, Intel® Pentium® D, Intel® Pentium® 4, and Intel® Celeron® processor in the 775-land package. The motherboard supports Intel® processors with 1066/800/533 MHz Front Side Bus (FSB). The motherboard also supports the Intel® Hyper-Threading Technology, Intel® Dual-Core Technology and is fully compatible with Intel® 05B/05A and 04B/04A processors. See page 2-7 for details.

#### NVIDIA® Scalable Link Interface (SLI™) - Intel® Edition

The NVIDIA® nForce4® Scalable Link Interface (SLI™) - Intel® Edition technology allows two graphics processing units (GPUs) in a single system. This technology takes advantage of the PCI Express™ bus architecture and features intelligent hardware and software solutions that allows multiple GPUs to work together and achieve exceptional graphics performance. See Chapter 6 for details.

#### Intel® Dual-Core Technology CPU support

The motherboard supports dual-core processors containing two physical CPU cores with dedicated L2 caches to meet demands for more powerful processing. See page 2-7 for details.

#### Intel® EM64T

The motherboard supports Intel® processors with the Intel® EM64T (Extended Memory 64 Technology). The Intel® EM64T feature allows your computer to run on 64-bit operating systems and access larger amounts of system memory for faster and more efficient computing. See the Appendix for details.

#### Enhanced Intel SpeedStep® Technology (EIST)

The Enhanced Intel SpeedStep® Technology (EIST) intelligently manages the CPU resources by automatically adjusting the CPU voltage and core frequency depending on the CPU loading and system speed or power requirement. See the Appendix for details.

## DDR2 memory support

The motherboard supports DDR2 memory that features data transfer rates of 667 MHz or 533 MHz to meet the higher bandwidth requirements of the latest 3D graphics, multimedia, and Internet applications. The dual-channel DDR2 architecture doubles the bandwidth of your system memory to boost system performance, eliminating bottlenecks with peak bandwidths of up to 10.7 GB/s. See pages 2-14 to 2-19 for details.

## NVIDIA® QuickSync

The NVIDIA® nForce4® SLI™ - Intel® Edition memory controller features the QuickSync synchronization technology that transfers memory requests and data between the Front Side Bus (FSB) and memory clock domains in the shortest amount of time. QuickSync ensures that the memory controller has the shortest latency between receiving/placing CPU requests, and between receiving the data from memory and sending it to the CPU for all FSB and memory speeds.

## NVIDIA® DASP 3.0

The NVIDIA® Dynamic Adaptive Speculative Preprocessor (DASP) 3.0 comes with sophisticated data pre-fetch algorithms in preprocessors that are tasked to track data threads and pre-fetch appropriate data for improved performance.

## Built-in NVFirewall™ and NVActiveArmor™



ActiveArmor™

The NVIDIA® Firewall™ (NVFirewall™) is an easy-to-use high-performance desktop firewall application that protects your system from intruders. Integrated into the NVIDIA® nForce4® SLI™ chipset, it provides advanced anti-computer-hacking technologies, remote management capabilities, and a user-friendly setup wizard that improves overall system security.

Enhancing your network security is the NVIDIA® ActiveArmor™ (NV ActiveArmor™) engine that provides advanced data packet inspection. This innovative technology ensures that only safe data packets are passed on the network. It boosts overall system performance by offloading the CPU from the rigorous task of filtering data packets. See page 5-19 for details.

## Dual RAID solution

Onboard RAID controllers provide the motherboard with dual-RAID functionality that allows you to select the best RAID solution using IDE or Serial ATA devices.

The NVIDIA® nForce4® SLI™ allows RAID 0, RAID 1, RAID 0+1, RAID 5, and JBOD configuration for four SATA 3 Gb/s and two PATA connectors. See pages 2-31 and 5-28.

The Silicon Image® 3132 controller supports two additional Serial ATA 3Gb/s connectors and allows RAID 0, RAID 1, and JBOD configurations through the internal and external Serial ATA ports. See pages 2-32 and 5-35 for details.

## Dual Gigabit LAN solution

The motherboard comes with dual Gigabit LAN controllers to provide the total solution for your networking needs. These network controllers use the PCI Express segment to provide faster data bandwidth for your wired or wireless Internet, LAN, and file sharing requirements. See page 2-27 for details.

## Wireless LAN solution (*optional*)

The motherboard comes with the Realtek® RTL8187L LAN controller for the onboard wireless LAN module that supports IEEE 802.11 b/g standards, allowing data transmission of up to 54 Mbps using the 2.4 GHz/ 5 GHz frequency band. ASUS provides a user-friendly wizard that helps you set up your wireless local area network effortlessly. See page 5-22 for details.

## PCI Express™ interface

The motherboard fully supports PCI Express, the latest I/O interconnect technology that speeds up the PCI bus. PCI Express features point-to-point serial interconnections between devices and allows higher clockspeeds by carrying data in packets. This high speed interface is software compatible with existing PCI specifications. See pages 2-23 and 2-24 for details.

## CPU Lock Free

This feature allows you to adjust the CPU multiplier to 14x. Setting the appropriate BIOS setting automatically reduces the CPU multiplier value for more flexibility when increasing external FSB. See page 4-21 for details.

## S/PDIF digital sound ready

The motherboard supports the S/PDIF technology through the S/PDIF interfaces on the rear panel and at midboard. The S/PDIF technology turns your computer into a high-end entertainment system with digital connectivity to powerful audio and speaker systems. See page 2-29 for details.

## IEEE 1394a support

The IEEE 1394a interface provides high-speed and flexible PC connectivity to a wide range of peripherals and devices compliant to the IEEE 1394a standard. The IEEE 1394a interface allows up to 400 Mbps transfer rates through simple, low-cost, high-bandwidth asynchronous (real-time) data interfacing between computers, peripherals, and consumer electronic devices such as camcorders, VCRs, printers, TVs, and digital cameras. See page 2-34 for details.

## USB 2.0 technology

The motherboard implements the Universal Serial Bus (USB) 2.0 specification, dramatically increasing the connection speed from the 12 Mbps bandwidth on USB 1.1 to a fast 480 Mbps on USB 2.0. USB 2.0 is backward compatible with USB 1.1. See pages 2-28 and 2-33 for details.

### 1.3.2 ASUS AI Life features



#### Serial ATA II and SATA-On-The-Go



The motherboard supports the Serial ATA 3 Gb/s technology through the Silicon Image Serial ATA interfaces and the NVIDIA® SLI™ - Intel® Edition chipset. The Serial ATA 3 Gb/s specification provides twice the bandwidth of the current Serial ATA products with a host of new features, including Native Command Queuing (NCQ), Power Management (PM) Implementation Algorithm, and Hot Swap. Serial ATA allows thinner, more flexible cables with lower pin count and reduced voltage requirements.

Leveraging these Serial ATA 3Gb/s features is the SATA-On-The-Go. This external port on the rear panel I/O provides smart setup, hot-plug and support for up to 16 devices with port-multiplier functions. See pages 2-28 and 2-32 for details.

#### ASUS Stack Cool 2

ASUS Stack Cool 2 is a fan-less and zero-noise cooling solution that lowers the temperature of critical heat generating components. The motherboard uses a special design on the printed circuit board (PCB) to dissipate heat that critical components generate. See page 2-3 for details.

### 1.3.3 Innovative ASUS features

#### AI NOS™ (Non-Delay Overclocking System)

ASUS Non-delay Overclocking System™ (NOS) is a technology that auto-detects the CPU loading and dynamically overclocks the CPU speed only when needed.

#### Precision Tweaker

This feature allows you to fine tune the CPU/memory voltage and gradually increase the memory Front Side Bus (FSB) and PCI Express frequency at 1MHz increment to achieve maximum system performance.

## AI NET 2

AI NET 2 is a BIOS-based diagnostic tool that detects and reports Ethernet cable faults and shorts. With this utility, you can easily monitor the condition of the Ethernet cable(s) connected to the Marvell® LAN (RJ-45) port. During the bootup process, AI NET 2 immediately diagnoses the LAN cable and reports shorts and faults up to 100 meters at 1 meter accuracy. See pages 4-27 and 5-12 for details.

## AI Audio technology

The motherboard supports 8-channel audio through the onboard Realtek® ALC850 CODEC with 16-bit DAC, a stereo 16-bit ADC, and an AC97 2.3 compatible multi-channel audio designed for PC multimedia systems. It also provides Jack-Sensing function, S/PDIF out support, interrupt capability and includes the Realtek® proprietary UAJ® (Universal Audio Jack) technology. See pages 2-26 and 5-13 for details.

## Fanless Design

The ASUS fanless design allows multi-directional heat flow from major thermal sources in the motherboard to lower overall system temperature, resulting in quieter operation and longer system life.

## PEG Link Mode for two graphics cards

This feature enhances your PCI Express graphics card performance. It allows the motherboard to automatically adjust the PCI Express graphics link mode to the correct frequency based on the system configuration. Four additional settings are available for overclocking the PEG Link Mode. See page 4-29 for details.

## ASUS Two-slot thermal design

The motherboard is designed with one PCI Express x1 slot and one PCI Express x4 slot placed between the PCI Express x16 slots, allowing increased airflow between the two PCI Express x16 graphics cards. This special design permits more room for ventilation, thus lowering the overall system temperature.

## CrashFree BIOS 2

This feature allows you to restore the original BIOS data from the support CD in case when the BIOS codes and data are corrupted. This protection eliminates the need to buy a replacement ROM chip. See page 4-5 for details.

## ASUS Q-Fan 2 technology

The ASUS Q-Fan 2 technology smartly adjusts the CPU and chassis fan 1 speeds according to the system loading to ensure quiet, cool, and efficient operation. See page 4-37 for details.

## ASUS Multi-language BIOS

The multi-language BIOS allows you to select the language of your choice from the available options. The localized BIOS menus allow easier and faster configuration. See page 4-14 for details.

## ASUS MyLogo2™

This new feature present in the motherboard allows you to personalize and add style to your system with customizable boot logos. See page 5-10 for details.

## ASUS EZ Plug™

This patented ASUS technology is a 4-pin auxiliary +12V connector that is designed to maintain the voltage integrity of your system. This plug guarantees adequate supply of power to the motherboard and other installed peripherals. See page 2-35 for the illustration.

## C.P.R. (CPU Parameter Recall)

The C.P.R. feature of the motherboard BIOS allows automatic re-setting to the BIOS default settings in case the system hangs due to overclocking. When the system hangs due to overclocking, C.P.R. eliminates the need to open the system chassis and clear the RTC data. Simply shut down and reboot the system, and the BIOS automatically restores the CPU default setting for each parameter.



This chapter lists the hardware setup procedures that you have to perform when installing system components. It includes description of the jumpers and connectors on the motherboard.

# Hardware information



## Chapter summary



2.1	Before you proceed .....	2-1
2.2	Motherboard overview .....	2-2
2.3	Central Processing Unit (CPU) .....	2-7
2.4	System memory .....	2-14
2.5	Expansion slots .....	2-21
2.6	Jumper .....	2-25
2.7	Connectors .....	2-26

## 2.1 Before you proceed

Take note of the following precautions before you install motherboard components or change any motherboard settings.



- Unplug the power cord from the wall socket before touching any component.
- Use a grounded wrist strap or touch a safely grounded object or to a metal object, such as the power supply case, before handling components to avoid damaging them due to static electricity.
- Hold components by the edges to avoid touching the ICs on them.
- Whenever you uninstall any component, place it on a grounded antistatic pad or in the bag that came with the component.
- **Before you install or remove any component, ensure that the ATX power supply is switched off or the power cord is detached from the power supply.** Failure to do so may cause severe damage to the motherboard, peripherals, and/or components.

### Onboard LED

The motherboard comes with a standby power LED. The green LED lights up to indicate that the system is ON, in sleep mode, or in soft-off mode. This is a reminder that you should shut down the system and unplug the power cable before removing or plugging in any motherboard component. The illustration below shows the location of the onboard LED.

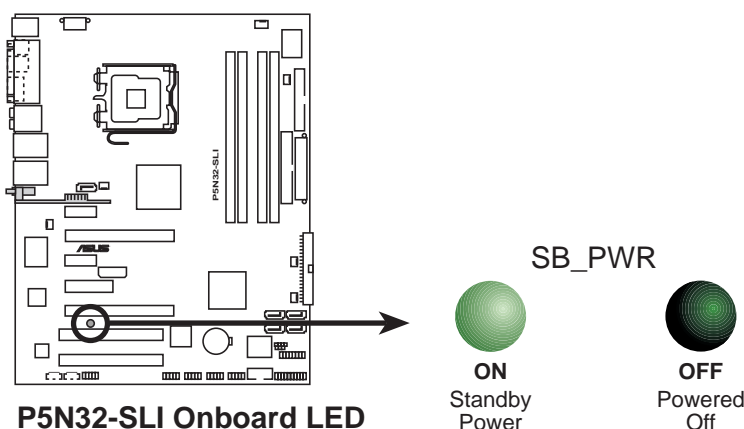

Make sure to connect the EZPlug when using two PCI Express graphics cards and a 20-pin ATX power supply unit, or if the graphics cards do not have auxiliary power plugs. See page 2-37 for the location of the EZPlug connector.

## 2.2 Motherboard overview

Before you install the motherboard, study the configuration of your chassis to ensure that the motherboard fits into it.



Make sure to unplug the power cord before installing or removing the motherboard. Failure to do so can cause you physical injury and damage motherboard components.

### 2.2.1 Placement direction

When installing the motherboard, make sure that you place it into the chassis in the correct orientation. The edge with external ports goes to the rear part of the chassis as indicated in the image below.

### 2.2.2 Screw holes

Place nine (9) screws into the holes indicated by circles to secure the motherboard to the chassis.



Do not overtighten the screws! Doing so can damage the motherboard.

Place this side towards  
the rear of the chassis

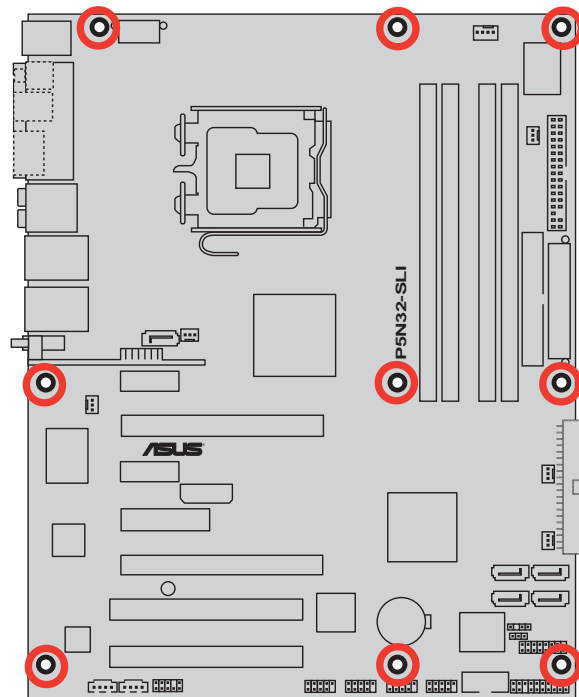

### 2.2.3 ASUS Stack Cool 2

The motherboard comes with the ASUS Stack Cool 2 cooling solution that lowers the temperature of critical heat generating components. The motherboard uses a special design on the printed circuit board (PCB) to dissipate heat that critical components generate.

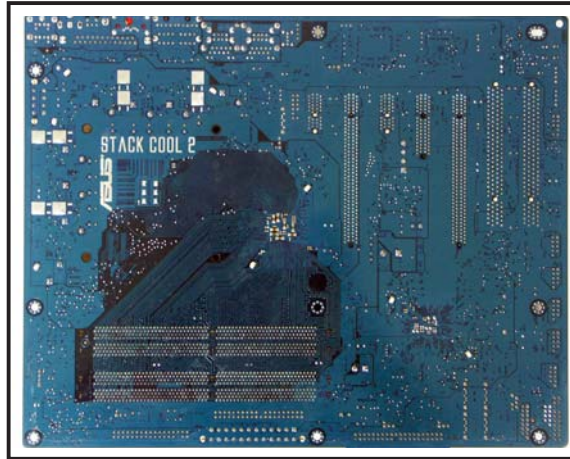

## 2.2.3 Motherboard layout

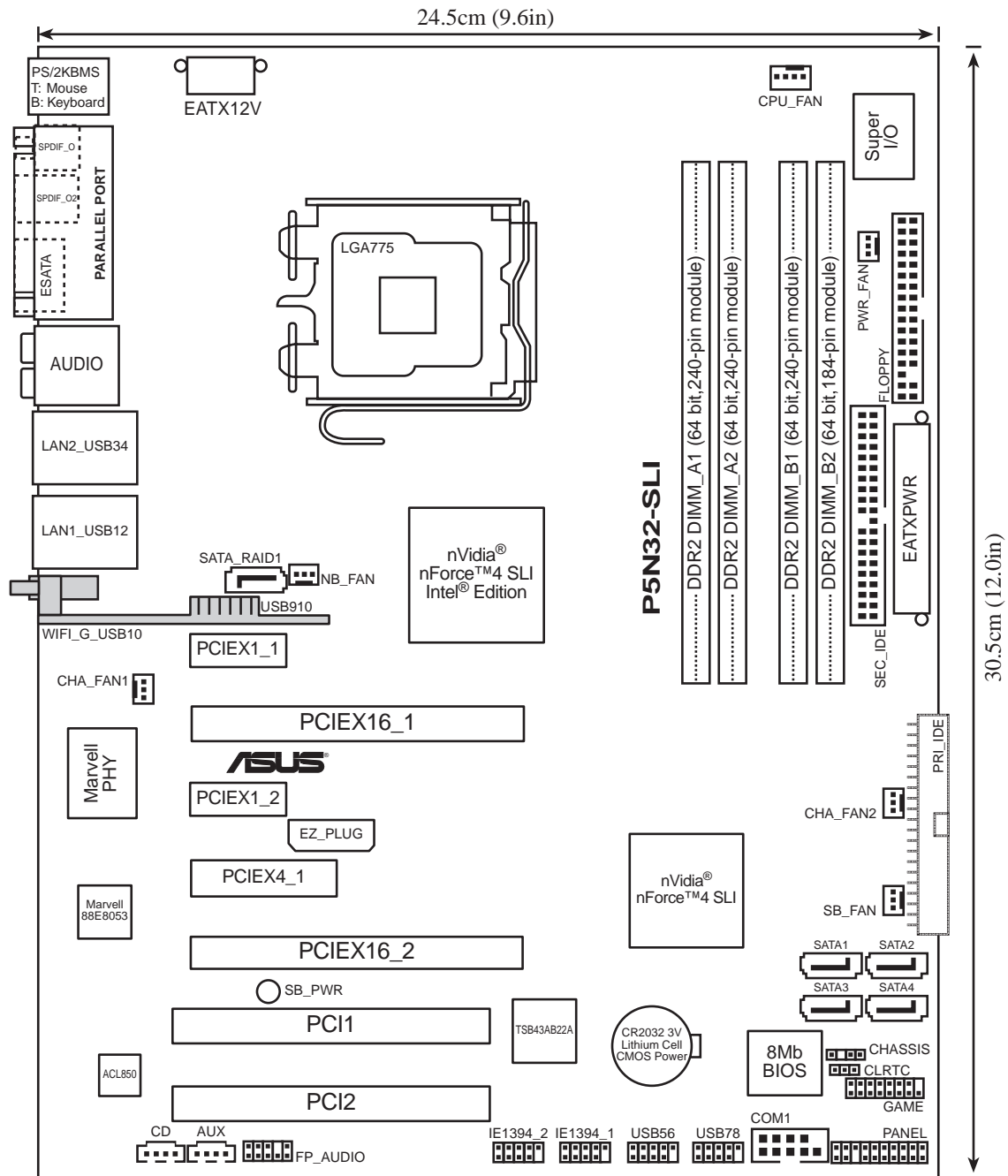

The Wireless LAN module and the USB port on the module are optional items and are grayed out in the above illustration.

## 2.2.4 Layout contents

Slots	Page
1. DDR2 DIMM slots	2-14
2. PCI slots	2-23
3. PCI Express x1 slots	2-23
4. PCI Express x 4 slot	2-23
5. PCI Express x16 slots	2-24

Jumper	Page
1. Clear RTC RAM (3-pin CLRTC)	2-25

Rear panel connectors	Page
1. PS/2 mouse port (green)	2-26
2. Parallel port	2-26
3. Side Speaker Out port (black)	2-26
4. Rear Speaker Out port (gray)	2-26
5. Line In port (light blue)	2-26
6. Line Out port (lime)	2-26
7. LAN 2 (RJ-45)	2-27
8. LAN 1 (RJ-45)	2-27
9. Wireless LAN activity LED	2-27
10. Wireless LAN port	2-28
11. USB 2.0 port 9	2-28
12. USB 2.0 ports 3 and 4	2-28
13. USB 2.0 ports 1 and 2	2-28
14. Microphone port (pink)	2-28
15. Center/Subwoofer port (orange)	2-28
16. External SATA port	2-28
17. Optical S/PDIF Out port	2-29
18. Coaxial S/PDIF Out port	2-29
19. PS/2 keyboard port (purple)	2-29

Internal connectors		Page
1.	Floppy disk drive connector (34-1 pin FLOPPY)	2-29
2.	Primary IDE connector (40-1 pin PRI_IDE)	2-30
3.	Secondary IDE connector (40-1 pin SEC_IDE)	2-30
4.	NVIDIA® SATA connectors (7-pin SATA1 [blue], SATA2 [blue], SATA3 [blue], SATA4 [blue])	2-31
5.	Silicon Image® SATA RAID connector (7-pin SATA_RAID1 [red])	2-32
6.	Optical drive audio connector (4-pin CD)	2-33
7.	Auxiliary audio connector (4-pin AUX)	2-33
8.	USB connectors (10-1 pin USB56, USB78)	2-33
9.	Front panel audio connector (10-1 pin FP_AUDIO)	2-34
10.	IEEE 1394 port connectors (10-1 pin IE1394_1, IE1394_2)	2-34
11.	GAME/MIDI port connector (16-1 pin GAME)	2-35
12.	Serial port connector (10-1 pin COM1)	2-35
13.	CPU, Chassis, Northbridge, and Power Fan connectors (4-pin CPU_FAN, 3-pin PWR_FAN, 3-pin NB_FAN, 3-pin SB_FAN, 3-pin CHA_FAN1, 3-pin CHA_FAN2)	2-36
14.	Chassis intrusion connector (4-1 pin CHASSIS)	2-37
15.	ATX power connectors (24-pin EATXPWR, 8-pin EATX12V, 4-pin EZ_PLUG)	2-37
16.	System panel connector (20-pin PANEL) <ul style="list-style-type: none"> <li>• System power LED (Green 3-pin PLED)</li> <li>• Hard disk drive activity LED (Red 2-pin IDE_LED)</li> <li>• System warning speaker (Orange 4-pin SPEAKER)</li> <li>• ATX power button/soft-off button (Yellow 2-pin PWR)</li> <li>• Reset button (Blue 2-pin RESET)</li> </ul>	2-39



## 2.3 Central Processing Unit (CPU)

The motherboard comes with a surface mount LGA775 socket designed for the Intel® Pentium® D, Intel® Pentium® 4 and Intel® Celeron® processors in the 775-land package.

This motherboard supports the Intel® Pentium® Processor Extreme Edition, the latest CPU with embedded dual physical cores and Hyper-Threading technology, making four CPU threads possible. Refer to the table below for the operating system support status.

OS licensing support list	
Intel Dual-Core CPU support	Intel Dual-Core CPU and Hyper-Threading Technology support
Windows® 2000 Professional	
Windows® 2000 Advanced Server	Windows® 2000 Advanced Server
Windows® XP Home	Windows® XP Home
Windows® XP Professional	Windows® XP Professional
Windows® Server 2003 - Standard, Enterprise	Windows® Server 2003 - Standard, Enterprise



- Due to chipset limitation, Intel® Pentium® D 820 processors work only in single-core CPU mode.
- Due to chipset limitation, dual-core processors cannot support the Intel® EIST, TM2, and C1E functions.



- Install a chassis fan with at least a speed of 2400 rpm and 8 CFM turnrate when using a dual-core CPU to ensure system stability. Overheating can permanently damage the system and/or CPU.
- Install an additional chassis fan to ensure better air flow when overclocking.
- Upon purchase of the motherboard, make sure that the PnP cap is on the socket and the socket contacts are not bent. Contact your retailer immediately if the PnP cap is missing, or if you see any damage to the PnP cap/socket contacts/motherboard components. ASUS will shoulder the cost of repair only if the damage is shipment/transit-related.
- Keep the cap after installing the motherboard. ASUS will process Return Merchandise Authorization (RMA) requests only if the motherboard comes with the cap on the LGA775 socket.
- The product warranty does not cover damage to the socket contacts resulting from incorrect CPU installation/removal, or misplacement/loss/incorrect removal of the PnP cap.

## 2.3.1 Installing the CPU

To install a CPU:

1. Locate the CPU socket on the motherboard.

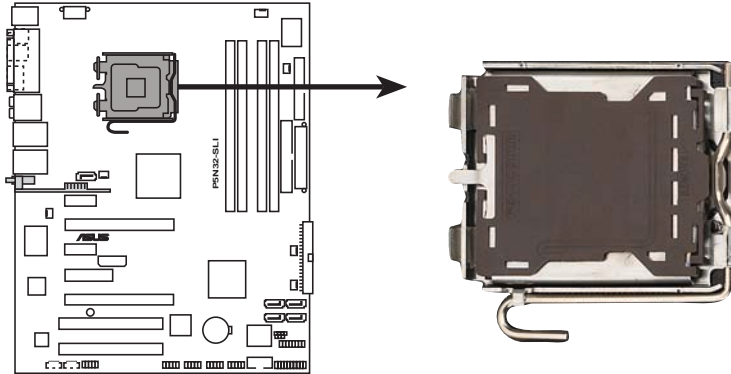

**P5N32-SLI CPU Socket 775**



Before installing the CPU, make sure that the cam box is facing towards you and the load lever is on your left.

2. Press the load lever with your thumb (A), then move it to the left (B) until it is released from the retention tab.

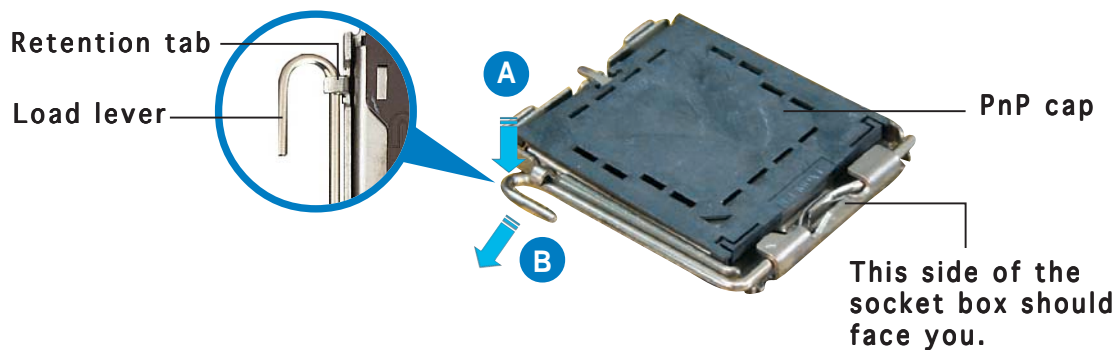

To prevent damage to the socket pins, do not remove the PnP cap unless you are installing a CPU.

3. Lift the load lever in the direction of the arrow to a 135° angle.

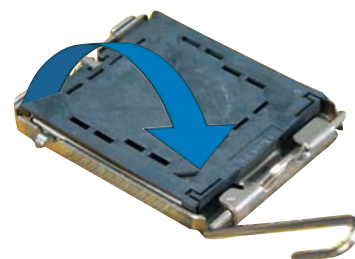

4. Lift the load plate with your thumb and forefinger to a 100° angle (A), then push the PnP cap from the load plate window to remove (B).

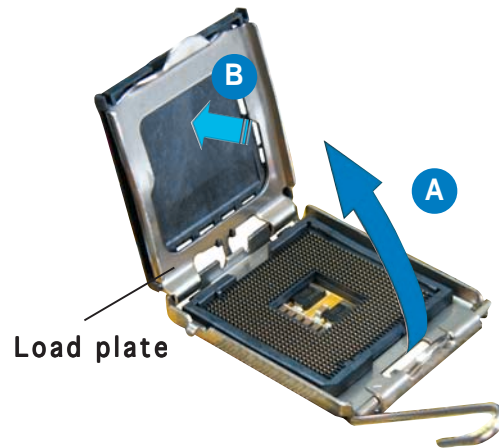

5. Position the CPU over the socket, making sure that the gold triangle is on the bottom-left corner of the socket. The socket alignment key should fit into the CPU notch.

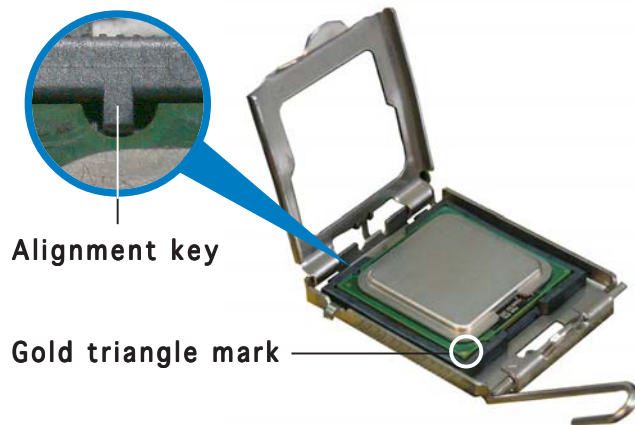

The CPU fits in only one correct orientation. DO NOT force the CPU into the socket to prevent bending the connectors on the socket and damaging the CPU!

6. Close the load plate (A), then push the load lever (B) until it snaps into the retention tab.



The motherboard supports Intel® Pentium® 4 LGA775 processors with the Intel® Enhanced Memory 64 Technology (EM64T), Enhanced Intel SpeedStep® Technology (EIST), and Hyper-Threading Technology. Refer to the Appendix for more information on these CPU features.

## 2.3.2 Installing the CPU heatsink and fan

Intel® LGA775 processors require a specially designed heatsink and fan assembly to ensure optimum thermal condition and performance.



- When you buy a boxed Intel® processor, the package includes the CPU fan and heatsink assembly. If you buy a CPU separately, make sure that you use only Intel®-certified multi-directional heatsink and fan.
- Your Intel® LGA775 processor heatsink and fan assembly comes in a push-pin design and requires no tool to install.
- If you purchased a separate CPU heatsink and fan assembly, make sure that you have properly applied Thermal Interface Material to the CPU heatsink or CPU before you install the heatsink and fan assembly.



Make sure that you have installed the motherboard to the chassis before you install the CPU fan and heatsink assembly.

To install the CPU heatsink and fan:

1. Place the heatsink on top of the installed CPU, making sure that the four fasteners match the holes on the motherboard.



Orient the heatsink and fan assembly such that the CPU fan cable is closest to the CPU fan connector.

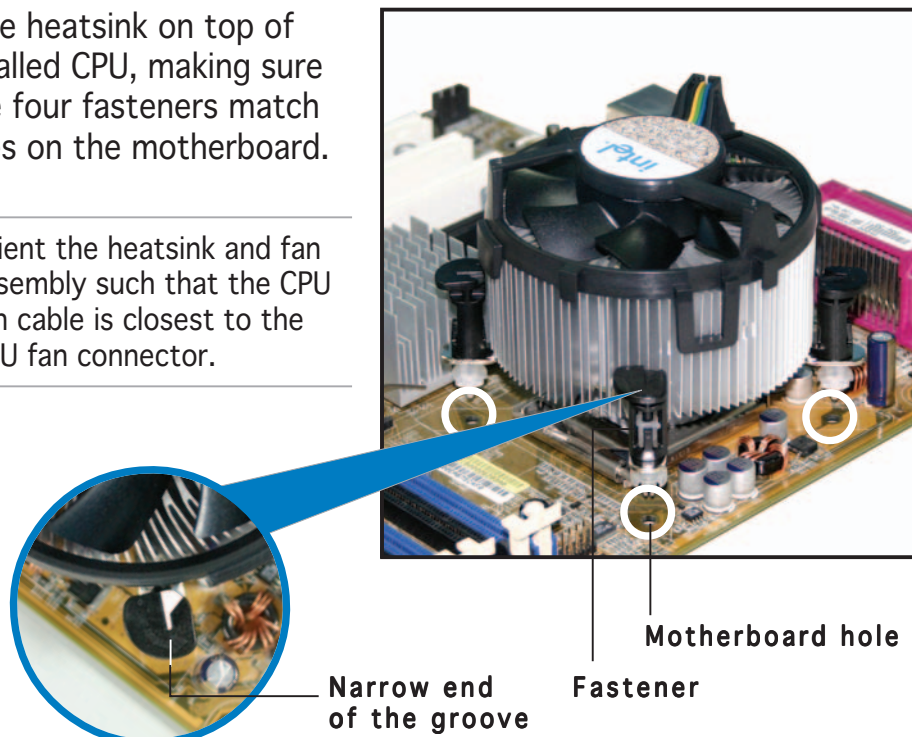

Make sure to orient each fastener with the narrow end of the groove pointing outward. (The photo shows the groove shaded for emphasis.)

2. Push down two fasteners at a time in a diagonal sequence to secure the heatsink and fan assembly in place.

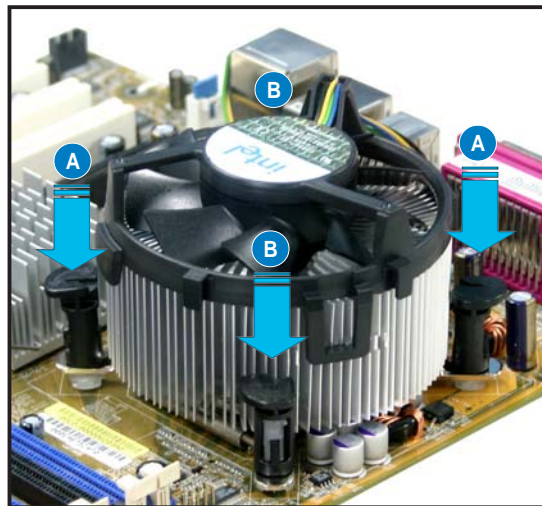
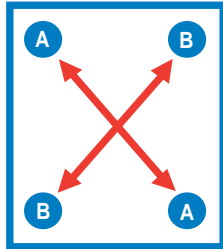

3. Connect the CPU fan cable to the connector on the motherboard labeled CPU\_FAN.

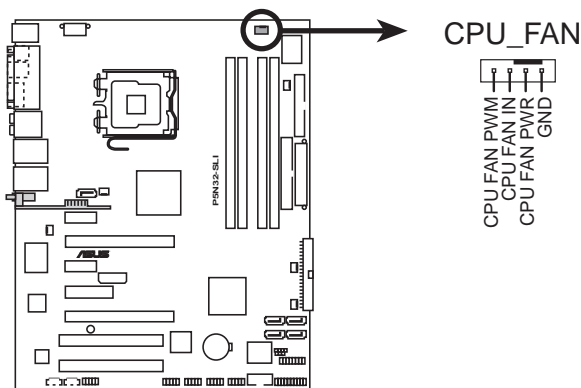

**P5N32-SLI CPU fan connector**



- Do not forget to connect the CPU fan connector! Hardware monitoring errors can occur if you fail to plug this connector.
- The retention module of some third-party CPU heatsink and fan can interfere with chipset components at the bottom of the board. Before purchasing a separate CPU heatsink and fan, make sure that it will not interfere with the chipset components.

### 2.3.3 Uninstalling the CPU heatsink and fan

To uninstall the CPU heatsink and fan:

1. Disconnect the CPU fan cable from the connector on the motherboard.
2. Rotate each fastener counterclockwise.
3. Pull up two fasteners at a time in a diagonal sequence to disengage the heatsink and fan assembly from the motherboard.

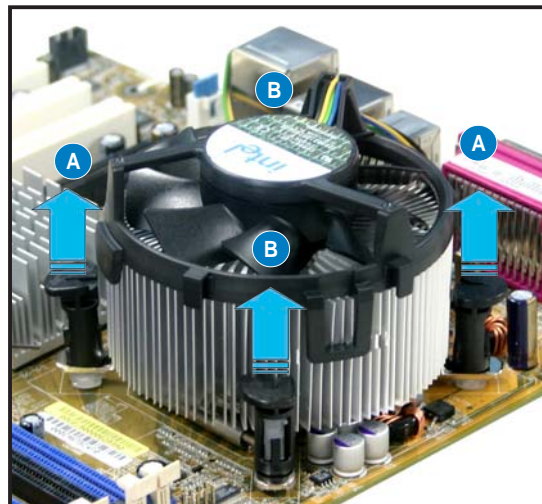
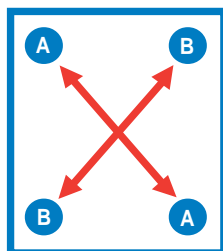

4. Carefully remove the heatsink and fan assembly from the motherboard.

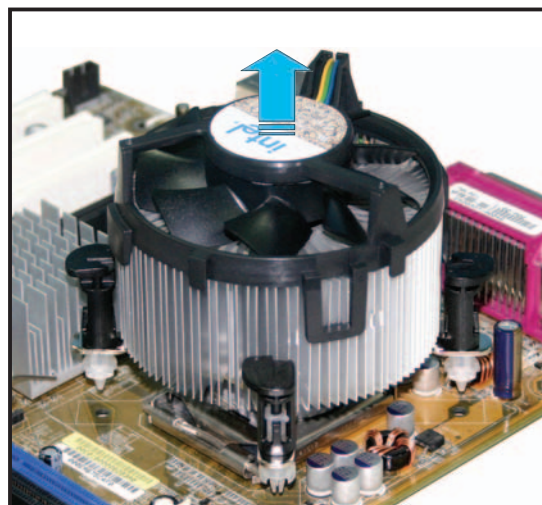

5. Rotate each fastener clockwise to ensure correct orientation when reinstalling.

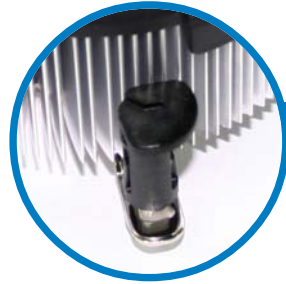

**Narrow end of the groove**



---

The narrow end of the groove should point outward after resetting. (The photo shows the groove shaded for emphasis.)

---

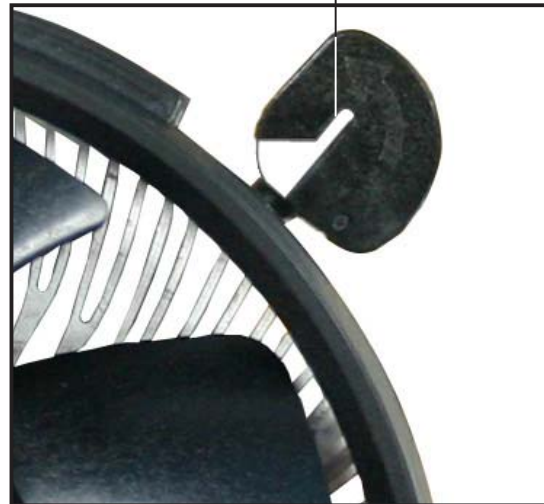

---

Refer to the documentation in the boxed or stand-alone CPU fan package for detailed information on CPU fan installation.

---

## 2.4 System memory

### 2.4.1 Overview

The motherboard comes with four Double Data Rate 2 (DDR2) Dual Inline Memory Modules (DIMM) sockets.

A DDR2 module has the same physical dimensions as a DDR DIMM but has a 240-pin footprint compared to the 184-pin DDR DIMM. DDR2 DIMMs are notched differently to prevent installation on a DDR DIMM socket.

The figure illustrates the location of the DDR2 DIMM sockets:

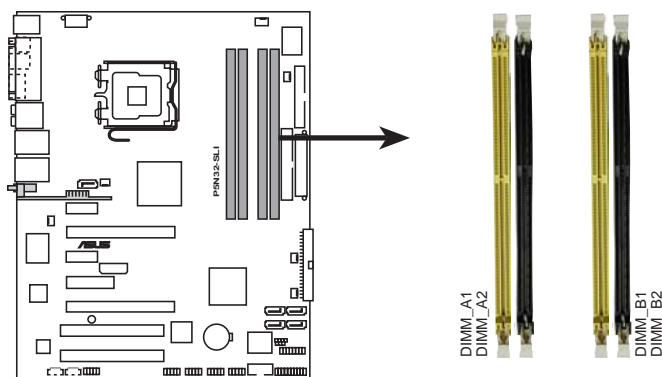

**P5N32-SLI 240-pin DDR2 DIMM sockets**

Channel	Sockets
Channel A	DIMM_A1 and DIMM_A2
Channel B	DIMM_B1 and DIMM_B2



## 2.4.2 Memory configurations

You may install 256 MB, 512 MB, 1 GB, 2 GB, and 4 GB unbuffered non-ECC DDR2 DIMMs into the DIMM sockets.



- If you installed four 1 GB memory modules, the system may detect less than 3 GB of total memory because of address space allocation for other critical functions. This limitation applies to Windows® XP 32-bit version operating system.
- If you installed Windows® XP 32-bit version operating system, we recommend that you install less than 3 GB of total memory.
- For dual-channel configuration, the total size of memory module(s) installed per channel must be the same (DIMM\_A1 + DIMM\_A2 = DIMM\_B1 + DIMM\_B2).
- Always install DIMMs with the same CAS latency. For optimum compatibility, we recommend that you obtain memory modules from the same vendor. Refer to the DDR2 Qualified Vendors List on the next page for details.
- Due to chipset resource allocation, the system may detect less than 16 GB system memory when you installed four 4 GB DDR2 memory modules.
- This motherboard does not support memory modules made up of 2048 Mb chips or double sided x16 memory modules.



The motherboard can support up to 16 GB on the operating systems listed below. You may install a maximum of 4 GB DIMMs on each slot.

32-bit	64-bit
Windows® 2000 Advanced Server Windows® Server 2003 Enterprise Edition	Windows® Server 2003 Standard x64 Edition Windows® XP Professional x64 Edition Windows® Server 2003 Enterprise x64 Edition

## Qualified Vendors Lists (QVL)

### DDR2-667 MHz capability

Size	Vendor	Model	Brand	Side(s)	Component	DIMM support			
						CL	A	B	C
512 MB	KINGSTON	KVR667D2N5/512	-	SS	E5108AE-GE-E	-	•	•	
1024 MB	KINGSTON	KVR667D2N5/1G	-	DS	E5108AE-GE-E	-	•	•	•
512 MB	KINGSTON	KVR667D2N5/512	-	SS	E5108AE-6E-E	-	•	•	
1024 MB	KINGSTON	KVR667D2N5/1G	-	DS	E5108AE-6E-E	-	•	•	•
512 MB	KINGSTON	KVR667D2E5/512	-	SS	E5108AE-GE-E	-		•	•
256 MB	SAMSUNG	M378T3253FZ0-CE6	-	SS	K4T56083QF-ZCE6	-	•	•	•
512 MB	SAMSUNG	M378T6453FZ0-CE6	-	DS	K4T56083QF-ZCE6	-	•	•	•
256 MB	SAMSUNG	M391T3253FZ0-CE6	-	SS	K4T56083QF-ZCE6(ECC)	-			
512 MB	SAMSUNG	M391T6453FZ0-CE6	-	DS	K4T56083QF-ZCE6(ECC)	-			
256 MB	SAMSUNG	M378T3354CZ0-CE6	-	SS	K4T51163QC-ZCE6	-	•	•	•
512 MB	SAMSUNG	M378T6553CZ0-CE6	-	SS	ZCE6K4T51083QC	-	•	•	•
1024 MB	SAMSUNG	M378T2953CZ0-CE6	-	DS	ZCE6K4T51083QC	-	•	•	•
256 MB	MICRON	MT8HTF3264AY-667B5	-	SS	4SB42D9CZM	-	•	•	
512 MB	MICRON	MT16HTF6464AY-667B4	-	DS	4VB41D9CZM	-	•	•	•
256 MB	MICRON	MT8HTF3264AY-667B6	-	SS	5FB42D9DPN	-	•	•	•
256 MB	Infineon	HYS64T32000HU-3S-A	-	SS	HYB18T512160AF-3S	-	•	•	
512 MB	Infineon	HYS64T64000HU-3S-A	-	SS	HYB18T512800AF3S	-	•	•	
1024 MB	Infineon	HYS64T128020HU-3S-A	-	DS	HYB18T512800AF3S	-	•	•	•
256 MB	Infineon	HYS72T32000HU-3S-A	-	SS	HYB18T256800AF3S(ECC)	-			
512 MB	Infineon	HYS72T64000HU-3S-A	-	SS	HYB18T512800AF3S(ECC)	-			
1024 MB	Infineon	HYS72T128020HU-3S-A	-	DS	HYB18T512800AF3S(ECC)	-			
512 MB	Hynix	HYMP564U64AP8-Y5	-	SS	HY5PS12821AFP-Y5	-	•		
1024 MB	Hynix	HYMP512U64AP8-Y5	-	DS	HY5PS12821AFP-Y5	-	•	•	
1024 MB	Hynix	HYMP112U72P8-Y5	-	SS	HY5PS1G831FP-Y5(ECC)	-			
512 MB	Hynix	HYMP564U72AP8-Y5	-	SS	HY5PS12821AFP-Y5(ECC)	-			
1024 MB	Hynix	HYMP512U72AP8-Y5	-	DS	HY5PS12821AFP-Y5(ECC)	-			
512 MB	Hynix	HYMP564U64AP8-Y4	-	SS	HY5PS12821AFP-Y4	-	•	•	
1024 MB	Hynix	HYMP512U64AP8-Y4	-	DS	HY5PS12821AFP-Y4	-	•	•	•
512 MB	Hynix	HYMP564U72AP8-Y4	-	SS	HY5PS12821AFP-Y4(ECC)	-			
1024 MB	Hynix	HYMP512U72AP8-Y4	-	DS	HY5PS12821AFP-Y4(ECC)	-			
256 MB	ELPIDA	EBE25UC8ABFA-6E-E	-	SS	E2508AB-GE-E	-	•	•	
512 MB	ELPIDA	EBE51UD8AEFA-6E-E	-	SS	E5108AE-GE-E	-	•	•	
1024 MB	ELPIDA	EBE11UD8AEFA-6E-E	-	DS	Engineering Sample	-	•	•	
256 MB	crucial	BL3264AA664.8FB	-	SS	Heat-Sink Package	-			
512 MB	crucial	BL6464AA664.16FB	-	DS	Heat-Sink Package	-			
1024 MB	crucial	BL12864AA664.16FA	-	DS	Heat-Sink Package	-			
512 MB	crucial	BL6464AL664.16FB	-	DS	Heat-Sink Package	-			
1024 MB	crucial	BL12864AL664.16FA	-	DS	Heat-Sink Package	-			
512 MB	TwinMOS	8G-25JK5-EBT	-	SS	E5108AE-GE-E	-			
512 MB	Kingmax	KLCC28F-A8EB5	-	SS	E5108AE-6E-E	-			
1024 MB	Kingmax	KLCD48F-A8EB5	-	DS	E5108AE-6E-E	-			
512 MB	GEIL	GX21GB5300UDC	-	SS	Heat-Sink Package	-			
512 MB	GEIL	GX21GB5300DC	-	SS	Heat-Sink Package	-			
256 MB	NANYA	NT256T64UH4A0FY-3C	-	SS	NT5TU32M16AG-3C	-			
512 MB	NANYA	NT512T64U88A0BY-3C	-	SS	NT5TU64M8AE-3C	-			
512 MB	OCZ	OCZ26671024EBDCPE-K	-	SS	Heat-Sink Package	-			

(Continued on the next page)

## DDR2-667 MHz capability

Size	Vendor	Model	Brand	Side(s)	Component	DIMM support			
						CL	A	B	C
1024 MB	OCZ	OCZ26672048EBDCPE-K	-	DS	Heat-Sink Package	-			
1024 MB	PQI	MEAD-403LA	-	SS	E5108AE-5C-E	-			
512 MB	WINTEC	39127282	-	SS	4UAI2D9CRZ	-			
1024 MB	WINTEC	39137282	-	DS	4WAIID9CWX	-			
512 MB	Apacer	78.91092.420	-	SS	E5108AE-6E-E	-			
1024 MB	Apacer	78.01092.420	-	DS	E5108AE-6E-E	-			
512 MB	A-DATA	M20EL5G3H3160B1COZ	-	SS	E5108AE-6E-E	-			
1024 MB	PDP	PDC21G5600+XBLK	-	SS	Heat-Sink Package	-			

**Side(s):** **SS** - Single-sided **DS** - Double-sided

### DIMM support:

- A** - Supports one module inserted into either slot, in Single-channel memory configuration.
- B** - Supports one pair of modules inserted into either Channel A or Channel B as one pair of Dual-channel memory configuration.
- C** - Supports four modules inserted into the yellow and black slots as two pairs of Dual-channel memory configuration.



Visit the ASUS website for the latest DDR2-667 MHz QVL.

## DDR2-533 MHz capability

Size	Vendor	Part No.	Brand	Side(s)	Chip No.	DIMM support			
						CL	A	B	C
256 MB	KINGSTON	KVR533D2N4/256	-	SS	E5116AB-5C-E	-	•	•	•
512 MB	KINGSTON	KVR533D2N4/512	-	DS	HY5PS56821F-C4	-			
1024 MB	KINGSTON	KVR533D2N4/1G	-	DS	D6408TE7BL-37	-			
512 MB	SAMSUNG	M378T6553BG0-CD5	-	SS	K4T51083QB-GCD5	-			
256 MB	SAMSUNG	M378T3253FG0-CD5	-	SS	K4T56083QF-GCD5	-	•	•	•
512 MB	SAMSUNG	M378T6453FG0-CD5	-	DS	K4T56083QF-GCD5	-	•	•	
512 MB	SAMSUNG	M391T6453FG0-CD5	-	DS	K4T56083QF-GCD5(ECC)	-			
1024 MB	SAMSUNG	M378T2953BG0-CD5	-	DS	K4T51083QB-GCD5	-			
1024 MB	SAMSUNG	M391T2953BG0-CD5	-	DS	K4T51083QB-GCD5(ECC)	-			
512 MB	MICRON	MT16HTF6464AG-53EB2	-	DS	4FBII9BQM	-			
256 MB	MICRON	-	-	SS	4DBIIZ9BQT	-			
256 MB	MICRON	MT8HTF3264AY-53EB3	-	SS	4FBII9CHM	-			
512 MB	MICRON	MT16HTF6464AY-53EB2	-	DS	4FBII9CHM	-			
1024 MB	MICRON	MT18HTF12872AY-53EA1	-	DS	4MAIID9CRZ(ECC)	-			
512 MB	Infineon	HYS72T64000HU-3.7-A	-	SS	HYB18T512800AF3(ECC)	-			
512 MB	Infineon	HYS64T64000GU-3.7-A	-	SS	HYB18T512800AC37	-	•	•	•
256 MB	Infineon	HYS64T32000HU-3.7-A	-	SS	HYB18T512160AF-3.7	-			
512 MB	Infineon	HYS64T64000HU-3.7-A	-	SS	HYB18T512800AF37	-	•	•	
256 MB	Infineon	HYS64T128020HU-3.7-A	-	DS	HYB18T512800AF37	-			

(Continued on the next page)

## DDR2-533 MHz capability

Size	Vendor	Part No.	Brand	Side(s)	Chip No.	DIMM support			
						CL	A	B	C
2048 MB	Infineon	HYS64T256020HU-3.7-A	-	DS	HYB18T1G800AF-3.7	-			
256 MB	Infineon	HYS64T32000HU-3.7-B	-	SS	HYB18T5121608BF-3.7	-			
512 MB	Infineon	HYS64T64000HU-3.7-B	-	SS	HYB18T512800BF37	-			
1024 MB	Infineon	HYS64T128020HU-3.7-B	-	DS	HYB18T512800BF37	-			
512 MB	Hynix	HYMP564U648-C4	-	SS	HY5PS12821F-C4	-	•	•	
512 MB	Hynix	HYMP564U728-C4	-	SS	HY5PS12821F-C4(ECC)	-			
1024 MB	Hynix	HYMP512U648-C4	-	DS	HY5PS12821F-C4	-			
1024 MB	Hynix	HYMP512U728-C4	-	DS	HY5PS12821F-C4(ECC)	-			
1024 MB	Hynix	HYMP512U728-C4	-	DS	HY5PS12821F-E3(ECC)	-			
512 MB	Hynix	HYMP564U728-C4	-	SS	HY5PS12821FP-C4(ECC)	-			
1024 MB	Hynix	HYMP512U648-C4	-	DS	HY5PS12821FP-C4	-			
512 MB	Hynix	HYMP564U64AP8-C3	-	SS	HY5PS12821AFP-C3	-			
1024 MB	Hynix	HYMP512U64AP8-C3	-	DS	HY5PS12821AFP-C3	-			
512 MB	ELPIDA	EBE51ED8ABFA-5C-E	-	SS	E5108AB-5C-E(ECC)	-			
512 MB	ELPIDA	EBE51UD8ABFA-5C	-	SS	E5108AB-5C-E	-	•	•	•
512 MB	ELPIDA	EBE51UD8ABFA-5C-E	-	SS	E5108AB-5C-E	-			
1024 MB	ELPIDA	EBE11UD8ABFA-5C-E	-	DS	E5108AB-5C-E	-			
2048 MB	ELPIDA	EBE21EE8AAFA-5C-E	-	DS	E1108AA-5C-E	-			
256 MB	CORSAIR	VS256MB533D2	-	SS	MIII0051832M8CEC	-			
512 MB	CORSAIR	VS512MB533D2	-	DS	MI110052432M8CEC	-			
256 MB	Apacer	78.81077.420	-	SS	E5116AB-5C-E	-			
256 MB	CENTURY	25V6S8SSD5F4-K43	-	SS	K4T56083QF-GCD5	-			
512 MB	CENTURY	25V2H8EL5CB4-J43	-	SS	E5108AB-5C-E	-			
1024 MB	CENTURY	25V0H8EL5CB4-J45	-	DS	E5108AB-5C-E	-			
1024 MB	CENTURY	25VOH8EL5C	-	DS	E5108AB-5C-E	-			
256 MB	crucial	BL3264AA53V.8FB	-	SS	Heat-Sink Package	-			
512 MB	crucial	BL6464AA53V.16FB	-	DS	Heat-Sink Package	-			
256 MB	elixir	M2U25664TUH4A0F-37B	-	SS	N2TU51216AF-37B	-			
512 MB	elixir	M2U51264TU88A0F-37B	-	SS	N2TU51280AF-37B	-			
256 MB	Aeneon	AET560UD00-370A98X	-	SS	AET960UD00-37C88X	-			
512 MB	Aeneon	AET660UD00-370A98X	-	SS	AET960UD00-37C88X	-			
512 MB	Aeneon	AET660UD00-370A98X	-	SS	AET93F370AG0513	-			
256 MB	Aeneon	AET560UD00-370A98Z	-	SS	AET94F370A	-			
256 MB	Aeneon	AET560UD00-370A98X	-	SS	AET94F370A	-			
512 MB	Aeneon	AET660UD00-370A98Z	-	SS	AET93F370A	-			
512 MB	Aeneon	AET660UD00-370A98X	-	SS	AET93F370A	-			
512 MB	Aeneon	AET660UD00-370A98X	-	SS	AET93F370	-			
256 MB	KINGMAX	KLBB68K-38SP4	-	SS	K4T56083QF-GCD5	-			
1024 MB	KINGMAX	KLBD48F-A8EP4	-	DS	E5108AB-5C-E	-			
512 MB	KINGMAX	KLBC28F-A8EP4	-	SS	E5108AB-5C-E	-			
256 MB	KINGMAX	KLBB68F-38KP4	-	SS	KKEA88A4IA-37	-			
512 MB	KINGMAX	KLBC28F-A8KP4	-	SS	KKEA88A4IA-37	-			
1024 MB	KINGMAX	KLBD48F-A8KP4	-	DS	KKEA88A4IA-37	-			
256 MB	KINGMAX	KLBB68F-36EP4	-	SS	E5116AB-5C-E	-			
512 MB	KINGMAX	KLBC28F-A8EB4	-	SS	E5108AE-5C-E	-			
1024 MB	KINGMAX	KLBD48F-A8EB4	-	DS	E5108AE-5C-E	-			
256 MB	NANYA	NT256T64UH4A0F-37B	-	SS	NT5TU32M16AF-37B	-			

(Continued on the next page)

## DDR2-533 MHz capability

Size	Vendor	Part No.	Brand	Side(s)	Chip No.	DIMM support			
						CL	A	B	C
512 MB	NANYA	NT512T64U88A0F-37B	-	SS	NT5TU64M8AF-37B	-			
512 MB	NANYA	NT512T72U89A0F-37B	-	SS	NT5TU64M8AF-37B(ECC)	-			
1024 MB	NANYA	NT1GT64U8HA0F-37B	-	DS	NT5TU64M8AF-37B	-			
1024 MB	PQI	MEAB-323LA	-	DS	64MX8D2-E	-			
512 MB	PQI	MEAB-423LA	-	SS	64MX8D2-E	-			
512 MB	TwinMOS	8D-22JB5-K2T	-	SS	K4T51083QB-GCD5	-			
512 MB	Transcend	TS64MLQ64V5J	-	SS	K4T51083QB-GCD5	-			
1024 MB	Transcend	TS128MLQ64V5J	-	DS	K4T51083QB-GCD5	-			
256 MB	SimpleTech	SVM-42DR2/256	-	SS	858S032F25A	-			
512 MB	SimpleTech	SVM-42DR2/512	-	DS	858S064F25A	-			
512 MB	MDT	M512-533-8	-	SS	18D51280D-3.70S20	-			
1024 MB	MDT	M924-533-16	-	DS	18D51280D-3.70448	-			

**Side(s):** **SS** - Single-sided **DS** - Double-sided

### DIMM support:

- A** - Supports one module inserted into either slot, in Single-channel memory configuration.
- B** - Supports one pair of modules inserted into either Channel A or Channel B as one pair of Dual-channel memory configuration.
- C** - Supports two pairs of modules inserted into the yellow and black slots as two pairs of Dual-channel memory configuration.



Visit the ASUS website for the latest DDR2-533 MHz QVL.

## 2.4.3 Installing a DIMM



Unplug the power supply before adding or removing DIMMs or other system components. Failure to do so can cause severe damage to both the motherboard and the components.

To install a DIMM:

1. Unlock a DIMM socket by pressing the retaining clips outward.
2. Align a DIMM on the socket such that the notch on the DIMM matches the break on the socket.
3. Firmly insert the DIMM into the socket until the retaining clips snap back in place and the DIMM is properly seated.

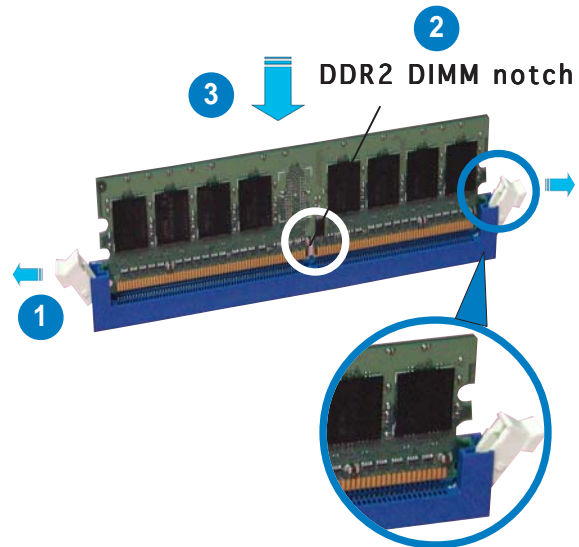

Unlocked retaining clip



- A DDR2 DIMM is keyed with a notch so that it fits in only one direction. Do not force a DIMM into a socket to avoid damaging the DIMM.
- The DDR2 DIMM sockets do not support DDR DIMMs. DO not install DDR DIMMs to the DDR2 DIMM sockets.

## 2.4.4 Removing a DIMM

To remove a DIMM:

1. Simultaneously press the retaining clips outward to unlock the DIMM.



Support the DIMM lightly with your fingers when pressing the retaining clips. The DIMM might get damaged when it flips out with extra force.

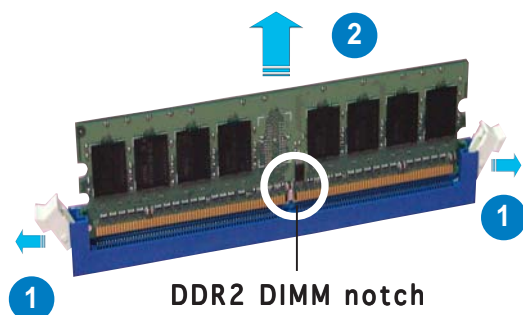

2. Remove the DIMM from the socket.

## 2.5 Expansion slots

In the future, you may need to install expansion cards. The following sub-sections describe the slots and the expansion cards that they support.



---

Make sure to unplug the power cord before adding or removing expansion cards. Failure to do so may cause you physical injury and damage motherboard components.

---

### 2.5.1 Installing an expansion card

To install an expansion card:

1. Before installing the expansion card, read the documentation that came with it and make the necessary hardware settings for the card.
2. Remove the system unit cover (if your motherboard is already installed in a chassis).
3. Remove the bracket opposite the slot that you intend to use. Keep the screw for later use.
4. Align the card connector with the slot and press firmly until the card is completely seated on the slot.
5. Secure the card to the chassis with the screw you removed earlier.
6. Replace the system cover.

### 2.5.2 Configuring an expansion card

After installing the expansion card, configure the it by adjusting the software settings.

1. Turn on the system and change the necessary BIOS settings, if any. See Chapter 4 for information on BIOS setup.
2. Assign an IRQ to the card. Refer to the tables on the next page.
3. Install the software drivers for the expansion card.



---

When using PCI cards on shared slots, ensure that the drivers support “Share IRQ” or that the cards do not need IRQ assignments. Otherwise, conflicts will arise between the two PCI groups, making the system unstable and the card inoperable. Refer to the table on the next page for details.

---

## 2.5.3 Interrupt assignments

### Standard interrupt assignments

IRQ	Priority	Standard Function
0	1	System Timer
1	2	Keyboard Controller
2	—	Re-direct to IRQ#9
4	12	Communications Port (COM1)*
5	13	IRQ holder for PCI steering*
6	14	Floppy Disk Controller
7	15	Printer Port (LPT1)*
8	3	System CMOS/Real Time Clock
9	4	IRQ holder for PCI steering*
10	5	IRQ holder for PCI steering*
11	6	IRQ holder for PCI steering*
12	7	PS/2 Compatible Mouse Port*
13	8	Numeric Data Processor
14	9	Primary IDE Channel
15	10	Secondary IDE Channel

\* These IRQs are usually available for ISA or PCI devices.

### IRQ assignments for this motherboard

	A	B	C	D	E	F	G	H
PCI Express x16 slot	shared	—	—	—	—	—	—	—
PCI Express x16 slot	shared	—	—	—	—	—	—	—
PCI Express x1 slot	shared	—	—	—	—	—	—	—
PCI Express x1 slot	shared	—	—	—	—	—	—	—
PCI slot 1	shared	—	—	—	—	—	—	—
PCI slot 2	—	shared	—	—	—	—	—	—
PCI slot 3	—	—	shared	—	—	—	—	—
Onboard USB 1.0 controller	shared	—	—	—	—	—	—	—
Onboard USB 1.0 controller	—	shared	—	—	—	—	—	—
Onboard USB 2.0 controller	—	—	shared	—	—	—	—	—
Onboard LAN1	shared	—	—	—	—	—	—	—
Onboard LAN2	—	—	—	shared	—	—	—	—
Onboard IDE controller	—	—	—	—	shared	—	—	—
Onboard SATA controller	shared	—	—	—	—	—	—	—
Onboard PCI SATA RAID (SI)	—	—	—	shared	—	—	—	—
Onboard 1394a	—	—	—	—	shared	—	—	—
Onboard Audio controller	shared	—	—	—	—	—	—	—



## 2.5.4 PCI slots

The PCI slots support cards such as a LAN card, SCSI card, USB card, and other cards that comply with PCI specifications. Refer to the figure below for the location of the slots.

## 2.5.5 PCI Express x1 slotS

This motherboard supports PCI Express x1 network cards, SCSI cards and other cards that comply with the PCI Express specifications. Refer to the figure below for the location of the slots.

## 2.5.6 PCI Express x4 slot

This motherboard supports PCI Express x4 network cards, SCSI cards and other cards that comply with the PCI Express specifications. Refer to the figure below for the location of the slot.

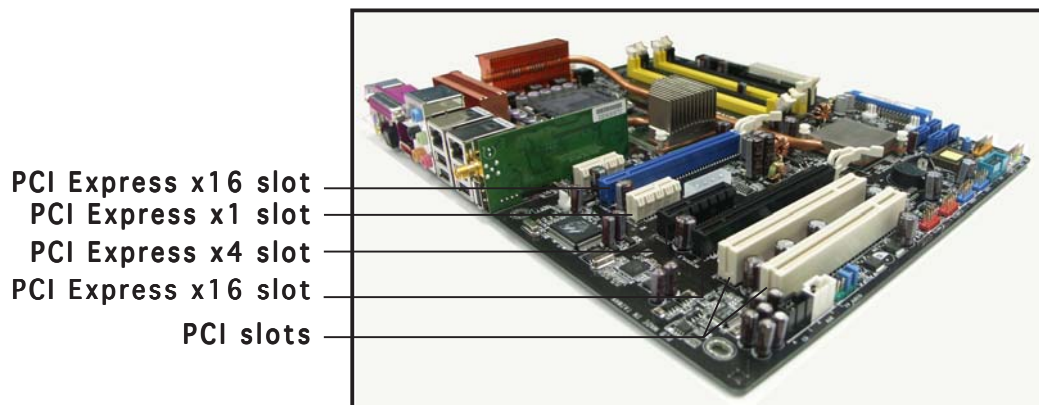

## 2.5.7 Two PCI Express x16 slots

This motherboard supports two SLI-ready PCI Express x16 graphics cards that comply with the PCI Express specifications. The figure shows two graphics card installed on the PCI Express x16 slots.

See Chapter 6 for details on the SLI technology feature.

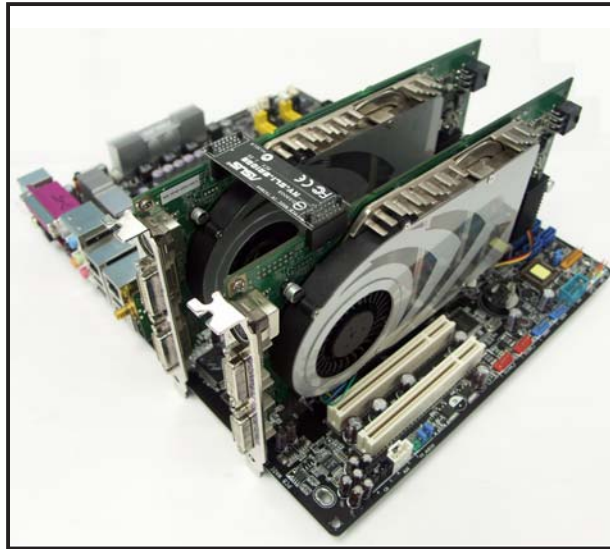

- 
- Install a rear chassis fan to either the chassis (CHA\_FAN1) or Northbridge (NB\_FAN) connectors when using two graphics cards for better thermal environment. See page 2-36 for details.
  - Connect the EZ Plug™ when using two graphics cards and a 20-pin ATX power supply, or if the graphics cards do not have auxiliary power plugs.
- 



- 
- In Single Card mode, we recommend that you use the blue slot for PCI Express x16 graphics cards.
  - In SLI mode, the PCI Express x16 slots work at the full bandwidth of PCI Express x16 on each slot for a combined bandwidth of x32.
-

## 2.6 Jumper

### Clear RTC RAM (CLRTC)

This jumper allows you to clear the Real Time Clock (RTC) RAM in CMOS. You can clear the CMOS memory of date, time, and system setup parameters by erasing the CMOS RTC RAM data. The onboard button cell battery powers the RAM data in CMOS, which include system setup information such as system passwords.

To erase the RTC RAM:

1. Turn OFF the computer and unplug the power cord.
2. Remove the onboard battery.
3. Move the jumper cap from pins 1-2 (default) to pins 2-3. Keep the cap on pins 2-3 for about 5~10 seconds, then move the cap back to pins 1-2.
4. Reinstall the battery.
5. Plug the power cord and turn ON the computer.
6. Hold down the <Del> key during the boot process and enter BIOS setup to re-enter data.



---

Except when clearing the RTC RAM, never remove the cap on CLRTC jumper default position. Removing the cap will cause system boot failure!

---

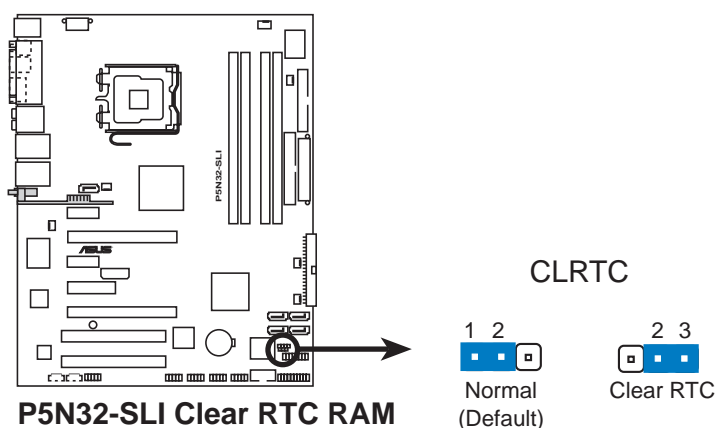

- Make sure to re-enter your previous BIOS settings after you clear the CMOS.
  - You do not need to clear the RTC when the system hangs due to overclocking. For system failure due to overclocking, use the C.P.R. (CPU Parameter Recall) feature. Shut down and reboot the system so the BIOS can automatically reset parameter settings to default values.
-

## 2.7 Connectors

### 2.7.1 Rear panel connectors

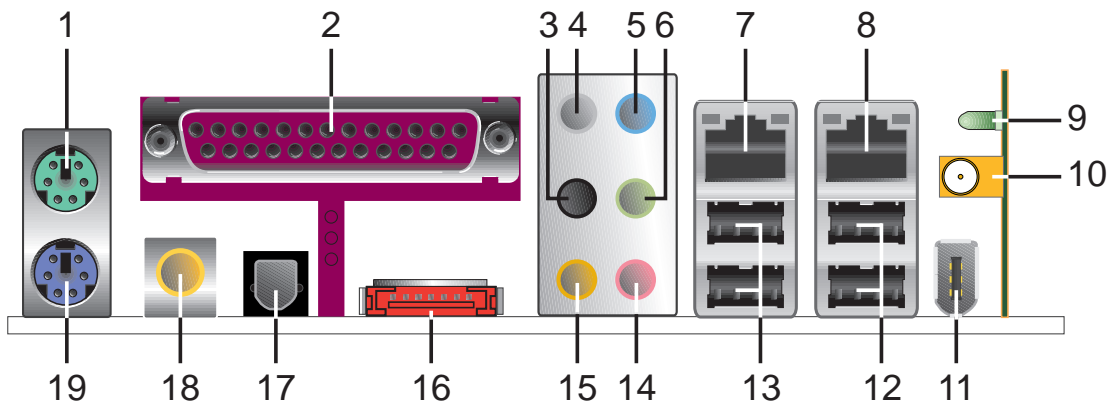

1. **PS/2 mouse port (green).** This port is for a PS/2 mouse.
2. **Parallel port.** This 25-pin port connects a parallel printer, a scanner, or other devices.
3. **Side Speaker Out port (black).** This port connects the side speakers in an 8-channel audio configuration.
4. **Rear Speaker Out port (gray).** This port connects the rear speakers on a 4-channel, 6-channel, or 8-channel audio configuration.
5. **Line In port (light blue).** This port connects the tape, CD, DVD player, or other audio sources.
6. **Line Out port (lime).** This port connects a headphone or a speaker. In 4-channel, 6-channel, and 8-channel configuration, the function of this port becomes Front Speaker Out.



- Refer to the audio configuration table below for the function of the audio ports in 2, 4, 6, or 8-channel configuration.
- See section “5.3.3 Audio configurations” on page 5-13 for details.

### Audio 2, 4, 6, or 8-channel configuration

Port	Headset 2-channel	4-channel	6-channel	8-channel
Light Blue	Line In	Line In	Line In	Line In
Lime	Line Out	Front Speaker Out	Front Speaker Out	Front Speaker Out
Pink	Mic In	Mic In	Mic In	Mic In
Gray	-	Rear Speaker Out	Rear Speaker Out	Rear Speaker Out
Black	-	-	-	Side Speaker Out
Orange	-	-	Center/Subwoofer	Center/Subwoofer

7. **LAN 2 (RJ-45) port.** Supported by Marvell® 88E8053 Gigabit LAN controller, this port allows Gigabit connection to a Local Area Network (LAN) through a network hub. Refer to the table below for the LAN port LED indications.
8. **LAN 1 (RJ-45) port.** Supported by the Marvell® 88E1115 Gigabit LAN controller, this port allows Gigabit connection to a Local Area Network (LAN) through a network hub. Refer to the table below for the LAN port LED indications.

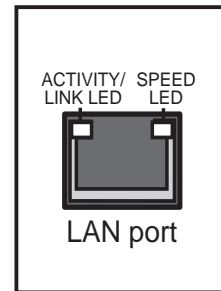

### 32-bit OS LAN port LED indications

Activity/Link	Speed LED	Description
OFF	OFF	Soft-off Mode
YELLOW*	OFF	During Power ON/OFF
YELLOW*	ORANGE	100 Mbps connection
YELLOW*	GREEN	1 Gbps connection

\* Blinking

### 64-bit OS LAN port LED indications

Activity/Link	Speed LED	Description
DNR	DNR	Soft-off Mode
DNR	DNR	During Power ON/OFF
DNR	DNR	100 Mbps connection
DNR	DNR	1 Gbps connection

DNR - Driver Not Ready



Item numbers 9, 10, and 11 are only for the optional Wireless LAN module.

9. **Wireless LAN Activity LED.** The wireless LAN module comes with an activity LED. Refer to the table below for the LED indications.

Status	Description
On	The wireless LAN module is on but has no data activity.
Off	The wireless LAN module is off.
Flashing	The wireless LAN module is transmitting and/or receiving data. The wireless LAN module is scanning for available access points or another wireless device.

- 10. Wireless LAN port.** This port is on the onboard wireless LAN module that allows you to set up a wireless network and exchange information with other wireless devices without tangling cables and wires. Connect the moveable omni-directional dual band-antenna to this port.

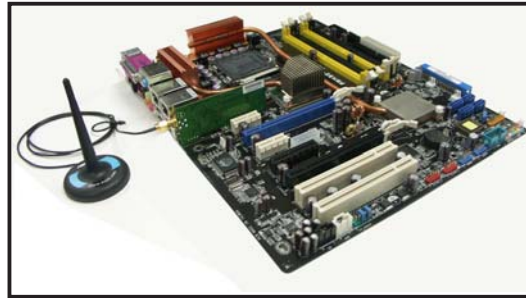

- 11. USB 2.0 port 9.** This 4-pin Universal Serial Bus (USB) port is available for connecting a USB 2.0 device.
- 12. USB 2.0 ports 1 and 2.** These two 4-pin Universal Serial Bus (USB) ports are available for connecting USB 2.0 devices.
- 13. USB 2.0 ports 3 and 4.** These two 4-pin Universal Serial Bus (USB) ports are available for connecting USB 2.0 devices.
- 14. Microphone port (pink).** This port connects a microphone.
- 15. Center/Subwoofer port (orange).** This port connects the center/subwoofer speakers.
- 16. External SATA port.** This port connects to an external SATA box or a Serial ATA port multiplier.



---

The external SATA port supports external Serial ATA 1.5 and 3 Gb/s devices. Longer cables support higher power requirements to deliver signal up to two meters away, and enables improved hot-swap function.

---



---

Do not insert a different connector to this port.

---

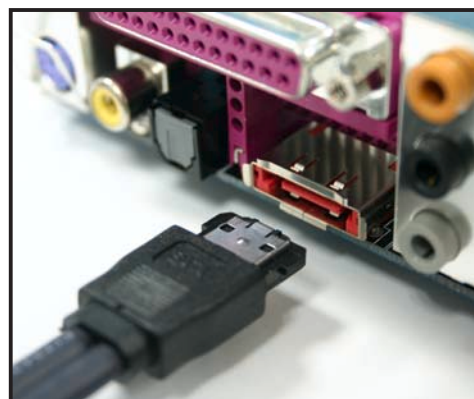

17. **Optical S/PDIF Out port.** This port connects an external audio output device via an optical S/PDIF cable.
18. **Coaxial S/PDIF Out port.** This port connects an external audio output device via a coaxial S/PDIF cable.
19. **PS/2 keyboard port (purple).** This port is for a PS/2 keyboard.

## 2.7.2 Internal connectors

### 1. Floppy disk drive connector (34-1 pin FLOPPY)

This connector is for the provided floppy disk drive (FDD) signal cable. Insert one end of the cable to this connector, then connect the other end to the signal connector at the back of the floppy disk drive.



---

Pin 5 on the connector is removed to prevent incorrect cable connection when using a FDD cable with a covered Pin 5.

---

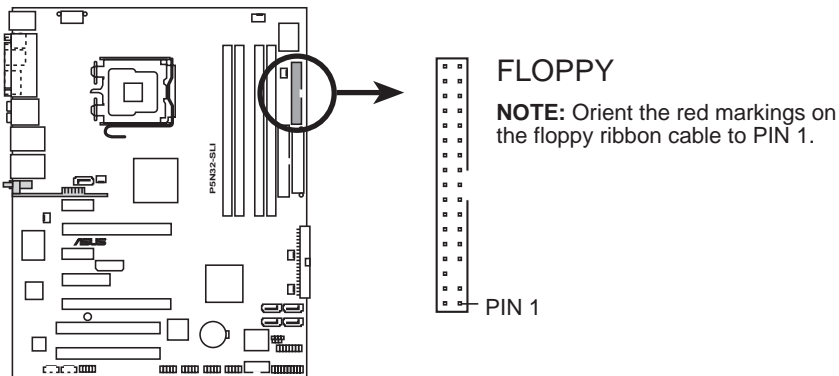

**P5N32-SLI Floppy disk drive connector**

## 2. IDE connectors (40-pin PRI\_IDE, SEC\_IDE)

These connectors are for Ultra DMA 133/100/66 signal cables. The Ultra DMA 133/100/66 signal cable has three connectors: a blue connector for the primary IDE connector on the motherboard, a black connector for an Ultra DMA 133/100/66 IDE slave device (optical drive/hard disk drive), and a gray connector for an Ultra DMA 133/100/66 IDE master device (hard disk drive). If you install two hard disk drives, you must configure the second drive as a slave device by setting its jumper accordingly. Refer to the hard disk documentation for the jumper settings.



- Pin 20 on the IDE connector is removed to match the covered hole on the Ultra DMA cable connector. This prevents incorrect insertion when you connect the IDE cable.
- Use the 80-conductor IDE cable for Ultra DMA 100/66 IDE devices.
- These connectors support RAID 0, RAID 1, RAID 0+1, RAID 5 and JBOD that spans across the Serial ATA drives.

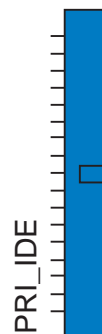
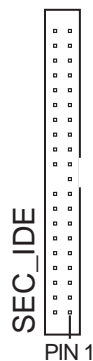
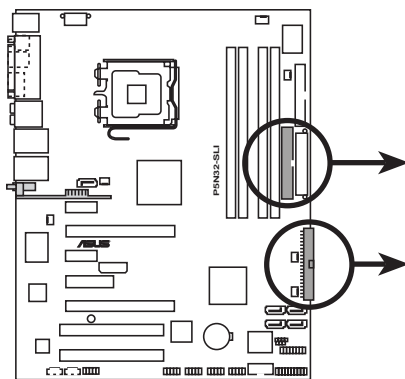

**NOTE:** Orient the red markings (usually zigzag) on the IDE ribbon cable to PIN 1.

**P5N32-SLI IDE connectors**



### 3. NVIDIA® nForce™ 4 SLI Southbridge Serial ATA connectors (7-pin SATA1 [blue], SATA2 [blue], SATA3 [blue], SATA4 [blue])

These connectors are for the Serial ATA signal cables for Serial ATA 3Gb/s hard disk and optical disk drives. The Serial ATA 3Gb/s is backward compatible with Serial ATA 1.5Gb/s specification.

If you installed Serial ATA hard disk drives, you can create a RAID 0, RAID 1, RAID 0+1, RAID 5, or JBOD configuration through the onboard NVIDIA® nForce™ 4 SLI RAID controller. Refer to section “5.4.2 NVIDIA® RAID configurations” for details on how to set up Serial ATA RAID configurations.



The RAID function of these connectors is set to [Disabled] by default. If you intend to create a Serial ATA RAID set using these connectors, enable the **nVidia RAID Function** item in the BIOS. See section “4.3.7 IDE Configuration” for details.

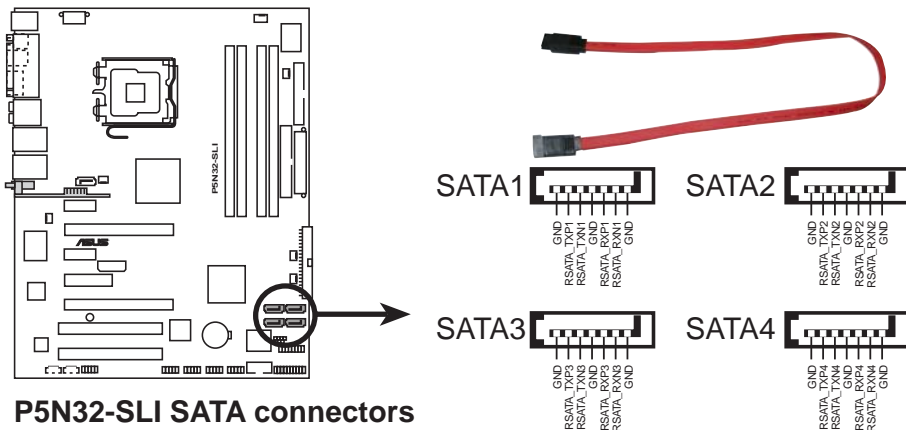

These connectors support Native Command Queuing (NCQ), Power Management (PM) Implementation Algorithm, Hot Swap and smart setup.

#### 4. Silicon Image® Serial ATA RAID connector (7-pin SATA\_RAID1)

This connector is for a Serial ATA signal cable. It supports a Serial ATA hard disk drive that you can combine with an external Serial ATA 3Gb/s device to configure a RAID 0, RAID 1, or JBOD set through the onboard Silicon Image SATA RAID controller. Refer to Chapter 5 for details on how to set up Serial ATA RAID configurations.



If you intend to create a RAID configuration using this connector, set the **Silicon 3132 Controller** item in the BIOS to [RAID Mode]. See section “4.4.6 Onboard Devices Configuration” for details.

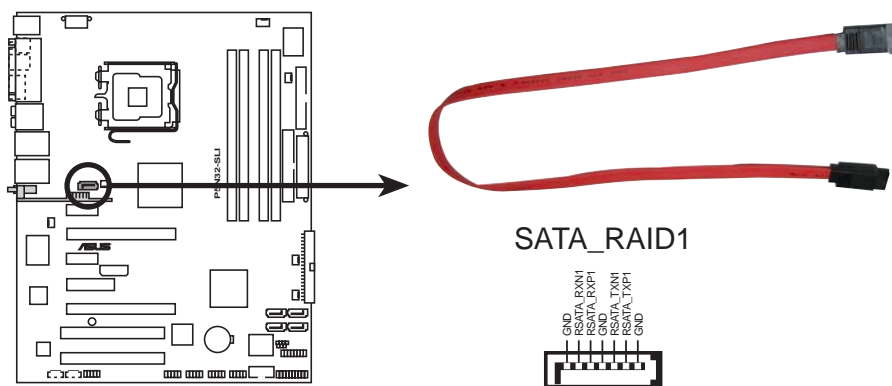

**P5N32-SLI SATA RAID connector**



- Before creating a RAID set using Serial ATA hard disks, make sure that you have connected the Serial ATA signal cable and installed Serial ATA hard disk drives; otherwise, you cannot enter the Silicon Image RAID utility and SATA BIOS setup during POST.
- Use this connector and an external Serial ATA box connected to the external SATA port, if you want to configure a RAID 0 or RAID 1 set.
- The Serial ATA port multiplier and external Serial ATA box are purchased separately.



DO NOT unplug the external Serial ATA box when a RAID 0 or RAID 1 is configured.

## 5. Audio connectors (4-pin CD, AUX)

These connectors allow you to receive stereo audio input from sound sources such as a CD-ROM, TV-tuner, or MPEG card.

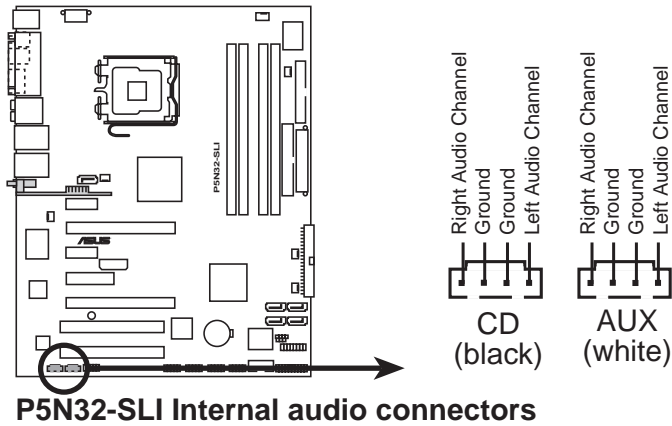

Due to system resource allocation, the function of the AUX connector is disabled under 8-channel mode.

## 6. USB connectors (10-1 pin USB56, USB78)

These connectors are for USB 2.0 ports. Connect the USB/GAME module cable to any of these connectors, then install the module to a slot opening at the back of the system chassis. These USB connectors comply with USB 2.0 specification that supports up to 480 Mbps connection speed.

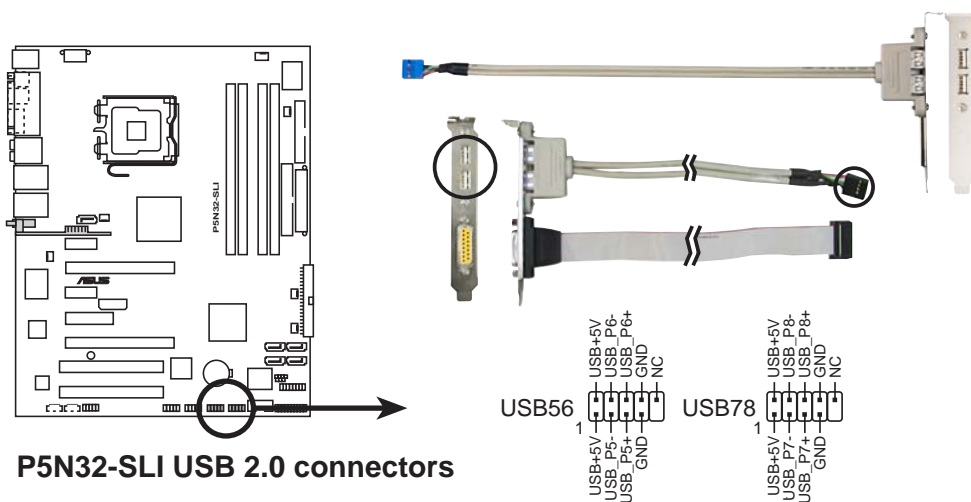

Never connect a **1394** cable to the USB connectors. Doing so will damage the motherboard!

## 7. Front panel audio connector (10-1 pin FP\_AUDIO)

This connector is for a chassis-mounted front panel audio I/O module that supports legacy AC '97 audio standard. Connect one end of the front panel audio I/O module cable to this connector.

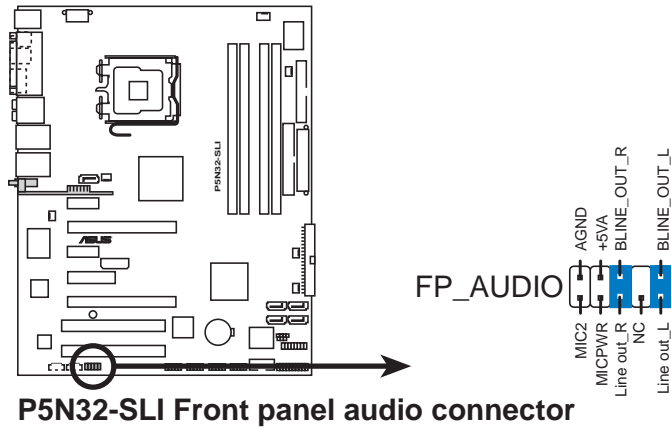

## 8. IEEE 1394 port connectors (10-1 pin IE1394\_1, IE1394\_2)

These connectors are for IEEE 1394 ports. Connect the IEEE 1394 module cable to this connector, then install the module to a slot opening at the back of the system chassis.

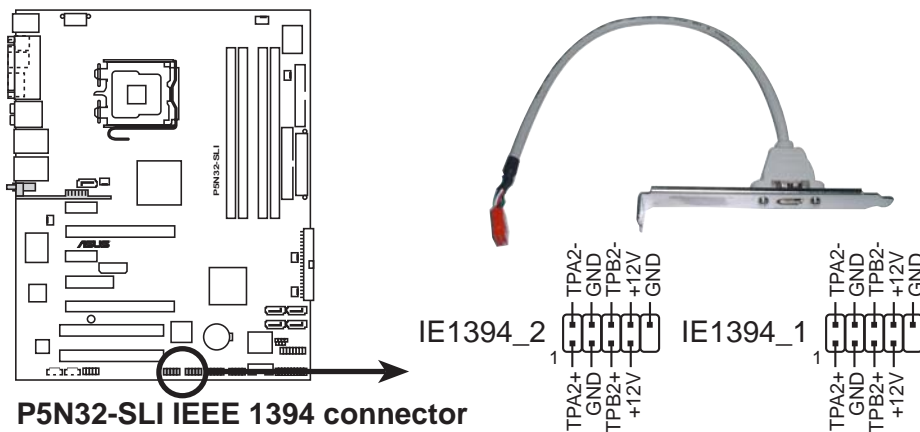

Never connect a **USB cable** to the IEEE 1394a connectors. Doing so will damage the motherboard!

## 9. GAME/MIDI port connector (16-1 pin GAME)

This connector is for a GAME/MIDI port. Connect the USB/GAME module cable to this connector, then install the module to a slot opening at the back of the system chassis. The GAME/MIDI port connects a joystick or game pad for playing games, and MIDI devices for playing or editing audio files.

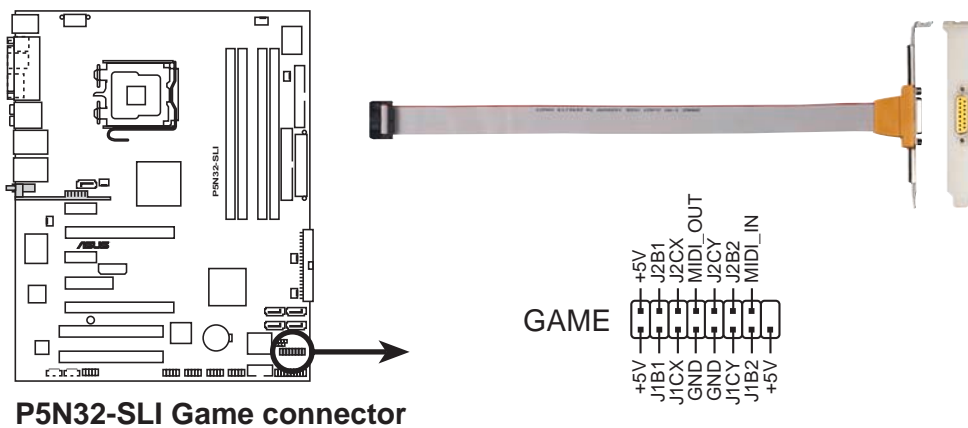

**P5N32-SLI Game connector**

## 10. Serial port connector (10-1 pin COM1)

This connector is for a serial (COM) port. Connect the serial port module cable to this connector, then install the module to a slot opening at the back of the system chassis.

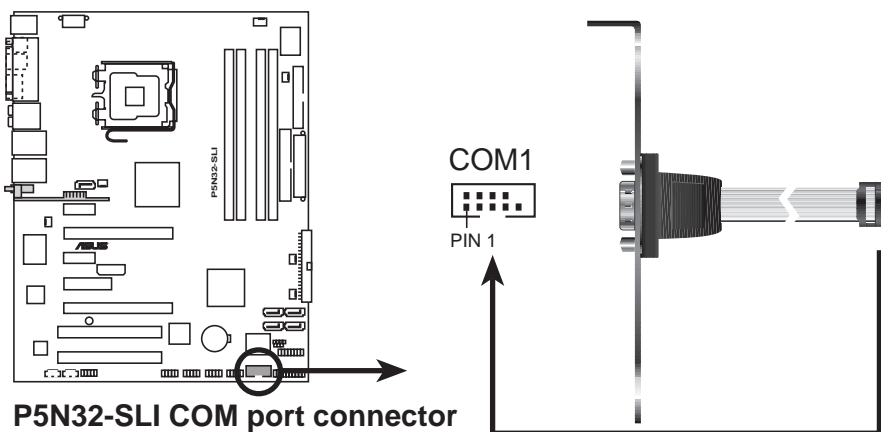

**P5N32-SLI COM port connector**

## 11. CPU, Chassis, Northbridge, and Power Fan connectors (4-pin CPU\_FAN, 3-pin PWR\_FAN, 3-pin CHA\_FAN1, 3-pin CHA\_FAN2, 3-pin NB\_FAN, 3-pin SB\_FAN)

The fan connectors support cooling fans of 350 mA ~ 2000 mA (24 W max.) or a total of 1 A ~ 3.48 A (41.76 W max.) at +12V. Connect the fan cables to the fan connectors on the motherboard, making sure that the black wire of each cable matches the ground pin of the connector.



Do not forget to connect the fan cables to the fan connectors. Insufficient air flow inside the system may damage the motherboard components. These are not jumpers! Do not place jumper caps on the fan connectors!

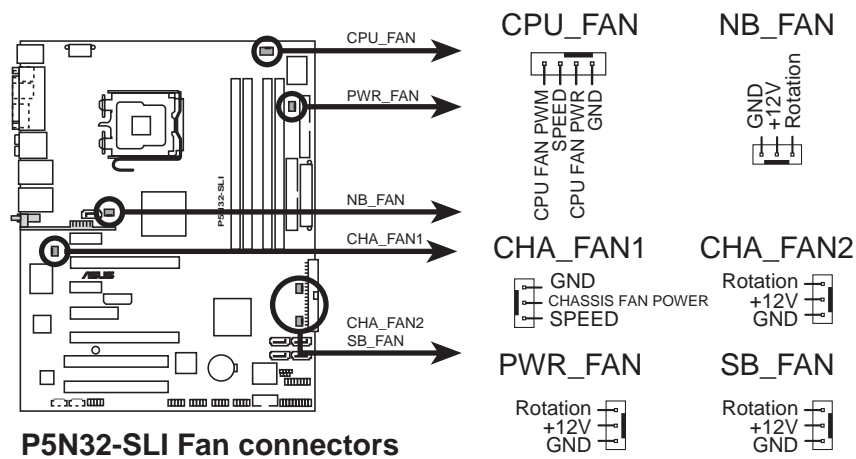

Only the CPU\_FAN and CHA\_FAN1 connectors support the ASUS Q-Fan 2 feature.



- Install an additional chassis fan when you are using two PCI Express graphics cards or a dual-core processor for better thermal environment.
- For some chassis models with short 3-pin chassis fan cable, connect the cable to the NB\_FAN connector.

## 12. Chassis intrusion connector (4-1 pin CHASSIS)

This connector is for a chassis-mounted intrusion detection sensor or switch. Connect one end of the chassis intrusion sensor or switch cable to this connector. The chassis intrusion sensor or switch sends a high-level signal to this connector when a chassis component is removed or replaced. The signal is then generated as a chassis intrusion event.

By default, the pins labeled “Chassis Signal” and “Ground” are shorted with a jumper cap. Remove the jumper caps only when you intend to use the chassis intrusion detection feature.

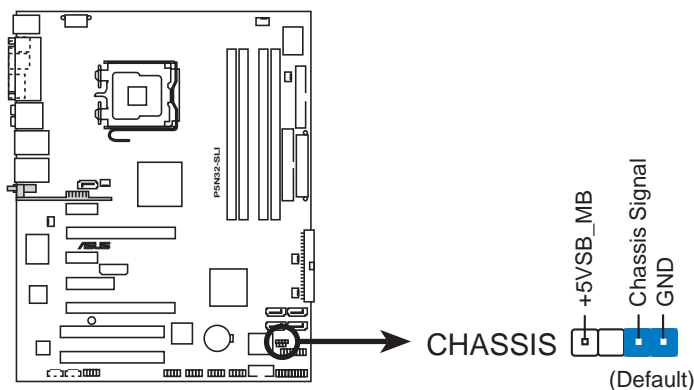

**P5N32-SLI Chassis intrusion connector**

## 13. ATX power connectors (24-pin EATXPWR, 8-pin EATX12V, 4-pin EZ\_PLUG)

These connectors are for ATX power supply plugs. The power supply plugs are designed to fit these connectors in only one orientation. Find the proper orientation and push down firmly until the connectors completely fit.

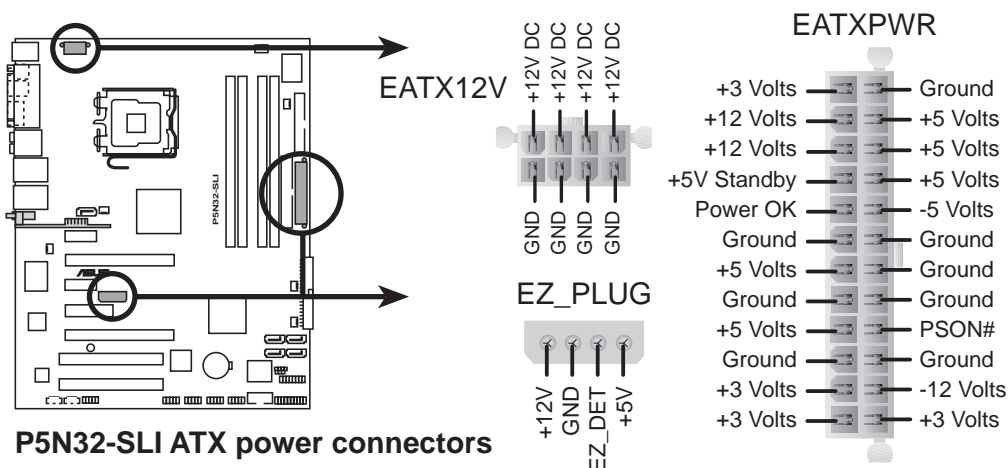

**P5N32-SLI ATX power connectors**



- For a fully configured system, we recommend that you use a power supply unit (PSU) that complies with ATX 12 V Specification 2.0 (or later version) and provides a minimum power of 500 W.
- Do not forget to connect the 8-pin ATX +12 V power plug; otherwise, the system will not boot.
- When using two graphics cards without auxiliary power plugs, do not forget to connect a 4-pin ATX power plug to the EZ Plug™; otherwise, the system will be unstable. See page 6-4 for details.
- To support an Intel® Dual-Core CPU Extreme Edition up to 3.2 GHz, make sure that the PSU can provide at least 16 A and 19 A peak on the +12V\_2 lead.
- Use of a PSU with a higher power output is recommended when configuring a system with more power-consuming devices. The system may become unstable or may not boot up if the power is inadequate. Refer to the **Power supply requirements** table below for details.

## Power supply requirements

Heavy Loading	
CPU	3.2G SMF-XE
DDR800	256M*4
VGA	7800*2
HD	SATA*4
CD-ROM	2
USB	6
PCI-E	1
PCI	2

	+12V-V2 (4-pin)	+12V-V1 (24-pin)	+5V	+3.3V	
Io_max (A)	13.22	16.61	16.14	4.17	TOTAL PSU Po_max (W)
Io_rms (A)	8.18	9.43	12.475	3.566	
Vout (V)	12	12	5	3.3	
Po_max (W)	158.64	199.32	80.7	13.761	

Normal Loading	
CPU	3.8G PSC-EM64T
DDR667	1G*2
VGA	6800Ultra*2
HD	SATA*2
CD-ROM	2
USB	4
PCI	1

	+12V-V2 (4-pin)	+12V-V1 (24-pin)	+5V	+3.3V	
Io_max (A)	10.1	17.56	14.48	3.56	TOTAL PSU Po_max (W)
Io_rms (A)	8.014	10.15	10.598	2.908	
Vout (V)	12	12	5	3.3	
Po_max (W)	121.2	210.72	72.4	11.748	



Light Loading	
CPU	3.8G PSC
DDR667	1G*2
VGA	6600GT*2
HD	SATA*2
CD-ROM	1
USB	2
PCI	1

	+12V-V2 (4-pin)	+12V-V1 (24-pin)	+5V	+3.3V	
Io_max (A)	10.29	11.22	11.76	2.73	TOTAL PSU Po_max (W)
Io_rms (A)	8.364	6.821	9.085	1.587	
Vout (V)	12	12	5	3.3	
Po_max (W)	123.48	134.64	58.8	9.009	

## 14. System panel connector (20-pin PANEL)

This connector supports several chassis-mounted functions.

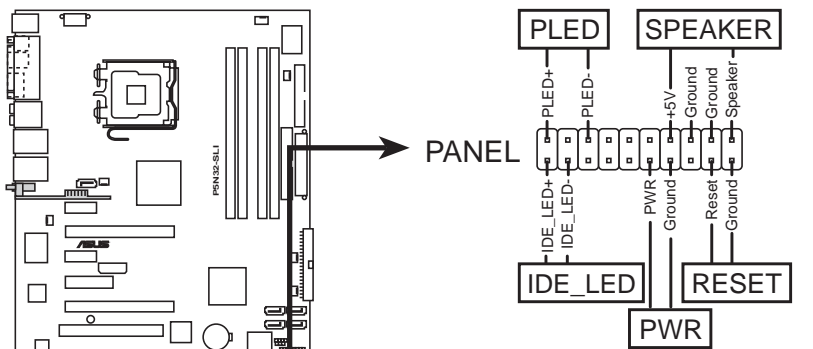

\* Requires an ATX power supply.

**P5N32-SLI System panel connector**



The system panel connector is color-coded for easy connection. Refer to the connector description below for details.

- System power LED (Green 3-pin PLED)**  
 This 3-pin connector is for the system power LED. Connect the chassis power LED cable to this connector. The system power LED lights up when you turn on the system power, and blinks when the system is in sleep mode.
- Hard disk drive activity LED (Red 2-pin IDE\_LED)**  
 This 2-pin connector is for the HDD Activity LED. Connect the HDD Activity LED cable to this connector. The IDE LED lights up or flashes when data is read from or written to the HDD.

- **System warning speaker (Orange 4-pin SPEAKER)**  
This 4-pin connector is for the chassis-mounted system warning speaker. The speaker allows you to hear system beeps and warnings.
- **ATX power button/soft-off button (Light Green 2-pin PWR)**  
This connector is for the system power button. Pressing the power button turns the system on or puts the system in sleep or soft-off mode depending on the BIOS settings. Pressing the power switch for more than four seconds while the system is ON turns the system OFF.
- **Reset button (Blue 2-pin RESET)**  
This 2-pin connector is for the chassis-mounted reset button for system reboot without turning off the system power.

This chapter describes the power up sequence, the vocal POST messages, and ways of shutting down the system.

# Powering up

## Chapter summary

# 3

3.1	Starting up for the first time .....	3-1
3.2	Powering off the computer .....	3-2

## 3.1 Starting up for the first time

1. After making all the connections, replace the system case cover.
2. Be sure that all switches are off.
3. Connect the power cord to the power connector at the back of the system chassis.
4. Connect the power cord to a power outlet that is equipped with a surge protector.
5. Turn on the devices in the following order:
  - a. Monitor
  - b. External SCSI devices (starting with the last device on the chain)
  - c. System power
6. After applying power, the system power LED on the system front panel case lights up. For systems with ATX power supplies, the system LED lights up when you press the ATX power button. If your monitor complies with “green” standards or if it has a “power standby” feature, the monitor LED may light up or switch between orange and green after the system LED turns on.

The system then runs the power-on self tests or POST. While the tests are running, the BIOS beeps or additional messages appear on the screen. If you do not see anything within 30 seconds from the time you turned on the power, the system may have failed a power-on test. Check the jumper settings and connections or call your retailer for assistance.

7. At power on, hold down the <Delete> key to enter the BIOS Setup. Follow the instructions in Chapter 4.

## 3.2 Powering off the computer

### 3.2.1 Using the OS shut down function

If you are using Windows® 2000:

1. Click the **Start** button then click **Shut Down...**
2. Make sure that the **Shut Down** option button is selected, then click the **OK** button to shut down the computer.
3. The power supply should turn off after Windows® shuts down.

If you are using Windows® XP:

1. Click the **Start** button then select **Turn Off Computer.**
2. Click the **Turn Off** button to shut down the computer.
3. The power supply should turn off after Windows® shuts down.

### 3.2.2 Using the dual function power switch

While the system is ON, pressing the power switch for less than four seconds puts the system to sleep mode or to soft-off mode, depending on the BIOS setting. Pressing the power switch for more than four seconds lets the system enter the soft-off mode regardless of the BIOS setting. Refer to section “4.5 Power Menu” in Chapter 4 for details.

This chapter tells how to change the system settings through the BIOS Setup menus. Detailed descriptions of the BIOS parameters are also provided.

# BIOS setup



4.1	Managing and updating your BIOS .....	4-1
4.2	BIOS setup program .....	4-11
4.3	Main menu .....	4-14
4.4	Advanced menu .....	4-20
4.5	Power menu .....	4-34
4.6	Boot menu .....	4-39
4.7	Exit menu .....	4-43



## 4.1 Managing and updating your BIOS

The following utilities allow you to manage and update the motherboard Basic Input/Output System (BIOS) setup.

1. **ASUS AFUDOS** (Updates the BIOS in DOS mode using a bootable floppy disk.)
2. **ASUS CrashFree BIOS 2** (Updates the BIOS using a bootable floppy disk or the motherboard support CD when the BIOS file fails or gets corrupted.)
3. **ASUS EZ Flash** (Updates the BIOS in DOS mode using a floppy disk or the motherboard support CD.)
4. **ASUS Update** (Updates the BIOS in Windows® environment.)

Refer to the corresponding sections for details on these utilities.



---

Save a copy of the original motherboard BIOS file to a bootable floppy disk in case you need to restore the BIOS in the future. Copy the original motherboard BIOS using the ASUS Update or AFUDOS utilities.

---

### 4.1.1 Creating a bootable floppy disk

1. Do either one of the following to create a bootable floppy disk.

#### *DOS environment*

- a. Insert a 1.44MB floppy disk into the drive.
- b. At the DOS prompt, type **format A:/S** then press <Enter>.

#### *Windows® XP environment*

- a. Insert a 1.44 MB floppy disk to the floppy disk drive.
- b. Click **Start** from the Windows® desktop, then select **My Computer**.
- c. Select the 3 1/2 Floppy Drive icon.
- d. Click **File** from the menu, then select **Format**. A **Format 3 1/2 Floppy Disk** window appears.
- e. **Windows® XP users:** Select **Create an MS-DOS startup disk** from the format options field, then click **Start**.

### *Windows® 2000 environment*

To create a set of boot disks for Windows® 2000:

- a. Insert a formatted, high density 1.44 MB floppy disk into the drive.
  - b. Insert the Windows® 2000 CD to the optical drive.
  - c. Click **Start**, then select **Run**.
  - d. In the **Open** field, type `D:\bootdisk\makeboot a:` assuming that D is your optical drive letter.
  - e. Press <Enter>, then follow screen instructions to continue.
2. Copy the original or the latest motherboard BIOS file to the bootable floppy disk.

## 4.1.2 AFUDOS utility

The AFUDOS utility allows you to update the BIOS file in DOS environment using a bootable floppy disk with the updated BIOS file. This utility also allows you to copy the current BIOS file that you can use as backup when the BIOS fails or gets corrupted during the updating process.

### Copying the current BIOS

To copy the current BIOS file using the AFUDOS utility:



- 
- Make sure that the floppy disk is not write-protected and has at least 1.2 MB free space to save the file.
  - The succeeding BIOS screens are for reference only. The actual BIOS screen displays may not be same as shown.
- 

1. Copy the AFUDOS utility (afudos.exe) from the motherboard support CD to the bootable floppy disk you created earlier.
2. Boot the system in DOS mode, then at the prompt type:

```
afudos /o[filename]
```

where the [filename] is any user-assigned filename not more than eight alphanumeric characters for the main filename and three alphanumeric characters for the extension name.

```
A:\>afudos /oOLDBIOS1.rom
```

Main filename      Extension name

3. Press <Enter>. The utility copies the current BIOS file to the floppy disk.

```
A:\>afudos /oOLDBIOS1.rom
AMI Firmware Update Utility - Version 1.19(ASUS V2.07(03.11.24BB))
Copyright (C) 2002 American Megatrends, Inc. All rights reserved.
  Reading flash ..... done
  Write to file..... ok
A:\>
```

The utility returns to the DOS prompt after copying the current BIOS file.

## Updating the BIOS file

To update the BIOS file using the AFUDOS utility:

1. Visit the ASUS website ([www.asus.com](http://www.asus.com)) and download the latest BIOS file for the motherboard. Save the BIOS file to a bootable floppy disk.



---

Write the BIOS filename on a piece of paper. You need to type the exact BIOS filename at the DOS prompt.

---

2. Copy the AFUDOS utility (afudos.exe) from the motherboard support CD to the bootable floppy disk you created earlier.
3. Boot the system in DOS mode, then at the prompt type:

```
afudos /i[filename]
```

where [filename] is the latest or the original BIOS file on the bootable floppy disk.

```
A:\>afudos /iP5N32SD.rom
```

4. The utility verifies the file and starts updating the BIOS.

```
A:\>afudos /iP5N32SD.rom
AMI Firmware Update Utility - Version 1.19(ASUS V2.07(03.11.24BB))
Copyright (C) 2002 American Megatrends, Inc. All rights reserved.

WARNING!! Do not turn off power during flash BIOS
Reading file ..... done
Reading flash ..... done

Advance Check .....
Erasing flash ..... done
Writing flash ..... 0x0008CC00 (9%)
```



---

Do not shut down or reset the system while updating the BIOS to prevent system boot failure!

---

5. The utility returns to the DOS prompt after the BIOS update process is completed. Reboot the system from the hard disk drive.

```
A:\>afudos /iP5N32SD.rom
AMI Firmware Update Utility - Version 1.19(ASUS V2.07(03.11.24BB))
Copyright (C) 2002 American Megatrends, Inc. All rights reserved.

WARNING!! Do not turn off power during flash BIOS
Reading file ..... done
Reading flash ..... done

Advance Check .....
Erasing flash ..... done
Writing flash ..... done
Verifying flash .... done

Please restart your computer

A:\>
```

### 4.1.3 ASUS CrashFree BIOS 2 utility

The ASUS CrashFree BIOS 2 is an auto recovery tool that allows you to restore the BIOS file when it fails or gets corrupted during the updating process. You can update a corrupted BIOS file using the motherboard support CD or the floppy disk that contains the updated BIOS file.



- Prepare the motherboard support CD or the floppy disk containing the updated motherboard BIOS before using this utility.
- Make sure that you rename the original or updated BIOS file in the floppy disk to **P5N32SD.ROM**.

### Recovering the BIOS from a floppy disk

To recover the BIOS from a floppy disk:

1. Turn on the system.
2. Insert the floppy disk with the original or updated BIOS file to the floppy disk drive.
3. The utility displays the following message and automatically checks the floppy disk for the original or updated BIOS file.

```
Bad BIOS checksum. Starting BIOS recovery...
Checking for floppy...
```

When found, the utility reads the BIOS file and starts flashing the corrupted BIOS file.

```
Bad BIOS checksum. Starting BIOS recovery...
Checking for floppy...
Floppy found!
Reading file "P5N32SD.ROM". Completed.
Start flashing...
```



DO NOT shut down or reset the system while updating the BIOS! Doing so can cause system boot failure!

4. Restart the system after the utility completes the updating process.

## Recovering the BIOS from the support CD

To recover the BIOS from the support CD:

1. Remove any floppy disk from the floppy disk drive, then turn on the system.
2. Insert the support CD to the optical drive.
3. The utility displays the following message and automatically checks the floppy disk for the original or updated BIOS file.

```
Bad BIOS checksum. Starting BIOS recovery...
Checking for floppy...
```

When no floppy disk is found, the utility automatically checks the optical drive for the original or updated BIOS file. The utility then updates the corrupted BIOS file.

```
Bad BIOS checksum. Starting BIOS recovery...
Checking for floppy...
Floppy not found!
Checking for CD-ROM...
CD-ROM found!
Reading file "P5N32SD.ROM". Completed.
Start flashing...
```



---

DO NOT shut down or reset the system while updating the BIOS! Doing so can cause system boot failure!

---

4. Restart the system after the utility completes the updating process.



---

The recovered BIOS may not be the latest BIOS version for this motherboard. Visit the ASUS website ([www.asus.com](http://www.asus.com)) to download the latest BIOS file.

---

## 4.1.4 ASUS EZ Flash utility

The ASUS EZ Flash feature allows you to update the BIOS without having to go through the long process of booting from a floppy disk and using a DOS-based utility. The EZ Flash utility is built-in the BIOS chip so it is accessible by pressing <Alt> + <F2> during the Power-On Self Tests (POST).

To update the BIOS using EZ Flash:

1. Visit the ASUS website ([www.asus.com](http://www.asus.com)) to download the latest BIOS file for the motherboard and rename the same to **P5N32SD.ROM**.
2. Save the BIOS file to a floppy disk, then restart the system.
3. Press <Alt> + <F2> during POST to display the following.

```
EZFlash starting BIOS update
Checking for floppy...
```

4. Insert the floppy disk that contains the BIOS file to the floppy disk drive. When the correct BIOS file is found, EZ Flash performs the BIOS update process and automatically reboots the system when done.

```
EZFlash starting BIOS update
Checking for floppy...
Floppy found!
Reading file "P5N32SD.rom". Completed.
Start erasing.....|
Start programming...|
Flashed successfully. Rebooting.
```



- Do not shutdown or reset the system while updating the BIOS to prevent system boot failure!
- A “Floppy not found!” error message appears if there is no floppy disk in the drive. A “P5N32SD.ROM not found!” error message appears if the correct BIOS file is not found in the floppy disk. Make sure that you rename the BIOS file to P5N32SD.ROM.

## 4.1.5 ASUS Update utility

The ASUS Update is a utility that allows you to manage, save, and update the motherboard BIOS in Windows® environment. The ASUS Update utility allows you to:

- Save the current BIOS file
- Download the latest BIOS file from the Internet
- Update the BIOS from an updated BIOS file
- Update the BIOS directly from the Internet, and
- View the BIOS version information.

This utility is available in the support CD that comes with the motherboard package.



---

ASUS Update requires an Internet connection either through a network or an Internet Service Provider (ISP).

---

## Installing ASUS Update

To install ASUS Update:

1. Place the support CD in the optical drive. The **Drivers** menu appears.
2. Click the **Utilities** tab, then click **ASUS Update**. See page 5-3 for the **Utilities** screen menu.
3. The ASUS Update utility is copied to your system.



---

Quit all Windows® applications before you update the BIOS using this utility.

---



## Updating the BIOS through the Internet

To update the BIOS through the Internet:

1. Launch the ASUS Update utility from the Windows® desktop by clicking **Start > Programs > ASUS > ASUSUpdate > ASUSUpdate**. The ASUS Update main window appears.

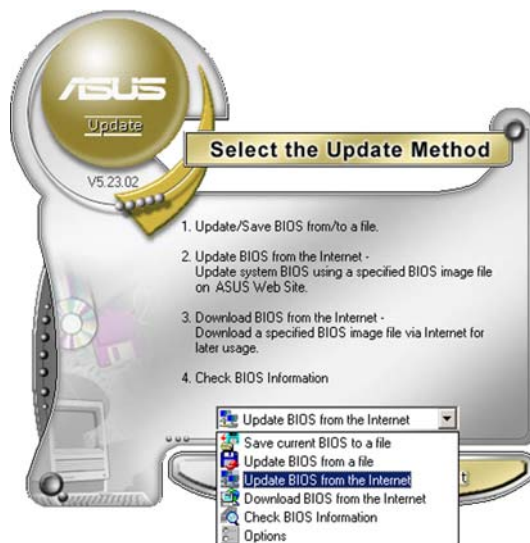
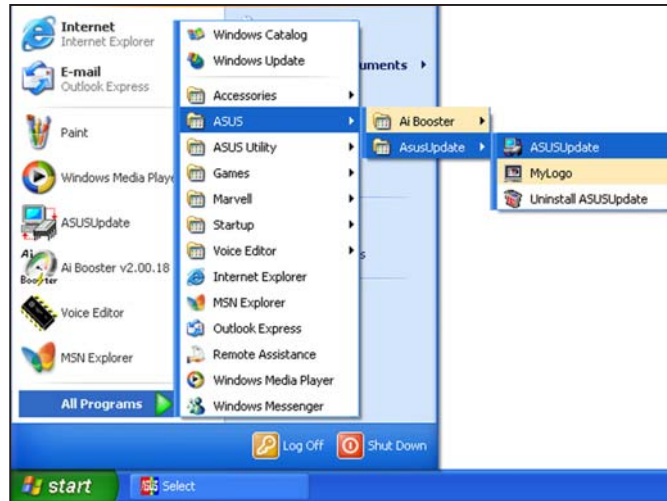

2. Select **Update BIOS from the Internet** option from the drop-down menu, then click **Next**.



3. Select the ASUS FTP site nearest you to avoid network traffic, or click **Auto Select**. Click **Next**.

- From the FTP site, select the BIOS version that you wish to download. Click Next.
- Follow the screen instructions to complete the update process.



The ASUS Update utility is capable of updating itself through the Internet. Always update the utility to avail all its features.



## Updating the BIOS through a BIOS file

To update the BIOS through a BIOS file:

- Launch the ASUS Update utility from the Windows® desktop by clicking **Start > Programs > ASUS > ASUSUpdate > ASUSUpdate**. The ASUS Update main window appears.
- Select **Update BIOS from a file** option from the drop-down menu, then click **Next**.

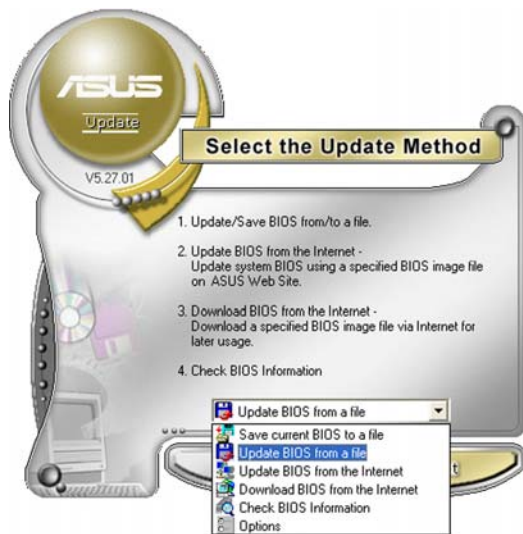

- Locate the BIOS file from the **Open** window, then click **Save**.
- Follow the screen instructions to complete the update process.

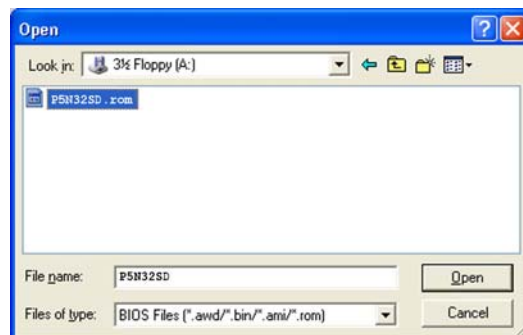

## 4.2 BIOS setup program

This motherboard supports a programmable firmware chip that you can update using the provided utility described in section “4.1 Managing and updating your BIOS.”

Use the BIOS Setup program when you are installing a motherboard, reconfiguring your system, or prompted to “Run Setup.” This section explains how to configure your system using this utility.

Even if you are not prompted to use the Setup program, you can change the configuration of your computer in the future. For example, you can enable the security password feature or change the power management settings. This requires you to reconfigure your system using the BIOS Setup program so that the computer can recognize these changes and record them in the CMOS RAM or the firmware hub.

The firmware hub on the motherboard stores the Setup utility. When you start up the computer, the system provides you with the opportunity to run this program. Press <Del> during the Power-On-Self-Test (POST) to enter the Setup utility; otherwise, POST continues with its test routines.

If you wish to enter Setup after POST, restart the system by pressing <Ctrl+Alt+Delete>, or by pressing the reset button on the system chassis. You can also restart by turning the system off and then back on. Do this last option only if the first two failed.

The Setup program is designed to make it as easy to use as possible. Being a menu-driven program, it lets you scroll through the various sub-menus and make your selections from the available options using the navigation keys.



- 
- The default BIOS settings for this motherboard apply for most conditions to ensure optimum performance. If the system becomes unstable after changing any BIOS settings, load the default settings to ensure system compatibility and stability. Select the **Load Default Settings** item under the Exit Menu. See section “4.7 Exit Menu.”
  - The BIOS setup screens shown in this section are for reference purposes only, and may not exactly match what you see on your screen.
  - Visit the ASUS website ([www.asus.com](http://www.asus.com)) to download the latest BIOS file for this motherboard.
-

## 4.2.1 BIOS menu screen

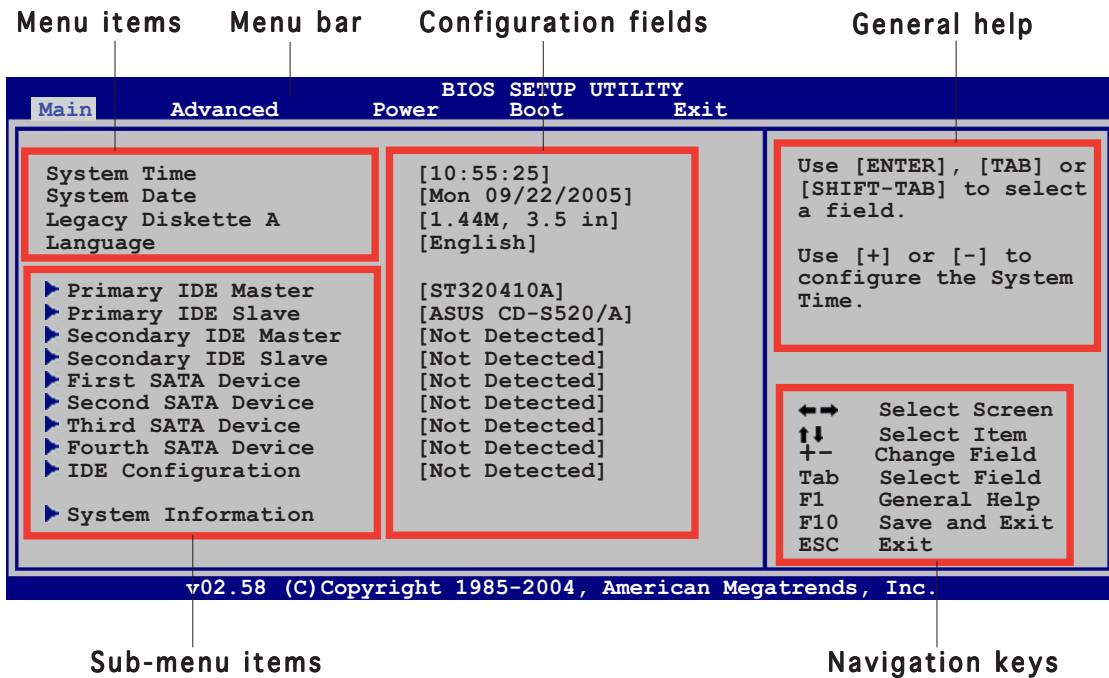

## 4.2.2 Menu bar

The menu bar on top of the screen has the following main items:

- Main** For changing the basic system configuration
- Advanced** For changing the advanced system settings
- Power** For changing the advanced power management (APM) configuration
- Boot** For changing the system boot configuration
- Exit** For selecting the exit options and loading default settings

To select an item on the menu bar, press the right or left arrow key on the keyboard until the desired item is highlighted.

## 4.2.3 Navigation keys

At the bottom right corner of a menu screen are the navigation keys for that particular menu. Use the navigation keys to select items in the menu and change the settings.



Some of the navigation keys differ from one screen to another.

## 4.2.4 Menu items

The highlighted item on the menu bar displays the specific items for that menu. For example, selecting **Main** shows the Main menu items.

The other items (Advanced, Power, Boot, and Exit) on the menu bar have their respective menu items.

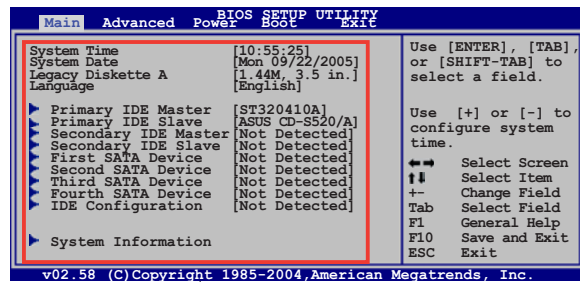

Main menu items

## 4.2.5 Sub-menu items

A solid triangle before each item on any menu screen means that the item has a sub-menu. To display the sub-menu, select the item and press <Enter>.

## 4.2.6 Configuration fields

These fields show the values for the menu items. If an item is user-configurable, you can change the value of the field opposite the item. You cannot select an item that is not user-configurable.

A configurable field is enclosed in brackets, and is highlighted when selected. To change the value of a field, select it then press <Enter> to display a list of options. Refer to “4.2.7 Pop-up window.”

## 4.2.7 Pop-up window

Select a menu item then press <Enter> to display a pop-up window with the configuration options for that item.

## 4.2.8 Scroll bar

A scroll bar appears on the right side of a menu screen when there are items that do not fit on the screen. Press the Up/Down arrow keys or <Page Up> /<Page Down> keys to display the other items on the screen.

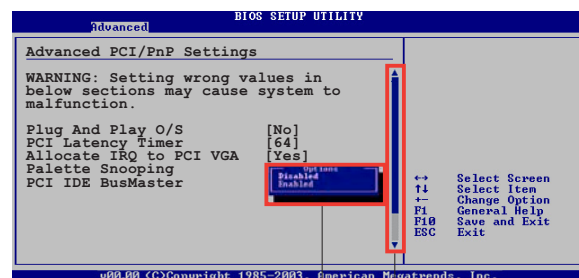

Pop-up window

Scroll bar

## 4.2.9 General help

At the top right corner of the menu screen is a brief description of the selected item.

## 4.3 Main menu

When you enter the BIOS Setup program, the **Main** menu screen appears, giving you an overview of the basic system information.



Refer to section “4.2.1 BIOS menu screen” for information on the menu screen items and how to navigate through them.

```
BIOS SETUP UTILITY
Main  Advanced  Power  Boot  Exit

System Time          [10:55:25]
System Date          [Mon 09/22/2005]
Legacy Diskette A    [1.44M, 3.5 in]
Language              [English]

▶ Primary IDE Master  [ST320410A]
▶ Primary IDE Slave   [ASUS CD-S520/A]
▶ Secondary IDE Master [Not Detected]
▶ Secondary IDE Slave [Not Detected]
▶ First SATA Device   [Not Detected]
▶ Second SATA Device  [Not Detected]
▶ Third SATA Device   [Not Detected]
▶ Fourth SATA Device  [Not Detected]
▶ IDE Configuration  [Not Detected]

▶ System Information

Use [ENTER], [TAB] or [SHIFT-TAB] to select a field.
Use [+] or [-] to configure the System Time.

←→ Select Screen
↑↓ Select Item
+- Change Field
Tab Select Field
F1  General Help
F10 Save and Exit
ESC Exit

v02.58 (C) Copyright 1985-2004, American Megatrends, Inc.
```

### 4.3.1 System Time [xx:xx:xx]

Allows you to set the system time.

### 4.3.2 System Date [Day xx/xx/xxxx]

Allows you to set the system date.

### 4.3.3 Legacy Diskette A [1.44M, 3.5 in.]

Sets the type of floppy drive installed. Configuration options: [Disabled] [360K, 5.25 in.] [1.2M, 5.25 in.] [720K, 3.5 in.] [1.44M, 3.5 in.] [2.88M, 3.5 in.]

### 4.3.4 Language [English]

Allows you to choose the BIOS language version from the options. Configuration options: [Chinese BIG5] [Chinese (GB)] [Japanese] [Français] [German] [English]

### 4.3.5 Primary and Secondary IDE Master/Slave

The BIOS automatically detects the connected IDE devices. There is a separate sub-menu for each IDE device. Select a device item, then press <Enter> to display the IDE device information.

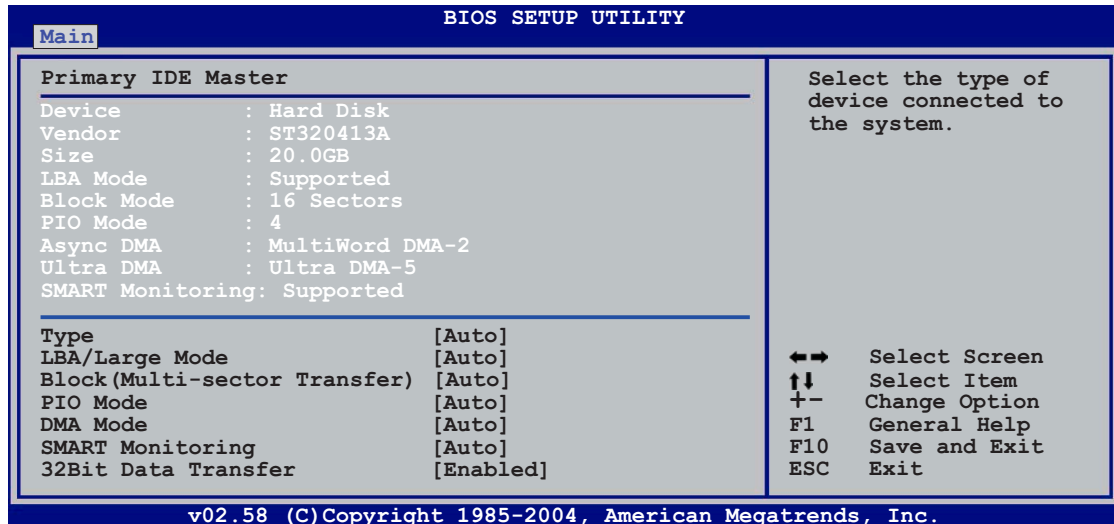

The BIOS automatically detects the values opposite the dimmed items (Device, Vendor, Size, LBA Mode, Block Mode, PIO Mode, Async DMA, Ultra DMA, and SMART monitoring). These values are not user-configurable. These items show N/A if no IDE device is installed in the system.

#### Type [Auto]

Selects the type of IDE drive. Setting to [Auto] allows automatic selection of the appropriate IDE device type. Select [CDROM] if you are specifically configuring a CD-ROM drive. Select [ARMD] (ATAPI Removable Media Device) if your device is either a ZIP, LS-120, or MO drive. Configuration options: [Not Installed] [Auto] [CDROM] [ARMD]

#### LBA/Large Mode [Auto]

Enables or disables the LBA mode. Setting to [Auto] enables the LBA mode if the device supports this mode, and if the device was not previously formatted with LBA mode disabled. Configuration options: [Disabled] [Auto]

#### Block (Multi-sector Transfer) [Auto]

Enables or disables data multi-sectors transfers. When set to [Auto], the data transfer from and to the device occurs multiple sectors at a time if the device supports multi-sector transfer feature. When set to [Disabled], the data transfer from and to the device occurs one sector at a time. Configuration options: [Disabled] [Auto]

### PIO Mode [Auto]

Selects the PIO mode.

Configuration options: [Auto] [0] [1] [2] [3] [4]

### DMA Mode [Auto]

Selects the DMA mode. Configuration options: [Auto] [SWDMA0] [SWDMA1] [SWDMA2] [MWDMA0] [MWDMA1] [MWDMA2] [UDMA0] [UDMA1] [UDMA2] [UDMA3] [UDMA4] [UDMA5]

### SMART Monitoring [Auto]

Sets the Smart Monitoring, Analysis, and Reporting Technology.

Configuration options: [Auto] [Disabled] [Enabled]

### 32Bit Data Transfer [Enabled]

Enables or disables 32-bit data transfer.

Configuration options: [Disabled] [Enabled]

## 4.3.6 First, Second, Third, and Fourth SATA Device

The BIOS automatically detects the connected Serial ATA devices. There is a separate sub-menu for each device. Select a device item, then press <Enter> to display the SATA device information.

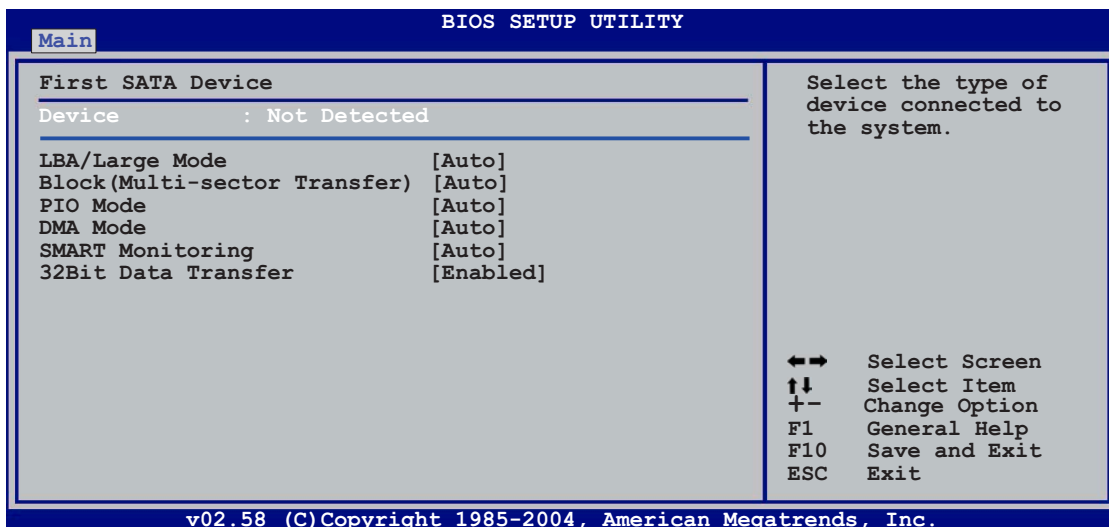

### LBA/Large Mode [Auto]

Enables or disables the LBA mode. Setting to [Auto] enables the LBA mode if the device supports this mode, and if the device was not previously formatted with LBA mode disabled. Configuration options: [Disabled] [Auto]



### **Block (Multi-sector Transfer) [Auto]**

Enables or disables data multi-sectors transfers. When set to [Auto], the data transfer from and to the device occurs multiple sectors at a time if the device supports multi-sector transfer feature. When set to [Disabled], the data transfer from and to the device occurs one sector at a time.  
Configuration options: [Disabled] [Auto]

### **PIO Mode [Auto]**

Selects the PIO mode.  
Configuration options: [Auto] [0] [1] [2] [3] [4]

### **DMA Mode [Auto]**

Selects the DMA mode. Configuration options: [Auto] [SWDMA0] [SWDMA1] [SWDMA2] [MWDMA0] [MWDMA1] [MWDMA2] [UDMA0] [UDMA1] [UDMA2] [UDMA3] [UDMA4] [UDMA5]

### **SMART Monitoring [Auto]**

Sets the Smart Monitoring, Analysis, and Reporting Technology.  
Configuration options: [Auto] [Disabled] [Enabled]

### **32Bit Data Transfer [Enabled]**

Enables or disables 32-bit data transfer.  
Configuration options: [Disabled] [Enabled]

## 4.3.7 IDE Configuration

The items in this menu allow you to set or change the configurations for the IDE devices installed in the system. Select an item then press <Enter> if you want to configure the item.

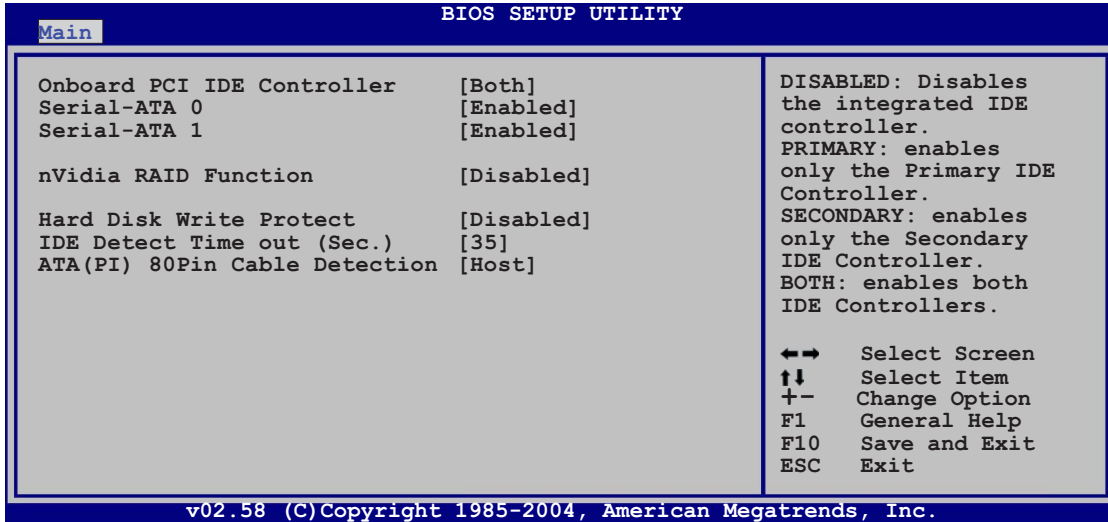

### Onboard PCI IDE Controller [Both]

Allows you to disable the integrated IDE controller, or choose which IDE controller/s to enable. Configuration options: [Disabled] [Primary] [Secondary] [Both]

### Serial-ATA 0 [Enabled]

### Serial-ATA 1 [Enabled]

Allows you to enable or disable the Serial ATA ports.  
Configuration options: [Enabled] [Disabled]

### nVidia RAID Function [Disabled]

Allows you to enable or disable the NVIDIA RAID function.  
Configuration options: [Disabled] [Enabled]

### Hard Disk Write Protect [Disabled]

Allows you to enable or disable the hard disk write protect feature. You can use this feature only if you access the device through the BIOS.  
Configuration options: [Disabled] [Enabled]

### IDE Detect Time out (Sec.) [35]

Selects the time out value for detecting ATA/ATAPI devices.  
Configuration options: [0] [5] [10] [15] [20] [25] [30] [35]

## ATA(PI) 80Pin Cable Detection [Host]

Allows you to select the mechanism to be used for detecting the 80-pin ATA(PI) cable. Configuration options: [Host & Device] [Host] [Device]

### 4.3.8 System Information

This menu gives you an overview of the general system specifications. The BIOS automatically detects the items in this menu.

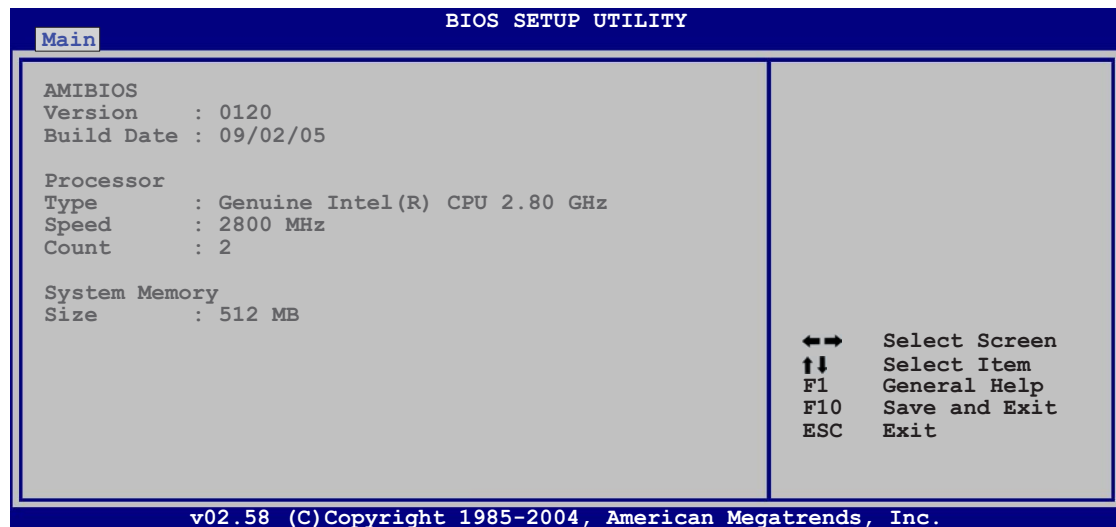

#### AMI BIOS

Displays the auto-detected BIOS information.

#### Processor

Displays the auto-detected CPU specification.

#### System Memory

Displays the auto-detected system memory.

## 4.4 Advanced menu

The Advanced menu items allow you to change the settings for the CPU and other system devices.



Take caution when changing the settings of the Advanced menu items. Incorrect field values can cause the system to malfunction.

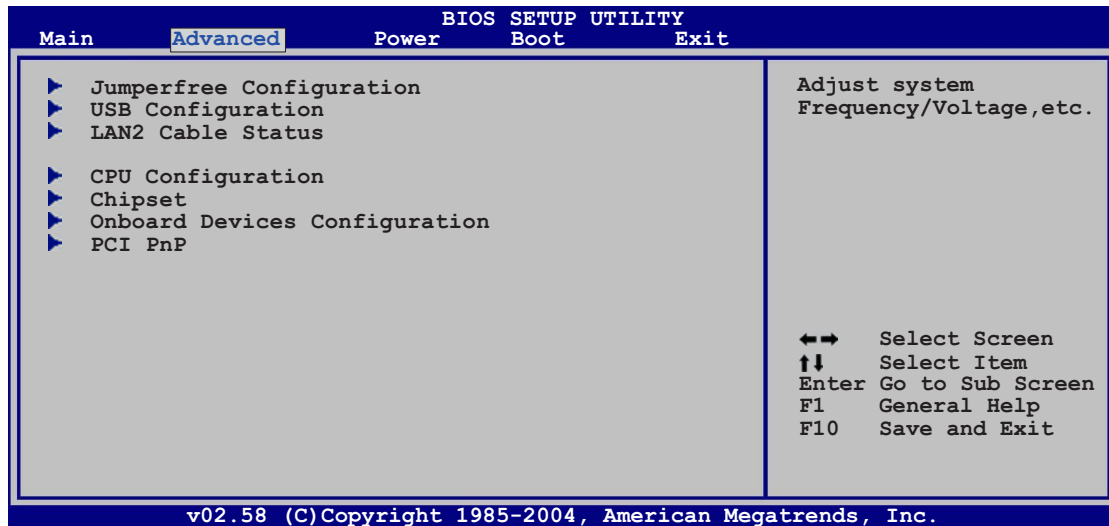

### 4.4.1 JumperFree Configuration

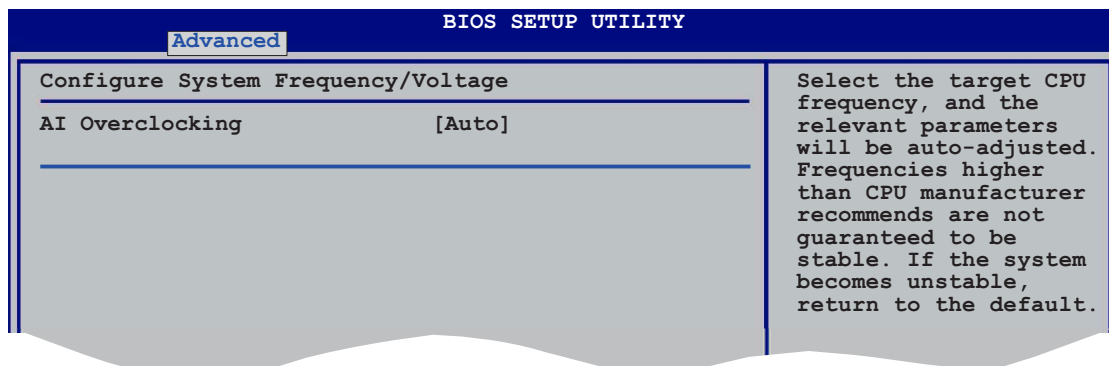

#### AI Overclocking [Auto]

Allows you to select the overclocking options to achieve the desired CPU internal frequency. Select either one of the preset overclocking configuration options.

**Manual** - allows you to individually set overclocking parameters.

**Auto** - loads the optimal settings for the system.

**Overclock Profile** - loads overclocking profiles with optimal parameters for stability when overclocking.

**AI N.O.S.** - The ASUS AI Non-delay Overclocking System feature intelligently determines the system load and automatically boosts the performance for the most demanding tasks.



The following item appears only when you install a CPU that supports the lock free feature. Only some latest CPUs support this feature

## CPU Lock Free [Auto]

This feature allows you to adjust the CPU multiplier to 14x. Setting this item to [Auto] allows the motherboard to automatically reduce the CPU multiplier value for more flexibility when increasing external FSB.

Configuration options: [Auto] [Disabled] [Enabled]



The following item appears only when you set the **AI Overclocking** item to [Manual].

BIOS SETUP UTILITY		
Advanced		
Configure System Frequency/Voltage		
AI Overclocking [Manual]	Select the target CPU frequency, and the relevant parameters will also be auto-adjusted. Frequencies higher than the CPU manufacturer recommends are not guaranteed to stable. If the system becomes unstable, return to the default.  ←→ Select Screen ↑↓ Select Item +- Change Option F1 General Help F10 Save and Exit ESC Exit	
▶ Performance Options		
▶ Spread Spectrum Control		
CPU VCore Voltage [Auto]		
FSB Termination Voltage [Auto]		
Memory Voltage [Auto]		
NB Chipset Voltage [Auto]		
SB Chipset Voltage [Auto]		
v02.58 (C)Copyright 1985-2004, American Megatrends, Inc.		

## Performance Options

BIOS SETUP UTILITY	
Advanced	
Performance Options	
FSB Optimize Mode [Disabled]	<b>Options</b>  Disabled Enabled  ←→ Select Screen ↑↓ Select Item +- Change Option F1 General Help F10 Save and Exit ESC Exit
Memory Optimize Mode [Disabled]	
System Clock Mode [Auto]	
PCIe Frequency (MHz) [100.0000]	
Memory Timings [Auto]	
v02.58 (C)Copyright 1985-2004, American Megatrends, Inc.	

### *FSB Optimize Mode [Disabled]*

Allows you to enable or disable the FSB Optimize mode.  
Configuration options: [Disabled] [Enabled]

### *Memory Optimize Mode [Disabled]*

When disabled, the fast read budget is set to to 3.5 ns. When enabled, the fast read budget is set to 3.5 ns if the memory speed is less than 400 MHz. If the memory speed is more than 400 MHz, the fast read budget is equivalent to twice the value of the memory speed period.

### *System Clock Mode [Auto]*

Sets the system clock mode. The default setting [Auto], automatically sets the FSB and memory speeds. Set to [Linked] to overclock the memory and FSB proportionally. Set to [Manual] to manually set the FSB and memory clock. Configuration options: [Auto] [Linked] [Manual]



---

The following item appears if the **System Clock Mode** is set to [Linked]

---

### **FSB Clock (Mhz) [XXX]**

Allows you to set the FSB frequency, depending on the frequency of the CPU installed. Enter the value using the numeric keypad, or use the <+>/ <-> key to adjust the value up to 1600. Any value that is not within this range will not take effect.



---

Setting a very high value may cause the system to become unstable. Revert to the [Auto] setting if this happens.

---



---

The following item also appears if the **System Clock Mode** is set to [Manual]

---

### **Memory Clock (Mhz) [XXX]**

Allows you to set the memory frequency, depending on the CPU installed. Enter the value using the numeric keypad, or use the <+>/ <-> key to adjust the value from 400 to 1600. Any value that is not within this range will not take effect.



---

Setting a very high value may cause the system to become unstable. Revert to the [Auto] setting if this happens.

---

### *PCI Express Frequency (MHz) [100.0000]*

Allows you to set the PCI Express frequency. Configuration options:

[100.0000] [101.5625] [103.1250] [104.6875] [106.2500]  
[107.8125] [110.9375] [112.5000] [114.0625] [115.6250]  
[107.1875] [118.7500] [120.3125] [121.8750] [123.4375]  
[125.0000] [126.5625] [128.1250] [129.6875] [131.2500]  
[132.8125] [134.3750] [135.9375] [137.5000] [139.0625]  
[140.6250] [142.1875] [143.7500] [145.3125] [146.8750]  
[148.4375]

### *Memory Timings [Auto]*

[Auto] allows the BIOS to set the memory timing automatically.  
[Manual] allows you to input the values manually. Configuration options: [Auto] [Manual]



---

The following items appear if you set the **Memory Timings** item to [Manual].

---

#### **CAS Latency (CL) [Auto]**

Configuration options: [Auto] [1] [2]... [6]

#### **tRCD [Auto]**

Configuration options: [Auto] [1] [2]... [7]

#### **tRP [Auto]**

Configuration options: [Auto] [1] [2]... [7]

#### **tRAS [4 CLK]**

Configuration options: [Auto] [1] [2]... [31]

#### **tRC [Auto]**

Configuration options: [Auto] [1] [2]... [31]

#### **Address Mode [Auto]**

Configuration options: [Auto] [1T] [2T]

## Spread Spectrum Control

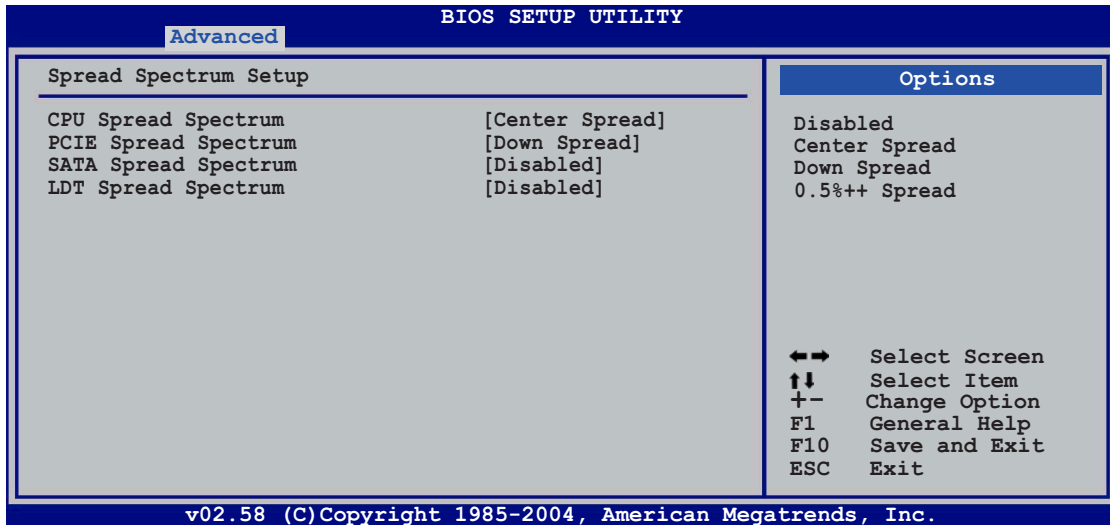

### CPU Spread Spectrum [Center Spread]

Configuration options: [Disabled] [Center Spread] [Down Spread] [0.5%++ Spread]

### PCIE Spread Spectrum [Down Spread]

Configuration options: [Disabled] [Down Spread]

### SATA Spread Spectrum [Disabled]

Configuration options: [Disabled] [Down Spread]

### LDT Spread Spectrum [Disabled]

Configuration options: [Disabled] [Center Spread]

---

## CPU VCore Voltage [Auto]

Allows the BIOS to automatically enable, or allows you to set the CPU VCore Voltage. Configuration options: [Auto] [1.7000V] [1.6875V] [1.6750V] [1.6625V]... [1.1000V]



Refer to the CPU documentation before setting the CPU Vcore voltage. Setting a high Vcore voltage may damage the CPU. Setting a very low Vcore voltage may cause the system to become unstable.

## FSB Termination Voltage [Auto]

Allows you to select the front side bus termination voltage. Set to [Auto] for safe mode. Configuration options: [Auto] [1.215V] [1.315V] [1.415V]





---

Setting a high FSB termination voltage may damage the chipset and CPU.

---

## Memory Voltage [Auto]

Allows you to select the memory voltage. Set to [Auto] for safe mode. Configuration options: [Auto] [1.80V] [1.90V] [2.00V] [2.10V] [2.20V] [2.30V] [2.40V]



---

Refer to the DDR2 documentation before adjusting the memory voltage. Setting a very high memory voltage may damage the memory module(s). Setting a very low memory voltage may cause the system to become unstable.

---

## NB Chipset Voltage [Auto]

Allows you to select the Northbridge chipset voltage. Set to [Auto] for safe mode. Configuration options: [Auto] [1.40V] [1.50V] [1.60V]

## SB Chipset Voltage [Auto]

Allows you to select the Southbridge chipset voltage. Set to [Auto] for safe mode. Configuration options: [Auto] [1.50V] [1.60V]



---

The following item appears only when the **AI Overclocking** item is set to [Overclock Profile].

---

## Overclock Options [Overclock 5%]

Allows you to overclock the CPU speed through the available preset values. Configuration options: [Overclock 5%] [Overclock 10%] [Overclock 15%] [Overclock 20%] [FSB 890M/DDR2 890M] [FSB 940M/DDR2 860M] [FSB 980M/DDR2 800M] [FSB 1050M/DDR2 667M] [FSB 1120M/DDR2 880M] [FSB 1160M/DDR2 838M] [FSB 1200M/DDR2 800M] [FSB 1280M/DDR2 667M]



---

The following item appears only when the **AI Overclocking** item is set to [AI N.O.S.].

---

## N.O.S. Mode [Auto]

Sets the Non-delay Overclocking System mode. Configuration options: [Auto] [Manual]



---

The following items appear only when the **N.O.S. Mode** item is set to [Manual].

---

## Sensitivity [Sensitive]

Allows you to set the sensitivity of the AI N.O.S. sensor. Setting to [Sensitive] will trigger AI N.O.S. with less CPU loading. Configuration options: [Normal] [Sensitive] [Less-Sensitive]

## Target Frequency [Overclock 3%]

This option allows you to set the maximum overclocking percentage when AI N.O.S. is activated. Configuration options: [Overclock 3%] [Overclock 5%] [Overclock 8%] [Overclock 10%]



Setting a very high target frequency may cause the system to become unstable. If this happens, revert to the default setting.

## 4.4.2 USB Configuration

The items in this menu allows you to change the USB-related features. Select an item then press <Enter> to display the configuration options.

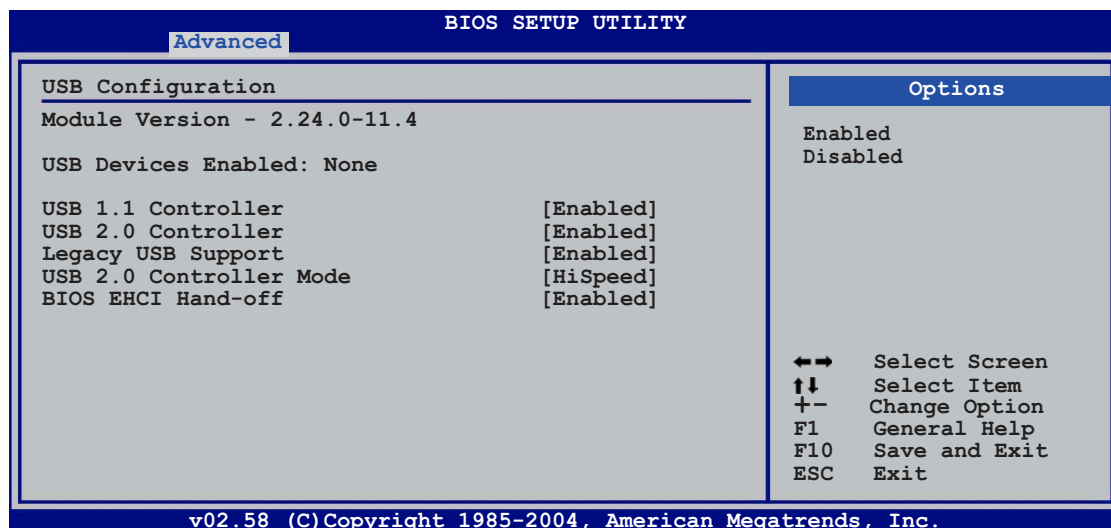

The **Module Version** and **USB Devices Enabled** items show the auto-detected values. If no USB device is detected, the item shows **None**.

### USB 1.0 Controller [Enabled]

Allows you to enable or disable the USB 1.1 controller. Configuration options: [Enabled] [Disabled]

### USB 2.0 Controller [Enabled]

Allows you to enable or disable the USB 2.0 controller. Configuration options: [Enabled] [Disabled]

## Legacy USB Support [Auto]

Allows you to enable or disable support for legacy USB devices. Setting to [Auto] allows the system to detect the presence of USB devices at startup. If detected, the USB controller legacy mode is enabled. If no USB device is detected, the legacy USB support is disabled.

Configuration options: [Disabled] [Enabled] [Auto]

## USB 2.0 Controller Mode [HiSpeed]

Allows you to set the USB 2.0 controller mode to HiSpeed (480 Mbps) or FullSpeed (12 Mbps). Configuration options: [HiSpeed] [FullSpeed]

## BIOS EHCI Hand-off [Enabled]

Allows you to enable support for operating systems without an EHCI hand-off feature. Configuration options: [Disabled] [Enabled]

## 4.4.3 LAN2 Cable Status

This menu displays the status of the Local Area Network (LAN) cable connected to the LAN (RJ-45) port.

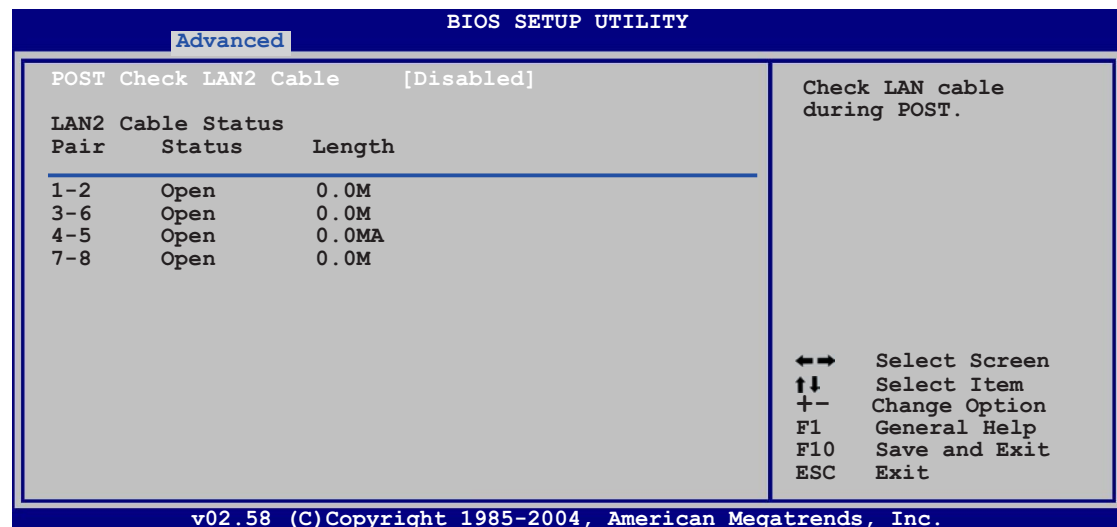

## POST Check LAN Cable [Disabled]

Allows you to enable or disable LAN cable check during POST. When enabled, the menu reports the cable faults or shorts, and displays the point (length) where the fault or short is detected. Configuration options: [Disabled] [Enabled]



This function is available only on Marvell® LAN (LAN2). See page 5-12 for details.

## 4.4.4 CPU Configuration

The items in this menu show the CPU-related information that the BIOS automatically detects.

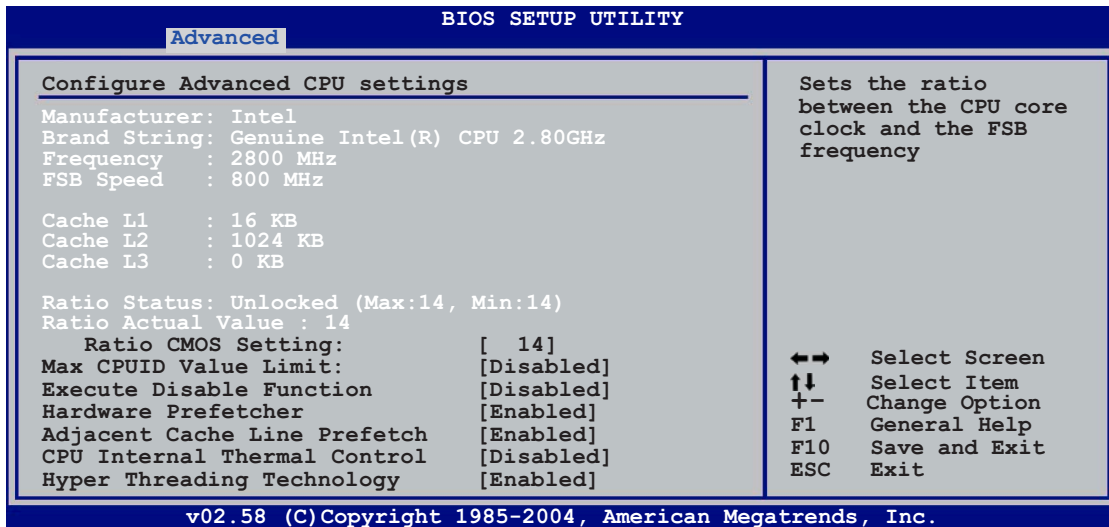

### Ratio CMOS Setting [ 14 ]

Sets the ratio between the CPU core clock and the Front Side Bus frequency. The BIOS auto-detects the default value of this item. Use the <+> or <-> key to adjust the values.



You can only adjust the **Ratio CMOS** if you installed an unlocked CPU. Refer to the CPU documentation for details.

### Max CPUID Value Limit [Disabled]

Setting this item to [Enabled] allows legacy operating systems to boot even without support for CPUs with extended CPUID functions. Configuration options: [Disabled] [Enabled]

### Execute Disable Function [Disabled]

Allows you to enable or disable the No-Execution Page Protection Technology. Setting this item to [Enabled] forces the XD feature flag to always return to zero (0). Configuration options: [Disabled] [Enabled]

### Hardware Prefetcher [Enabled]

Allows you to enable or disable the hardware prefetcher feature. Configuration options: [Disabled] [Enabled]

### Adjacent Cache Line Prefetch [Enabled]

Allows you to enable or disable the adjacent cache line feature. Configuration options: [Disabled] [Enabled]

## CPU Internal Thermal Control [Auto]

Allows you to disable or set to auto the CPU Internal Thermal Control function. When set to [Auto], the BIOS automatically checks the CPU's capability to enable TM or TM2 support. In TM mode, the CPU power consumption is reduced. In TM2 mode, the CPU core and VID are reduced. Configuration options: [Auto] [Disabled]

## Hyper Threading Technology [Enabled]

Allows you to enable or disable the processor Hyper-Threading Technology. Refer to the Appendix for more information on the Hyper-Threading Technology. Configuration options: [Disabled] [Enabled]



---

The following item appears only when you installed an Intel® Pentium® 4 CPU that supports the Enhanced Intel SpeedStep® Technology (EIST).

---

## Intel(R) SpeedStep Technology [Automatic]

Allows you to use the Enhanced Intel SpeedStep® Technology. When set to [Automatic], you can adjust the system power settings in the operating system to use the EIST feature.

Set this item to [Disabled] if you do not want to use the EIST.

Configuration options: [Automatic] [Disabled]



- 
- Refer to the Appendix for details on how to use the EIST feature.
  - The motherboard comes with a BIOS file that supports EIST.
-

## 4.4.5 Chipset

The Chipset menu allows you to change the advanced chipset settings. Select an item then press <Enter> to display the sub-menu.

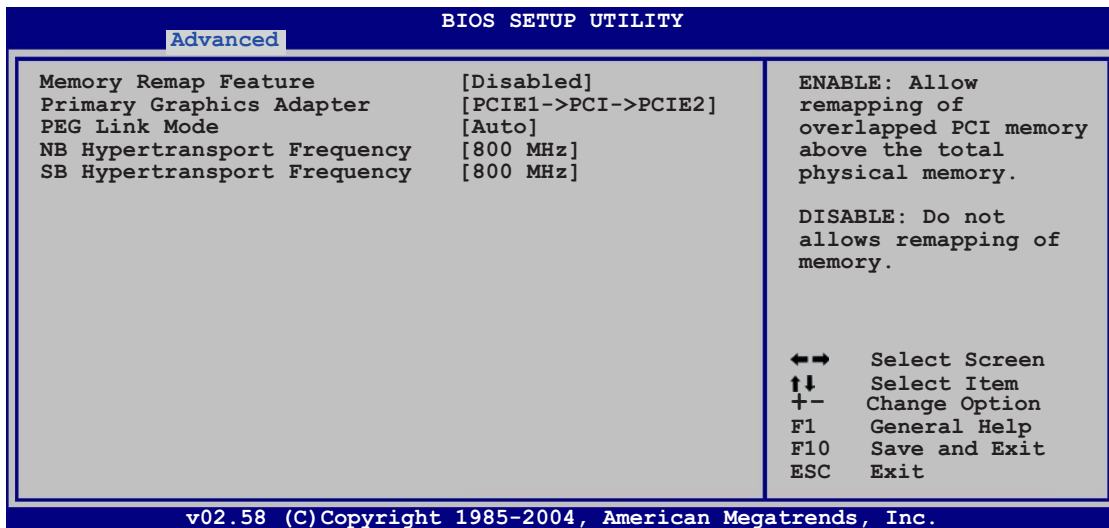

### Memory Remap Feature [Disabled]

Setting to [Enabled] allows remapping of overlapped PCI memory above the total physical memory. Configuration options: [Disabled] [Enabled]

### Primary Graphics Adapter [PCIE1->PCI->PCIE2]

Allows selection of the graphics controller to use as primary boot device. Configuration options: [PCIE2->PCI->PCIE1] [PCIE1->PCI->PCIE2]

### PEG Link Mode [Auto]

Sets the PCI Express graphics link mode. Setting this item to [Auto] allows the motherboard to automatically adjust the PCI Express graphics link mode to the correct frequency based on the system configuration. Three additional settings are available for overclocking the PEG Link Mode. Configuration options: [Auto] [Disabled] [Normal] [Fast] [Faster]

### NB Hypertransport Frequency [800 MHz]

Sets the Northbridge Hypertransport frequency. Configuration options: [200 MHz] [400 MHz] [600 MHz] [800 MHz] [1000 MHz]

### SB Hypertransport Frequency [800 MHz]

Sets the Southbridge Hypertransport frequency. Configuration options: [200 MHz] [400 MHz] [600 MHz] [800 MHz] [1000 MHz]

## 4.4.6 Onboard Devices Configuration

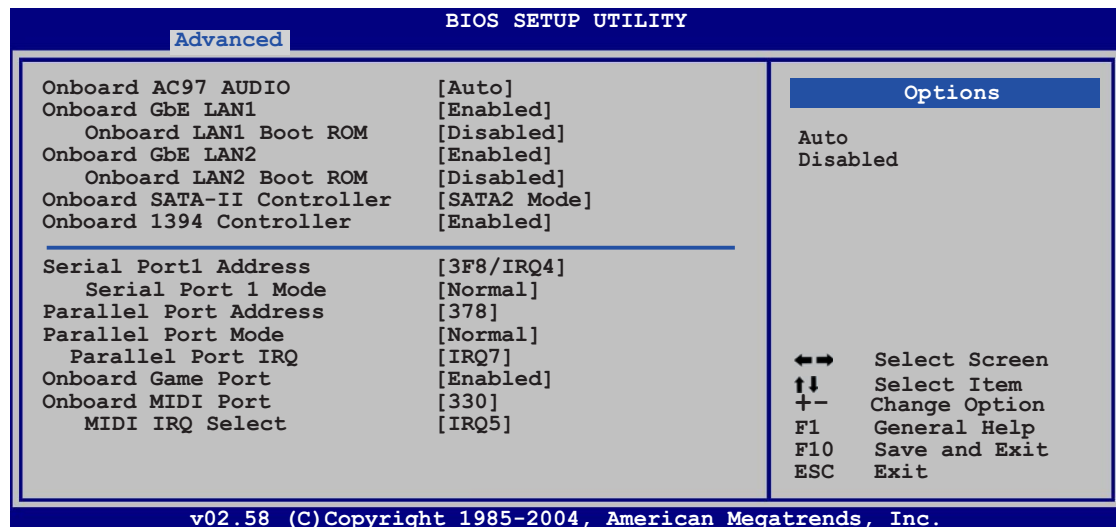

### Onboard AC97 AUDIO [Auto]

Allows you to disable the legacy AC97 audio CODEC, or lets the BIOS automatically configure. Configuration options: [Auto] [Disabled]

### Onboard GbE LAN1 [Enabled]

Allows you to enable or disable the onchip MAC LAN. Configuration options: [Disabled] [Enabled]

#### *Onboard LAN1 Boot ROM [Disabled]*

This item allows you to enable or disable the MAC boot ROM. This item appears only when the **Onboard GbE LAN1** item is set to [Enabled]. Configuration options: [Disabled] [Enabled]

### Onboard GbE LAN2 [Enabled]

Allows you to enable or disable the onboard PCI Express Gigabit LAN controller. Configuration options: [Disabled] [Enabled]

#### *Onboard LAN2 Boot ROM [Disabled]*

This item allows you to enable or disable the PCI Express Gigabit LAN boot ROM. This item appears only when the **Onboard GbE LAN2** item is set to [Enabled]. Configuration options: [Disabled] [Enabled]

### Onboard SATA-II Controller [SATA2 Mode]

Allows you to set the mode at which the onboard Silicon Image 3132 Serial ATA controller will operate. Set this item to [SATA2 Mode] to enable hot-plug function for the external device. Configuration options: [SATA2 Mode] [RAID Mode] [Disabled]

## OnBoard 1394 Controller [Enabled]

Allows you to enable or disable the onboard IEEE 1394a controller.  
Configuration options: [Enabled] [Disabled]

## Serial Port1 Address [3F8/IRQ4]

Allows you to select the Serial Port1 base address.  
Configuration options: [Disabled] [3F8/IRQ4] [2F8/IRQ3] [3E8/IRQ4]  
[2E8/IRQ3]

### *Serial Port1 Mode [Normal]*

Allows you to select the Serial Port1 mode.  
Configuration options: [Normal] [IrDA] [ASK IR]



---

The following item appears only when you set the Serial Port1 Mode item to [IrDA] or [ASK IR].

---

### *COMA Duplex Mode [Half Duplex]*

Allows the BIOS to select full or half-duplex for mode for Serial port1.  
Configuration options: [Full Duplex] [Half Duplex]

## Parallel Port Address [378]

Allows you to select the Parallel Port base addresses.  
Configuration options: [Disabled] [378] [278] [3BC]

## Parallel Port Mode [Normal]

Allows you to select the Parallel Port mode.  
Configuration options: [Normal] [EPP] [ECP] [EPP+ECP]

### **ECP Mode DMA Channel [DMA3]**

Appears only when the Parallel Port Mode is set to [ECP]. This item allows you to set the Parallel Port ECP DMA.  
Configuration options: [DMA0] [DMA1] [DMA3]

### **EPP Version [1.9]**

Appears only when the Parallel Port Mode is set to [EPP]. Allows you to select the parallel port EPP version. Configuration options: [1.9] [1.7]

### *Parallel Port IRQ [IRQ7]*

Allows you to select the parallel port IRQ.  
Configuration options: [IRQ5] [IRQ7]

## Onboard Game Port [Disabled]

Allows you to enable or disable the onboard game port  
Configuration options: [Disabled] [Enabled]



## Onboard MIDI Port [330]

Allows you to select the Game Port address or to disable the port.

Configuration options: [Disabled] [300] [330]

### *MIDI IRQ Select [IRQ5]*

This item allows the BIOS to select the MIDI port IRQs.

Configuration options: [IRQ5] [IRQ7] [IRQ10] [IRQ11]

## 4.4.7 PCI PnP

The PCI PnP menu items allow you to change the advanced settings for PCI/PnP devices. The menu includes setting IRQ and DMA channel resources for either PCI/PnP or legacy ISA devices, and setting the memory size block for legacy ISA devices.



Take caution when changing the settings of the PCI PnP menu items. Incorrect field values can cause the system to malfunction.

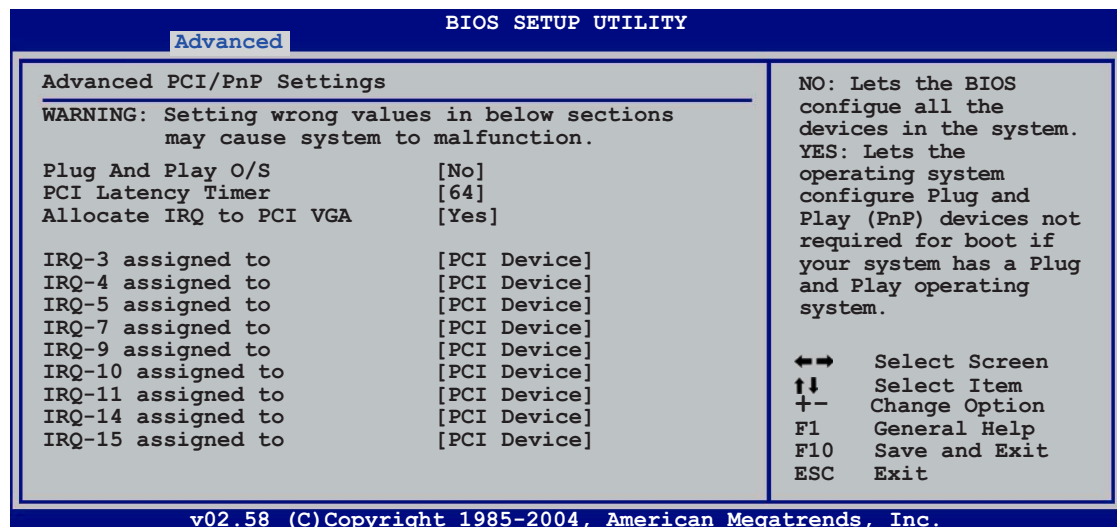

### Plug And Play O/S [No]

When set to [No], BIOS configures all the devices in the system. When set to [Yes] and if you install a Plug and Play operating system, the operating system configures the Plug and Play devices not required for boot.

Configuration options: [No] [Yes]

### PCI Latency Timer [64]

Allows you to select the value in units of PCI clocks for the PCI device latency timer register. Configuration options: [32] [64] [96] [128] [160] [192] [224] [248]

## Allocate IRQ to PCI VGA [Yes]

When set to [Yes], BIOS assigns an IRQ to PCI VGA card if the card requests for an IRQ. When set to [No], BIOS does not assign an IRQ to the PCI VGA card even if requested. Configuration options: [No] [Yes]

## IRQ-xx assigned to [PCI Device]

When set to [PCI Device], the specific IRQ is free for use of PCI/PnP devices. When set to [Reserved], the IRQ is reserved for legacy ISA devices. Configuration options: [PCI Device] [Reserved]

## 4.5 Power menu

The Power menu items allow you to change the settings for the ACPI and Advanced Power Management (APM) features. Select an item then press <Enter> to display the configuration options.

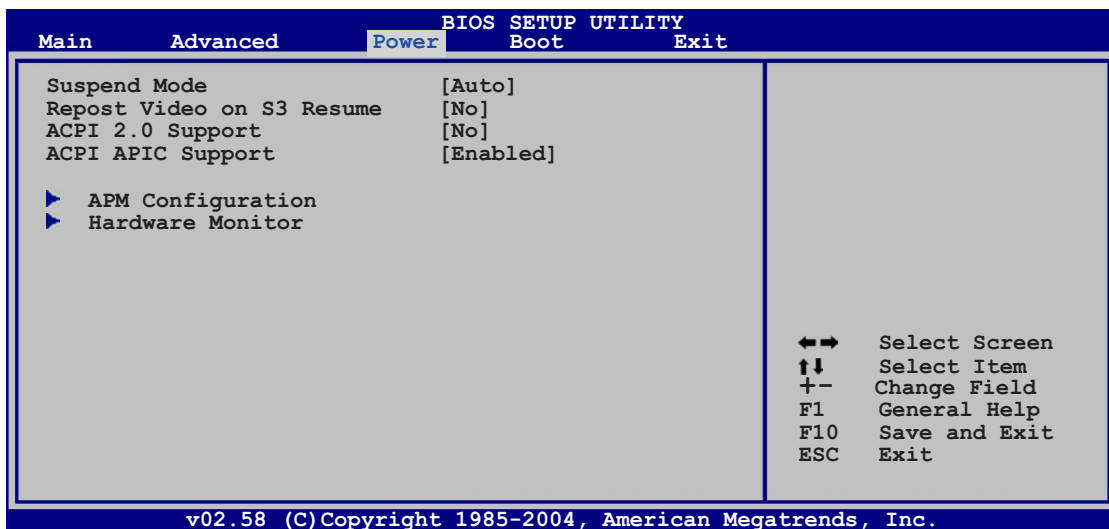

### 4.5.1 Suspend Mode [Auto]

Allows you to select the Advanced Configuration and Power Interface (ACPI) state to be used for system suspend. Setting this item to [Auto] allows the OS to select the ACPI state. Configuration options: [S1 (POS) Only] [S3 Only] [Auto]

### 4.5.2 Repost Video on S3 Resume [No]

Determines whether to invoke VGA BIOS POST on S3/STR resume. Configuration options: [No] [Yes]

### 4.5.3 ACPI 2.0 Support [No]

Allows you to add more tables for Advanced Configuration and Power Interface (ACPI) 2.0 specifications. Configuration options: [No] [Yes]

### 4.5.4 ACPI APIC Support [Enabled]

Allows you to enable or disable the Advanced Configuration and Power Interface (ACPI) support in the Advanced Programmable Interrupt Controller (APIC). When set to Enabled, the ACPI APIC table pointer is included in the RSDT pointer list. Configuration options: [Disabled] [Enabled]

### 4.5.5 APM Configuration

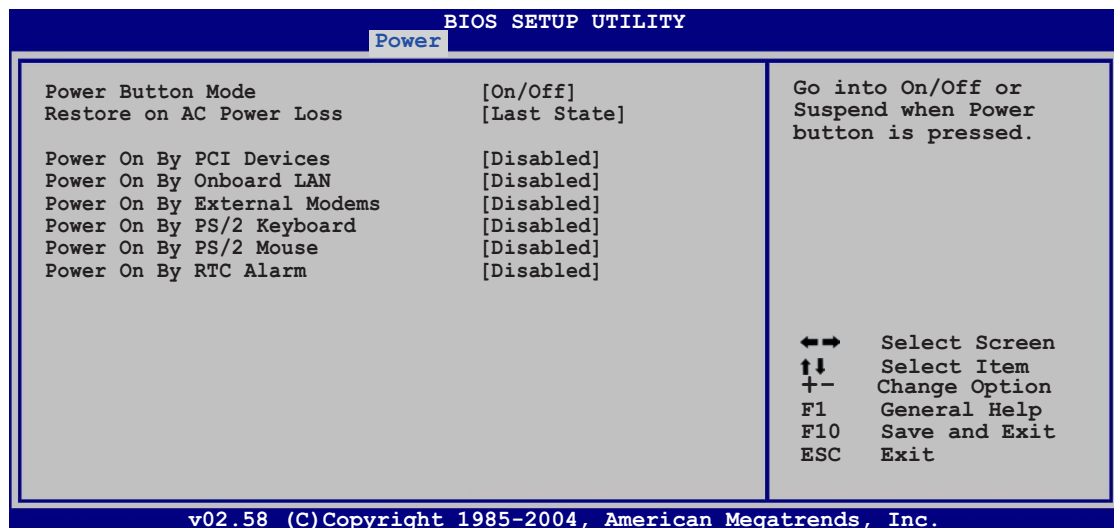

#### Power Button Mode [On/Off]

Allows the system to go into On/Off mode or suspend mode when the power button is pressed. Configuration options: [On/Off] [Suspend]

#### Restore on AC Power Loss [Last State]

When set to Power Off, the system goes into off state after an AC power loss. When set to Power On, the system goes on after an AC power loss. When set to Last State, the system goes into either off or on state, whatever the system state was before the AC power loss. Configuration options: [Power Off] [Power On] [Last State]

#### Power On By PCI Devices [Disabled]

When set to [Enabled], this parameter allows you to turn on the system through a PCI LAN or modem card. This feature requires an ATX power supply that provides at least 1A on the +5VSB lead. Configuration options: [Disabled] [Enabled]

## Power On By Onboard LAN [Disabled]

Allows you to enable or disable the LAN (MAC) to generate a wake event.  
Configuration options: [Disabled] [Enabled]

## Power On By External Modems [Disabled]

Allows either settings of [Enabled] or [Disabled] for powering up the computer when the external modem receives a call while the computer is in Soft-off mode. Configuration options: [Disabled] [Enabled]



---

The computer cannot receive or transmit data until the computer and applications are fully running. Thus, connection cannot be made on the first try. Turning an external modem off and then back on while the computer is off causes an initialization string that turns the system power on.

---

## Power On By PS/2 Keyboard [Disabled]

Allows you to use specific keys on the keyboard to turn on the system. This feature requires an ATX power supply that provides at least 1A on the +5VSB lead. Configuration options: [Disabled] [Enabled]

## Power On By PS/2 Mouse [Disabled]

When set to [Enabled], this parameter allows you to use the PS/2 mouse to turn on the system. This feature requires an ATX power supply that provides at least 1A on the +5VSB lead. Configuration options: [Disabled] [Enabled]

## Power On By RTC Alarm [Disabled]

Allows you to enable or disable RTC to generate a wake event.  
Configuration options: [Disabled] [Enabled]



---

The succeeding items appear when the **Power On By RTC Alarm** item is set to Enabled.

---

### *RTC Alarm Date*

To set the alarm date, highlight this item and press the <+> or <-> key to make the selection.

## System Time

Allows you to set the system time. Use <Enter>, <Tab>, or <Shift+Tab> to select a field. Use the <+> or <-> key to set the value.

## 4.5.6 Hardware Monitor

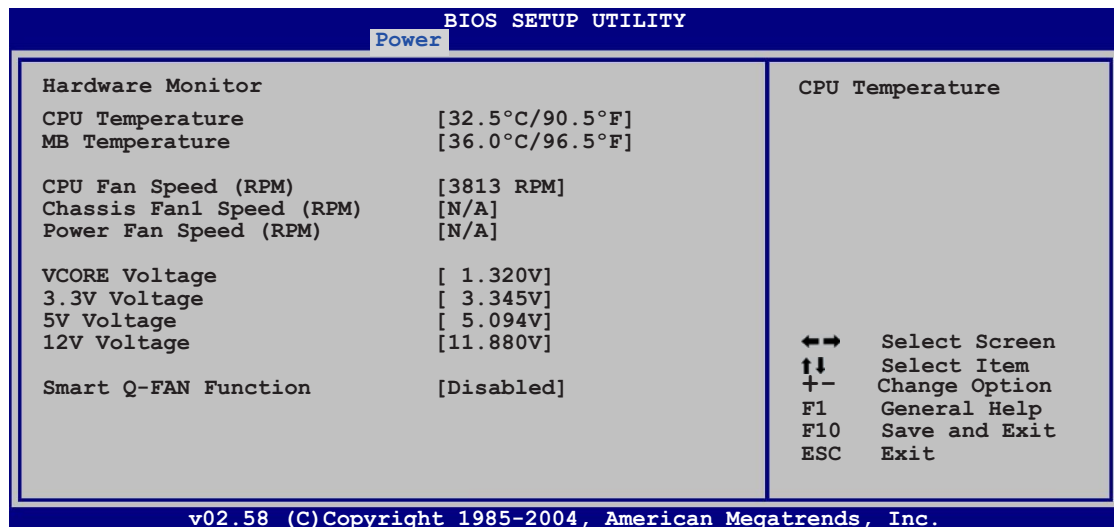

### **CPU Temperature [xxx°C/xxx°F] MB Temperature [xxx°C/xxx°F]**

The onboard hardware monitor automatically detects and displays the motherboard and CPU temperatures. Select [Disabled] if you do not wish to display the detected temperatures.

### **CPU Fan Speed (RPM) [xxxxRPM] or [N/A] or [Ignored]**

The onboard hardware monitor automatically detects and displays the CPU fan speed in rotations per minute (RPM). If the fan is not connected to the motherboard, the field shows N/A. Select [Ignore] from the item options to disable CPU fan speed monitoring.

### **Chassis Fan1 Speed [xxxxRPM] or [N/A] or [Ignored]**

The onboard hardware monitor automatically detects and displays the chassis fan speed in rotations per minute (RPM). If the fan is not connected to the chassis, the specific field shows N/A. Select [Ignore] from the item options to disable chassis fan speed monitoring.

### **Power Fan Speed (RPM) [xxxxRPM] or [N/A] or [Ignored]**

The onboard hardware monitor automatically detects and displays the power fan speed in rotations per minute (RPM). If the fan is not connected to the power fan connector, the specific field shows N/A.

### **VCORE Voltage, 3.3V Voltage, 5V Voltage, 12V Voltage**

The onboard hardware monitor automatically detects the voltage output through the onboard voltage regulators.

## Smart Q-FAN Function [Disabled]

Allows you to enable or disable the ASUS Q-Fan feature that smartly adjusts the fan speeds for more efficient system operation. Configuration options: [Disabled] [Enabled]



---

The following items appear when you enable the **Smart Q-FAN Function**.

---

## CPU Q-Fan Mode [PWM]

Allows you to select the type of CPU fan cable connected to the CPU fan connector. Set to [PWM] when using a 4-pin CPU fan cable. Set to [DC] when using a 3-pin CPU fan cable. Configuration options: [PWM] [DC]



---

Some CPU fans with a 4-pin cable do not comply with Intel®'s PWM fan specification. When using this type of CPU fan, you can not reduce the CPU fan speed even if you set the CPU Q-Fan Mode to [PWM].

---

## CPU Fan Start Voltage [5.0V]

Configuration options: [4.0V] [4.5V] [5.0V] [5.5V] [6.0V]

## CPU Fan Start Speed Temp [25°C]

Configuration options: [25°C] [26°C] [27°C]... [75°C]

## CPU Fan Full Speed Temp [66°C]

Configuration options: [25°C] [26°C] [27°C]... [75°C]

## Chassis Fan1 Start Voltage [5.0V]

Configuration options: [4.0V] [4.5V] [5.0V] [5.5V] [6.0V]

## Chassis Fan1 Start Speed Temp [25°C]

Configuration options: [25°C] [26°C] [27°C]... [75°C]

## Chassis Fan1 Full Speed Temp [45°C]

Configuration options: [25°C] [26°C] [27°C]... [75°C]

## 4.6 Boot menu

The Boot menu items allow you to change the system boot options. Select an item then press <Enter> to display the sub-menu.

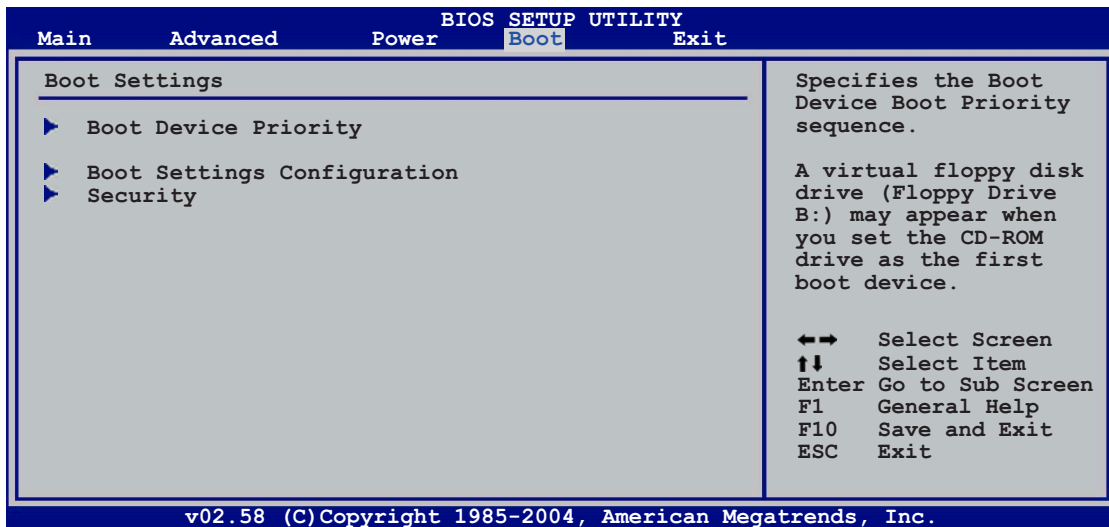

### 4.6.1 Boot Device Priority

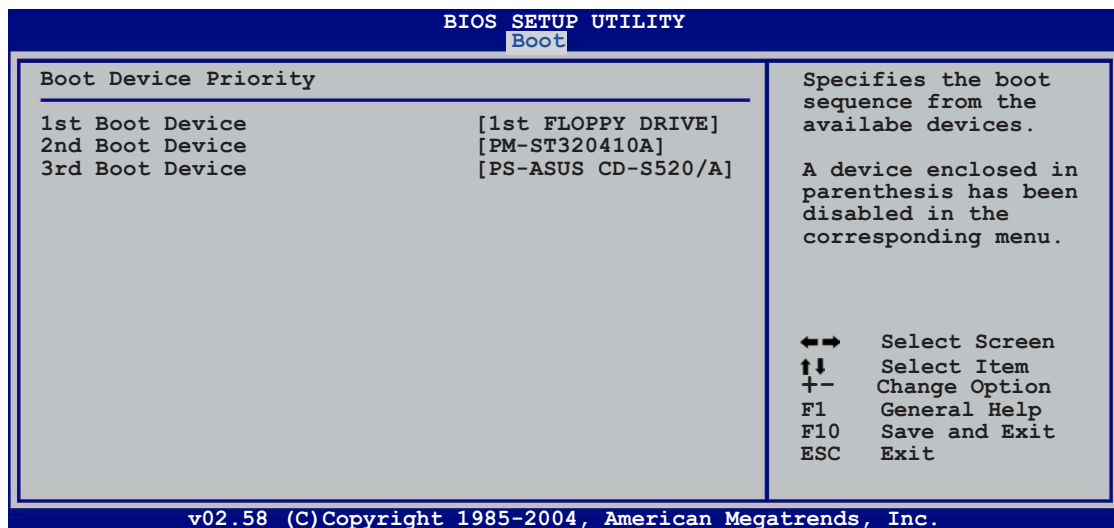

#### 1st ~ xxth Boot Device [1st Floppy Drive]

These items specify the boot device priority sequence from the available devices. The number of device items that appears on the screen depends on the number of devices installed in the system.

Configuration options: [xxxxx Drive] [Disabled]

## 4.6.2 Boot Settings Configuration

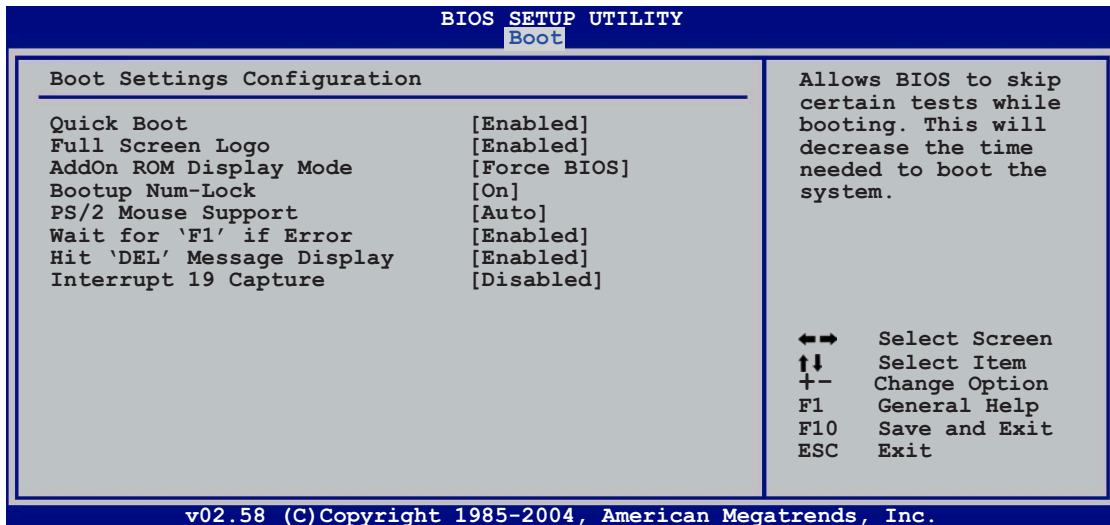

### Quick Boot [Enabled]

Enabling this item allows the BIOS to skip some power on self tests (POST) while booting to decrease the time needed to boot the system. When set to [Disabled], BIOS performs all the POST items.

Configuration options: [Disabled] [Enabled]

### Full Screen Logo [Enabled]

Allows you to enable or disable the full screen logo display feature.

Configuration options: [Disabled] [Enabled]



Set this item to [Enabled] to use the ASUS MyLogo2™ feature.

### Add On ROM Display Mode [Force BIOS]

Sets the display mode for option ROM.

Configuration options: [Force BIOS] [Keep Current]

### Bootup Num-Lock [On]

Allows you to select the power-on state for the NumLock.

Configuration options: [Off] [On]

### PS/2 Mouse Support [Auto]

Allows you to enable or disable support for PS/2 mouse.

Configuration options: [Disabled] [Enabled] [Auto]

### Wait for 'F1' If Error [Enabled]

When set to Enabled, the system waits for the F1 key to be pressed when error occurs. Configuration options: [Disabled] [Enabled]



## Hit 'DEL' Message Display [Enabled]

When set to Enabled, the system displays the message "Press DEL to run Setup" during POST. Configuration options: [Disabled] [Enabled]

## Interrupt 19 Capture [Disabled]

When set to [Enabled], this function allows the option ROMs to trap Interrupt 19. Configuration options: [Disabled] [Enabled]

### 4.6.3 Security

The Security menu items allow you to change the system security settings. Select an item then press <Enter> to display the configuration options.

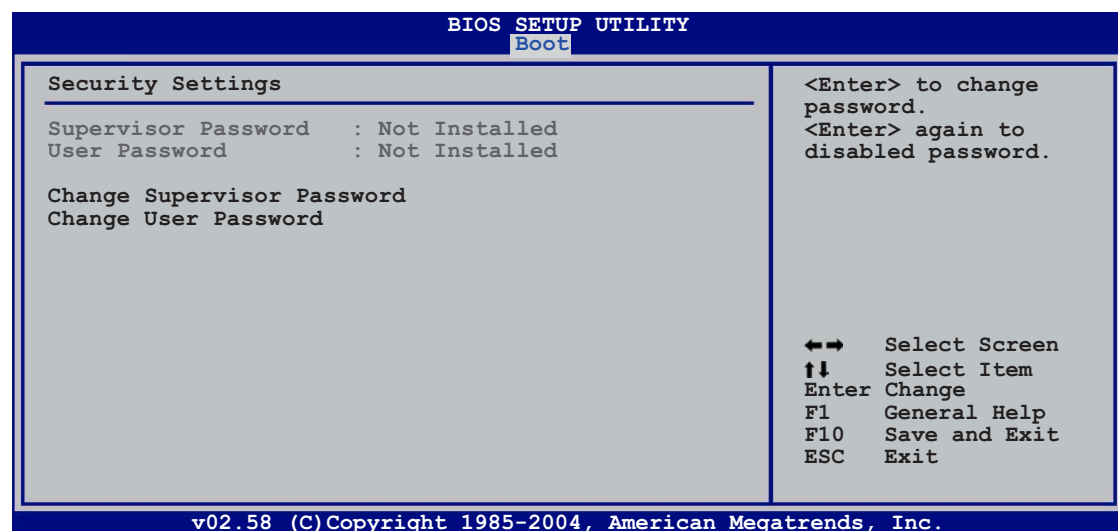

### Change Supervisor Password

Select this item to set or change the supervisor password. The Supervisor Password item on top of the screen shows the default **Not Installed**. After you set a password, this item shows **Installed**.

To set a Supervisor Password:

1. Select the Change Supervisor Password item and press <Enter>.
2. From the password box, type a password composed of at least six letters and/or numbers, then press <Enter>.
3. Confirm the password when prompted.

The message "Password Installed" appears after you successfully set your password.

To change the supervisor password, follow the same steps as in setting a user password.

To clear the supervisor password, select the Change Supervisor Password then press <Enter>. The message “Password Uninstalled” appears.



If you forget your BIOS password, you can clear it by erasing the CMOS Real Time Clock (RTC) RAM. See section “2.6 Jumpers” for information on how to erase the RTC RAM.

After you have set a supervisor password, the other items appear to allow you to change other security settings.

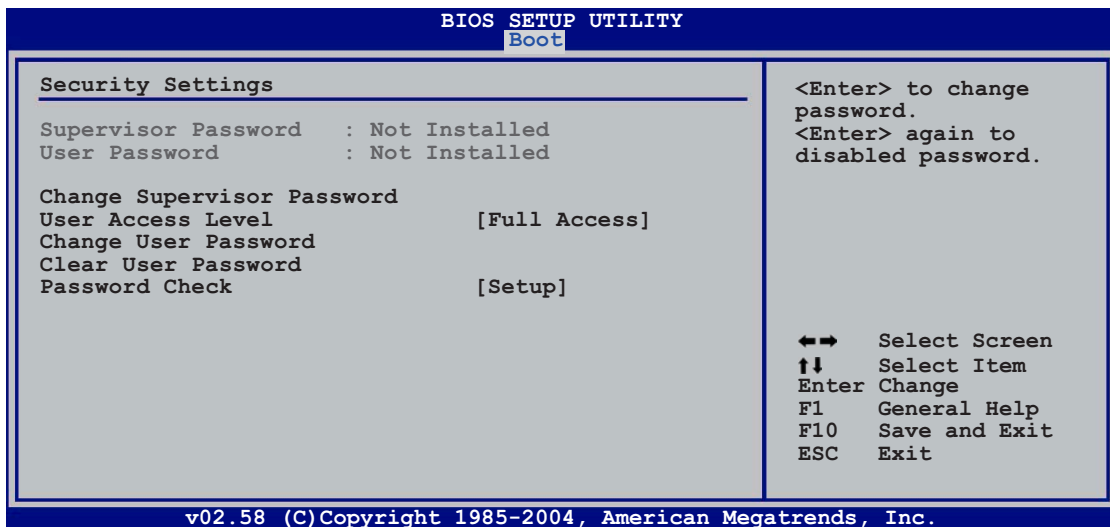

## User Access Level (Full Access)

This item allows you to select the access restriction to the Setup items. Configuration options: [No Access] [View Only] [Limited] [Full Access]

**No Access** prevents user access to the Setup utility.

**View Only** allows access but does not allow change to any field.

**Limited** allows changes only to selected fields, such as Date and Time.

**Full Access** allows viewing and changing all the fields in the Setup utility.

## Change User Password

Select this item to set or change the user password. The User Password item on top of the screen shows the default **Not Installed**. After you set a password, this item shows **Installed**.

To set a User Password:

1. Select the Change User Password item and press <Enter>.
2. On the password box that appears, type a password composed of at least six letters and/or numbers, then press <Enter>.
3. Confirm the password when prompted.

The message “Password Installed” appears after you set your password successfully.

To change the user password, follow the same steps as in setting a user password.

## Password Check [Setup]

When set to [Setup], BIOS checks for user password when accessing the Setup utility. When set to [Always], BIOS checks for user password both when accessing Setup and booting the system.

Configuration options: [Setup] [Always]

## 4.7 Exit menu

The Exit menu items allow you to load the optimal or failsafe default values for the BIOS items, and save or discard your changes to the BIOS items.

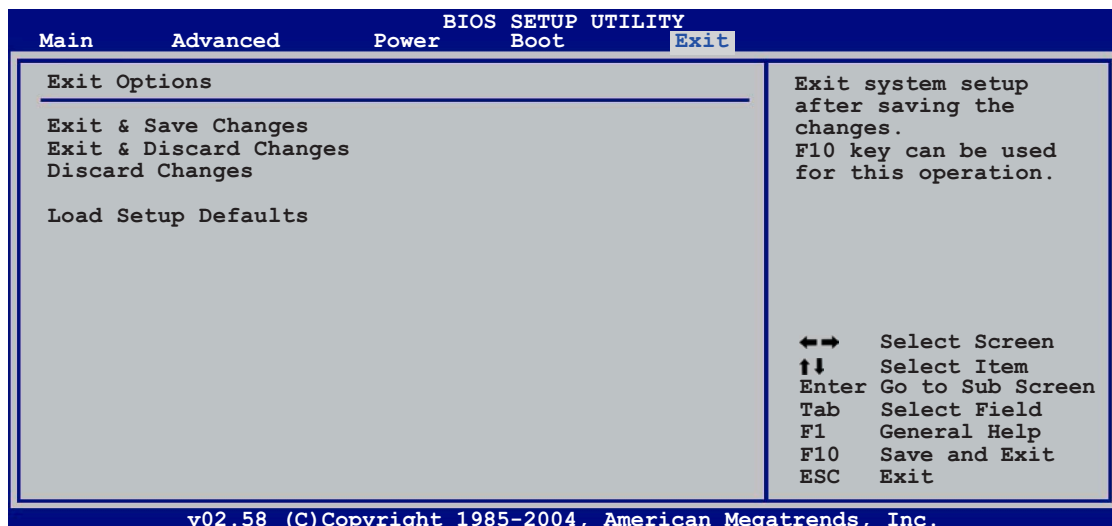

Pressing <Esc> does not immediately exit this menu. Select one of the options from this menu or <F10> from the legend bar to exit.

## Exit & Save Changes

Once you are finished making your selections, choose this option from the Exit menu to ensure the values you selected are saved to the CMOS RAM. An onboard backup battery sustains the CMOS RAM so it stays on even when the PC is turned off. When you select this option, a confirmation window appears. Select **[Ok]** to save changes and exit.



---

If you attempt to exit the Setup program without saving your changes, the program prompts you with a message asking if you want to save your changes before exiting. Press <Enter> to save the changes while exiting.

---

## Exit & Discard Changes

Select this option only if you do not want to save the changes that you made to the Setup program. If you made changes to fields other than System Date, System Time, and Password, the BIOS asks for a confirmation before exiting.

## Discard Changes

This option allows you to discard the selections you made and restore the previously saved values. After selecting this option, a confirmation appears. Select **[Ok]** to discard any changes and load the previously saved values.

## Load Setup Defaults

This option allows you to load the default values for each of the parameters on the Setup menus. When you select this option or if you press <F5>, a confirmation window appears. Select **[Ok]** to load default values. Select **Exit & Save Changes** or make other changes before saving the values to the non-volatile RAM.

This chapter describes the contents of the support CD that comes with the motherboard package.

# 5 Software support

5.1	Installing an operating system .....	5-1
5.2	Support CD information .....	5-1
5.3	Software information .....	5-10
5.4	RAID configurations .....	5-26
5.5	Creating a RAID driver disk .....	5-42

## 5.1 Installing an operating system

This motherboard supports Windows® 2000/2003 Server/XP/64-bit XP operating systems (OS). Always install the latest OS version and corresponding updates to maximize the features of your hardware.



- Motherboard settings and hardware options vary. Use the setup procedures presented in this chapter for reference only. Refer to your OS documentation for detailed information.
- Make sure that you install Windows® 2000 Service Pack 4 or the Windows® XP Service Pack 2 or later versions before installing the drivers for better compatibility and system stability.

## 5.2 Support CD information

The support CD that came with the motherboard package contains the drivers, software applications, and utilities that you can install to avail all motherboard features.



The contents of the support CD are subject to change at any time without notice. Visit the ASUS website([www.asus.com](http://www.asus.com)) for updates.

### 5.2.1 Running the support CD

Place the support CD to the optical drive. The CD automatically displays the **Drivers** menu if Autorun is enabled in your computer.

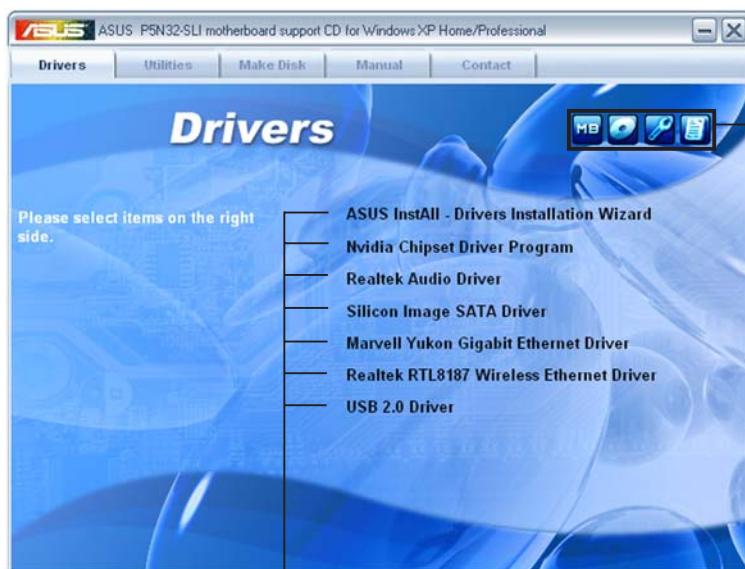

Click an icon to display support CD/motherboard information

Click an item to install



If **Autorun** is NOT enabled in your computer, browse the contents of the support CD to locate the file **ASSETUP.EXE** from the BIN folder. Double-click the **ASSETUP.EXE** to run the CD.

## 5.2.2 Drivers menu

The drivers menu shows the available device drivers if the system detects installed devices. Install the necessary drivers to activate the devices.



### **ASUS InstAll -Drivers Installation Wizard**

Launches the ASUS InstallAll driver installation wizard.

### **Nvidia Chipset Driver**

Installs the NVIDIA® Chipset drivers for the NVIDIA® nForce™ 4 SLI chipset.

### **Realtek Audio Driver**

Installs the Realtek® ALC850 audio controller and application.

### **Silicon Image SATA Driver**

Installs the Silicon Image® Serial ATA driver.

### **Marvell Yukon Gigabit Ethernet Driver**

Installs the Marvell® Yukon Gigabit Ethernet driver.

### **Realtek RTL8187 Wireless Ethernet Driver**

Installs the Realtek® RTL8187 wireless Ethernet driver.

### **USB 2.0 Driver**

Installs the Universal Serial Bus 2.0 (USB 2.0) driver.



## 5.2.3 Utilities menu

The Utilities menu shows the applications and other software that the motherboard supports.

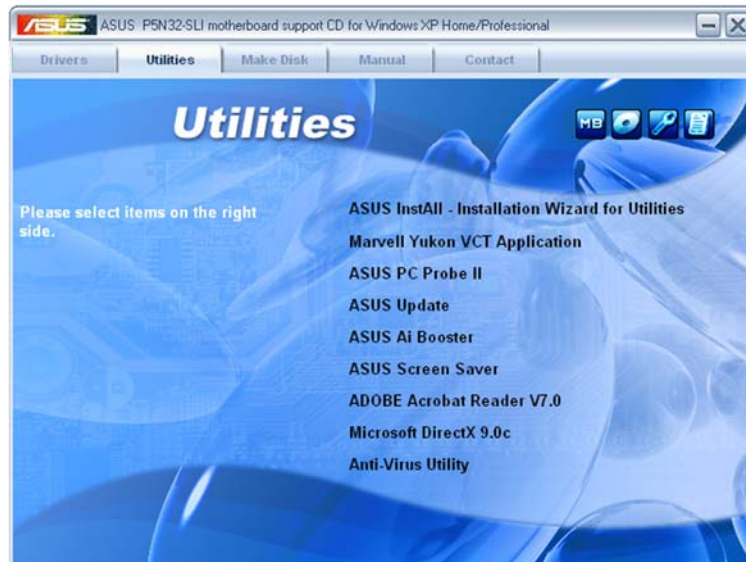

### **ASUS InstAll - Installation Wizard for utilities**

Launches the ASUS InstallAll utilities installation wizard.

### **Marvell Yukon VCT Application**

Installs the Marvell® Yukon Virtual Cable Tester™, a cable diagnostic utility that reports LAN cable faults and shorts.

### **ASUS PC Probe II**

This smart utility monitors the fan speed, CPU temperature, and system voltages, and alerts you of any detected problems. This utility helps you keep your computer in healthy operating condition.

### **ASUS Update**

The ASUS Update utility allows you to update the motherboard BIOS in Windows® environment. This utility requires an Internet connection either through a network or an Internet Service Provider (ISP).

### **ASUS Screen Saver**

Bring life to your computer screen by installing the ASUS screen saver.

### **ADOBE Acrobat V7.0**

Installs the Adobe® Acrobat® Reader that allows you to open, view, and print documents in Portable Document Format (PDF).

## Microsoft DirectX 9.0c

Installs the Microsoft® DirectX 9.0c driver. The Microsoft DirectX® 9.0c is a multimedia technology that enhances computer graphics and sound.

DirectX® improves the multimedia features of your computer so you can enjoy watching TV and movies, capturing videos, or playing games in your computer. Visit the Microsoft website ([www.microsoft.com](http://www.microsoft.com)) for updates.

## Anti-virus Utility

The anti-virus application scans, identifies, and removes computer viruses. View the online help for detailed information.

## 5.2.4 Make Disk menu

The Make Disk menu contains items to create the NVIDIA® nForce™ 4 or Silicon Image SATA/PATA RAID driver disk.



### NV Win2000 PATA RAID Driver

### NV Win2000 SATA RAID Driver

Allows you to create an NVIDIA® Windows® 2000 parallel/serial ATA RAID driver disk.

### NV WinXP PATA RAID Driver

### NV WinXP SATA RAID Driver

Allows you to create an NVIDIA® Windows® XP parallel/serial ATA RAID driver disk.

### NV Win2003 PATA RAID Driver

### NV Win2003 SATA RAID Driver

Allows you to create an NVIDIA® Windows® 2003 parallel/serial ATA RAID driver disk.

## **Make NV 64bit WinXP PATA RAID Driver Make NV 64bit WinXP SATA RAID Driver**

Allows you to create an NVIDIA® Windows® XP parallel/serial ATA RAID driver disk for a 64-bit system.

## **Make NV 64bit Win2003 PATA RAID Driver Make NV 64bit Win2003 SATA RAID Driver**

Allows you to create an NVIDIA® Windows® 2003 parallel/serial ATA RAID driver disk for a 64-bit system.



Click  to view the next screen.



## **Silicon Image 32bit RAID Driver Silicon Image 32bit SATA Driver**

Allows you to create a Silicon Image® RAID/Serial ATA driver disk for a 32-bit system.

## **Silicon Image 64bit RAID Driver Silicon Image 64bit SATA Driver**

Allows you to create a Silicon Image® RAID/Serial ATA driver disk for a 64-bit system.



Click  to view the previous screen.

## 5.2.5 Manuals menu

The Manuals menu contains a list of supplementary user manuals. Click an item to open the folder of the user manual.



Most user manual files are in Portable Document Format (PDF). Install the Adobe® Acrobat® Reader from the **Utilities menu** before opening a user manual file.

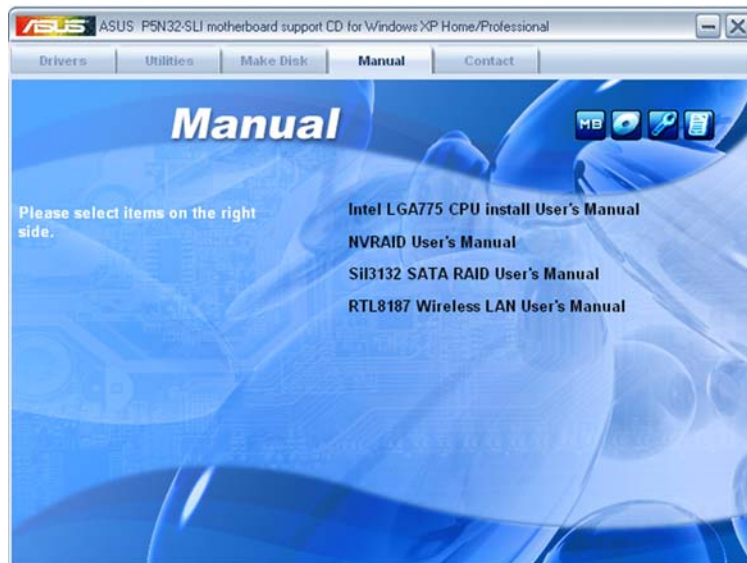

### **Intel LGA775 CPU Install User's Manual**

Allows you to open the Intel® LGA775 CPU installation guide.

### **NVRAID User's Manual**

Allows you to open the NVRAID user's manual.

### **Sil3132 SATA RAID User's Manual**

Allows you to open the Silicon Image Sil3132 SATA RAID user's manual.

### **RTL8187 Wireless LAN User's Manual**

Allows you to open the Realtek® RTL8187 Wireless LAN user's manual.

## 5.2.6 ASUS Contact information

Click the **Contact** tab to display the ASUS contact information. You can also find this information on the inside front cover of this user guide.



## 5.2.7 Other information

The icons on the top right corner of the screen give additional information on the motherboard and the contents of the support CD. Click an icon to display the specified information.

### Motherboard Info

Displays the general specifications of the motherboard.

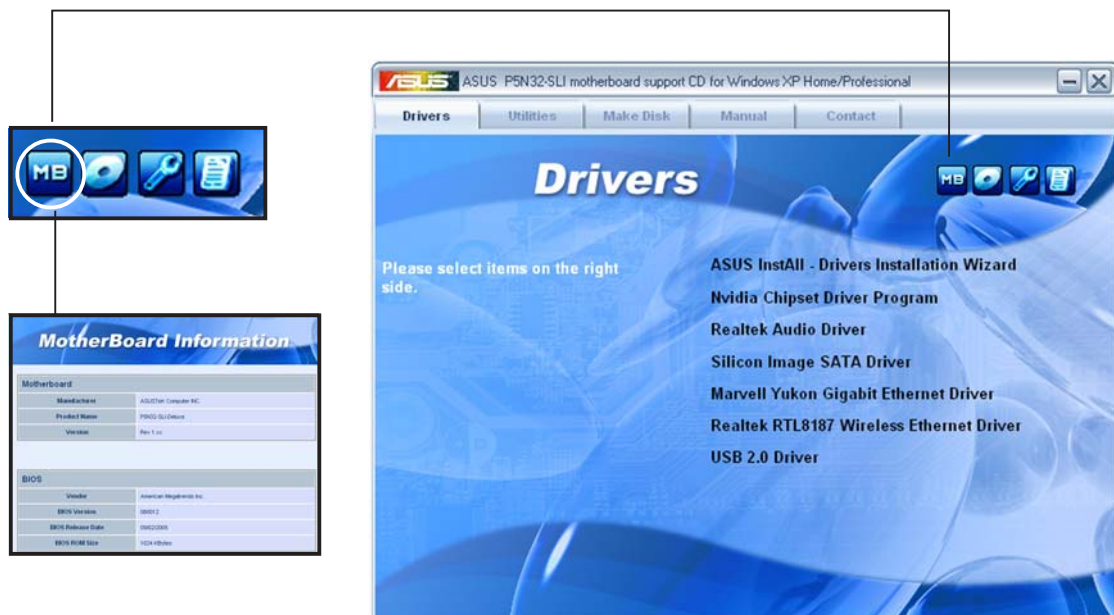

## Browse this CD

Displays the support CD contents in graphical format.

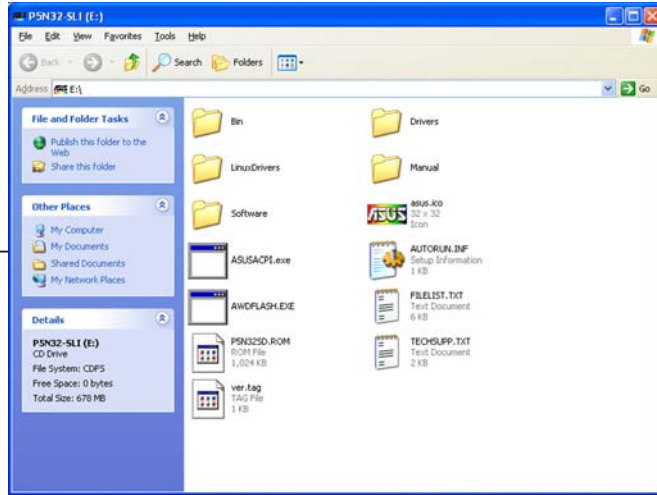

## Technical support Form

Displays the ASUS Technical Support Request Form that you have to fill out when requesting technical support.

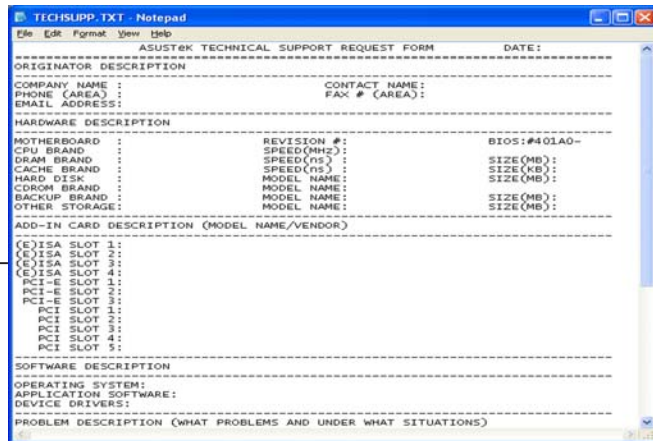

## Filelist

Displays the contents of the support CD and a brief description of each in text format.



```
FILELIST.TXT - Notepad
File list for the included support software for P5N32-SLI Series motherboard
-----
File Name      Description
-----
--Drivers
--Audio
--ALC850      --Realtek AC'97 Driver V5.10.00.5890 for windows 2000/XP/Win
--Chipset
--2002x64     --nvidia Chipset Driver v6.66 for 64 bit windows 2003.
--ak-g018     --nvidia Chipset RAID Driver 018k.
--w1n2k3     --nvidia Chipset Driver v6.66 for windows 2003.
--w1n2k3     --nvidia Chipset Driver v6.66 for 64 bit windows xp(WHQL).
--w1nXP      --nvidia Chipset Driver v6.66 for windows 2000/XP(WHQL).
--LAN
--Marvell    --Marvell Yukon Gigabit Ethernet Driver V8.24.3.3 for Window
--VCT        --Marvell VCT Package V2.11.1.3 for 2000/XP/2003 & 64bit XP/2
--UNDI       --Marvell UNDI Driver For EFI33 V2.03.
--Client_32  --Marvell Yukon Client 32 Driver V7.03.
--DOS        --Marvell DOS DOS Driver V7.06.
--Netware    --Marvell Yukon Netware 4.0 Driver V7.03.
--Marvell    --Marvell Yukon Netware 3.7A driver V7.03.
--SC0        --Marvell SC0 unware 7.1.x driver and openuntx 8.0.
--RIS        --Marvell RIS Driver V8.27.4.3 for 2000/XP/2003.
--Marvell    --Marvell RIS Driver V8.27.3.3 for 64bit XP/2003.
--Yukon      --Marvell Yukon Gigabit Ethernet Driver V8.27.3.3 for window
--x64
--SATA
--S11332     --S11332
--12bit-RAID --S11332 RAID Driver V1.2.3.1 and utility for Window
--12bit-SATA --S11332 Image Serial ATA driver V1.0.0.9 for windows XP/20
--12bit-DOS-RAID --S11332 RAID Driver V1.2.3.1 For XP/2k/200
--12bit-DOS-SATA --S11332 Image S11 3132 Serial ATA driver V1.0.0.9 for XP/
--64bit-RAID --S11332 Image Serial ATA RAID Driver V1.2.3.1 WHQL For W1
--64bit-SATA --S11332 Image Serial ATA Driver V1.0.3.0 WHQL For windows
--64bit-DOS-RAID --S11332 RAID Driver V1.0.3.0 WHQL For XP/
--64bit-DOS-SATA --S11332 Image S11 3132 Serial ATA Driver V1.0.3.0 WHQL For XP/
```

## 5.3 Software information

Most of the applications in the support CD have wizards that will conveniently guide you through the installation. View the online help or readme file that came with the software application for more information.

### 5.3.1 ASUS MyLogo2™

The ASUS MyLogo2™ utility lets you customize the boot logo. The boot logo is the image that appears on screen during the Power-On Self-Tests (POST). The ASUS MyLogo2™ is automatically installed when you install the **ASUS Update** utility from the support CD. See section “5.2.3 Utilities menu” for details.



- Before using the ASUS MyLogo2™, use the AFUDOS BIOS Flash utility to make a copy of your original BIOS file, or obtain the latest BIOS version from the ASUS website. See section “4.1.2 AFUDOS utility.”
- Make sure that the BIOS item **Full Screen Logo** is set to [Enabled] if you wish to use ASUS MyLogo2. See section “4.6.2 Boot Settings Configuration”.
- You can create your own boot logo image in GIF, JPG, or BMP file formats.

To launch the ASUS MyLogo2™:

1. Launch the ASUS Update utility. Refer to section “4.1.5 ASUS Update utility” for details.
2. Select **Options** from the drop down menu, then click **Next**.
3. Check the option **Launch MyLogo to replace system boot logo before flashing BIOS**, then click **Next**.
4. Select **Update BIOS from a file** from the drop down menu, then click **Next**.
5. When prompted, locate the new BIOS file, then click **Next**. The ASUS MyLogo2 window appears.
6. From the left window pane, select the folder that contains the image you intend to use as your boot logo.





7. When the logo images appear on the right window pane, select an image to enlarge by clicking on it.



8. Adjust the boot image to your desired size by selecting a value on the **Ratio** box.



9. When the screen returns to the ASUS Update utility, flash the original BIOS to load the new boot logo.
10. After flashing the BIOS, restart the computer to display the new boot logo during POST.

## 5.3.2 AI NET 2

The Marvell® Virtual Cable Tester™ (VCT) is a cable diagnostic utility that reports LAN cable faults and shorts using the Time Domain Reflectometry (TDR) technology. The VCT detects and reports open and shorted cables, impedance mismatches, pair swaps, pair polarity problems, and pair skew problems of up to 100 meters at one meter accuracy.

The VCT feature reduces networking and support costs through a highly manageable and controlled network system. This utility can be incorporated in the network systems software for ideal field support as well as development diagnostics.

### Using the Virtual Cable Tester™

To use the the Marvell® Virtual Cable Tester™ utility:

1. Launch the VCT utility from the Windows® desktop by clicking **Start > All Programs > Marvell > Virtual Cable Tester**.
2. Click **Virtual Cable Tester** from the menu to display the screen below.

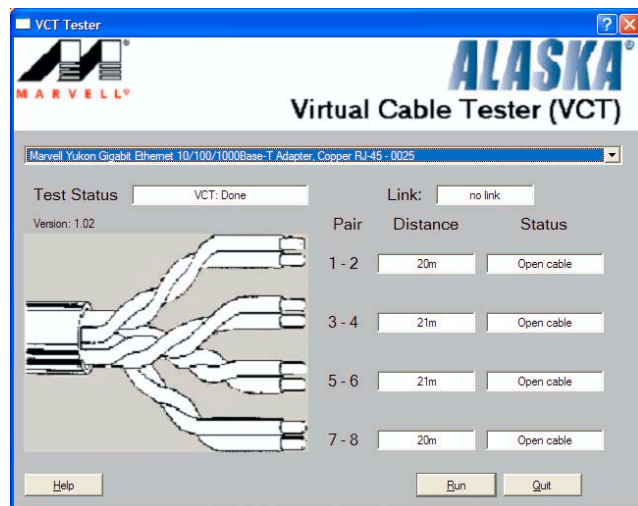

3. Click the **Run** button to perform a cable test.



- The VCT only runs on systems with Windows® XP or Windows® 2000 operating systems.
- The **Run** button on the Virtual Cable Tester™ main window is disabled if no problem is detected on the LAN cable(s) connected to the LAN port(s).
- If you want the system to check the LAN cable before entering the OS, enable the **POST Check LAN cable** item in the BIOS. See section “4.4.3 LAN2 Cable Status” for details.

### 5.3.3 Audio configurations

The Realtek® ALC850 AC '97 audio CODEC provides 8-channel audio capability to deliver the ultimate audio experience on your PC. The software provides Jack-Sensing function (Line-In, Line-Out, Mic-In), S/PDIF out support and interrupt capability. The ALC850 also includes the Realtek® proprietary UAJ® (Universal Audio Jack) technology for three ports (Line-In, Line-Out and Mic-In), eliminating cable connection errors and giving users plug and play convenience.

Follow the installation wizard to install the **Realtek ALC850 Audio Driver and Application** from the support CD that came with the motherboard package.

If the Realtek audio software is correctly installed, you will find the SoundEffect icon on the taskbar.

From the taskbar, double-click on the **SoundEffect** icon to display the **Realtek Audio Control Panel**.



Realtek SoundEffect icon



The Jack-sensing and UAJ® technology features are supported on the Line-In, Line-Out, and Mic jacks only.

### Sound Effect options

The Realtek® ALC850 Audio CODEC allows you to set your listening environment, adjust the equalizer, set the karaoke, or select pre-programmed equalizer settings for your listening pleasure.

To set the sound effect options:

1. From the Realtek Audio Control Panel, click the **Sound Effect** button.
2. Click the shortcut buttons to change the acoustic environment, adjust the equalizer, or set the karaoke to your desired settings.
3. The audio settings take effect immediately after you click on the buttons.
4. Click the Exit (  ) button on the upper-right hand corner of the window to exit.



## S/PDIF option

The Sony/Philips Digital Interface (S/PDIF) options allows you to change your S/PDIF output settings.

To set the S/PDIF options:

1. From the Realtek Audio Control Panel, click the **SPDIF** button.
2. Click the option buttons to change your S/PDIF out settings.
3. Click the Exit (  ) button on the upper-right hand corner of the window to exit.



## Speaker Configuration

This option allows you to set your speaker configuration.

To set the speaker configuration:

1. From the Realtek Audio Control Panel, click the **Speaker Configuration** button.
2. Select from the combo list box your current speaker setup, then click **Auto Test** to test your settings.
3. Click the **UAJ Automatic** button to enable or disable the Universal Audio Jack(UAJ<sup>®</sup>) technology feature.
4. Click the Exit (  ) button on the upper-right hand corner of the window to exit.



## AI Audio feature

The AI Audio feature works through the connector sensing option that allows you to check if your audio devices are connected properly.

To start the connector sensing:

1. From the Realtek Audio Control Panel, click the **Connector Sensing** button.
2. Click the **Bracket** button to display connected audio devices.
3. Click the **Option** button to change sensing options.
4. Click the **Start** button to start connection sensing. A progress bar displays current connector sensing status.



---

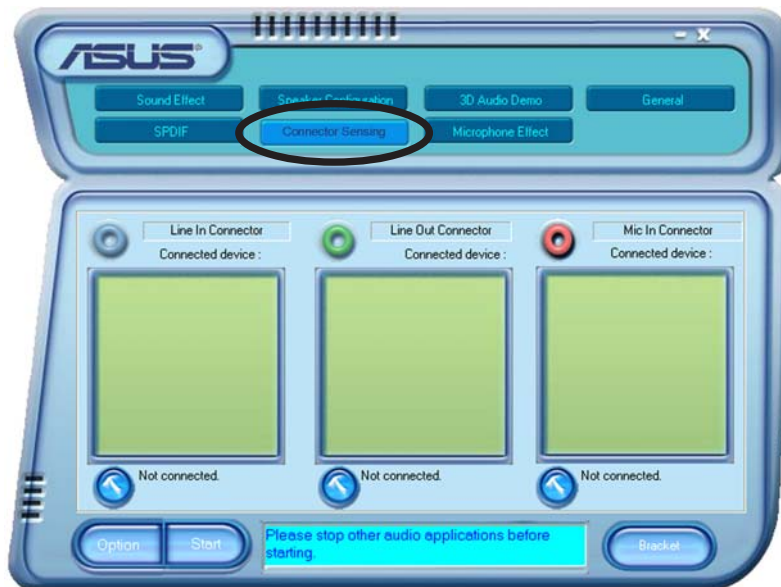

Make sure to exit all audio applications before starting this function.

---

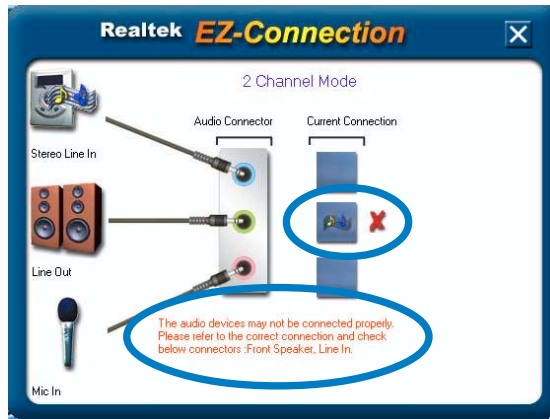

5. When finished, the utility prompts the Realtek® EZ-connection dialog box showing your current audio connections. The text at the bottom of the box explains your audio connection status. An *X* mark denotes an incorrect connection.



6. If there are detected problems, make sure that your audio cables are connected to the proper audio jack and repeat connector sensing.
7. Click the  button to exit EZ-connection dialog box.
8. Click the Exit () button on the upper-right hand corner of the window to exit.

### 3D Audio Demo

This option shows a demo of the 3D audio feature.

To start the 3D audio demo:

1. From the Realtek Audio Control Panel, click the **3D Audio Demo** button.
2. Click the option buttons to change the sound, moving path or EAX settings.
3. Click the **Play** button to start or the **Stop** button to stop.
4. Click the Exit () button on the upper-right hand corner of the window to exit.



## General settings

This option shows the audio settings and allows you to change the language setting or toggle the SoundEffect icon display on the Windows taskbar.

To display the general settings:

1. From the Realtek Audio Control Panel, click the **General** button.
2. Click the option button to enable or disable the icon display on the Windows taskbar.
3. Click the **Language** combo list box to change language display.
4. Click the Exit (  ) button on the upper-right hand corner of the window to exit.

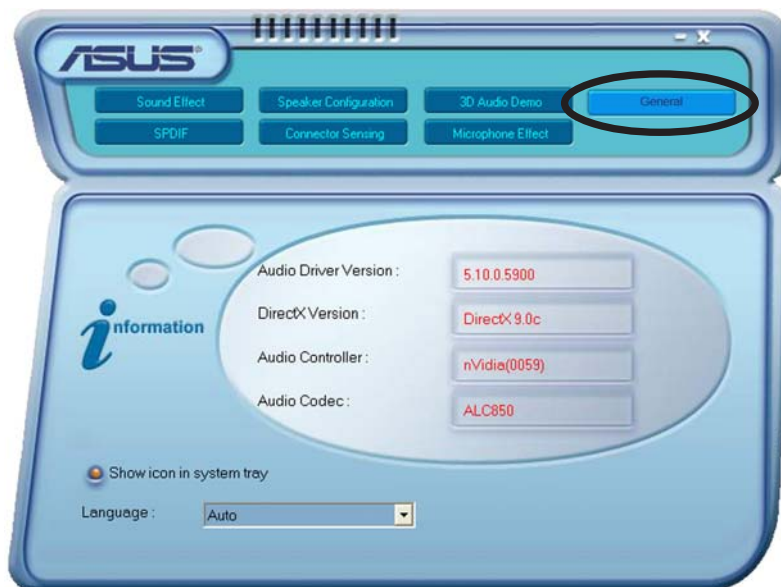

## Rear panel audio ports function variation

The functions of the Line Out (lime), Line In (blue), Mic (pink), Rear Speaker Out (gray), Side Speaker Out (black), and Center/Subwoofer (yellow orange) ports on the rear panel change when you select the 4-channel, 6-channel or 8-channel audio configuration as shown in the following table. See the “Audio 8, 6, 4 or 2-channel configuration” on page 2-24 for details.



### 5.3.4 Using the NVIDIA® Firewall™

The motherboard supports the NVIDIA® Firewall™ (NVFirewall™) application that protects your computer from intruders. The NVFirewall™ is classified as a personal firewall or desktop firewall that works at the device level to protect your system from malicious computer code by controlling the connections to and from your computer and alerting you for attempted intrusions. The following sections describe how to use the NVIDIA® Firewall™.

#### Launching the NVFirewall™ summary

After you install the NVFirewall™ application from the motherboard support CD, it is automatically activated with a **Medium** security profile as its default setting. The setup summary of NVFirewall™ is displayed in the summary menu.

To launch the NVFirewall™ summary menu:

1. Click the **NVIDIA® Firewall™ icon** from the Windows® taskbar.



NVIDIA® Firewall™ icon

2. Double-click the icon to display the NVFirewall™ Summary menu.

Click to select firewall profile

Click to view profile details

Click to view the firewall log

Click to view the firewall stats



## Setting security profiles

The NVFirewall™ application allows several security profiles to match your system security needs. The following describes the NVFirewall™ security profiles:

- **Low** - allows safe incoming connections and deny those that are known to be dangerous connections. This profile also enables some anti-hacking features.
- **Medium** - blocks most incoming connections. Incoming connections to some ports must be set to allow file transfers using some online messaging applications. This profile also enables some anti-hacking features.
- **High** - allows the least traffic through. Only outbound connections are allowed. This profile also includes the “stealth mode” feature that makes your system invisible to intruders. This also enables some anti-hacking features.
- **Lockdown** - blocks all incoming and outgoing connections.
- **Anti-hacking only** - this profile enables all anti-hacking features but disables the firewall. This security profile is useful if you want to use a third-party firewall application.
- **Custom 1, 2, 3** - these are reserved for customized profiles.
- **Off** - deactivates the firewall.

To set a security profile:

1. From the NVFirewall™ summary menu, click the **Current Firewall Profile** combo list box then select a security profile. The following confirmation box appears.
2. Click **Change Profile** to apply settings or **Don't Change Profile** to return to previous menu.



## Turning the NVFirewall™ off



Take caution when using this option, your computer becomes vulnerable to viruses, hackers or intruders after you turn off the firewall.

To turn off the NVFirewall™:

1. From the NVIDIA Firewall™ summary menu, click the **Current Firewall Profile** combo list box then select **Off**. The following confirmation box appears.

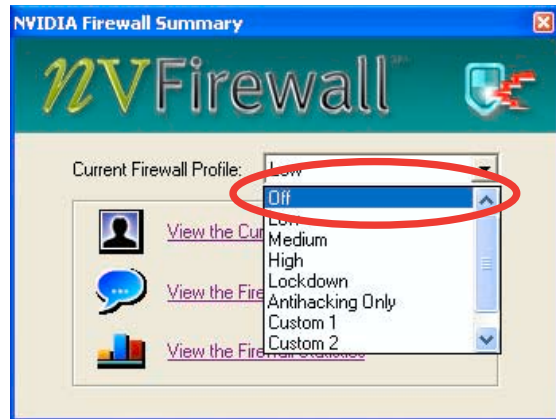

2. Click **Turn Firewall OFF**.

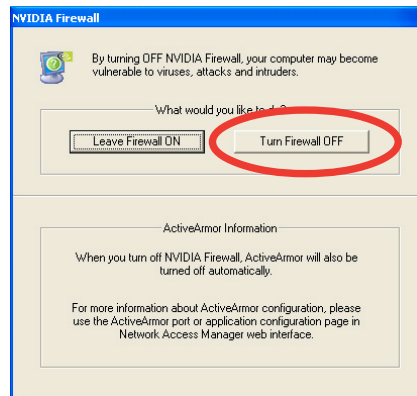

## 5.3.5 Using the Wireless LAN module



- The wireless LAN module is an optional item.
- For detailed information on using the Wireless LAN module, view/download the RTL8187 Wireless LAN User's Manual on the motherboard support CD.

The wireless IEEE 802.11 b/g LAN module is installed on the rear panel.

### Wi-Fi antenna

The wireless LAN port on the module accommodates a moveable omni-directional dual-band antenna to maximize your wireless coverage.



To install the antenna:

1. Locate the wireless LAN antenna port on the rear panel.
2. Connect the antenna twist-on connector (female) to the wireless LAN antenna port (male).
3. Place the antenna at an elevated location to enhance your wireless coverage.



- Do not place the antenna under your table or in a closed compartment.
- The speed of wireless transmission decreases as you move farther from the access point. To achieve faster data transmission, minimize the distance between the antenna and the access point (Infrastructure mode) or other wireless device.

### Operating range

The operating range is dependent on the operating environment. Every home or office layout varies in obstacles, barriers, or wall types that could reflect or absorb radio signals. For example, two wireless devices in an open space can achieve an operating distance of up to 200 ft, while the same devices can only achieve up to 80 ft when used indoors.

By default, the device automatically adjusts the data rate to maintain an operational wireless transmission. Therefore, a wireless device that is close to the access point may operate at higher speeds while a wireless device far from the access point may operate at lower speeds.

## Driver installation



If you are using a Windows® operating system, your computer auto-detects the wireless LAN module during start-up and displays an **Add New Hardware Wizard** window. Click **Cancel** then proceed with the following instructions.

To install the wireless LAN driver:

1. Place the WiFi-TV card support CD into the optical drive.
2. The CD automatically displays the Drivers menu.
3. Click **Realtek RTL8187 Wireless Ethernet Driver**.

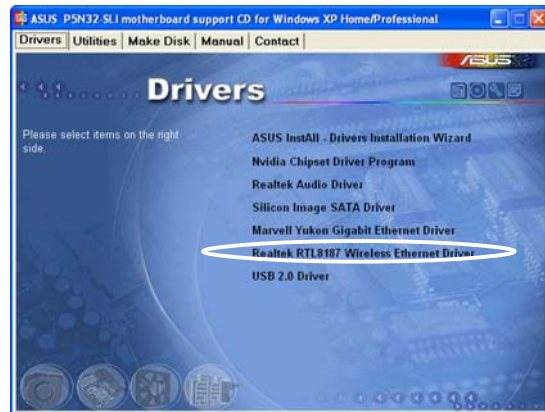

4. The **Realtek RTL8187 Wireless Network Driver and Utility** installation window appears. Click **Next**.

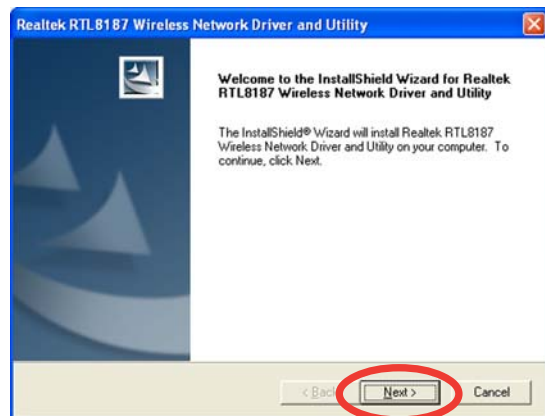

4. Follow succeeding screen instructions to complete installation.
6. When finished, restart your computer.

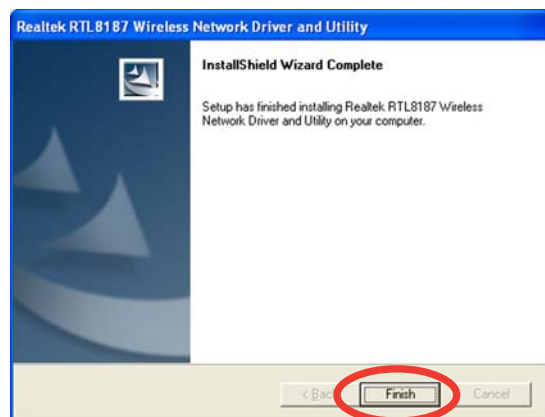

## Network setup

You can use the wireless LAN module in various wireless network configurations. After installing the wireless LAN adapter drivers to your computer, select the most appropriate configuration for your home or office wireless network.

To set up a wireless network:

1. Launch the Realtek RTL8187 Wireless Network Driver and Utility by double-clicking the icon on your desktop.



2. The **Wireless LAN Utility-RtWLAN** opens. Click the **Wi-Set** item.

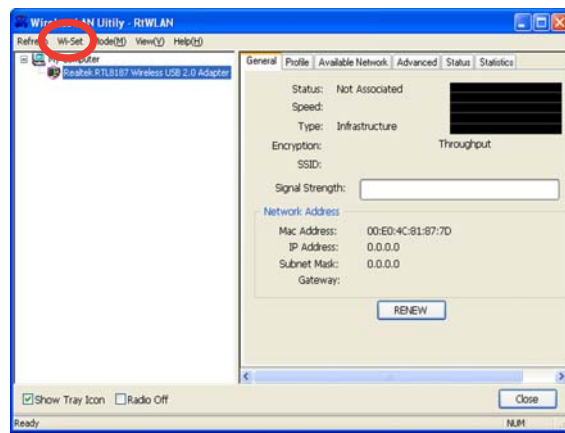

3. Select the Operation Mode. **Station** allows you to connect to a wireless network. **AP** allows you to set up a wireless network. Follow succeeding screen instructions and key in values for the required parameters.

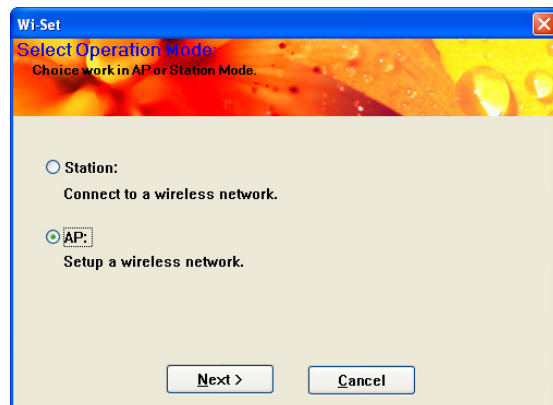

4. Click **Finish** to complete setup.

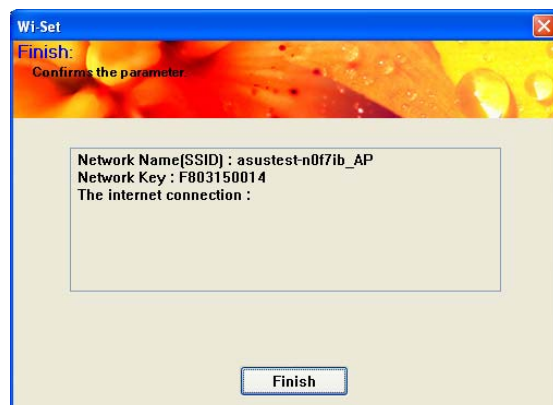

## Configuration options

Below are some of the wireless network configurations that you can use for your wireless LAN module.



---

The following descriptions are for reference only and may not exactly match your actual network configuration.

---

### *Ad-hoc mode*

When in **Ad-hoc** mode, the wireless LAN module connects to another wireless device (also called a **station**) within its operating range. Select this configuration when no access point (AP) is present in your wireless network.

### *Infrastructure mode*

In **Infrastructure** mode, the wireless network is centered on an access point (AP) that provides a central link for wireless clients to communicate with each other or with a wired network.

In this setup, the wireless LAN module functions as a wireless client/station that connects to an AP to establish connection to a wired or wireless LAN.

### *Software Access Point (Soft AP)*

In this mode, the wireless LAN module becomes the access point that connects wireless clients to the Internet or network printer.

Set to this mode if you are using Windows® 2000/XP/2003 Server operating system. The Soft AP feature can support an unlimited number of wireless clients and is ideal for homes with several computers but with only a single Internet connection and/or one printer.

### *Wireless bridge (Wireless Distribution System)*

In this setup, the wireless LAN module connects two or more APs while maintaining connection to its wireless clients. The wireless bridge feature is a cost-effective solution that integrates several wireless networks.

## 5.4 RAID configurations

The motherboard comes with the Silicon Image Sil3132 and the NVIDIA® nForce™ 4 SLI Southbridge RAID controllers that allow you to configure Serial ATA hard disk drives as RAID sets. The motherboard supports the following RAID configurations.

**RAID 0** (*Data striping*) optimizes two identical hard disk drives to read and write data in parallel, interleaved stacks. Two hard disks perform the same work as a single drive but at a sustained data transfer rate, double that of a single disk alone, thus improving data access and storage. Use of two new identical hard disk drives is required for this setup.

**RAID 1** (*Data mirroring*) copies and maintains an identical image of data from one drive to a second drive. If one drive fails, the disk array management software directs all applications to the surviving drive as it contains a complete copy of the data in the other drive. This RAID configuration provides data protection and increases fault tolerance to the entire system. Use two new drives or use an existing drive and a new drive for this setup. The new drive must be of the same size or larger than the existing drive.

**RAID 0+1** is *data striping* and *data mirroring* combined without parity (redundancy data) having to be calculated and written. With the RAID 0+1 configuration you get all the benefits of both RAID 0 and RAID 1 configurations. Use four new hard disk drives or use an existing drive and three new drives for this setup.

**RAID 5** stripes both data and parity information across three or more hard disk drives. Among the advantages of RAID 5 configuration include better HDD performance, fault tolerance, and higher storage capacity. The RAID 5 configuration is best suited for transaction processing, relational database applications, enterprise resource planning, and other business systems. Use a minimum of three identical hard disk drives for this setup.

**RAID 10** is a striped configuration with each stripe a RAID 1 array of drives. It combines the features of both RAID 1 and RAID 0. Fault tolerance is provided through *mirroring* while adding performance through *striping*. This offers higher performance than a RAID 1 configuration but at a much higher cost. A minimum of four hard disk drives is required for this setup.

**JBOD** (*Spanning*) stands for **Just a Bunch of Disks** and refers to hard disk drives that are not yet configured as a RAID set. This configuration stores the same data redundantly on multiple disks that appear as a single disk on the operating system. Spanning does not deliver any advantage over using separate disks independently and does not provide fault tolerance or other RAID performance benefits.





---

If you want to boot the system from a hard disk drive included in a RAID set, copy first the RAID driver from the support CD to a floppy disk before you install an operating system to a selected hard disk drive. Refer to section “5.6 Creating a RAID driver disk” for details.

---

## 5.4.1 Installing hard disks

The motherboard supports Ultra DMA 133/100/66 and Serial ATA hard disk drives. For optimal performance, install identical drives of the same model and capacity when creating a disk array.

### Installing Serial ATA (SATA) hard disks

To install the SATA hard disks for a RAID configuration:

1. Install the SATA hard disks into the drive bays.
2. Connect the SATA signal cables.
3. Connect a SATA power cable to the power connector on each drive.



---

Refer to the RAID controllers user manual in the motherboard support CD for detailed information on RAID configurations. See section “5.2.4 Manuals menu.”

---

## 5.4.2 NVIDIA® RAID configurations

The motherboard includes a high performance IDE RAID controller integrated in the NVIDIA® nForce™ 4 SLI southbridge chipset. It supports RAID 0, RAID 1, RAID 0+1, RAID 5 and JBOD for four independent Serial ATA channels.

### Setting the BIOS RAID items

After installing the hard disk drives, make sure to set the necessary RAID items in the BIOS before setting your RAID configuration.

To set the BIOS RAID items:

1. Boot the system and press <Del> during the Power-On Self-Test (POST) to enter the BIOS Setup Utility.
2. From the **Main > IDE Configuration** menu item in the BIOS set the **nVidia RAID Function** item to Enabled.
3. Select and enable the IDE or SATA drive(s) that you want to configure as RAID. See section “4.3.7 IDE Configuration” for details.
4. Save your changes and Exit Setup.



---

Make sure to re-enter your NVRAID settings after the CMOS is cleared; otherwise, the system will not recognize your RAID setup.

---



- For detailed descriptions on the NVIDIA® RAID configuration, refer to the “NVIDIA® RAID User’s Manual” found in your motherboard support CD.
  - When using Windows 2000 operating system, make sure to install the Windows 2000 Service Pack 4 or later versions.
-

## Entering the NVIDIA® RAID utility

To enter the NVIDIA® RAID utility:

1. Boot up your computer.
2. During POST, press <F10> to display the main menu of the utility.



The RAID BIOS setup screens shown in this section are for reference only, and may not exactly match the items on your screen.

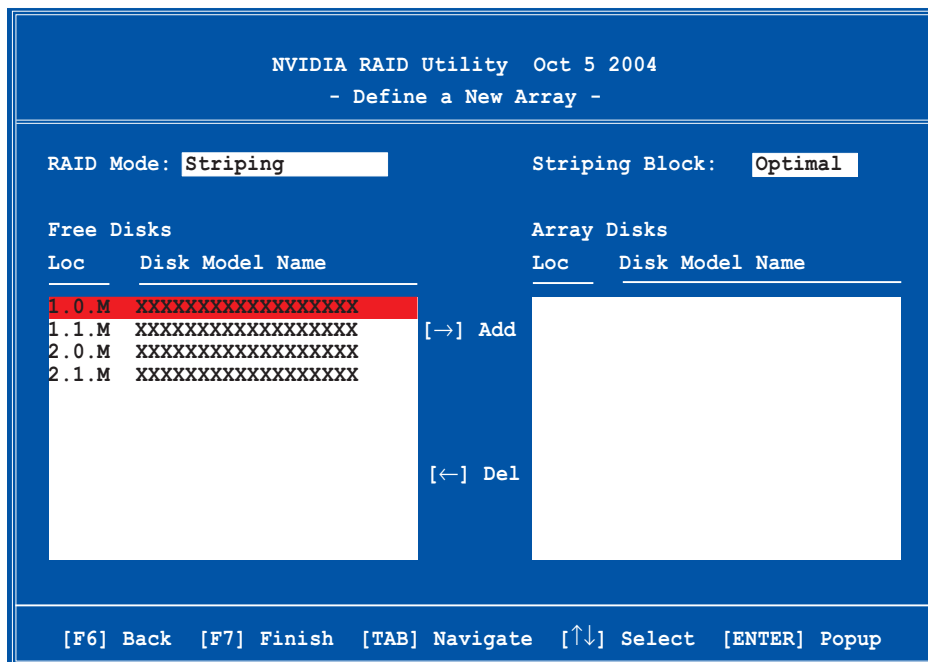

At the bottom of the screen are the navigation keys. These keys allow you to move through and select menu options.

## Creating a RAID Volume

To create a RAID volume:

1. From the NVIDIA® RAID utility Define a New Array menu, select **RAID Mode** then press <Enter>. The following submenu appears.

Use the up or down arrow keys to select a RAID mode then press <Enter>.

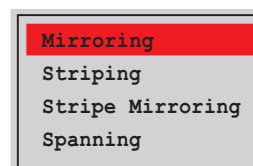

2. Press <TAB> select the Striping Block then press <Enter>. The following submenu appears:

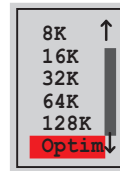

If you selected Striping or Stripe Mirroring, use the up or down arrow keys to select the stripe size for your RAID 0 array then press <Enter>. The available values range from 8 KB to 128 KB. The default selection is 128 KB. The strip value should be chosen based on the planned drive usage.

- 8 /16 KB - low disk usage
- 64 KB - typical disk usage
- 128 KB - performance disk usage



---

**TIP:** For server systems, we recommend using a lower array block size. For multimedia computer systems used mainly for audio and video editing, we recommend a higher array block size for optimum performance.

---

3. Press <TAB> to select the Free Disks area. Use the left or right arrow keys to assign the array disks.
4. Press <F7> to create RAID set. The following message box appears.

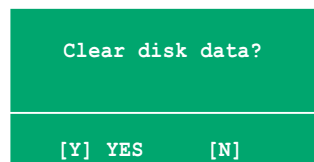

5. Press <Y> to clear the selected disks or <N> to proceed without clearing the disks. The following screen appears.



---

Take caution in using this option. All data on the RAID drives will be lost!

---

```

NVIDIA RAID Utility  Oct 5 2004
- Array List -

  Boot  Id  Status  Vendor  Array Model Name
  ----  --  -
  No    4  Healthy  NVIDIA  MIRROR  XXX.XXG

[Ctrl-X]Exit  [↑↓]Select  [B]Set Boot  [N]New Array  [ENTER]Detail

```

A new set of navigation keys is displayed on the bottom of the screen.

6. Press <Ctrl+X> to save settings and exit.

## Rebuilding a RAID array

To rebuild a RAID array:

1. From the Array List menu, use the up or down arrow keys to select a RAID array then press <Enter>. The RAID Array details appear.

```

Array 1 : NVIDIA MIRROR  XXX.XXG
- Array Detail -

RAID Mode: Mirroring
Striping Width: 1          Striping Block: 64K

  Adapt  Channel  M/S      Index  Disk Model Name      Capacity
  ----  -
  2       1       Master   0      XXXXXXXXXXXXXXXXXXXX  XXX.XXGB
  1       0       Master   1      XXXXXXXXXXXXXXXXXXXX  XXX.XXGB

[R] Rebuild  [D] Delete  [C] Clear Disk  [ENTER] Return

```

A new set of navigation keys is displayed on the bottom of the screen.

2. Press <R> to rebuild a RAID array. The following screen appears.

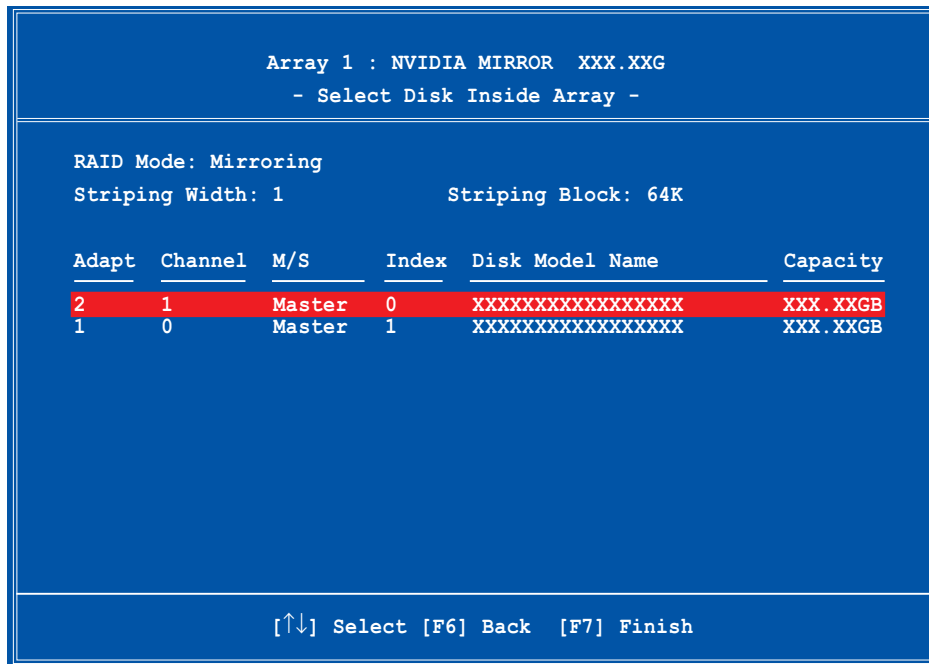

3. Use the up or down arrow keys to select a RAID array to rebuild, then press <F7>. The following confirmation message appears.

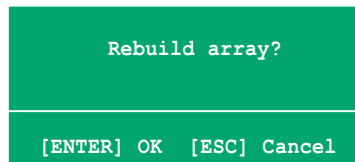

4. Press <Enter> to start rebuilding array or press <Esc> to cancel.
5. After the rebuild process, the Array list menu appears.

## Deleting a RAID array

To delete a RAID array:

1. From the Array List menu, use the up or down arrow keys to select a RAID array then press <Enter>. The RAID Array details appear.

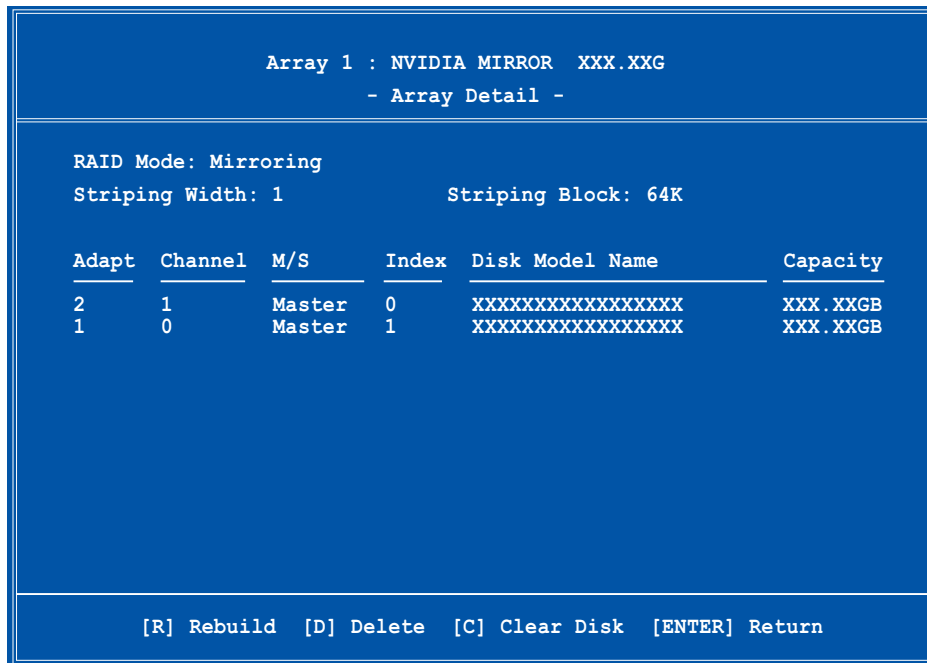

A new set of navigation keys is displayed on the bottom of the screen.

2. Press <D> to delete a RAID array. The following confirmation message appears.

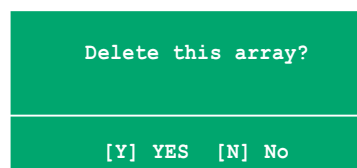

3. Press <Y> to delete array or press <N> to cancel.



Take caution in using this option. All data on the RAID drives will be lost!

4. If you selected Yes, the Define a New Array menu appears.

## Clearing a disk data

To clear disk data:

1. From the Array List menu, use the up or down arrow keys to select a RAID array then press <Enter>. The RAID Array details appear.

```
Array 1 : NVIDIA MIRROR XXX.XXG
- Array Detail -

RAID Mode: Mirroring
Striping Width: 1          Striping Block: 64K

Adapt Channel M/S Index Disk Model Name Capacity
2         1   Master 0   XXXXXXXXXXXXXXXXXXXX XXX.XXGB
1         0   Master 1   XXXXXXXXXXXXXXXXXXXX XXX.XXGB

[R] Rebuild [D] Delete [C] Clear Disk [ENTER] Return
```

A new set of navigation keys is displayed on the bottom of the screen.

2. Press <C> to clear disk. The following confirmation message appears.

```
Clear disk data?

[Y] YES [N]
```

5. Press <Y> to clear the disk data or press <N> to cancel.



Take caution in using this option. All data on the RAID drives will be lost!



### 5.4.3 Silicon Image RAID configurations

The Silicon Image RAID controller supports RAID 0 and RAID 1 configurations. Use the Silicon Image RAID utility to configure a disk array.

#### Setting the BIOS RAID items

After installing the hard disk drives, make sure to set the necessary RAID items in the BIOS before setting your RAID configuration.

To set the BIOS RAID items:

1. Boot the system and press <Del> during the Power-On Self-Test (POST) to enter the BIOS Setup Utility.
2. From the **Advanced > Onboard Devices Configuration** menu item in the BIOS set the **Silicon Image Controller** item to RAID Mode. See section “4.4.6 Onboard Devices Configuration” for details.
3. Save your changes and Exit Setup.

#### Launching the Silicon Image Array Management Software

Launch the Silicon Image Array Management software from Windows® XP by clicking the **Start** button and selecting **All Programs > Silicon Image > Sam**



---

For details on the Silicon Image SATAraid™ RAID configuration, refer to the “Sil3132 SATA RAID User’s Manual” in your motherboard support CD.

---

## Entering the Silicon Image BIOS RAID Configuration Utility

To enter the Silicon Image BIOS RAID configuration utility:

1. Boot up your computer.
2. During POST, press <Ctrl+S> or <F4>.



The RAID BIOS setup screens shown in this section are for reference only, and may not exactly match the items on your screen.

```
RAID Configuration Utility - Silicon Image Inc. Copyright (C) 2004

MAIN MENU
-----
Create RAID set
Delete RAID set
Rebuild Raid1 set
Resolve Conflicts
Low Level Format
Logical Drive Info

HELP
-----
Press "Enter" to create
RAID set

PHYSICAL DRIVE
-----
0  XXXXXXXXXXXX          XXXXXMB
1  XXXXXXXXXXXX          XXXXXMB
2  XXXXXXXXXXXX          XXXXXMB
3  XXXXXXXXXXXX          XXXXXMB

LOGICAL DRIVE
-----
STXXXXXXXXXX          XXXXXMB
STXXXXXXXXXX          XXXXXMB
STXXXXXXXXXX          XXXXXMB
STXXXXXXXXXX          XXXXXMB

↑↓:Select Menu  ESC:Previous Menu  Enter:Select  Ctrl-E:Exit
```

The Main Menu on the upper left corner allows you to select an operation to be performed. The Main Menu options include the following:

**Create RAID set** - creates a new legacy RAID set or allocates spare drives.

**Delete RAID set** - deletes a RAID set or deallocates a spare drive.

**Rebuild RAID1 set** - rebuilds a RAID 1 set (e.g., swapped drives).

**Resolve Conflicts** - automatically restores disrupted drives on a RAID set.

**Low Level Format** - creates a pattern of reference marks on a drive.

Formatting the disks erases all data previously stored in the drive.

**Logical Drive Info** - shows the current configuration of each RAID set.

On the upper right corner of the screen is the Help message box. The message describes the function of each menu item. At the bottom of the screen is the legend box. The keys on the legend box allow you to navigate through the setup menu options. The following lists the keys found in the legend box and their corresponding functions.

- ↑, ↓ : Select/Move to the next item
- ESC : Previous Menu
- Enter : Select
- Ctrl-E : Exit

## Creating a RAID 0 set (Striped)

To create a RAID set:

1. From the Silicon Image configuration utility main menu, select **Create RAID set** then press <Enter> to display an option menu.

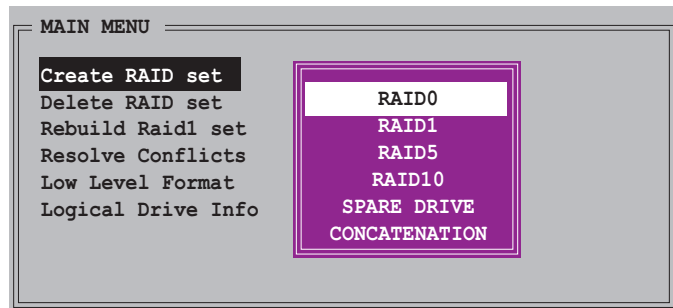

2. Select **RAID 0** then press <Enter> to display the following.

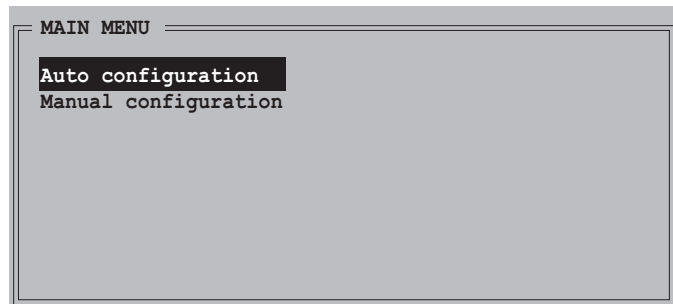

3. Select your desired method of configuration.  
**Auto configuration**
  - a. Select Auto Configuration the press <Enter>.
  - b. The utility prompts a message to input the RAID size, use the up or down arrow keys to set the RAID size then press <Enter>.
  - c. Press <Y> to confirm or <N> to return to the Main Menu.



By default, Auto configuration sets the stripe size to 64K and sets the logical drives based on the physical drives installed.

### Manual configuration

- a. Select **Manual configuration** and press <Enter>. The following pop-up menu appears.
- b. Use the up or down arrow keys to select a chunk size appropriate to your drive usage then press <Enter>.

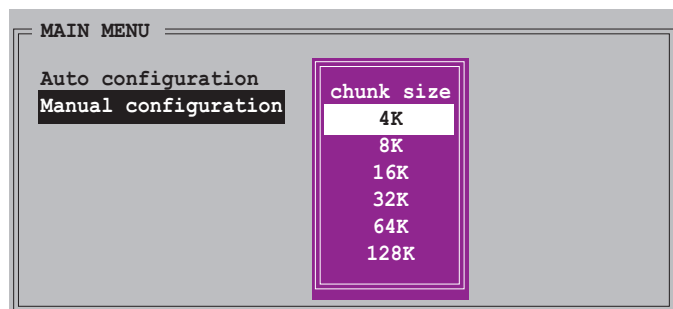



**TIP:** For server systems, we recommend using a lower array block size. For multimedia computer systems used mainly for audio and video editing, we recommend a higher array block size for optimum performance.

- c. The selection bar moves to the Physical Drive menu. Using the up or down arrow keys, select a drive then press <Enter> to set the first drive of the RAID set.

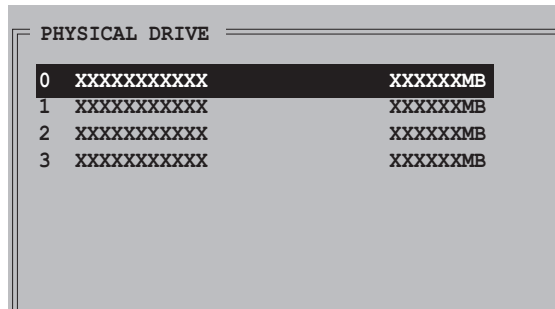

- d. Repeat step c to set the second, third, and fourth drive. The number of available drives depend on the installed and enabled physical drives in the system.
- e. The utility prompts a message to input the RAID size, use the up or down arrow keys to set the RAID size then press <Enter>.
- f. Press <Y> to confirm or <N> to return to the Main Menu.

## Creating a RAID 1 set (Mirrored)

To create a RAID 1 set:

1. From the Silicon Image configuration utility main menu, select **Create RAID set** then press <Enter>. The following sub-menu appears.

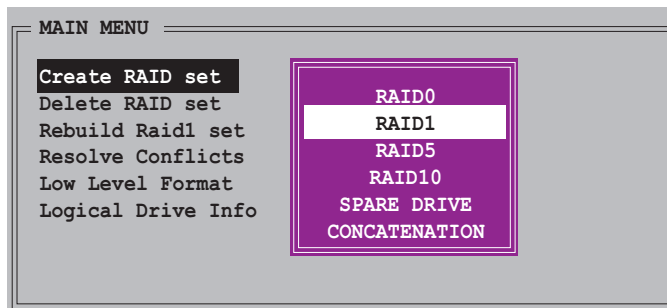

2. Select **RAID 1** then press <Enter> to display the following.

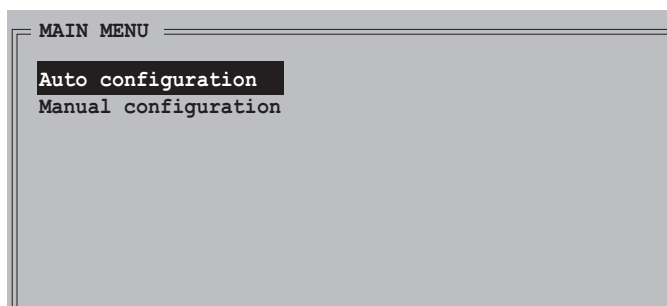

3. Select your desired method of configuration.

### Auto configuration

- a. Select Auto Configuration then press <Enter>.
- b. The utility prompts a message to input the RAID size, use the up or down arrow keys to set the RAID size then press <Enter>.
- c. Press <Y> to confirm or <N> to return to the Main Menu.



- Auto-configuration creates a RAID 1 set without a backup copy of the current source disk data.
- When migrating a single hard disk drive to a RAID 1 set, use of the Manual configuration is recommended.

### Manual configuration

- a. Select **Manual configuration** and press <Enter>. The selection bar moves to the Physical Drives menu.
- b. Using the up or down arrow keys, select the *source drive* and press <Enter>.
- c. Repeat step b to select the *target drive*.
- d. After selecting the source and target drives, the following pop-up menu appears.

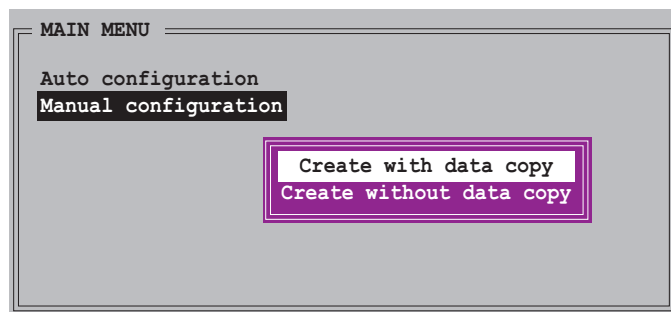
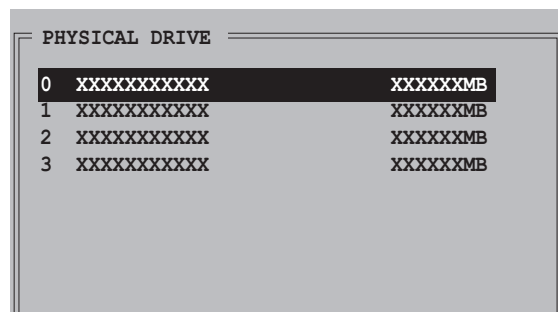

- The **Create with data copy** option allows you to copy the current data from the source drive to the mirror drive.
- Select **Create with data copy** if you have important data in your source drive.
- The **Create without data copy** option disables the disk copy function of the Mirrored set.
- If you selected **Create without data copy**, the RAID 1 set must be repartitioned and reformatted to guarantee the consistency of its contents.

- e. If you selected **Create with data copy**, the following pop-up menu appears.

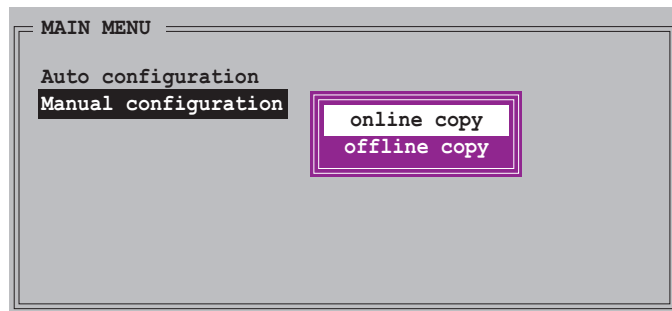

---

The **online copy** option automatically copies the data to the target drives on the background while writing to the source drives. The **offline copy** option allows you to copy the contents of the source drive to the target drives now.

---

- f. Use the up or down arrow keys to select desired copy method, then press <Enter>.
- g. The utility prompts a message to input the RAID size, use the up or down arrow keys to set the RAID size then press <Enter>.
- h. Press <Y> to confirm or <N> to return to the Main Menu.



---

A copy progress appears if you previously selected offline copy.

---

## Creating a CONCATENATION set

To create a CONCATENATION set:

1. From the Silicon Image configuration utility main menu, select **Create RAID set** then press <Enter>.
2. From the sub-menu Select **CONCATENATION** then press <Enter>.
3. The selection bar moves to the Physical Drive menu. Using the up or down arrow keys, select a drive then press <Enter> to set a drive for the RAID set.
4. The utility prompts a message to input the RAID size, use the up or down arrow keys to set the RAID size then press <Enter>.
5. Press <Y> to confirm or <N> to return to the Main Menu.

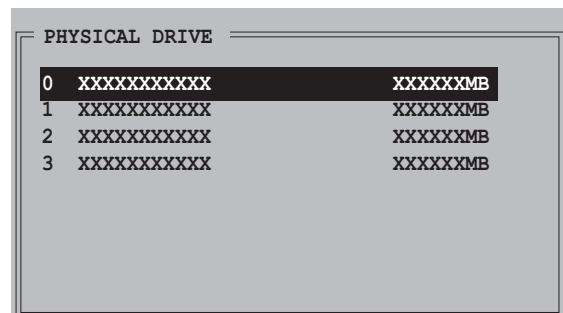
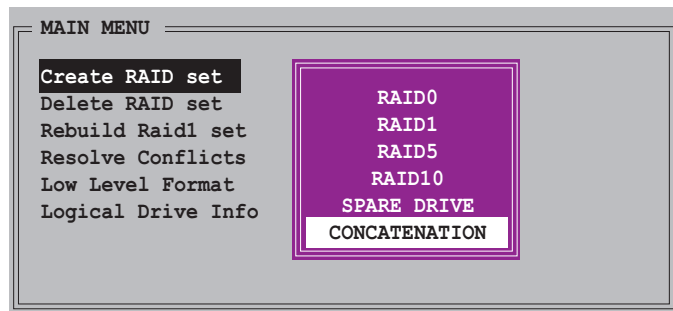

- Configure a CONCATENATION set when using a single Serial ATA drive; otherwise, the system will not recognize the drive.
- You can also create a RAID set using the SATARAID5 GUI utility under a Windows® environment.

## 5.5 Creating a RAID driver disk

A floppy disk with the RAID driver is required when installing Windows® 2000/XP operating system on a hard disk drive that is included in a RAID set.

To create a RAID driver disk:

1. Place the motherboard support CD into the CD-ROM drive.
2. Select **Make Disk** tab.
3. From the **Make Disk** menu, select the RAID driver disk you want to create or browse the contents of the support CD to locate the driver disk utility.



---

Refer to section “5.2.4 Make Disk menu” for details.

---

4. Insert floppy disk to floppy disk drive.
5. Follow succeeding screen information to complete process.
6. Write-protect the floppy disk to avoid computer virus infection.

To install the RAID driver:

1. During the OS installation, the system prompts you to press the F6 key to install third-party SCSI or RAID driver.
2. Press <F6> then insert the floppy disk with RAID driver into the floppy disk drive.
3. Follow the succeeding screen instructions to complete the installation.



---

Due to chipset limitation, the Serial ATA ports supported by the NVIDIA chipset doesn't support Serial Optical Disk Drives (Serial ODD) under DOS.

---



This chapter tells how to install  
SLI-ready PCI Express graphics cards.

**NVIDIA® SLI™**  
**technology**  
**support**



## Chapter summary

6.1	Overview .....	6-1
6.2	Dual graphics cards setup .....	6-2

## 6.1 Overview

The motherboard supports the NVIDIA® SLI™ (Scalable Link Interface) - Intel® Edition technology that allows you to install two identical PCI Express™ x16 graphics cards. Follow the installation procedures in this section.

### Requirements

- You should have two identical SLI-ready graphics cards that are NVIDIA® certified.
- Visit the ASUS website ([www.asus.com](http://www.asus.com)) for a list of qualified SLI-ready graphics cards for this motherboard.
- Make sure that your graphics card driver supports the NVIDIA SLI technology. Download the latest driver from the NVIDIA website ([www.nvidia.com](http://www.nvidia.com)).
- Make sure that your power supply unit (PSU) can provide at least the minimum power required by your system. See “13. ATX power connectors” on page 2-37 for details.



- 
- The NVIDIA SLI technology supports Windows® XP™ operating system only.
  - Due to chipset driver limitation, SLI mode is not supported under Windows® XP 64-bit edition.
  - Visit the NVIDIA zone website (<http://www.nzone.com>) for the latest certified graphics card and supported 3D application list.
-

## 6.2 Dual graphics card setup

### 6.2.1 Installing SLI-ready graphics cards



Install only identical SLI-ready graphics cards that are NVIDIA®-certified. Different types of graphics cards will not work together properly.

To install the graphics cards:

1. Prepare two graphics cards. Each graphics card should have goldfingers for the SLI connector.



Goldfingers

2. Remove the metal bracket covers opposite the two PCI Express x16 slots.

3. Insert one graphics card into either the blue or black slot. Make sure that the card is properly seated on the slot.



4. Insert the second graphics card into the other slot. Make sure that the card is properly seated on the slot.

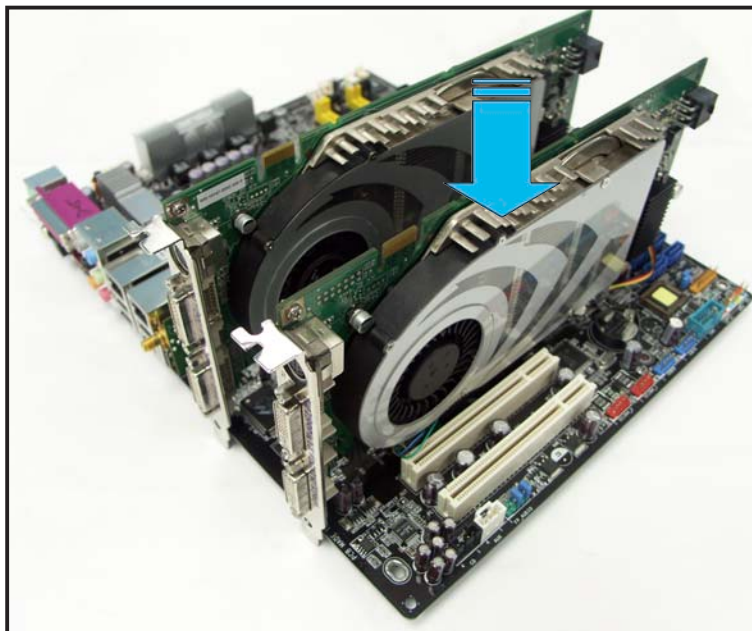

---

If required, connect an auxiliary power source to the PCI Express graphics cards.

---

- Align and insert the SLI connector to the goldfingers on each graphics card. Make sure that the connector is firmly in place.

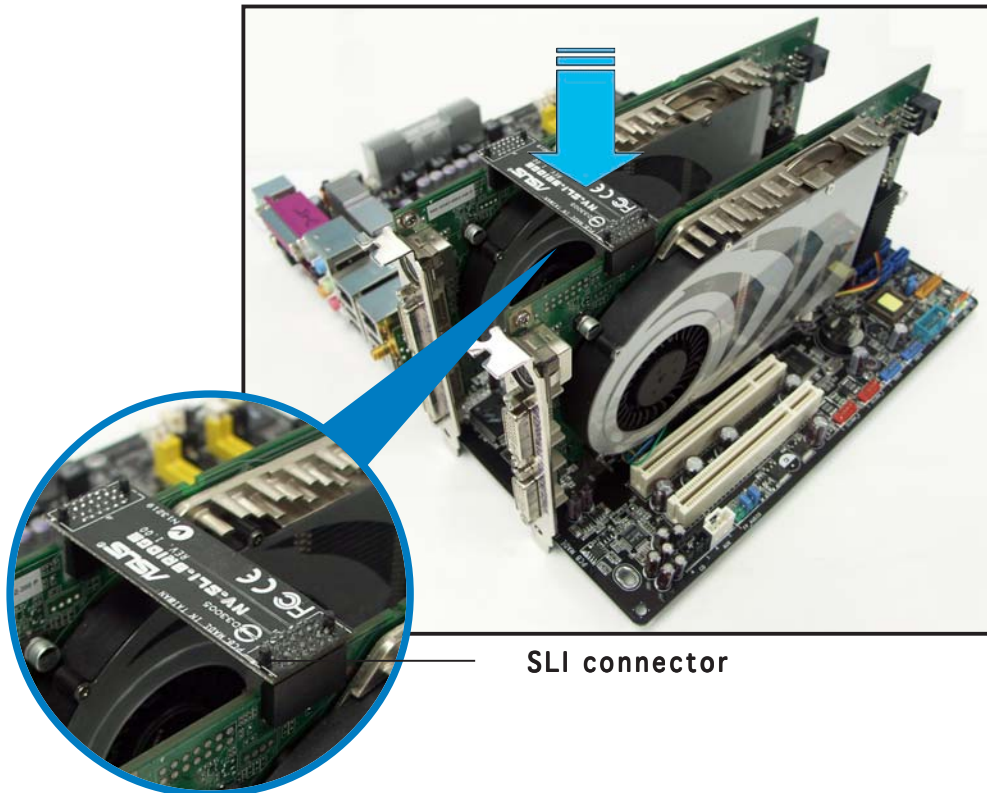

- Connect a 4-pin ATX power cable to the EZ Plug™ labeled **EZ\_PLUG** on your motherboard.



Make sure to connect a 4-pin ATX power cable to the EZ Plug; otherwise, the system will be unstable.

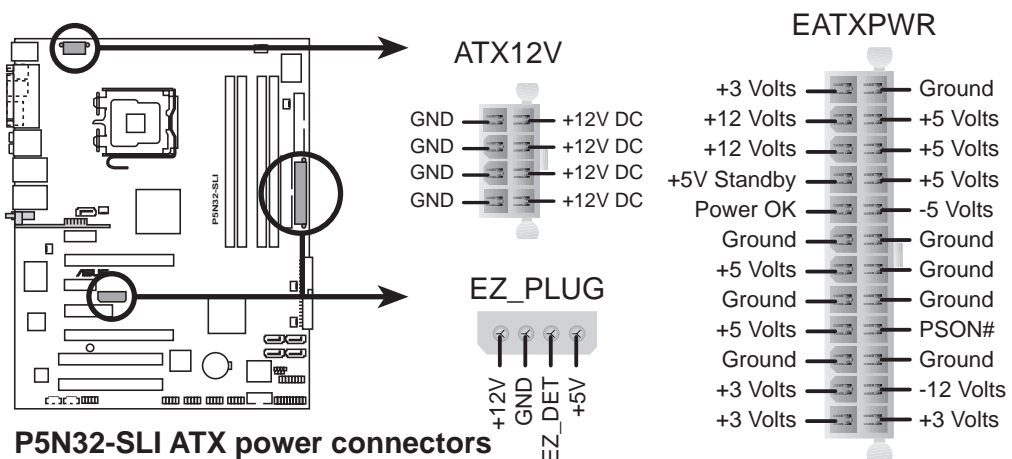

7. Align and insert the retention bracket into the slot then secure it with a screw.



---

Make sure that the retention bracket firmly supports the two graphics cards.

---

8. Connect a **VGA cable** or a **DVI-I cable** to the graphics card/s.



---

We recommend to install an additional chassis fan for better thermal environment.

---

## 6.2.2 Installing the device drivers

Refer to the documentation that came with your graphics card package to install the device drivers.



---

Make sure that your PCI Express graphics card driver supports the NVIDIA SLI technology. Download the latest driver from the NVIDIA website ([www.nvidia.com](http://www.nvidia.com)).

---

## 6.2.3 Enabling the multi-GPU feature in Windows®

After installing your graphics cards and the device drivers, enable the Multi-Graphics Processing Unit (GPU) feature in the NVIDIA nView properties.

To enable the multi-GPU feature:

1. Click the **NVIDIA Settings icon** on your Windows taskbar.



**NVIDIA Settings icon**

2. From the pop-up menu, select **nView Desktop Manager** then click **nView Properties**.

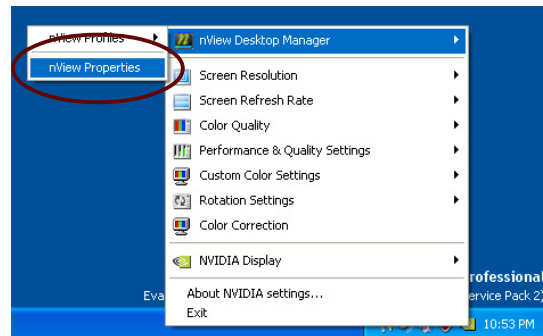



3. From the nView Desktop Manager window, select the **Desktop Management** tab.
4. Click **Properties** to display the Display Properties dialog box.

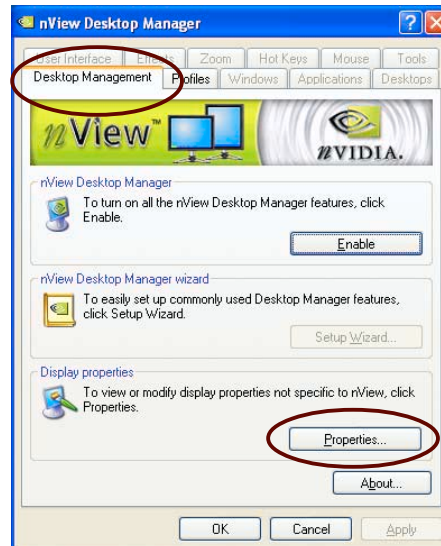

5. From the Display Properties dialog box, select the **Settings** tab then click **Advanced**.

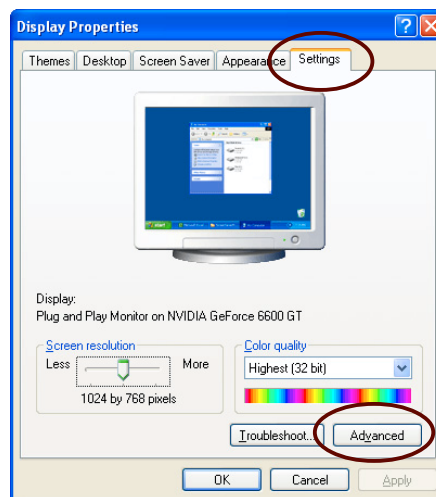

6. Select the **NVIDIA GeForce** tab.

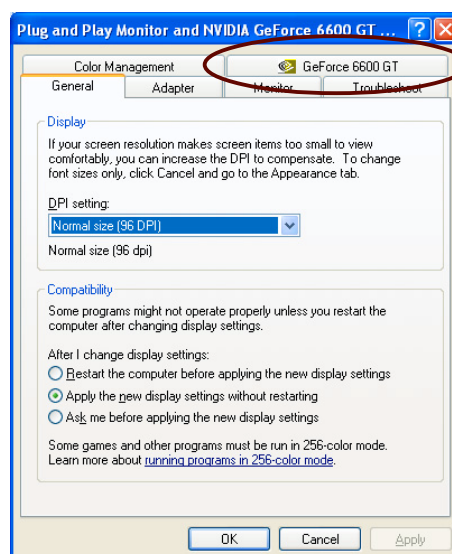

- Click the slider to display the following screen, then select the **SLI multi-GPU** item.

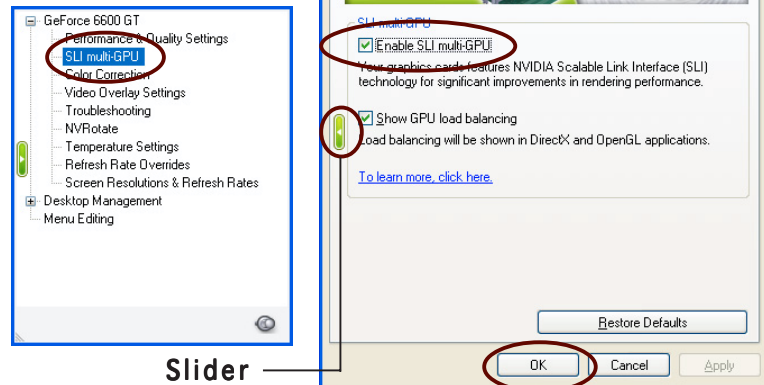

- Click the **Enable SLI multi-GPU** check box.
- Click **OK** when done.

The Appendix describes the CPU features that the motherboard supports.

# Appendix A CPU features

## Chapter summary



A.1	Intel® EM64T .....	A-1
A.2	Enhanced Intel SpeedStep® Technology (EIST) .....	A-1
A.3	Intel® Hyper-Threading Technology .....	A-3

## A.1 Intel® EM64T



- 
- The motherboard is fully compatible with Intel® Pentium® 4 LGA775 processors running on 32-bit operating systems.
  - The motherboard comes with a BIOS file that supports EM64T. You can download the latest BIOS file from the ASUS website ([www.asus.com/support/download/](http://www.asus.com/support/download/)) if you need to update the BIOS file. See Chapter 4 for details.
  - Visit [www.intel.com](http://www.intel.com) for more information on the EM64T feature.
  - Visit [www.microsoft.com](http://www.microsoft.com) for more information on Windows® 64-bit OS.
- 

### Using the Intel® EM64T feature

To use the Intel® EM64T feature:

1. Install an Intel® Pentium® 4 CPU that supports the Intel® EM64T.
2. Install a 64-bit operating system (Windows® XP Professional x64 Edition or Windows® Server 2003 x64 Edition).
3. Install the 64-bit drivers for the motherboard components and devices from the support CD.
4. Install the 64-bit drivers for expansion cards or add-on devices, if any.



---

Refer to the expansion card or add-on device(s) documentation, or visit the related website, to verify if the card/device supports a 64-bit system.

---

## A.2 Enhanced Intel SpeedStep® Technology (EIST)



- 
- The motherboard comes with a BIOS file that supports EIST. You can download the latest BIOS file from the ASUS website ([www.asus.com/support/download/](http://www.asus.com/support/download/)) if you need to update the BIOS. See Chapter 4 for details.
  - Visit [www.intel.com](http://www.intel.com) for more information on the EIST feature.
- 

### A.2.1 System requirements

Before using EIST, check your system if it meets the following requirements:

- Intel® Pentium® 4 processor with EIST support
- BIOS file with EIST support
- Operating system with EIST support (Windows® XP SP2/Windows® Server 2003 SP1/Linux 2.6 kernel or later versions)

## A.2.2 Using the EIST

To use the EIST feature:

1. Turn on the computer, then enter the BIOS Setup.
2. Go to the **Advanced Menu**, highlight **CPU Configuration**, then press <Enter>.
3. Set the **Intel(R) SpeedStep Technology** item to [Automatic], then press <Enter>.
4. Press <F10> to save your changes and exit the BIOS setup.
5. After the computer restarts, right click on a blank space on the desktop, then select **Properties** from the pop-up menu.
6. When the **Display Properties** window appears, click the **Screen Saver** tab.
7. Click the **Power** button on the Monitor power section to open the **Power Options Properties** window.

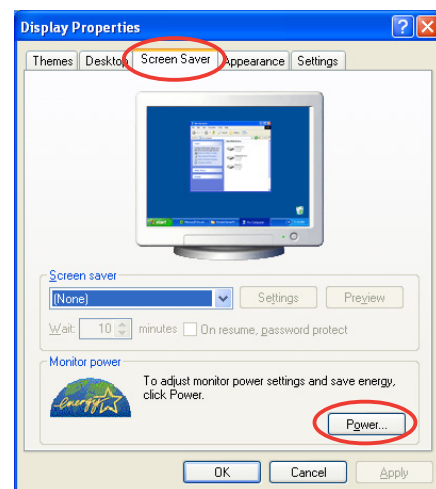

8. On the **Power schemes** section, click , then select any option except **Home/Office Desktop** or **Always On**.
9. Click **Apply**, then click **OK**.
10. Close the **Display Properties** window.

After you adjust the power scheme, the CPU internal frequency slightly decreases when the CPU loading is low.

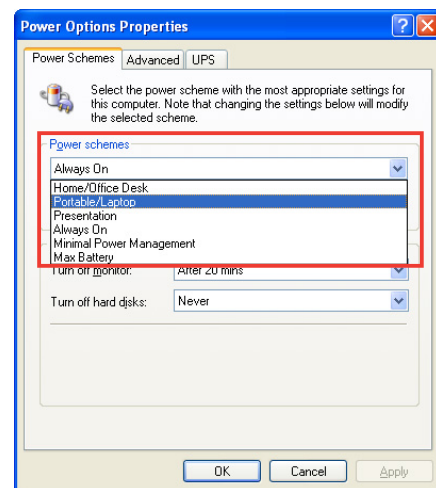

The screen displays and procedures may vary depending on the operating system.

## A.3 Intel® Hyper-Threading Technology

---



- The motherboard supports Intel® Pentium® 4 LGA775 processors with Hyper-Threading Technology.
  - Hyper-Threading Technology is supported under Windows® XP/2003 Server and Linux 2.4.x (kernel) and later versions only. Under Linux, use the Hyper-Threading compiler to compile the code. If you are using any other operating systems, disable the Hyper-Threading Technology item in the BIOS to ensure system stability and performance.
  - Installing Windows® XP Service Pack 1 or later version is recommended.
  - Make sure to enable the Hyper-Threading Technology item in BIOS before installing a supported operating system.
  - For more information on Hyper-Threading Technology, visit [www.intel.com/info/hyperthreading](http://www.intel.com/info/hyperthreading).
- 

### Using the Hyper-Threading Technology

To use the Hyper-Threading Technology:

1. Install an Intel® Pentium® 4 CPU that supports Hyper-Threading Technology.
2. Power up the system and enter the BIOS Setup. Under the **Advanced Menu**, make sure that the item **Hyper-Threading Technology** is set to **Enabled**.  
The BIOS item appears only if you installed a CPU that supports Hyper-Threading Technology.
3. Restart the computer.

