

**P5VD2-VM/  
P5V-VM SE DH**



# Motherboard

E2832

First Edition V1

October 2006

**Copyright © 2006 ASUSTeK COMPUTER INC. All Rights Reserved.**

No part of this manual, including the products and software described in it, may be reproduced, transmitted, transcribed, stored in a retrieval system, or translated into any language in any form or by any means, except documentation kept by the purchaser for backup purposes, without the express written permission of ASUSTeK COMPUTER INC. ("ASUS").

Product warranty or service will not be extended if: (1) the product is repaired, modified or altered, unless such repair, modification or alteration is authorized in writing by ASUS; or (2) the serial number of the product is defaced or missing.

ASUS PROVIDES THIS MANUAL "AS IS" WITHOUT WARRANTY OF ANY KIND, EITHER EXPRESS OR IMPLIED, INCLUDING BUT NOT LIMITED TO THE IMPLIED WARRANTIES OR CONDITIONS OF MERCHANTABILITY OR FITNESS FOR A PARTICULAR PURPOSE. IN NO EVENT SHALL ASUS, ITS DIRECTORS, OFFICERS, EMPLOYEES OR AGENTS BE LIABLE FOR ANY INDIRECT, SPECIAL, INCIDENTAL, OR CONSEQUENTIAL DAMAGES (INCLUDING DAMAGES FOR LOSS OF PROFITS, LOSS OF BUSINESS, LOSS OF USE OR DATA, INTERRUPTION OF BUSINESS AND THE LIKE), EVEN IF ASUS HAS BEEN ADVISED OF THE POSSIBILITY OF SUCH DAMAGES ARISING FROM ANY DEFECT OR ERROR IN THIS MANUAL OR PRODUCT.

SPECIFICATIONS AND INFORMATION CONTAINED IN THIS MANUAL ARE FURNISHED FOR INFORMATIONAL USE ONLY, AND ARE SUBJECT TO CHANGE AT ANY TIME WITHOUT NOTICE, AND SHOULD NOT BE CONSTRUED AS A COMMITMENT BY ASUS. ASUS ASSUMES NO RESPONSIBILITY OR LIABILITY FOR ANY ERRORS OR INACCURACIES THAT MAY APPEAR IN THIS MANUAL, INCLUDING THE PRODUCTS AND SOFTWARE DESCRIBED IN IT.

Products and corporate names appearing in this manual may or may not be registered trademarks or copyrights of their respective companies, and are used only for identification or explanation and to the owners' benefit, without intent to infringe.

# Contents

Notices.....	vi
Safety information .....	vii
About this guide .....	viii
P5VD2-VM/P5V-VM SE DH specifications summary.....	x

## Chapter 1: Product introduction

<b>1.1</b>	<b>Welcome!</b> .....	<b>1-2</b>
<b>1.2</b>	<b>Package contents</b> .....	<b>1-2</b>
<b>1.3</b>	<b>Special features</b> .....	<b>1-2</b>
	1.3.1 Product highlights .....	1-2
	1.3.2 Innovative ASUS features .....	1-4
	1.3.3 ASUS Digital Home for P5V-VM SE DH special features .....	1-5
<b>1.4</b>	<b>Before you proceed</b> .....	<b>1-7</b>
<b>1.5</b>	<b>Motherboard overview</b> .....	<b>1-8</b>
	1.5.1 Placement direction .....	1-8
	1.5.2 Screw holes .....	1-8
	1.5.3 Motherboard layout.....	1-9
<b>1.6</b>	<b>Central Processing Unit (CPU)</b> .....	<b>1-10</b>
	1.6.1 Installing the CPU .....	1-10
	1.6.2 Installing the CPU heatsink and fan .....	1-13
	1.6.3 Uninstalling the CPU heatsink and fan .....	1-15
<b>1.7</b>	<b>System memory</b> .....	<b>1-17</b>
	1.7.1 Overview .....	1-17
	1.7.2 Memory configurations.....	1-17
	1.7.3 Installing a DIMM .....	1-20
	1.7.4 Removing a DIMM .....	1-20
<b>1.8</b>	<b>Expansion slots</b> .....	<b>1-21</b>
	1.8.1 Installing an expansion card .....	1-21
	1.8.2 Configuring an expansion card .....	1-21
	1.8.3 Interrupt assignments .....	1-22
	1.8.4 PCI slots.....	1-23
	1.8.5 PCI Express x1 slot.....	1-23
	1.8.6 PCI Express x16 slot.....	1-23
<b>1.9</b>	<b>Jumpers</b> .....	<b>1-24</b>

# Contents

- 1.10 Connectors ..... 1-27**
  - 1.10.1 Rear panel connectors ..... 1-27
  - 1.10.2 Internal connectors ..... 1-29
  
- Chapter 2: BIOS setup**
- 2.1 Managing and updating your BIOS ..... 2-2**
  - 2.1.1 ASUS Update utility ..... 2-2
  - 2.1.2 Creating a bootable floppy disk ..... 2-5
  - 2.1.3 ASUS EZ Flash 2 utility ..... 2-6
  - 2.1.4 Updating the BIOS ..... 2-7
  - 2.1.5 ASUS CrashFree BIOS 2 utility ..... 2-9
- 2.2 BIOS setup program ..... 2-11**
  - 2.2.1 BIOS menu screen ..... 2-12
  - 2.2.2 Menu bar ..... 2-12
  - 2.2.3 Legend bar ..... 2-13
  - 2.2.4 Menu items ..... 2-13
  - 2.2.5 Sub-menu items ..... 2-13
  - 2.2.6 Configuration fields ..... 2-13
  - 2.2.7 Pop-up window ..... 2-14
  - 2.2.8 General help ..... 2-14
- 2.3 Main menu ..... 2-15**
  - 2.3.1 System Time ..... 2-15
  - 2.3.2 System Date ..... 2-15
  - 2.3.3 Legacy Diskette A ..... 2-15
  - 2.3.4 Primary and Secondary IDE Master/Slave ..... 2-16
  - 2.3.5 SATA 1/2 ..... 2-18
  - 2.3.6 HDD SMART Monitoring ..... 2-19
  - 2.3.7 Installed Memory ..... 2-19
  - 2.3.8 Usable Memory ..... 2-19
- 2.4 Advanced menu ..... 2-20**
  - 2.4.1 CPU Configuration ..... 2-20
  - 2.4.2 Chipset ..... 2-21
  - 2.4.3 PCIPnP ..... 2-23
  - 2.4.4 Onboard Devices Configuration ..... 2-25
  - 2.4.5 USB Configuration ..... 2-27

# Contents

<b>2.5</b>	<b>Power menu</b> .....	<b>2-28</b>
2.5.1	ACPI Suspend Type.....	2-28
2.5.2	ACPI APIC Support.....	2-28
2.5.3	APM Configuration.....	2-28
2.5.4	Hardware Monitor .....	2-31
<b>2.6</b>	<b>Boot menu</b> .....	<b>2-33</b>
2.6.1	Boot Device Priority .....	2-33
2.6.2	Removable Drives.....	2-33
2.6.3	Hard Disk Drives .....	2-34
2.6.4	Boot Settings Configuration .....	2-34
2.6.5	Security .....	2-36
<b>2.7</b>	<b>Tools menu</b> .....	<b>2-38</b>
2.7.1	ASUS EZ Flash 2.....	2-38
<b>2.8</b>	<b>Exit menu</b> .....	<b>2-39</b>

## Chapter 3: Software support

<b>3.1</b>	<b>Installing an operating system</b> .....	<b>3-2</b>
<b>3.2</b>	<b>Support CD information</b> .....	<b>3-2</b>
3.2.1	Running the support CD .....	3-2
3.2.2	Drivers menu.....	3-3
3.2.3	Utilities menu .....	3-4
3.2.4	Make Disk menu .....	3-5
3.2.5	Manuals menu .....	3-5
3.2.6	ASUS Contact information .....	3-6
<b>3.3</b>	<b>RAID configurations</b> .....	<b>3-7</b>
3.3.1	Installing hard disks .....	3-8
3.3.2	JMicron® RAID Configuration.....	3-12
<b>3.4</b>	<b>Creating a RAID driver disk</b> .....	<b>3-20</b>

# Notices

## Federal Communications Commission Statement

This device complies with Part 15 of the FCC Rules. Operation is subject to the following two conditions:

- This device may not cause harmful interference, and
- This device must accept any interference received including interference that may cause undesired operation.

This equipment has been tested and found to comply with the limits for a Class B digital device, pursuant to Part 15 of the FCC Rules. These limits are designed to provide reasonable protection against harmful interference in a residential installation. This equipment generates, uses and can radiate radio frequency energy and, if not installed and used in accordance with manufacturer's instructions, may cause harmful interference to radio communications. However, there is no guarantee that interference will not occur in a particular installation. If this equipment does cause harmful interference to radio or television reception, which can be determined by turning the equipment off and on, the user is encouraged to try to correct the interference by one or more of the following measures:

- Reorient or relocate the receiving antenna.
- Increase the separation between the equipment and receiver.
- Connect the equipment to an outlet on a circuit different from that to which the receiver is connected.
- Consult the dealer or an experienced radio/TV technician for help.



---

The use of shielded cables for connection of the monitor to the graphics card is required to assure compliance with FCC regulations. Changes or modifications to this unit not expressly approved by the party responsible for compliance could void the user's authority to operate this equipment.

---

## Canadian Department of Communications Statement

This digital apparatus does not exceed the Class B limits for radio noise emissions from digital apparatus set out in the Radio Interference Regulations of the Canadian Department of Communications.

This class B digital apparatus complies with Canadian ICES-003.

# Safety information

## Electrical safety

- To prevent electrical shock hazard, disconnect the power cable from the electrical outlet before relocating the system.
- When adding or removing devices to or from the system, ensure that the power cables for the devices are unplugged before the signal cables are connected. If possible, disconnect all power cables from the existing system before you add a device.
- Before connecting or removing signal cables from the motherboard, ensure that all power cables are unplugged.
- Seek professional assistance before using an adapter or extension cord. These devices could interrupt the grounding circuit.
- Make sure that your power supply is set to the correct voltage in your area. If you are not sure about the voltage of the electrical outlet you are using, contact your local power company.
- If the power supply is broken, do not try to fix it by yourself. Contact a qualified service technician or your retailer.

## Operation safety

- Before installing the motherboard and adding devices on it, carefully read all the manuals that came with the package.
- Before using the product, make sure all cables are correctly connected and the power cables are not damaged. If you detect any damage, contact your dealer immediately.
- To avoid short circuits, keep paper clips, screws, and staples away from connectors, slots, sockets and circuitry.
- Avoid dust, humidity, and temperature extremes. Do not place the product in any area where it may become wet.
- Place the product on a stable surface.
- If you encounter technical problems with the product, contact a qualified service technician or your retailer.



---

This symbol of the crossed out wheeled bin indicates that the product (electrical and electronic equipment) should not be placed in municipal waste. Please check local regulations for disposal of electronic products.

---

# About this guide

This user guide contains the information you need when installing and configuring the motherboard.

## How this guide is organized

This manual contains the following parts:

- **Chapter 1: Product introduction**  
This chapter describes the features of the motherboard and the new technology it supports. This chapter also lists the hardware setup procedures that you have to perform when installing system components. It includes description of the jumpers and connectors on the motherboard.
- **Chapter 2: BIOS setup**  
This chapter tells how to change system settings through the BIOS Setup menus. Detailed descriptions of the BIOS parameters are also provided.
- **Chapter 3: Software support**  
This chapter describes the contents of the support CD that comes with the motherboard package.

## Where to find more information

Refer to the following sources for additional information and for product and software updates.

1. **ASUS websites**  
The ASUS website provides updated information on ASUS hardware and software products. Refer to the ASUS contact information.
2. **Optional documentation**  
Your product package may include optional documentation, such as warranty flyers, that may have been added by your dealer. These documents are not part of the standard package.



## Conventions used in this guide

To make sure that you perform certain tasks properly, take note of the following symbols used throughout this manual.



**DANGER/WARNING:** Information to prevent injury to yourself when trying to complete a task.



**CAUTION:** Information to prevent damage to the components when trying to complete a task.



**IMPORTANT:** Instructions that you **MUST** follow to complete a task.



**NOTE:** Tips and additional information to help you complete a task.

## Typography

**Bold text**

Indicates a menu or an item to select

*Italics*

Used to emphasize a word or a phrase

<Key>

Keys enclosed in the less-than and greater-than sign means that you must press the enclosed key

Example: <Enter> means that you must press the Enter or Return key

<Key1+Key2+Key3>

If you must press two or more keys simultaneously, the key names are linked with a plus sign (+)

Example: <Ctrl+Alt+D>

**Command**

Means that you must type the command exactly as shown, then supply the required item or value enclosed in brackets

Example: At the DOS prompt, type the command line:

**awdf`lash` P5VD2VM.bin**

# P5VD2-VM/P5V-VM SE DH specifications summary

<b>CPU</b>	LGA775 socket for Intel® Core™2 Duo/Pentium® D/ Pentium® 4/Celeron® D CPU support Supports Intel EIST/EM64T/Hyper-Threading Technology
<b>Chipset</b>	Northbridge: VIA P4M900 Southbridge: VIA VT8237A
<b>Front side bus</b>	1066(support Intel® Core™2 Processors only)/800/533 MHz
<b>Memory</b>	2 x 240-pin DIMM sockets support up to 4 GB of DDR2 667/533 unbuffered non-ECC memory
<b>Expansion slots</b>	1 x PCI Express x16 1 x PCI Express x1 2 x PCI slots (Note: PCI-E x1 and JMicron JMB363 SATA controller cannot be used simultaneously)
<b>VGA</b>	Integrated Graphics, up to 256MB shared memory Support max. resolution to 2048 x 1536 (@75Hz)
<b>Storage</b>	VIA 8237A Southbridge supports: - 2 x Ultra DMA 133/100/66/33 interfaces for four(4) hard disk devices - 2 x Serial ATA with RAID 0, RAID 1, and JBOD configuration JMicron JMB363 SATA controller supports: - 1 x Internal Serial ATA 3 Gb/s - 1 x External Serial ATA 3 Gb/s (SATA On-the-Go) - RAID 0, RAID 1, and JBOD configuration (by 1 x External SATA & 1 x Internal SATA)
<b>Audio</b>	High definition audio, ADI® AD1986A SoundMax 5.1-channel CODEC Supports Jack-sensing function
<b>LAN</b>	Realtek® RTL8110SC Gigabit LAN Controller
<b>USB</b>	Supports up to 8 USB 2.0 ports
<b>Special features</b>	ASUS Q-Fan ASUS EZ Flash 2 ASUS CrashFree BIOS 2 MyLogo™

*(continued on the next page)*

# P5VD2-VM/P5V-VM SE DH specifications summary

Overclocking Features	ASUS C.P.R. (CPU Parameter Recall) SFS (Stepless Frequency Selection) from 133MHz up to 300MHz at 1MHz increment Fixed PCI-E/SATA frequencies.
Rear panel	1 x Parallel port 1 x External SATA 1 x LAN (RJ-45) port 4 x USB 2.0/1.1 ports (P5VD2-VM) 2 x USB 2.0/1.1 ports (P5V-VM SE DH) 1 x VGA port 1 x PS/2 keyboard port 1 x PS/2 mouse port 6-Channel Audio I/O ports
BIOS features	4 Mb Flash ROM, Award BIOS, PnP, WfM2.0, ACPI2.0a, SM BIOS 2.3, DMI 2.0
Manageability	WOL by PME, WOR by PME, Chassis Intrusion, PXE, RPL
Internal connectors	2 x USB 2.0 connectors for 4 additional USB 2.0 ports 1 x CPU fan connector 1 x Chassis fan connector 1 x COM connector 1 x 24-pin ATX power connector 1 x 4-pin ATX 12 V power connector 1 x CD/AUX audio-in connector 1 x Front panel audio connector 1 x S/PDIF out connector Chassis intrusion System panel connector
Form Factor	mATX form factor: 9.6 in x 8.6 in (24.5 cm x 21.8 cm)
Support CD contents	Device drivers ASUS PC Probe 2 ASUS Live Update utility Anti-virus software (OEM version)

*(continued on the next page)*

# Extra specifications on P5V-VM SE DH

ASUS Digital Home Features	<ul style="list-style-type: none"> <li>ASUS WiFi-AP Solo</li> <li>- 54 Mbps IEEE 802.11g and backwards compatible with 11 Mbps IEEE 802.11b</li> <li>- Access point mode</li> <li>- Station mode: Infrastructure mode or Ad-Hoc mode</li> <li>ASUS DH Remote™</li> <li>- Power</li> <li>- Quick Power</li> <li>- Noise Off</li> <li>- EZ WiFi</li> <li>- Full Screen</li> <li>- AP Launch</li> <li>- Media Controller Zone</li> <li>ASUS MP3-In™</li> </ul>
ASUS Digital Home Accessories	<ul style="list-style-type: none"> <li>ASUS DH Remote</li> <li>ASUS DH Remote Receiver</li> <li>ASUS WiFi-AP Solo omni-directional antenna</li> <li>ASUS MP3-In Module</li> </ul>
Wireless LAN	Up to 54Mbps IEEE 802.11b/g (ASUS WiFi-AP Solo)
Rear Panel	1 x WiFi-AP Solo antenna jack
Internal Connectors	1 x MP3-In connector
Support CD contents	ASUS WiFi-AP Solo, ASUS DH Remote™ Application

\*Specifications are subject to change without notice.

\*P5V-VM SE DH only supports max. 6 USB2.0 ports (2 USB 2.0/1.1 ports on rear panel).

This chapter describes the motherboard features and the new technologies it supports.

# 1 Product introduction

## 1.1 Welcome!

Thank you for buying an ASUS® P5VD2-VM/P5V-VM SE DH motherboard!

The motherboard delivers a host of new features and latest technologies, making it another standout in the long line of ASUS quality motherboards!

Before you start installing the motherboard, and hardware devices on it, check the items in your package with the list below.

## 1.2 Package contents

Check your motherboard package for the following items.

Motherboard	ASUS P5VD2-VM/P5V-VM SE DH motherboard
Cables	1 x Serial ATA power cable 1 x Serial ATA signal cable 1 x Ultra DMA 133/100/66 cables 1 x Floppy disk drive cable
Accessories	I/O shield ASUS DH Remote (only for P5V-VM SE DH) ASUS DH Remote Receiver (only for P5V-VM SE DH) ASUS WiFi-AP Solo omni-directional antenna (only for P5V-VM SE DH) ASUS MP3-In Module (only for P5V-VM SE DH)
Application CD	ASUS motherboard support CD
Documentation	User guide



If any of the above items is damaged or missing, contact your retailer.

## 1.3 Special features

### 1.3.1 Product highlights

#### Latest processor technology

The motherboard comes with a 775-pin surface mount Land Grid Array (LGA) socket designed for the Intel® processor in the 775-land package. The motherboard supports the Intel® Pentium® D processor with 1066/800/533 MHz Front Side Bus (FSB). The motherboard also supports the Intel® Hyper-Threading Technology. See page 1-10 for details.



## Intel® 65nm Dual-Core CPU support

This motherboard supports Intel® Pentium® D/Pentium® 4/Celeron® D dual-core processors built on the 65-nanometer (nm) process technology with copper interconnect. Dual-core processors contain two physical CPU cores with dedicated L2 caches to meet demands for more powerful processing. Intel®'s 65nm process is the most advanced chip manufacturing technology, delivering breakthrough performance, enhanced media experience, and low power consumption. Intel® 65nm dual-core processors utilize the latest package technologies for a thinner, lighter design without compromising performance. This motherboard also supports Intel® next generation Core™2 Duo CPU. This motherboard supports the latest Intel® Core™2 processors in LGA775 package. With new Intel® Core™ microarchitecture technology and 1066/800 MHz FSB, Intel® Core™2 processor is one of the most powerful and energy-efficient CPUs in the world.

## PCI Express™ interface

The motherboard fully supports PCI Express, the latest I/O interconnect technology that speeds up the PCI bus. PCI Express features point-to-point serial interconnections between devices and allows higher clockspeeds by carrying data in packets. This high speed interface is software compatible with existing PCI specifications.

## Serial ATA 3Gb/s technology and SATA-On-The-Go

The motherboard built with JMicron JMB363 SATA controller supports the next-generation hard drives based on the Serial ATA (SATA) 3Gb/s storage specification, delivering enhanced scalability and doubling the bus bandwidth for high-speed data retrieval and saves. The external SATA port located at the back I/O provides smart setup and hot-plug functions. Easily backup photos, videos and other entertainment contents on external devices. See pages 1-28 and 1-31 for details.

## Dual RAID solution

The onboard VIA VT8237A chipset allows RAID 0, RAID 1, and JBOD configuration for two SATA connectors, and JMicron JMB363 SATA controller also supports RAID 0, RAID 1, and JBOD.

## USB 2.0 technology

The motherboard implements the Universal Serial Bus (USB) 2.0 specification, dramatically increasing the connection speed from the 12 Mbps bandwidth on USB 1.1 to a fast 480 Mbps on USB 2.0. USB 2.0 is backward compatible with USB 1.1. See pages 1-25 and 1-34 for details.

## S/PDIF digital sound ready

The motherboard supports the S/PDIF Out function through the S/PDIF interface at midboard. The S/PDIF technology turns your computer into a high-end entertainment system with digital connectivity to powerful audio and speaker systems. See page 1-32 for details.

## 6-channel high definition audio

Enjoy high-end sound quality on your PC! The onboard 6-channel HD audio (High Definition Audio, previously codenamed Azalia) CODEC enables high-quality 192 KHz/ 24-bit audio output and jack-sensing feature! With CODEC, 6-channel audio ports, and S/PDIF interfaces, you can connect your computer to home theater decoders to produce crystal-clear digital audio.

## Gigabit LAN solution

The motherboard comes with a Gigabit LAN controllers to provide the total solution for your networking needs. These network controllers use the PCI segment to provide data bandwidth for your wired or wireless Internet, LAN, and file sharing requirements.

### 1.3.2 Innovative ASUS features

#### CrashFree BIOS 2

This feature allows you to restore the original BIOS data from the support CD in case when the BIOS codes and data are corrupted. This protection eliminates the need to buy a replacement ROM chip. See details on page 2-9.



## ASUS EZ Flash 2



EZ Flash 2 is a user-friendly BIOS update utility. Simply press the predefined hotkey to launch the utility and update the BIOS without entering the OS. Update your BIOS easily without preparing a bootable diskette or using an OS-based flash utility. See page 2-38 for details.

## ASUS Q-Fan technology



The ASUS Q-Fan technology smartly adjusts the CPU fan speed according to the system loading to ensure quiet, cool, and efficient operation.

## C.P.R. (CPU Parameter Recall)



The C.P.R. feature of the motherboard BIOS allows automatic re-setting to the BIOS default settings in case the system hangs due to overclocking. When the system hangs due to overclocking, C.P.R. eliminates the need to open the system chassis and clear the RTC data. Simply shut down and reboot the system, and the BIOS automatically restores the CPU default setting for each parameter.

### 1.3.3 ASUS Digital Home for P5V-VM SE DH special features



#### ASUS WiFi-AP Solo (Only for P5V-VM SE DH)

The ASUS WiFi-AP Solo allows a new level of versatility for your PC, enabling it to create a complete wireless home network in either AP or wireless client mode. Users will be able to play LAN games, connecting to the Internet, access and share printers, and use Skype from anywhere within range. The ASUS WiFi-AP Solo can provide these functions even when the PC is in sleep mode, so users can use Skype as a true replacement for traditional long distance telephone service. WiFi-AP Solo is an on-board feature, which means that users will save the extra WiFi-AP cost.

## **ASUS DH Remote™** (Only for P5V-VM SE DH)

The ASUS DH Remote™ is a convenient PC remote controller that gives users unprecedented control over their PCs from the comfort of their couches. With the touch of a button, users can instantly operate the following functions:

**Power:** Turns the computer on/off.

**Quick Power:** Puts the computer quickly into sleep mode.

**Noise Off:** Reduces the noise coming from the computer.

**EZ WiFi:** Puts the computer quickly into sleep mode but allowing WiFi-AP Solo to still operate.

**Full Screen:** Puts the media application into full screen.

**AP Launch:** Launches the media application.

**Media Control Zone:** Controls the media application.

## **ASUS MP3-In™** (Only for P5V-VM SE DH)

A convenient interface between computers and MP3 players, the ASUS MP3-In™ feature enables MP3 players to connect to PC speakers even when the PC power is off, which means that users can enjoy the sound quality from PC speakers without additional stereo equipment cost. Please refer page 1-35 and ASUS MP3-In™ quick installation guide for details.

## 1.4 Before you proceed

Take note of the following precautions before you install motherboard components or change any motherboard settings.



- Unplug the power cord from the wall socket before touching any component.
- Use a grounded wrist strap or touch a safely grounded object or to a metal object, such as the power supply case, before handling components to avoid damaging them due to static electricity
- Hold components by the edges to avoid touching the ICs on them.
- Whenever you uninstall any component, place it on a grounded antistatic pad or in the bag that came with the component.
- Before you install or remove any component, ensure that the ATX power supply is switched off or the power cord is detached from the power supply. Failure to do so may cause severe damage to the motherboard, peripherals, and/or components.

### Onboard LED

The motherboard comes with a standby power LED that lights up to indicate that the system is ON, in sleep mode, or in soft-off mode. This is a reminder that you should shut down the system and unplug the power cable before removing or plugging in any motherboard component. The illustration below shows the location of the onboard LED.

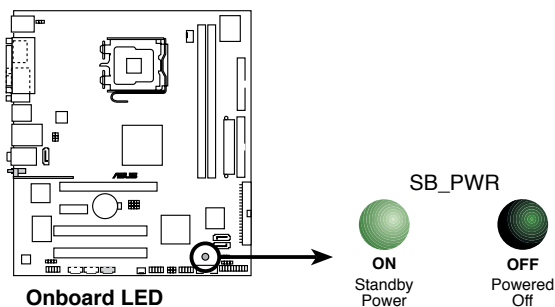

## 1.5 Motherboard overview

Before you install the motherboard, study the configuration of your chassis to ensure that the motherboard fits into it.



Make sure to unplug the power cord before installing or removing the motherboard. Failure to do so can cause you physical injury and damage motherboard components.

### 1.5.1 Placement direction

When installing the motherboard, make sure that you place it into the chassis in the correct orientation. The edge with external ports goes to the rear part of the chassis as indicated in the image below.

### 1.5.2 Screw holes

Place six (6) screws into the holes indicated by circles to secure the motherboard to the chassis.



Do not overtighten the screws! Doing so can damage the motherboard.

Place this side towards  
the rear of the chassis

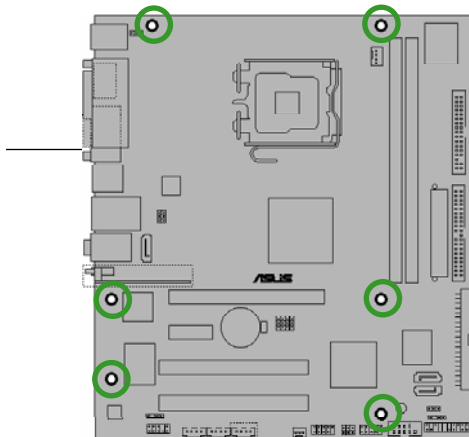

## 1.5.3 P5VD2-VM/P5V-VM SE DH Motherboard layout

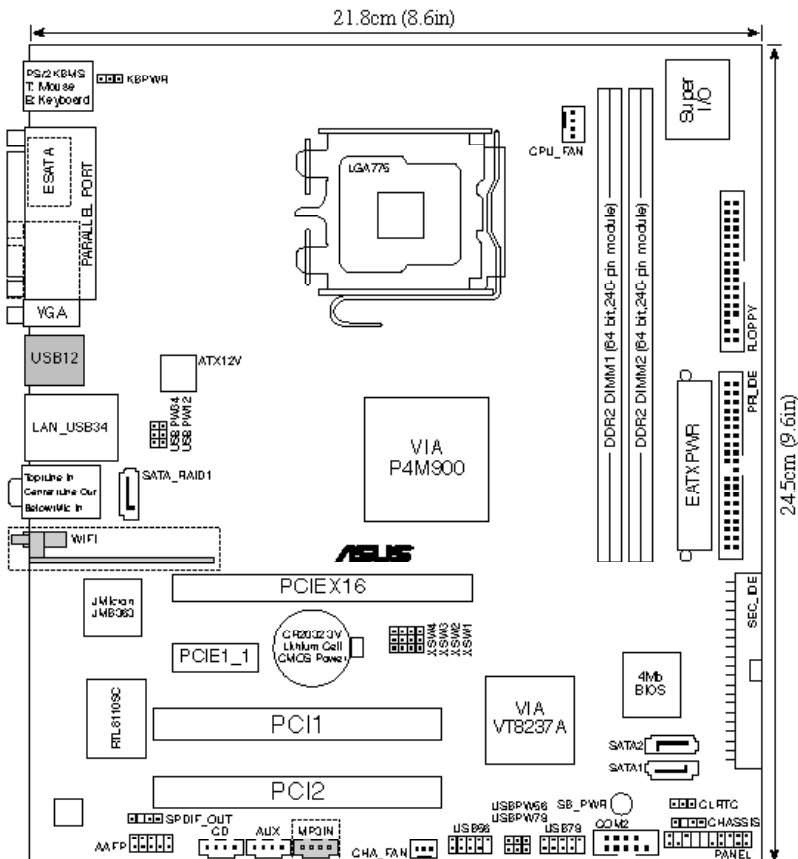

- The WIFI connector and MP3IN connector are only for P5V-VM SE DH.
- USB1 and USB2 ports are only for P5VD2-VM.

## 1.6 Central Processing Unit (CPU)

The motherboard comes with a surface mount LGA775 socket designed for the Intel® Core™2 Duo/Pentium® D/ Pentium® 4/Celeron® D processor in the 775-land package.



- Your boxed Intel® Core™2 Duo/Pentium® D/Pentium® 4/Celeron® D LGA775 processor package should come with installation instructions for the CPU, fan and heatsink assembly. If the instructions in this section do not match the CPU documentation, follow the latter.
- Upon purchase of the motherboard, make sure that the PnP cap is on the socket and the socket pins are not bent. Contact your retailer immediately if the PnP cap is missing, or if you see any damage to the PnP cap/socket pins/motherboard components. ASUS will shoulder the cost of repair only if the damage is shipment/transit-related.
- Keep the cap after installing the motherboard. ASUS will process Return Merchandise Authorization (RMA) requests only if the motherboard comes with the cap on the LGA775 socket.
- The product warranty does not cover damage to the socket pins resulting from incorrect CPU installation/removal, or misplacement/loss/incorrect removal of the PnP cap.

### 1.6.1 Installing the CPU

To install a CPU:

1. Locate the CPU socket on the motherboard.

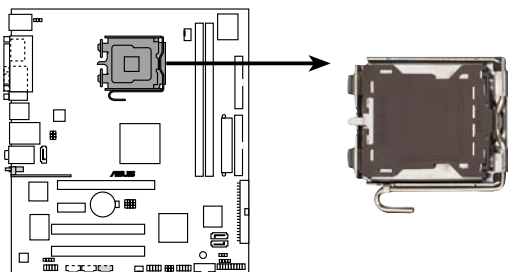

**CPU Socket 775**



Before installing the CPU, make sure that the socket box is facing towards you and the load lever is on your left.

2. Press the load lever with your thumb (A) and move it to the left (B) until it is released from the retention tab.

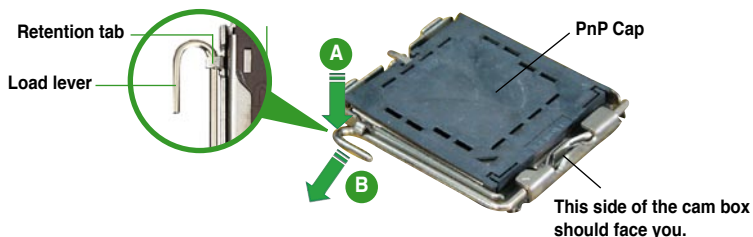

To prevent damage to the socket pins, do not remove the PnP cap unless you are installing a CPU.

3. Lift the load lever in the direction of the arrow to a 135° angle.

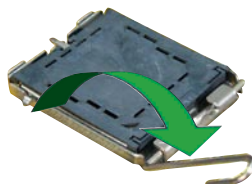

4. Lift the load plate with your thumb and forefinger to a 100° angle (A), then push the PnP cap from the load plate window to remove (B).

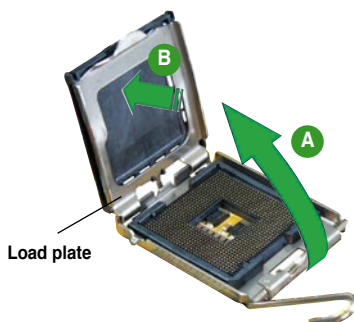

5. Position the CPU over the socket, making sure that the gold triangle is on the bottom-left corner of the socket. The socket alignment key should fit into the CPU notch.

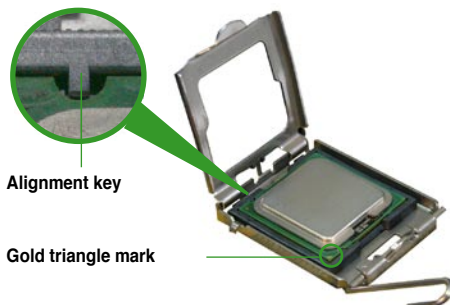

6. Close the load plate (A), then push the load lever (B) until it snaps into the retention tab.

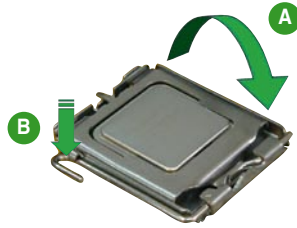

---

The CPU fits in only one correct orientation. DO NOT force the CPU into the socket to prevent bending the connectors on the socket and damaging the CPU!

---

### Notes on Intel® Hyper-Threading Technology



- This motherboard supports Intel® Pentium® 4 CPUs in the 775-land package with Hyper-Threading Technology.
  - Hyper-Threading Technology is supported under Windows® XP/2003 Server and Linux 1.7.x (kernel) and later versions only. Under Linux, use the Hyper-Threading compiler to compile the code. If you are using any other operating systems, disable the Hyper-Threading Technology item in the BIOS to ensure system stability and performance.
  - Installing Windows® XP Service Pack 1 or later version is recommended.
  - Make sure to enable the Hyper-Threading Technology item in BIOS before installing a supported operating system.
  - For more information on Hyper-Threading Technology, visit [www.intel.com/info/hyperthreading](http://www.intel.com/info/hyperthreading).
- 

To use the Hyper-Threading Technology on this motherboard:

1. Install an Intel® Pentium® 4 CPU in the 775-land package that supports Hyper-Threading Technology.
2. Power up the system and enter the BIOS Setup (see Chapter 2: BIOS setup). Under the Advanced Menu, make sure that the item Hyper-Threading Technology is set to Enabled. The item appears only if you installed a CPU that supports Hyper-Threading Technology.
3. Reboot the computer.



## 1.6.2 Installing the CPU heatsink and fan

The Intel® Pentium® 4 LGA775 processor requires a specially designed heatsink and fan assembly to ensure optimum thermal condition and performance.



- Install the motherboard to the chassis before you install the CPU fan and heatsink assembly
- When you buy a boxed Intel® Pentium® 4 processor, the package includes the CPU fan and heatsink assembly. If you buy a CPU separately, make sure that you use only Intel®-certified multi-directional heatsink and fan.
- Your Intel® Pentium® 4 heatsink and fan assembly comes in a push-pin design and requires no tool to install.



If you purchased a separate CPU heatsink and fan assembly, make sure that a Thermal Interface Material is properly applied to the CPU heatsink or CPU before you install the heatsink and fan assembly.

To install the CPU heatsink and fan:

1. Place the heatsink on top of the installed CPU, making sure that the four fasteners match the holes on the motherboard.

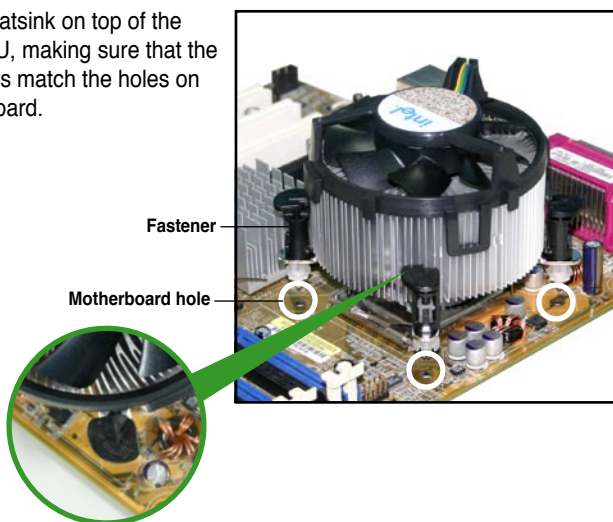

Make sure each fastener is oriented as shown, with the narrow groove directed outward.

2. Push down two fasteners at a time in a diagonal sequence to secure the heatsink and fan assembly in place.

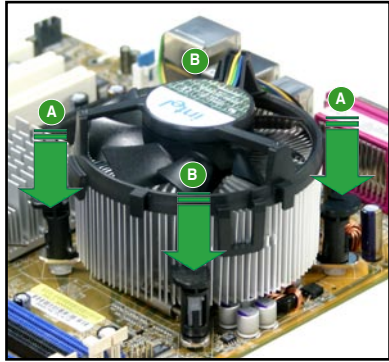
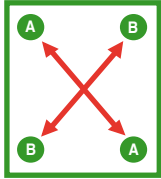

3. When the fan and heatsink assembly is in place, connect the CPU fan cable to the connector on the motherboard labeled CPU\_FAN.

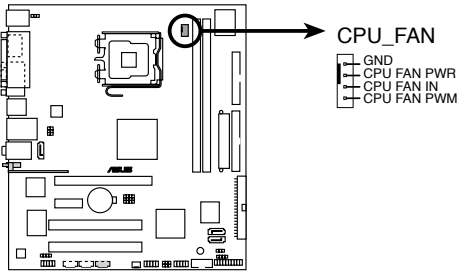

**CPU fan connector**



---

Do not forget to connect the CPU fan connector! Hardware monitoring errors can occur if you fail to plug this connector.

---

### 1.6.3 Uninstalling the CPU heatsink and fan

To uninstall the CPU heatsink and fan:

1. Disconnect the CPU fan cable from the connector on the motherboard labeled CPU\_FAN.
2. Rotate each fastener counterclockwise.

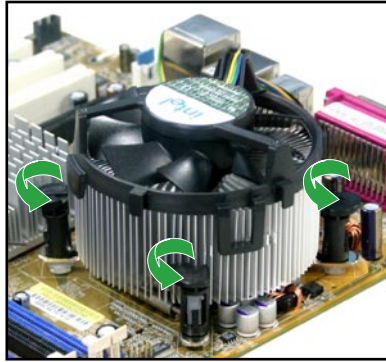

3. Pull up two fasteners at a time in a diagonal sequence to disengage the heatsink and fan assembly from the motherboard.

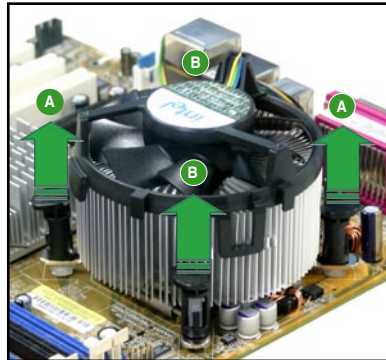
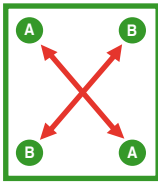

4. Remove the heatsink and fan assembly from the motherboard.

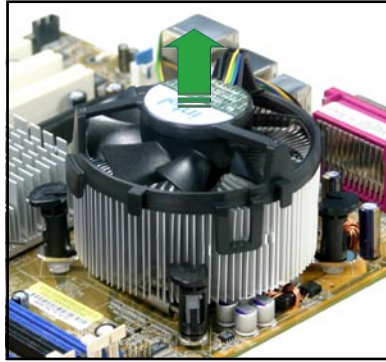

5. Rotate each fastener clockwise to reset the orientation.

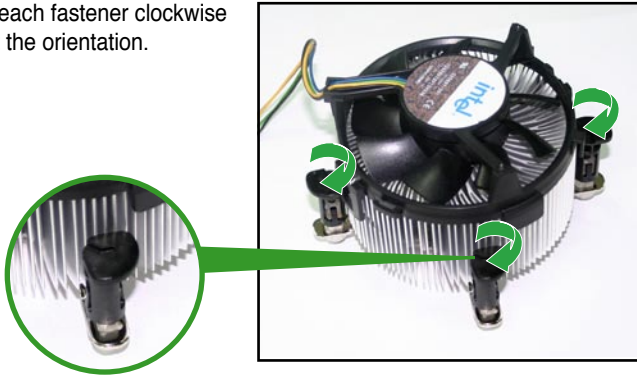

**Narrow end of the groove**



The narrow end of the groove should point outward after resetting. (The photo shows the groove shaded for emphasis.)

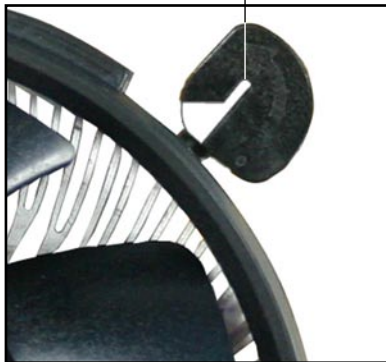

## 1.7 System memory

### 1.7.1 Overview

The motherboard comes with two Double Data Rate 2 (DDR2) Dual Inline Memory Modules (DIMM) sockets.

A DDR2 module has the same physical dimensions as a DDR DIMM but has a 240-pin footprint compared to the 184-pin DDR DIMM. DDR2 DIMMs are notched differently to prevent installation on a DDR DIMM socket.

The figure illustrates the location of the DDR2 DIMM sockets:

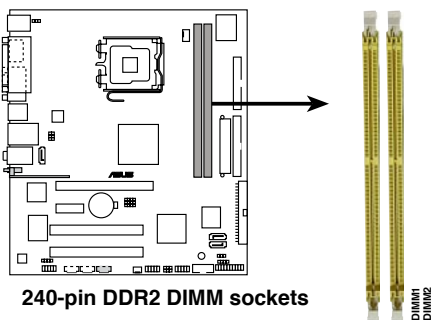

### 1.7.2 Memory configurations

You may install 256 MB, 512 MB, 1 GB, and 2 GB unbuffered non-ECC DDR2 DIMMs into the DIMM sockets.



- Always install DIMMs with the same CAS latency. For optimum compatibility, it is recommended that you obtain memory modules from the same vendor. Refer to the DDR2 Qualified Vendors List on the next page for details.
- Due to chipset resource allocation, the system may detect less than 4 GB system memory when you installed two 2 GB DDR2 memory modules.

## Qualified Vendors Lists (QVL)

### DDR2-667 MHz capability

Size	Vendor	Model	Brand	Side(s)	Component	DIMM support	
						A	B
512MB	KINGSTON	E5108AE-6E-E	N/A	SS	KVR667D2N5/512	V	V
1024MB	KINGSTON	E5108AE-6E-E	N/A	DS	KVR667D2N5/1G	V	V
512MB	KINGSTON	E5108AE-6E-E	N/A	SS	KVR667D2E5/512	V	V
256MB	KINGSTON	HYB18T256800AF3	N/A	SS	KVR667D2N5/256	V	V
256MB	Qimonda	HYB18T512160AF-3S	N/A	SS	HYS64T32000HU-3S-A	V	V
512MB	Qimonda	HYB18T512800AF3S	N/A	SS	HYS64T64000HU-3S-A	V	V
1024MB	Qimonda	HYB18T512800AF3S	N/A	DS	HYS64T128020HU-3S-A	V	V
256MB	Qimonda	HYB18T512160BF-3S	N/A	SS	HYS64T32000HU-3S-B	V	V
512MB	Qimonda	HYB18T512800BF3S	N/A	SS	HYS64T64000HU-3S-B	V	V
1024MB	Qimonda	HYB18T512800BF3S	N/A	DS	HYS64T128020HU-3S-B	V	V
256MB	SAMSUNG	K4T51163QC-ZCE6	N/A	SS	M378T3354CZ0-CE6	V	V
512MB	SAMSUNG	ZCE6K4T51083QC	N/A	SS	M378T6553CZ0-CE6	V	V
1024MB	SAMSUNG	ZCE6K4T51083QC	N/A	DS	M378T2953CZ0-CE6	V	V
512MB	Hynix	HY5PS12821AFP-Y5	N/A	SS	HYMP564U64AP8-Y5	V	V
1024MB	Hynix	HY5PS12821AFP-Y5	N/A	DS	HYMP512U64AP8-Y5	V	V
512MB	Hynix	HY5PS12821AFP-Y4	N/A	DS	HYMP564U64AP8-Y4	V	V
1024MB	Hynix	HY5PS12821AFP-Y4	N/A	DS	HYMP512U64AP8-Y4	V	V
256MB	ELPIDA	E2508AB-6E-E	N/A	SS	EBE25UC8ABFA-6E-E	V	V
512MB	ELPIDA	E5108AE-6E-E	N/A	SS	EBE51UD8AEFA-6E-E	V	V
512MB	A-DATA	AD29608A8B-3EG	N/A	SS	M20AD5Q3H3163J1C52	V	V
512MB	A-DATA	AD29608A8A-3EG	N/A	SS	M20AD5G3H3161C52	V	V
512MB	crucial	Heat-Sink Package	N/A	SS	BL464AA663.8FD	V	V
1024MB	crucial	Heat-Sink Package	N/A	DS	BL12864AA663.16FD	V	V
1024MB	crucial	Heat-Sink Package	N/A	DS	BL12864AL664.16FD	V	V
1024MB	Apacer	E5108AE-6E-E	N/A	DS	78.01092.420	V	V
512MB	Apacer	AM4B5708GQJS7E	N/A	SS	AU512E667C5KBGC	V	V
1024MB	Apacer	AM4B5708GQJS7E	N/A	DS	AU01GE667C5KBGC	V	V
512MB	KINGMAX	KKEA88B4LAUG-29DX	N/A	SS	KLCC28F-A8KB5	V	V
1024MB	KINGMAX	KKEA88B4LAUG-29DX	N/A	DS	KLCD48F-A8KB5	V	V
512MB	Transcend	E5108AE-6E-E	N/A	SS	TS64MLQ64V6J	V	V
1024MB	Transcend	E5108AE-6E-E	N/A	DS	TS128MLQ64V6J	V	V
512MB	Transcend	J12Q3AB-6	N/A	SS	JM367Q643A-6	V	V
1024MB	Transcend	J12Q3AB-6	N/A	DS	JM388Q643A-6	V	V

Side(s): SS - Single-sided      DS - Double-sided

DIMM support:

- A - Supports one module inserted in any slot as Single-channel memory configuration
- B - Supports one pair of modules inserted into yellow slots as one pair of Single-channel memory configuration

## DDR2-533 MHz capability

Size	Vendor	Model	Brand	Side(s)	Component	DIMM support	
						A	B
256MB	KINGSTON	E5116AF-5C-E	N/A	SS	KVR533D2N4/256	V	V
512MB	KINGSTON	HYB18T512800AF37	N/A	SS	KVR533D2N4/512	V	V
1024MB	KINGSTON	5YD1ID9GCT	N/A	DS	KVR533D2N4/1G	V	V
256MB	Qimonda	HYB18T512160AF-3.7	N/A	SS	HYS64T32000HU-3.7-A	V	V
512MB	Qimonda	HYB18T512800AF37	N/A	SS	HYS64T64000HU-3.7-A	V	V
1024MB	Qimonda	HYB18T512800AF37	N/A	DS	HYS64T128020HU-3.7-A	V	V
2048MB	Qimonda	HYB18T1G800AF-3.7	N/A	DS	HYS64T256020HU-3.7-A	V	V
256MB	Qimonda	HYB18T5121608BF-3.7	N/A	SS	HYS64T32000HU-3.7-B	V	V
512MB	Qimonda	HYB18T512800BF37	N/A	SS	HYS64T64000GU-3.7-B	V	V
1024MB	Qimonda	HYB18T512800BF37	N/A	DS	HYS64T32000HU-3.7-A	V	V
512MB	Hynix	HY5PS12821F-C4	N/A	SS	HYMP564U648-C4	V	V
1024MB	Hynix	HY5PS12821F-C4	N/A	DS	HYMP512U648-C4	V	V
1024MB	Hynix	HY5PS12821FP-C4	N/A	DS	HYMP512U648-C4	V	V
512MB	Hynix	HY5PS12821AFP-C3	N/A	SS	HYMP564U644AP8-C3	V	V
1024MB	Hynix	HY5PS12821AFP-C3	N/A	DS	HYMP512U644AP8-C3	V	V
512MB	ELPIDA	E5108AB-5C-E	N/A	SS	EBE51UD8ABFA-5C	V	V
512MB	ELPIDA	E5108AB-5C-E	N/A	SS	EBE51UD8ABFA-5C-E	V	V
1024MB	ELPIDA	E5108AB-5C-E	N/A	DS	EBE11UD8ABFA-5C-E	V	V
256MB	Apacer	E5116AB-5C-E	N/A	SS	78.81077.420	V	V
512MB	KINGMAX	E5108AE-5C-E	N/A	SS	KLBC28F-A8EB4	V	V
1024MB	KINGMAX	E5108AE-5C-E	N/A	DS	KLBD48F-A8EB4	V	V
512MB	KINGMAX	KKFA88E4AAK-37	N/A	SS	KLBC28F-A8KE4	V	V
1024MB	KINGMAX	5MB22D9DCN	N/A	DS	KLBD48F-A8ME4	V	V
256MB	CENTURY	K4T56083QF-GCD5	N/A	SS	25V6S8SSD5F4-K43	V	V
512MB	CENTURY	E5108AB-5C-E	N/A	SS	25V2H8EL5CB4-J43	V	V
512MB	Aeneon	AET93F370A	N/A	SS	AET660UD00-370A98Z	V	V
512MB	Aeneon	AET93F370A	N/A	SS	AET660UD00-370A98X	V	V
1024MB	Aeneon	AET93F370A	N/A	DS	AET760UD00-370A98Z	V	V
1024MB	Aeneon	AET93F370A	N/A	DS	AET760UD00-370A98S	V	V

Side(s): SS - Single-sided      DS - Double-sided

DIMM support:

- A - Supports one module inserted in any slot as Single-channel memory configuration
- B - Supports one pair of modules inserted into yellow slots as one pair of Single-channel memory configuration

### 1.7.3 Installing a DIMM



Make sure to unplug the power supply before adding or removing DIMMs or other system components. Failure to do so may cause severe damage to both the motherboard and the components.

1. Unlock a DIMM socket by pressing the retaining clips outward.
2. Align a DIMM on the socket such that the notch on the DIMM matches the break on the socket.
3. Firmly insert the DIMM into the socket until the retaining clips snap back in place and the DIMM is properly seated.

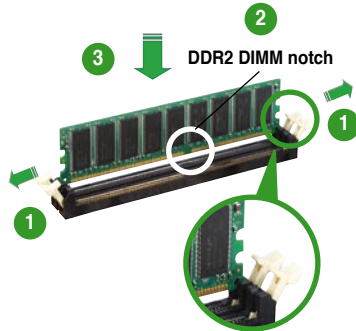

Unlocked retaining clip



- A DDR2 DIMM is keyed with a notch so that it fits in only one direction. DO NOT force a DIMM into a socket to avoid damaging the DIMM.
- The DDR2 DIMM sockets do not support DDR DIMMs. Do not install DDR DIMMs to the DDR2 DIMM sockets.

### 1.7.4 Removing a DIMM

To remove a DIMM:

1. Simultaneously press the retaining clips outward to unlock the DIMM.

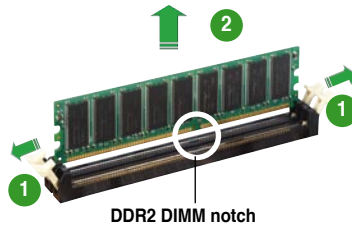

Support the DIMM lightly with your fingers when pressing the retaining clips. The DIMM might get damaged when it flips out with extra force.

2. Remove the DIMM from the socket.



## 1.8 Expansion slots

In the future, you may need to install expansion cards. The following sub-sections describe the slots and the expansion cards that they support.



---

Make sure to unplug the power cord before adding or removing expansion cards. Failure to do so may cause you physical injury and damage motherboard components.

---

### 1.8.1 Installing an expansion card

To install an expansion card:

1. Before installing the expansion card, read the documentation that came with it and make the necessary hardware settings for the card.
2. Remove the system unit cover (if your motherboard is already installed in a chassis).
3. Remove the bracket opposite the slot that you intend to use. Keep the screw for later use.
4. Align the card connector with the slot and press firmly until the card is completely seated on the slot.
5. Secure the card to the chassis with the screw you removed earlier.
6. Replace the system cover.

### 1.8.2 Configuring an expansion card

After installing the expansion card, configure it by adjusting the software settings.

1. Turn on the system and change the necessary BIOS settings, if any. See Chapter 2 for information on BIOS setup.
2. Assign an IRQ to the card. Refer to the tables on the next page.
3. Install the software drivers for the expansion card.

## 1.8.3 Interrupt assignments

### Standard interrupt assignments

IRQ	Priority	Standard Function
0	1	System Timer
1	2	Keyboard Controller
2	•	Re-direct to IRQ#9
4	12	Communications Port (COM)*
5	13	IRQ holder for PCI steering*
6	14	Floppy Disk Controller
7	15	Printer Port (LPT1)*
8	3	System CMOS/Real Time Clock
9	4	IRQ holder for PCI steering*
10	5	IRQ holder for PCI steering*
11	6	PCI-E x1
12	7	PS/2 Compatible Mouse Port*
13	8	Numeric Data Processor
14	9	Primary IDE Channel
15	10	Secondary IDE Channel

\* These IRQs are usually available for ISA or PCI devices.

### IRQ assignments for this motherboard

	A	B	C	D
PCI slot 1	—	shared	—	—
PCI slot 2	—	—	shared	—
PCIe x1 slot*	Fixed	Fixed	Fixed	Fixed
Onboard USB controller 1	shared	—	—	—
Onboard USB controller 2	—	shared	—	—
Onboard USB controller 3	—	—	shared	—
Onboard USB controller 4	—	—	—	shared
Onboard USB 2.0 controller	—	—	shared	—
Onboard LAN	shared	—	—	—
Onboard audio	—	shared	—	—
Onboard VGA	shared	—	—	—



When using PCI cards on shared slots, ensure that the drivers support "Share IRQ" or that the cards do not need IRQ assignments. Otherwise, conflicts will arise between the two PCI groups, making the system unstable and the card inoperable.

### 1.8.4 PCI slots

The PCI slots support cards such as a LAN card, SCSI card, USB card, and other cards that comply with PCI specifications. The figure shows a LAN card installed on a PCI slot.

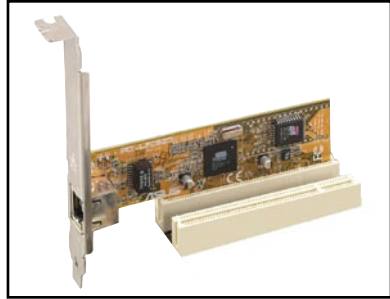

### 1.8.5 PCI Express x1 slot

This motherboard supports PCI Express x1 network cards, SCSI cards and other cards that comply with the PCI Express specifications. The figure shows a network card installed on the PCI Express x1 slot.

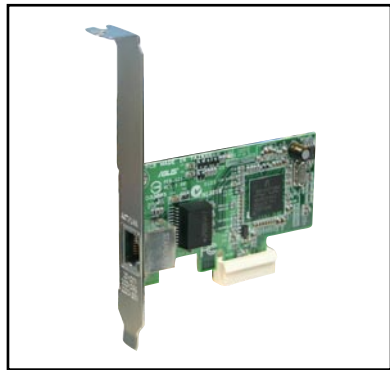

- PCI-E x1 and eSATA cannot be used simultaneously.
- See page 1-26 “4. PCI Express x 1 and External SATA jumper setting” for details.

### 1.8.6 PCI Express x16 slot

This motherboard supports PCI Express x16 graphic cards that comply with PCI Express specifications. The figure shows a graphics card installed on the PCI Express x16 slot.

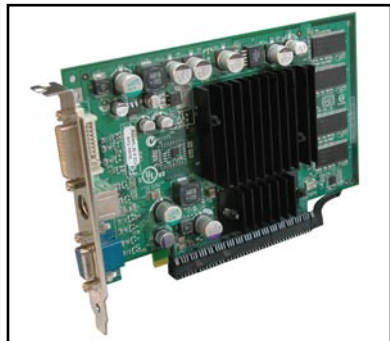

# 1.9 Jumpers

## 1. Clear RTC RAM (CLRTC)

This jumper allows you to clear the Real Time Clock (RTC) RAM in CMOS. You can clear the CMOS memory of date, time, and system setup parameters by erasing the CMOS RTC RAM data. The onboard button cell battery powers the RAM data in CMOS, which include system setup information such as system passwords.

To erase the RTC RAM:

1. Turn OFF the computer and unplug the power cord.
2. Remove the onboard battery.
3. Move the jumper cap from pins 1-2 (default) to pins 2-3. Keep the cap on pins 2-3 for about 5~10 seconds, then move the cap back to pins 1-2.
4. Re-install the battery.
5. Plug the power cord and turn ON the computer.
6. Hold down the <Del> key during the boot process and enter BIOS setup to re-enter data.



Except when clearing the RTC RAM, never remove the cap on CLRTC jumper default position. Removing the cap will cause system boot failure!

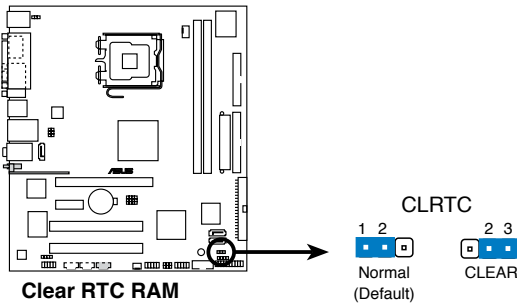

You do not need to clear the RTC when the system hangs due to overclocking. For system failure due to overclocking, use the C.P.R. (CPU Parameter Recall) feature. Shut down and reboot the system so the BIOS can automatically reset parameter settings to default values.

## 2. Keyboard power (3-pin KBPWR)

This jumper allows you to enable or disable the keyboard wake-up feature. Set this jumper to pins 2-3 (+5VSB) to wake up the computer when you press a key on the keyboard (the default is the Space Bar). This feature requires an ATX power supply that can supply at least 1A on the +5VSB lead, and a corresponding setting in the BIOS.

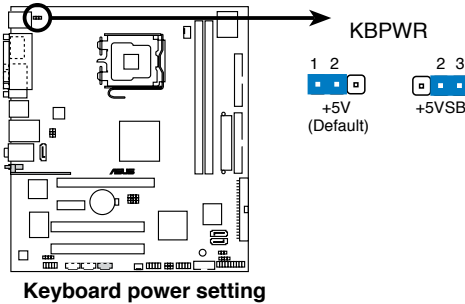

## 3. USB device wake-up (3-pin USBPW12, USBPW34, USBPW56, USBPW78)

Set these jumpers to +5V to wake up the computer from S1 sleep mode (CPU stopped, DRAM refreshed, system running in low power mode) using the connected USB devices. Set to +5VSB to wake up from S3 and S4 sleep modes (no power to CPU, DRAM in slow refresh, power supply in reduced power mode).

The USBPWR12 and USBPWR34 jumpers are for the rear USB ports. The USBPWR56 and USBPWR78 jumper is for the internal USB connectors that you can connect to additional USB ports.

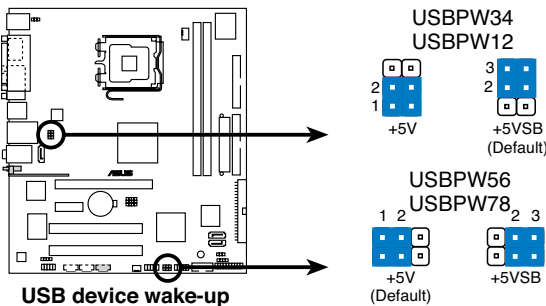



- USB1 and USB2 ports are only for P5VD2-VM.
- For P5V-VM SE DH, USBPW12 jumper controls Wifi-AP Solo. Do not change the setting.



- The USB device wake-up feature requires a power supply that can provide 500mA on the +5VSB lead for each USB port; otherwise, the system would not power up.
- The total current consumed must NOT exceed the power supply capability (+5VSB) whether under normal condition or in sleep mode.

#### 4. PCI Express x 1 and External SATA jumper setting

This jumper allows you to enable or disable the PCI Express x 1 or the External SATA function. Set this jumper to pins 1-2 to activate the PCI Express x 1 function. Set this jumper to pin 2-3 (default) to activate External SATA function.

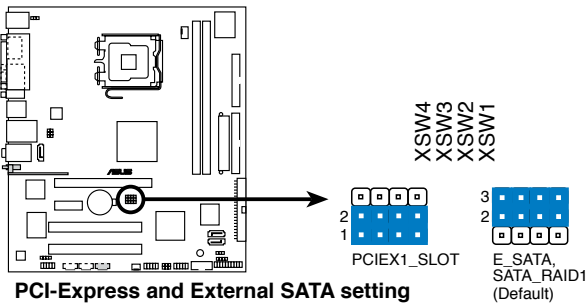

# 1.10 Connectors

## 1.10.1 Rear panel connectors

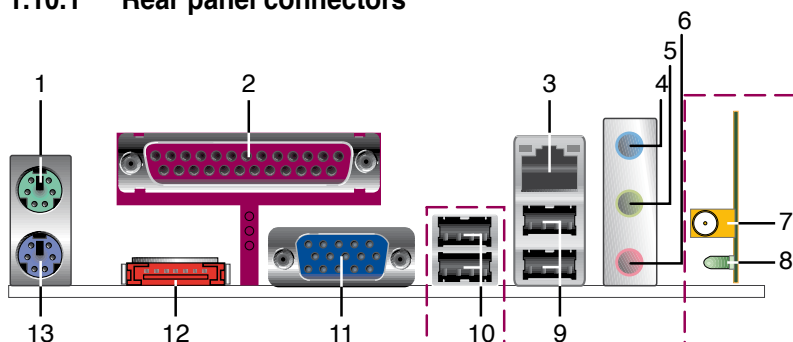

1. PS/2 mouse port (green). This port is for a PS/2 mouse.
2. Parallel port. This 25-pin port connects a parallel printer, a scanner, or other devices.
3. LAN (RJ-45) port. This port allows connection to a Local Area Network (LAN) through a network hub.

### LAN port LED indications

Activity/Link Speed LED			
Status	Description	Status	Description
OFF	No link	OFF	10 Mbps connection
ORANGE	Linked	ORANGE	100 Mbps connection
BLINKING	Data activity	GREEN	1 Gbps connection

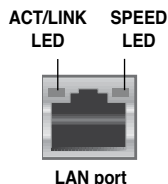

4. Line In port (light blue). This port connects a tape, CD, DVD player, or other audio sources. In 4-channel and 6-channel configuration, the function of this port becomes Front Speaker Out.
5. Line Out port (lime). This port connects a headphone or a speaker. In 4-channel and 6-channel configuration, the function of this port becomes Rear Speaker Out.
6. Microphone port (pink). This port connects a microphone. In a 6-channel configuration, the function of this port becomes Bass/Center Speaker.



Refer to the audio configuration table for the function of the audio ports in 2, 4, or 6-channel configuration.

### Audio 2, 4, or 6-channel configuration

Port	Headset 2-channel	4-channel	6-channel
Light Blue	Line In	Surround	Surround
Lime	Headphone/Front	Front	Front
Pink	Microphone	Microphone	Center/Subwoofer

7. Antenna jack (Only for P5V-VM SE DH). This port is on the onboard wireless LAN module that allows you to set up a wireless network and exchange information with other wireless devices without tangling cables and wires. Connect the moveable omni-directional antenna to this jack.
8. WIFI-AP Solo LED indicator (Only for P5V-VM SE DH). The WIFI-AP Solo comes with a green data transmission LED (AIR). Refer to the ASUS WiFi-Solo user guide.
9. USB 2.0 ports 1 and 2. These two 4-pin Universal Serial Bus (USB) ports are available for connecting USB 2.0 devices.
10. USB 2.0 ports 3 and 4 (Only for P5VD2-VM). These two 4-pin Universal Serial Bus (USB) ports are available for connecting USB 2.0 devices.
11. VGA port. This 15-pin VGA port connects to a VGA monitor.
12. External SATA port. This port connects to an external Serial ATA hard disk drive. To configure a RAID 0, a RAID 1, or a JBOD set, install an external Serial ATA hard disk drive and an internal Serial ATA hard disk drive to the SATA connector labeled SATA\_RAID1.



---

The external SATA port supports external Serial ATA 1.5 and 3 Gb/s devices. Longer cables support higher power requirements to deliver signal up to two meters away, and enables improved hot-swap function.

---

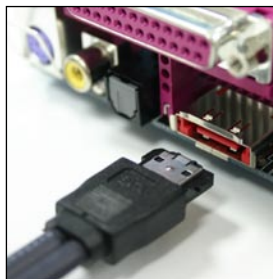

- Before creating a RAID set using Serial ATA hard disks, make sure that you have connected the Serial ATA signal cable and installed Serial ATA hard disk drives; otherwise, you cannot enter the JMicron RAID utility and SATA BIOS setup during POST.
- If you intend to create a RAID configuration using this connector, set the JMicron RAID controller item in the BIOS to [RAID Mode]. See section “2.4.4 Onboard Devices Configuration” for details.



- DO NOT insert a different connector to this port.
  - DO NOT unplug the external Serial ATA box when a RAID 0 or JBOD is configured.
  - PCI-E x1 and eSATA cannot be used simultaneously.
- 

13. PS/2 keyboard port (purple). This port is for a PS/2 keyboard.



## 1.10.2 Internal connectors

### 1. Floppy disk drive connector (34-1 pin FLOPPY)

This connector is for the provided floppy disk drive (FDD) signal cable. Insert one end of the cable to this connector, then connect the other end to the signal connector at the back of the floppy disk drive.



---

Pin 5 on the connector is removed to prevent incorrect cable connection when using an FDD cable with a covered Pin 5.

---

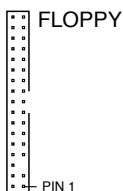
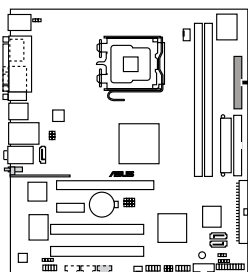

**NOTE:** Orient the red markings on the floppy ribbon cable to PIN 1.

**Floppy disk drive connector**

**2. Primary/Secondary IDE connectors (40-1 pin PRI\_IDE [blue]; 40-1 pin SEC\_IDE [black])**

The onboard IDE connectors are for Ultra DMA 133/100/66 signal cables. There are three connectors on each Ultra DMA 133/100/66 signal cable: blue, black, and gray. Connect the blue connector to the motherboard's IDE connector, then select one of the following modes to configure your device(s).

	Drive jumper setting	Mode of device(s)	Cable connector
Single device	Cable-Select or Master	-	Black
Two devices	Cable-Select	Master	Black
		Slave	Gray
	Master	Master	Black or gray
	Slave	Slave	



- Pin 20 on the IDE connector is removed to match the covered hole on the Ultra DMA cable connector. This prevents incorrect insertion when you connect the IDE cable.
- Use the 80-conductor IDE cable for Ultra DMA 100/66 IDE devices.



If any device jumper is set as "Cable-Select," make sure all other device jumpers have the same setting.

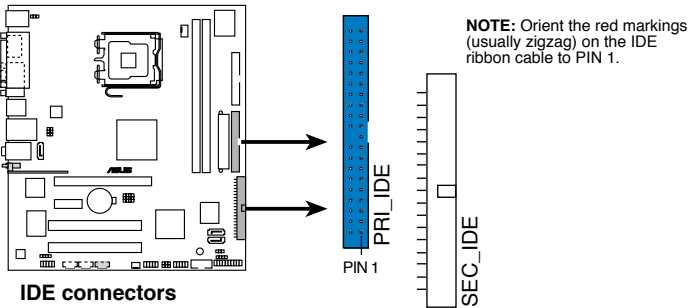

### 3. Serial ATA connectors (7-pin SATA1, SATA2)

These connectors are for the Serial ATA signal cables for Serial ATA 1.5 Gb/s hard disk drives.

If you installed Serial ATA hard disk drives, you can create a RAID 0, RAID 1, and JBOD configuration through the onboard VIA VT8237A RAID controller.

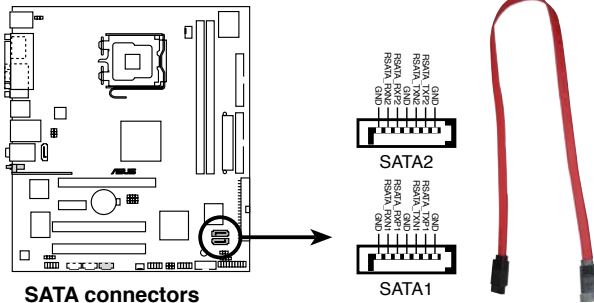

**SATA connectors**



#### Important notes on Serial ATA

- The Serial ATA RAID feature (RAID 0, RAID 1, and JBOD) is available only if you are using Windows® 2000/2003 Server/XP operation system.
- Install the Windows® 2000 Service Pack 4, the Windows® XP Service Pack 1 or later version before using Serial ATA.
- Please refer to section “Onboard Devices Configuration” in the BIOS for details on SATA RAID configuration.

### 4. JMicron Serial ATA RAID connector (7-pin SATA\_RAID1)

This connector is for a Serial ATA signal cable. This connector supports a Serial ATA hard disk drive, which you can combine with an external Serial ATA hard disk drive, to configure for RAID via the onboard Serial ATA RAID controller.

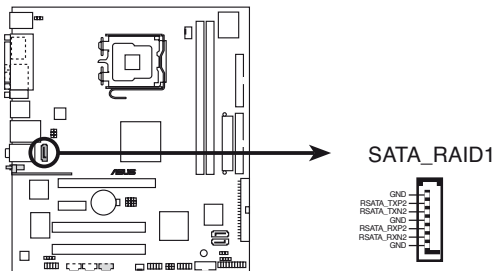

**SATA RAID connector**



Do not remove/unplug external SATA devices when running under RAID mode.

**5. CPU and Chassis fan connectors (4-pin CPU\_FAN, 3-pin CHA\_FAN)**

The fan connectors support cooling fans of 350mA~740mA (8.88W max.) or a total of 1A~2.22A (26.64W max.) at +12V. Connect the fan cables to the fan connectors on the motherboard, making sure that the black wire of each cable matches the ground pin of the connector.



Do not forget to connect the fan cables to the fan connectors. Insufficient air flow inside the system may damage the motherboard components. These are not jumpers! DO NOT place jumper caps on the fan connectors.

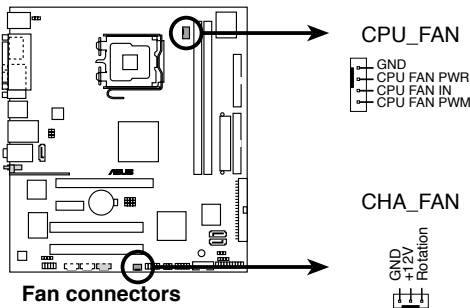

**6. Digital Audio connector (4-1 pin SPDIF\_OUT)**

This connector is for the S/PDIF audio module to allow digital sound output. Connect one end of the S/PDIF audio cable to this connector and the other end to the S/PDIF module.

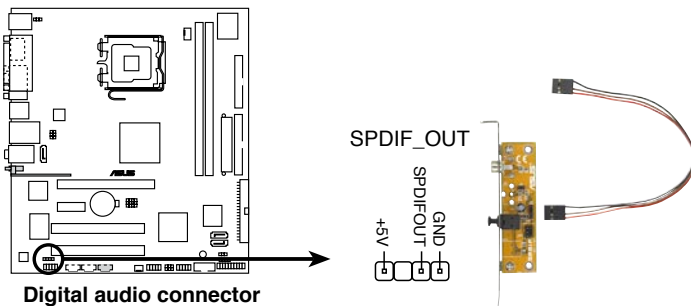

The S/PDIF out module is purchased separately.

## 7. ATX power connectors (24-pin EATXPWR, 4-pin ATX12V)

These connectors are for an ATX power supply. The plugs from the power supply are designed to fit these connectors in only one orientation. Find the proper orientation and push down firmly until the connectors completely fit.



- Do not forget to connect the 4-pin ATX +12 V power plug; otherwise, the system will not boot up.
- Use a PSU with a minimum power rating of 300 W on this motherboard. Use of a PSU with a higher power output is recommended when configuring a system with more power-consuming devices. The system may become unstable or may not boot up if the power is inadequate.

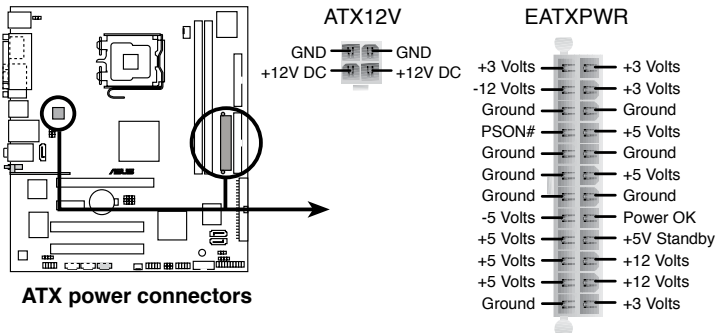

**ATX power connectors**

## 8. Serial port connector (10-1 pin COM2)

This connector is for a serial (COM) port. Connect the serial port module cable to this connector, then install the module to a slot opening at the back of the system chassis.

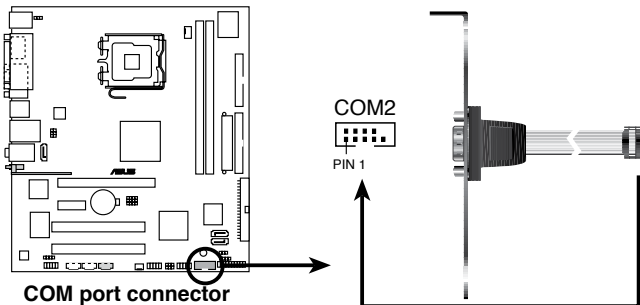

**COM port connector**



The Serial (COM) port module is purchased separately.

### 9. Internal audio connectors (4-pin CD, AUX)

These connectors allow you to receive stereo audio input from sound sources such as a CD-ROM, TV tuner, MPEG card or modem.

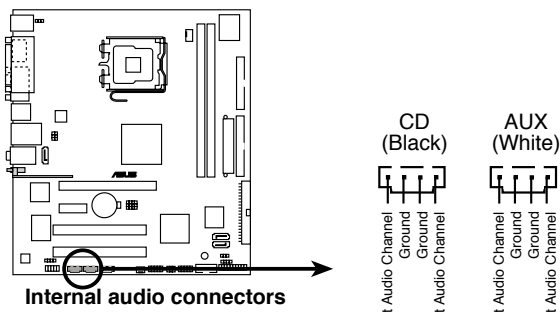

### 10. USB connectors (10-1 pin USB56, USB78)

These connectors are for USB 2.0 ports. Connect the optional USB module cable to any of these connectors, then install the module to a slot opening at the back of the system chassis. These USB connectors comply with USB 2.0 specification that supports up to 480 Mbps connection speed.

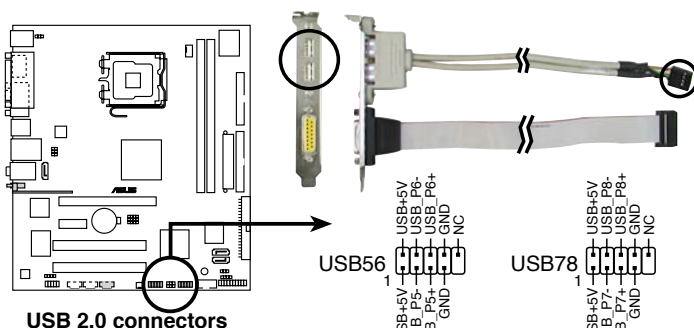

Never connect a 1394 cable to the USB connectors. Doing so will damage the motherboard!



The USB module is purchased separately.

## 11. Front panel audio connector (10-1 pin AAFP)

This connector is for a chassis-mounted front panel audio I/O module that supports either High Definition Audio or legacy AC '97 audio standard. Connect one end of the front panel audio I/O module cable to this connector.

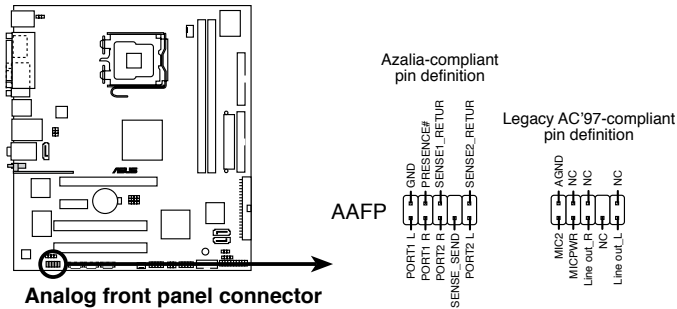

- Use a chassis that provides a high-definition audio front panel audio I/O to use the high-definition audio features.
- The default setting of this connector is legacy AC'97 audio, if you want to use the High-Definition (Azalia) audio features, set the Front Panel Support Type in the BIOS to Azalia.

## 12. Chassis intrusion connector (4-1 pin CHASSIS)

This connector is for a chassis-mounted intrusion detection sensor or switch. Connect one end of the chassis intrusion sensor or switch cable to this connector. The chassis intrusion sensor or switch sends a high-level signal to this connector when a chassis component is removed or replaced. The signal is then generated as a chassis intrusion event.

By default, the pins labeled “Chassis Signal” and “Ground” are shorted with a jumper cap. Remove the jumper caps only when you intend to use the chassis intrusion detection feature.

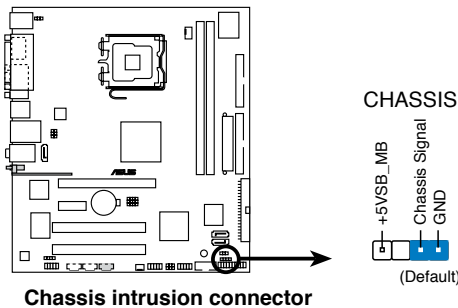

**13. MP3-In connector (4-pin MP3IN [red])  
(Only for P5V-VM SE DH)**

This connector is for the MP3-In module that allows you to connect your MP3 player to the speakers of the computer. For more information, refer to the MP3-In™ quick installation guide for details.

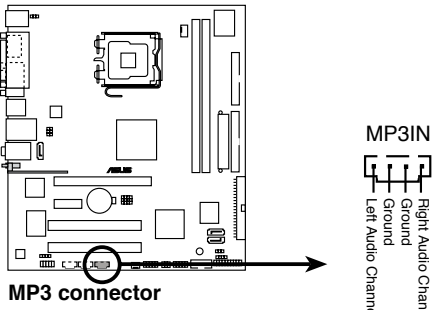

- The MP3-In module is bundled with the motherboard package. Connect the cable to the MP3IN connector, and enjoy music from computer speakers even when the PC is turned off.
- Do not plug the MP3-In cable into the Audio-in connector.



#### 14. System panel connector (20-8 pin F\_PANEL)

This connector supports several chassis-mounted functions.

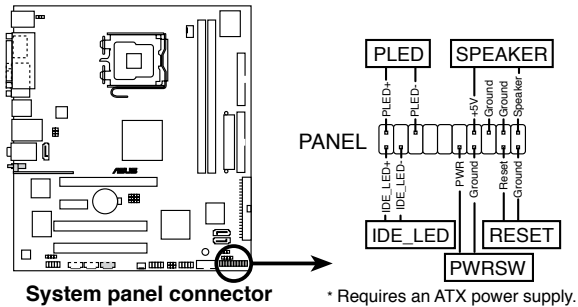

- **System power LED (3-pin PLED)**  
This 3-pin connector is for the system power LED. Connect the chassis power LED cable to this connector. The system power LED lights up when you turn on the system power, and blinks when the system is in sleep mode.
- **Hard disk drive activity LED (2-pin IDE\_LED)**  
This 2-pin connector is for the HDD Activity LED. Connect the HDD Activity LED cable to this connector. The IDE LED lights up or flashes when data is read from or written to the HDD.
- **System warning speaker (4-pin SPEAKER)**  
This 4-pin connector is for the chassis-mounted system warning speaker. The speaker allows you to hear system beeps and warnings.
- **Power/Soft-off button (2-pin PWRSW)**  
This connector is for the system power button. Pressing the power button turns the system ON or puts the system in SLEEP or SOFT-OFF mode depending on the BIOS settings. Pressing the power switch for more than four seconds while the system is ON turns the system OFF.
- **Reset button (2-pin RESET)**  
This 2-pin connector is for the chassis-mounted reset button for system reboot without turning off the system power.



This chapter tells how to change the system settings through the BIOS Setup menus. Detailed descriptions of the BIOS parameters are also provided.

# BIOS setup **2**

## 2.1 Managing and updating your BIOS

The following utilities allow you to manage and update the motherboard Basic Input/Output System (BIOS) setup.

1. ASUS Update (Updates the BIOS in Windows® environment.)
2. ASUS EZ Flash 2(Updates the BIOS using a floppy disk/USB flash disk or the motherboard support CD.)
3. Award BIOS Flash Utility (Updates the BIOS in DOS mode using a bootable floppy disk.)
4. ASUS CrashFree BIOS 2 (Updates the BIOS using a bootable floppy disk or the motherboard support CD when the BIOS file fails or gets corrupted.)

Refer to the corresponding sections for details on these utilities.



---

Save a copy of the original motherboard BIOS file to a bootable floppy disk in case you need to restore the BIOS in the future. Copy the original motherboard BIOS using the ASUS Update or Award BIOS Flash utilities.

---

### 2.1.1 ASUS Update utility

The ASUS Update is a utility that allows you to manage, save, and update the motherboard BIOS in Windows® environment. The ASUS Update utility allows you to:

- Save the current BIOS file
- Download the latest BIOS file from the Internet
- Update the BIOS from an updated BIOS file
- Update the BIOS directly from the Internet, and
- View the BIOS version information.

This utility is available in the support CD that comes with the motherboard package.



---

ASUS Update requires an Internet connection either through a network or an Internet Service Provider (ISP).

---

### Installing ASUS Update

To install ASUS Update:

1. Place the support CD in the optical drive. The Drivers menu appears.
2. Click the Utilities tab, then click Install ASUS Update VX.XX.XX. See page 3-4 for the Utilities screen menu.
3. The ASUS Update utility is copied to your system.



---

Quit all Windows® applications before you update the BIOS using this utility.

---

## Updating the BIOS through the Internet

To update the BIOS through the Internet:

1. Launch the ASUS Update utility from the Windows® desktop by clicking Start > Programs > ASUS > ASUSUpdate > ASUSUpdate. The ASUS Update main window appears.

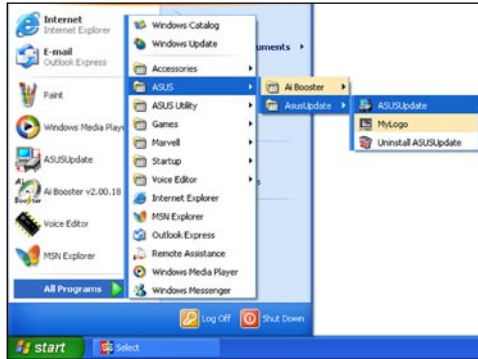

2. Select Update BIOS from the Internet option from the drop-down menu, then click Next.



3. Select the ASUS FTP site nearest you to avoid network traffic, or click Auto Select. Click Next.

- From the FTP site, select the BIOS version that you wish to download. Click Next.
- Follow the screen instructions to complete the update process.



The ASUS Update utility is capable of updating itself through the Internet. Always update the utility to avail all its features.



### Updating the BIOS through a BIOS file

To update the BIOS through a BIOS file:

- Launch the ASUS Update utility from the Windows® desktop by clicking Start > Programs > ASUS > ASUSUpdate > ASUSUpdate. The ASUS Update main window appears.
- Select Update BIOS from a file option from the drop-down menu, then click Next.



- Locate the BIOS file from the Open window, then click Save.
- Follow the screen instructions to complete the update process.

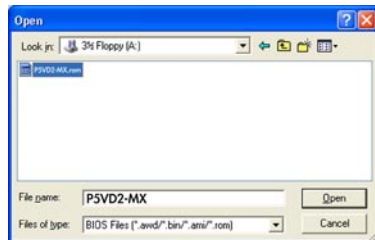

## 2.1.2 Creating a bootable floppy disk

1. Do either one of the following to create a bootable floppy disk.
  - DOS environment*
    - a. Insert a 1.44MB floppy disk into the drive.
    - b. At the DOS prompt, type `format a: /s` then press <Enter>.
  - Windows® XP environment*
    - a. Insert a 1.44 MB floppy disk to the floppy disk drive.
    - b. Click Start from the Windows® desktop, then select My Computer.
    - c. Select the 3 1/2 Floppy Drive icon.
    - d. Click File from the menu, then select Format. A Format 3 1/2 Floppy Disk window appears.
    - e. Select Create an MS-DOS startup disk from the format options field, then click Start.
  - Windows® 2000 environment*

To create a set of boot disks for Windows® 2000:

    - a. Insert a formatted, high density 1.44 MB floppy disk into the drive.
    - b. Insert the Windows® 2000 CD to the optical drive.
    - c. Click Start, then select Run.
    - d. From the Open field, type  
`D:\bootdisk\makeboot a:`  
assuming that D: is your optical drive.
    - e. Press <Enter>, then follow screen instructions to continue.
2. Copy the original or the latest motherboard BIOS file to the bootable floppy disk.

### 2.1.3 ASUS EZ Flash 2 utility

The ASUS EZ Flash 2 feature allows you to update the BIOS without having to go through the long process of booting from a floppy disk and using a DOS-based utility. The EZ Flash utility is built-in the BIOS chip so it is accessible by pressing <Alt> + <F2> during the Power-On Self Tests (POST).

To update the BIOS using EZ Flash 2:

1. Visit the ASUS website ([www.asus.com](http://www.asus.com)) to download the latest BIOS file for the motherboard.
2. Save the BIOS file to a floppy disk/USB flash disk, then restart the system.
3. You can launch the EZ Flash 2 by two methods.
  - (1) Insert the floppy disk/USB flash disk that contains the BIOS file to the floppy disk drive or the USB port.  
Press <Alt> + <F2> during POST to display the following.

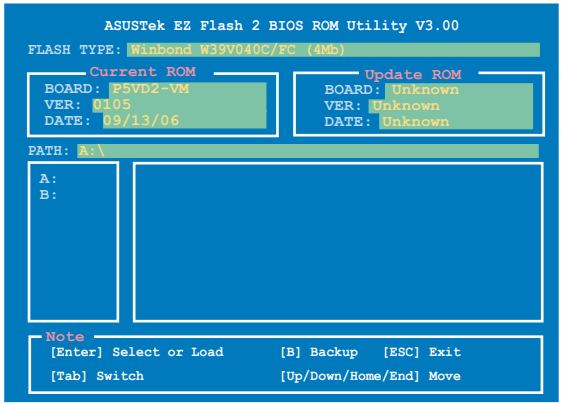

- (2) Enter BIOS setup program. Go to the Tools menu to select EZ Flash 2 and press <Enter> to enable it.

You can switch between drives by pressing <Tab> before the correct file is found. Then press <Enter>.

4. When the correct BIOS file is found, EZ Flash 2 performs the BIOS update process and automatically reboots the system when done.



- This function can support devices such as USB flash disk, hard disk, or floppy disk with FAT32/16/12 format only.
- Do not shut down or reset the system while updating the BIOS to prevent system boot failure!



## 2.1.4 Updating the BIOS

The Basic Input/Output System (BIOS) can be updated using the AwardBIOS Flash Utility. Follow these instructions to update the BIOS using this utility.

1. Download the latest BIOS file from the ASUS web site. Rename the file to P5VD2VM.BIN/P5VVMSEDH.BIN and save it to a floppy disk.



Save only the updated BIOS file in the floppy disk to avoid loading the wrong BIOS file.

2. Copy the AwardBIOS Flash Utility (awdf flash.exe) from the Software folder of the support CD to the floppy disk with the latest BIOS file.
3. Boot the system in DOS mode using the bootable floppy disk you created earlier.
4. When the A.> appears, replace the bootable floppy disk with the floppy disk containing the new BIOS file and the Award BIOS Flash Utility.
5. At the prompt, type **awdf flash** then press <Enter>. The Award BIOS Flash Utility screen appears.

```
AwardBIOS Flash Utility for ASUS V1.14
(C) Phoenix Technologies Ltd. All Rights Reserved

For NF-CK804-P5VD2-VM-00      DATE: 09/13/2006
Flash Type - Winbond W39V040C/FC (4Mb)

File Name to Program: 

Message: Please input File Name!
```

6. Type the BIOS file name in the **File Name to Program** field, then press <Enter>.

```
AwardBIOS Flash Utility for ASUS V1.14
(C) Phoenix Technologies Ltd. All Rights Reserved

For NF-CK804-P5VD2-VM-00      DATE: 09/13/2006
Flash Type - Winbond W39V040C/FC (4Mb)

File Name to Program: 0105.bin

Message: Do You Want To Save Bios (Y/N)
```

- 7. Press <N> when the utility prompts you to save the current BIOS file. The following screen appears.
- 8. The utility verifies the BIOS file in the floppy disk and starts flashing the BIOS file.

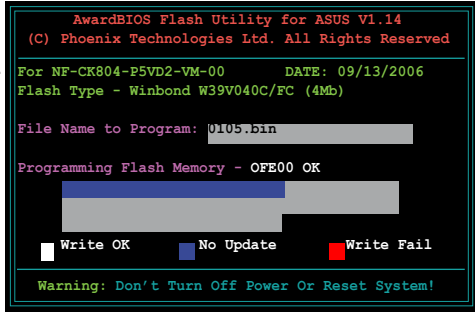

Do not turn off or reset the system during the flashing process!

- 9. The utility displays a **Flashing Complete** message indicating that you have successfully flashed the BIOS file. Remove the floppy disk then press <F1> to restart the system.

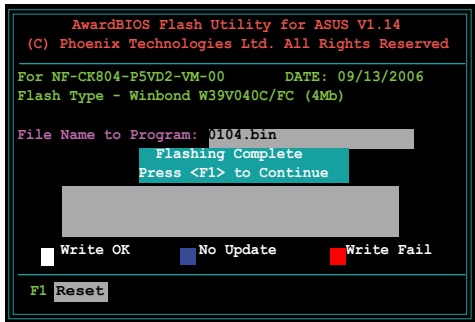

## 2.1.5 ASUS CrashFree BIOS 2 utility

The ASUS CrashFree BIOS 2 is an auto recovery tool that allows you to restore the BIOS file when it fails or gets corrupted during the updating process. You can update a corrupted BIOS file using the motherboard support CD or the floppy disk that contains the updated BIOS file.



- Prepare the motherboard support CD or the floppy disk containing the updated motherboard BIOS before using this utility.
- Make sure that you rename the original or updated BIOS file in the floppy disk to P5VD2VM.ROM/P5VVMSEDH.ROM.



To use CrashFree BIOS2 feature on motherboards with onboard VGA, you will not see the screen display when the BIOS crashes even when you reboot the system. Install a graphics card into the expansion slot before rebooting the computer to display BIOS recovery message.

### Recovering the BIOS from a floppy disk

To recover the BIOS from a floppy disk:

1. Turn on the system.
2. Insert the floppy disk with the original or updated BIOS file to the floppy disk drive.
3. The utility displays the following message and automatically checks the floppy disk for the original or updated BIOS file.

```
Bad BIOS checksum. Starting BIOS recovery...  
Checking for floppy...
```

When found, the utility reads the BIOS file and starts flashing the corrupted BIOS file.

```
Bad BIOS checksum. Starting BIOS recovery...  
Checking for floppy...  
Floppy found!  
Reading file "P5VD2VM.ROM". Completed.  
Start flashing...
```



**DO NOT** shut down or reset the system while updating the BIOS! Doing so can cause system boot failure!

4. Restart the system after the utility completes the updating process.

## Recovering the BIOS from the support CD

To recover the BIOS from the support CD:

1. Remove any floppy disk from the floppy disk drive, then turn on the system.
2. Insert the support CD to the optical drive.
3. The utility displays the following message and automatically checks the floppy disk for the original or updated BIOS file.

```
Bad BIOS checksum. Starting BIOS recovery...
Checking for floppy...
```

When no floppy disk is found, the utility automatically checks the optical drive for the original or updated BIOS file. The utility then updates the corrupted BIOS file.

```
Bad BIOS checksum. Starting BIOS recovery...
Checking for floppy...
Floppy not found!
Checking for CD-ROM...
CD-ROM found!
Reading file "P5VD2VM.ROM". Completed.
Start flashing...
```



DO NOT shut down or reset the system while updating the BIOS! Doing so can cause system boot failure!

---

4. Restart the system after the utility completes the updating process.



The recovered BIOS may not be the latest BIOS version for this motherboard. Visit the ASUS website ([www.asus.com](http://www.asus.com)) to download the latest BIOS file.

---

## 2.2 BIOS setup program

This motherboard supports a programmable firmware chip that you can update using the provided utility described in section “2.1 Managing and updating your BIOS.”

Use the BIOS Setup program when you are installing a motherboard, reconfiguring your system, or prompted to “Run Setup”. This section explains how to configure your system using this utility.

Even if you are not prompted to use the Setup program, you can change the configuration of your computer in the future. For example, you can enable the security password feature or change the power management settings. This requires you to reconfigure your system using the BIOS Setup program so that the computer can recognize these changes and record them in the CMOS RAM of the firmware hub.

The firmware hub on the motherboard stores the Setup utility. When you start up the computer, the system provides you with the opportunity to run this program. Press <Del> during the Power-On Self-Test (POST) to enter the Setup utility; otherwise, POST continues with its test routines.

If you wish to enter Setup after POST, restart the system by pressing <Ctrl+Alt+Delete>, or by pressing the reset button on the system chassis. You can also restart by turning the system off and then back on. Do this last option only if the first two failed.

The Setup program is designed to make it as easy to use as possible. Being a menu-driven program, it lets you scroll through the various sub-menus and make your selections from the available options using the navigation keys.



- 
- The default BIOS settings for this motherboard apply for most conditions to ensure optimum performance. If the system becomes unstable after changing any BIOS settings, load the default settings to ensure system compatibility and stability. Select the Load Default Settings item under the Exit Menu. See section “2.8 Exit Menu.”
  - The BIOS setup screens shown in this section are for reference purposes only, and may not exactly match what you see on your screen.
  - Visit the ASUS website ([www.asus.com](http://www.asus.com)) to download the latest BIOS file for this motherboard and .
-

## 2.2.1 BIOS menu screen

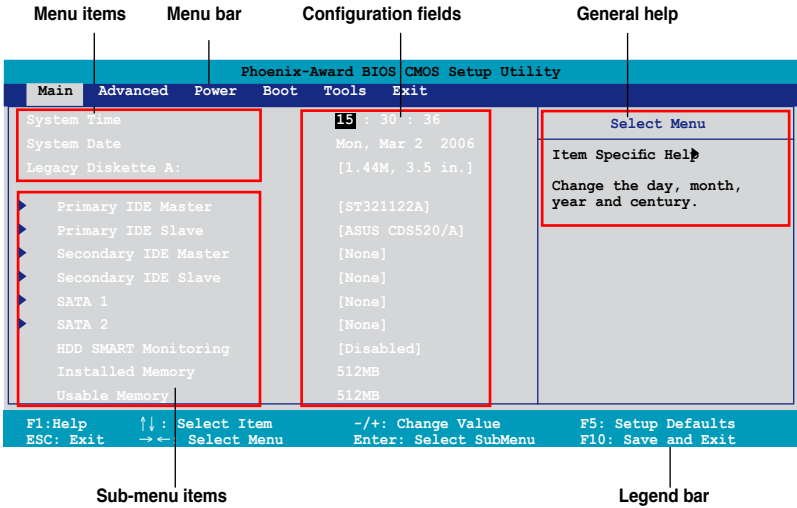

## 2.2.2 Menu bar

The menu bar on top of the screen has the following main items:

- Main** For changing the basic system configuration
- Advanced** For changing the advanced system settings
- Power** For changing the advanced power management (APM) configuration
- Boot** For changing the system boot configuration
- Tools** For configuring options for special functions
- Exit** For selecting the exit options and loading default settings

To select an item on the menu bar, press the right or left arrow key on the keyboard until the desired item is highlighted.



- The BIOS setup screens shown in this chapter are for reference purposes only, and may not exactly match what you see on your screen.
- Visit the ASUS website ([www.asus.com](http://www.asus.com)) to download the latest BIOS information.

### 2.2.3 Legend bar

At the bottom of the Setup screen is a legend bar. The keys in the legend bar allow you to navigate through the various setup menus. The following table lists the keys found in the legend bar with their corresponding functions.

Navigation Key	Function
<F1>	Displays the General Help screen
<F5>	Loads setup default values
<Esc>	Exits the BIOS setup or returns to the main menu from a sub-menu
Left or Right arrow	Selects the menu item to the left or right
Up or Down arrow	Moves the highlight up or down between fields
Page Down or - (minus)	Scrolls backward through the values for the highlighted field
Page Up or + (plus)	Scrolls forward through the values for the highlighted field
<Enter>	Brings up a selection menu for the highlighted field
<F10>	Saves changes and exit

### 2.2.4 Menu items

The highlighted item on the menu bar displays the specific items for that menu. For example, selecting Main shows the Main menu items.

The other items (Advanced, Power, Boot, and Exit) on the menu bar have their respective menu items.

### 2.2.5 Sub-menu items

A solid triangle before each item on any menu screen means that the item has a sub-menu. To display the sub-menu, select the item and press <Enter>.

### 2.2.6 Configuration fields

These fields show the values for the menu items. If an item is user-configurable, you can change the value of the field opposite the item. You cannot select an item that is not user-configurable.

A configurable field is enclosed in brackets, and is highlighted when selected. To change the value of a field, select it then press <Enter> to display a list of options. Refer to “2.2.7 Pop-up window.”

## 2.2.7 Pop-up window

Select a menu item then press <Enter> to display a pop-up window with the configuration options for that item.

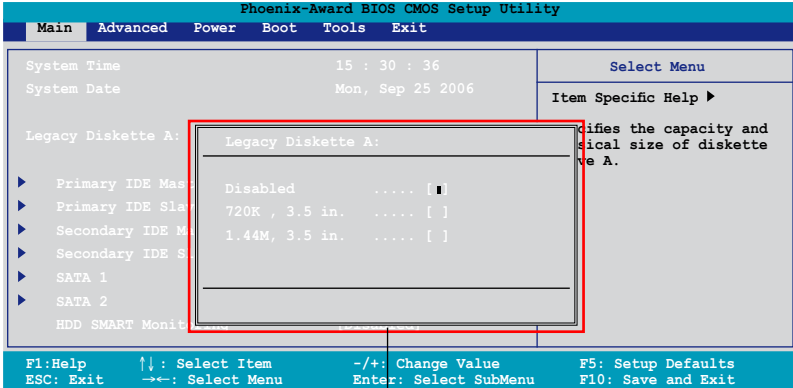

Pop-up menu

## 2.2.8 General help

At the top right corner of the menu screen is a brief description of the selected item.



## 2.3 Main menu

When you enter the BIOS Setup program, the Main menu screen appears, giving you an overview of the basic system information.



Refer to section “2.2.1 BIOS menu screen” for information on the menu screen items and how to navigate through them.

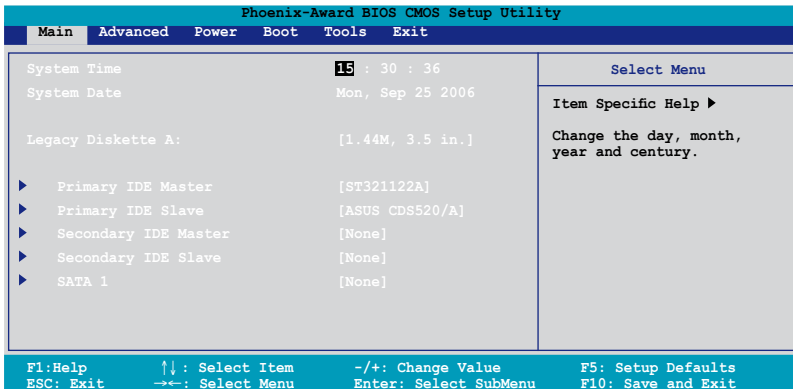

### 2.3.1 System Time [xx:xx:xx]

Allows you to set the system time.

### 2.3.2 System Date [Day xx/xx/xxxx]

Allows you to set the system date.

### 2.3.3 Legacy Diskette A [1.44M, 3.5 in.]

Sets the type of floppy drive installed. Configuration options: [Disabled]  
[720K , 3.5 in.] [1.44M, 3.5 in.]

### 2.3.4 Primary and Secondary IDE Master/Slave

While entering Setup, the BIOS automatically detects the presence of IDE devices. There is a separate sub-menu for each IDE device. Select a device item then press <Enter> to display the IDE device information.

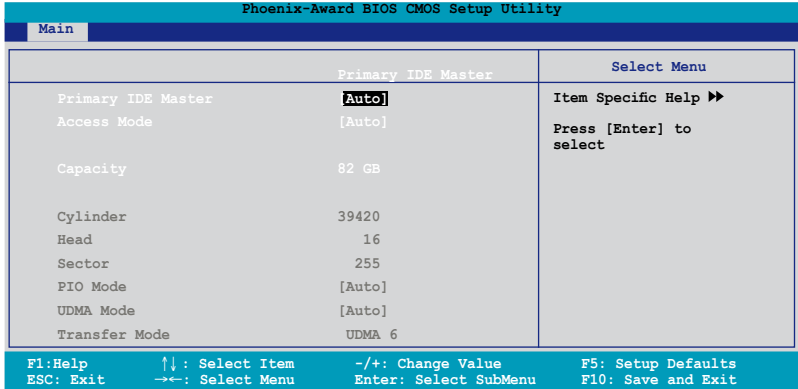

The BIOS automatically detects the values opposite the dimmed items (Capacity, Cylinder, Head, Sector and Transfer Mode). These values are not user-configurable. These items show N/A if no IDE device is installed in the system.

#### Primary IDE Master/Slave [Auto] Secondary IDE Master/Slave [Auto]

Select [Auto] to automatically detect an IDE hard disk drive. If automatic detection is successful, the BIOS automatically fills in the correct values for the remaining fields on this sub-menu. If the hard disk was already formatted on a previous system, the setup BIOS may detect incorrect parameters. Select [Manual] to manually enter the IDE hard disk drive parameters. If no drive is installed select [None].

Configuration options: [None] [Auto] [Manual]

#### Access Mode [Auto]

The default [Auto] allows automatic detection of an IDE hard disk drive. Select [CHS] for this item if you set the IDE Primary Master/Slave to [Manual]. Configuration options: [CHS] [LBA] [Large] [Auto]



Before attempting to configure a hard disk drive, make sure you have the correct configuration information supplied by the drive manufacturer. Incorrect settings may cause the system to fail to recognize the installed hard disk.

## Capacity

Displays the auto-detected hard disk capacity. This item is not configurable.

## Cylinder

Shows the number of the hard disk cylinders. This item is not configurable.

## Head

Shows the number of the hard disk read/write heads. This item is not configurable.

## Sector

Shows the number of sectors per track. This item is not configurable.

## PIO Mode [Auto]

Sets the PIO mode for the IDE device.

Configuration options: [Auto] [Mode 0] [Mode 1] [Mode 2] [Mode 3] [Mode 4]

## UDMA Mode [Auto]

Disables or sets the UDMA mode. Configuration options: [Disabled] [Auto]

## Transfer Mode

Shows the Transfer mode. This item is not configurable.



---

After entering the IDE hard disk drive information into BIOS, use a disk utility, such as FDISK, to partition and format new IDE hard disk drives. This is necessary so that you can write or read data from the hard disk. Make sure to set the partition of the Primary IDE hard disk drives to active.

---

### 2.3.5 SATA 1/2

While entering Setup, the BIOS automatically detects the presence of Serial ATA devices. There is a separate sub-menu for each SATA device. Select a device item then press <Enter> to display the SATA device information.

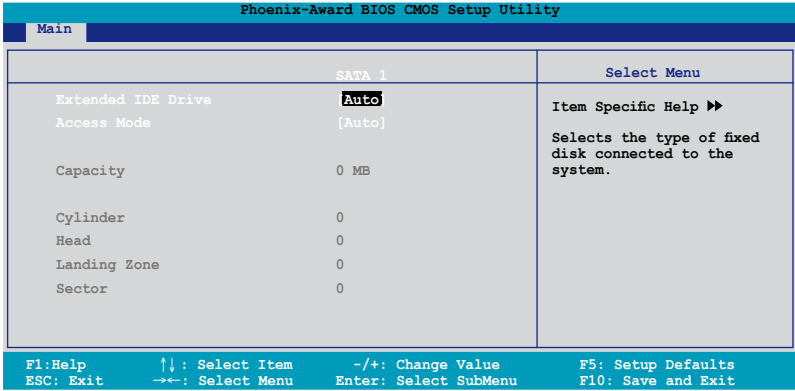

The BIOS automatically detects the values opposite the dimmed items (Capacity, Cylinder, Head, Landing Zone and Sector). These values are not user-configurable. These items show 0 if no SATA device is installed in the system.

#### Extended IDE Drive [Auto]

Selects the type of fixed disk connected to the system.

Configuration options: [None] [Auto]

#### Access Mode [Auto]

Sets the sector addressing mode. Configuration options: [Large] [Auto]



Before attempting to configure a hard disk drive, make sure you have the correct configuration information supplied by the drive manufacturer. Incorrect settings may cause the system to fail to recognize the installed hard disk.

#### Capacity

Displays the auto-detected hard disk capacity. This item is not configurable.

#### Cylinder

Shows the number of the hard disk cylinders. This item is not configurable.

## Head

Shows the number of the hard disk read/write heads. This item is not configurable.

## Landing Zone

Shows the number of landing zone per track. This item is not configurable.

## Sector

Shows the number of sectors per track. This item is not configurable.



---

After entering the IDE hard disk drive information into BIOS, use a disk utility, such as FDISK, to partition and format new IDE hard disk drives. This is necessary so that you can write or read data from the hard disk. Make sure to set the partition of the Primary IDE hard disk drives to active.

---

### 2.3.6 HDD SMART Monitoring [Disabled]

Allows you to enable or disable the HDD Self-Monitoring Analysis and Reporting Technology (SMART) feature.

Configuration options: [Disabled] [Enabled]

### 2.3.7 Installed Memory [xxx MB]

Shows the size of installed memory.

### 2.3.8 Usable Memory [XXX MB]

Shows the size of usable memory.

## 2.4 Advanced menu

The Advanced menu items allow you to change the settings for the CPU and other system devices.



Take caution when changing the settings of the Advanced menu items. Incorrect field values can cause the system to malfunction.

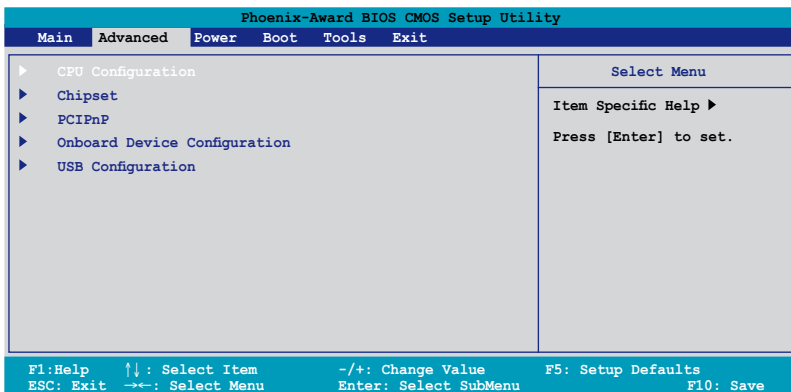

### 2.4.1 CPU Configuration

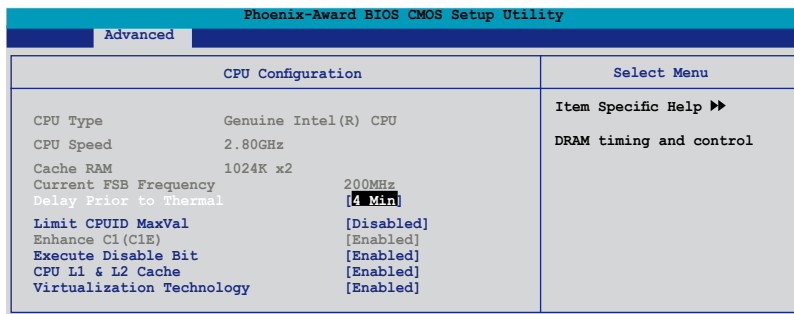

#### Delay Prior to Thermal [4 Min]

Configuration options: [4 Min] [8 Min] [16 Min] [32 Min]

#### Limit CPUID MaxVal [Disabled]

Configuration options: [Disabled] [Enabled]

#### Enhance C1 (C1E) [Enabled]

Configuration options: [Enabled] [Disabled]

#### Execute Disable Bit [Enabled]

Configuration options: [Enabled] [Disabled]

#### Virtualization Technology [Enabled]

Configuration options: [Enabled] [Disabled]

## CPU L1 & L2 Cache [Enabled]

Configuration options: [Disabled] [Enabled]

### 2.4.2 Chipset

Phoenix-Award BIOS CMOS Setup Utility	
Advanced	
Chipset	Select Menu
▶ DRAM Clock/Drive Control	Item Specific Help▶▶
▶ Frequency/Voltage control	
Top Performance [Disabled]	
Primary Display Adapter [PCI-E]	
VGA Share Memory Size [64M]	

### DRAM Clock/Drive Control

Phoenix-Award BIOS CMOS Setup Utility	
Advanced	
DRAM Clock/Drive Control	Select Menu
Current DRAM Frequency 200MHz	Item Specific Help ▶▶
DRAM Frequency <b>Auto</b>	
DRAM Timing Selectable [By SPD]	
x CAS Latency Time 4	
x Bank Interleave Disabled	
x Precharge to Active (Trp) 4T	
x Active to Precharge (Tras) 07T	
x Active to CMD (Trcd) 4T	
x REF to ACT/REF (Trfc) 20T/21T	
x ACT (0) to ACT (1) (TRRD) 3T	

#### DRAM Frequency [Auto]

Configuration options: [Auto] [400 MHz] [533 MHz][667MHz]

#### DRAM Timing Selectable [By SPD]

Configuration options: [Manual] [By SPD]



The following items are user-configurable when the “DRAM Timing Selectable” item is set to [Manual].

CAS Latency Time [4]

Configuration options: [2] [3] [4] [5]

Bank Interleave [4 Bank]

Configuration options: [Disabled] [2 Bank] [4 Bank] [8 Bank]

Precharge to Active (Trp) [3T]

Configuration options: [2T] [3T] [4T] [5T]

Active to Precharge(Tras) [15T]

Configuration options: [05T] [06T]...[20T]

Active to CMD(Trcd) [3T]

Configuration options: [2T] [3T] [4T] [5T]

REF to ACT/REF(Trfc) [34T/35T]

Configuration options: [07T/08T] [08T/09T] [09/10T]...[70T/71T]

Act(o) to ACT(1) (TRRD) [3T]

Configuration options: [2T] [3T]

## Frequency/Voltage control

Phoenix-Award BIOS CMOS Setup Utility	
Advanced	
Frequency/Voltage control	Select Menu
CPU Frequency Ratio [9X]	Item Specific Help ▶▶
Async CPU/PCIE Clock [Async Mode]	
CPU Clock [200MHz]	
Spread Spectrum [ +/-0.2% ]	

### CPU Frequency Ratio [9 X]

Sets the CPU frequency ratio. Min=6; Max=9.

### Async CPU/PCIE Clock [Async Mode]

Configuration options: [Sync Mode] [Async Mode]

### CPU Clock [266MHz]

Sets the CPU clock frequency. Min=266 MHz; Max=300 MHz.

### Spread Spectrum [ +/-0.2% ]

Configuration options: [Disabled] [ +/-0.1% ] [ +/-0.2% ]...[ +/-1.0% ]

## Top Performance [Disabled]

Configuration options: [Disabled] [Enabled]



## Primary Display Adapter [PCI-E]

Allows you to select which graphics controller to use as the primary boot device.  
Configuration options: [PCI] [PCI-E]

## VGA Share Memory Size [64M]

Configuration options: [Disabled] [64M] [128M] [256M]



The VGA share memory size should not exceed 50% of the total system memory size.

### 2.4.3 PCIPnP

Phoenix-Award BIOS CMOS Setup Utility		
Advanced		
PCIPnP	Select Menu	
Plug & Play O/S	[No]	Item Specific Help▶▶
Resources Controlled By	[Auto]	Select Yes if you are using a Plug and Play capable operating system
x IRQ Resources		Select No if you need the BIOS to configure non-boot devices
Assign IRQ For VGA	[Enabled]	
** PCI Express relative itmes **		
Maximum Payload Size	[4096]	

## Plug & Play O/S [No]

When set to [No], the BIOS configures all the devices in the system. When set to [Yes] and if you install a Plug and Play operating system, the operating system configures the Plug and Play devices not required for boot. Configuration options: [No] [Yes]

## Resources Controlled By [Auto]

When set to [Auto], the BIOS automatically configures all the boot and Plug and Play compatible devices. Set to [Manual] if you want to assign the IRQ DMA and memory base address fields.  
Configuration options: [Auto] [Manual]



When the item Resources Controlled By is set to [Auto], the item IRQ Resources is grayed out and not user-configurable. Refer to the section "IRQ Resources" for information on how to enable this item.

## IRQ Resources

This sub-menu is activated only when the Resources Controlled By item is set to Manual.

Phoenix-Award BIOS CMOS Setup Utility		
Advanced		
IRQ Resources		Select Menu
IRQ-3 assigned to	[PCI Device]	Item Specific Help▶▶▶  Legacy ISA for devices compliant with the original PC AT bus specification, PCI/ISA PnP for devices compliant with the
IRQ-4 assigned to	[PCI Device]	
IRQ-5 assigned to	[PCI Device]	
IRQ-7 assigned to	[PCI Device]	
IRQ-9 assigned to	[PCI Device]	
IRQ-10 assigned to	[PCI Device]	
IRQ-11 assigned to	[PCI Device]	
IRQ-14 assigned to	[PCI Device]	
IRQ-15 assigned to	[PCI Device]	

### *IRQ-xx assigned to*

When set to [PCI Device], the specific IRQ is free for use of PCI/PnP devices. When set to [Reserved], the IRQ is reserved for legacy ISA devices.  
Configuration options: [PCI Device] [Reserved]

## Assign IRQ For VGA [Enabled]

Configuration options: [Enabled] [Disabled]

## Maximum Payload Size [4096]

Sets maximum TLP payload size for the PCI Express devices. The unit is byte.  
Configuration options: [128] [256] [512] [1024] [2048] [4096]

## 2.4.4 Onboard Devices Configuration

Phoenix-Award BIOS CMOS Setup Utility		
Advanced		
Onboard Device Configuration		Select Menu
JMicron RAID controller	[IDE]	Item Specific Help ►►
SATA Controller	[Enabled]	Press [Enter] to set
SATA Controller Mode	[IDE]	
HDA Controller	[Auto]	
Onboard LAN Device	[Enabled]	
Onboard LAN Boot ROM	[Disabled]	
Serial Port1 Address	[3F8/IRQ4]	
Parallel Port Address	[378/IRQ7]	
Parallel Port Mode	[Bi-Directional]	
ECP Mode Use DMA	[3]	

F1: Help    ↑↓ : Select Item    -/+ : Change Value    F5: Setup Defaults  
ESC: Exit    →← : Select Menu    Enter: Select SubMenu    F10: Save and Exit

### JMicron RAID controller [IDE]

Configuration options: [Disabled] [IDE] [RAID] [AHCI]

### SATA Controller [Enabled]

Allows you to enable or disable the OnChip SATA.

Configuration options: [Disabled] [Enabled]

### SATA Controller Mode [IDE]

Configuration options: [IDE] [RAID]

### HDA Controller [Auto]

Allows you to enable or disable the High-Definition Audio controller.

Configuration options: [Auto] [Disabled]

### Onboard LAN [Enabled]

Enables or disables the onboard LAN controller.

Configuration options: [Enabled] [Disabled]

### Onboard LAN Boot ROM [Disabled]

Enables or disables the onboard LAN boot ROM.

Configuration options: [Enabled] [Disabled]

### **Serial Port1 Address [3F8/IRQ4]**

Allows you to select the Serial Port1 base address.

Configuration options: [Disabled] [3F8/IRQ4] [2F8/IRQ3] [3E8/IRQ4] [2E8/IRQ3] [Auto]

### **Parallel Port Address [378/IRQ7]**

Allows you to select the Parallel Port address.

Configuration options: [Disabled] [378/IRQ7] [278/IRQ5] [3BC/IRQ7]

### **Parallel Port Mode [Bi-Directional]**

Allows you to select the Parallel Port mode.

Configuration options: [Normal] [EPP] [ECP] [Bi-Directional]



---

The “ECP Mode Use DMA” item becomes user-configurable when the “ Parallel Port Mode” item is set to [ECP] or [Bi-Directional]

---

### **ECP Mode Use DMA [3]**

Allows selection of ECP Mode. Configuration options: [1] [3]

## 2.4.5 USB Configuration

Phoenix-Award BIOS CMOS Setup Utility		
Advanced		
USB Configuration	Select Menu	
USB Controller	Enabled	Item Specific Help▶▶
USB 2.0 Controller	[Enabled]	Enable or Disable USB
USB Legacy support	[Auto]	1.1 and 2.0 Controller

### USB Controller [Enabled]

Allows you to enable or disable the onchip USB controller.

Configuration options: [Disabled] [Enabled]

### USB 2.0 Controller [Enabled]

Allows you to enable or disable the USB 2.0 controller.

Configuration options: [Disabled] [Enabled]

### USB Legacy Support [Auto]

Allows you to enable or disable support for USB devices on legacy operating systems (OS). Configuration options: [Auto] [Enabled] [Disabled]

## 2.5 Power menu

The Power menu items allow you to change the settings for the Advanced Configuration and Power Interface (ACPI) and the Advanced Power Management (APM). Select an item then press <Enter> to display the configuration options.

Phoenix-Award BIOS CMOS Setup Utility			
Main	Advanced	Power	Boot Tools Exit
ACPI Suspend Type	[S1&S3]		Select Menu
ACPI APIC support	Enabled		Item Specific Help▶
▶ APM Configuration			Select the ACPI state used for System Suspend.
▶ Hardware Monitor			
F1:Help ESC: Exit	↑↓: Select Item →←: Select Menu	-/+ : Change Value Enter: Select Sub-menu	F5: Setup Defaults F10: Save and Exit

### 2.5.1 ACPI Suspend Type [S1&S3]

Allows you to select the Advanced Configuration and Power Interface (ACPI) state to be used for system suspend.

Configuration options: [S1(POS)] [S3(STR)] [S1&S3]

### 2.5.2 ACPI APIC Support [Enabled]

Allows you to enable or disable the Advanced Configuration and Power Interface (ACPI) support in the Application-Specific Integrated Circuit (ASIC). When set to Enabled, the ACPI APIC table pointer is included in the RSDT pointer list.

Configuration options: [Disabled] [Enabled]

### 2.5.3 APM Configuration

Phoenix-Award BIOS CMOS Setup Utility			
Power			
APM Configuration			Select Menu
Power Up By PS/2 Mouse	[Disabled]		Item Specific Help▶▶
Power Up By PS/2 Keyboard	[Disabled]		Press [Enter] to select
Power Up On PCI/PCIE Devices	[Disabled]		
Power On By External Modem	[Disabled]		
Power On By On-board LAN	[Disabled]		
Power On by RTC Alarm	[Disabled]		
x Date (of Month) Alarm	0		
x Alarm Time (hh:mm)	0 : 0 : 0		
Restore on AC Power Loss	[Power Off]		
PWR Button < 4 secs	[Instant-Off]		
HPET Support	[Enabled]		
F1:Help ESC: Exit	↑↓: Select Item →←: Select Menu	-/+ : Change Value Enter: Select SubMenu	F5: Setup Defaults F10: Save and Exit

### **Power On By PS/2 Mouse [Disabled]**

When set to [Enabled], this parameter allows you to use the PS/2 mouse to turn on the system. This feature requires an ATX power supply that provides at least 1A on the +5VSB lead.

Configuration options: [Disabled] [Double Click]

### **Power On By PS/2 Keyboard [Disabled]**

Allows you to disable the Power On by PS/2 keyboard function or set specific keys on the PS/2 keyboard to turn on the system. This feature requires an ATX power supply that provides at least 1A on the +5VSB lead.

Configuration options: [Disabled] [Space Bar] [Ctrl-ESC] [Power Key]

### **Power Up On PCI/PCIE Devices [Disabled]**

Allows you to enable or disable the PME to wake up from S5 by PCI/PsCIE devices & NV Onboard LAN. Configuration options: [Disabled] [Enabled]

### **Power On By External Modem [Disabled]**

This allows either settings of [Enabled] or [Disabled] for powering up the computer when the external modem receives a call while the computer is in Soft-off mode.

Configuration options: [Disabled] [Enabled]



---

The computer cannot receive or transmit data until the computer and applications are fully running. Thus, connection cannot be made on the first try. Turning an external modem off and then back on while the computer is off causes an initialization string that turns the system power on.

---

### **Power On By On-board LAN [Disabled]**

Allows you to enable or disable the Wake Up On LAN function.

Configuration options: [Disabled] [Enabled]

### **Power On By RTC Alarm [Disabled]**

Allows you to enable or disable RTC to generate a wake event. When this item is set to Enabled, the items Date of Month Alarm and Time (hh:mm:ss) Alarm items become user-configurable with set values.

Configuration options: [Disabled] [Enabled]



---

The items **Date of Month Alarm** and **Alarm Time** become user-configurable only when the item **Power On By RTC Alarm** is enabled.

---

### **Date of Month Alarm [0]**

To set the date of alarm, highlight this item and press <Enter> to display the Date of Month Alarm pop-up menu. Key-in a value within the specified range then press <Enter>.

Configuration options: [Min=0] [Max=31]

### **Alarm Time (hh:mm)**

To set the time of alarm:

1. Highlight this item and press <Enter> to display a pop-up menu for the hour field.
2. Key-in a value (Min=0, Max=23), then press <Enter>.
3. Press <TAB> to move to the minutes field then press <Enter>.
4. Key-in a minute value (Min=0, Max=59), then press <Enter>.
5. Press <TAB> to move to the seconds field then press <Enter>.
6. Key-in a value (Min=0, Max=59), then press <Enter>.

### **Restore on AC Power Loss [Power Off]**

Allows you to enable or disable the Restore on AC Power Loss function.

Configuration options: [Power Off] [Power On] [Last State]

### **PWR Button < 4 secs [Instant-Off]**

Allows you to set the event after the power button is pressed for more than 4 seconds.

Configuration options: [Suspend] [Instant-Off]

### **HPET Support [Enabled]**

Allows you to enable or disable the HPET Support.

Configuration options: [Enabled] [Disabled]



## 2.5.4 Hardware Monitor

The items in this sub-menu displays the hardware monitor values automatically detected by the BIOS. It also allows you to change CPU Q-Fan feature-related parameters. Select an item then press <Enter> to display the configuration options.

Phoenix-Award BIOS CMOS Setup Utility		
Power		
Hardware Monitor		Select Menu
Q-Fan Controller	[Enabled]	Item Specific Help ►►  Press [Enter] to enable or disable
Vcore Voltage	[1.56V]	
3.3V Voltage	[3.30V]	
5V Voltage	[5.05V]	
12V Voltage	[11.58V]	
CPU Temperature	48°C	
M/B Temperature	41°C	
CPU Fan Speed	3068 RPM	
Chassis Fan Speed	0 RPM	
CPU Fan Speed warning	[800 RPM]	
Start Up Temperature(°C)	[50]	
Full Speed Temperature(°C)	[70]	
Start Up PWM	[60]	
Slope PWM	[4 PWM/°C]	

F1: Help ↑↓ : Select Item      -/+ : Change Value      F5: Setup Defaults  
ESC: Exit      ←→ : Select Menu      Enter: Select SubMenu      F10: Save and Exit

### Q-Fan Controller [Enabled]

Allows you to enable or disable the Q-Fan controller.

Configuration options: [Disabled] [Enabled]

### Vcore Voltage, 3.3V Voltage, 5V Voltage, 12V Voltage

The onboard hardware monitor automatically detects the voltage output through the onboard voltage regulators. Configuration options: [xxx] [Ignored]

### CPU Temperature, M/B Temperature

The onboard hardware monitor automatically detects and displays the motherboard and CPU temperatures. These items are not user-configurable.

### CPU Fan Speed [xxxxRPM]

### Chassis Fan Speed [xxxxRPM]

The onboard hardware monitor automatically detects and displays the CPU, Chassis, and chip fan speeds in rotations per minute (RPM). If any of the fans is not connected to the motherboard, the field shows 0. These items are not user-configurable.

### CPU Fan Speed warning [600 RPM]

Sets the CPU fan speed warning feature.

Configuration options: [Disabled] [600RPM] [1200RPM] [1600RPM]

**Start Up Temperature(°C) [50]**

Fan will start up when the temperature is over the set value.

Configuration options: [Min=0] [Max=100]

**Full Speed Temperature(°C) [70]**

Fan will run at full speed when the temperature is over the set value.

Configuration options: [Min=0] [Max=100]

**Start Up PWM [80]**

Sets the PWM value when the fan starts up.

Configuration options: [Min=0] [Max=127]

**Slope PWM [4 PWM/°C]**

Sets the PWM value when the temperature increases one value.

Configuration options: [0 PWM/°C] [1 PWM/°C] [2 PWM/°C] [4 PWM/°C]

[8 PWM/°C] [16 PWM/°C] [32 PWM/°C] [64 PWM/°C]

## 2.6 Boot menu

The Boot menu items allow you to change the system boot options. Select an item then press <Enter> to display the sub-menu.

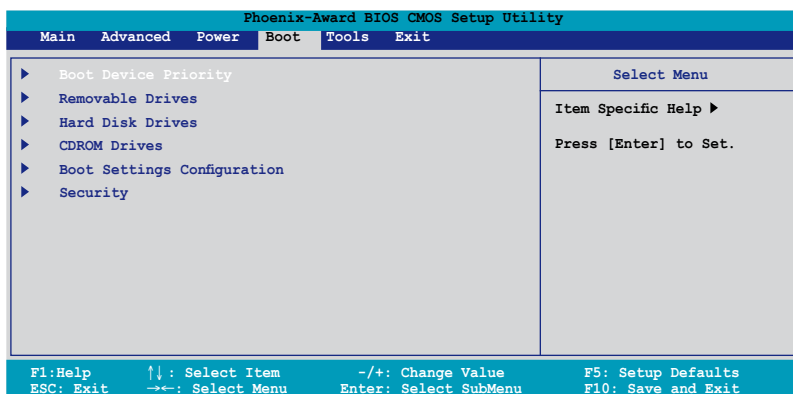

### 2.6.1 Boot Device Priority

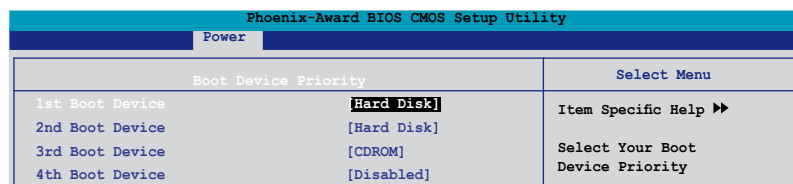

#### 1st ~ 4th Boot Device [Hard Disk]

These items specify the boot device priority sequence from the available devices. The number of device items that appears on the screen depends on the number of devices installed in the system.

Configuration options: [Removable] [Hard Disk] [CDROM] [Disabled]

### 2.6.2 Removable Drives

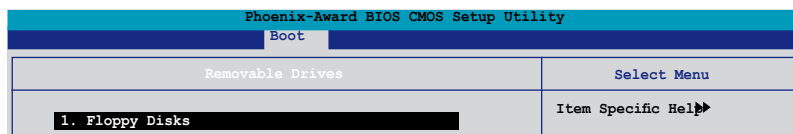

#### 1. Floppy Disks

Allows you to assign a removable drive attached to the system.

## 2.6.3 Hard Disk Drives

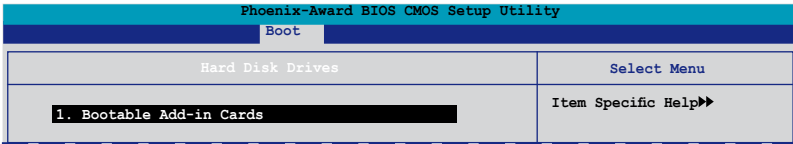

### 1. Bootable Add-in Cards

Allows you to assign bootable add-in cards attached to the system.

## 2.6.4 Boot Settings Configuration

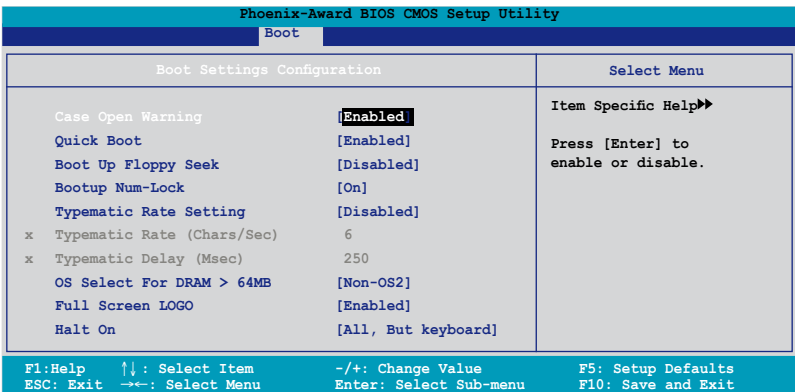

### Case Open Warning [Enabled]

Enables or disables the chassis open status feature. Setting to Enabled, clears the chassis open status. Refer to section “1.10.2 Internal connectors” for setting details. Configuration options: [Disabled] [Enabled]

### Quick Boot [Enabled]

Allows you to enable or disable the system quick boot feature. When Enabled, the system skips certain tests while booting. Configuration options: [Disabled] [Enabled]

### Boot Up Floppy Seek [Disabled]

Enables or disables the chassis open status feature. Setting to Enabled, clears the chassis open status. Configuration options: [Disabled] [Enabled]

### **Bootup Num-Lock [On]**

Allows you to select the power-on state for the NumLock.

Configuration options: [Off] [On]

### **Typematic Rate Setting [Disabled]**

Allows you to set the keystroke rate. Enable this item to configure the Typematic Rate (Chars/Sec) and the Typematic Delay (Msec).

Configuration options: [Disabled] [Enabled]



---

The items Typematic Rate (Chars/Sec) and Typematic Delay (Msec) become user-configurable only when the item Typematic Rate Setting is enabled.

---

### **Typematic Rate (Chars/Sec) [6]**

Allows you to select the rate at which a character repeats when you hold a key.

Configuration options: [6] [8] [10] [12] [15] [20] [24] [30]

### **Typematic Delay (Msec) [250]**

Allows you to set the delay before keystrokes begin to repeat.

Configuration options: [250] [500] [750] [1000]

### **OS Select for DRAM > 64MB [Non-OS2]**

Set this item to OS2 only when you are running on an OS/2 operating system with an installed RAM of greater than 64 KB.

Configuration options: [Non-OS2] [OS2]

### **Full Screen LOGO [Enabled]**

Allows you to enable or disable the full screen logo display feature.

Configuration options: [Disabled] [Enabled]



---

Make sure that the above item is set to [Enabled] if you want to use the ASUS MyLogo™ feature.

---

### **Halt On [All, But Keyboard]**

Allows you to error report type.

Configuration options: [All Errors] [No Errors] [All, But Keyboard] [All, But Diskette] [All, But Disk/Key]

## 2.6.5 Security

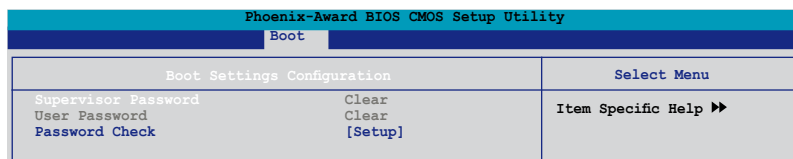

### Supervisor Password

### User Password

These fields allow you to set passwords:

To set a password:

1. Select an item then press <Enter>.
2. Type in a password using a combination of a maximum of eight (8) alphanumeric characters, then press <Enter>.
3. When prompted, confirm the password by typing the exact characters again, then press <Enter>. The password field setting is changed to Set.

To clear the password:

1. Select the password field and press <Enter> twice. The following message appears:



2. Press any key to continue. The password field setting is changed to Clear.

### A note about passwords

The Supervisor password is required to enter the BIOS Setup program preventing unauthorized access. The User password is required to boot the system preventing unauthorized use.

Forgot your password?

If you forget your password, you can clear it by erasing the CMOS Real Time Clock (RTC) RAM. The RAM data containing the password information is powered by the onboard button cell battery. If you need to erase the CMOS RAM, refer to section “1.9 Jumpers” for instructions.

## **Password Check**

This field requires you to enter the password before entering the BIOS setup or the system. Select [Setup] to require the password before entering the BIOS Setup.

Select [System] to require the password before entering the system.

Configuration options: [Setup] [System]

## 2.7 Tools menu

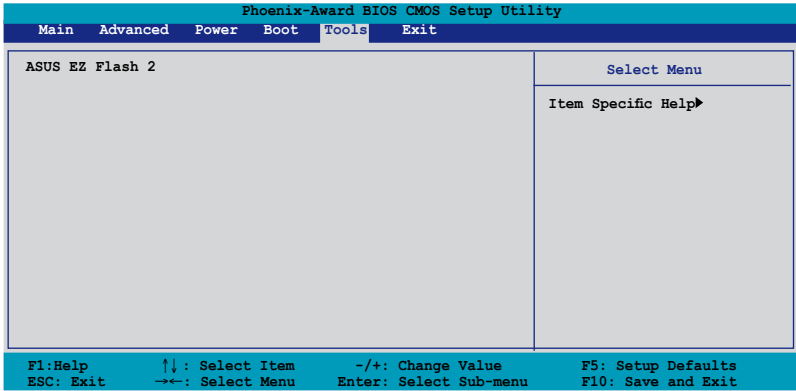

### 2.7.1 ASUS EZ Flash 2

Allows you to run ASUS EZ Flash 2. When you press <Enter>, a confirmation message appears. Use the left/right arrow key to select between [Yes] or [No], then press <Enter> to confirm your choice.

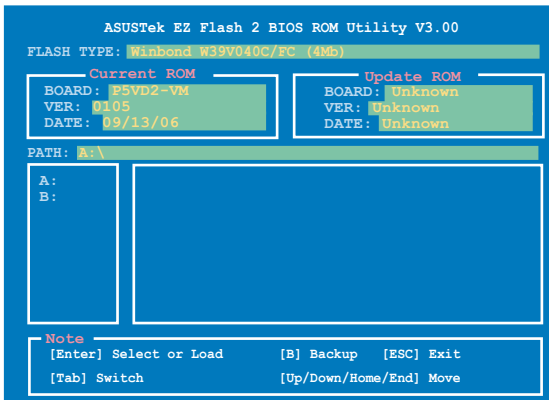

The model name may differ.



## 2.8 Exit menu

The Exit menu items allow you to load the optimal or failsafe default values for the BIOS items, and save or discard your changes to the BIOS items.

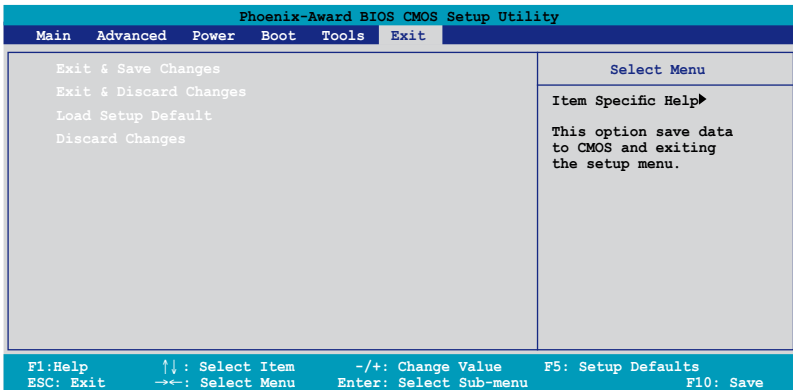

Pressing <Esc> does not immediately exit this menu. Select one of the options from this menu or <F10> from the legend bar to exit.

### Exit & Save Changes

Once you are finished making your selections, choose this option from the Exit menu to ensure the values you selected are saved to the CMOS RAM. An onboard backup battery sustains the CMOS RAM so it stays on even when the PC is turned off. When you select this option, a confirmation window appears. Select YES to save changes and exit.



If you attempt to exit the Setup program without saving your changes, the program prompts you with a message asking if you want to save your changes before exiting. Press <Enter> to save the changes while exiting.

### Exit & Discard Changes

Select this option only if you do not want to save the changes that you made to the Setup program. If you made changes to fields other than System Date, System Time, and Password, the BIOS asks for a confirmation before exiting.

## **Load Setup Defaults**

This option allows you to load the default values for each of the parameters on the Setup menus. When you select this option or if you press <F5>, a confirmation window appears. Select YES to load default values. Select Exit & Save Changes or make other changes before saving the values to the non-volatile RAM.

## **Discard Changes**

This option allows you to discard the selections you made and restore the previously saved values. After selecting this option, a confirmation appears. Select YES to discard any changes and load the previously saved values.

This chapter describes the contents of the support CD that comes with the motherboard package.

# 3 Software support

## 3.1 Installing an operating system

This motherboard supports Windows® 2000/XP/2003 Server operating systems (OS). Always install the latest OS version and corresponding updates to maximize the features of your hardware.



- Motherboard settings and hardware options vary. Use the setup procedures presented in this chapter for reference only. Refer to your OS documentation for detailed information.
- Make sure that you install Windows® 2000 Service Pack 4 or the Windows® XP Service Pack 1 or later versions before installing the drivers for better compatibility and system stability.

## 3.2 Support CD information

The support CD that came with the motherboard package contains the drivers, software applications, and utilities that you can install to avail all motherboard features.



The contents of the support CD are subject to change at any time without notice. Visit the ASUS website([www.asus.com](http://www.asus.com)) for updates.

### 3.2.1 Running the support CD

Place the support CD to the optical drive. The CD automatically displays the Drivers menu if Autorun is enabled in your computer.

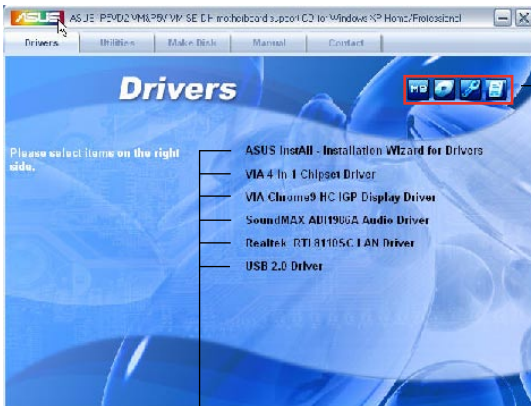

Click an icon to display support CD/motherboard information

Click an item to install



If Autorun is NOT enabled in your computer, browse the contents of the support CD to locate the file ASSETUP.EXE from the BIN folder. Double-click the ASSETUP.EXE to run the CD.

## 3.2.2 Drivers menu

The drivers menu shows the available device drivers if the system detects installed devices. Install the necessary drivers to activate the devices.



### **ASUS Install - Installation Wizard for Drivers**

Launches the ASUS InstallAll driver installation wizard.

### **VIA 4 in 1 Chipset Driver**

Installs the VIA 4 in 1 chipset Driver.

### **VIA Chrome9 HC IGP Display Driver**

Installs the VIA Chrome9 HC IGP Display Driver.

### **SoundMAX® ADI1986A Audio Driver**

Executes the wizard to install the SoundMAX® ADI1986A audio driver and application.

### **Realtek® RTL810SC LAN Driver**

Installs the Realtek® RTL810SC LAN driver for the LAN module.

### **USB 2.0 Driver**

Installs the USB 2.0 driver.

### **ASUS WiFi-AP Solo (For P5V-VM SE DH only)**

Installs the ASUS WiFi-AP Solo™ driver and application.

### **ASUS DH Remote (For P5V-VM SE DH only)**

Installs the ASUS DH Remote driver and application.

### 3.2.3 Utilities menu

The Utilities menu shows the applications and other software that the motherboard supports.

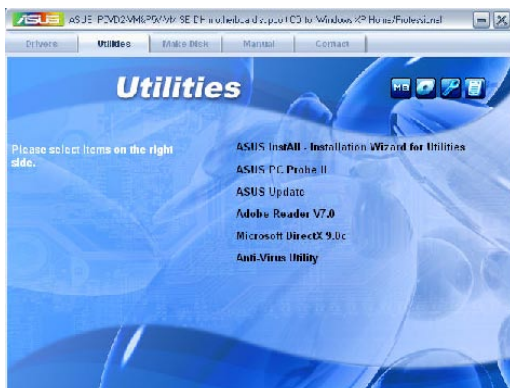

#### **ASUS InstAll - Installation Wizard for Drivers**

Launches the ASUS InstallAll driver installation wizard.

#### **ASUS PC Probe II**

This smart utility monitors the fan speed, CPU temperature, and system voltages, and alerts you of any detected problems. This utility helps you keep your computer in healthy operating condition.

#### **ASUS Update**

The ASUS Update utility allows you to update the motherboard BIOS in a Windows® environment. This utility requires an Internet connection either through a network or an Internet Service Provider (ISP). See page 2-8 for details.

#### **Adobe® Reader V7.0**

Installs the Adobe® Acrobat® Reader V7.0 that allows you to open, view, and print documents in Portable Document Formant (PDF).

#### **Microsoft DirectX 9.0c**

Installs the Microsoft® DirectX 9.0c driver.

#### **Anti-Virus Utility**

The anti-virus application scans, identifies, and removes computer viruses. View the online help for detailed information.

### 3.2.4 Make Disk menu

The Make Disk menu allows you to make a RAID driver disk.



#### Make VIA VT8237 RAID Driver Disk

Allows you to create a VIA VT8237 RAID driver disk.0

#### Make JMicron JMB36X 32/64 bit RAID/AHCI Driver

Allows you to create a JMicron JMB36X RAID driver disk for a 32/64-bit system.

### 3.2.5 Manuals menu

The Manuals menu contains a list of supplementary user manuals. Click an item to open the folder of the user manual.



Most user manual files are in Portable Document Format (PDF). Install the Adobe® Acrobat® Reader from the Utilities menu before opening a user manual file.

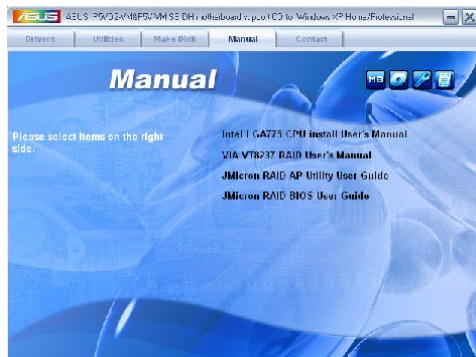

### Intel LGA775 CPU install User's Manual

Allows you to open the Intel® LGA775 CPU installation guide.

### VIA VT8237 RAID User's Manual

Allows you to open the VIA VT8237 RAID user's manual.

### JMicron RAID AP Utility User Manual

Allows you to open the JMicron RAID AP user's manual.

### JMicron RAID BIOS User Manual

Allows you to open the JMicron RAID BIOS user's manual.

## 3.2.6 ASUS Contact information

Click the Contact tab to display the ASUS contact information. You can also find this information on the inside front cover of this user guide.





### 3.3 RAID configurations

The motherboard supports the following RAID configurations.

RAID 0 (Data striping) optimizes two identical hard disk drives to read and write data in parallel, interleaved stacks. Two hard disks perform the same work as a single drive but at a sustained data transfer rate, double that of a single disk alone, thus improving data access and storage. Use of two new identical hard disk drives is required for this setup.

RAID 1 (Data mirroring) copies and maintains an identical image of data from one drive to a second drive. If one drive fails, the disk array management software directs all applications to the surviving drive as it contains a complete copy of the data in the other drive. This RAID configuration provides data protection and increases fault tolerance to the entire system. Use two new drives or use an existing drive and a new drive for this setup. The new drive must be of the same size or larger than the existing drive.

JBOD (Spanning) stands for Just a Bunch of Disks and refers to hard disk drives that are not yet configured as a RAID set. This configuration stores the same data redundantly on multiple disks that appear as a single disk on the operating system. Spanning does not deliver any advantage over using separate disks independently and does not provide fault tolerance or other RAID performance benefits.



---

If you want to boot the system from a hard disk drive included in a RAID set, copy first the RAID driver from the support CD to a floppy disk before you install an operating system to a selected hard disk drive. Refer to section “3.4 Creating a RAID driver disk” for details.

---

### 3.3.1 Installing hard disks

The motherboard supports RAID function on Serial ATA hard disk drives. For optimal performance, install identical drives of the same model and capacity when creating a disk array.

#### Installing Serial ATA (SATA) hard disks

To install the SATA hard disks for a RAID configuration:

1. Install the SATA hard disks into the drive bays.
2. Connect the SATA signal cables.
3. Connect a SATA power cable to the power connector on each drive.



---

Refer to the RAID controllers user manual in the motherboard support CD for detailed information on RAID configurations. See section “3.2.5 Manuals menu”.

---

#### Entering VIA Tech RAID BIOS Utility

1. Boot-up your computer.
2. During POST, press <Tab> to enter VIA RAID configuration utility.  
The following menu options will appear.



---

The RAID BIOS information on the setup screen shown below is for reference only. What you see on your screen may not exactly match what is shown here.

---

## Create Array

From the VIA RAID BIOS utility main menu, select Create Array then press <Enter>. The main menu items on the upper-left corner of the screen are replaced with create array menu options.

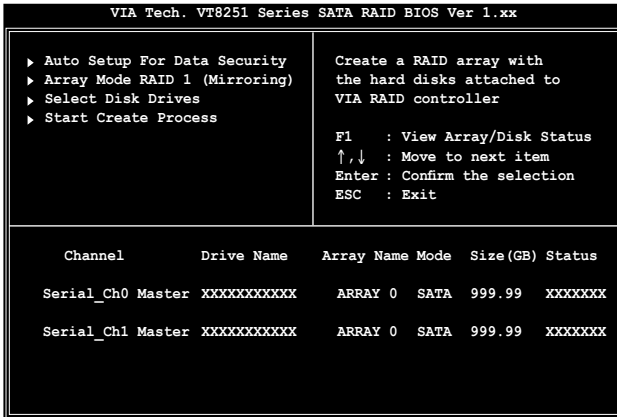

## RAID 0 for performance

1. From the create array menu, select Array Mode, then press <Enter>. The supported RAID configurations appear on a pop-up menu.

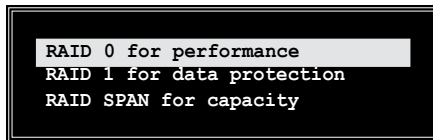

2. Select RAID 0 for performance then press <Enter>. From this point, you may choose to auto-configure the RAID array by selecting Auto Setup for Performance or manually configure the RAID array for striped sets. If you want to auto-configure, proceed to the next step, otherwise, skip to step 5.
3. Select Auto Setup for Performance and press <Enter>. The following confirmation message appears.

```
Auto create array will destroy all
data on disks, Continue? (Y/N)
```

4. Press <Y> to confirm or <N> to return to the configuration options. If you selected <Y>, proceed to step 9.
5. Select Select Disk Drives, then press <Enter>. Use arrow keys to select disk drive, then press <Enter> to mark selected drive. An asterisk appears before a selected drive.
6. Select Block Size, then press <Enter> to set array block size. A list of valid array block sizes are displayed on a pop-up menu.





---

TIP: For server systems, use of a lower array block size is recommended. For multimedia computer systems used mainly for audio and video editing, a higher array block size is recommended for optimum performance.

---

Use arrow keys to move selection bar on items and press <Enter> to select.

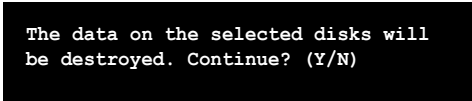
7. Select Start Create Process and press <Enter> to set up hard disk for RAID system. The following confirmation message appears:



8. Press <Y> to confirm or <N> to return to the configuration options.
9. Press <Esc> to go back to main menu.

### RAID 1 for data protection

1. From the create array menu, select Array Mode, then press <Enter>. The supported RAID configurations appear on a pop-up menu.

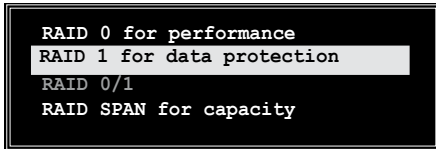

2. Select RAID 1 for data protection then press <Enter>.

3. From this point, you can auto-configure the RAID array by selecting Auto Setup for Data Security or manually configure the RAID array for mirrored sets. If you want to auto-configure, proceed to the next step, otherwise, skip to step 6.
4. Select Auto Setup for Data Security and press <Enter>. The following confirmation message appears.

```
Auto create array will destroy all
data on disks, Continue? (Y/N)
```

5. Press <Y> to confirm or <N> to return to the configuration options. If you selected <Y>, proceed to step 11.
6. Select Select Disk Drives, then press <Enter>. Use arrow keys to select disk drive/s, then press <Enter>. An asterisk appears before a selected drive.
7. Select Start Create Process and press <Enter> to setup hard disk for RAID system. The following inquiry appears:

```
Save the data on source disk to
mirror after creation? (Y/N)
```

8. If you select <Y> the utility will duplicate your data. Press <Y> anytime if you want to exit the duplication process.

```
Duplicating...
██████████
Press Yes(Y) to Escape
```

9. If you select <N>, the following confirmation message appears.

```
The data on the selected disks will
be
```

10. Press <Y> to confirm or <N> to return to the configuration options.
11. Press <Esc> to go back to main menu.

### 3.3.2 JMicron® RAID Configuration

The JMicron® Serial ATA controller allows you to configure RAID 0 and RAID 1 sets on the external Serial ATA hard disk drives.

#### Before creating a RAID set

Prepare the following items:

1. Two HDDs, preferably with the same model and capacity.
2. A write-enabled floppy disk
3. Microsoft® Windows® OS installation disk (Windows 2000/XP/2003)
4. Motherboard support CD with JMB363 driver

Complete the following steps before you create a RAID set:

1. Install an internal Serial ATA hard disk drive and an external Serial ATA hard disk drive on your system.



Install the internal Serial ATA hard disk drive to the SATA connector labeled SATA\_RAID1.

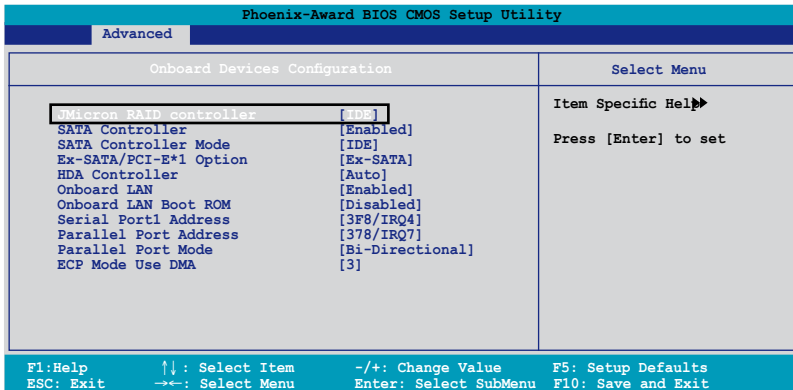

2. Set the **JMicon RAID Controller** item in the BIOS to [RAID]. See section “2.4.4 Onboard Devices Configuration” for details.
3. Enter the JMB363 RAID BIOS utility to set up your RAID configuration.
4. Create a JMB363 RAID driver disk for Windows® OS installation. See section “3.4 Creating a RAID driver disk” for details.
5. Install the JMB363 driver after the Windows® OS had been installed.

## Entering the JMB363 RAID BIOS utility

1. During POST, press <Ctrl-J> to enter the JMB363 RAID BIOS menu.

```
JMicron Technology Corp. PCI-to-SATA II/IDE RAID Controller BIOS v0.97
Copyright (C) 2004-2005 JMicron Technology          http://www. jmicron.com

HDD0 : HDS722516VLSA80                               164 GB Non-RAID
HDD1 : HDS722516DLA380                               164 GB Non-RAID

Press <Ctrl-J> to enter RAID Setup Utility...
```

2. The main JMB363 RAID BIOS menu appears.
3. Use the arrow keys to move the color bar and navigate through the items.

```
JMicron Technology Corp. PCI-to-SATA II/IDE RAID Controller BIOS v0.97

[Main Menu]
Create RAID Disk Drive
Delete RAID Disk Drive
Revert HDD to Non-RAID
Repair Mirror Conflict
Save and Exit Setup
Exit Without Saving

[Hard Disk Drive List]
Model Name      Capacity  Type/Status
HDD0: HDS722516VLSA80  164 GB  Non-RAID
HDD1: HDS722516DLA380  164 GB  Non-RAID

[RAID Disk Drive List]

[<--> TAB]-Switch Window  [↑↓]-Select Item  [ENTER]-Action  [ESC]-Exit
```

## Creating a RAID set

1. In the main JMB363 RAID BIOS menu, highlight Create RAID Disk Drive using the up/down arrow key then press <Enter>.

```
[Main Menu]
Create RAID Disk Drive
Delete RAID Disk Drive
Revert HDD to Non-RAID
Repair Mirror Conflict

Save and Exit Setup
Exit Without Saving
```

- 2. When the Level item is highlighted, use the up/down arrow key to select the RAID set that you want to create.



- 3. When the Disks item is highlighted, use the up/down arrow key to highlight an HDD that you want to belong to the RAID set, then press the space bar to confirm selection. Repeat the process until the HDDs are selected. A selected HDD shows a ► sign before it.

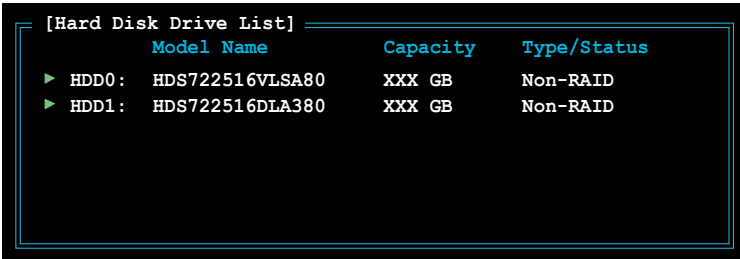

- 4. Key in the RAID volume capacity. Use the up/down arrow to choose the block size. The default value indicates the maximum allowed capacity.





- When done, press <Enter> to confirm the creation of the RAID set. A dialogue box appears to confirm the action. Press <Y> to confirm; otherwise, press <N>.

```
JMicron Technology Corp. PCI-to-SATA II/IDE RAID Controller BIOS v0.97
[Create New RAID]
Name: JRAID
Level: 0-Stripe
Disks: Select Disk
Block: 128 KB
Size : 319 GB
Confirm Creation

[Hard Disk Drive List]
Model Name Capacity Type/Status
▶ HDD0: HDS722516VLSA80 164 GB Non-RAID
▶ HDD1: HDS722516DLA380 164 GB Non-RAID

[RAID Disk I]
Create RAID on the selected HDD (Y/N) ? Y

[<--> TAB]-Switch Window [↑↓]-Select Item [ENTER]-Action [ESC]-Exit
```



Pressing <Y> deletes all the data in the HDDs.

- The following screen appears, displaying the relevant information about the RAID set you created.

```
[RAID Disk Drive List]
Model Name RAID Level Capacity Status Members (HDDx)
RDD0: JRAID 0-Stripe XXX GB Normal 01
```

## Deleting a RAID set

1. In the main JMB363 RAID BIOS menu, highlight Delete RAID Disk Drive using the up/down arrow key then press <Enter>.

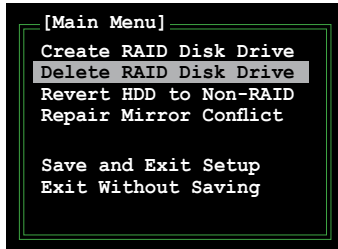

2. Use the space bar to select the RAID set you want to delete. A selected set shows a ► sign before it. Press the <Del> key to delete the set.
3. A dialogue box appears to confirm the action. Press <Y> to confirm; otherwise, press <N>.

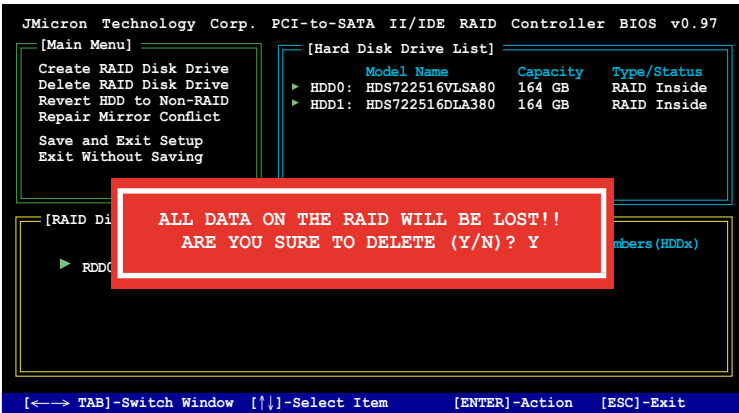

Pressing <Y> deletes all the data in the HDDs.

## Resetting disks to non-RAID



An HDD that has been previously configured as part of another RAID set in another platform is called a broken RAID HDD. When you install a broken RAID HDD, you cannot select this HDD when configuring a RAID set through the JMB363 utility.

If you still want to use this broken RAID HDD as part of the RAID set configured through the JMB363, you may do so by resetting the disk to non-RAID. You will, however, lose all data and previous RAID configurations.

To reset disks to non-RAID:

1. In the main JMB363 RAID BIOS menu, highlight Revert HDD to non-RAID using the up/down arrow key then press <Enter>.



2. Use the space bar to select the HDD that you want to reset to non-RAID. A selected HDD shows a ► sign before it.
3. A dialogue box appears to confirm the action. Press <Y> to confirm; otherwise, press <N>.



Pressing <Y> deletes all the data in the HDD.

## Repairing a Mirror conflict

A Mirror conflict occurs when one or both disks in a RAID 1 (Mirror) configuration are unplugged from the system, then plugged in again. Since both disks contain exactly the same data, the system will be unable to determine which of the two is the source drive. This option allows you to set the source drive and rebuild the Mirror drive according to the contents of the source drive.

To repair a Mirror conflict:

1. In the main JMB363 RAID BIOS menu, highlight Repair Mirror Conflict using the up/down arrow key then press <Enter>.



2. Use the space bar to select the HDD that you want to set as source drive. The selected HDD shows a ► sign before it.
3. Using the <TAB>, move to the RAID Disk Drive List menu and highlight the RAID set that you want to rebuild. Press <Del> to begin rebuilding the Mirror configuration.

A status bar at the bottom of the screen shows the progress of the rebuilding.

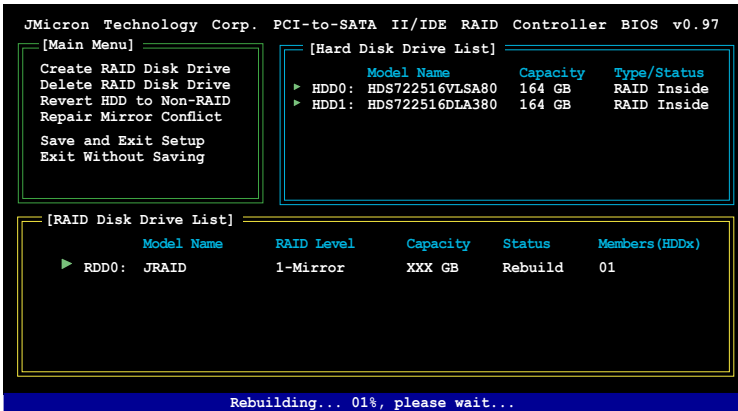

### **Saving the settings and exiting setup**

When you have finished, highlight Save & Exit Setup using the up/down arrow key then press <Enter> to save the current RAID configuration and exit the JMB363 RAID BOS utility.

A dialogue box appears to confirm the action. Press <Y> to confirm; otherwise, press <N> to return to the JMB RAID BIOS menu.

### 3.4 Creating a RAID driver disk

A floppy disk with the RAID driver is required when installing Windows® 2000/XP operating system on a hard disk drive that is included in a RAID set.

To create a VIA RAID driver disk:

1. Place the motherboard support CD into the CD-ROM drive.
2. When the **Make disk** menu appears, click **Make VIA VT8237 RAID Driver Disk** to create a VIA VT8237 RAID driver disk

Or

Browse the contents of the support CD to locate the driver disk utility and go to \Drivers\**VIA 4 in 1 Chipset Driver** for the VIA RAID driver disk utility



---

Refer to section “3.2.2 Drivers menu” for details.

---

3. Insert floppy disk to floppy disk drive.
4. Follow succeeding screen information to complete process.
5. Write-protect the floppy disk to avoid computer virus infection.

To create a JMicron RAID driver disk:

1. Place the motherboard support CD into the CD-ROM drive.
2. When the **Make disk** menu appears, click **Make JMicron JMB36X 32/64 bit RAID/AHCI Driver** to create a JMicron JMB363 RAID driver disk.
3. Insert floppy disk to floppy disk drive.
4. Follow succeeding screen information to complete process.
5. Write-protect the floppy disk to avoid computer virus infection.

To install the RAID driver:

1. During the OS installation, the system prompts you to press the F6 key to install third-party SCSI or RAID driver.
2. Press <F6> then insert the floppy disk with RAID driver into the floppy disk drive.
3. Follow the succeeding screen instructions to complete the installation.