

ASUS[®]

WiFi-TV

*IEEE 802.11a/b/g
Wireless LAN Adapter and
Digital/Analog TV/FM Radio Tuner
PCI Card*

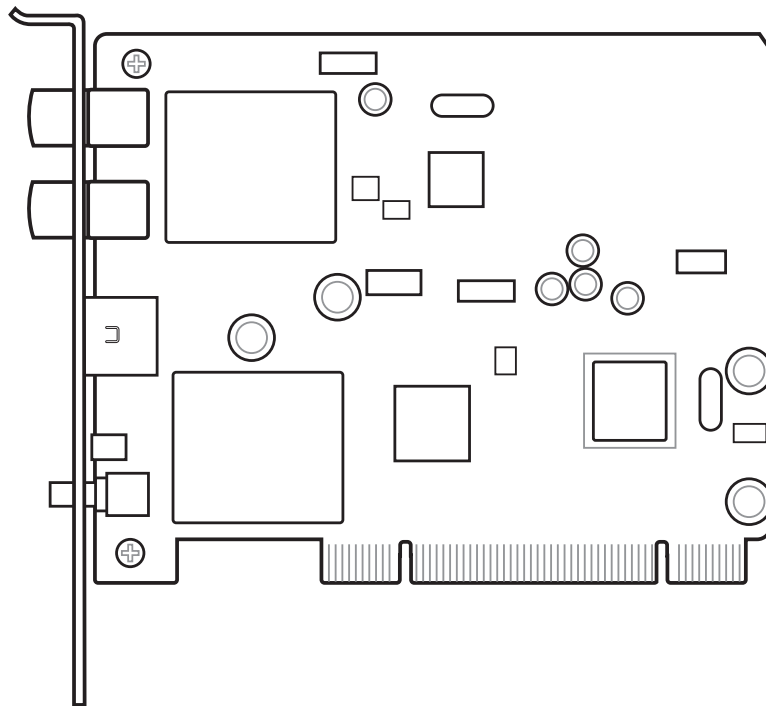

User guide

E2042

**First Edition V1
April 2005**

Copyright © 2005 ASUSTeK COMPUTER INC. All Rights Reserved.

No part of this manual, including the products and software described in it, may be reproduced, transmitted, transcribed, stored in a retrieval system, or translated into any language in any form or by any means, except documentation kept by the purchaser for backup purposes, without the express written permission of ASUSTeK COMPUTER INC. (“ASUS”).

Product warranty or service will not be extended if: (1) the product is repaired, modified or altered, unless such repair, modification or alteration is authorized in writing by ASUS; or (2) the serial number of the product is defaced or missing.

ASUS PROVIDES THIS MANUAL “AS IS” WITHOUT WARRANTY OF ANY KIND, EITHER EXPRESS OR IMPLIED, INCLUDING BUT NOT LIMITED TO THE IMPLIED WARRANTIES OR CONDITIONS OF MERCHANTABILITY OR FITNESS FOR A PARTICULAR PURPOSE. IN NO EVENT SHALL ASUS, ITS DIRECTORS, OFFICERS, EMPLOYEES OR AGENTS BE LIABLE FOR ANY INDIRECT, SPECIAL, INCIDENTAL, OR CONSEQUENTIAL DAMAGES (INCLUDING DAMAGES FOR LOSS OF PROFITS, LOSS OF BUSINESS, LOSS OF USE OR DATA, INTERRUPTION OF BUSINESS AND THE LIKE), EVEN IF ASUS HAS BEEN ADVISED OF THE POSSIBILITY OF SUCH DAMAGES ARISING FROM ANY DEFECT OR ERROR IN THIS MANUAL OR PRODUCT.

SPECIFICATIONS AND INFORMATION CONTAINED IN THIS MANUAL ARE FURNISHED FOR INFORMATIONAL USE ONLY, AND ARE SUBJECT TO CHANGE AT ANY TIME WITHOUT NOTICE, AND SHOULD NOT BE CONSTRUED AS A COMMITMENT BY ASUS. ASUS ASSUMES NO RESPONSIBILITY OR LIABILITY FOR ANY ERRORS OR INACCURACIES THAT MAY APPEAR IN THIS MANUAL, INCLUDING THE PRODUCTS AND SOFTWARE DESCRIBED IN IT.

Products and corporate names appearing in this manual may or may not be registered trademarks or copyrights of their respective companies, and are used only for identification or explanation and to the owners’ benefit, without intent to infringe.

Contents

Notices	v
Safety information	vi
About this guide	vii
WiFi-TV specifications summary	ix

Chapter 1: Product introduction

1.1 Welcome!	1-2
1.2 Package contents	1-2
1.3 Special features	1-3
1.3.1 Wireless LAN features	1-3
1.3.2 TV features	1-4
1.4 Card layout	1-5
1.5 LED indicator	1-5

Chapter 2: Installation

2.1 Card installation	2-2
2.1.1 System requirements	2-2
2.1.2 Installing the card	2-2
2.2 Connecting devices and accessories	2-3
2.2.1 Digital cable TV and FM radio	2-3
2.2.2 Analog cable TV	2-3
2.2.2 Television, VCR, or camcorder	2-3
2.2.3 Wi-Fi antenna	2-4
2.3 Driver installation	2-6
2.3.1 Running the support CD	2-6
2.3.2 Drivers menu	2-6
2.3.3 Manual menu	2-7
2.3.4 ASUS contact information	2-7
2.3.5 Wi-Fi driver and utilities installation	2-8

Chapter 3: Wi-Fi features

3.1 Recommended network setup	3-2
3.1.1 Ad-hoc mode	3-2
3.1.2 Infrastructure mode	3-2
3.1.3 Software Access Point (Soft AP)	3-3
3.1.4 Wireless bridge (Wireless Distribution System)	3-4
3.2 Using the One Touch wizard	3-5
3.2.1 Launching the setup wizard	3-5
3.2.2 Creating your own wireless LAN (One Touch)	3-5
3.2.3 Connecting to an access point	3-8
3.2.4 Connecting to another wireless device	3-9
3.2.5 Customizing your setup	3-11

Contents

3.3	Other software support	3-14
3.3.1	Control Center	3-14
3.3.2	Wireless Settings	3-16
3.3.3	Mobile Manager	3-17
3.3.4	Site Monitor	3-18

Chapter 4: TV features

4.1	Using PowerCinema	4-2
4.1.1	Launching PowerCinema	4-2
4.1.2	Optimizing your computer for multimedia	4-3
4.1.3	Navigating through the home page	4-6
4.1.4	Using the player controls	4-6
4.1.5	Watching TV	4-7
4.1.6	Watching movies	4-9
4.2	Using PowerDirector	4-10
4.2.1	Adjusting the sound recording settings	4-10
4.2.2	Creating movies	4-10

Appendix: Reference information

A.1	Wireless LAN channels	A-2
A.1.1	IEEE 802.11b/g	A-2
A.1.2	IEEE 802.11a	A-3
A.2.1	Using the remote controller	A-4
A.2	Remote controller	A-4
A.2.2	Remote controller layout	A-5
A.2.3	Remote controller functions	A-5
A.2.4	Mouse mode	A-6
A.3	International TV systems and standards	A-7

Notices

Federal Communications Commission Statement

This device complies with Part 15 of the FCC Rules. Operation is subject to the following two conditions:

- This device may not cause harmful interference, and
- This device must accept any interference received including interference that may cause undesired operation.

This equipment has been tested and found to comply with the limits for a Class B digital device, pursuant to Part 15 of the FCC Rules. These limits are designed to provide reasonable protection against harmful interference in a residential installation. This equipment generates, uses and can radiate radio frequency energy and, if not installed and used in accordance with manufacturer's instructions, may cause harmful interference to radio communications. However, there is no guarantee that interference will not occur in a particular installation. If this equipment does cause harmful interference to radio or television reception, which can be determined by turning the equipment off and on, the user is encouraged to try to correct the interference by one or more of the following measures:

- Reorient or relocate the receiving antenna.
- Increase the separation between the equipment and receiver.
- Connect the equipment to an outlet on a circuit different from that to which the receiver is connected.
- Consult the dealer or an experienced radio/TV technician for help.



The use of shielded cables for connection of the monitor to the graphics card is required to assure compliance with FCC regulations. Changes or modifications to this unit not expressly approved by the party responsible for compliance could void the user's authority to operate this equipment.

FCC RF Radiation Exposure Statement

This equipment complies with the FCC RF radiation exposure limits set forth for an uncontrolled environment. This equipment should be installed and operated with a minimum distance of 20 cm between the radiator and your

Canadian Department of Communications Statement

This digital apparatus does not exceed the Class B limits for radio noise emissions from digital apparatus set out in the Radio Interference Regulations of the Canadian Department of Communications.

This class B digital apparatus complies with Canadian ICES-003.

Safety information

Electrical safety

- To prevent electrical shock hazard, disconnect the power cable from the electrical outlet before relocating the system.
- When adding or removing devices to or from the system, ensure that the power cables for the devices are unplugged before the signal cables are connected. If possible, disconnect all power cables from the existing system before you add a device.
- Before connecting or removing signal cables from the motherboard, ensure that all power cables are unplugged.
- Seek professional assistance before using an adapter or extension cord. These devices could interrupt the grounding circuit.
- Make sure that your power supply is set to the correct voltage in your area. If you are not sure about the voltage of the electrical outlet you are using, contact your local power company.
- If the power supply is broken, do not try to fix it by yourself. Contact a qualified service technician or your retailer.

Operation safety

- Before installing the motherboard and adding devices on it, carefully read all the manuals that came with the package.
- Before using the product, make sure all cables are correctly connected and the power cables are not damaged. If you detect any damage, contact your dealer immediately.
- To avoid short circuits, keep paper clips, screws, and staples away from connectors, slots, sockets and circuitry.
- Avoid dust, humidity, and temperature extremes. Do not place the product in any area where it may become wet.
- Place the product on a stable surface.
- If you encounter technical problems with the product, contact a qualified service technician or your retailer.

About this guide

This user guide contains the information you need when installing and configuring the card.

How this guide is organized

This guide contains the following parts:

- **Chapter 1: Product introduction**
This chapter describes the card features and the new technologies it supports.
- **Chapter 2: Hardware and driver installation**
This chapter provides step by step instructions on how to install card and the card drivers and utilities to your computer.
- **Chapter 3: WiFi features**
This chapter provides information on the Wi-Fi features of the card including the recommended setup and bundled utilities.
- **Chapter 4: TV features**
This chapter provides information on the TV features of the card and the bundled software application.
- **Appendix: Reference information**
The Appendix provides information on the wireless LAN channels, remote controller, and TV standards in your location.

Where to find more information

Refer to the following sources for additional information and for product and software updates.

1. ASUS websites

The ASUS website provides updated information on ASUS hardware and software products. Refer to the ASUS contact information.

2. Optional documentation

Your product package may include optional documentation, such as warranty flyers, that may have been added by your dealer. These documents are not part of the standard package.

Conventions used in this guide

To make sure that you perform certain tasks properly, take note of the following symbols used throughout this user guide.



DANGER/WARNING: Information to prevent injury to yourself when trying to complete a task.



CAUTION: Information to prevent damage to the components when trying to complete a task.



IMPORTANT: Instructions that you **MUST** follow to complete a task.



NOTE: Tips and additional information to help you complete a task.

Typography

Bold text

Indicates a menu or an item to select.

Italics

Used to emphasize a word or a phrase.

<Key>

Keys enclosed in the less-than and greater-than sign means that you must press the enclosed key.

Example: <Enter> means that you must press the Enter or Return key.

<Key1+Key2+Key3>

If you must press two or more keys simultaneously, the key names are linked with a plus sign (+).

Example: <Ctrl+Alt+D>

Command

Means that you must type the command exactly as shown, then supply the required item or value enclosed in brackets.

Example: At the DOS prompt, type the command line:

format a:

WiFi-TV specifications summary

WiFi specifications

Interface	PCI bus
Wi-Fi Standard	IEEE 802.11g; IEEE 802.11a; IEEE 802.11b
Technology	Orthogonal Frequency Division Multiplexing (OFDM) Direct Sequence Spread Spectrum (DSSS)
Data transfer rates	802.11a/g : 54, 48, 36, 24,18, 12, 9, and 6 Mbps 802.11b : 11, 5.5, 2, and 1 Mbps
Supported networks	Infrastructure mode Ad-hoc mode (peer-to-peer) Software Access Point (Soft AP) mode* Wireless Bridge (Wireless Distribution System) mode*
Operating channels	802.11b/g : 2.40 ~ 2.4835 GHz 802.11a : 4.92 ~ 5.08 GHz 5.15 ~ 5.35 GHz 5.47 ~ 5.805 GHz
Security	64 or 128-bit Wired Equivalent Privacy (WEP) encryption Wi-Fi Protected Access (WPA)
Operating distance	Indoor : 130 ft (40 m) Outdoor : 1000 ft (310 m) LOS**
Operating temp.	-20°C ~ 65°C
Storage temp.	-30°C ~ 75°C
Compatibility	IEEE 802.11a/b/g devices
Supported OS	Windows® 2000/XP/2003 Server (32-bit version)
Accessory	Omni-directional dual-band antenna with magnetic base
LED	Green data transmission (AIR) LED
Software support	One Touch Wizard Control Center Wireless Settings Mobile Manager Site Monitor (client mode)

* On Windows® 2000/XP/2003 Server only

** Line-of-sight

(Continued on the next page)

WiFi-TV specifications summary

TV specifications

Interface	PCI bus
TV Standard	NTSC/PAL/SECAM
Supported technology	Analog TV Digital TV (DVB-T) FM radio
Ports	Analog PAL/SECAM Digital PAL/SECAM Audio-Video In
Software support	CyberLink PowerCinema CyberLink PowerDirector Intervideo® WinDVD Suite
Supported OS	Windows® XP
Accessories	WiFi-TV remote controller with USB IR receiver Audio-Video cable PAL/SECAM to NTSC RF adapter FM antenna

Specifications are subject to change without notice.

This chapter describes the card features and the new technologies it supports.

1 Product introduction

1.1 Welcome!

Thank you for buying an ASUS® WiFi-TV!

The WiFi-TV card delivers a host of new features and latest technologies, making it another standout in the long line of ASUS quality products!

Before you start installing the card, drivers, and software applications, check the items in your package with the list below.

1.2 Package contents

Check your WiFi-TV package for the following items.

PCI Card	ASUS WiFi-TV PCI card
Cable	Audio-Video cable
Accessories	Remote controller with two “AAA” batteries USB remote controller IR receiver with mounting tape PAL/SECAM to NTSC RF adapter Omni-directional dual-band antenna FM antenna
Support CD	ASUS WiFi-TV support CD includes: <ul style="list-style-type: none">• Card drivers• CyberLink PowerCinema• Cyberlink PowerDirector
Documentation	User guide



If any of the above items is damaged or missing, contact your retailer.

1.3 Special features

1.3.1 Wireless LAN features

54 Mbps speed advantage

With data transmission rate up to five times faster than IEEE 802.11b standards, the WiFi-TV breaks the wireless data transmission speed barrier to give you faster Internet connection and file sharing capabilities.

One Touch setup wizard

Designed for novice home users and experts alike, the One Touch setup wizard guides you through the entire setup process without the hassles of configuring confusing network settings.

The One Touch wizard guides you in configuring the WiFi-TV as an access point and intelligently configures the Internet connection sharing settings so you can share your Internet connection with other computers in your home or office network.

Easy integration and flexibility

Because WiFi-TV uses IEEE 802.11 a/b/g standard, you can easily integrate all wireless devices using different wireless standards. This flexibility lets you use the WiFi-TV card in almost any wireless LAN environment.

Soft access point function

If you are using a Windows® 2000/XP/Server 2003 operating system, you can transform the WiFi-TV card into a Software Access Point (Soft AP). When in Soft AP mode, WiFi-TV can support an unlimited number of client computers with wireless LAN adapters making it an ideal solution for homes and offices with single Internet connection or network printer.

Wireless bridge capability

Integrate several wireless LANs using the wireless bridge capability of the WiFi-TV. With the bundled software utilities, you can connect several wireless LANs in no time without buying expensive wireless LAN peripherals.

Full software support

The WiFi-TV support CD includes the latest utilities that could help you set up and create a wireless home or office network. These utilities also assist you in integrating the card to an existing wireless network.

Moveable omni-directional dual-band antenna

A moveable, omni-directional, dual-band antenna comes with your WiFi-TV card to maximize your wireless coverage.

1.3.2 TV features

Watch TV on your PC

The WiFi-TV card lets you watch TV on your PC. With a digital cable TV/FM radio and analog cable TV interfaces, WiFi-TV supports both digital (DVB-T) and analog cable TV and FM radio signals. Digital cable TV signals provide clearer, sharper images, and stereo quality sound. Contact your local cable TV provider for the availability of this service.

Supports various TV standards

The card supports NTSC, PAL, or SECAM TV standard. If the TV standard in your area is NTSC, use the PAL/SECAM to NTSC RF adapter to receive TV signals from your digital or analog cable TV provider.

Connectivity

If you want to watch on your television set or create a movie from your digital video recorder, you can use the supplied AV cable to connect the WiFi-TV to your television or camcorder. With this, you still enjoy digital or analog cable TV signals anytime. You can also use the AV cable to connect other multimedia devices such as VCRs and digital cameras.

Full software support

Your WiFi-TV package includes the PowerCinema application that allows you to watch and record your favorite TV programs, watch DVD/VCD movies, browse photos stored in your computer, or listen to your favorite music CD or FM radio station.

If you want to watch or create a movie from your home videos, you can connect your video recorder to the Audio-Video port and create a movie using the bundled PowerDirector application.

1.4 Card layout

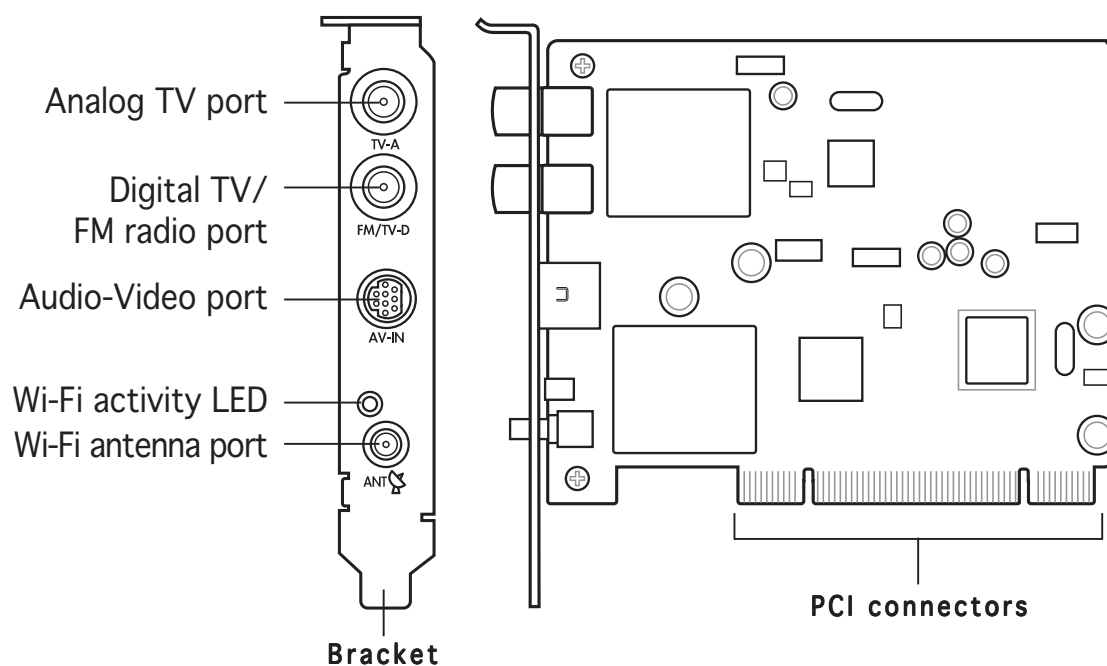

1.5 LED indicator

The card comes with a wireless LAN activity LED. Refer to the table below for the LED indications.

Wireless LAN LED indications

Status	Indication
On	The WiFi-TV is on but has no data activity
Off	The WiFi-TV card is off
Flashing	The WiFi-TV card is transmitting and/or receiving data The WiFi-TV card scanning for available access points or another wireless device

This chapter provides step by step instructions on how to install card and the card drivers and utilities to your computer.

Installation

2.1 Card installation

2.1.1 System requirements

Before installing the WiFi-TV card, make sure that your system meets the following requirements.

- Intel® Pentium™ 4 600+ series processor
AMD Athlon™ processor
- Windows® 2000/XP/2003 Server
- 64 MB system memory (minimum)
- Microsoft DirectX 9.0 or higher
- Windows Media Player 9 or higher
- Optical drive for utilities and driver installation
- Available PCI slot
- Local digital or analog cable TV subscription

2.1.2 Installing the card

To install the WiFi-TV card:

1. Remove the system unit cover (if your motherboard is already installed in a chassis).
2. Remove the bracket opposite the PCI slot that you intend to use. Keep the screw for later use.
3. Align the card connector with the slot and press firmly until the card is completely seated on the slot. Refer to the drawing on the right.
4. Secure the card to the chassis with the screw you removed earlier.
5. Replace the system cover.

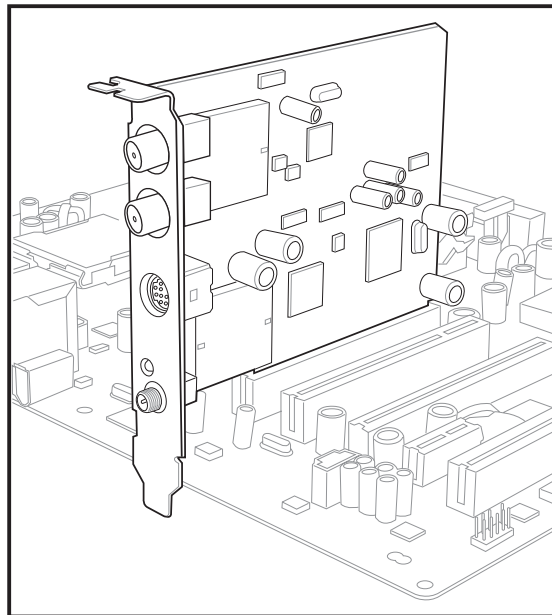

2.2 Connecting devices and accessories

2.2.1 Digital cable TV and FM radio

If you have a digital cable TV subscription, insert the cable TV connector to the cable port labeled TV-D to receive digital TV signals. You can also connect the bundled FM radio antenna to this port.

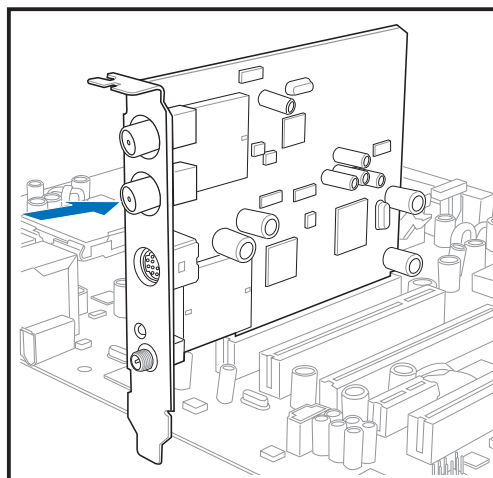

2.2.2 Analog cable TV

If you have an analog cable TV subscription, you can connect the cable TV connector to the cable port on connector to the lower coaxial cable port to receive analog TV signals.



If the TV standard in your location is NTSC, use the PAL/SECAM to NTSC RF adapter to receive cable TV signals. Refer to the Appendix for details.

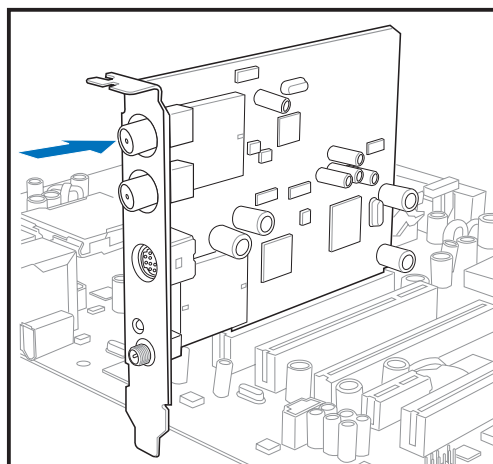



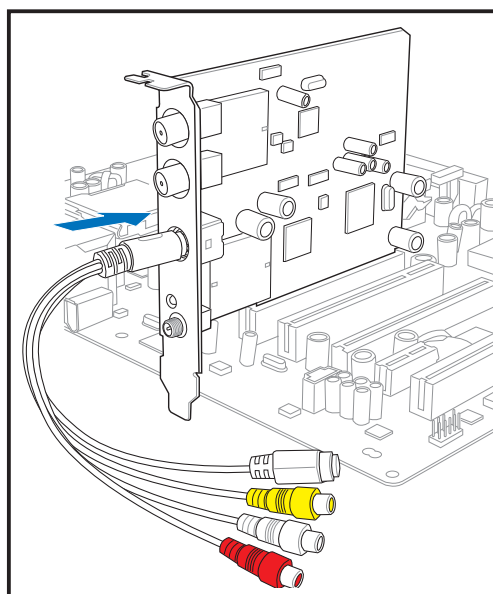

2.2.2 Television, VCR, or camcorder

If you want to watch TV on your television set or record TV shows on your VCR, DVD recorder or camcorder, you can use the supplied audio-video cable to connect these appliances.

Connect one end of the audio-video cable to the AV-IN port, then connect the plugs to the appliance. Refer to the plug specifications table on the next page.



Audio-Video cable plugs

Plug	Name (Color)	Connects to a
	S-Video (black)	television/VCR/camcorder with S-Video port
	Video In (yellow)	TV/VCR with a composite Video In port
	Left Audio In (white)	TV/VCR with a composite Left Audio In port
	Right Audio In (red)	TV/VCR with a composite Right Audio In port

2.2.3 Wi-Fi antenna

The multi-directional, moveable, and dual-band antenna maximizes the WiFi-TV wireless coverage.

To install the antenna:

1. Locate the wireless LAN antenna port on the card bracket.
2. Connect the antenna twist-on connector (female) to the wireless LAN antenna port (male).
3. Place the antenna at an elevated location to enhance your wireless coverage.

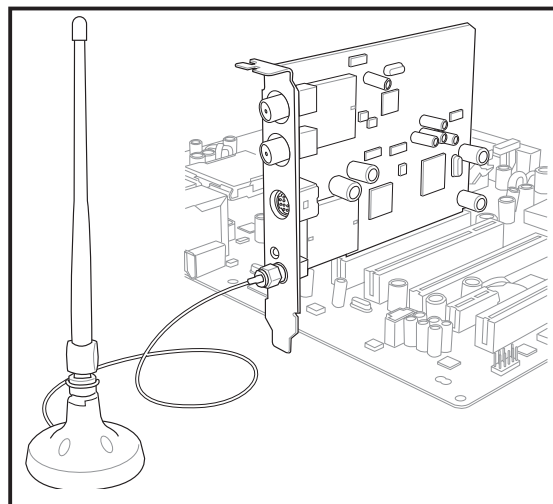

- Do not place the antenna under your table or in a closed compartment.
- The speed of wireless transmission decreases as you move farther from the access point. To achieve faster data transmission, minimize the distance between the WiFi-TV and the access point (Infrastructure mode) or the other wireless device.

Operating range

The WiFi-TV range is dependent on the operating environment. Every home or office layout varies in obstacles, barriers, or wall types that could reflect or absorb radio signals. For example, two wireless devices in an open space can achieve an operating distance of up to 200 ft, while the same devices can only achieve up to 80 ft when used indoors.

By default, the device automatically adjusts the data rate to maintain an operational wireless transmission. Therefore, a wireless device that is close to the access point may operate at higher speeds while a wireless device far from the access point may operate at lower speeds.

Site survey

A site survey (provided with the ASUS WiFi-TV card) analyzes the installation environment and recommends the best location for wireless LAN devices and access points.

2.3 Driver installation

The support CD that came with the WiFi-TV package contains the drivers and utilities that you can install to avail all card features. Make sure that you install all necessary motherboard drivers and utilities before installing the WiFi-TV drivers.



The contents of the support CD may change at any time without notice. Visit the ASUS website (www.asus.com) for updates.

2.3.1 Running the support CD

Place the support CD to the optical drive. The CD automatically displays the **Drivers** menu if Autorun is enabled in your computer.

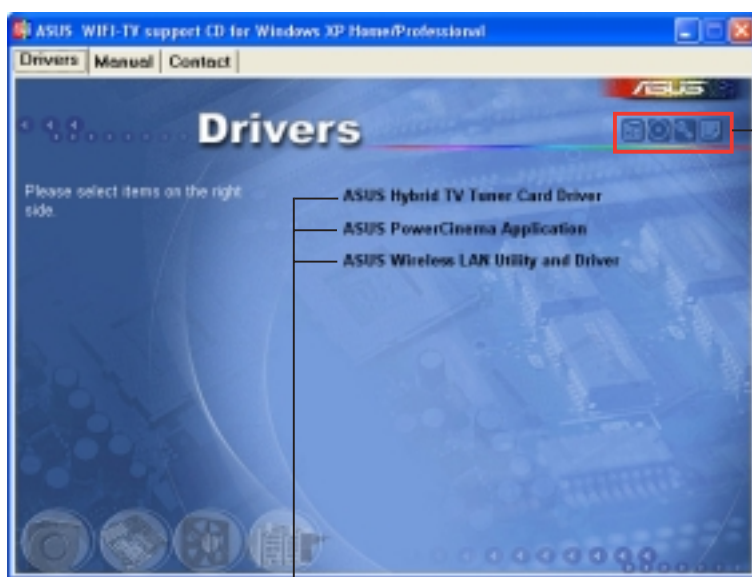

Click an icon to display support CD/motherboard information

Click an item to install



If **Autorun** is NOT enabled in your computer, browse the contents of the support CD to locate the file **ASSETUP.EXE** from the BIN folder. Double-click the **ASSETUP.EXE** to run the CD.

2.3.2 Drivers menu

The drivers menu shows the available device drivers and utilities. Install the necessary drivers to activate the card features

ASUS Hybrid TV Tuner Card Application

Installs the TV tuner driver.

ASUS PowerCinema Application

Installs the PowerCinema application.

ASUS Wireless LAN adapter Driver

Installs the driver and utilities for the wireless LAN adapter.

2.3.3 Manual menu

The **Manual** menu contains the user manual(s) for third party components and applications.

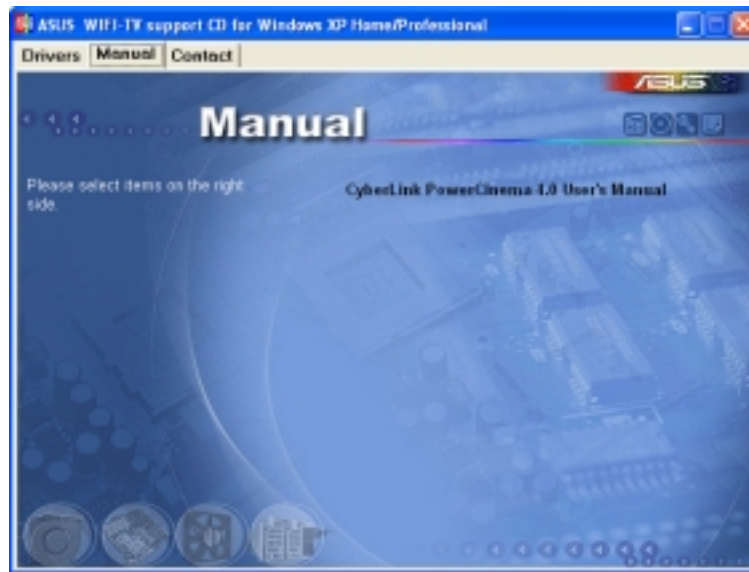

Most user manual files are in Portable Document Format (PDF). Install the Adobe Acrobat Reader application from the **Utilities** tab before opening a user manual file.

2.3.4 ASUS contact information

Click the **Contact** tab to display the ASUS contact information. You can also find this information on the inside front cover of this user guide.



2.3.5 Wi-Fi driver and utilities installation



If you are using a Windows® operating system, your computer auto-detects the WiFi-TV during start-up and displays an **Add New Hardware Wizard** window. Click **Cancel** then proceed with the following instructions.

To install the Wi-Fi driver and utilities:

1. Place the WiFi-TV card support CD to the optical drive.
2. The CD automatically displays the Drivers menu. See page 2-6 for details.
3. Click **ASUS Wireless LAN Utility and Driver**. The ASUS Wireless LAN Card installation window appears.



4. Click **Install ASUS WLAN Card Utilities/Driver**.
5. Follow screen instructions to complete installation.
6. When finished, restart your computer.

Windows® XP wireless options

If you are using Windows® XP, a **Wireless Option** window appears during startup. Select **Only use ASUS utilities and disable XP wireless function**, then click **OK**.

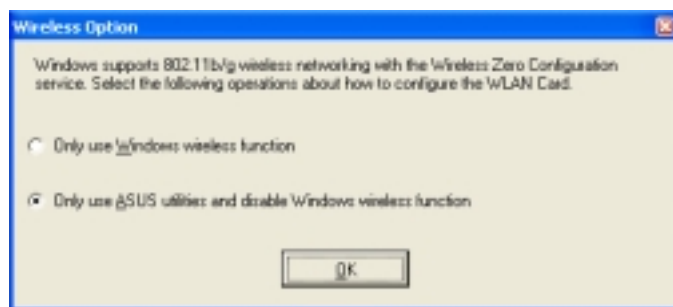

Make sure you select the ASUS utilities option to avail of the WiFi-TV Soft AP features.

This chapter provides information on the Wi-Fi features of the card including the recommended setup and bundled utilities.

Wi-Fi features **3**

3.1 Recommended network setup

You can use the ASUS WiFi-TV in various wireless network configurations. After installing the card and the wireless LAN adapter drivers to your computer, select the most appropriate configuration for your home or office wireless network.



The following descriptions are for reference only and may not exactly match your actual network configuration.

3.1.1 Ad-hoc mode

When in **Ad-hoc** mode, the WiFi-TV connects to another wireless device (also called station) within its operating range. Select this configuration when no access point (AP) is present in your wireless network.

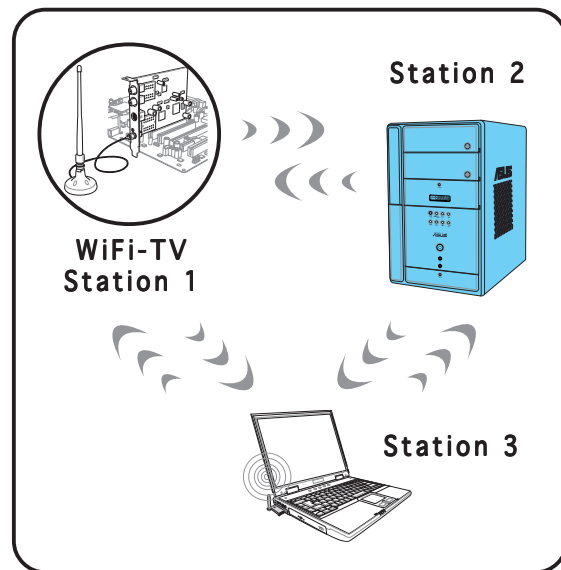

3.1.2 Infrastructure mode

In **Infrastructure** mode, the wireless network is centered on an access point (AP) that provides a central link for wireless clients to communicate with each other or with a wired network.

In this setup, the WiFi-TV functions as a wireless client/station that connects to an AP to establish connection to a wired or wireless LAN.

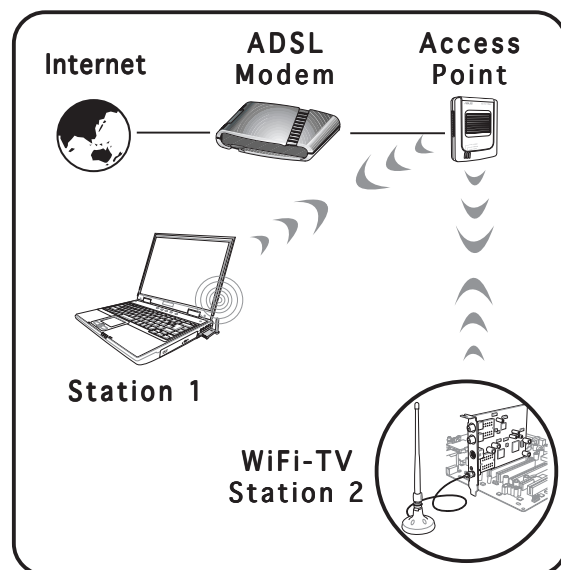

3.1.3 Software Access Point (Soft AP)

You can configure the WiFi-TV as a software access point (Soft AP). In this mode, the WiFi-TV becomes the access point that connects wireless clients to the Internet or network printer.

Set WiFi-TV to this mode if:

- you are using Windows® 2000/XP/2003 Server operating system
- the motherboard has an onboard Ethernet/Gigabit LAN adapter

The WiFi-TV Soft AP feature can support an unlimited number of wireless clients and is ideal for homes with several computers but with only a single Internet connection and/or one printer.

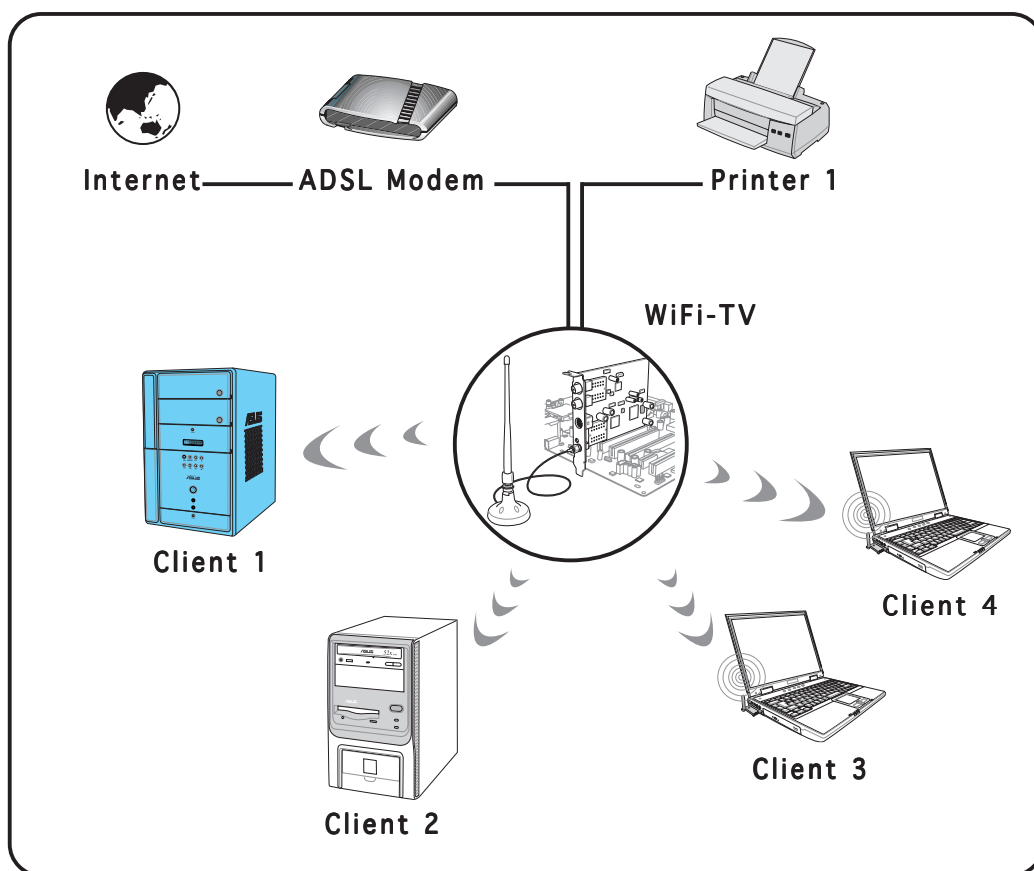

3.1.4 Wireless bridge (Wireless Distribution System)

In a wireless bridge setup, the WiFi-TV connects two or more APs while maintaining connection to its wireless clients. The wireless bridge feature of the WiFi-TV is a cost-effective solution for integrating several wireless networks.

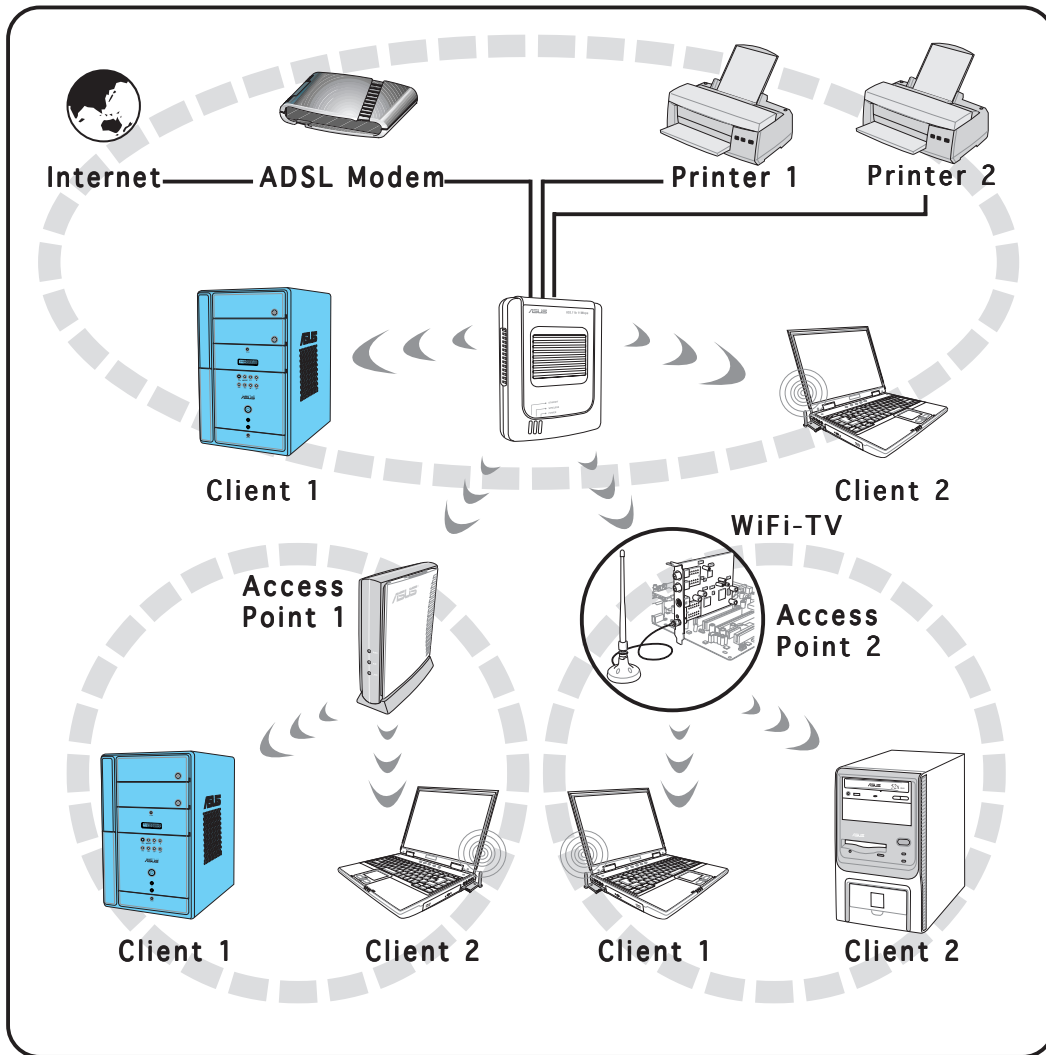

3.2 Using the One Touch wizard

The One Touch wizard allows you to configure the WiFi-TV through step-by-step instructions. The wizard helps you to:

- Configure the WiFi-TV as an access point, and
- Set the Internet connection sharing feature.



Make sure that you have selected the most appropriate configuration for your wireless home network before you proceed. Refer to section 3.1 “Recommended network setup” for details.

3.2.1 Launching the setup wizard

This utility launches automatically when you restart the system after installing the WiFi-TV drivers and utilities.

You can also launch the wizard from the desktop by clicking **Start > All Programs > ASUS Utility > WLAN Card > One Touch Wizard**.

3.2.2 Creating your own wireless LAN (One Touch)

You can create your own wireless local area network (WLAN) in your home if your:

- home network does not have an existing access point
- computer is connected to the Internet and you intend to share this connection to other computers/devices in your home network
- other computers/devices have an IEEE 802.11 a/b/g wireless LAN adapter (i.e. Centrino™ notebooks, PDAs with Wi-Fi feature)
- operating system is Windows® 2000/XP/2003 Server

To create your own wireless LAN:

1. In the **Operation Mode** section, select **Create a new Wireless LAN (AP)**, then select **One Touch (Recommended for home users)**.
2. Click **Next**.

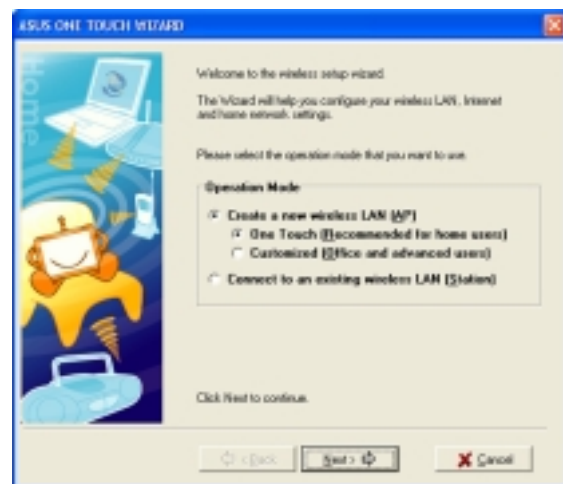

3. Assign a Service Set Identifier (SSID) for the WiFi-TV (i.e. Tech Comm Department).



By default, the wizard uses the computer name as the SSID. The SSID identifies the wireless device in a network. All wireless devices within a network must have the same SSID to establish connection.



4. Check the **Data encryption (WEP-enabled)** option if you want to secure your wireless network with a Wired Equivalent Privacy (WEP) key, then click **Next**.

The wizard automatically configures the WiFi-TV card settings indicates that you have successfully created your wireless LAN.

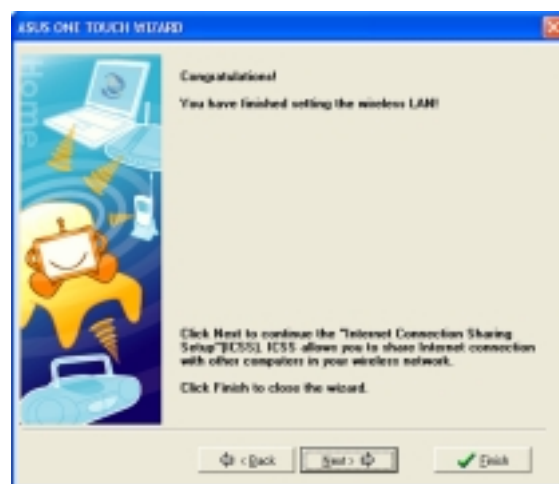

5. If the access point has an enabled DHCP server, select **Obtain an IP address automatically**; otherwise, assign the IP address manually by entering the values in the IP address field.



Inquire the IP address with your network administrator.

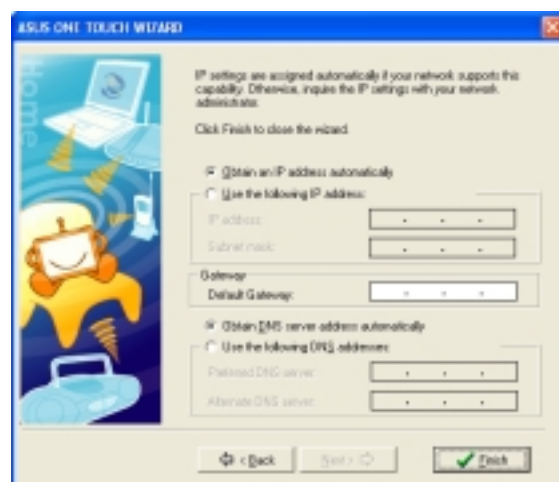

6. Click **Finish**.

7. An **Important Information** window displays the WiFi-TV settings.

Write down the SSID and encryption settings in a piece of paper for reference.

Click **OK** to close the window.



All wireless computers/ devices in your home network must have the same settings as that of the WiFi-TV to establish connection.

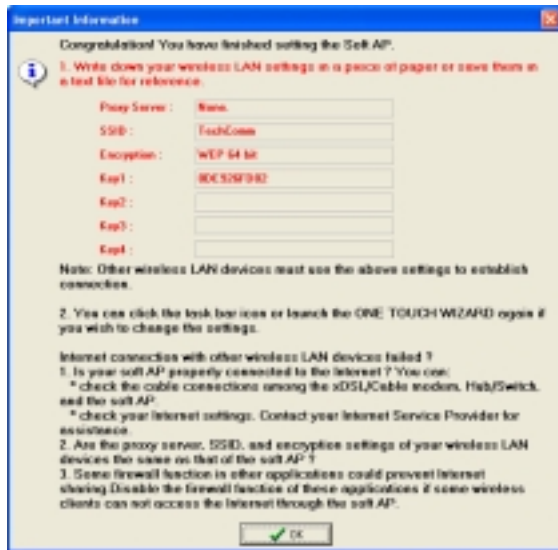



3.2.3 Connecting to an access point

If you have an existing access point in your home network, follow these instructions to connect the WiFi-TV to the access point.

1. Launch the One Touch wizard.
2. Select **Connect to other Wireless LAN (Station)**, then click **Next**.

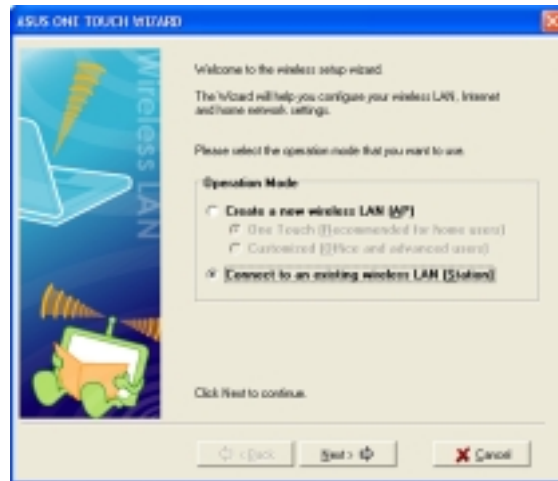
The wizard scans for available access point(s) and wireless devices in your location.



3. Select an access point from the list, then click **Next**. An access point is marked with the icon .

The wizard connects the WiFi-TV to the selected access point.

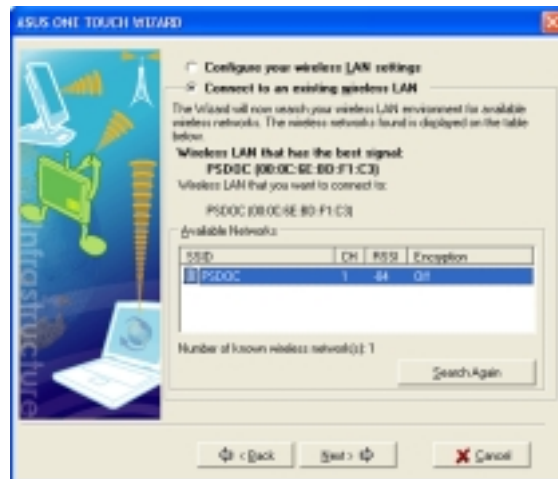

4. When connected to an access point, the wizard displays the connection information.

Click **Next** to configure the TCP/IP settings.

If the WiFi-TV fails to connect to an access point, the wizard instructs you to change the WiFi-TV settings or click the **Back** button to rescan.

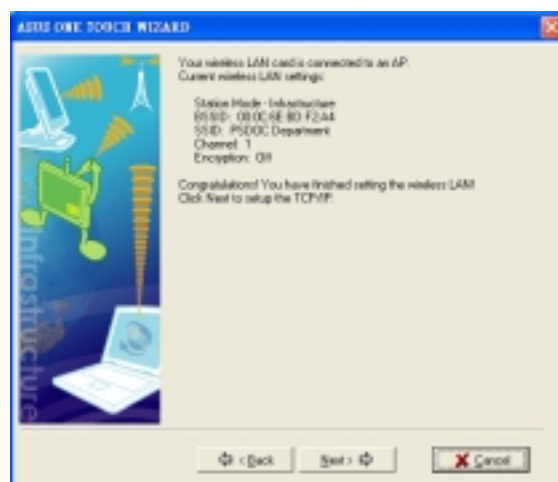

- If the access point has an enabled DHCP server, select **Obtain an IP address automatically**; otherwise, assign the IP address manually by entering the values in the IP address field.



Inquire the IP address with your network administrator.

- Click **Finish**.

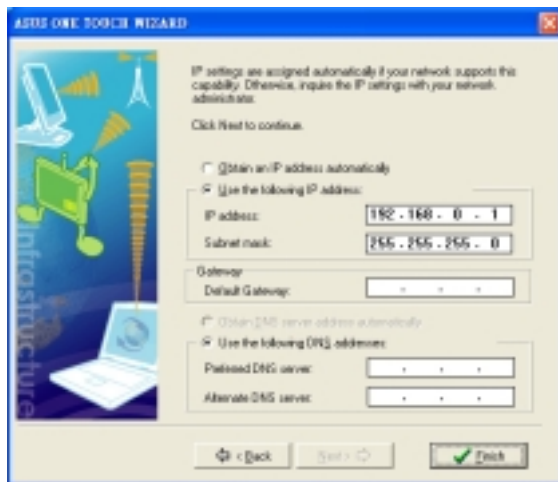



3.2.4 Connecting to another wireless device

If no access point or Internet connection is present in your home network, you can use the wizard to connect the WiFi-TV to another wireless computer, notebook, or PDA for file or printer sharing. This is called an **Ad-hoc** network.

To connect to another wireless computer or device:

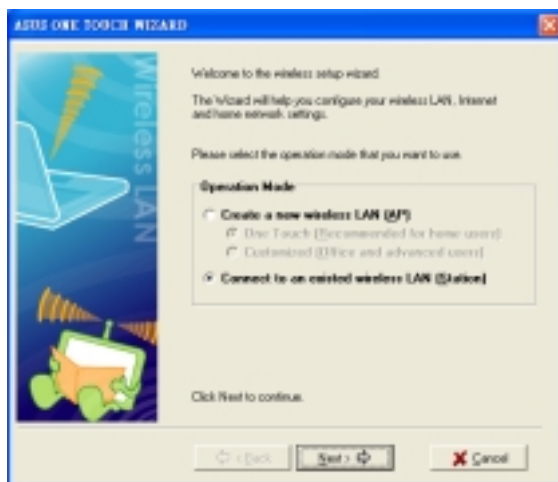
- Launch the One Touch wizard.
- Select the **Connect to other Wireless LAN (Station)** option, then click **Next**.



- Select a wireless device from the list, then click **Next**. A wireless device is marked with the icon .

The wizard connects the WiFi-TV to the selected wireless device.

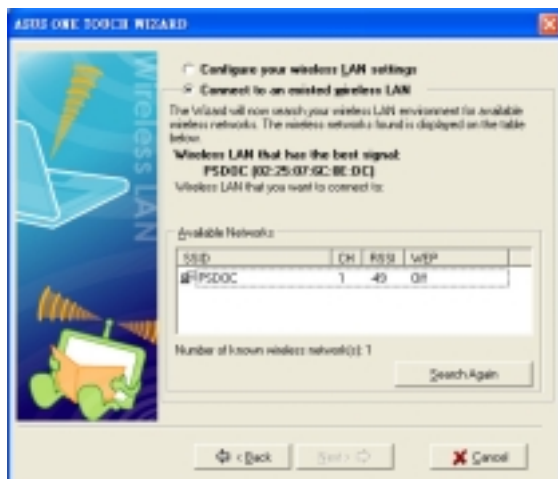



The window design changes from **Wireless LAN** to **Ad Hoc** when you highlight a wireless device from the list.

4. When connected to the wireless device, the wizard displays the connection information.

Click **Next** to configure the TCP/IP settings.

If the WiFi-TV fails to connect to a wireless device, the wizard instructs you to change the WiFi-TV settings or click the **Back** button to rescan.

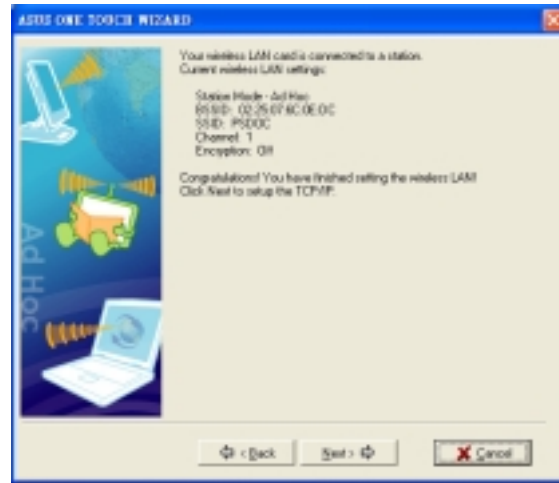

5. Assign the IP address manually by entering the values in the IP address field.

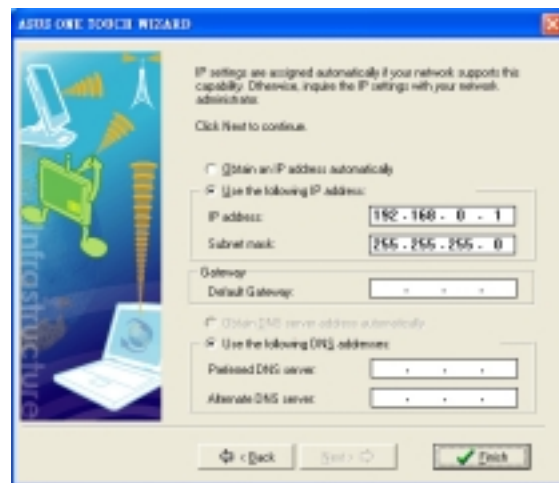

In an Ad-hoc network, you must specify the WiFi-TV IP address manually. Make sure that the WiFi-TV IP address is on the same subnet as that of the other wireless device to establish connection. For example, if the other wireless device IP is 192.168.0.1, then the WiFi-TV IP must be 192.168.0.X, where X = 2 ~ 254).

6. Click **Finish**.

3.2.5 Customizing your setup

If you are familiar with wireless network settings, you can configure the WiFi-TV using the **Customized (Office and Advanced Users)** option in the setup wizard.

To customize the WiFi-TV setup:

1. Launch the One Touch wizard.
2. Select **Create a new wireless LAN (AP)** from the **Operation Mode** field, then select **Customized (Office and advanced users)**.
3. Click **Next**.

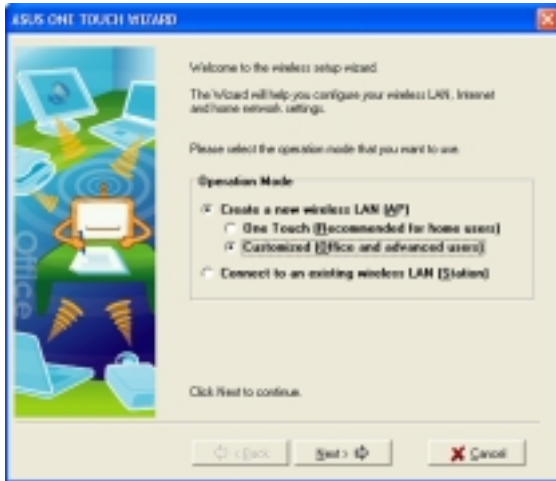

4. Assign a Service Set Identifier (SSID) for the WiFi-TV (i.e. Tech Comm Department).



By default, the wizard uses the computer name as the SSID. The SSID identifies the wireless device in a network. All wireless devices within a network must have the same SSID to establish connection.



5. Select the WiFi-TV card channel or check the **Auto Channel Selection** option to allow the wizard to assign the clearest channel.



If you specified a channel, all wireless devices within the network must use the same channel to establish connection.

6. Click **Next** to continue.

- Set the **Network Authentication** to **Open** or **Shared**. Refer to the table below for a comparison of the network authentication methods.

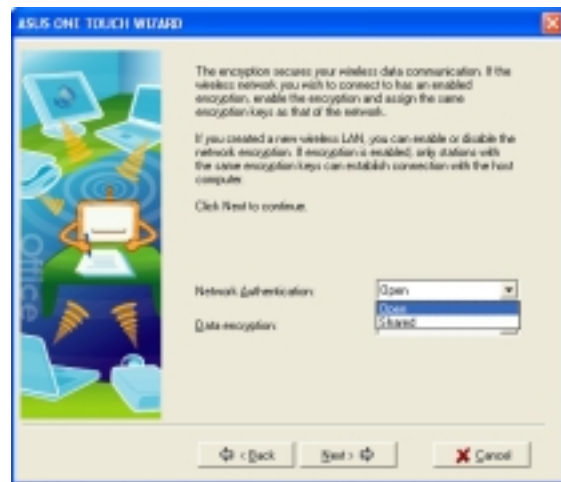

Network authentication methods

Method	Description
Open	The WiFi-TV accepts connection requests from any wireless device within its operating range.
Shared	Only wireless device(s) with the same encryption are allowed connection to the WiFi-TV.

- Enable **Data Encryption**, then click **Next**.

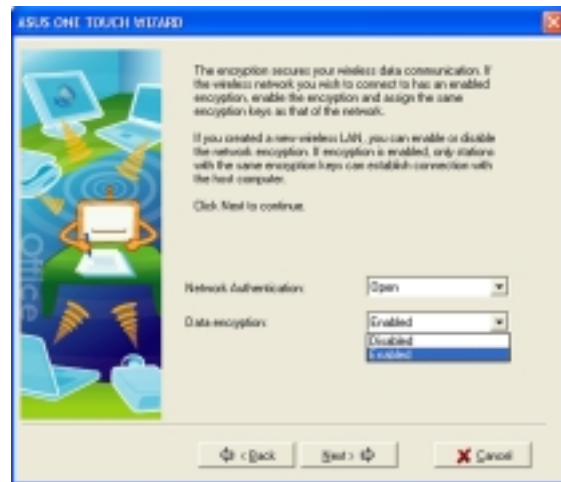

- When you enable **Data Encryption**, select the Wired Equivalent Privacy (WEP) encryption **Key Format** and **Key Length**, then select the generation mode.



Refer to the next page for ways on how to set the WEP encryption keys.

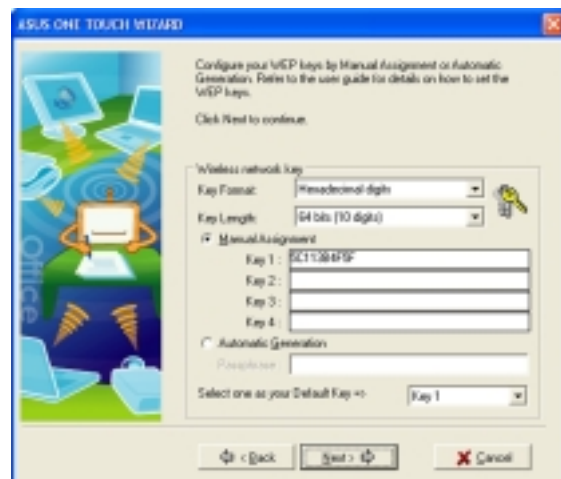

Assign the WEP keys then click **Next**.

Two ways to assign WEP keys

Manual Assignment. For a 64-bit encryption, enter 10 hexadecimal digits (0 ~ 9, a ~ f, A ~ F) or five ASCII characters in each of the four WEP keys. For 128-bit encryption enter 26 hexadecimal digits (0 ~ 9, a ~ f, A ~ F) or 13 ASCII characters in each of the four WEP keys.

Automatic Generation. Type a combination of up to 64 letters, numbers, or symbols in the **Passphrase** field. The utility uses an algorithm to generate four WEP keys based on the typed combination.

10. Select **Obtain an IP address automatically**; otherwise, assign the IP address manually by entering the values in the IP address field.
11. Click **Finish**.

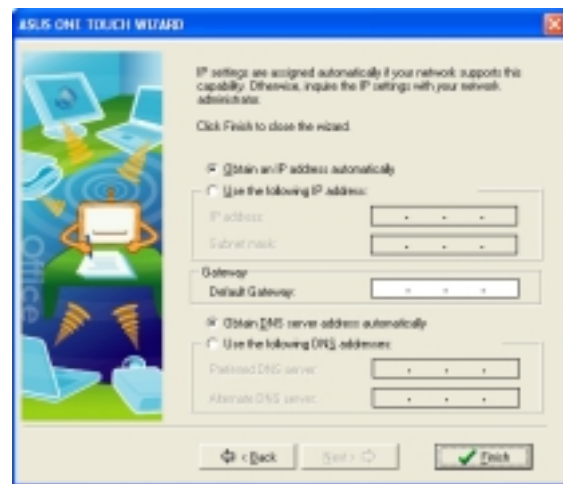

12. The wizard configures the WiFi-TV card settings, then displays an **Important Information** window. Write down the SSID and encryption settings in a piece of paper for reference. Click **OK** to close the window.



All wireless computers/
devices in your home network
must have the same settings
as that of the WiFi-TV to
establish connection to the
Internet.

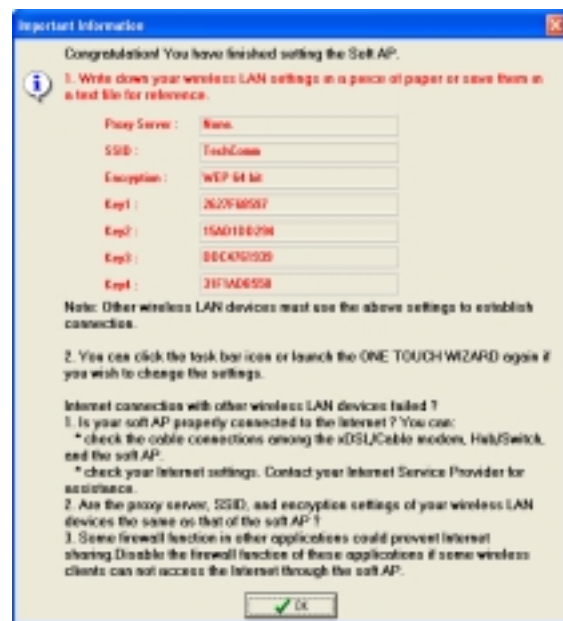

3.3 Other software support

The WiFi-TV comes with several utilities to configure and set up the WiFi-TV in your home or office network. The following applications are automatically installed when you install the WiFi-TV drivers and utilities.



The bundled software applications are subject to change without notice. Visit the ASUS website for updates.

3.3.1 Control Center

Use this utility to launch the Wireless Settings, Mobile Manager, and Site Monitor applications. During system startup, the Control Center launches automatically and displays an icon in the taskbar. This icon provides Internet connection and link quality indications.

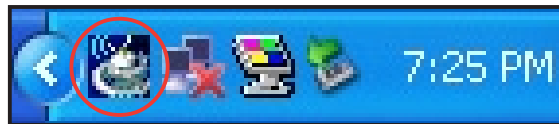

Control Center icons

The Control Center icon changes automatically to indicate the WiFi-TV mode, Internet connection status, and link quality to an access point or another wireless device. Refer to the table below for Control Center icon indications.

Infrastructure mode (WiFi-TV to an access point)

Icon	Indication	Icon	Indication
	Excellent link quality and connected to the Internet		Excellent link quality but not connected to the Internet
	Good link quality and connected to the Internet		Good link quality but not connected to the Internet
	Fair link quality and connected to the Internet		Fair link quality but not connected to the Internet
	Poor link quality but connected to the Internet		Poor link quality and not connected to the Internet
	Not linked but connected to the Internet		Not linked and not connected to the Internet

Ad-hoc mode (WiFi-TV to another wireless device)

Icon	Indication
	The WiFi-TV is connected to a wireless device.
	The WiFi-TV is not connected to a wireless device.
	The WiFi-TV is connected to the Internet.

Access point mode

Icon	Indication
	The WiFi-TV is in access point mode.

Right-click menu

Right-clicking the Control Center icon displays the WiFi-TV software applications. Refer to the succeeding sections for details on these applications.

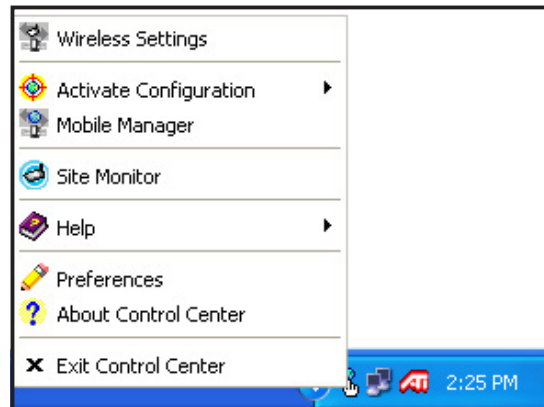

Left-click menu

Left-clicking the Control Center icon displays the left-click menu.

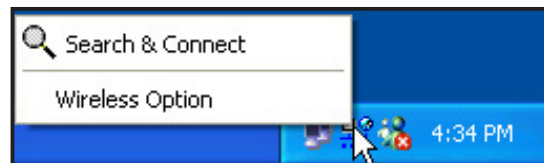

Search & Connect – View available wireless networks within range.

Wireless Option – This window allows you to select the utility to use in the configuring the WiFi-TV. Select **“Only use ASUS utilities and disable Windows wireless function”** to avail all WiFi-TV features.

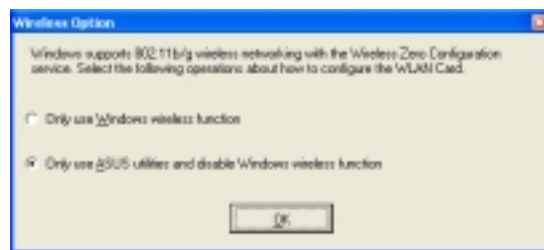

3.3.2 Wireless Settings

The **Wireless Settings** is the main interface that allows you to control the WiFi-TV. Use the Wireless Settings to view the operational and connection status, or to modify the WiFi-TV configuration.

To launch the Wireless Settings utility, click the **ASUS WLAN Control Center** icon on the desktop or right-click the Control Center icon on the taskbar, then select **Wireless Settings** from the menu.

Click the icons on the left panel to display the information or configuration sheet on the right.

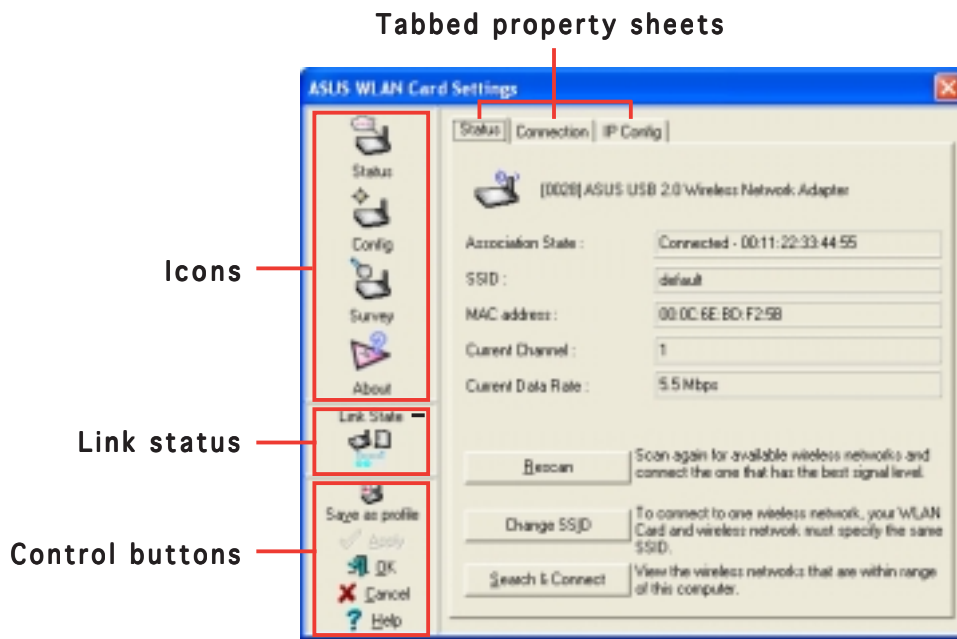

Click **Help** for detailed information on the Wireless Settings.

3.3.3 Mobile Manager

The **Mobile Manager** is a convenient tool to set up and manage multiple alternative network settings for different locations. You must set up this utility once so you can easily switch configurations when changing locations.

To launch the Mobile Manager utility:

Click the **Start > All Programs > ASUS Utility > WLAN Card > Mobile Manager** from the Windows® desktop.

OR

Right-click the **Control Center** icon on the taskbar, then select **Mobile Manager** from the menu.

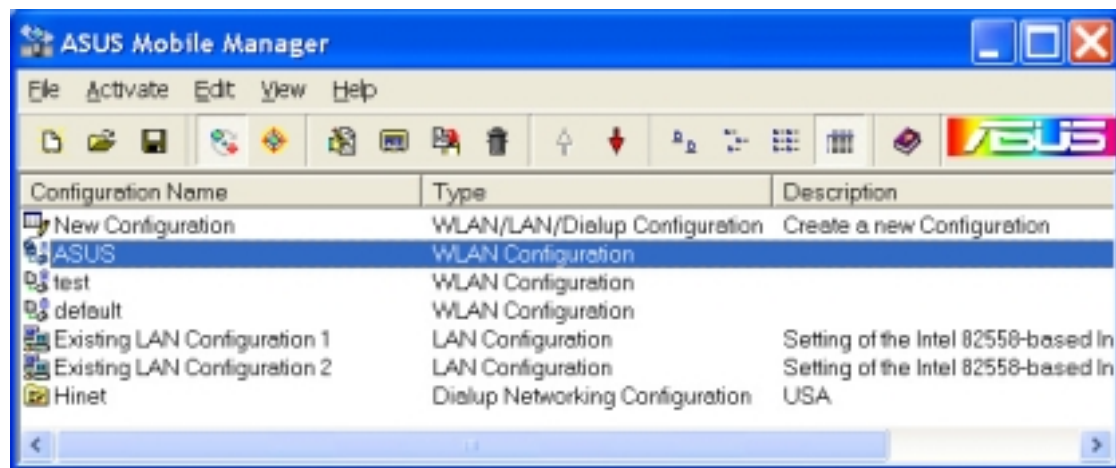

You can use the Mobile Manager utility main window to create, edit, or activate a configuration. The main window displays the menu bar, toolbar, and existing configurations.

Click the toolbar buttons to access common commands in the Mobile Manager utility. All toolbar button commands are also available from the menu bar.



See the help file for details on the ASUS Mobile Manager.

3.3.4 Site Monitor

The **Site Monitor** utility measures the signal-to-noise (SNR) values of all available wireless networks. Use this utility to determine the best location to place the WiFi-TV.

To launch the Site Monitor:

1. Click the **Start**, then select **Programs > ASUS Utility > WLAN Card > Site Monitor**, or
Right-click the **Control Center** icon on the taskbar, then select **Site Monitor** from the menu.
2. Click **OK** when the **Site Survey Message** appears.

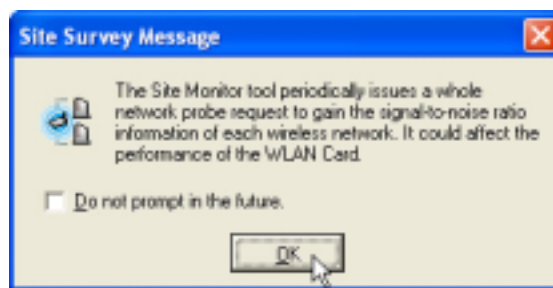

The Site Monitor main window displays the available wireless connections and the signal-to-noise (SNR) value of a selected connection.

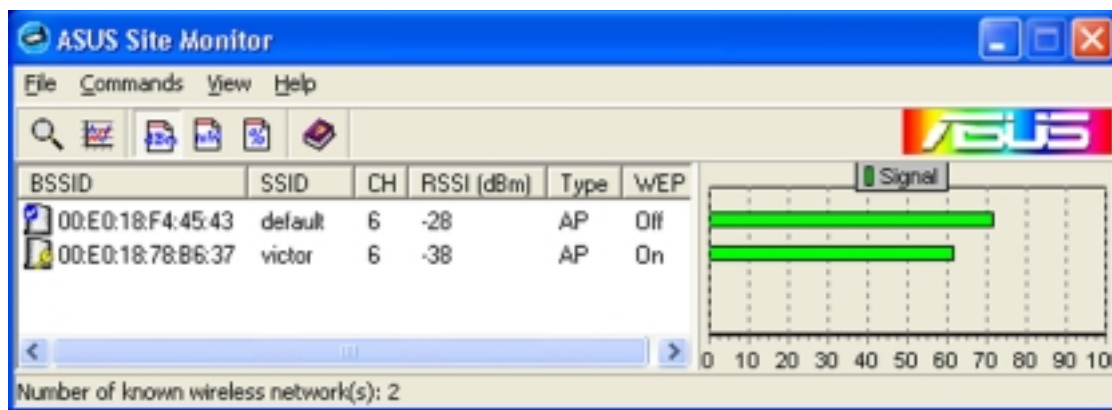

- Some AP disable their SSID broadcasting to hide themselves from the Site Monitor. You can join these APs if you specify the same SSID.
- Click **Help** for details on the ASUS Site Monitor.

This chapter provides information on the TV features of the card and the bundled software application.

TV features

4.1 Using PowerCinema

The PowerCinema application comes with the ASUS WiFi-TV card support CD. This application allows you to watch TV and DVDs, listen to FM radio or music CDs, or browse pictures stored in your computer. Use the mouse or the remote controller to navigate through the user interface. For details on the remote controller, see the Appendix.



For more information on this application, browse and/or print the Cyberlink PowerCinema 4.0 User's Manual from the support CD Manual tab. Refer to page 2-4.

4.1.1 Launching PowerCinema

There are three ways to launch the PowerCinema application.

(1) From the Windows® Start menu

Click **Start > All Programs > Cyberlink PowerCinema 4.0 > PowerCinema**.

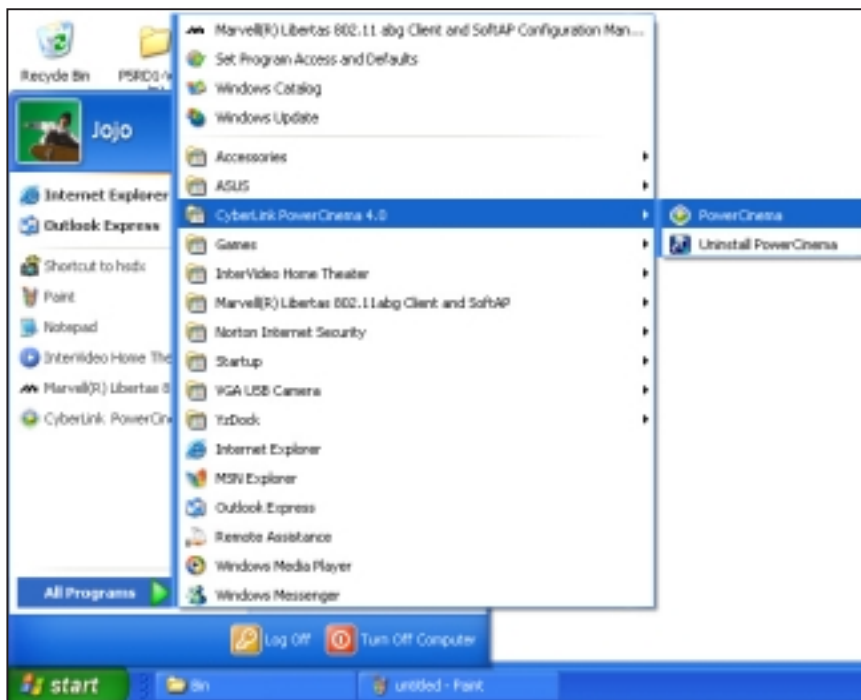

(2) From the PowerCinema icon

Double-click the CyberLink PowerCinema icon on the desktop.



(3) From the remote controller

Press the **Home** key or any system button (except Power and Toggle) to launch the application. Refer to the Appendix for details on the remote controller.

4.1.2 Optimizing your computer for multimedia

During initial launch, a Setup Wizard prompts you to optimize your computer for various multimedia functions.

To optimize your computer:

1. From the Setup Wizard initial window, click **Next** to continue.
2. Select the screen ratio of your display device, then click **Next**.
3. Select the type of TV tuner card, then click **Next**.
If you have a digital cable TV subscription, select **Digital**; otherwise, select **Analog**.
4. Select the TV connection type, then click **Next**.
If you have a cable TV subscription, select **Cable**; otherwise, select **Antenna**.



5. Select your location, then click **Next**.



Setting the correct location allows the application to select the appropriate TV standard and DVD region to your location.



6. When prompted, click **Autoscan for TV Channels Now** (recommended); otherwise, click **Next** to continue.



A new window appears when you autoscan the channels.



7. When prompted, click **Search for Radio Stations Now** (recommended); otherwise, click **Next** to continue.



8. The application then prompts you to search for stored music files in your computer. Click **Search for Music Now** (recommended); otherwise, click **Next** to continue.



9. Select a two- or three-dimensional display effect, then click **Next**.

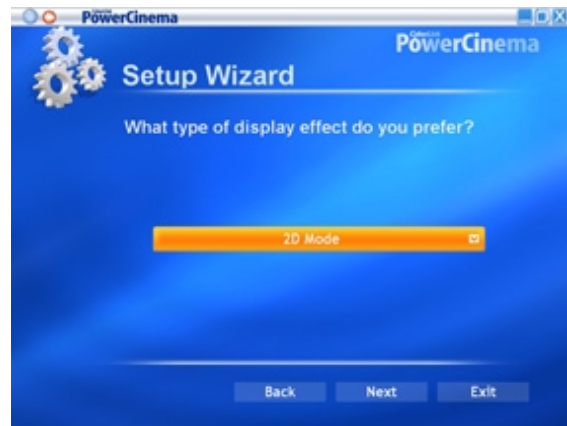

10. When prompted, key-in your name and e-mail address, then click **Next**.



11. Click Finish to close the Setup Wizard and to display the PowerCinema 4 main menu.



You can run the Setup Wizard anytime by clicking or selecting from the PowerCinema home page.

4.1.3 Navigating through the home page

The home page has six multimedia functions (TV, Movies, Videos, Music, Pictures, Radio, Extras) and a configuration option (Settings) that you can select by pressing the up/down arrow of the remote controller or by using the mouse. To launch a function, press the OK button of the remote controller or click the mouse.



4.1.4 Using the player controls

When using a mouse, each multimedia screen has a player control at the bottom left corner of the display that allows control of the current function. The player controls correspond to the remote controller buttons.



Refer to the Cyberlink PowerCinema 4.0 User's Manual from the support CD for details on the player control.

4.1.5 Watching TV

The PowerCinema application allows you to watch TV on your computer. Select **TV** from the home page, then press **OK** from the remote controller, or click the mouse to display the TV screen.



Make sure that you autoscans the channels before you watch TV on your computer. Use the PowerCinema 4 **Setup Wizard** or click the **Settings** button from the TV screen to scan for available channels and/or configure the TV settings.

To watch TV in full screen, highlight the TV window using the remote controller or mouse, then press the remote controller **OK** button or click the mouse. To change channels, use the remote controller or the keyboard Page Up/Page Down keys or the numeric keys.

TV buttons

Buttons	Click this button to
Live TV	Watch full screen live TV on your computer
Recorded TV	Play, sort, and manage recorded TV programs
Schedule	Set the channel, program, and time for TV recording
TV Preview	Display a thumbnail of each available channel
Program Guide	View the program guide from your Electronic Program Guide (EPG) provider or EPG source (Internet)
Find Program	Search for programs by channel or category
Settings	Change or adjust the signal, channel, recording, and EPG settings

Changing the TV signal

If you have a digital cable TV subscription, you must change the TV signal setting using the TV Settings window.

To change the signal setting:

1. From the TV screen, select **Settings**, then press **OK**.



2. Select **Signal Settings** from the TV settings window, then press **OK**.



3. Select **Signal Type** from the signal settings window, then press **OK**.



You can also change these settings using the **Settings** screen

4. Select **Digital** from the menu, then press **OK**.
5. Highlight the **Apply** button, then press **OK**.



4.1.6 Watching movies

The PowerCinema allows you to watch DVD or VCD movies on your computer.



To watch a movie:

1. Insert the DVD or VCD movie to the optical drive. When playing DVDs, make sure that the optical drive supports the DVD standard.
2. Select **Movies** from the main menu, then press **OK** from the remote controller, or click the mouse to start watching the movie.
3. Use the remote controller or the player control to stop, play, pause, forward, or rewind the movie.



Refer to the Cyberlink PowerCinema 4.0 User's Manual from the support CD for details on how to watch movies, play music, and browse photos.

4.2 Using PowerDirector

You can create a DVD movie of your favorite home videos using the PowerDirector application and the AV IN port of the WiFi-TV card.

4.2.1 Adjusting the sound recording settings

You must adjust the sound recording settings before creating a movie. To do this:

1. From the Windows® desktop, click **Start**, then click **Control Panel**.
2. Click **Sounds, Speech, and Audio Devices** from the Control Panel window, click **Sounds and Audio Devices**.

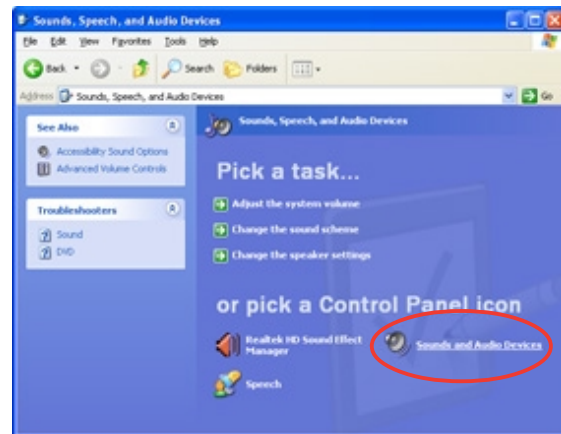

3. Click the **Audio** tab, then set the **Sound Recording Default device** to **713x BDA Analog Audio Capture**.
4. Click **Apply**.

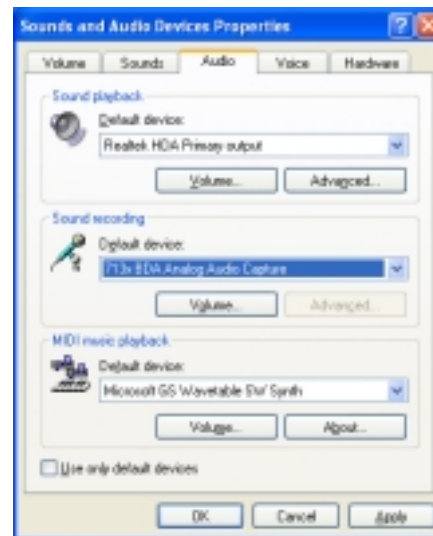

4.2.2 Creating movies

To create a movie:

1. Connect the audio and video source (i.e. camcorder, video recorder, VCR) to the WiFi-TV AV IN connector. See page 2-3 to 2-4 for details.
2. Use the PowerDirector application to capture and create movies from your videos. Refer to the application help for details.

The Appendix provides information on the wireless LAN channels, remote controller, and TV standards in your location.

Reference information

A large, light gray, stylized number '4' is positioned behind the text 'Reference information', partially overlapping it.

A.1 Wireless LAN channels

A.1.1 IEEE 802.11b/g

The IEEE 802.11b/g standard for wireless LAN allocated the 2.4 GHz frequency band into 14 overlapping operating channels. Each channel corresponds to a different set of frequencies. The table below shows the center frequencies of each channel.

Channel	Center Frequency	Channel	Center Frequency
1	2.412 GHz	8	2.447 GHz
2	2.417 GHz	9	2.452 GHz
3	2.422 GHz	10	2.457 GHz
4	2.427 GHz	11	2.462 GHz
5	2.432 GHz	12	2.467 GHz
6	2.437 GHz	13	2.472 GHz
7	2.442 GHz	14	2.484 GHz



If several Wi-Fi devices are operating in the same vicinity, the distance between the center frequencies of channels used must be at least 25 MHz to avoid interference.

The number of channels available for the wireless LAN adapter (in IEEE 802.11b/g) mode varies by country/region. Refer to the table below to determine the number of channels available in your location.

Country/Region (Regulating Body)	Available Channels
Australia (ACA)	Channels 1 to 13
Belgium (RTT&E/EMC/LVD)	Channels 1 to 13
Bulgaria (RTT&E/EMC/LVD)	Channels 1 to 13
Canada (CSA/cUL 950 3rd Edition)	Channels 1 to 11
China (MI)	Channels 1 to 11
Cyprus (RTT&E/EMC/LVD)	Channels 1 to 13
Czech Republic (RTT&E/EMC/LVD)	Channels 1 to 13
Denmark (RTT&E/EMC/LVD)	Channels 1 to 13
Finland (RTT&E/EMC/LVD)	Channels 1 to 13
France (RTT&E/EMC/LVD)	Channels 1 to 13
Germany (RTT&E/EMC/LVD)	Channels 1 to 13
Greece (RTT&E/EMC/LVD)	Channels 1 to 13
Hong Kong (OFTA)	Channels 1 to 13
Hungary (RTT&E/EMC/LVD)	Channels 1 to 13
Iceland (RTT&E/EMC/LVD)	Channels 1 to 13

(continued on the next page)

Country/Region (Regulating Body)	Available Channels
Ireland (RTT&E/EMC/LVD)	Channels 1 to 13
Italy (RTT&E/EMC/LVD)	Channels 1 to 13
Japan (TELEC)	Channels 1 to 14
Luxembourg (RTT&E/EMC/LVD)	Channels 1 to 13
Malaysia (SIRIM/CMC)	Channels 1 to 13
Mexico	Channels 9 to 11
Netherlands Antilles (RTT&E/EMC/LVD)	Channels 1 to 13
Netherlands/Holland (RTT&E/EMC/LVD)	Channels 1 to 13
New Zealand (PTC)	Channels 1 to 13
Norway (RTT&E/EMC/LVD)	Channels 1 to 13
Portugal (RTT&E/EMC/LVD)	Channels 1 to 13
Saudi Arabia	Channels 1 to 13
Singapore	Channels 1 to 13
South Korea (KS)	Channels 1 to 13
Spain (RTT&E/EMC/LVD)	Channels 1 to 13
Sweden (RTT&E/EMC/LVD)	Channels 1 to 13
Switzerland (RTT&E/EMC/LVD)	Channels 1 to 13
Taiwan (DGT)	Channels 1 to 11
Turkey (TTAS)	Channels 1 to 13
United Kingdom (RTT&E/EMC/LVD)	Channels 1 to 13
United States (FCC)	Channels 1 to 11



Channels 1, 6 and 11 are independent and do not overlap each other. We recommended that you tune your wireless LAN adapter to these channels.

A.1.2 IEEE 802.11a

The number of channels available for the wireless LAN adapter (in IEEE 802.11a) mode varies by region. Refer to the table below to determine the channels available in your location.

Region (Regulating Body)	Available Channels
North America	36, 40, 44, 48, 52, 56, 60, 64, 149, 153, 157, 161
Singapore	36, 40, 44, 48, 52, 56, 60, 64, 149, 153, 157, 161
Europe (ETSI)	36, 40, 44, 48, 52, 56, 60, 64, 100, 104, 108, 112, 116, 120, 124, 128, 132, 136, 140
Japan (MCK)	240, 244, 248, 252, 8, 2, 16, 36, 40, 44, 48, 52, 56, 60, 64
Taiwan (DGT)	52, 56, 60, 64, 100, 104, 108, 112, 116, 120, 124, 128, 132, 136, 140, 149, 153, 157, 161

A.2 Remote controller

The ASUS remote controller allows you to operate the WiFi-TV from a distance. Use the remote controller to navigate through the PowerCinema windows.

Remote controller specifications

Operating range	5 meters (max)
Power Source	3V (2 x "AAA" batteries)
Receiver	USB infrared receiver (supplied)

A.2.1 Using the remote controller

To use the remote controller:

1. Install the remote controller batteries.
2. Insert the USB plug of the remote controller receiver to an available USB port in your computer. Refer to the illustration on the right.
3. Install the receiver at an unobscured location for optimum operation.
4. Turn on your computer, then open the PowerCinema application. Refer to Chapter 4 for details.
5. Use the remote controller to navigate through the PowerCinema windows.

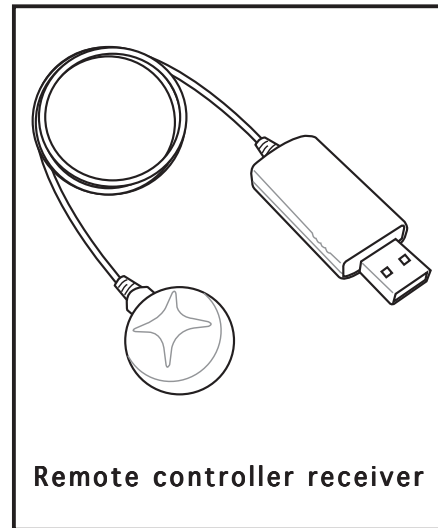

A.2.2 Remote controller layout

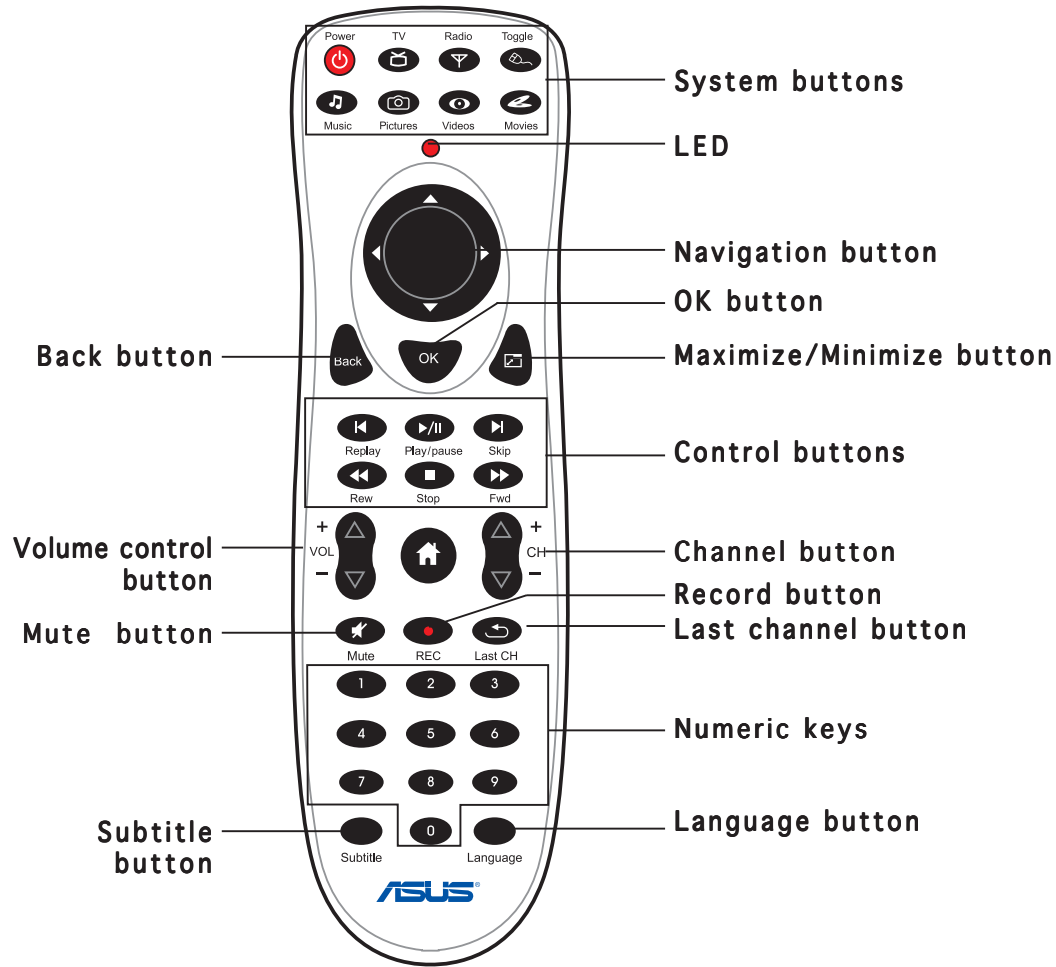

A.2.3 Remote controller functions

System buttons

Button	Press to
	Turn off the computer
	Launch the TV mode
	Print the screen (Pictures mode)
	Toggle the remote controller as mouse or vice-versa
	Launch the Music mode
	Launch the Pictures mode
	Launch the Video Mode
	Play a CD/DVD movie

A.2.4 Mouse mode

You can use the remote controller instead of the mouse to navigate through, and select icons from the desktop. Press , then use the navigation button to move through the desktop and the back and maximize/minimize button for the left and right-click mouse function. Refer to the illustration below for the function of the remote controller keys when toggled to a mouse.

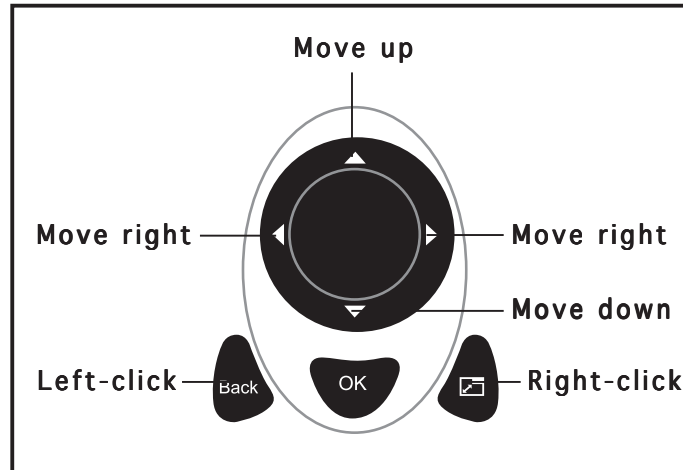

A.3 International TV systems and standards



- TV systems and standards may change anytime without notice. This list is provided for reference only.
- Make sure that your TV card conforms with the system or standard used in your country or location.

AREA	TV	COLOR	STEREO	SUBTITLE
Albania	B/G	PAL		
Argentina	N	PAL-N		
Australia	B/G	PAL	FM-FM	Teletext
Austria	B/G	PAL	FM-FM	Teletext
Azores Is. (Portugal)	B	PAL		
Bahamas	M	NTSC		
Bahrain	B	PAL		
Barbados	N	NTSC		
Belgium	B/G	PAL	Nicam	Teletext
Bermuda	M	NTSC		
Brazil	M	PAL-M	MTS	
Bulgaria	D	SECAM		
Canada	M	NTSC	MTS	CC
Canary Is.	B	PAL		
China	D	PAL		
Colombia	N	NTSC		
Cyprus	B	PAL		
Czech Republic	D/K	SECAM/PAL		
Denmark	B	PAL	Nicam	TeleText
Egypt	B	SECAM		
Faroe Islands (DK)	B	PAL		
Finland	B/G	PAL	Nicam	TeleText
France	E/L	SECAM		Antiope
Gambia	I	PAL		
Germany	B/G	PAL	FM-FM	TeleText
Germany (prev East)	B/G	SECAM/PAL		
Gibraltar	B	PAL		
Greece	B/H	SECAM		
Hong Kong	I	PAL	Nicam	
Hungary	B/G & D/K	PAL (was SECAM)	Nicam (Budapest only)	
Iceland	B	PAL		
India	B	PAL		
Indonesia	B	PAL		
Iran	H	SECAM		
Ireland	I	PAL	Nicam	TeleText

AREA	TV	COLOR	STEREO	SUBTITLE
Israel	B/G	PAL	Nicam	TeleText
Italy	B/G	PAL	FM/FM	TeleText
Jamaica	M	SECAM		
Japan	M	NTSC	Matrix	
Jordan	B	PAL		
Kenya	B	PAL		
Korea	M	NTSC		
Luxembourg	B/G	PAL		TeleText
Madeira	B	PAL		
Madagascar	B	SECAM		
Malaysia	B	PAL		
Malta	B/G	PAL		
Mauritius	B	SECAM		
Mexico	M	NTSC	MTS	CC
Monaco	L/G	SECAM/PAL		
Morocco	B	SECAM		
Netherlands	B/G	PAL	FM-FM	TeleText
New Zealand	B/G	PAL	Nicam	TeleText
North Korea	D, D/K	SECAM/PAL		
Norway	B/G	PAL	Nicam	
Pakistan	B	PAL		
Paraguay	N	PAL		
Peru	M	NTSC		
Philippines	M	NTSC		
Poland	D/K	PAL		Teletext
Portugal	B/G	PAL	Nicam	Teletext
Romania	G	PAL		
Russia	D/K	SECAM		
Saudi Arabia	B	SECAM		
Seychelles	I	PAL		
Singapore	B	PAL		
South Africa	I	PAL		
South Korea	N	NTSC		
Spain	B/G	PAL	Nicam	
Sri Lanka	B/G	PAL		
Sweden	B/G	PAL	Nicam	Teletext
Switzerland	B/G	PAL	FM-FM	TeleText
Tahiti	KI	SECAM		
Taiwan	M	NTSC		
Thailand	B	PAL		
Trinidad	M	NTSC		
Tunisia	B	SECAM		
Turkey	BPAL			TeleText
Ukraine	D/K	SECAM		
United Arab Emirates	B/G	PAL		
United States	M	NTSC		
United Kingdom	I	PAL		
Vietnam	M/D	NTSC/SECAM		
Yugoslavia	B/G	PAL		
Zambia	B/G	PAL		
Zimbabwe	B/G	PAL		