

**M2N32-SLI**  
*Deluxe*



**Motherboard**

E2594

Revised Edition V2

May 2006

**Copyright © 2006 ASUSTeK COMPUTER INC. All Rights Reserved.**

No part of this manual, including the products and software described in it, may be reproduced, transmitted, transcribed, stored in a retrieval system, or translated into any language in any form or by any means, except documentation kept by the purchaser for backup purposes, without the express written permission of ASUSTeK COMPUTER INC. ("ASUS").

Product warranty or service will not be extended if: (1) the product is repaired, modified or altered, unless such repair, modification or alteration is authorized in writing by ASUS; or (2) the serial number of the product is defaced or missing.

ASUS PROVIDES THIS MANUAL "AS IS" WITHOUT WARRANTY OF ANY KIND, EITHER EXPRESS OR IMPLIED, INCLUDING BUT NOT LIMITED TO THE IMPLIED WARRANTIES OR CONDITIONS OF MERCHANTABILITY OR FITNESS FOR A PARTICULAR PURPOSE. IN NO EVENT SHALL ASUS, ITS DIRECTORS, OFFICERS, EMPLOYEES OR AGENTS BE LIABLE FOR ANY INDIRECT, SPECIAL, INCIDENTAL, OR CONSEQUENTIAL DAMAGES (INCLUDING DAMAGES FOR LOSS OF PROFITS, LOSS OF BUSINESS, LOSS OF USE OR DATA, INTERRUPTION OF BUSINESS AND THE LIKE), EVEN IF ASUS HAS BEEN ADVISED OF THE POSSIBILITY OF SUCH DAMAGES ARISING FROM ANY DEFECT OR ERROR IN THIS MANUAL OR PRODUCT.

SPECIFICATIONS AND INFORMATION CONTAINED IN THIS MANUAL ARE FURNISHED FOR INFORMATIONAL USE ONLY, AND ARE SUBJECT TO CHANGE AT ANY TIME WITHOUT NOTICE, AND SHOULD NOT BE CONSTRUED AS A COMMITMENT BY ASUS. ASUS ASSUMES NO RESPONSIBILITY OR LIABILITY FOR ANY ERRORS OR INACCURACIES THAT MAY APPEAR IN THIS MANUAL, INCLUDING THE PRODUCTS AND SOFTWARE DESCRIBED IN IT.

Products and corporate names appearing in this manual may or may not be registered trademarks or copyrights of their respective companies, and are used only for identification or explanation and to the owners' benefit, without intent to infringe.

# Contents

Notices.....	vii
Safety information .....	viii
About this guide .....	ix
M2N32-SLI Deluxe specifications summary.....	xi

## Chapter 1: Product introduction

1.1	Welcome!.....	1-1
1.2	Package contents.....	1-1
1.3	Special features.....	1-2
1.3.1	Product highlights .....	1-2
1.3.2	ASUS AI Lifestyle features .....	1-5
1.3.3	ASUS Special features .....	1-6
1.3.4	ASUS Intelligent Overclocking features .....	1-8

## Chapter 2: Hardware information

2.1	Before you proceed .....	2-1
2.2	Motherboard overview.....	2-2
2.2.1	Placement direction .....	2-2
2.2.2	Screw holes .....	2-2
2.2.3	ASUS Stack Cool 2.....	2-3
2.2.4	Motherboard layout.....	2-4
2.2.5	Layout contents.....	2-5
2.3	Central Processing Unit (CPU) .....	2-7
2.3.1	Installing the CPU .....	2-7
2.3.2	Installing the heatsink and fan .....	2-9
2.4	System memory .....	2-12
2.4.1	Overview .....	2-12
2.4.2	Memory configurations.....	2-12
2.4.3	Installing a DIMM .....	2-14
2.4.4	Removing a DIMM .....	2-14
2.5	Expansion slots.....	2-16
2.5.1	Installing an expansion card .....	2-16
2.5.2	Configuring an expansion card .....	2-16
2.5.3	Interrupt assignments .....	2-17
2.5.4	PCI slots.....	2-18
2.5.5	PCI Express x4 slot.....	2-18
2.5.6	Two PCI Express x16 slots .....	2-18

# Contents

- 2.6 Jumper ..... 2-19
- 2.7 Connectors ..... 2-20
  - 2.7.1 Rear panel connectors ..... 2-20
  - 2.7.2 Internal connectors ..... 2-23
  
- Chapter 3: Powering up**
- 3.1 Starting up for the first time..... 3-1
- 3.2 Powering off the computer..... 3-2
  - 3.2.1 Using the OS shut down function..... 3-2
  - 3.2.2 Using the dual function power switch..... 3-2
  
- Chapter 4: BIOS setup**
- 4.1 Managing and updating your BIOS ..... 4-1
  - 4.1.1 ASUS Update utility ..... 4-1
  - 4.1.2 Creating a bootable floppy disk..... 4-4
  - 4.1.3 ASUS EZ Flash 2 utility..... 4-5
  - 4.1.4 Updating the BIOS ..... 4-6
  - 4.1.5 Saving the current BIOS file..... 4-8
  - 4.1.6 ASUS CrashFree BIOS 3 utility ..... 4-9
- 4.2 BIOS setup program ..... 4-10
  - 4.2.1 BIOS menu screen.....4-11
  - 4.2.2 Menu bar.....4-11
  - 4.2.3 Legend bar..... 4-12
  - 4.2.4 Menu items ..... 4-12
  - 4.2.5 Sub-menu items..... 4-12
  - 4.2.6 Configuration fields ..... 4-12
  - 4.2.7 Pop-up window ..... 4-13
  - 4.2.8 General help ..... 4-13
- 4.3 Main menu ..... 4-14
  - 4.3.1 System Time ..... 4-14
  - 4.3.2 System Date ..... 4-14
  - 4.3.3 Language ..... 4-14
  - 4.3.4 Legacy Diskette A ..... 4-14
  - 4.3.5 Primary IDE Master/Slave..... 4-15
  - 4.3.6 SATA 1-6.....4-17

# Contents

4.3.7	HDD SMART Monitoring .....	4-18
4.3.8	Installed Memory .....	4-18
4.3.9	Usable Memory .....	4-18
<b>4.4</b>	<b>Advanced menu .....</b>	<b>4-19</b>
4.4.1	JumperFree Configuration .....	4-19
4.4.2	LAN Cable Status .....	4-22
4.4.3	PEG Link Mode .....	4-23
4.4.4	CPU Configuration .....	4-23
4.4.5	Chipset .....	4-27
4.4.6	PCI/PnP .....	4-28
4.4.7	Onboard Device Configuration .....	4-29
<b>4.5</b>	<b>Power menu .....</b>	<b>4-32</b>
4.5.1	ACPI Suspend Type .....	4-32
4.5.2	ACPI APIC Support .....	4-32
4.5.3	APM Configuration .....	4-33
2.5.4	Hardware Monitor .....	4-35
<b>4.6</b>	<b>Boot menu .....</b>	<b>4-37</b>
4.6.1	Boot Device Priority .....	4-37
4.6.2	Removable Drives .....	4-38
4.6.3	Hard Disk Drives .....	4-38
4.6.4	CDROM Drives .....	4-38
4.6.5	Boot Settings Configuration .....	4-39
4.6.6	Security .....	4-40
<b>4.7</b>	<b>Tools menu .....</b>	<b>4-42</b>
4.7.1	ASUS Music Alarm .....	4-42
4.7.2	ASUS O.C. Profile .....	4-44
4.7.4	ASUS EZ Flash 2 .....	4-46
<b>4.8</b>	<b>Exit menu .....</b>	<b>4-47</b>

# Contents

<b>Chapter 5: Software support</b>	
<b>5.1</b>	<b>Installing an operating system ..... 5-1</b>
<b>5.2</b>	<b>Support CD information ..... 5-1</b>
5.2.1	Running the support CD ..... 5-1
5.2.2	Drivers menu..... 5-2
5.2.3	Utilities menu ..... 5-3
5.2.4	Make Disk menu ..... 5-4
5.2.5	Manuals menu ..... 5-5
5.2.6	ASUS Contact information ..... 5-6
5.2.7	Other information ..... 5-6
<b>5.3</b>	<b>Software information</b>
5.3.1	ASUS MyLogo3 ..... 5-8
5.3.2	Cool 'n' Quiet™ Technology..... 5-10
5.3.3	ASUS PC Probe II..... 5-13
5.3.4	ASUS Ai Gear ..... 5-19
5.3.5	ASUS Ai Nap..... 5-21
5.3.6	ASUS Music Alarm..... 5-22
5.3.7	SoundMAX ADI1988 ..... 5-25
<b>5.4</b>	<b>RAID configurations ..... 5-30</b>
5.4.1	Installing hard disks ..... 5-31
5.4.2	NVIDIA® MediaShield RAID configurations..... 5-32
5.4.3	Silicon Image RAID configurations ..... 5-39
<b>5.5</b>	<b>Creating a RAID driver disk..... 5-46</b>
<b>Chapter 6: NVIDIA® SLI™ technology support</b>	
<b>6.1</b>	<b>Overview ..... 6-1</b>
<b>6.2</b>	<b>Dual graphics card setup ..... 6-2</b>
6.2.1	Installing SLI-ready graphics cards..... 6-2
6.2.2	Installing the device drivers..... 6-5
6.2.3	Enabling the multi-GPU feature in Windows® ..... 6-5

# Notices

## Federal Communications Commission Statement

This device complies with Part 15 of the FCC Rules. Operation is subject to the following two conditions:

- This device may not cause harmful interference, and
- This device must accept any interference received including interference that may cause undesired operation.

This equipment has been tested and found to comply with the limits for a Class B digital device, pursuant to Part 15 of the FCC Rules. These limits are designed to provide reasonable protection against harmful interference in a residential installation. This equipment generates, uses and can radiate radio frequency energy and, if not installed and used in accordance with manufacturer's instructions, may cause harmful interference to radio communications. However, there is no guarantee that interference will not occur in a particular installation. If this equipment does cause harmful interference to radio or television reception, which can be determined by turning the equipment off and on, the user is encouraged to try to correct the interference by one or more of the following measures:

- Reorient or relocate the receiving antenna.
- Increase the separation between the equipment and receiver.
- Connect the equipment to an outlet on a circuit different from that to which the receiver is connected.
- Consult the dealer or an experienced radio/TV technician for help.



---

The use of shielded cables for connection of the monitor to the graphics card is required to assure compliance with FCC regulations. Changes or modifications to this unit not expressly approved by the party responsible for compliance could void the user's authority to operate this equipment.

---

## Canadian Department of Communications Statement

This digital apparatus does not exceed the Class B limits for radio noise emissions from digital apparatus set out in the Radio Interference Regulations of the Canadian Department of Communications.

This class B digital apparatus complies with Canadian ICES-003.

# Safety information

## Electrical safety

- To prevent electrical shock hazard, disconnect the power cable from the electrical outlet before relocating the system.
- When adding or removing devices to or from the system, ensure that the power cables for the devices are unplugged before the signal cables are connected. If possible, disconnect all power cables from the existing system before you add a device.
- Before connecting or removing signal cables from the motherboard, ensure that all power cables are unplugged.
- Seek professional assistance before using an adapter or extension cord. These devices could interrupt the grounding circuit.
- Make sure that your power supply is set to the correct voltage in your area. If you are not sure about the voltage of the electrical outlet you are using, contact your local power company.
- If the power supply is broken, do not try to fix it by yourself. Contact a qualified service technician or your retailer.

## Operation safety

- Before installing the motherboard and adding devices on it, carefully read all the manuals that came with the package.
- Before using the product, make sure all cables are correctly connected and the power cables are not damaged. If you detect any damage, contact your dealer immediately.
- To avoid short circuits, keep paper clips, screws, and staples away from connectors, slots, sockets and circuitry.
- Avoid dust, humidity, and temperature extremes. Do not place the product in any area where it may become wet.
- Place the product on a stable surface.
- If you encounter technical problems with the product, contact a qualified service technician or your retailer.



# About this guide

This user guide contains the information you need when installing and configuring the motherboard.

## How this guide is organized

This guide contains the following parts:

- **Chapter 1: Product introduction**  
This chapter describes the features of the motherboard and the new technology it supports.
- **Chapter 2: Hardware information**  
This chapter lists the hardware setup procedures that you have to perform when installing system components. It includes description of the switches, jumpers, and connectors on the motherboard.
- **Chapter 3: Powering up**  
This chapter describes the power up sequence and ways of shutting down the system.
- **Chapter 4: BIOS setup**  
This chapter tells how to change system settings through the BIOS Setup menu. Detailed descriptions of the BIOS parameters are also provided.
- **Chapter 5: Software support**  
This chapter describes the contents of the support CD that comes with the motherboard package.

## Where to find more information

Refer to the following sources for additional information and for product and software updates.

1. **ASUS websites**  
The ASUS website provides updated information on ASUS hardware and software products. Refer to the ASUS contact information.
2. **Optional documentation**  
Your product package may include optional documentation, such as warranty flyers, that may have been added by your dealer. These documents are not part of the standard package.

## Conventions used in this guide

To make sure that you perform certain tasks properly, take note of the following symbols used throughout this manual.



**DANGER/WARNING:** Information to prevent injury to yourself when trying to complete a task.



**CAUTION:** Information to prevent damage to the components when trying to complete a task.



**IMPORTANT:** Instructions that you **MUST** follow to complete a task.



**NOTE:** Tips and additional information to help you complete a task.

## Typography

**Bold text**

Indicates a menu or an item to select.

*Italics*

Used to emphasize a word or a phrase.

<Key>

Keys enclosed in the less-than and greater-than sign means that you must press the enclosed key.

Example: <Enter> means that you must press the Enter or Return key.

<Key1+Key2+Key3>

If you must press two or more keys simultaneously, the key names are linked with a plus sign (+).

Example: <Ctrl+Alt+D>

**Command**

Means that you must type the command exactly as shown, then supply the required item or value enclosed in brackets.

Example: At the DOS prompt, type the command line:

```
awdflash M2N32SLI .bin
```

# M2N32-SLI Deluxe specifications summary

<b>CPU</b>	Socket AM2 for AMD Athlon™ 64 X2/ Athlon™ 64 /Athlon™ FX/Sempron™ processor Supports AMD Cool 'n' Quiet™ Technology AMD64 architecture enables simultaneous 32-bit and 64-bit computing AMD LIVE!™ Ready
<b>Chipset</b>	NVIDIA® nForce® 590 SLI™ MCP NVIDIA® LinkBoost™ Technology
<b>System bus</b>	2000 / 1600 MT/s
<b>Memory</b>	Dual-channel memory architecture <ul style="list-style-type: none"> <li>- 4 x 240-pin DIMM sockets support unbuffered ECC/non-ECC DDR2 800/667/533 MHz memory modules</li> <li>- Supports up to 8 GB system memory</li> </ul>
<b>Expansion slots</b>	2 x PCI Express™ x16 slots with NVIDIA® SLI™ support at full x16, x16 speed 1 x PCI Express™ x4 slot (supports PCI Express™ x4 or x1 card) 1 x PCI Express™ x1 slot 2 x PCI 2.2 slots
<b>Scalable Link Interface (SLI™)</b>	Supports two identical NVIDIA® SLI™-ready graphics cards, both at x16 mode ASUS two-slot thermal design ASUS PEG Link
<b>Storage</b>	NVIDIA® nForce® 590 SLI™ MCP supports: <ul style="list-style-type: none"> <li>- 1 x IDE connector for up to two Ultra DMA 133/100/66/33 devices</li> <li>- 6 x Serial ATA 3.0 Gb/s connectors support six Serial ATA devices</li> <li>- RAID 0, RAID 1, RAID 0+1, RAID 5, and JBOD configurations spanning across Serial ATA drives via the onboard NVIDIA® MediaShield™ RAID controller</li> </ul> <p>Silicon Image® Sil3132 Serial ATA controller supports:</p> <ul style="list-style-type: none"> <li>- 1 x Internal Serial ATA 3.0 Gb/s</li> <li>- 1 x External Serial ATA 3.0 Gb/s on the rear panel with Port Multiplier function (SATA-On-The-Go)</li> <li>- RAID 0, RAID 1, and JBOD configuration</li> </ul>
<b>LAN</b>	Dual Gigabit LAN controllers support NVIDIA® DualNet technology NVIDIA® nForce® 590 SLI™ MCP built-in dual Gigabit MAC with external Marvel® PHY <ul style="list-style-type: none"> <li>- Supports Teaming and Fail-Over functions</li> <li>- Supports TCP/IP Acceleration</li> </ul>

*(continued on the next page)*

# M2N32-SLI Deluxe specifications summary

<b>High Definition Audio</b>	SoundMAX® ADI AD1988B 8-channel CODEC Supports Jack-Sensing, Enumeration, Multi-Streaming, and Jack-Retasking Technology Optical and Coaxial S/PDIF Out interfaces Supports DTS® Connect function
<b>Wireless LAN (Optional)</b>	Wi-Fi-AP Solo USB wireless module supports IEEE 802.11 b/g
<b>IEEE 1394</b>	T1 1394 controller supports: - 2 x IEEE 1394a connectors (1 at mid-board, 1 on the rear panel)
<b>USB</b>	Wireless Edition: Supports up to 8 USB 2.0/1.1 ports Standard Version: Supports up to 10 USB 2.0/1.1 ports
<b>ASUS AI Lifestyle features</b>	AI Nap AI Gear Advanced Thermal Design - ASUS Fanless Design: Heat-pipe Thermal solution - ASUS 8-Phase Power Design - Stack Cool 2 ASUS Crystal Sound - ASUS Array Microphone - Noise Filer WiFi-AP Solo™ (Optional) - 54 Mbps IEEE 802.11g and backwards compatible with 11 Mbps IEEE 802.11b - Software Access point mode - Infrastructure mode: Client or Ad-Hoc mode

*(continued on the next page)*

# M2N32-SLI Deluxe specifications summary

<b>ASUS Exclusive Overclocking features</b>	<p>Intelligent overclocking tools:</p> <ul style="list-style-type: none"><li>- AI NOS™ (Non-delay Overclocking System)</li><li>- AI Overclocking (intelligent CPU frequency tuner)</li><li>- AI Clock Skew</li><li>- ASUS PEG Link (automatic performance tuning for graphics cards)</li></ul> <p>ASUS O.C. Profile: overclocking configuration-sharing tool</p> <p>Precision Tweaker:</p> <ul style="list-style-type: none"><li>- vDIMM: 25-step DRAM voltage control</li><li>- vCore: Adjustable CPU voltage at 0.0125 V increment</li><li>- Stepless Frequency Selection(SFS) allows FSB tuning from 200 MHz up to 400 MHz at 1 MHz increment</li><li>- PCI Express frequency allows PCI Express x16 frequency tuning from 100 MHz to 200 MHz at 1 MHz increment</li></ul> <p>Overclocking protection:</p> <ul style="list-style-type: none"><li>- ASUS C.P.R. (CPU Parameter Recall)</li></ul> <p>ASUS AI Booster Utility</p>
<b>Special features</b>	<p>ASUS EZ DIY:</p> <ul style="list-style-type: none"><li>- Q-Connector</li><li>- ASUS CrashFree BIOS 3</li><li>- ASUS EZ Flash 2</li></ul> <p>ASUS Music Alarm</p> <p>ASUS MyLogo3</p>
<b>Rear panel</b>	<p>1 x PS/2 keyboard port (purple) 1 x PS/2 mouse port (green) 1 x Serial (COM1) port 1 x IEEE 1394a port 1 x Optical S/PDIF Out port 1 x Coaxial S/PDIF Out port 2 x LAN (RJ-45) ports 4 x USB 2.0/1.1 ports 1 x WiFi-g™ antenna jack (Wireless Edition only) 8-channel audio ports</p>

(continued on the next page)

## M2N32-SLI Deluxe specifications summary

<b>Internal connectors</b>	<b>Wireless Edition:</b> 2 x USB 2.0 connectors support four additional USB 2.0 ports <b>Standard Version:</b> 3 x USB 2.0 connectors support six additional USB 2.0 ports 1 x Floppy disk drive connector 1 x IDE connector for two devices 7 x Serial ATA connectors 1 x CPU / 4 x Chassis / 1 x Chipset / 1 x Power fan connectors 1 x IEEE 1394a connector 1 x Parallel connector 1 x S/PDIF Out connector 1 x ADH connector for future upgrade Chassis intrusion connector Front panel audio connector CD audio in connector 24-pin ATX power connector 4-pin ATX 12 V power connector System panel connector
<b>BIOS features</b>	8 Mb AWARD BIOS, PnP, DMI 2.0, WfM2.0, SM BIOS 2.3
<b>Manageability</b>	WOL by PME, WOR by PME, Chassis intrusion, PXE
<b>Power requirements</b>	ATX power supply (with 24-pin and 4-pin 12 V plugs) ATX 12 V 2.0 compliant
<b>Support CD contents</b>	Device drivers ASUS WiFi-AP Solo™ Wizard ASUS AI Booster ASUS PC Probe II ASUS Update NVIDIA® MediaShield™ RAID Anti-virus Utility (OEM version)
<b>Form factor</b>	ATX form factor: 12 in x 9.6 in (30.5 cm x 24.5 cm)

\*Specifications are subject to change without notice.

This chapter describes the motherboard features and the new technologies it supports.

# 1 Product introduction

# Chapter summary

# 1

1.1	Welcome! .....	1-1
1.2	Package contents.....	1-1
1.3	Special features.....	1-2



## 1.1 Welcome!

Thank you for buying an **ASUS® M2N32-SLI Deluxe motherboard!**

The motherboard delivers a host of new features and latest technologies, making it another standout in the long line of ASUS quality motherboards!

Before you start installing the motherboard, and hardware devices on it, check the items in your package with the list below.

## 1.2 Package contents

Check your motherboard package for the following items.

Motherboard	ASUS M2N32-SLI Deluxe/WiFi or ASUS M2N32-SLI Deluxe
I/O modules	IEEE 1394a module 1 x 2-port USB 2.0 module
Cables	6 x Serial ATA cables 3 x Serial ATA power cables for six devices 1 x Ultra DMA 133/100/66 cable 1 x Floppy disk drive cable
Accessories	Wireless antenna (for Wireless Edition only) I/O shield ASUS SLI™ Bridge ASUS Array Mic ASUS Optional Fan 1 x ASUS Q-Connector Kit (USB, 1394, system panel; Retail version only)
Application CD	ASUS motherboard support CD InterVideo® Media Launcher (OEM version)
Documentation	User guide



If any of the above items is damaged or missing, contact your retailer.

## 1.3 Special features

### 1.3.1 Product highlights

#### Latest processor technology



The motherboard comes with a 940-pin AM2 socket that supports AMD Athlon™ 64 X2/Athlon™ 64/Athlon™ FX/Sempron™ processor. With an integrated low-latency high-bandwidth memory controller and a highly scalable HyperTransport™ technology-based system bus, the motherboard provides a powerful platform for your diverse computing needs, increased office productivity, and enhanced digital media experience. See page 2-7 for details.

#### NVIDIA® Scalable Link Interface (SLI™)



The NVIDIA® Scalable Link Interface (SLI™) technology allows two graphics processing units (GPUs) in a single system. This technology takes advantage of the PCI Express™ bus architecture and features intelligent hardware and software solutions that allows multiple GPUs to work together and achieve exceptional graphics performance.

#### NVIDIA nForce® 590 SLI™ (NVIDIA LinkBoost™ certified)



NVIDIA nForce® 590 SLI™ media and communication processors (MCPs) deliver the tools and performance PC enthusiasts demand. When combined with selected NVIDIA GeForce graphics cards and other system components, you get automatic access to faster bus speeds. Ready for system overclocking and greater data throughput.

#### DDR2 memory support



The motherboard supports DDR2 memory that features data transfer rates of 800/667/533 MHz to meet the higher bandwidth requirements of the latest 3D graphics, multimedia, and Internet applications. The dual-channel DDR2 architecture doubles the bandwidth of your system memory to boost system performance, eliminating bottlenecks with peak bandwidths of up to 12.8 GB/s. See pages 2-12 to 2-13 for details.

#### PCI Express™ interface



The motherboard fully supports PCI Express, the latest I/O interconnect technology that speeds up the PCI bus. PCI Express features point-to-point serial interconnections between devices and allows higher clockspeeds by carrying data in packets. This high speed interface is software compatible with existing PCI specifications. See page 2-18 for details.

## Serial ATA 3.0 Gb/s technology and SATA-On-The-Go



The motherboard fully supports the Serial ATA 3.0 Gb/s technology through the Serial ATA interfaces and the NVIDIA® nForce® 590 SLI™ chipset. The Serial ATA 3 Gb/s specification provides twice the bandwidth of the current Serial ATA products with a host of new features, including Native Command Queuing (NCQ), and Power Management (PM) Implementation Algorithm. Serial ATA allows for thinner, more flexible cables with lower pin count and reduced voltage required. Leveraging these Serial ATA 3.0 Gb/s features is the SATA-On-The-Go. Supported by the Silicon Image Sil3132 Serial ATA controller, two Serial ATA 3.0 Gb/s connectors (one at mid-board and one on the rear panel) provide smart setup, and hot-plug function. See pages 2-21, 2-24, and 2-25 for details.

## Dual RAID solution



Onboard RAID controllers provide the motherboard with dual-RAID functionality that allows you to select the best RAID solution using Serial ATA devices.

The NVIDIA® nForce® 590 SLI™ chipset allows RAID 0, RAID 1, RAID 0+1, RAID 5, and JBOD configuration for six SATA 3.0 Gb/s connector. See pages 2-24.

The Silicon Image® Sil3132 controller supports two additional Serial ATA 3.0 Gb/s connectors (one at mid-board and one on the rear panel) and allows RAID 0, RAID 1, and JBOD configurations on these ports. See pages 2-25 for details.

## IEEE 1394a support



The IEEE 1394a interface provides high-speed and flexible PC connectivity to a wide range of peripherals and devices compliant to the IEEE 1394a standard. The IEEE 1394a interface allows up to 400 Mbps transfer rates through simple, low-cost, high-bandwidth asynchronous (real-time) data interfacing between computers, peripherals, and consumer electronic devices such as camcorders, VCRs, printers, TVs, and digital cameras. See pages 2-20 and 2-26 for details.

## S/PDIF digital sound ready



The motherboard supports the S/PDIF technology through the S/PDIF interfaces on the rear panel. The S/PDIF technology turns your computer into a high-end entertainment system with digital connectivity to powerful audio and speaker systems. See pages 2-22 and 2-31 for details.

## USB 2.0 technology

The motherboard implements the Universal Serial Bus (USB) 2.0 specification, dramatically increasing the connection speed from the 12 Mbps bandwidth on USB 1.1 to a fast 480 Mbps on USB 2.0. USB 2.0 is backward compatible with USB 1.1. See pages 2-21 and 2-26 for details.



## Dual Gigabit LAN solution

The motherboard comes with dual Gigabit LAN controllers to provide the total solution for your networking needs. These network controllers provide faster data bandwidth for your wired or wireless Internet, LAN, and file sharing requirements. See page 2-20 for details.

## AMD Cool 'n' Quiet Technology

The motherboard supports the AMD Cool 'n' Quiet Technology, which monitors system operation and automatically adjusts CPU voltage and frequency for a cool and quiet operating environment. See page 4-26 for details.

## 1.3.2 ASUS AI Lifestyle features

### AI Gear

AI Gear allows users to choose from four modes to adjust CPU and Vcore voltage, minimizing noise and power consumption. Users can choose the mode that best suits their needs. See page 5-19 for details

### AI Nap

With AI Nap, the system can continue running at minimum power and noise when the user is temporarily away. To wake the system and return to the OS environment, simply click the mouse or press a key. See page 5-21 for details.

### ASUS Crystal Sound

This feature can enhance speech-centric applications like Skype, online game, video conference and recording. See page 5-25 for details.

#### ASUS Array Mic

The Bundled Superbeam Array Microphone receives only the sound coming from the reception cone and ignores the sounds coming from other directions. This mechanism eliminates a large number of interferences, including neighboring speakers and reverberations. It also uses advanced de-reverberation techniques to reduce echo and minimize its effect on the speech engine. This feature can enhance speech-centric applications like Skype, online game, video conference, and recording.

#### Noise Filter

This feature detects repetitive and stationary noises (non-voice signals) like computer fans, air conditioners, and other background noises then eliminates it in the incoming audio stream while recording.

### Advanced Thermal Design

#### ASUS Stack Cool 2

ASUS Stack Cool 2 is a fan-less and zero-noise cooling solution that lowers the temperature of critical heat generating components. The motherboard uses a special design on the printed circuit board (PCB) to dissipate heat that critical components generate. See page 2-3 for details.

## 8-Phase Power Design



The ASUS 8-Phase Power Design prolongs CPU lifespan and keeps the system stable by preventing high power stress to the CPU and power supply module. The design ensures high efficiency operation to generate less heat compared with conventional power solutions, thus achieving cool system environment and making this motherboard ideal for overclocking.

## Fanless Design and Heat-pipe



The ASUS fanless design allows multi-directional heat flow from major thermal sources in the motherboard to lower overall system temperature, resulting in quieter operation and longer system life. ASUS has devoted special efforts to address the thermal issues across the motherboard, and most notably in the following areas: CPU, power, VGA, Northbridge and Southbridge. The heat pipe, heatsink, and strategic board layout were tailor made to dissipate heat in the most efficient manner.

## WiFi-AP Solo™ (Optional)



Why buy wireless AP off the store when you can have it on board? The essence of wireless home network! WiFi-AP Solo™ turns the next generation ASUS M2N32-SLI Deluxe motherboard into wireless access point or client without extra costs. Bundled on the motherboard, WiFi-AP Solo™ can operate AP function even when the PC sleeps, so the clients can still play LAN game, share printer, exchange files, connect to the Internet, and make Skype phone calls. Digitalize your home with WiFi-AP Solo™.

### 1.3.3 ASUS Special features

#### ASUS Music Alarm



Wake up to the music of your choice instead of the irritating sound of an alarm clock. The ASUS Music Alarm gives you a personal wake-up call with your favorite CD music without having to enter the OS. See page 4-42 and 5-22 for details.

#### ASUS CrashFree BIOS 3



The ASUS CrashFree BIOS 3 allows users to restore corrupted BIOS data from a USB flash disk containing the BIOS file. This utility saves users the cost and hassle of buying a replacement BIOS chip. See page 4-9 for details.

## ASUS EZ Flash 2



EZ Flash 2 is a user-friendly BIOS update utility. Simply press the predefined hotkey to launch the utility and update the BIOS without entering the OS. Update your BIOS easily without preparing a bootable diskette or using an OS-based flash utility. See page 4-5 for details.

## ASUS MyLogo 3



ASUS My Logo 3 is the new feature present in the motherboard that allows you to personalize and add style to your system with customizable and animated boot logos. See page 5-8 for details.

## ASUS Q-Connector

You can use ASUS Q-Connector to connect / disconnect chassis front panel cables by only a few easy steps. See page 2-33 for details.

## DTS® Connect



This feature consists of two elements: DTS interactive and DTS NEO:PC. DTS interactive re-encodes your stereo or multi-channel sound into a DTS audio signal and send it out from your PC to any DTS enabled system. While DTS NEO:PC turns your stereo audio such as MP3, WMA, CD, and other sound format into a convincing multi-channel audio experience.

## PEG Link Mode



This feature enhances your PCI Express graphics card performance. It allows the motherboard to automatically adjust the PCI Express graphics link mode to the correct frequency based on the system configuration. Four additional settings are available for overclocking the PEG Link Mode. See page 4-23 for details.

## Precision Tweaker



This feature allows you to fine tune the CPU/memory voltage and gradually increase the memory Front Side Bus (FSB) and PCI Express frequency at 1MHz increment to achieve maximum system performance.

## ASUS Multi-language BIOS

The multi-language BIOS allows you to select the language of your choice from the available options. The localized BIOS menus allow easier and faster configuration. See page 4-14 for details.

## C.P.R. (CPU Parameter Recall)

The C.P.R. feature of the motherboard BIOS allows automatic re-setting to the BIOS default settings in case the system hangs due to overclocking. When the system hangs due to overclocking, C.P.R. eliminates the need to open the system chassis and clear the RTC data. Simply shut down and reboot the system, and the BIOS automatically restores the CPU default setting for each parameter.

### 1.3.4 ASUS Intelligent Overclocking features

#### ASUS O.C. Profile

The motherboard features the ASUS O.C. Profile that allows users to conveniently store or load multiple BIOS settings. The BIOS settings can be stored in the CMOS or a separate file, giving users freedom to share and distribute their favorite settings. See page 4-44 for details.

#### AI NOS™ (Non-Delay Overclocking System)

ASUS Non-delay Overclocking System™ (NOS) is a technology that auto-detects the CPU loading and dynamically overclocks the CPU speed only when needed. See page 4-20 for details.



This chapter lists the hardware setup procedures that you have to perform when installing system components. It includes description of the jumpers and connectors on the motherboard.

# Hardware information

A large, light gray, stylized number '2' is positioned behind the word 'Hardware' in the title.

2.1	Before you proceed .....	2-1
2.2	Motherboard overview.....	2-2
2.3	Central Processing Unit (CPU) .....	2-7
2.4	System memory .....	2-12
2.5	Expansion slots.....	2-16
2.6	Jumper .....	2-19
2.7	Connectors .....	2-20

## 2.1 Before you proceed

Take note of the following precautions before you install motherboard components or change any motherboard settings.



- Unplug the power cord from the wall socket before touching any component.
- Use a grounded wrist strap or touch a safely grounded object or to a metal object, such as the power supply case, before handling components to avoid damaging them due to static electricity.
- Hold components by the edges to avoid touching the ICs on them.
- Whenever you uninstall any component, place it on a grounded antistatic pad or in the bag that came with the component.
- Before you install or remove any component, ensure that the ATX power supply is switched off or the power cord is detached from the power supply. Failure to do so may cause severe damage to the motherboard, peripherals, and/or components.

### Onboard LED

The motherboard comes with a standby power LED. The green LED lights up to indicate that the system is ON, in sleep mode, or in soft-off mode. This is a reminder that you should shut down the system and unplug the power cable before removing or plugging in any motherboard component. The illustration below shows the location of the onboard LED.

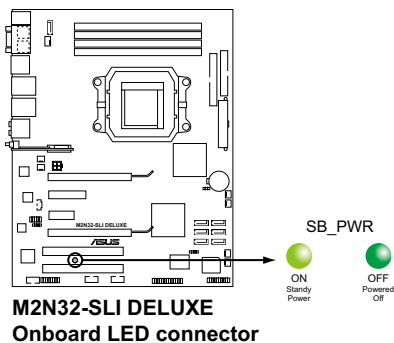

## 2.2 Motherboard overview

Before you install the motherboard, study the configuration of your chassis to ensure that the motherboard fits into it.



Make sure to unplug the power cord before installing or removing the motherboard. Failure to do so can cause you physical injury and damage motherboard components.

### 2.2.1 Placement direction

When installing the motherboard, make sure that you place it into the chassis in the correct orientation. The edge with external ports goes to the rear part of the chassis as indicated in the image below.

### 2.2.2 Screw holes

Place nine (9) screws into the holes indicated by circles to secure the motherboard to the chassis.



Do not overtighten the screws! Doing so can damage the motherboard.

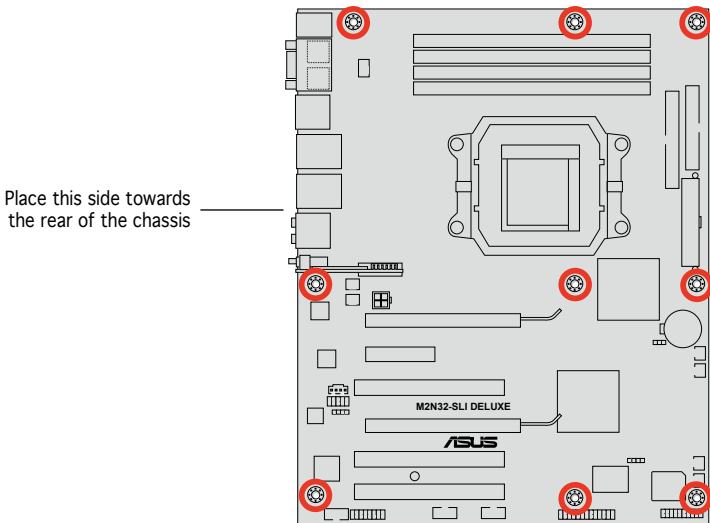

### 2.2.3 ASUS Stack Cool 2

The motherboard comes with the ASUS Stack Cool 2 cooling solution that lowers the temperature of critical heat generating components by 20°C. The motherboard uses a special design on the printed circuit board (PCB) to dissipate heat that critical components generate.



## 2.2.4 Motherboard layout

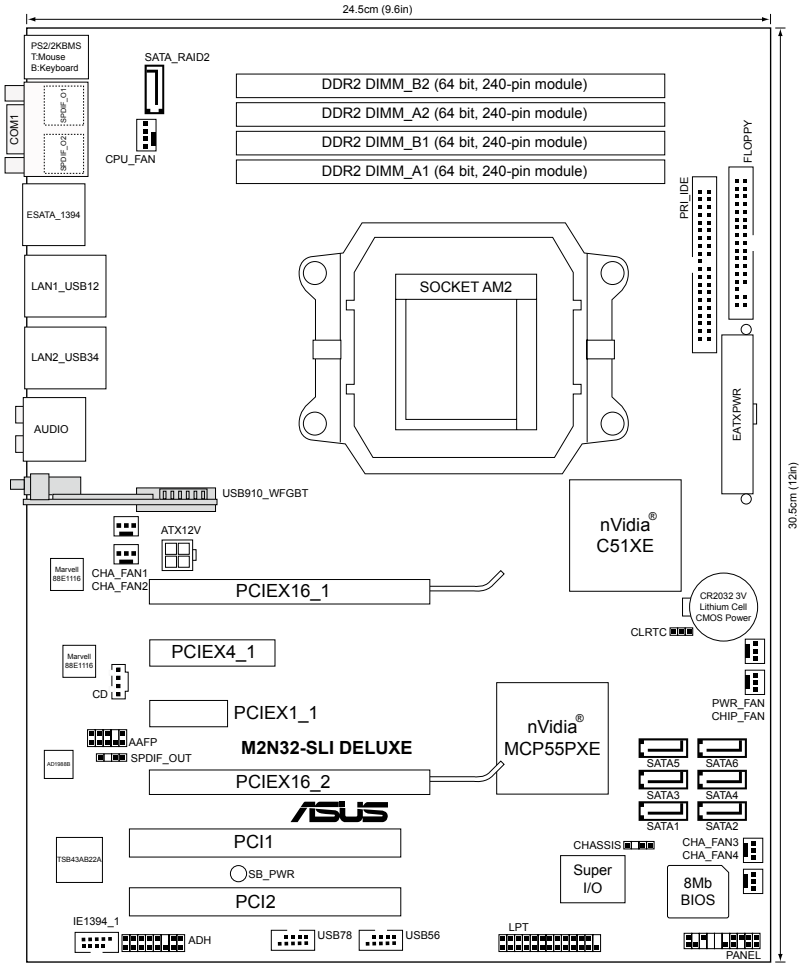

The USB910\_WFGBT connector with onboard Wireless LAN module is for Wireless Edition only and is grayed out in the above illustration.

## 2.2.5 Layout contents

Slots		Page
1.	DDR2 DIMM slots	2-12
2.	PCI slots	2-18
3.	PCI Express x 4 slot	2-18
4.	PCI Express x16 slots	2-18
5.	PCI Express x 1 slot	2-18

Jumper		Page
1.	Clear RTC RAM (3-pin CLRTC)	2-19

Rear panel connectors		Page
1.	PS/2 mouse port (green)	2-20
2.	Serial (COM) port	2-20
3.	IEEE 1394a port	2-20
4.	LAN 1 (RJ-45) port.	2-20
5.	LAN 2 (RJ-45) port.	2-20
6.	Center/Subwoofer port (orange)	2-20
7.	Rear Speaker Out port (black)	2-20
8.	Line In port (light blue)	2-20
9.	Line Out port (lime)	2-21
10.	Microphone port (pink)	2-21
11.	Side Speaker Out port (gray)	2-21
12.	USB 2.0 ports 1 and 2, 3 and 4	2-21
13.	External SATA port	2-21
14.	Optical S/PDIF Out port	2-22
15.	Coaxial S/PDIF Out port	2-22
16.	PS/2 keyboard port (purple)	2-22
17.	Wireless LAN port (for Wireless Edition only)	2-22
18.	Wireless LAN Activity LED (for Wireless Edition only)	2-22

Internal connectors		Page
1.	Floppy disk drive connector (34-1 pin FLOPPY)	2-23
2.	IDE connector (40-1 pin PRI_IDE)	2-23
3.	NVIDIA® nForce SLI Southbridge Serial ATA connectors (7-pin SATA1 [red], SATA2 [red], SATA3 [red], SATA4 [red], SATA5 [red], SATA6 [red])	2-24
4.	Silicon Image® Serial ATA RAID connector (7-pin SATA_RAID2)	2-25
5.	USB connectors Wireless Edition: (10-1 pin USB56, USB78) Standard Version: (10-1 pin USB56, USB78, USB910_WFGBT)	2-26
6.	IEEE 1394a port connector (10-1 pin IE1394_1)	2-26
7.	CPU, chassis, power, and chipset fan connectors (4-pin CPU_FAN, 3-pin CHA_FAN1, 3-pin CHA_FAN2, 3-pin CHA_FAN3, 3-pin CHA_FAN4, 3-pin PWR_FAN, 3-pin CHIP_FAN )	2-27
8.	Chassis intrusion connector (4-1 pin CHASSIS)	2-28
9.	ATX power connectors (24-pin EATXPWR, 4-pin EATX12V)	2-28
10.	Front panel audio connector (10-1 pin AAFP)	2-29
11.	Optical drive audio connector (4-pin CD)	2-30
12.	Parallel port connector (26-1 pin LPT)	2-30
13.	Digital audio connector (4-1 pin SPDIF)	2-31
14.	System panel connector (20-8-pin PANEL) <ul style="list-style-type: none"> <li>• System power LED (2-pin PLED)</li> <li>• Hard disk drive activity LED (2-pin IDE_LED)</li> <li>• System warning speaker (4-pin SPEAKER)</li> <li>• ATX power button/soft-off button (2-pin PWRSW)</li> <li>• Reset button (2-pin RESET)</li> </ul>	2-32



## 2.3 Central Processing Unit (CPU)

The motherboard comes with a 940-pin AM2 socket designed for the Athlon™ 64 X2/Athlon™ 64/Athlon™ 64FX/Sempron™ processor.



The AM2 socket has a different pinout from the 940-pin socket designed for the AMD AM2 processor. Make sure you use a CPU is designed for the AM2 socket. The CPU fits in only one correct orientation. DO NOT force the CPU into the socket to prevent bending the connectors on the socket and damaging the CPU!

### 2.3.1 Installing the CPU

To install a CPU:

1. Locate the CPU socket on the motherboard.

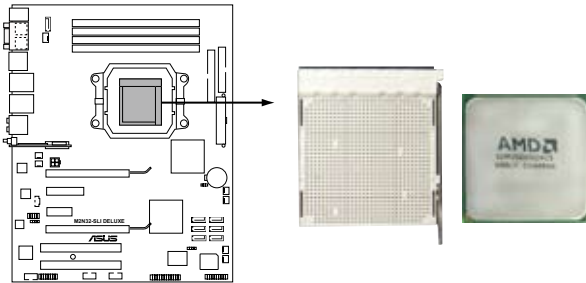

**M2N32-SLI DELUXE**  
**CPU Socket AM2**

2. Unlock the socket by pressing the lever sideways, then lift it up to a 90° angle.

Socket lever



Make sure that the socket lever is lifted up to a 90° angle; otherwise, the CPU will not fit in completely.

3. Position the CPU above the socket such that the CPU corner with the gold triangle matches the socket corner with a small triangle.
4. Carefully insert the CPU into the socket until it fits in place.

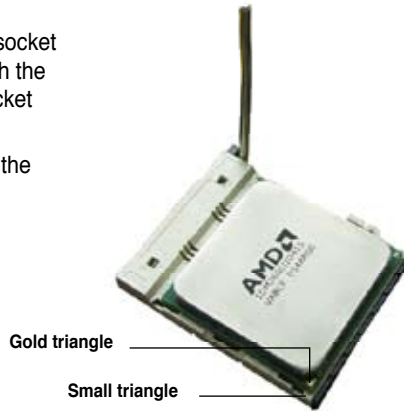

5. When the CPU is in place, push down the socket lever to secure the CPU. The lever clicks on the side tab to indicate that it is locked.
6. Install a CPU heatsink and fan following the instructions that came with the heatsink package.



## 2.3.2 Installing the heatsink and fan

The AMD Athlon™ 64FX/Athlon™ 64/Athlon™ 64 X2/Sempron™ processor requires a specially designed heatsink and fan assembly to ensure optimum thermal condition and performance.



---

Make sure that you use only AMD-certified heatsink and fan assembly.

---

To install the CPU heatsink and fan:

1. Place the heatsink on top of the installed CPU, making sure that the heatsink fits properly on the retention module base.



- The retention module base is already installed on the motherboard upon purchase.
  - You do not have to remove the retention module base when installing the CPU or installing other motherboard components.
  - If you purchased a separate CPU heatsink and fan assembly, make sure that a Thermal Interface Material is properly applied to the CPU heatsink or CPU before you install the heatsink and fan assembly.
- 

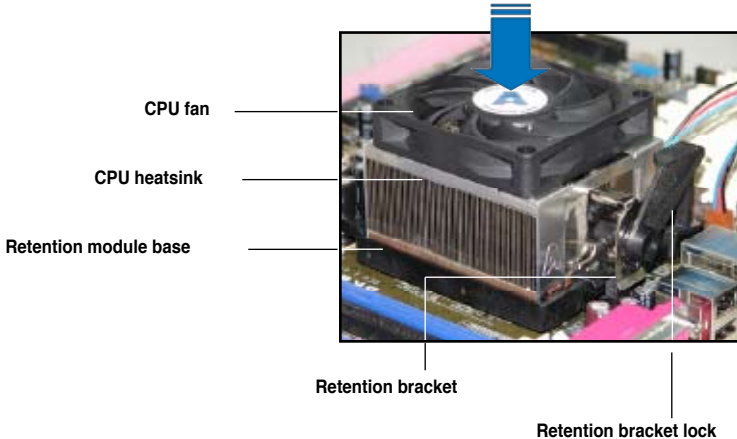

---

Your boxed CPU heatsink and fan assembly should come with installation instructions for the CPU, heatsink, and the retention mechanism. If the instructions in this section do not match the CPU documentation, follow the latter.

---

2. Attach one end of the retention bracket to the retention module base.

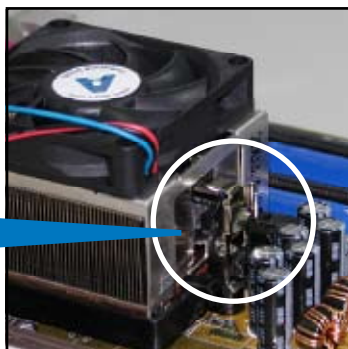
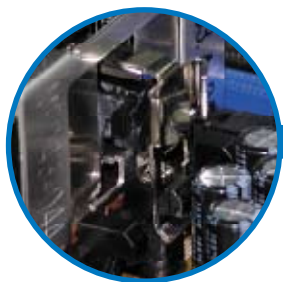

3. Align the other end of the retention bracket (near the retention bracket lock) to the retention module base. A clicking sound denotes that the retention bracket is in place.



---

Make sure that the fan and heatsink assembly perfectly fits the retention mechanism module base, otherwise you cannot snap the retention bracket in place.

---



4. Push down the retention bracket lock on the retention mechanism to secure the heatsink and fan to the module base.



5. When the fan and heatsink assembly is in place, connect the CPU fan cable to the connector on the motherboard labeled CPU\_FAN.

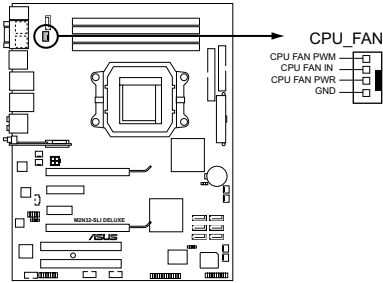

**M2N32-SLI DELUXE  
CPU Fan connectors**



- Do not forget to connect the CPU fan connector! Hardware monitoring errors can occur if you fail to plug this connector.
- This connector is backward compatible with old 3-pin CPU fan.

## 2.4 System memory

### 2.4.1 Overview

The motherboard comes with four Double Data Rate 2 (DDR2) Dual Inline Memory Modules (DIMM) sockets.

A DDR2 module has the same physical dimensions as a DDR DIMM but has a 240-pin footprint compared to the 184-pin DDR DIMM. DDR2 DIMMs are notched differently to prevent installation on a DDR DIMM socket.

The figure illustrates the location of the DDR2 DIMM sockets:

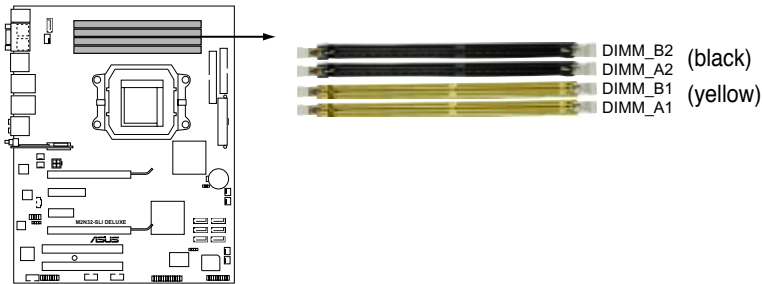

**M2N32-SLI DELUXE**  
**240-pin DDR2 DIMM Sockets**

Channel	Sockets
Channel A	DIMM_A1 and DIMM_A2
Channel B	DIMM_B1 and DIMM_B2

### 2.4.2 Memory configurations

You may install 256 MB, 512 MB, 1 GB, and 2GB unbuffered ECC/non-ECC DDR2 DIMMs into the DIMM sockets.

Recommended Memory Configurations

Mode	Sockets			
	DIMM_A1	DIMM_B1	DIMM_A2	DIMM_B2
Single-Channel	-	Populated	-	-
	Populated	-	-	-
Dual-channel (1)	Populated	Populated	-	-
Dual-channel (2)	Populated	Populated	Populated	Populated



- When using only one memory module, start installing the DDR2 DIMMs from slot DIMM\_A1 or DIMM\_B1 for better overclocking capability.
- For dual-channel configuration (2), you may:
  - install identical DIMMs in all four sockets OR
  - install identical DIMM pair in DIMM\_A1 and DIMM\_B1 (yellow sockets) and another identical DIMM pair in DIMM\_A2 and DIMM\_B2 (black sockets)
- Always use identical DDR2 DIMM pairs for dual channel mode. For optimum compatibility, it is recommended that you obtain memory modules from the same vendor. Visit the ASUS website (www.asus.com) for the latest Qualified Vendors list.



### Important notice on installing Windows® XP 32-bit version

If you install Windows® XP 32-bit version Operating System (OS), the limitation of this OS version is that it may reserve a certain amount of memory space for system devices. We recommend that you install less than 3 GB system memory if you would like to work under Windows® XP 32-bit version OS. The excess memory installation will not cause any usage problem, but it will not give users the benefit of manipulating this excess memory space.

Visit the ASUS FAQ site for further explanation:

<http://support.asus.com/faq/faq.aspx?SLanguage=en-us>

Under **General Search**, make the selections as shown, then click **Search**. Click the article titled “**4GB memory installed but less memory size detected.**”



You also may check the URLs below for third party comments on this issue:

[http://dlsvr01.asus.com/pub/ASUS/mb/4GB\\_Rev1.pdf](http://dlsvr01.asus.com/pub/ASUS/mb/4GB_Rev1.pdf)

<http://www.intel.com/support/motherboards/server/sb/cs-016594.htm>



This motherboard can support 8 GB physical memory on the operating systems listed below. You may install a maximum of 2 GB DIMMs on each slot.

32-bit	64-bit
Windows® 2000 Advanced Server	Windows® Server 2003 Standard x64 Edition
Windows® Server 2003 Enterprise Edition	Windows® XP Professional x64 Edition
	Windows® Server 2003 Enterprise x64 Edition

## 2.4.3 Installing a DIMM



Unplug the power supply before adding or removing DIMMs or other system components. Failure to do so can cause severe damage to both the motherboard and the components.

To install a DIMM:

1. Unlock a DIMM socket by pressing the retaining clips outward.
2. Align a DIMM on the socket such that the notch on the DIMM matches the break on the socket.
3. Firmly insert the DIMM into the socket until the retaining clips snap back in place and the DIMM is properly seated.

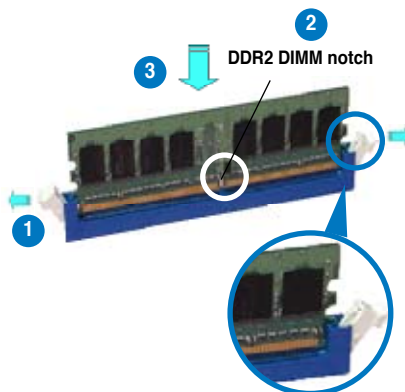

Unlocked retaining clip



- A DDR2 DIMM is keyed with a notch so that it fits in only one direction. Do not force a DIMM into a socket to avoid damaging the DIMM.
- The DDR2 DIMM sockets do not support DDR DIMMs. DO not install DDR DIMMs to the DDR2 DIMM sockets.

## 2.4.4 Removing a DIMM

To remove a DIMM:

1. Simultaneously press the retaining clips outward to unlock the DIMM.



Support the DIMM lightly with your fingers when pressing the retaining clips. The DIMM might get damaged when it flips out with extra force.

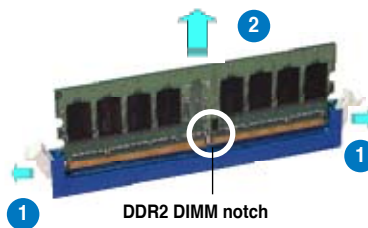

2. Remove the DIMM from the socket.



## M2N32-SLI Deluxe Series Motherboard Qualified Vendors Lists (QVL)

### DDR2-800 MHz capability

Size	Vendor	Chip No.	Chip Brand	Side(s)	Part No.	DIMM support		
						A*	B*	C*
512 MB	KINGSTON	Heat-Sink Package	-	SS	KHX6400D2/512	v	v	-
512 MB	KINGSTON	K4T51083QC	-	SS	KVR800D2N5/512	v	-	v
1024 MB	KINGSTON	K4T51083QC	-	DS	KVR800D2N5/1G	v	-	v
256 MB	SAMSUNG	K4T56083QF-ZCE7	-	SS	M378T3253FZ3-CE7	v	v	-
256 MB	SAMSUNG	K4T56083QF-ZCE7(ECC)	-	SS	M391T3253FZ3-CE7	v	v	-
512 MB	SAMSUNG	EDD339XX	-	SS	M378T6553CZ3-CE7	v	v	v
512 MB	Infineon	HYB18T256800AF25	-	DS	HYS64T64520HU-2.5-A	v	v	v
512 MB	Infineon	HYB18T256800AF25F	-	DS	HYS64T64520HU-2.5F-A	v	-	-
512 MB	Hynix	HY5PS12821BFP-S5	-	SS	HYMP564U64BP-S58	v	v	v
1024 MB	Hynix	HY5PS12821BFP-S5	-	DS	HYMP512U64BP-S58	v	v	v
512 MB	MICRON	5JAI29DQQ	-	SS	MT8HTF6464AY-80EA3	v	v	v
1024 MB	MICRON	5JAI29DQQ	-	DS	MT16HTF12864AY-80EA3	v	v	v
512 MB	MICRON	5ZD22D9GKX	-	SS	MT8HTF6464AY-80ED4	-	v	v
1024 MB	MICRON	5ZD22D9GKX	-	DS	MT16HTF12864AY-80ED4	v	v	-
512 MB	MICRON	6CD22D9GKX	-	SS	MT8HTF6464AY-80ED4	v	v	v
1024 MB	MICRON	6CD22D9GKX	-	DS	MT16HTF12864AY-80ED4	v	v	v
512 MB	CORSAIR	Heat-Sink Package	-	SS	CM2X512A-6400	v	v	-
1024 MB	CORSAIR	Heat-Sink Package	-	DS	CM2X1024A-6400PRO	v	v	v
1024 MB	CORSAIR	Heat-Sink Package	-	DS	CM2X1024A-6400C4	v	v	v
256 MB	A-DATA	E2508AB-GE-E	-	SS	M20EL6F3G3170A1D0Z	v	v	-
256 MB	A-DATA	E2508AB-GE-E	-	SS	M20EL6F3G3160A1D0Z	-	v	v
512 MB	A-DATA	E2508AB-GE-E	-	DS	M20EL6F3H4170A1D0Z	v	v	v
512 MB	Apacer	E2508AB-GE-E	-	DS	78.91091.420	v	v	-
512 MB	Crucial	Heat-Sink Package	-	SS	BL6464AA804.8FA	v	v	-
512 MB	Elixir	N2TU51280AE-25C	-	SS	M2Y51264TU88A2B-25C	v	v	-
1024 MB	NANYA	NT5TU64M8BE-28C	-	DS	NT1GT64U8HB0BY-25C	v	v	-

- A\*: Supports one module inserted in any slot as Single-channel memory configuration.
- B\*: Supports one pair of modules inserted into either the yellow slots or the black slots as one pair of Dual-channel memory configuration.
- C\*: Supports 4 modules inserted into both the yellow and black slots as two pairs of Dual-channel memory configuration.

## 2.5 Expansion slots

In the future, you may need to install expansion cards. The following sub-sections describe the slots and the expansion cards that they support.



---

Make sure to unplug the power cord before adding or removing expansion cards. Failure to do so may cause you physical injury and damage motherboard components.

---

### 2.5.1 Installing an expansion card

To install an expansion card:

1. Before installing the expansion card, read the documentation that came with it and make the necessary hardware settings for the card.
2. Remove the system unit cover (if your motherboard is already installed in a chassis).
3. Remove the bracket opposite the slot that you intend to use. Keep the screw for later use.
4. Align the card connector with the slot and press firmly until the card is completely seated on the slot.
5. Secure the card to the chassis with the screw you removed earlier.
6. Replace the system cover.

### 2.5.2 Configuring an expansion card

After installing the expansion card, configure the it by adjusting the software settings.

1. Turn on the system and change the necessary BIOS settings, if any. See Chapter 4 for information on BIOS setup.
2. Assign an IRQ to the card. Refer to the tables on the next page.
3. Install the software drivers for the expansion card.



---

When using PCI cards on shared slots, ensure that the drivers support “Share IRQ” or that the cards do not need IRQ assignments; otherwise, conflicts will arise between the two PCI groups, making the system unstable and the card inoperable.

---

## 2.5.3 Interrupt assignments

### Standard interrupt assignments

IRQ	Priority	Standard function
0	1	System Timer
1	2	Keyboard Controller
2	-	Redirect to IRQ#9
4	12	Communications Port (COM1)*
5	13	IRQ Holder for PCI Steering*
6	14	Floppy Disk Controller
7	15	Printer Port (LPT1)*
8	3	System CMOS/Real Time Clock
9	4	IRQ Holder for PCI Steering*
10	5	IRQ Holder for PCI Steering*
11	6	IRQ Holder for PCI Steering*
12	7	PS/2 Compatible Mouse Port*
13	8	Numeric Data Processor
14	9	Primary IDE Channel

\* These IRQs are usually available for ISA or PCI devices.

### IRQ assignments for this motherboard

	A	B	C	D	E	F	G	H
PCI Slot 1	-	shared	-	-	-	-	-	-
PCI Slot 2	-	-	shared	-	-	-	-	-
Onboard 1394	shared	-	-	-	-	-	-	-
PCIe x 16 1	shared	-	-	-	-	-	-	-
PCIe x 16 2	-	-	-	-	-	shared	-	-
PCIe x 4	-	-	-	-	-	-	shared	-
PCIe x 1	-	-	-	-	shared	-	-	-

## 2.5.4 PCI slots

The PCI slots support cards such as a LAN card, SCSI card, USB card, and other cards that comply with PCI specifications. Refer to the figure below for the location of the slots.

## 2.5.5 PCI Express x4 slot & PCI Express x1 slot

This motherboard supports PCI Express x4 and PCI Express x1 network cards, SCSI cards and other cards that comply with the PCI Express specifications. Refer to the figure below for the location of the slot.

## 2.5.6 Two PCI Express x16 slots

This motherboard supports two NVIDIA® SLI™-ready PCI Express x16 graphic cards that comply with PCI Express specifications. Refer to the figure below for the location of the slots.

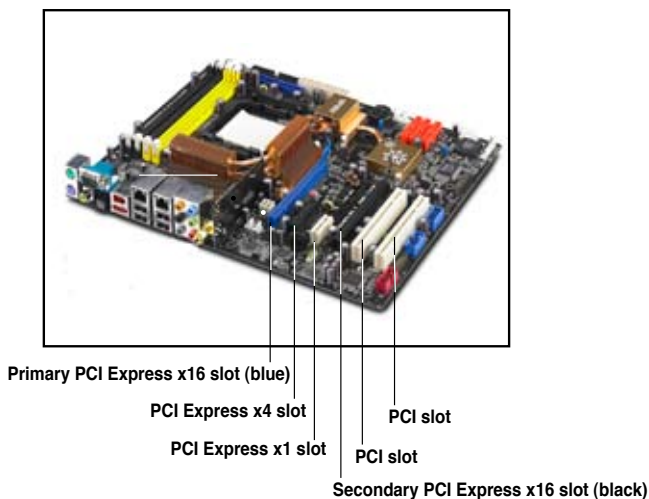

- Connect a rear chassis fan to the chassis (CHA\_FAN1 or CHA\_FAN2) connector when using two graphics cards for better thermal environment. See page 2-27 for details.
- In single card mode, you may use either the blue or black slot for PCI Express x16 cards.
- In NVIDIA® SLI™ mode, the PCI Express x16 slots work at the full bandwidth of PCI Express x16 for a combined bandwidth of x32.
- We recommend that you provide sufficient power when running NVIDIA® SLI™ mode. See pages 2-28 and 2-29 for details.
- See chapter 6 for details on the NVIDIA SLI™ technology feature.

## 2.6 Jumper

### Clear RTC RAM (CLRRTC)

This jumper allows you to clear the Real Time Clock (RTC) RAM in CMOS. You can clear the CMOS memory of date, time, and system setup parameters by erasing the CMOS RTC RAM data. The onboard button cell battery powers the RAM data in CMOS, which include system setup information such as system passwords.

To erase the RTC RAM:

1. Turn OFF the computer and unplug the power cord.
2. Remove the onboard battery.
3. Move the jumper cap from pins 1-2 (default) to pins 2-3. Keep the cap on pins 2-3 for about 5~10 seconds, then move the cap back to pins 1-2.
4. Reinstall the battery.
5. Plug the power cord and turn ON the computer.
6. Hold down the <Del> key during the boot process and enter BIOS setup to re-enter data.



Except when clearing the RTC RAM, never remove the cap on CLRRTC jumper default position. Removing the cap will cause system boot failure!

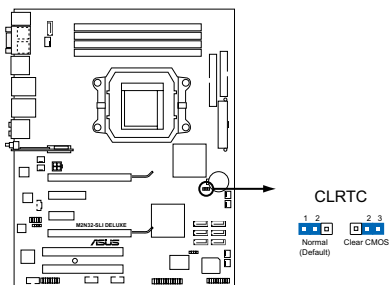

### M2N32-SLI DELUXE Clear RTC RAM



- Make sure to re-enter your previous BIOS settings after you clear the CMOS.
- You do not need to clear the RTC when the system hangs due to overclocking. For system failure due to overclocking, use the C.P.R. (CPU Parameter Recall) feature. Shut down and reboot the system so the BIOS can automatically reset parameter settings to default values.

## 2.7 Connectors

### 2.7.1 Rear panel connectors

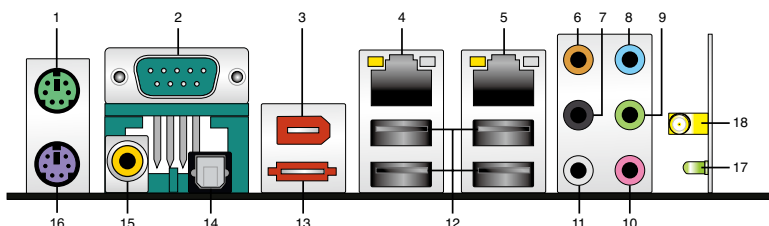

1. **PS/2 mouse port (green).** This port is for a PS/2 mouse.
2. **Serial port.** This 9-pin COM1 port is for pointing devices and other serial devices.
3. **IEEE 1394a port.** This 6-pin IEEE 1394a port provides high-speed connectivity for audio/video devices, storage peripherals, PCs, or portable devices.
4. **LAN 1 (RJ-45) port.** Supported by Marvell® 88E1116 Gigabit LAN controller, this port allows Gigabit connection to a Local Area Network (LAN) through a network hub. Refer to the table below for the LAN port LED indications.
5. **LAN 2 (RJ-45) port.** Supported by the Marvell® 88E1116 Gigabit LAN controller, this port allows Gigabit connection to a Local Area Network (LAN) through a network hub. Refer to the table below for the LAN port LED indications.

#### LAN port LED indications

Activity/Link Speed LED			
Status	Description	Status	Description
OFF	No link	OFF	10 Mbps connection
ORANGE	Linked	ORANGE	100 Mbps connection
BLINKING	Data activity	GREEN	1 Gbps connection

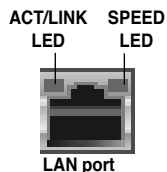

6. **Center/Subwoofer port (orange).** This port connects the center/subwoofer speakers.
7. **Rear Speaker Out port (black).** This port connects the rear speakers in a 4-channel, 6-channel, or 8-channel audio configuration..
8. **Line In port (light blue).** This port connects the tape, CD, DVD player, or other audio sources.

9. **Line Out port (lime).** This port connects a headphone or a speaker. In 4-channel, 6-channel, and 8-channel configuration, the function of this port becomes Front Speaker Out.
10. **Microphone port (pink).** This port connects a microphone.
11. **Side Speaker Out port (gray).** This port connects the side speakers in an 8-channel audio configuration.



Refer to the audio configuration table below for the function of the audio ports in 2, 4, 6, or 8-channel configuration.

### Audio 2, 4, 6, or 8-channel configuration

Port	Headset 2-channel	4-channel	6-channel	8-channel
Light Blue	Line In	Line In	Line In	Line In
Lime	Line Out	Front Speaker Out	Front Speaker Out	Front Speaker Out
Pink	Mic In	Mic In	Mic In	Mic In
Gray	–	–	–	Side Speaker Out
Black	–	Rear Speaker Out	Rear Speaker Out	Rear Speaker Out
Orange	–	–	Center/Subwoofer	Center/Subwoofer

12. **USB 2.0 ports 1 and 2, 3 and 4.** These 4-pin Universal Serial Bus (USB) ports are available for connecting USB 2.0 devices.
13. **External SATA port.** This port connects to an external SATA box or a Serial ATA port multiplier. This port supports a Serial ATA hard disk drive that you can combine with an external Serial ATA 3.0 Gb/s device to configure a RAID 0, RAID 1, or JBOD set through the onboard Silicon Image® SATA RAID controller.



The external SATA port supports external Serial ATA 3.0 Gb/s devices. Longer cables support higher power requirements to deliver signal up to two meters away, and enables improved hot-swap function.





- 
- Before creating a RAID set using Serial ATA hard disks, make sure that you have connected the Serial ATA signal cable and installed Serial ATA hard disk drives; otherwise, you cannot enter the Silicon Image RAID utility and SATA BIOS setup during POST.
  - If you intend to create a RAID configuration using this connector, set the Silicon 3132 Controller item in the BIOS to [RAID Mode]. See section “4.4.7 Onboard Device Configuration” for details.
  - Use these ports and an external Serial ATA box connected to the external SATA port, if you want to configure a RAID 0 or RAID 1 set.
  - The Serial ATA port multiplier and external Serial ATA box are purchased separately.
- 



- 
- Do not insert a different connector to this port.
  - DO NOT unplug the external Serial ATA box when a RAID 0 or JBOD is configured.
- 

14. **Optical S/PDIF Out port.** This port connects an external audio output device via an optical S/PDIF cable.
15. **Coaxial S/PDIF Out port.** This port connects an external audio output device via a coaxial S/PDIF cable.
16. **PS/2 keyboard port (purple).** This port is for a PS/2 keyboard.

### For Wireless Edition only:

Please refer to the wireless user guide for detail configuration and settings.

17. **Wireless LAN port.** This port is on the onboard wireless LAN module that allows you to set up a wireless network and exchange information with other wireless devices without tangling cables and wires. Connect the moveable omni-directional antenna to this port.
18. **Wireless LAN Activity LED.** The wireless module comes with an activity LED.





## 2.7.2 Internal connectors

### 1. Floppy disk drive connector (34-1 pin FLOPPY)

This connector is for the provided floppy disk drive (FDD) signal cable. Insert one end of the cable to this connector, then connect the other end to the signal connector at the back of the floppy disk drive.



Pin 5 on the connector is removed to prevent incorrect cable connection when using a FDD cable with a covered Pin 5.

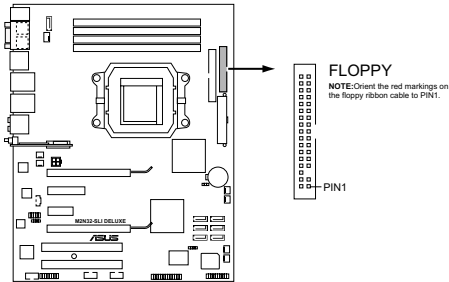

**M2N32-SLI DELUXE**  
Floppy disk drive connector

### 2. IDE connector (40-1 pin PRI\_IDE)

The onboard IDE connector is for the Ultra DMA (133/100/66) signal cable. There are three connectors on each Ultra DMA 133/100/66 signal cable: blue, black, and gray. Connect the blue connector to the motherboard's IDE connector, then select one of the following modes to configure your device.

	Drive jumper setting	Mode of device(s)	Cable connector
Single device	Cable-Select or Master	-	Black
Two devices	Cable-Select	Master	Black
		Slave	Gray
	Master	Master	Black or gray
	Slave	Slave	



- Pin 20 on the IDE connector is removed to match the covered hole on the Ultra DMA cable connector. This prevents incorrect insertion when you connect the IDE cable.
- Use the 80-conductor IDE cable for Ultra DMA 100/66 IDE devices.



If any device jumper is set as "Cable-Select," make sure all other device jumpers have the same setting.

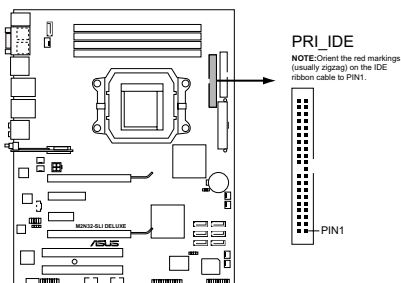

**M2N32-SLI DELUXE  
IDE connector**

**3. NVIDIA® nForce® 590 SLI Southbridge Serial ATA connectors (7-pin SATA1 [red], SATA2 [red], SATA3 [red], SATA4 [red], SATA5 [red], SATA6 [red])**

These connectors are for the Serial ATA signal cables for Serial ATA 3.0 Gb/s hard disk and optical disk drives. The Serial ATA 3.0 Gb/s is backward compatible with Serial ATA 1.5 Gb/s specification.

If you installed Serial ATA hard disk drives, you can create a RAID 0, RAID 1, RAID 0+1, RAID 5, or JBOD configuration through the onboard NVIDIA® MediaShield™ controller.



The RAID function of these connectors is set to [Disabled] by default. If you intend to create a Serial ATA RAID set using these connectors, enable the **RAID Enabled** item in the SATA Configuration sub-menu in the BIOS. See section “4.4.7 Onboard Device Configuration” for details.

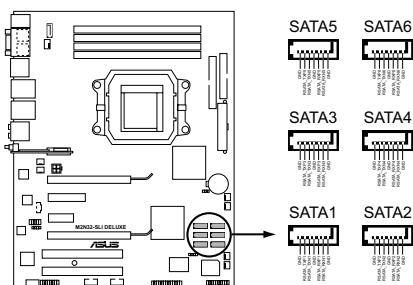

**M2N32-SLI DELUXE  
SATA connectors**



Connect the right-angle side of SATA signal cable to SATA device. Or you may connect the right-angle side of SATA cable to the onboard SATA port to avoid mechanical conflict with huge graphics cards.

right angle side

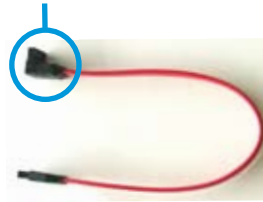

#### 4. Silicon Image® Serial ATA RAID connector (7-pin SATA\_RAID2)

This connector is for a Serial ATA signal cable. This connector supports a Serial ATA hard disk drive that you can configure for RAID through the onboard Serial ATA RAID controller.



The Silicon 3132 Controller item in the BIOS is set to [SATA2 Mode] by default, allowing you to enable the hot-plug function for the external device. Set to [RAID Mode] to use the connectors to build a RAID set. See section “4.4.7 Onboard Device Configuration” for details.

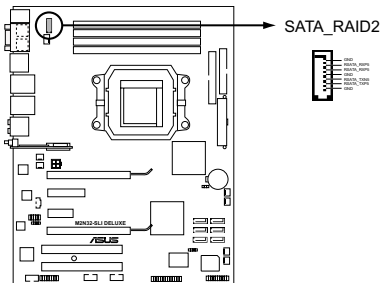

**M2N32-SLI DELUXE**  
**SATA RAID connector**



Before creating a RAID set using Serial ATA hard disks, make sure that you have connected the Serial ATA signal cables and installed Serial ATA hard disk drives; otherwise, you cannot enter the Silicon Image® RAID utility and SATA BIOS setup during POST.

5. **USB connectors**

**Wireless Edition: (10-1 pin USB56, USB78)**

**Standard Version: (10-1 pin USB56, USB 78, USB910\_WFGBT)**

These connectors are for USB 2.0 ports. Connect the USB module cable to any of these connectors, then install the module to a slot opening at the back of the system chassis. These USB connectors comply with USB 2.0 specification that supports up to 480 Mbps connection speed.

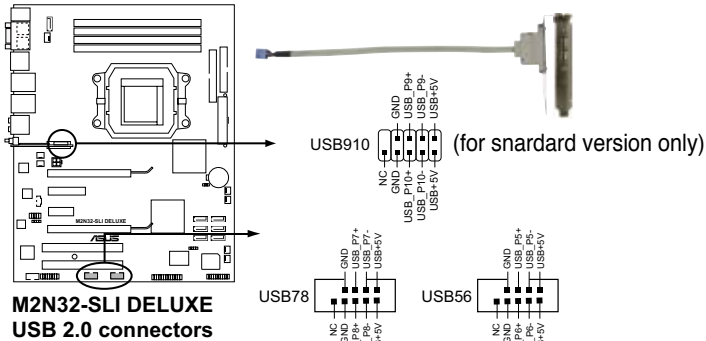

Never connect a 1394 cable to the USB connectors. Doing so will damage the motherboard!



You can connect the USB cable to ASUS Q-Connector (USB, blue) first, and then install the Q-Connector (USB) to the USB connector onboard.

6. **IEEE 1394a port connector (10-1 pin IE1394\_1)**

This connector is for a IEEE 1394a port. Connect the IEEE 1394a module cable to this connector, then install the module to a slot opening at the back of the system chassis.

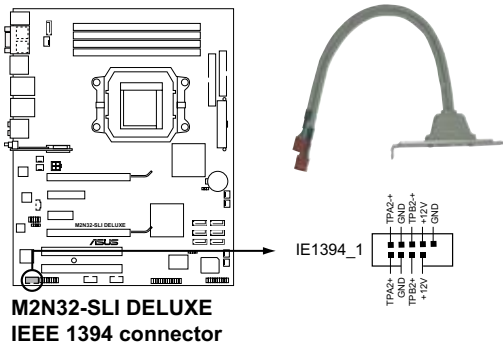



Never connect a USB cable to the IEEE 1394a connector. Doing so will damage the motherboard!



You can connect the 1394 cable to ASUS Q-Connector (1394, red) first, and then install the Q-Connector (1394) to the 1394 connector onboard.

## 7. CPU, chassis, power, and chipset fan connectors (4-pin CPU\_FAN, 3-pin CHA\_FAN1, 3-pin CHA\_FAN2, 3-pin CHA\_FAN3, 3-pin CHA\_FAN4, 3-pin PWR\_FAN, 3-pin CHIP\_FAN )

The fan connectors support cooling fans of 350 mA ~ 2000 mA (24 W max.) or a total of 1 A ~ 7 A (84 W max.) at +12V. Connect the fan cables to the fan connectors on the motherboard, making sure that the black wire of each cable matches the ground pin of the connector.



Do not forget to connect the fan cables to the fan connectors. Insufficient air flow inside the system may damage the motherboard components. These are not jumpers! Do not place jumper caps on the fan connectors!

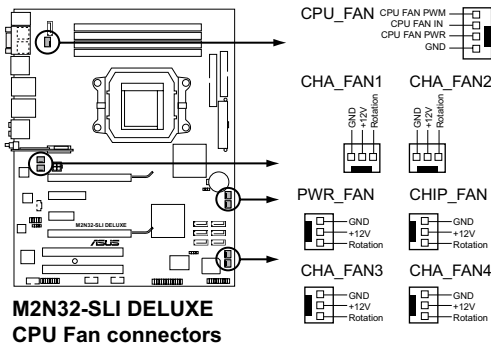

- Only the CPU-FAN and CHA-FAN 1-4 connectors support the ASUS Q-FAN2 feature.
- If you install two VGA cards, we recommend that you plug the rear chassis fan cable to the motherboard connector labeled CHA\_FAN1 or CHA\_FAN2 for better thermal environment.

**8. Chassis intrusion connector (4-1 pin CHASSIS)**

This connector is for a chassis-mounted intrusion detection sensor or switch. Connect one end of the chassis intrusion sensor or switch cable to this connector. The chassis intrusion sensor or switch sends a high-level signal to this connector when a chassis component is removed or replaced. The signal is then generated as a chassis intrusion event.

By default , the pin labeled “Chassis Signal” and “Ground” are shorted with a jumper cap. Remove the jumper caps only when you intend to use the chassis intrusion detection feature.

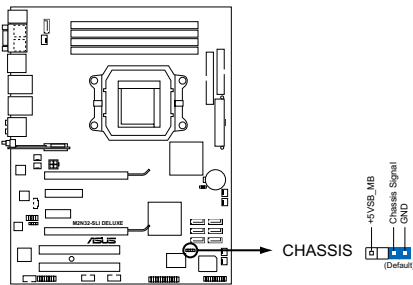

**M2N32-SLI DELUXE**  
Chassis intrusion connector

**9. ATX power connectors (24-pin EATXPWR, 4-pin EATX12V)**

These connectors are for ATX power supply plugs. The power supply plugs are designed to fit these connectors in only one orientation. Find the proper orientation and push down firmly until the connectors completely fit.

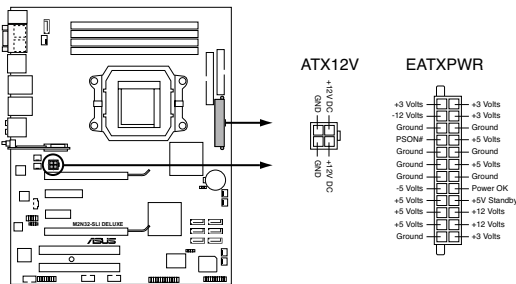

**M2N32-SLI DELUXE**  
ATX power connector



- For a fully configured system, we recommend that you use a power supply unit (PSU) that complies with ATX 12 V Specification 2.0 (or later version) and provides a minimum power of 600 W.
- Do not forget to connect the 4-pin ATX +12 V power plug; otherwise, the system will not boot.
- Use of a PSU with a higher power output is recommended when configuring a system with more power-consuming devices. The system may become unstable or may not boot up if the power is inadequate.
- The ATX 12 V Specification 2.0-compliant (500W) PSU has been tested to support the motherboard power requirements with the following configuration:  
CPU: AMD FX-62  
Memory 1024 MB DDR2-800 (x4)  
Graphics card: PCI Express x16 NVIDIA 7950Gx2  
Serial ATA device: SATA hard disk drive (x2)  
Optical drives: DVD-RW  
Parallel ATA device: IDE hard disk drive
- If you want to use two high-end PCI Express x16 cards, use a PSU with 500W to 600W power or above to ensure the system stability.

## 10. Front panel audio connector (10-1 pin AAFP)

This connector is for a chassis-mounted front panel audio I/O module that supports either HD Audio or legacy AC'97 audio standard. Connect one end of the front panel audio I/O module cable to this connector.

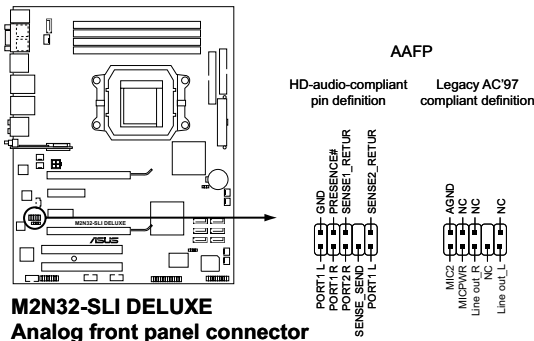

- We recommend that you connect a high-definition front panel audio module to this connector to avail of the motherboard's high-definition audio capability.
- By default, this connector is set to **AC'97**. If you want to connect a **High Definition** front panel audio module to this connector, set the **Front Panel Support Type** item in the BIOS setup to [HD Audio]. See section 4.4.7 Onboard Device Configuration for details.

### 11. Optical drive audio connector (4-pin CD)

These connectors allow you to receive stereo audio input from sound sources such as a CD-ROM, TV tuner, or MPEG card.

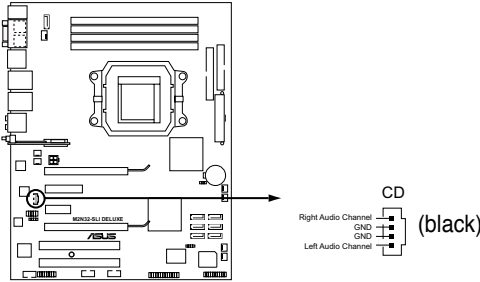

**M2N32-SLI DELUXE**  
Internal audio connector

### 12. Parallel port connector (26-1 pin LPT)

This connector is for a parallel port. Connect the parallel port module cable to this connector, then install the module to a slot opening at the back of the system chassis.

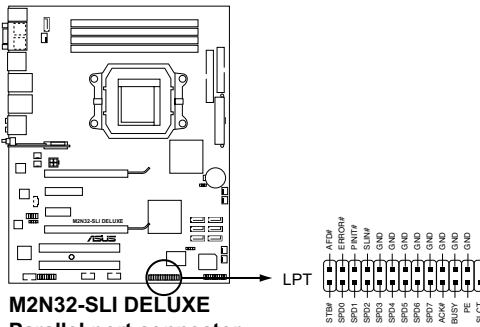

**M2N32-SLI DELUXE**  
Parallel port connector



The parallel port cable is purchased separately.



### 13. Digital audio connector (4-1 pin SPDIF)

This connector is for an additional Sony/Philips Digital Interface (S/PDIF) port(s). Connect the S/PDIF Out module cable to this connector, then install the module to a slot opening at the back of the system chassis.

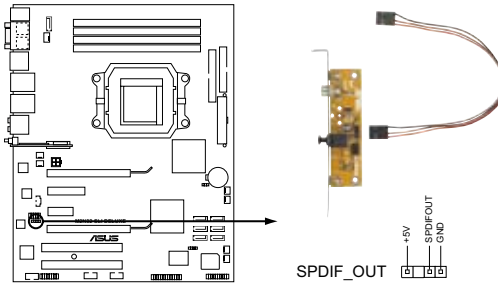

**M2N32-SLI DELUXE**  
**Digital audio connector**



---

The S/PDIF module is purchased separately.

---

## 14. System panel connector (20-8 pin PANEL)

This connector supports several chassis-mounted functions.

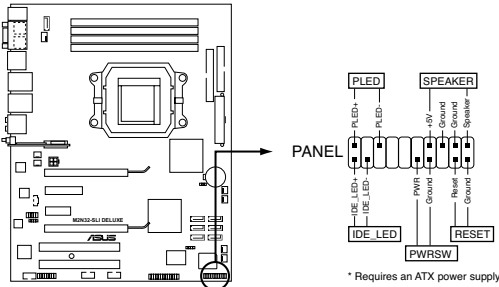

**M2N32-SLI DELUXE**  
**System panel connector**

- **System power LED (2-pin PLED)**

This 2-pin connector is for the system power LED. Connect the chassis power LED cable to this connector. The system power LED lights up when you turn on the system power, and blinks when the system is in sleep mode.

- **Hard disk drive activity LED (2-pin IDE\_LED)**

This 2-pin connector is for the HDD Activity LED. Connect the HDD Activity LED cable to this connector. The IDE LED lights up or flashes when data is read from or written to the HDD.

- **System warning speaker (4-pin SPEAKER)**

This 4-pin connector is for the chassis-mounted system warning speaker. The speaker allows you to hear system beeps and warnings.

- **ATX power button/soft-off button (2-pin PWR)**

This connector is for the system power button. Pressing the power button turns the system on or puts the system in sleep or soft-off mode depending on the BIOS settings. Pressing the power switch for more than four seconds while the system is ON turns the system OFF.

- **Reset button (2-pin RESET)**

This 2-pin connector is for the chassis-mounted reset button for system reboot without turning off the system power.

## Q-Connector (system panel)

You can use ASUS Q-Connector to connect / disconnect chassis front panel cables by only a few steps. Directions below shows how to install ASUS Q-Connector.

### Step1.

Connect correct front panel to ASUS Q-Connector first. You can refer to the marking on Q-Connector itself to know the detail pin definition.

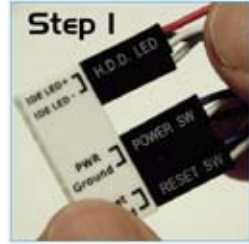

### Step2.

Properly install the ASUS Q-Connector to the System panel connector.



### Step3.

Front panel functions are enabled.



---

---

---

---

---

---

---

---

---

---

---

---

---

---

---

---

---

---

---

---

---

---

---

---

---

---

---

---

---

This chapter describes the power up sequence and ways of shutting down the system.

# Powering up **3**

## Chapter summary

# 3

<b>3.1</b>	<b>Starting up for the first time.....</b>	<b>3-1</b>
<b>3.2</b>	<b>Powering off the computer.....</b>	<b>3-2</b>

## 3.1 Starting up for the first time

1. After making all the connections, replace the system case cover.
2. Be sure that all switches are off.
3. Connect the power cord to the power connector at the back of the system chassis.
4. Connect the power cord to a power outlet that is equipped with a surge protector.
5. Turn on the devices in the following order:
  - a. Monitor
  - b. External SCSI devices (starting with the last device on the chain)
  - c. System power
6. After applying power, the system power LED on the system front panel case lights up. For systems with ATX power supplies, the system LED lights up when you press the ATX power button. If your monitor complies with “green” standards or if it has a “power standby” feature, the monitor LED may light up or switch between orange and green after the system LED turns on.

The system then runs the power-on self tests or POST. While the tests are running, the BIOS beeps or additional messages appear on the screen. If you do not see anything within 30 seconds from the time you turned on the power, the system may have failed a power-on test. Check the jumper settings and connections or call your retailer for assistance.
7. At power on, hold down the <Delete> key to enter the BIOS Setup. Follow the instructions in Chapter 4.

## **3.2 Powering off the computer**

### **3.2.1 Using the OS shut down function**

If you are using Windows® 2000:

1. Click the Start button then click Shut Down...
2. Make sure that the Shut Down option button is selected, then click the OK button to shut down the computer.
3. The power supply should turn off after Windows® shuts down.

If you are using Windows® XP:

1. Click the Start button then select Turn Off Computer.
2. Click the Turn Off button to shut down the computer.
3. The power supply should turn off after Windows® shuts down.

### **3.2.2 Using the dual function power switch**

While the system is ON, pressing the power switch for less than four seconds puts the system to sleep mode or to soft-off mode, depending on the BIOS setting. Pressing the power switch for more than four seconds lets the system enter the soft-off mode regardless of the BIOS setting. Refer to section “4.5 Power Menu” in Chapter 4 for details.



This chapter tells how to change the system settings through the BIOS Setup menus. Detailed descriptions of the BIOS parameters are also provided.

# BIOS setup **4**

4.1	Managing and updating your BIOS .....	4-1
4.2	BIOS setup program .....	4-10
4.3	Main menu .....	4-14
4.4	Advanced menu .....	4-19
4.5	Power menu.....	4-32
4.6	Boot menu .....	4-37
4.7	Tools menu .....	4-42
4.8	Exit menu .....	4-47

## 4.1 Managing and updating your BIOS

The following utilities allow you to manage and update the motherboard Basic Input/Output System (BIOS) setup.

1. **ASUS Update** (Updates the BIOS in Windows® environment.)
2. **ASUS EZ Flash 2** (Updates the BIOS in DOS using a floppy disk / USB flash disk, or the motherboard support CD.)
3. **Award BIOS Flash Utility** (Updates the BIOS using a bootable floppy disk / USB flash disk or a CD ROM.)
4. **ASUS CrashFree BIOS 3** (Updates the BIOS using a bootable floppy disk / USB flash disk or the motherboard support CD when the BIOS file fails or gets corrupted.)

Refer to the corresponding sections for details on these utilities.



---

Save a copy of the original motherboard BIOS file to a bootable floppy disk in case you need to restore the BIOS in the future. Copy the original motherboard BIOS using the ASUS Update or Award BIOS Flash utilities.

---

### 4.1.1 ASUS Update utility

The ASUS Update is a utility that allows you to manage, save, and update the motherboard BIOS in Windows® environment. The ASUS Update utility allows you to:

- Save the current BIOS file
- Download the latest BIOS file from the Internet
- Update the BIOS from an updated BIOS file
- Update the BIOS directly from the Internet, and
- View the BIOS version information.

This utility is available in the support CD that comes with the motherboard package.



---

ASUS Update requires an Internet connection either through a network or an Internet Service Provider (ISP).

---

### Installing ASUS Update

To install ASUS Update:

1. Place the support CD in the optical drive. The Drivers menu appears.
2. Click the Utilities tab, then click Install ASUS Update VX.XX.XX. See page 5-3 for the Utilities screen menu.
3. The ASUS Update utility is copied to your system.



Quit all Windows® applications before you update the BIOS using this utility.

## Updating the BIOS through the Internet

To update the BIOS through the Internet:

1. Launch the ASUS Update utility from the Windows® desktop by clicking **Start > Programs > ASUS > ASUSUpdate > ASUSUpdate**. The ASUS Update main window appears.

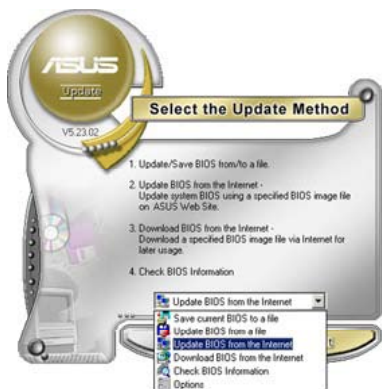

2. Select Update BIOS from the Internet option from the drop-down menu, then click Next.



3. Select the ASUS FTP site nearest you to avoid network traffic, or click Auto Select. Click Next.

- From the FTP site, select the BIOS version that you wish to download. Click Next.
- Follow the screen instructions to complete the update process.



The ASUS Update utility is capable of updating itself through the Internet. Always update the utility to avail all its features.



## Updating the BIOS through a BIOS file

To update the BIOS through a BIOS file:

- Launch the ASUS Update utility from the Windows® desktop by clicking Start > Programs > ASUS > ASUSUpdate > ASUSUpdate. The ASUS Update main window appears.
- Select Update BIOS from a file option from the drop-down menu, then click Next.



- Locate the BIOS file from the Open window, then click Open.
- Follow the screen instructions to complete the update process.

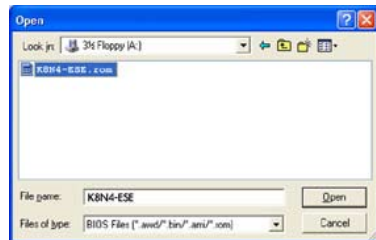

## 4.1.2 Creating a bootable floppy disk

1. Do either one of the following to create a bootable floppy disk.

### *DOS environment*

- a. Insert a 1.44MB floppy disk into the drive.
- b. At the DOS prompt, type `format A: /s` then press <Enter>.

### *Windows® XP environment*

- a. Insert a 1.44 MB floppy disk to the floppy disk drive.
- b. Click **Start** from the Windows® desktop, then select **My Computer**.
- c. Select the 3 1/2 Floppy Drive icon.
- d. Click File from the menu, then select **Format. A Format 3 1/2 Floppy Disk** window appears.
- e. Select **Create an MS-DOS startup disk** from the format options field, then click **Start**.

### *Windows® 2000 environment*

To create a set of boot disks for Windows® 2000:

- a. Insert a formatted, high density 1.44 MB floppy disk into the drive.
- b. Insert the Windows® 2000 CD to the optical drive.
- c. Click **Start**, then select **Run**.
- d. From the Open field, type  
`D:\bootdisk\makeboot a:`  
assuming that D: is your optical drive.
- e. Press <Enter>, then follow screen instructions to continue.

2. Copy the original or the latest motherboard BIOS file to the bootable floppy disk.

### 4.1.3 ASUS EZ Flash 2 utility

The ASUS EZ Flash 2 feature allows you to update the BIOS without having to go through the long process of booting from a floppy disk and using a DOS-based utility. The EZ Flash 2 utility is built-in the BIOS chip so it is accessible by pressing <Alt> + <F2> during the Power-On Self Tests (POST).

To update the BIOS using EZ Flash 2:

1. Visit the ASUS website ([www.asus.com](http://www.asus.com)) to download the latest BIOS file for the motherboard.
2. Save the BIOS file to a floppy disk or a USB flash disk, then restart the system.
3. You can launch the EZ Flash 2 by two methods.
  - (1) Insert the floppy disk / USB flash disk that contains the BIOS file to the floppy disk drive or the USB port.

Press <Alt> + <F2> during POST to display the following.

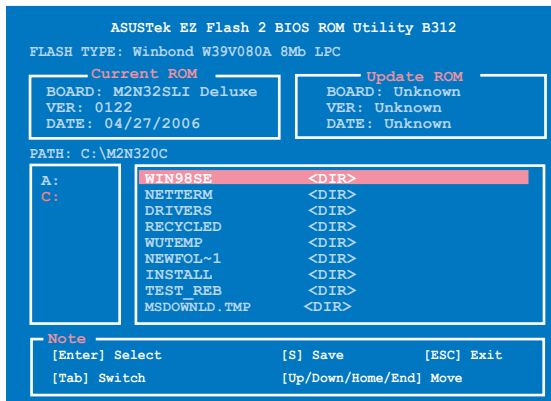

- (2) Enter BIOS setup program. Go to the **Tools** menu to select **EZ Flash2** and press <Enter> to enable it.  
You can switch between drives by pressing <Tab> before the correct file is found. Then press <Enter>.
4. When the correct BIOS file is found, EZ Flash 2 performs the BIOS update process and automatically reboots the system when done.



- This function can support devices such as USB flash disk, hard disk, or floppy disk **with FAT 32/16/12 format only**.
- Do not shut down or reset the system while updating the BIOS to prevent system boot failure!

## 4.1.4 Updating the BIOS

The Basic Input/Output System (BIOS) can be updated using the AwardBIOS Flash Utility. Follow these instructions to update the BIOS using this utility.

1. Download the latest BIOS file from the ASUS web site. Rename the file to M2N32SLI.BIN and save it to a floppy disk, CD ROM or a USB flash disk in **FAT 16/12 format**.



---

Save only the updated BIOS file in the disk to avoid loading the wrong BIOS file.

---

2. Copy the AwardBIOS Flash Utility (awdf flash.exe) from the Software folder of the support CD to the floppy disk, CD ROM or a USB flash disk with the latest BIOS file.
3. Boot the system in DOS mode using the bootable floppy disk, CD ROM or a USB flash disk you created earlier.
4. Under the DOS mode, use <X:> (X stands for the name of the disk assignment) to switch to the folder of floppy disk, CD ROM or USB flash disk you saved the BIOS file and AwardBIOS Flash Utility.
5. At the prompt, type awdf flash then press <Enter>. The Award BIOS Flash Utility screen appears.

```
AwardBIOS Flash Utility for ASUS V1.14
(C) Phoenix Technologies Ltd. All Rights Reserved

For NF590-SLI-M2N32-SLI-DELUXE      DATE:03/30/2006
Flash Type - PMC Pm49FL004T LPC/FWH

File Name to Program: 

Message: Please input File Name!
```



6. Type the BIOS file name in the File Name to Program field, then press <Enter>.

```
AwardBIOS Flash Utility for ASUS V1.14
(C) Phoenix Technologies Ltd. All Rights Reserved

For NF590-SLI-M2N32-SLI-DELUXE    DATE:03/30/2006
Flash Type - PMC Pm49FL004T LPC/FWH

File Name to Program: M2N32SLI.bin

Message: Do You Want To Save Bios (Y/N)
```

7. Press <N> when the utility prompts you to save the current BIOS file. The following screen appears.
8. The utility verifies the BIOS file in the floppy disk, CD ROM or a USB flash disk and starts flashing the BIOS file.

```
AwardBIOS Flash Utility for ASUS V1.14
(C) Phoenix Technologies Ltd. All Rights Reserved

For NF590-SLI-M2N32-SLI-DELUXE    DATE:03/30/2006
Flash Type - PMC Pm49FL004T LPC/FWH

File Name to Program: M2N32SLI.bin

Programming Flash Memory - OFE00 OK

Write OK      No Update      Write Fail

Warning: Don't Turn Off Power Or Reset System!
```



Do not turn off or reset the system during the flashing process!

9. The utility displays a Flashing Complete message indicating that you have successfully flashed the BIOS file. Remove the disk then press <F1> to restart the system.

```
AwardBIOS Flash Utility for ASUS V1.14
(C) Phoenix Technologies Ltd. All Rights Reserved

For NF590-SLI-M2N32-SLI-DELUXE    DATE:03/30/2006
Flash Type - PMC Pm49FL004T LPC/FWH

File Name to Program: M2N32SLI.bin

Flashing Complete
Press <F1> to Continue

Write OK      No Update      Write Fail

F1 Reset
```

### 4.1.5 Saving the current BIOS file

You can use the AwardBIOS Flash Utility to save the current BIOS file. You can load the current BIOS file when the BIOS file gets corrupted during the flashing process.



Make sure that the floppy disk, CD ROM or a USB flash disk has enough disk space to save the file.

To save the current BIOS file using the AwardBIOS Flash Utility:

1. Follow steps 1 to 6 of the previous section.
2. Press <Y> when the utility prompts you to save the current BIOS file. The following screen appears.

```
AwardBIOS Flash Utility for ASUS V1.14
(C) Phoenix Technologies Ltd. All Rights Reserved

For NF590-SLI-M2N32-SLI-DELUXE    DATE:03/30/2006
Flash Type - PMC Pm49FL004T LPC/FWH

File Name to Program: 0112.bin
Save current BIOS as:

Message:
```

3. Type a filename for the current BIOS file in the Save current BIOS as field, then press <Enter>.

```
AwardBIOS Flash Utility for ASUS V1.14
(C) Phoenix Technologies Ltd. All Rights Reserved

For NF590-SLI-M2N32-SLI-DELUXE    DATE:03/30/2006
Flash Type - PMC Pm49FL004T LPC/FWH

File Name to Program: 0112.bin
Checksum: 810DH
Save current BIOS as: 0113.bin

Message: Please Wait!
```

4. The utility saves the current BIOS file to the floppy disk, then returns to the BIOS flashing process.

```
AwardBIOS Flash Utility for ASUS V1.14
(C) Phoenix Technologies Ltd. All Rights Reserved

For NF590-SLI-M2N32-SLI-DELUXE    DATE:03/30/2006
Flash Type - PMC Pm49FL004T LPC/FWH

File Name to Program: 0113.bin
Now Backup System BIOS to
File!

Message: Please Wait!
```

## 4.1.6 ASUS CrashFree BIOS 3 utility

The ASUS CrashFree BIOS 3 is an auto recovery tool that allows you to restore the BIOS file when it fails or gets corrupted during the updating process. You can update a corrupted BIOS file using the motherboard support CD, the floppy disk, or the USB flash disk that contains the updated BIOS file.



---

Prepare the motherboard support CD, the floppy disk or the USB flash disk containing the updated motherboard BIOS before using this utility.

---

### Recovering the BIOS from the support CD

To recover the BIOS from the support CD:

1. Turn on the system.
2. Insert the motherboard support CD to the optical drive.
3. The utility displays the following message and automatically checks the CD for the BIOS file.

```
Award BootBlock BIOS v1.0
Copyright (c) 2000, Award Software, Inc.

BIOS ROM checksum error
Detecting IDE ATAPI device...
```

When found, the utility reads the BIOS file and starts flashing the corrupted BIOS file.

```
Award BootBlock BIOS v1.0
Copyright (c) 2000, Award Software, Inc.

BIOS ROM checksum error
Detecting IDE ATAPI device...
Found CDRom, try to Boot from it... Pass
```

4. Restart the system after the utility completes the updating process.

### Recovering the BIOS from the USB flash disk

To recover the BIOS from the USB flash disk:

1. Insert the USB flash disk that contains BIOS file to the USB port.
2. Turn on the system.
3. The utility will automatically check the devices for the BIOS file. When found, the utility reads the BIOS file and starts flashing the corrupted BIOS file.
4. Restart the system after the utility completes the updating process.



- Only the USB flash disk with FAT 32/16/12 format and single partition can support ASUS CrashFree BIOS 3. The device size should be smaller than 8GB.
  - DO NOT shut down or reset the system while updating the BIOS! Doing so can cause system boot failure!
-

## 4.2 BIOS setup program

This motherboard supports a programmable Low-Pin Count (LPC) chip that you can update using the provided utility described in section “4.1 Managing and updating your BIOS.”

Use the BIOS Setup program when you are installing a motherboard, reconfiguring your system, or prompted to “Run Setup.” This section explains how to configure your system using this utility.

Even if you are not prompted to use the Setup program, you can change the configuration of your computer in the future. For example, you can enable the security password feature or change the power management settings. This requires you to reconfigure your system using the BIOS Setup program so that the computer can recognize these changes and record them in the CMOS RAM of the LPC chip.

The LPC chip on the motherboard stores the Setup utility. When you start up the computer, the system provides you with the opportunity to run this program. Press <Del> during the Power-On Self-Test (POST) to enter the Setup utility; otherwise, POST continues with its test routines.

If you wish to enter Setup after POST, restart the system by pressing <Ctrl+Alt+Delete>, or by pressing the reset button on the system chassis. You can also restart by turning the system off and then back on. Do this last option only if the first two failed.

The Setup program is designed to make it as easy to use as possible. Being a menu-driven program, it lets you scroll through the various sub-menus and make your selections from the available options using the navigation keys.



- 
- The default BIOS settings for this motherboard apply for most conditions to ensure optimum performance. If the system becomes unstable after changing any BIOS settings, load the default settings to ensure system compatibility and stability. Select the **Load Default Settings** item under the Exit Menu. See section “4.8 Exit Menu.”
  - The BIOS setup screens shown in this section are for reference purposes only, and may not exactly match what you see on your screen.
  - Visit the ASUS website ([www.asus.com](http://www.asus.com)) to download the latest BIOS file for this motherboard.
-

## 4.2.1 BIOS menu screen

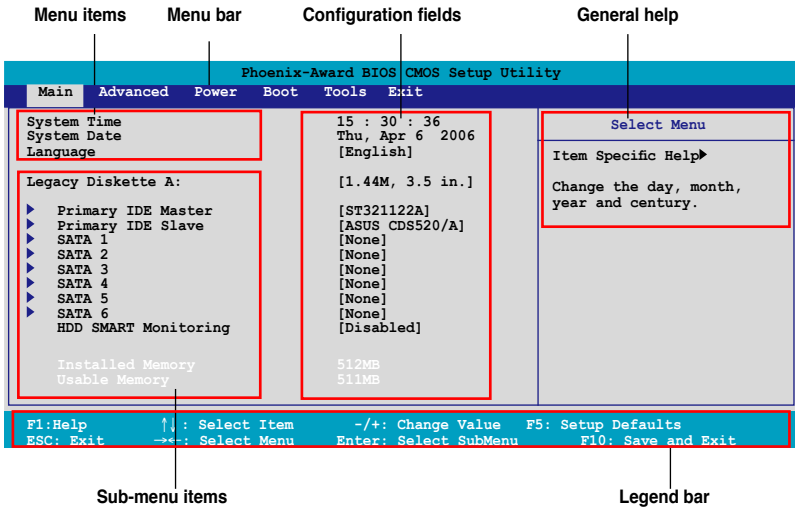

## 4.2.2 Menu bar

The menu bar on top of the screen has the following main items:

Main	For changing the basic system configuration
Advanced	For changing the advanced system settings
Power	For changing the advanced power management (APM) configuration
Boot	For changing the system boot configuration
Exit	For selecting the exit options and loading default settings

To select an item on the menu bar, press the right or left arrow key on the keyboard until the desired item is highlighted.



- The BIOS setup screens shown in this chapter are for reference purposes only, and may not exactly match what you see on your screen.
- Visit the ASUS website ([www.asus.com](http://www.asus.com)) to download the latest BIOS information.

### 4.2.3 Legend bar

At the bottom of the Setup screen is a legend bar. The keys in the legend bar allow you to navigate through the various setup menus. The following table lists the keys found in the legend bar with their corresponding functions.

Navigation Key	Function
<F1>	Displays the General Help screen
<F5>	Loads setup default values
<Esc>	Exits the BIOS setup or returns to the main menu from a sub-menu
Left or Right arrow	Selects the menu item to the left or right
Up or Down arrow	Moves the highlight up or down between fields
Page Down or - (minus)	Scrolls backward through the values for the highlighted field
Page Up or + (plus)	Scrolls forward through the values for the highlighted field
<Enter>	Brings up a selection menu for the highlighted field
<F10>	Saves changes and exit

### 4.2.4 Menu items

The highlighted item on the menu bar displays the specific items for that menu. For example, selecting **Main** shows the Main menu items.

The other items (Advanced, Power, Boot, and Exit) on the menu bar have their respective menu items.

### 4.2.5 Sub-menu items

A solid triangle before each item on any menu screen means that the item has a sub-menu. To display the sub-menu, select the item and press <Enter>.

### 4.2.6 Configuration fields

These fields show the values for the menu items. If an item is user-configurable, you can change the value of the field opposite the item. You cannot select an item that is not user-configurable.

A configurable field is enclosed in brackets, and is highlighted when selected. To change the value of a field, select it then press <Enter> to display a list of options. Refer to “4.2.7 Pop-up window.”

## 4.2.7 Pop-up window

Select a menu item then press <Enter> to display a pop-up window with the configuration options for that item.

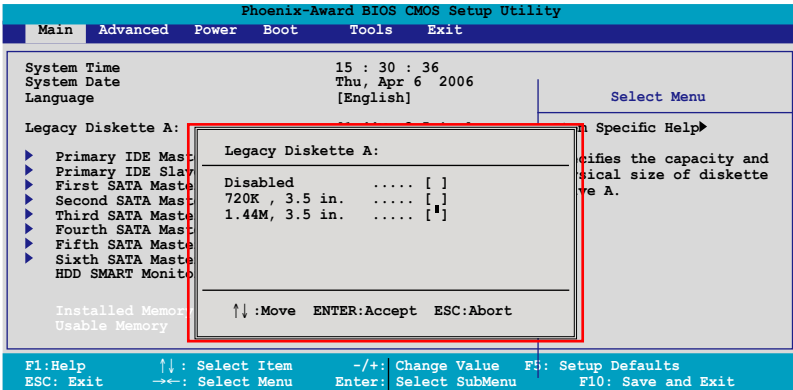

Pop-up menu

## 4.2.8 General help

At the top right corner of the menu screen is a brief description of the selected item.

## 4.3 Main menu

When you enter the BIOS Setup program, the Main menu screen appears, giving you an overview of the basic system information.



Refer to section “4.2.1 BIOS menu screen” for information on the menu screen items and how to navigate through them.

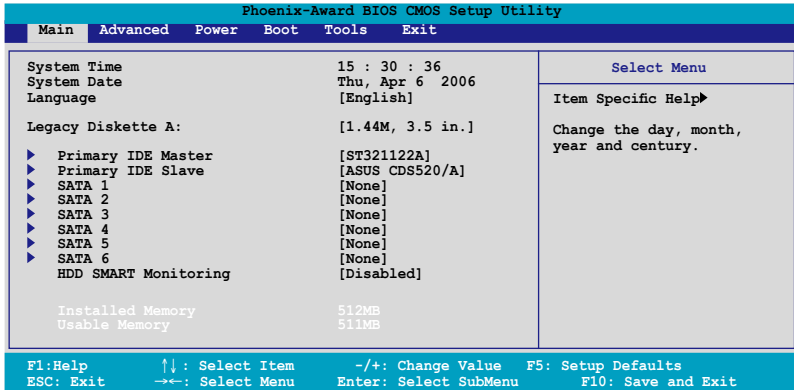

### 4.3.1 System Time [xx:xx:xx]

Allows you to set the system time.

### 4.3.2 System Date [Day xx/xx/xxxx]

Allows you to set the system date.

### 4.3.3 Language [English]

Allows you to choose the BIOS language version from the options. Configuration options: [English] [French] [Deutsch] [Chinese (Trad.)] [Chinese (Simp.)] [Japanese]

### 4.3.4 Legacy Diskette A [1.44M, 3.5 in.]

Sets the type of floppy drive installed.

Configuration options: [None] [360K, 5.25 in.] [1.2M, 5.25 in.] [720K, 3.5 in.] [1.44M, 3.5 in.]



### 4.3.5 Primary IDE Master/Slave

While entering Setup, the BIOS automatically detects the presence of IDE devices. There is a separate sub-menu for each IDE device. Select a device item then press <Enter> to display the IDE device information.

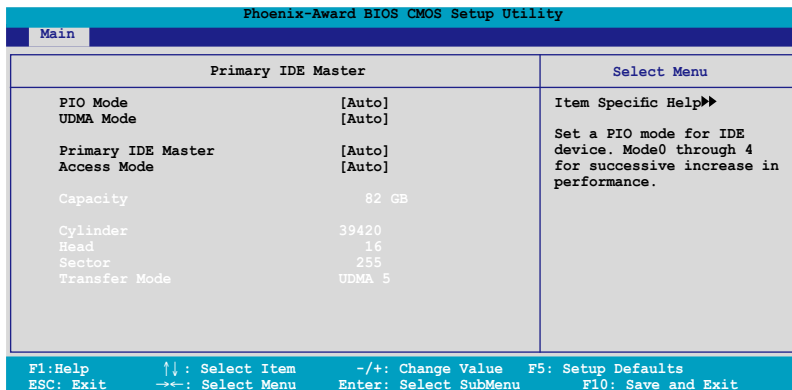

The BIOS automatically detects the values opposite the dimmed items (Capacity, Cylinder, Head, Sector and Transfer Mode). These values are not user-configurable. These items show N/A if no IDE device is installed in the system.

#### PIO Mode [Auto]

Sets the PIO mode for the IDE device.

Configuration options: [Auto] [Mode 0] [Mode 1] [Mode 2] [Mode 3] [Mode 4]

#### UDMA Mode [Auto]

Disables or sets the UDMA mode. Configuration options: [Disabled] [Auto]

#### Primary IDE Master/Slave [Auto]

Select [Auto] to automatically detect an IDE hard disk drive. If automatic detection is successful, the BIOS automatically fills in the correct values for the remaining fields on this sub-menu. If the hard disk was already formatted on a previous system, the setup BIOS may detect incorrect parameters. Select [Manual] to manually enter the IDE hard disk drive parameters. If no drive is installed select [None]. Configuration options: [None] [Auto] [Manual]

## Access Mode [Auto]

The default [Auto] allows automatic detection of an IDE hard disk drive. Select [CHS] for this item if you set the IDE Primary Master/Slave to [Manual]. Configuration options: [CHS] [LBA] [Large] [Auto]



---

Before attempting to configure a hard disk drive, make sure you have the correct configuration information supplied by the drive manufacturer. Incorrect settings may cause the system to fail to recognize the installed hard disk.

---

## Capacity

Displays the auto-detected hard disk capacity. This item is not configurable.

## Cylinder

Shows the number of the hard disk cylinders. This item is not configurable.

## Head

Shows the number of the hard disk read/write heads. This item is not configurable.

## Sector

Shows the number of sectors per track. This item is not configurable.

## Transfer Mode

Shows the Transfer mode. This item is not configurable.



---

After entering the IDE hard disk drive information into BIOS, use a disk utility, such as FDISK, to partition and format new IDE hard disk drives. This is necessary so that you can write or read data from the hard disk. Make sure to set the partition of the Primary IDE hard disk drives to active.

---

## 4.3.6 SATA 1-6

While entering Setup, the BIOS automatically detects the presence of Serial ATA devices. There is a separate sub-menu for each SATA device. Select a device item then press <Enter> to display the SATA device information.

Phoenix-Award BIOS CMOS Setup Utility		
Main		
SATA 1		Select Menu
Extended IDE Drive	[Auto]	Item Specific Help▶▶ Selects the type of fixed disk connected to the system.
Access Mode	[Auto]	
Capacity	0 MB	
Cylinder	0	
Head	0	
Landing Zone	0	
Sector	0	
F1: Help      ↑↓ : Select Item      -/+ : Change Value      F5: Setup Defaults		
ESC: Exit    →← : Select Menu      Enter: Select SubMenu      F10: Save and Exit		

The BIOS automatically detects the values opposite the dimmed items (Capacity, Cylinder, Head, Landing Zone and Sector). These values are not user-configurable. These items show 0 if no SATA device is installed in the system.

### Extended Drive [Auto]

Selects the type of fixed disk connected to the system.  
Configuration options: [None] [Auto]

### Access Mode [Auto]

Sets the sector addressing mode. Configuration options: [Large] [Auto]



Before attempting to configure a hard disk drive, make sure you have the correct configuration information supplied by the drive manufacturer. Incorrect settings may cause the system to fail to recognize the installed hard disk.

### Capacity

Displays the auto-detected hard disk capacity. This item is not configurable.

### Cylinder

Shows the number of the hard disk cylinders. This item is not configurable.

## Head

Shows the number of the hard disk read/write heads. This item is not configurable.

## Landing Zone

Shows the number of landing zone per track. This item is not configurable.

## Sector

Shows the number of sectors per track. This item is not configurable.



---

After entering the IDE hard disk drive information into BIOS, use a disk utility, such as FDISK, to partition and format new IDE hard disk drives. This is necessary so that you can write or read data from the hard disk. Make sure to set the partition of the Primary IDE hard disk drives to active.

---

### 4.3.7 HDD SMART Monitoring [Disabled]

Allows you to enable or disable the HDD Self-Monitoring Analysis and Reporting Technology (SMART) feature. Configuration options: [Disabled] [Enabled]

### 4.3.8 Installed Memory [xxx MB]

Shows the size of installed memory.

### 4.3.9 Usable Memory [XXX MB]

Shows the size of usable memory.

## 4.4 Advanced menu

The Advanced menu items allow you to change the settings for the CPU and other system devices.



Take caution when changing the settings of the Advanced menu items. Incorrect field values can cause the system to malfunction.

Phoenix-Award BIOS CMOS Setup Utility			
Main	Advanced	Power	Boot Tools Exit
<ul style="list-style-type: none"> <li>▶ JumperFree Configuration</li> <li>▶ AI Net2</li> <li>▶ PEG Link Mode</li>   <li>▶ CPU Configuration</li> <li>▶ Chipset</li> <li>▶ PCI/PnP</li> <li>▶ Onboard Device Configuration</li> </ul>		<p>Select Menu</p> <p>Item Specific Help▶</p> <p>Adjust system frequency/voltage.</p>	
<p>F1: Help    ↑↓ : Select Item    -/+ : Change Value    F5: Setup Defaults</p> <p>ESC: Exit    →← : Select Menu    Enter: Select SubMenu    F10: Save and Exit</p>			

### 4.4.1 JumperFree Configuration

Phoenix-Award BIOS CMOS Setup Utility			
Advanced		JumperFree Configuration	
<ul style="list-style-type: none"> <li>* OverClock Options      [Auto]</li> <li>* N.O.S. Option          Disabled</li> <li>* CPU Frequency          200.0</li> <li>* PCIE x16_1 clock        Auto</li> <li>* PCIE x16_2 clock        Auto</li> <li>* DDR2 Voltage Control    Auto</li> <li>* CPU Voltage             Auto</li> <li>* CPU Multiplier          Auto</li> <li>▶ Advanced Voltage Control</li> </ul>		<p>Select Menu</p> <p>Item Specific Help▶▶</p> <p>Press [Enter] to select overclock profile.</p>	
<p>F1: Help    ↑↓ : Select Item    -/+ : Change Value    F5: Setup Defaults</p> <p>ESC: Exit    →← : Select Menu    Enter: Select Sub-menu    F10: Save and Exit</p>			

#### AI Tuning [Auto]

Allows selection of CPU overclocking options to achieve desired CPU internal frequency. Select either one of the preset overclocking configuration options:

**Manual**                                      Allows you to individually set overclocking parameters.

**Auto**                                              Loads the optimal settings for the system.

**Standard**                                      Loads the standard settings for the system.

<b>AI Overclock</b>	Loads overclocking profiles with optimal parameters for stability when overclocking.
<b>AI N.O.S.</b>	The ASUS Non-delay Overclocking System feature intelligently determines the system load and automatically boosts the performance for the most demanding tasks.



The following item becomes user-configurable when you set **AI Tuning** to [AI Overclock].

### Overclock Options [Disabled]

Allows you to set the overclocking options.

Configuration options: [Disabled] [Overclock 3%] [Overclock 5%] [Overclock 8%] [Overclock 10%]



The following item becomes user-configurable when you set **AI Tuning** to [AI N.O.S.].

### N.O.S. Option [Disabled]

Allows you to set the Non-delay Overclocking System mode.

Configuration options: [Disabled] [Overclock 3%] [Overclock 5%] [Overclock 8%] [Overclock 10%]

The following items will become user-configurable when you set **AI Tuning** to [Manual]

### CPU Frequency [XXX] (value is auto-detected)

Indicates the frequency sent by the clock generator to the system bus and PCI bus. The bus frequency (external frequency) multiplied by the bus multiple equals the CPU speed. The BIOS auto-detects the value of this item. The values range from 200.0 to 400.0.



Setting a very high CPU frequency may cause the system to become unstable. If this happens, revert to the default setting.

### PCIEX16\_1 Clock [Auto]

Allows you to set the clock of the PCI Express\_1.

Configuration options: [Auto] [100MHz] ~ [200MHz]

### PCIEX16\_2 Clock [Auto]

Allows you to set the clock of the PCI Express\_2.

Configuration options: [Auto] [100MHz] ~ [200MHz]

## DDR2 Voltage Control [Auto]

Allows you to set the operating DDR2 voltage.

Configuration options: [Auto] [1.800V] [1.825V] [1.850V] ~ [2.500V]

## CPU Multiplier [Auto]

Allows you to set the operating CPU multiplier. The configuration options may vary depending on the type of CPU installed. Configuration options: [Auto] [5x] [6x] ~ [25x]

## CPU Voltage [Auto]

Allows you to set the operating CPU voltage. The configuration options may vary depending on the type of CPU installed. Configuration options: [Auto]



Please refer to CPU documentation before setting the CPU Vcore voltage. Setting a high Vcore voltage may damage the CPU.

## Advanced Voltage Control

Phoenix-Award BIOS CMOS Setup Utility		
Advanced		
Advanced Voltage Control		Select Menu
CPU Vcore Offset Voltage	[Disabled]	Item Specific Help▶▶▶
DDR2 Termination Voltage	[0.5 x DDR2 Voltage]	Set NB Core/PCI-E Voltage.
CPU to NB HT Voltage	[1.200V]	
NB to SB HT Voltage	[Auto]	
NB Core/PCI-E Voltage	[Auto]	
SB Core/PCI-E Voltage	[Auto]	
SB Standby Core Voltage	[+1.500V]	

F1: Help    ↑↓: Select Item    -/+ : Change Value    F5: Setup Defaults  
ESC: Exit    →←: Select Menu    Enter: Select Sub-menu    F10: Save and Exit

### CPU Vcore Offset Voltage [Disabled]

Enables or disables the CPU Vcore offset voltage. When this item is set to [Enabled], the CPU Vcore voltage will offset 200mV. Configuration options: [Disabled] [Enabled]

### DDR2 Termination Voltage [0.5 x DDR2 Voltage]

Allows you to set the DDR2 termination voltage.

Configuration options: [0.5 x DDR2 Voltage] [0.6 x DDR2 Voltage]

### CPU to NB HT Voltage [1.200V]

Allows you to set the CPU to Northbridge HT voltage.

Configuration options: [1.200V] [1.225V] [1.250V] ~ [1.500V]

NB to SB HT Voltage [Auto]

Allows you to set the NB to SB HT voltage.

Configuration options: [+1.300V] [+1.325V] [+1.350V] ~ [+1.500V] [Auto]

NB Core/PCI-E Voltage [Auto]

Allows you to set the NB Core/PCI-E voltage.

Configuration options: [+1.200V] [+1.250V] [+1.300V] [+1.350V] [+1.400V] [Auto]

SB Core/PCI-E Voltage [Auto]

Allows you to set the Southbridge core/PCI Express voltage.

Configuration options: [+1.500V] [+1.525V] [+1.550V] ~ [+1.700V] [+1.750V] [Auto]

SB Standby Core Voltage [+1.50V]

Allows you to set the Southbridge +1.5V standby voltage.

Configuration options: [+1.50V] [+1.60V] [+1.70V]

### 4.4.2 LAN Cable Status

Phoenix-Award BIOS CMOS Setup Utility			
Advanced			
AI Net2			Select Menu
POST Check LAN Cable	[Disabled]		Item Specific Help▶▶  Enable or Disable LAN cable check during POST.
POST Check LAN2 Cable	[Disabled]		
Pair	Status	Length	
LAN1 (1-2)	Open	N/A	
LAN1 (3-4)	Open	N/A	
LAN1 (5-6)	Open	N/A	
LAN1 (7-8)	Open	N/A	
LAN2 (1-2)	Open	N/A	
LAN2 (3-4)	Open	N/A	
LAN2 (5-6)	Open	N/A	
LAN2 (7-8)	Open	N/A	
F1: Help	↑↓: Select Item	-/+ : Change Value	F5: Setup Defaults
ESC: Exit	→←: Select Menu	Enter: Select Sub-menu	F10: Save and Exit

**POST Check LAN Cable [Disabled]**

**POST Check LAN2 Cable [Disabled]**

Enables or disables checking of the LAN/LAN2 cable during the Power-On Self-Test (POST).

Configuration options: [Disabled] [Enabled]



### 4.4.3 PEG Link Mode

Phoenix-Award BIOS CMOS Setup Utility	
Advanced	
PEG Link Mode	[Auto]
Select Menu	
Item Specific Help▶▶▶	
Enhance performance on PCIe serial graphic card.	

#### PEG Link Mode [Auto]

Allows you to enhance the performance of your PCI Express graphics card. Configuration options: [Auto] [Disabled] [Normal] [Fast] [Faster]



Setting to [Fast] or [Faster] may cause your system to be unstable. If this happens, revert to the default setting [Auto].

### 4.4.4 CPU Configuration

Phoenix-Award BIOS CMOS Setup Utility	
Advanced	
CPU Configuration	
CPU Type	AMD Engineering Sample
CPU Speed	2600 MHz
Cache RAM	1024K
▶ DRAM Configuration	[Enabled]
SLI Ready Memory	[Disabled]
AMD Cool 'n' Quiet Function	[Enabled]
Select Menu	
Item Specific Help▶▶▶	
DRAM timing and control.	

#### DRAM Configuration

The items in the sub-menu show the DRAM-related information auto-detected by the BIOS.

Phoenix-Award BIOS CMOS Setup Utility	
Advanced	
DRAM Configuration	
Memory Clock Frequency	[Auto]
Tcl	[Auto]
Trcd	[Auto]
Trp	[Auto]
Tras	[Auto]
1T/2T Memory Timing	[Auto]
DRAM ECC Enable	[Disabled]
AI Clock Skew	[Auto]
x channel A Clock Skew	
x channel B Clock Skew	
▶Advanced Memeory Settings	
▶DRAM Timing Control	
▶Output Driver Control	
Select Menu	
Item Specific Help▶▶▶	
Setting platform Memclock or limit value.	
F1:Help      ↑↓: Select Item      -/+ : Change Value      F5: Setup Defaults ESC: Exit    →←: Select Menu      Enter: Select Sub-menu    F10: Save and Exit	

Memory Clock Frequency [Auto]

Sets the memory clock frequency.

Configuration options: [Auto] [DDR2 400] [DDR2 533] [DDR2 667] [DDR2 800]

Tcl [Auto]

Configuration options: [Auto] [3] [4] [5] [6]

Trcd [Auto]

Configuration options: [Auto] [3] [4] [5] [6]

Trp [Auto]

Configuration options: [Auto] [3] [4] [5] [6]

Tras [Auto]

Configuration options: [Auto] [5] [6] [7] ~ [18]

1T/2T Memory Timing [Auto]

Sets the memory timing. Configuration options: [Auto] [1T] [2T]

DRAM ECC Enable [Disabled]

Enables or disables the DRAM ECC function.

Configuration options: [Disabled] [Enabled]



---

This item appears only when you install DRAM modules that support ECC function.

---

AI Clock Skew [Auto]

Below items become user-configurable when you set the AI Clock Skew to [Manual]

Channel A Clock Skew: [Advance 900ps] [Advance 750ps] [Advance 600ps] [Advance 450ps] [Advance 300ps] [Advance 150ps] [Normal] [Delay 150ps] [Normal] [Delay 300ps] [Normal] [Delay 450ps] [Normal] [Delay 600ps] [Normal] [Delay 750ps] [Normal] [Delay 900ps]

Channel B Clock Skew: [Advance 900ps] [Advance 750ps] [Advance 600ps] [Advance 450ps] [Advance 300ps] [Advance 150ps] [Normal] [Delay 150ps] [Normal] [Delay 300ps] [Normal] [Delay 450ps] [Normal] [Delay 600ps] [Normal] [Delay 750ps] [Normal] [Delay 900ps]

Advance Memory Settings

**CPU On-die Termination**

Configuration options: [Auto] [300ohm] [150ohm] [75ohm]

**Trc**

Configuration options: [Auto] [11] [12] [13]...[25] [26]

**Twr**

Configuration options: [Auto] [3] [4] [5] [6]

**Trrd**

Configuration options: [Auto] [2] [3] [4] [5]

**Trwt**

Configuration options: [Auto] [2] [3] [4] [5] [6] [7] [8] [9]

**Twtr**

Configuration options: [Auto] [1] [2] [3]

**Trtp**

Configuration options: [Auto] [2/4] [3/5]

**Twrrd**

Configuration options: [Auto] [0] [1] [2] [3]

**Twrrw**

Configuration options: [Auto] [1] [2] [3]

**Trdrd**

Configuration options: [Auto] [2] [3] [4] [5]

**Tref**

Configuration options: [Auto] [Undef] [7.8 us] [3.9 us]

**Trfc**

Configuration options: [Auto] [0] [1] [2] [3] [4]

**DRAM Termination**

Configuration options: [Auto] [Disabled] [75 ohms] [150 ohms] [50 ohms]

**Max Async Latency**

Configuration options: [Auto] [0 ns] [1 ns] [2 ns] [3 ns]...[14 ns] [15 ns]

**R/W Queue Bypass**

Configuration options: [Auto] [2x] [4x] [8x] [16x]

**Dynamic Idle Cycle Counter**

Configuration options: [Auto] [Disabled] [Enabled]

**Idle Cycle Limit**

Configuration options: [Auto] [0 cycles] [4 cycles] [8 cycles] [16 cycles] [32 cycles] [64 cycles] [128 cycles] [256 cycles]

**DCQ Bypass Maximum**

Configuration options: [Auto] [0x] [1x] [2x] [3x]...[14x] [15x]

**DRAM Burst Length**

Configuration options: [Auto] [64-byte] [32-byte]

**RdPadRcvFIFO Delay**

Configuration options: [Auto] [1.5] [2] [2.5] [3] [3.5]

**Disable Jitter**

Configuration options: [Auto] [OFF] [ON]

**DRAM Bank Interleaving**

Configuration options: [Disabled] [Enabled]

**DRAM Timing Control****CKE Fine Delay**

Configuration options: [Auto] [No delay] [1/64 MEMCLK delay] [2/64 MEMCLK delay] [3/64 MEMCLK delay] [4/64 MEMCLK delay] [5/64 MEMCLK delay]...[30/64 MEMCLK delay] [31/64 MEMCLK delay]

**CKE Setup Time**

Configuration options: [Auto] [1/2 MEMCLK] [1 MEMCLK]

**CS/ODT Fine Delay**

Configuration options: [Auto] [No delay] [1/64 MEMCLK delay] [2/64 MEMCLK delay] [3/64 MEMCLK delay] [4/64 MEMCLK delay] [5/64 MEMCLK delay]...[30/64 MEMCLK delay] [31/64 MEMCLK delay]

**CS/ODT Setup Time**

Configuration options: [Auto] [1/2 MEMCLK] [1 MEMCLK]

**Address/Command Fine Delay**

Configuration options: [Auto] [No delay] [1/64 MEMCLK delay] [2/64 MEMCLK delay] [3/64 MEMCLK delay] [4/64 MEMCLK delay] [5/64 MEMCLK delay]...[30/64 MEMCLK delay] [31/64 MEMCLK delay]

**Address/Command Setup Time**

Configuration options: [Auto] [1/2 MEMCLK] [1 MEMCLK]

**Read DQS Timing Control**

Configuration options: [Auto] [No delay] [1/64 MEMCLK delay] [2/64 MEMCLK delay] [3/64 MEMCLK delay] [4/64 MEMCLK delay] [5/64 MEMCLK delay]...[46/64 MEMCLK delay] [47/64 MEMCLK delay]

**Write Data Timing Control**

Configuration options: [Auto] [No delay] [1/64 MEMCLK delay] [2/64 MEMCLK delay] [3/64 MEMCLK delay] [4/64 MEMCLK delay] [5/64 MEMCLK delay]...[46/64 MEMCLK delay] [47/64 MEMCLK delay]

**DQS Receiver Enable Timing**

Configuration options: [Auto] [0 ps] [50 ps] [100 ps] [150 ps] [200 ps] [250 ps] [300 ps] [350 ps] [400 ps]...[8550 ps] [8600 ps] [8650 ps] [8700 ps]

***Output Driver Control*****CKE Drive Strength**

Configuration options: [Auto] [1.00x] [1.25x] [1.50x] [2.00x]

**CS/ODT Drive Strength**

Configuration options: [Auto] [1.00x] [1.25x] [1.50x] [2.00x]

**Add/CMD Drive Strength**

Configuration options: [Auto] [1.00x] [1.25x] [1.50x] [2.00x]

**MEMCLK Drive Strength**

Configuration options: [Auto] [0.75x] [1.00x] [1.25x] [1.50x]

**Data Drive Strength**

Configuration options: [Auto] [0.75x] [1.00x] [1.25x] [1.50x]

**DQS Drive Strength**

Configuration options: [Auto] [0.75x] [1.00x] [1.25x] [1.50x]

**DRAM Drivers Weak Mode**

Configuration options: [Auto] [Normal] [Weak]

**SLI Ready Memory [Disabled]**

Allows you to select the SPD profile for SLI-Ready memory modules. The configuration options may vary depending on the type of module you installed.

Configuration options: [Disabled] [Optimal] [High Frequency] [High Performance]

**AMD Cool 'n' Quiet Function [Enabled]**

Enables or disables the AMD Cool 'n' Quiet technology.

Configuration options: [Disabled] [Enabled]

## 4.4.5 Chipset

Phoenix-Award BIOS CMOS Setup Utility		
Advanced		
Chipset		Select Menu
LinkBoost Function	[Disabled]	Item Specific Help▶▶▶
NB to SB HT Frequency	[Auto]	
CPU<->NB HT Speed	[Auto]	
NB-->SB HT Speed	[5xNB to SB HT Frequency]	
SB-->NB HT Speed	[5xSB to NB HT Frequency]	
CPU<->NB HT Width	[↓16 ↑16]	
NB<->SB HT Width	[↓16 ↑16]	
F1: Help      ↑↓ : Select Item      -/+ : Change Value      F5: Setup Defaults ESC: Exit      →← : Select Menu      Enter: Select Sub-menu      F10: Save and Exit		

### LinkBoost Function [Disabled]

When you install 7900GTX or 7950 GX2 graphics card, this model will auto overclock to get a better performance.

### NB to SB HT Frequency [Auto]

Allows you to set the Northbridge to Southbridge HT frequency.  
Configuration options: [200.0] ~ [400.0]

### CPU<->NB HT Speed [Auto]

Allows you to set the CPU to Northbridge HT Speed.  
Configuration options: [1xCPU Frequency] [2xCPU Frequency] [3xCPU Frequency] [5xCPU Frequency] [5xCPU Frequency]

### NB-->SB HT Speed [5xNB to SB HT Frequency]

Allows you to set the Northbridge to Southbridge HT Speed.  
Configuration options: [1xNB to SB HT Frequency] [2xNB to SB HT Frequency] [3xNB to SB HT Frequency] [4xNB to SB HT Frequency] [5xNB to SB HT Frequency]

### SB-->NB HT Speed [5xSB to NB HT Frequency]

Allows you to set the Southbridge to Northbridge HT Speed.  
Configuration options: [1xNB to SB HT Frequency] [2xNB to SB HT Frequency] [3xNB to SB HT Frequency] [4xNB to SB HT Frequency] [5xNB to SB HT Frequency]

### CPU<->NB HT Width [↓16 ↑16]

Allows you to set the CPU to Northbridge HT width.  
Configuration options: [↓8 ↑8] [↓16 ↑16]

### NB<->SB HT Width [↓16 ↑16]

Allows you to set the Northbridge to Southbridge HT width.  
Configuration options: [↓4 ↑4] [↓8 ↑8] [↓16 ↑16]

## 4.4.6 PCIPnP

Phoenix-Award BIOS CMOS Setup Utility		
Advanced		
PCIPnP		Select Menu
Plug & Play O/S	[No]	Item Specific Help▶▶
Resources Controlled By	[Auto]	Select Yes if you are using a Plug and Play capable operating system. Select No if you need the BIOS to configure non-boot devices.
x IRQ Resources		

### Plug & Play O/S [No]

When set to [No], the BIOS configures all the devices in the system. When set to [Yes] and if you install a Plug and Play operating system, the operating system configures the Plug and Play devices not required for boot. Configuration options: [No] [Yes]

### Resources Controlled By [Auto]

When set to [Auto], the BIOS automatically configures all the boot and Plug and Play compatible devices. Set to [Manual] if you want to assign the IRQ DMA and memory base address fields. Configuration options: [Auto] [Manual]



The item **IRQ Resources** becomes user-configurable when you set **Resources Controlled By** to [Manual].

## IRQ Resources

Phoenix-Award BIOS CMOS Setup Utility		
Advanced		
IRQ Resources		Select Menu
IRQ-5 assigned to	[PCI Device]	Item Specific Help▶▶▶
IRQ-7 assigned to	[PCI Device]	Legacy ISA for devices compliant with the original PC AT bus specification, PCI/ISA PnP for devices compliant with the Plug and Play standard whether designed for PCI or ISA bus architecture.
IRQ-9 assigned to	[PCI Device]	
IRQ-10 assigned to	[PCI Device]	
IRQ-11 assigned to	[PCI Device]	
IRQ-14 assigned to	[PCI Device]	
IRQ-15 assigned to	[PCI Device]	

### IRQ-xx assigned to

When set to [PCI Device], the specific IRQ is free for use of PCI/PnP devices. When set to [Reserved], the IRQ is reserved for legacy ISA devices. Configuration options: [PCI Device] [Reserved]

## 4.4.7 Onboard Device Configuration

Phoenix-Award BIOS CMOS Setup Utility	
Advanced	
Onboard Device Configuration	Select Menu
<ul style="list-style-type: none"> <li>▶ IDE Function Setup</li> <li>▶ Serial-ATA Configuration</li> <li>▶ USB Configuration</li> <li>Onboard i394 Controller [Enabled]</li> <li>Onboard 1st nVidia LAN [Enabled]</li> <li>Onboard 2nd nVidia LAN [Enabled]</li> <li>Onboard nVidia LAN Boot ROM [Disabled]</li> <li>Primary Display Adapter [PCI-E slot]</li> <li>HD Audio [Auto]</li> <li>Front Panel Support Type [AC97]</li> <li>Silicon SATAII Controller [SATA Mode]</li> <li>Serial Port1 Address [3F8/IRQ4]</li> <li>Parallel Port Address [378/IRQ7]</li> <li>Parallel Port Mode [EPP]</li> <li>x ECP Mode Use DMA [3]</li> </ul>	Item Specific Help▶▶  Press [Enter] to set
F1: Help    ↑↓ : Select Item    -/+ : Change Value    F5: Setup Defaults ESC: Exit    →← : Select Menu    Enter: Select Sub-menu    F10: Save and Exit	

### IDE Function Setup

This sub-menu contains IDE function-related items. Select an item then press <Enter> to edit.

Phoenix-Award BIOS CMOS Setup Utility	
Advanced	
IDE Function Setup	Select Menu
OnChip IDE Channel0 [Enabled] IDE DMA transfer access [Enabled] IDE Prefetch Mode [Enabled]	Item Specific Help▶▶▶

#### OnChip IDE Channel0 [Enabled]

Allows you to enable or disable the onchip IDE channel 0 controller .  
 Configuration options: [Disabled] [Enabled]

#### IDE DMA transfer access [Enabled]

Allows you to enable or disable the IDE DMA transfer access.  
 Configuration options: [Disabled] [Enabled]

#### IDE Prefetch Mode [Enabled]

Allows you to enable or disable the IDE PIO read prefetch mode.  
 Configuration options: [Disabled] [Enabled]

## Serial-ATA Configuration

This sub-menu allows you to change Serial ATA settings. Select an item then press <Enter> to edit.

Phoenix-Award BIOS CMOS Setup Utility			
Advanced			
Serial-ATA Configuration			Select Menu
Serial-ATA Controller		[Enabled]	Item Specific Help▶▶▶
RAID Enabled		[Disabled]	
x SATA 1	RAID	Disabled	
x SATA 2	RAID	Disabled	
x SATA 3	RAID	Disabled	
x SATA 4	RAID	Disabled	
x SATA 5	RAID	Disabled	
x SATA 6	RAID	Disabled	

### Serial-ATA Controller [Enabled]

Configuration options: [Disabled] [Enabled]

### RAID Enabled [Disabled]

Enables or disables the onboard RAID controller. When set to [Enabled], the succeeding items become user-configurable.

Configuration options: [Disabled] [Enabled]

### SATA1~6 RAID [Disabled]

Enables or disables the RAID function of the SATA 1~6 drive.

Configuration options: [Disabled] [Enabled]

## USB Configuration

The items in this menu allows you to change the USB-related features. Select an item then press <Enter> to display the configuration options.

Phoenix-Award BIOS CMOS Setup Utility			
Advanced			
USB Configuration			Select Menu
USB Controller		[Enabled]	Item Specific Help▶▶▶
USB2.0 Controller		[Enabled]	
USB Legacy support		[Enabled]	
			Enable or Disable the USB Controller.

### USB Controller [Enabled]

Allows you to enable or disable the onchip USB controller.

Configuration options: [Disabled] [Enabled]

### USB 2.0 Controller [Enabled]

Allows you to enable or disable the USB 2.0 controller.

Configuration options: [Disabled] [Enabled]

### USB Legacy Support [Enabled]

Allows you to enable or disable support for USB devices on legacy operating systems (OS). Configuration options: [Disabled] [Enabled]



### **Onboard 1394 Controller [Enabled]**

Allows you to disable or enable the onboard 1394 device support.  
Configuration options: [Disabled] [Enabled]

### **Onboard 1st/2nd nVidia LAN [Enabled]**

Enables or disables the onboard NVIDIA® LAN controller.  
Configuration options: [Disabled] [Enabled]

### **OnBoard LAN Boot ROM [Disabled]**

Allows you to enable or disable the onboard LAN boot ROM.  
Configuration options: [Enabled] [Disabled]

### **Primary Display Adapter [PCI-E Slot]**

Allows you to select the graphics controller to use as the primary boot device.  
Configuration options: [PCI Slot] [PCI-E slot]

### **HD Audio [Auto]**

Allows you to disable or set the High-Definition audio function.  
Configuration options: [Auto] [Disabled]

### **Front Panel Support Type [AC97]**

Allows you to set the front panel audio connector (AAFP) mode to legacy AC'97 or high-definition audio depending on the audio standard that the front panel audio module supports.  
Configuration options: [AC97] [HD Audio]

### **Silicon SATAII Controller [SATA Mode]**

Allows you to disable or set the function of the extended SATA II controller.  
Configuration options: [Disabled] [SATA Mode] [RAID Mode]

### **Serial Port1 Address [3F8/IRQ4]**

Allows you to select the Serial Port1 base address.  
Configuration options: [Disabled] [3F8/IRQ4] [2F8/IRQ3] [3E8/IRQ4] [2E8/IRQ3] [Auto]

### **Parallel Port Address [378/IRQ7]**

Allows you to select the Parallel Port address.  
Configuration options: [Disabled] [378/IRQ7] [278/IRQ5] [3BC/IRQ7]

## Parallel Port Mode [EPP]

Allows you to select the Parallel Port mode.  
Configuration options: [Normal] [EPP] [ECP] [Bi-Directional]



The “ECP Mode Use DMA” item becomes user-configurable when the “ Parallel Port Mode” item is set to [ECP] or [Bi-Directional]

## ECP Mode Use DMA [3]

Allows selection of ECP Mode. Configuration options: [1] [3]

# 4.5 Power menu

The Power menu items allow you to change the settings for the Advanced Configuration and Power Interface (ACPI) and the Advanced Power Management (APM). Select an item then press <Enter> to display the configuration options.

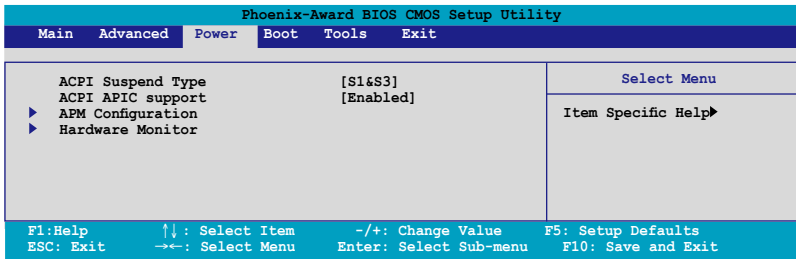

### 4.5.1 ACPI Suspend Type [S1&S3]

Allows you to select the Advanced Configuration and Power Interface (ACPI) state to be used for system suspend. Configuration options: [S1 (POS)] [S3 (STR)] [S1&S3]

### 4.5.2 ACPI APIC Support [Enabled]

Allows you to enable or disable the Advanced Configuration and Power Interface (ACPI) support in the Advanced Programmable Interrupt Controller (APIC). When set to Enabled, the ACPI APIC table pointer is included in the RSDT pointer list. Configuration options: [Disabled] [Enabled]

## 4.5.3 APM Configuration

Phoenix-Award BIOS CMOS Setup Utility		
Power		
APM Configuration		Select Menu
Restore on AC Power Loss	[Power-Off]	Item Specific Help▶▶  Press [Enter] to select whether or not to restart the system after AC power loss.
PWR Button < 4 secs	[Instant-Off]	
Power On By PCI/PCIE Devices	[Disabled]	
Power On By External Modems	[Disabled]	
Power On by RTC Alarm	[Disabled]	
* Date (of Month) Alarm	0	
* Time (hh:mm:ss) Alarm	0 : 0 : 0	
Power Up By PS/2 Mouse	[Disabled]	
Power Up By PS/2 Keyboard	[Disabled]	
F1: Help    ↑↓ : Select Item    -/+ : Change Value    F5: Setup Defaults		
ESC: Exit    →← : Select Menu    Enter: Select SubMenu    F10: Save and Exit		

### Restore on AC Power Loss [Power-Off]

Allows you to enable or disable the Restore on AC Power Loss function.

Configuration options: [Power-On] [Power-Off]

### PWR Button < 4 secs [Instant-Off]

Allows you to set the event after the power button is pressed for more than 4 seconds. Configuration options: [Suspend] [Instant-Off]

### Power On By PCI/PCIE Devices [Disabled]

Allows you to enable or disable the PME to wake up from S5 by PCI/PCIE devices & NV Onboard LAN. Configuration options: [Disabled] [Enabled]

### Power On By External Modems [Disabled]

This allows either settings of [Enabled] or [Disabled] for powering up the computer when the external modem receives a call while the computer is in Soft-off mode.

Configuration options: [Disabled] [Enabled]



---

The computer cannot receive or transmit data until the computer and applications are fully running. Thus, connection cannot be made on the first try. Turning an external modem off and then back on while the computer is off causes an initialization string that turns the system power on.

---

## **Power On By RTC Alarm [Disabled]**

Allows you to enable or disable RTC to generate a wake event. When this item is set to Enabled, the items Date of Month Alarm and Time (hh:mm:ss) Alarm items become user-configurable with set values.

Configuration options: [Disabled] [Enabled]

## **Date (of Month) Alarm [31]**

To set the date of alarm, highlight this item and press <Enter> to display the Date of Month Alarm pop-up menu. Key-in a value within the specified range then press <Enter>. Configuration options: [Min=0] [Max=31]

## **Alarm Time (hh:mm:ss) [Disabled]**

To set the time of alarm:

1. Highlight this item and press <Enter> to display a pop-up menu for the hour field.
2. Key-in a value (Min=0, Max=23), then press <Enter>.
3. Press <TAB> to move to the minutes field then press <Enter>.
4. Key-in a minute value (Min=0, Max=59), then press <Enter>.
5. Press <TAB> to move to the seconds field then press <Enter>.
6. Key-in a value (Min=0, Max=59), then press <Enter>.

## **Power On By PS/2 Mouse [Disabled]**

When set to [Enabled], this parameter allows you to use the PS/2 mouse to turn on the system. This feature requires an ATX power supply that provides at least 1A on the +5VSB lead. Configuration options: [Disabled] [Enabled]

## **Power On By PS/2 Keyboard [Disabled]**

Allows you to disable the Power On by PS/2 keyboard function or set specific keys on the PS/2 keyboard to turn on the system. This feature requires an ATX power supply that provides at least 1A on the +5VSB lead. Configuration options: [Disabled] [Space Bar] [Ctrl-ESC] [Power Key]



---

Enabling ASUS Music Alarm will automatically disable the PS/2 keyboard/power-up feature. See page 5-22 for details.

---

## 4.5.4 Hardware Monitor

The items in this sub-menu displays the hardware monitor values automatically detected by the BIOS. It also allows you to change CPU Q-Fan feature-related parameters. Select an item then press <Enter> to display the configuration options.

Phoenix-Award BIOS CMOS Setup Utility			
Power			
Hardware Monitor		Select Menu	
x	CPU Q-Fan Control	[Disabled]	Item Specific Help▶▶
	CPU Q-Fan Profile	[Performance]	
	Chassis Q-Fan Control	[Disabled]	Press [Enter] to enable or disable.
x	Chassis Q-Fan Profile	[Performance]	
	Vcore Voltage	1.47V	
	3.3V Voltage	3.15V	
	5V Voltage	5.05V	
	12V Voltage	11.58V	
	CPU Temperature	48°C	
	M/B Temperature	41°C	
	CPU FAN Speed	3068 RPM	
	CHA_FAN1 Speed	0 RPM	
	CHA_FAN2 Speed	0 RPM	
	CHA_FAN3 Speed	0 RPM	
	CHA_FAN4 Speed	0 RPM	
	PWR_FAN Speed	0 RPM	
	CHIE_FAN Speed	0 RPM	
	CPU Fan Speed warning	[ 800 RPM]	

F1: Help    ↑↓ : Select Item    -/+ : Change Value    F5: Setup Defaults  
ESC: Exit    →← : Select Menu    Enter: Select SubMenu    F10: Save and Exit

### CPU Q-Fan Control [Disabled]

Allows you to enable or disable the CPU Q-Fan controller.

Configuration options: [Disabled] [Enabled]



The **CPU Q-Fan Profile** items appear when you enable the ASUS Q-Fan Control feature.

### CPU Q-Fan Profile [Performance]

Allows you to set the appropriate performance level of the CPU Q-Fan. When set to [Optimal], the CPU fan automatically adjusts depending on the CPU temperature. Set this item to [Silent] to minimize fan speed for quiet CPU fan operation, or [Performance] to achieve maximum CPU fan speed. Configuration options: [Performance] [Optimal] [Silent]

### Chassis Q-Fan Control [Disabled]

Allows you to enable or disable the chassis Q-Fan controller.

Configuration options: [Disabled] [Enabled]



---

The succeeding item becomes user-configurable when you set the **Chassis Q-Fan Control** item to [Enabled].

---

### **Chassis Q-Fan Profile [Performance]**

Allows you to set the appropriate performance level of the chassis Q-Fan. When set to [Optimal], the chassis fan automatically adjusts depending on the chassis temperature. Set this item to [Silent] to minimize fan speed for quiet chassis fan operation, or [Performance] to achieve maximum chassis fan speed. Configuration options: [Performance] [Optimal] [Silent]

### **Vcore Voltage, 3.3V Voltage, 5V Voltage, 12V Voltage**

The onboard hardware monitor automatically detects the voltage output through the onboard voltage regulators. Select [Ignored] if you do not want to detect this item.

### **CPU Temperature, M/B Temperature**

The onboard hardware monitor automatically detects and displays the motherboard and CPU temperatures. These items are not user-configurable.

### **CPU Fan Speed**

#### **CHA\_FAN1/2/3/4 Speed**

#### **PWR\_FAN Speed**

#### **CHIP\_FAN Speed**

The onboard hardware monitor automatically detects and displays the CPU, Chassis, power, and Southbridge chip fan speeds in rotations per minute (RPM). If any of the fans is not connected to the motherboard, the field shows 0. These items are not user-configurable.

### **CPU Fan Speed warning [ 800 RPM]**

Allows you to disable or set the CPU fan warning speed.

Configuration options: [Disabled] [800 RPM] [1200 RPM] [1600 RPM]

## 4.6 Boot menu

The Boot menu items allow you to change the system boot options. Select an item then press <Enter> to display the sub-menu.

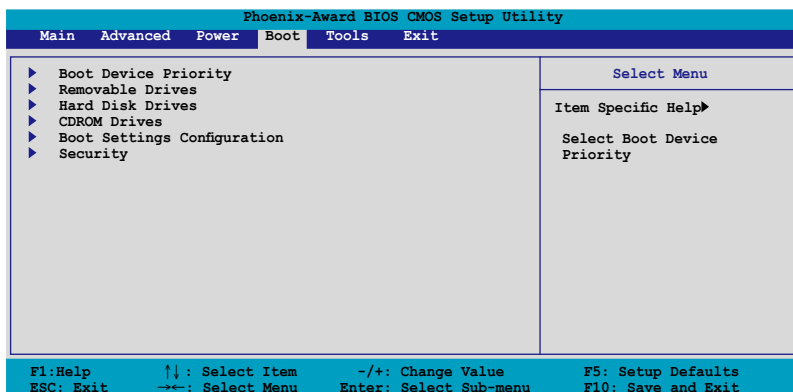

### 4.6.1 Boot Device Priority

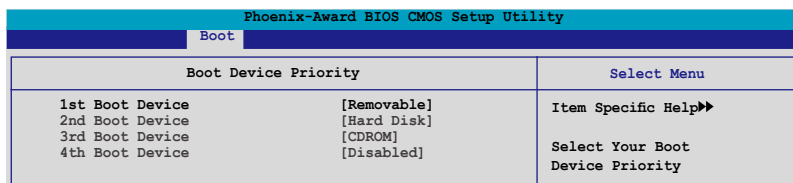

#### 1st ~ 4th Boot Device [Removable]

These items specify the boot device priority sequence from the available devices. The number of device items that appears on the screen depends on the number of devices installed in the system. Configuration options: [Removable] [Hard Disk] [CDROM] [Disabled]

## 4.6.2 Removable Drives

Phoenix-Award BIOS CMOS Setup Utility	
Boot	
Removable Drives	Select Menu
1. Floppy Disks	Item Specific Help▶▶

### 1. Floppy Disks

Allows you to assign a removable drive attached to the system.

## 4.6.3 Hard Disk Drives

Phoenix-Award BIOS CMOS Setup Utility	
Boot	
Hard Disk Drives	Select Menu
1. 1st Master: XXXXXXXXXX	Item Specific Help▶▶

### 1. 1st Master: XXXXXXXXXX

Allows you to assign hard disk drives attached to the system.

## 4.6.4 CDROM Drives

Phoenix-Award BIOS CMOS Setup Utility	
Boot	
CDROM Drives	Select Menu
1. 1st Slave: XXXXXXXXXX	Item Specific Help▶▶

### 1. 1st Slave: XXXXXXXXXX

Allows you to assign optical drives attached to the system.



## 4.6.5 Boot Settings Configuration

Phoenix-Award BIOS CMOS Setup Utility		
Boot		
Boot Settings Configuration		Select Menu
Case Open Warning	[Enabled]	Item Specific Help▶▶  Press [Enter] to enable or disable.
Quick Boot	[Enabled]	
Boot Up Floppy Seek	[Disabled]	
Bootup Num-Lock	[On]	
Typematic Rate Setting	[Disabled]	
x Typematic Rate (Chars/Sec)	6	
x Typematic Delay (Msec)	250	
OS Select For DRAM > 64MB	[Non-OS2]	
Full Screen LOGO	[Enabled]	
Halt On	[All Errors]	

F1: Help      ↑↓: Select Item      -/+ : Change Value      F5: Setup Defaults  
ESC: Exit      →←: Select Menu      Enter: Select Sub-menu      F10: Save and Exit

### Case Open Warning [Enabled]

Enables or disables the chassis open status feature. Setting to Enabled, clears the chassis open status. Refer to section “2.7.2 Internal connectors” for setting details. Configuration options: [Disabled] [Enabled]

### Quick Boot [Enabled]

Allows you to enable or disable the system quick boot feature. When Enabled, the system skips certain tests while booting. Configuration options: [Disabled] [Enabled]

### Boot Up Floppy Seek [Disabled]

Enables or disables the chassis open status feature. Setting to Enabled, clears the chassis open status. Configuration options: [Disabled] [Enabled]

### Bootup Num-Lock [On]

Allows you to select the power-on state for the NumLock. Configuration options: [Off] [On]

### Typematic Rate Setting [Disabled]

Allows you to set the keystroke rate. Enable this item to configure the Typematic Rate (Chars/Sec) and the Typematic Delay (Msec). Configuration options: [Disabled] [Enabled]



The items **Typematic Rate (Chars/Sec)** and **Typematic Delay (Msec)** become user-configurable only when the item **Typematic Rate Setting** is enabled.

### Typematic Rate (Chars/Sec) [6]

Allows you to select the rate at which a character repeats when you hold a key. Configuration options: [6] [8] [10] [12] [15] [20] [24] [30]

### Typematic Delay (Msec) [250]

Allows you to set the delay before keystrokes begin to repeat. Configuration options: [250] [500] [750] [1000]

### OS Select for DRAM > 64MB [Non-OS2]

Set this item to OS2 only when you are running on an OS/2 operating system with an installed RAM of greater than 64 KB. Configuration options: [Non-OS2] [OS2]

### Full Screen LOGO [Enabled]

Allows you to enable or disable the full screen logo display feature. Configuration options: [Disabled] [Enabled]



Make sure that the above item is set to [Enabled] if you want to use the ASUS MyLogo3™ feature.

### Halt On [All Errors]

Allows you to error report type. Configuration options: [All Errors] [No Errors] [All, But Keyboard] [All, But Diskette] [All, But Disk/Key]

## 4.6.6 Security

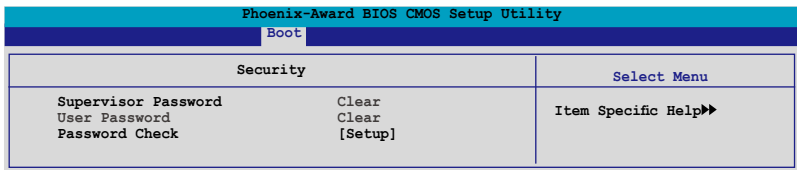

### Supervisor Password

### User Password

These fields allow you to set passwords:

To set a password:

1. Select an item then press <Enter>.
2. Type in a password using a combination of a maximum of eight (8) alphanumeric characters, then press <Enter>.

3. When prompted, confirm the password by typing the exact characters again, then press <Enter>. The password field setting is changed to Set.

To clear the password:

1. Select the password field and press <Enter> twice. The following message appears:



2. Press any key to continue. The password field setting is changed to Clear.

### **A note about passwords**

The Supervisor password is required to enter the BIOS Setup program preventing unauthorized access. The User password is required to boot the system preventing unauthorized use.

Forgot your password?

If you forget your password, you can clear it by erasing the CMOS Real Time Clock (RTC) RAM. The RAM data containing the password information is powered by the onboard button cell battery. If you need to erase the CMOS RAM, refer to section “2.6 Jumper” for instructions.

### **Password Check**

This field requires you to enter the password before entering the BIOS setup or the system. Select [Setup] to require the password before entering the BIOS Setup. Select [System] to require the password before entering the system. Configuration options: [Setup] [System]

## 4.7 Tools menu

The Tools menu items allow you to configure options for special functions. Select an item then press <Enter> to display the sub-menu.

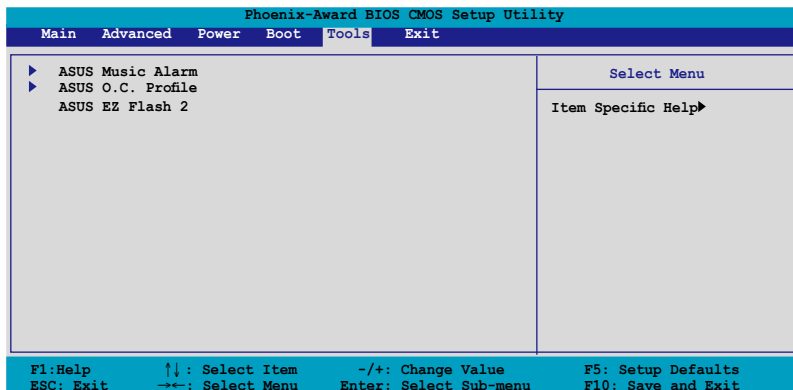

### 4.7.1 ASUS Music Alarm

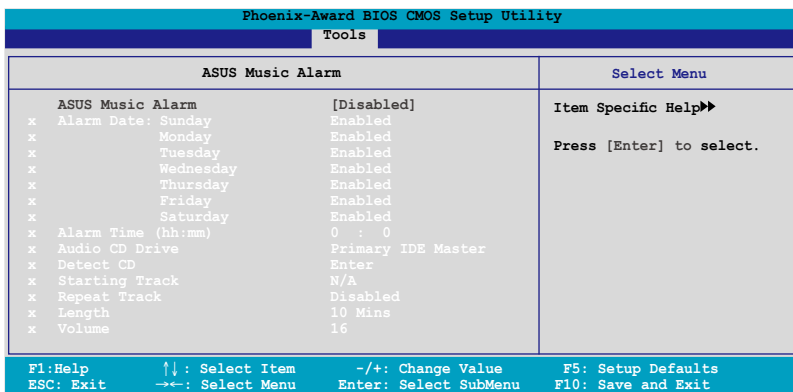

#### ASUS Music Alarm [Disabled]

Allows you to enable or disable the ASUS Music Alarm function.

Configuration options: [Disabled] [Enabled]



The succeeding items become user-configurable when you enable the ASUS Music Alarm.

## **Alarm Day: Sunday/Monday/Tuesday/Wednesday/Thursday/Friday/Saturday [Enabled]**

Allows you to enable or disable the alarm for a particular day.  
Configuration options: [Disabled] [Enabled]

## **Alarm Time (hh:mm) 0 : 0**

Allows you to set the alarm time. Press <Tab> to select the field, then use <+> or <-> to change the value.

## **Audio CD Drive [Primary IDE Master]**

Allows you to select the connection configuration of the optical storage device from which the alarm music will play from. Configuration options: [Primary IDE Master] [Primary IDE Slave]

## **Detect CD**

Press <Enter> to search the CD track number.

## **Starting Track**

Allows you to choose the starting track from the CD from which you would like the alarm music to play.

## **Repeat Track [Disabled]**

Allows you to enable or disable the repeat track function.  
Configuration options: [Disabled] [Single] [All]

## **Duration [10 Mins]**

Allows you to set the length of the music alarm.  
Configuration options: [10 Mins] [20 Mins] [30 Mins] [1 Hour]

## **Volume [16]**

Allows you to set the volume level of the music alarm.  
Configuration options: [01] ~ [32]



- 
- Only the IDE ATAPI devices from South bridge can support this function.
  - The system needs standby power, so ensure that the power cord is plugged.
  - You can also set the alarm time under operating system using ASUS Music Alarm Utility. See section 5.3.6 for details.
  - ASUS Music Alarm only supports audio CDs.
-

## 4.7.2 ASUS O.C. Profile

This item allows you to store or load multiple BIOS settings.

Phoenix-Award BIOS CMOS Setup Utility	
Tools	
ASUS O.C. Profile	Select Menu
▶ Load BIOS Profile ▶ Save BIOS Profile	Item Specific Help▶▶  Press [Enter] to select.

### Load BIOS Profile

Phoenix-Award BIOS CMOS Setup Utility	
Tools	
Load BIOS Profile	Select Menu
Load from Profile 1 Load from Profile 2 Load from File	Item Specific Help▶▶  Load BIOS Profile from Profile 1.

### Load from Profile 1/2

Allows you to load the previous BIOS settings saved in the BIOS Flash. Press <Enter> to load the file.

### Load from File

Allows you to load the previous BIOS file saved in the hard disk/floppy disk/USB flash disk with the FAT32/16/12 format. Follow the instructions below to load the BIOS file.

1. Insert the storage devices that contains the “xxx.CMO” file.
2. Turn on the system.
3. Enter BIOS setup program. Go to the “Tools” menu to select “Load from File.” Press <Enter> then the setup screen will appear.
4. Press <Tab> to switch between drives before the correct “xxx.CMO” file is found. Then press <Enter> to load the file.
5. A pop-up message will inform you when the loading process finishes.



- Suggest only to update the BIOS file coming from the same memory/CPU configuration and BIOS version.
- Only the “xxx.CMO” file can be loaded.

Phoenix-Award BIOS CMOS Setup Utility	
Tools	
Load BIOS Profile	Select Menu
Load from Profile 1 Load from Profile 2 Load from File	Item Specific Help▶▶  Load BIOS Profile from Profile 1.

## Save BIOS Profile

Phoenix-Award BIOS CMOS Setup Utility	
Tools	
<b>Save BIOS Profile</b>	<b>Select Menu</b>
Save to Profile 1 Save to Profile 2 Save to File	Item 0 Help▶▶  Save current BIOS Profile to Profile 1.

### Save to Profile 1/2

Allows you to save the current BIOS file to the BIOS Flash. Press <Enter> to save the file.

### Save to File

Allows you to save the current BIOS file to the hard disk/floppy disk/USB flash disk with FAT32/16/12 format. Follow the instructions below to save the BIOS file.

1. Insert the storage devices with enough space.
2. Turn on the system.
3. Enter the BIOS setup program. Go to the “Tool” menu to select “Save to File.” Press <Enter> then the setup screen will appear.
4. Press <Tab> to switch between the drives. Press hot-key <S> to save the file.
5. Key in the file name. Then press <Enter>.
6. A pop-up message will inform you when the saving process finishes.

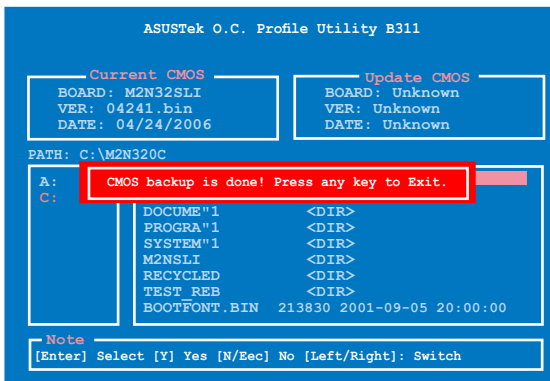

The BIOS file will be saved as “xxx.CMO”.

### 4.7.3 ASUS EZ Flash 2

Allows you to run ASUS EZ Flash 2. When you press <Enter>, a confirmation message appears. Use the left/right arrow key to select between [Yes] or [No], then press <Enter> to confirm your choice. Please see page 4-5, section 4.1.3 for details.

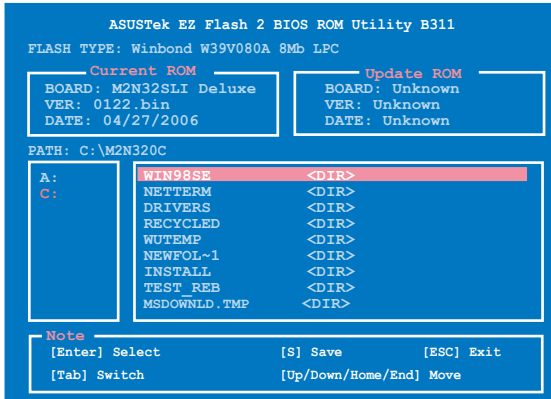



## 4.8 Exit menu

The Exit menu items allow you to load the optimal or failsafe default values for the BIOS items, and save or discard your changes to the BIOS items.

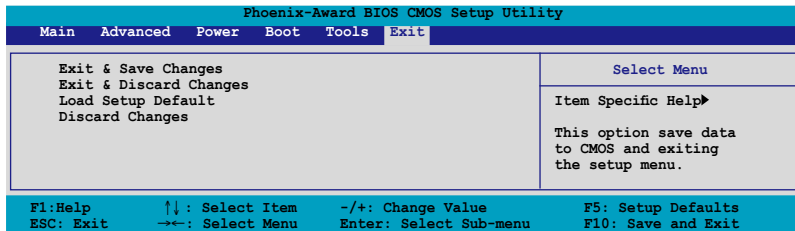

Pressing <Esc> does not immediately exit this menu. Select one of the options from this menu or <F10> from the legend bar to exit.

### Exit & Save Changes

Once you are finished making your selections, choose this option from the Exit menu to ensure the values you selected are saved to the CMOS RAM. An onboard backup battery sustains the CMOS RAM so it stays on even when the PC is turned off. When you select this option, a confirmation window appears. Select YES to save changes and exit.



If you attempt to exit the Setup program without saving your changes, the program prompts you with a message asking if you want to save your changes before exiting. Press <Enter> to save the changes while exiting.

### Exit & Discard Changes

Select this option only if you do not want to save the changes that you made to the Setup program. If you made changes to fields other than System Date, System Time, and Password, the BIOS asks for a confirmation before exiting.

### Load Setup Defaults

This option allows you to load the default values for each of the parameters on the Setup menus. When you select this option or if you press <F5>, a confirmation window appears. Select YES to load default values. Select Exit & Save Changes or make other changes before saving the values to the non-volatile RAM.

### Discard Changes

This option allows you to discard the selections you made and restore the previously saved values. After selecting this option, a confirmation appears. Select YES to discard any changes and load the previously saved values.

---

---

---

---

---

---

---

---

---

---

---

---

---

---

---

---

---

---

---

---

---

---

---

---

---

---

This chapter describes the contents of the support CD that comes with the motherboard package.

# 5 Software support

5.1	Installing an operating system .....	5-1
5.2	Support CD information .....	5-1
5.3	Software informtion .....	5-8
5.4	RAID configurations .....	5-30

## 5.1 Installing an operating system

This motherboard supports Windows® 2000/2003 Server/XP/64-bit XP operating systems (OS). Always install the latest OS version and corresponding updates to maximize the features of your hardware.



- Motherboard settings and hardware options vary. Use the setup procedures presented in this chapter for reference only. Refer to your OS documentation for detailed information.
- Make sure that you install Windows® 2000 Service Pack 4 or the Windows® XP Service Pack 2 or later versions before installing the drivers for better compatibility and system stability.

## 5.2 Support CD information

The support CD that came with the motherboard package contains the drivers, software applications, and utilities that you can install to avail all motherboard features.



The contents of the support CD are subject to change at any time without notice. Visit the ASUS website([www.asus.com](http://www.asus.com)) for updates.

### 5.2.1 Running the support CD

Place the support CD to the optical drive. The CD automatically displays the Drivers menu if Autorun is enabled in your computer.

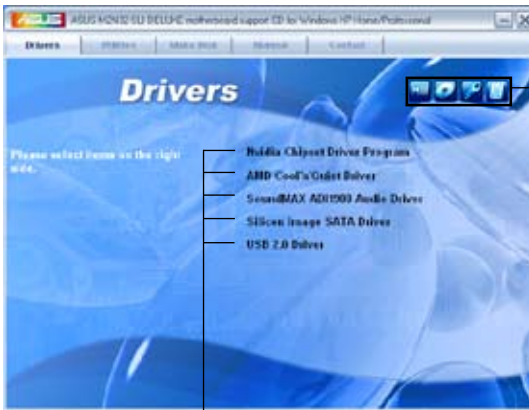

Click an icon to display support CD/motherboard information

Click an item to install



If Autorun is NOT enabled in your computer, browse the contents of the support CD to locate the file ASSETUP.EXE from the BIN folder. Double-click the ASSETUP.EXE to run the CD.

## 5.2.2 Drivers menu

The drivers menu shows the available device drivers if the system detects installed devices. Install the necessary drivers to activate the devices.



### **Nvidia Chipset Driver Program**

Installs the NVIDIA® Chipset drivers for the NVIDIA® nForce™ 590 SLI chipset.

### **AMD Cool 'n' Quiet Driver**

Installs the AMD Cool 'n' Quiet™ technology driver.

### **SoundMAX ADI1988 Audio Driver**

Installs the SoundMAX® ADI1988 audio driver and application.

### **Silicon Image SATA Driver**

Installs the Silicon Image® Serial ATA RAID driver.

### **USB 2.0 Driver**

Installs the Universal Serial Bus 2.0 (USB 2.0) driver.

## 5.2.3 Utilities menu

The Utilities menu shows the applications and other software that the motherboard supports.



### **ASUS Cool 'n' Quiet Utility**

Installs the AMD Cool 'n' Quiet™ software.

### **ASUS PC Probe II**

This smart utility monitors the fan speed, CPU temperature, and system voltages, and alerts you of any detected problems. This utility helps you keep your computer in healthy operating condition.

### **ASUS Update**

The ASUS Update utility allows you to update the motherboard BIOS in Windows® environment. This utility requires an Internet connection either through a network or an Internet Service Provider (ISP).

### **ASUS Ai Gear**

### **ASUS Ai Nap**

### **ASUS Ai Music Alarm**

### **Adobe Reader V7.0**

Installs the Adobe® Acrobat® Reader that allows you to open, view, and print documents in Portable Document Format (PDF).

## Microsoft DirectX 9.0c

Installs the Microsoft® DirectX 9.0c driver. The Microsoft DirectX® 9.0c is a multimedia technology that enhances computer graphics and sound. DirectX® improves the multimedia features of your computer so you can enjoy watching TV and movies, capturing videos, or playing games in your computer. Visit the Microsoft website ([www.microsoft.com](http://www.microsoft.com)) for updates.

## ASUS Ai Booster

The ASUS AI Booster application allows you to overclock the CPU speed in Windows® environment.

## Anti-Virus Utility

The anti-virus application scans, identifies, and removes computer viruses. View the online help for detailed information.

### 5.2.4 Make Disk menu

The Make Disk menu contains items to create the NVIDIA® nForce™ 590-SLI or Silicon Image SATA RAID driver disk.

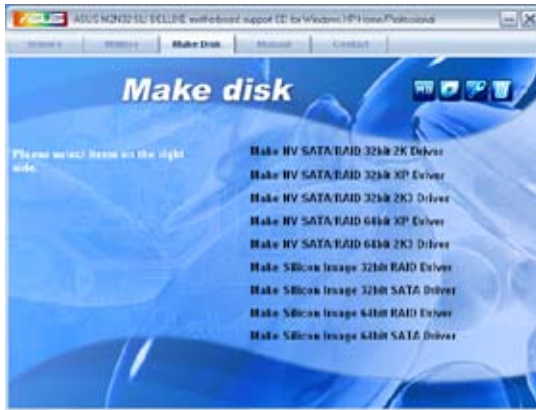

#### Make NV SATA/RAID 32bit 2K Driver

#### Make NV SATA/RAID 32bit XP Driver

#### Make NV SATA/RAID 32bit 2K3 Driver

Allows you to create an NVIDIA® Serial ATA RAID driver disk for a 32-bit 2K/XP/2K3 system.



### **Make NV SATA/RAID 64bit XP Driver**

### **Make NV SATA/RAID 64bit 2K3 Driver**

Allows you to create an NVIDIA® Serial ATA RAID driver disk for a 64-bit XP/2K3 system.

### **Make Silicon Image 32bit RAID Driver**

### **Make Silicon Image 32bit SATA Driver**

Allows you to create a Silicon Image® Serial ATA/RAID driver disk for a 32-bit system.

### **Make Silicon Image 64bit RAID Driver**

### **Make Silicon Image 64bit SATA Driver**

Allows you to create a Silicon Image® Serial ATA/RAID driver disk for a 64-bit system.

## **5.2.5 Manuals menu**

The Manuals menu contains a list of supplementary user manuals. Click an item to open the folder of the user manual.



---

Most user manual files are in Portable Document Format (PDF). Install the Adobe® Acrobat® Reader from the Utilities menu before opening a user manual file.

---



## 5.2.6 ASUS Contact information

Click the Contact tab to display the ASUS contact information. You can also find this information on the inside front cover of this user guide.



## 5.2.7 Other information

The icons on the top right corner of the screen give additional information on the motherboard and the contents of the support CD. Click an icon to display the specified information.

### Motherboard Info

Displays the general specifications of the motherboard.



## Browse this CD

Displays the support CD contents in graphical format.

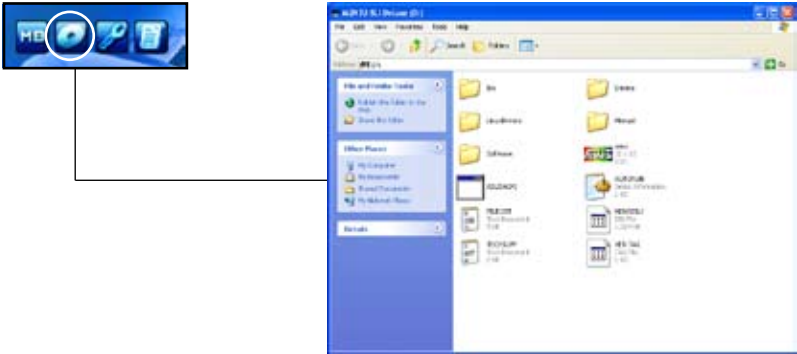

## Technical support Form

Displays the ASUS Technical Support Request Form that you have to fill out when requesting technical support.

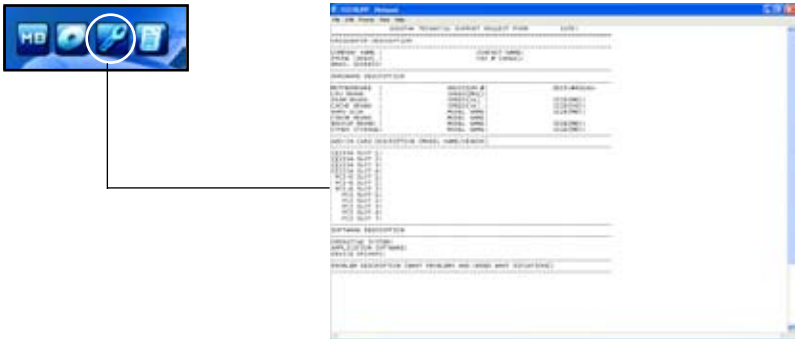

## 5.3 Software information

Most of the applications in the support CD have wizards that will conveniently guide you through the installation. View the online help or readme file that came with the software application for more information.

### 5.3.1 ASUS MyLogo3™

The ASUS MyLogo3™ utility lets you customize the boot logo. The boot logo is the image that appears on screen during the Power-On Self-Tests (POST). The ASUS MyLogo3™ is automatically installed when you install the ASUS Update utility from the support CD. See section “5.2.3 Utilities menu” for details.



- Before using the ASUS MyLogo3™, use the Award BIOS Flash utility to make a copy of your original BIOS file, or obtain the latest BIOS version from the ASUS website. See section “4.1.4 Award utility.”
- Make sure that the BIOS item Full Screen Logo is set to [Enabled] if you wish to use ASUS MyLogo3. See section “4.6.5 Boot Settings Configuration.”
- You can create your own boot logo image in GIF or BMP file formats.
- The file size should be smaller than 150k.

To launch the ASUS MyLogo3™:

1. Launch the ASUS Update utility. Refer to section “4.1.1 ASUS Update utility” for details.
2. Select Options from the drop down menu, then click Next.
3. Check the option Launch MyLogo to replace system boot logo before flashing BIOS, then click Next.
4. Select Update BIOS from a file from the drop down menu, then click Next.
5. When prompted, locate the new BIOS file, then click Next. The ASUS MyLogo3 window appears.
6. From the left window pane, select the folder that contains the image you intend to use as your boot logo.

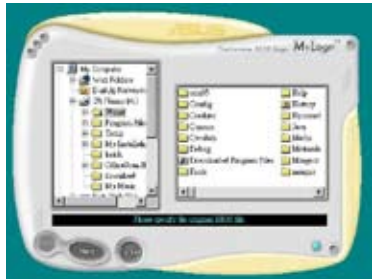

- When the logo images appear on the right window pane, select an image to enlarge by clicking on it.

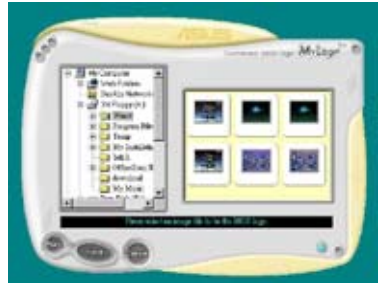

- Adjust the boot image to your desired size by selecting a value on the Ratio box.



- When the screen returns to the ASUS Update utility, flash the original BIOS to load the new boot logo.
- After flashing the BIOS, restart the computer to display the new boot logo during POST.

### 5.3.2 Cool ‘n’ Quiet!™ Technology

The motherboard supports the AMD Cool ‘n’ Quiet!™ Technology that dynamically and automatically change the CPU speed, voltage, and amount of power depending on the task the CPU performs.

#### Enabling Cool ‘n’ Quiet!™ Technology

To enable Cool ‘n’ Quiet!™ Technology:

1. Turn on the system and enter BIOS by pressing the <Del> key during the Power On Self-Tests (POST).
2. Go to Advanced -> CPU Configuration -> AMD K8 Cool ‘n’ Quiet Control and set it to [Enabled]. See section “4.4 Advanced Menu.”
3. In the Power menu, select the item ACPI 2.0 Support and make sure to set it to [Enabled]. See section “4.5 Power Menu.”
4. Save your changes and exit BIOS Setup.
5. Reboot your computer and set your Power Option Properties depending on your operating system.

#### Windows® 2000/XP

1. From the Windows® 2000/XP operating system, click the Start button. Select Settings, then Control Panel.
2. Make sure the Control Panel is set to Classic View.
3. Double-click the Display icon in the Control Panel then select the Screen Saver tab.
4. Click the Power... button. The following dialog box appears.
5. From the Power schemes combo list box, select Minimal Power Management.
6. Click OK to effect settings.



Make sure to install the Cool ‘n’ Quiet!™ driver and application before using this feature.

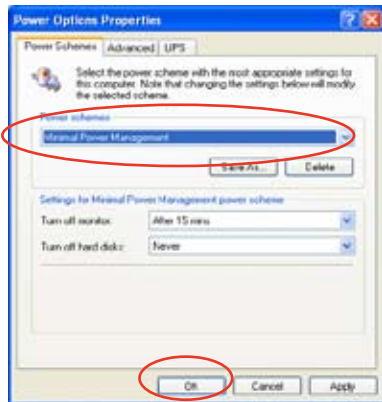

## Windows® 98 SE/Me

1. From the Windows® 98 SE/Me operating system, click the Start button. Select Settings, then Control Panel.
2. Double-click the Display icon in the Control Panel then select the Screen Saver tab.
3. From the Energy saving features of monitor group, click the Settings... button.

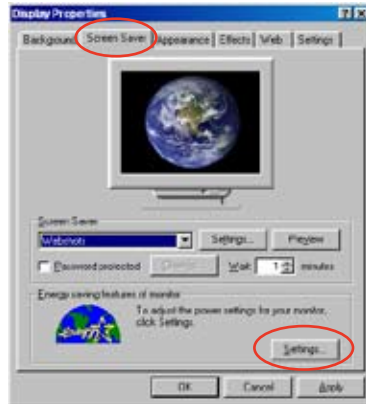

4. From the Power Options Properties dialog box, select the AMD's Cool 'n' Quiet(tm) Technology tab.
5. Click the Performance combo list box to select desired mode. Automatic Mode the recommended setting.
6. Click OK to effect settings.

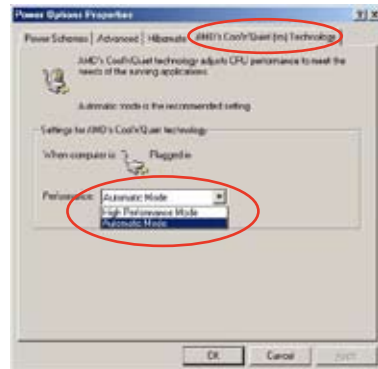

- Make sure to install the AMD Cool 'n' Quiet!™ driver and application before using this feature.
- The AMD Cool 'n' Quiet!™ technology feature works only with the AMD heatsink and fan assembly with monitor chip
- If you purchased a separate heatsink and fan package, use the ASUS Q-Fan technology feature to automatically adjust the CPU fan speed according to your system loading.

## Launching the Cool 'n' Quiet!™ software

The motherboard support CD includes the Cool 'n' Quiet!™ software that enables you to view your system's real-time CPU Frequency and voltage.



Make sure to install the Cool 'n' Quiet!™ software from the motherboard support CD. Refer to section "5.2.3 Utilities menu" for details.

To launch the Cool 'n' Quiet!™ program:

1. If you are using Windows® 98SE/Me/2000, click the Start button. Select Programs-> ASUS -> Cool & Quiet -> Cool & Quiet.
2. If you are using Windows® XP, click the Start button. Select All Programs-> ASUS -> Cool & Quiet -> Cool & Quiet.
3. The Cool 'n' Quiet!™ technology screen appears and displays the current CPU Frequency and CPU Voltage.

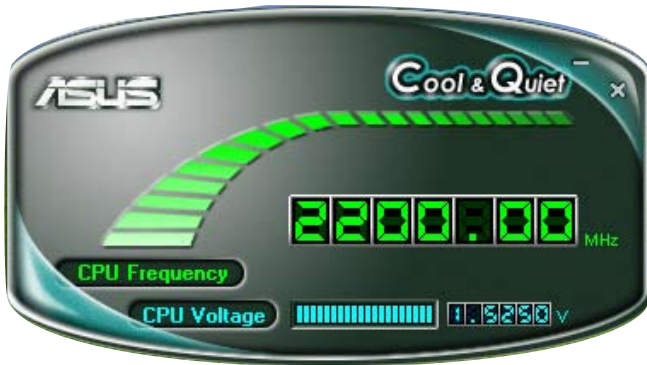



### 5.3.3 ASUS PC Probe II

PC Probe II is a utility that monitors the computer's vital components, and detects and alerts you of any problem with these components. PC Probe II senses fan rotations, CPU temperature, and system voltages, among others. Because PC Probe II is software-based, you can start monitoring your computer the moment you turn it on. With this utility, you are assured that your computer is always at a healthy operating condition.

#### Installing PC Probe II

To install PC Probe II on your computer:

1. Place the support CD to the optical drive. The Drivers installation tab appears if your computer has an enabled Autorun feature.



If Autorun is not enabled in your computer, browse the contents of the support CD to locate the setup.exe file from the ASUS PC Probe II folder. Double-click the setup.exe file to start installation.

2. Click the Utilities tab, then click ASUS PC Probe II.
3. Follow the screen instructions to complete installation.

#### Launching PC Probe II

You can launch the PC Probe II right after installation or anytime from the Windows® desktop.

To launch the PC Probe II from the Windows® desktop, click Start > All Programs > ASUS > PC Probe II > PC Probe II v1.00.43. The PC Probe II main window appears.

After launching the application, the PC Probe II icon appears in the Windows® taskbar. Click this icon to close or restore the application.









#### Using PC Probe II

##### Main window

The PC Probe II main window allows you to view the current status of your system and change the utility configuration. By default, the main window displays the Preference section. You can close or restore the Preference section by clicking on the triangle on the main window right handle.



Click to close the Preference panel

Button	Function
	Opens the Configuration window
	Opens the Report window
	Opens the Desktop Management Interface window
	Opens the Peripheral Component Interconnect window
	Opens the Windows Management Instrumentation window
	Opens the hard disk drive, memory, CPU usage window
	Shows/Hides the Preference section
	Minimizes the application
	Closes the application

### Sensor alert

When a system sensor detects a problem, the main window right handle turns red, as the illustrations below show.



When displayed, the monitor panel for that sensor also turns red. Refer to the Monitor panels section for details.

### Preferences

You can customize the application using the Preference section in the main window. Click the box before each preference to activate or deactivate.

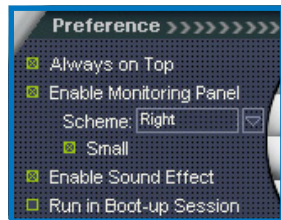

## Hardware monitor panels

The hardware monitor panels display the current value of a system sensor such as fan rotation, CPU temperature, and voltages.

The hardware monitor panels come in two display modes: hexagonal (large) and rectangular (small). When you check the Enable Monitoring Panel option from the Preference section, the monitor panels appear on your computer's desktop.



Large display



Small display

### Changing the monitor panels position

To change the position of the monitor panels in the desktop, click the arrow down button of the Scheme options, then select another position from the list box. Click OK when finished.



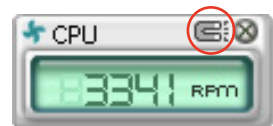

### Moving the monitor panels

All monitor panels move together using a magnetic effect. If you want to detach a monitor panel from the group, click the horseshoe magnet icon. You can now move or reposition the panel independently.



### Adjusting the sensor threshold value

You can adjust the sensor threshold value in the monitor panel by clicking the  or  buttons. You can also adjust the threshold values using the Config window.

You cannot adjust the sensor threshold values in a small monitoring panel.

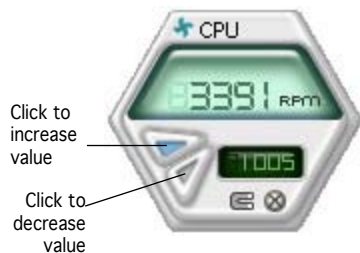

### Monitoring sensor alert

The monitor panel turns red when a component value exceeds or is lower than the threshold value. Refer to the illustrations below.



Large display



Small display

### WMI browser

Click **WMI** to display the WMI (Windows Management Instrumentation) browser. This browser displays various Windows® management information. Click an item from the left panel to display on the right panel. Click the plus sign (+) before WMI Information to display the available information.



You can enlarge or reduce the browser size by dragging the bottom right corner of the browser.

### DMI browser

Click **DMI** to display the DMI (Desktop Management Interface) browser. This browser displays various desktop and system information. Click the plus sign (+) before DMI Information to display the available information.



## PCI browser

Click **PCI** to display the PCI (Peripheral Component Interconnect) browser. This browser provides information on the PCI devices installed on your system. Click the plus sign (+) before the PCI Information item to display available information.

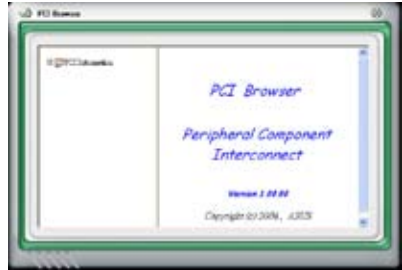

## Usage

The Usage browser displays real-time information on the CPU, hard disk drive space, and memory usage. Click **USAGE** to display the Usage browser.

### CPU usage

The CPU tab displays real-time CPU usage in line graph representation. If the CPU has an enabled Hyper-Threading, two separate line graphs display the operation of the two logical processors.



### Hard disk drive space usage

The Hard Disk tab displays the used and available hard disk drive space. The left panel of the tab lists all logical drives. Click a hard disk drive to display the information on the right panel. The pie chart at the bottom of the window represents the used (blue) and the available HDD space.



## Memory usage

The Memory tab shows both used and available physical memory. The pie chart at the bottom of the window represents the used (blue) and available (pink) memory.



## Configuring PC Probe II

Click **CONFIG** to view and adjust the sensor threshold values.

The Config window has two tabs: Sensor/Threshold and Preference. The Sensor/Threshold tab enables you to activate the sensors or to adjust the sensor threshold values. The Preference tab allows you to customize sensor alerts, or change the temperature scale.



Loads the default threshold values for each sensor

Applies your changes

Cancels or ignores your changes

Loads your saved configuration  
 Saves your configuration

### 5.3.4 ASUS AI Gear

ASUS AI Gear provides four system performance options that allows you to select the best performance setting for your computing needs. This easy-to-use utility adjusts the processor frequency and VCore voltage to minimize system noise and power consumption.

After installing AI Gear from the bundled support CD, you can launch AI Gear by double-clicking the AI Gear icon on your Windows OS taskbar.

Shift the gear to the performance setting that you like.

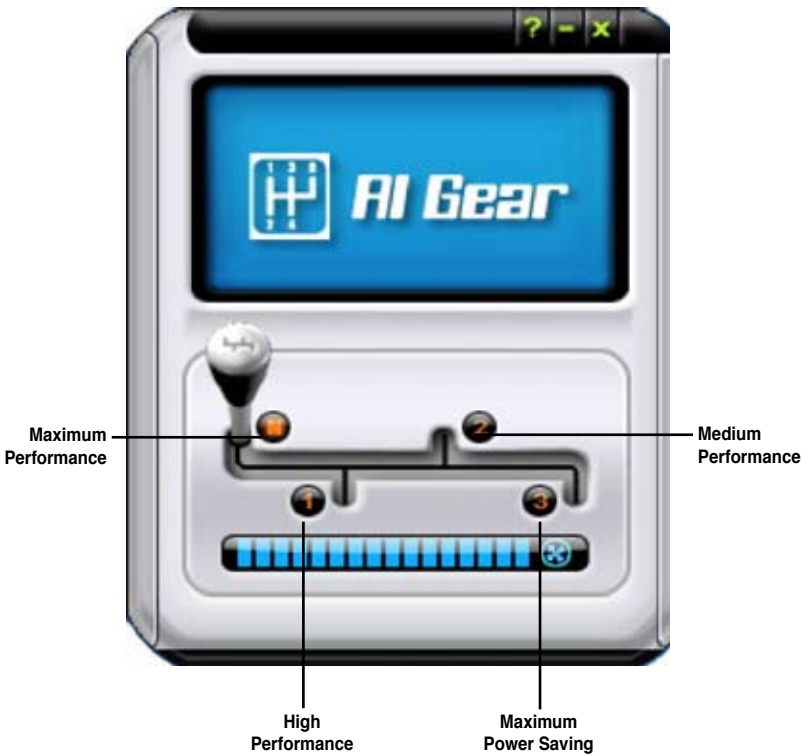

You can also set the AI Gear modes by clicking the AI Gear icon on the Windows taskbar.



- When AI Gear is enabled, the system will automatically optimize the CPU and chassis fan speed according to the system loading.
- The AI Booster (AI NOS) and AI Gear functions cannot be enabled simultaneously



### 5.3.5 ASUS Ai Nap

This feature allows you to minimize the power consumption of your computer whenever you are away. Enable this feature for minimum power consumption and a more quiet system operation.

After installing Ai Nap from the bundled support CD, you can launch the utility by double-clicking the Ai Nap icon on the Windows OS taskbar. Click **Yes** on the confirmation screen.

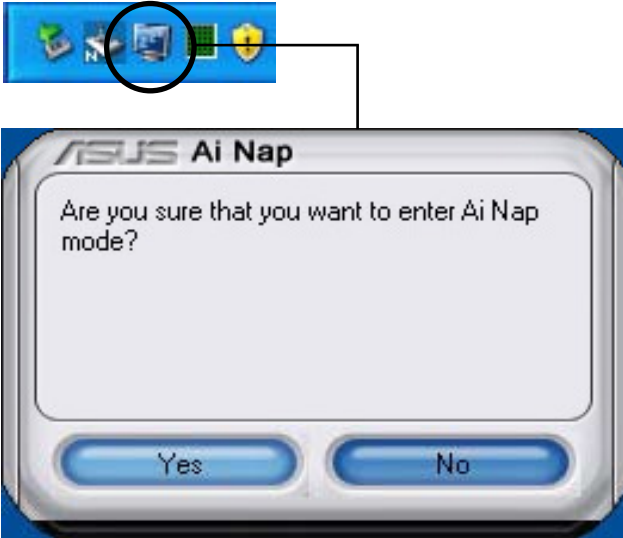

To exit Ai Nap mode, press the system power or mouse button then click **Yes** on the confirmation screen.

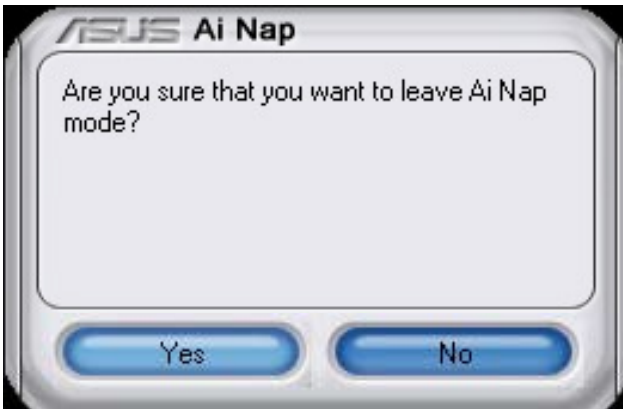

### 5.3.6 ASUS Music Alarm

This motherboard is equipped with an audio alarm clock called ASUS Music Alarm. The ASUS Music Alarm gives you a personal wake-up called with your favorite CD music when the system is off. The onboard audio CODEC supports this feature, which requires an optical drive (CD-ROM, CD-RW, or DVD-ROM).



- 
- Make sure that the power cord is plugged to a grounded power source so that the system has standby power.
  - ASUS Music Alarm only supports audio CDs.
  - ASUS Music Alarm will not work if you installed and enabled an add-on sound card.
  - Only IDE ATAPI devices from the Southbridge support this feature.
- 

#### Hardware setup

To set up the hardware:

1. Connect the analog audio cable from the optical drive to the 4-pin CD-In connector labeled CD on the motherboard. See section “2.7.2 Internal connectors” for the connector location.
2. Connect speakers or a headphone to the Line-Out (lime-colored) port on the front or rear panel for audio output. You may also connect speakers or a headphone to the output jack on the optical drive.
3. Refer to the succeeding sections to make the appropriate settings in the BIOS or in Windows®.

#### BIOS configuration

To enable ASUS Music Alarm in the BIOS:

1. Turn on the system.
2. During POST, press <Del> to enter BIOS setup.
3. Go to the **Tools** menu, then select **ASUS Music Alarm**.
4. Set the **ASUS Music Alarm** item to [Enabled]. See section “4.7.1 ASUS Music Alarm” for details.

## OS configuration

To configure ASUS Music Alarm in Windows®

1. Place the support CD into the optical drive.
2. Click the **Utilities** tab and choose **ASUS Music Alarm** to install the utility.
3. Insert an audio CD into the optical drive.
4. Launch the ASUS Music Alarm application by going to **Start > ASUS > ASUS Music Alarm**. The main window appears.

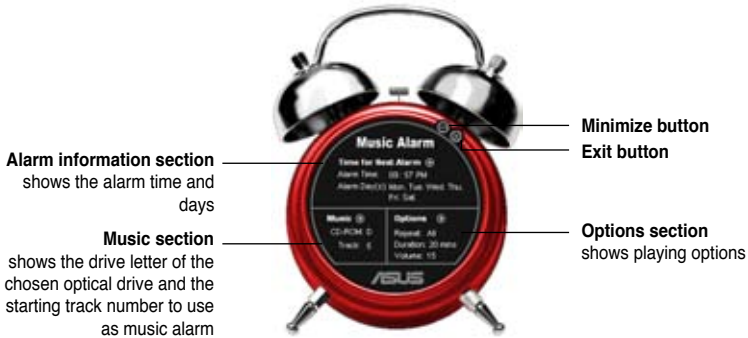

5. Click the arrow (▶) next to **Time for Next Alarm** in the Alarm information section. The Alarm Time Setting panel appears. Set the days and time of the alarm, or enable/disable the Music Alarm feature.

When done, click **OK**.



6. Click the arrow (▶) next to **Music** in the Music section. The Music Selection panel appears. Select the optical storage device, then choose the starting CD track number from which you would like the music alarm to play.

When done, click **OK**.



7. Click the arrow (▶) next to **Options** in the Options section. The Options panel appears. Disable or select the Repeat mode, then specify the length of the alarm music to play. Set the desired volume.

When done, click **OK**.



8. After you have finished making all the required settings, turn off the system.

### Adjusting the volume

To adjust the volume while the music alarm is playing:

- Use the <Up> or <Down> arrow key to increase or decrease the volume.

### Turning off the music alarm

To turn off the music alarm:

- Press any key to stop playing the CD and turn off the system.



- 
- While the music alarm is playing, the system wake-up features (LAN, keyboard, mouse, PCI/PCIE device, modem) are deactivated.
  - If the system loses connection or if it does not detect any optical drive or audio CD, the ASUS Music Alarm is automatically disabled/turned off.
  - While the music alarm is playing, the optical drive front panel functions are automatically disabled.
  - The ASUS Music Alarm works only when the system is off.
-

### 5.3.7 SoundMAX® High Definition Audio utility

The ADI AD1988B High Definition Audio CODEC provides 8-channel audio capability through the SoundMAX® audio utility with AudioESP™ software to deliver the ultimate audio experience on your PC. The software implements high quality audio synthesis/rendering, 3D sound positioning, and advanced voice-input technologies.

Follow the installation wizard to install the ADI AD1988B Audio Driver from the support CD that came with the motherboard package to activate the SoundMAX® audio utility.



- You must use 4-channel, 6-channel or 8-channel speakers for this setup.
- SoundMAX® requires Microsoft® Windows® 2000/XP or later version. Make sure that one of these operating systems is installed before installing SoundMAX®.
- Jack Retasking function works on High Definition front panel audio ports only.

If the SoundMAX® audio utility is correctly installed, you will find the SoundMAX® icon on the taskbar.



From the taskbar, double-click on the SoundMAX® icon to display the SoundMAX® Control Panel.



### Audio Setup Wizard

By clicking the  icon from the SoundMAX® control panel, you can easily configure your audio settings. Simply follow succeeding screen instructions and begin enjoying High Definition Audio.



## Jack configuration

This screen helps you configure your computer's audio ports, depending on the audio devices you have installed.



## Adjust speaker volume

This screen helps you adjust speaker volume. Click the **Test** button to hear the changes you have made.



## Adjust microphone volume

This screen helps you adjust microphone volume. You will be asked to read pre-written text to allow the AudioWizard to adjust the volume as you speak.



## Audio preferences

Click the  icon to go to the Preferences page. This page allows you to change various audio settings.

### General options

Click the General tab to choose your playback and recording devices, enable/disable the AudioESP™ feature, and enable/disable digital output.

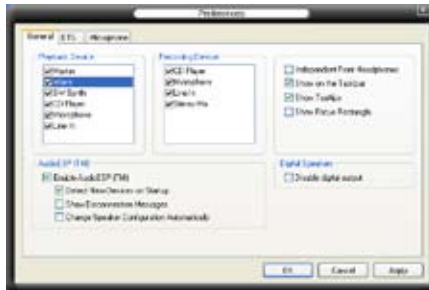

### DTS.

This feature is consists of two elements: DTS interactive and DTS NEO:PC. DTS interactive re-encodes your stereo or multi-channel sound into a DTS audio signal and send it out from your PC to any DTS enabled system.

While DTS NEO:PC turns your stereo audio such as MP3, WMA, CD, and other sound format into a convincing multi-channel audio experience.





## Microphone options

Click the Listening Environment tab allows you to optimize your microphone input settings.



## Enhanced Microphone Features

### Voice recording

Enables Noise Filter function. Detects repetitive and stationary noises like computer fans, air conditioners, and other background noises then eliminates it in the incoming audio stream while recording. You can enable it for a better recording quality.

### Directional Array

Receives only the sound coming from the reception cone and eliminates interferences including neighboring speakers and reverberations. You can enable it to transit clearer sound during on-line games, MSN, or Skype.

### Speaker Phone

Advanced de-reverberation techniques can help to reduce echo and minimize its effect on the speech engine. You can enable it when you have conference call to reduce echoes in the other side.



---

The directional Array and Speaker Phone function only when working with the ASUS Array Nic.

---



## 5.4 RAID configurations

The motherboard comes with the Silicon Image Sil3132 and the NVIDIA® nForce™ 590 SLI Southbridge RAID controllers that allow you to configure Serial ATA hard disk drives as RAID sets. The motherboard supports the following RAID configurations.

RAID 0 (Data striping) optimizes two identical hard disk drives to read and write data in parallel, interleaved stacks. Two hard disks perform the same work as a single drive but at a sustained data transfer rate, double that of a single disk alone, thus improving data access and storage. Use of two new identical hard disk drives is required for this setup.

RAID 1 (Data mirroring) copies and maintains an identical image of data from one drive to a second drive. If one drive fails, the disk array management software directs all applications to the surviving drive as it contains a complete copy of the data in the other drive. This RAID configuration provides data protection and increases fault tolerance to the entire system. Use two new drives or use an existing drive and a new drive for this setup. The new drive must be of the same size or larger than the existing drive.

RAID 0+1 is data striping and data mirroring combined without parity (redundancy data) having to be calculated and written. With the RAID 0+1 configuration you get all the benefits of both RAID 0 and RAID 1 configurations. Use four new hard disk drives or use an existing drive and three new drives for this setup.

RAID 5 stripes both data and parity information across three or more hard disk drives. Among the advantages of RAID 5 configuration include better HDD performance, fault tolerance, and higher storage capacity. The RAID 5 configuration is best suited for transaction processing, relational database applications, enterprise resource planning, and other business systems. Use a minimum of three identical hard disk drives for this setup.

JBOD (Spanning) stands for Just a Bunch of Disks and refers to hard disk drives that are not yet configured as a RAID set. This configuration stores the same data redundantly on multiple disks that appear as a single disk on the operating system. Spanning does not deliver any advantage over using separate disks independently and does not provide fault tolerance or other RAID performance benefits.



---

If you want to boot the system from a hard disk drive included in a RAID set, copy first the RAID driver from the support CD to a floppy disk before you install an operating system to a selected hard disk drive. Refer to section “5.6 Creating a RAID driver disk” for details.

---

## 5.4.1 Installing hard disks

The motherboard supports Serial ATA hard disk drives. For optimal performance, install identical drives of the same model and capacity when creating a disk array.

### Installing Serial ATA (SATA) hard disks

To install the SATA hard disks for a RAID configuration:

1. Install the SATA hard disks into the drive bays.
2. Connect the SATA signal cables.
3. Connect a SATA power cable to the power connector on each drive.



---

Refer to the RAID controllers user manual in the motherboard support CD for detailed information on RAID configurations. See section “5.2.4 Manuals menu.”

---

## 5.4.2 NVIDIA® MediaShield RAID configurations

The motherboard includes a high performance RAID controller integrated in the NVIDIA® nForce™ 590 SLI southbridge chipset. It supports RAID 0, RAID 1, RAID 0+1, RAID 5 and JBOD for four independent Serial ATA channels.

### Setting the BIOS RAID items

After installing the hard disk drives, make sure to set the necessary RAID items in the BIOS before setting your RAID configuration.

To set the BIOS RAID items:

1. Boot the system and press <Del> during the Power-On Self-Test (POST) to enter the BIOS Setup Utility.
2. From the Main > Serial ATA Configuration menu item in the BIOS set the nVidia RAID Function item to Enabled.
3. Select and enable the SATA drive(s) that you want to configure as RAID. See section “4.4.7 Onboard Device Configuration” for details.
4. Save your changes and Exit Setup.



---

Make sure to re-enter your NVRAID settings after the CMOS is cleared; otherwise, the system will not recognize your RAID setup.

---



- For detailed descriptions on the NVIDIA® RAID configuration, refer to the “NVIDIA® RAID User’s Guide” found in your motherboard support CD.
  - When using Windows 2000 operating system, make sure to install the Windows 2000 Service Pack 4 or later versions.
-

## Entering the NVIDIA® MeidaShield RAID utility

To enter the NVIDIA® RAID utility:

1. Boot up your computer.
2. During POST, press <F10> to display the main menu of the utility.



The RAID BIOS setup screens shown in this section are for reference only, and may not exactly match the items on your screen.

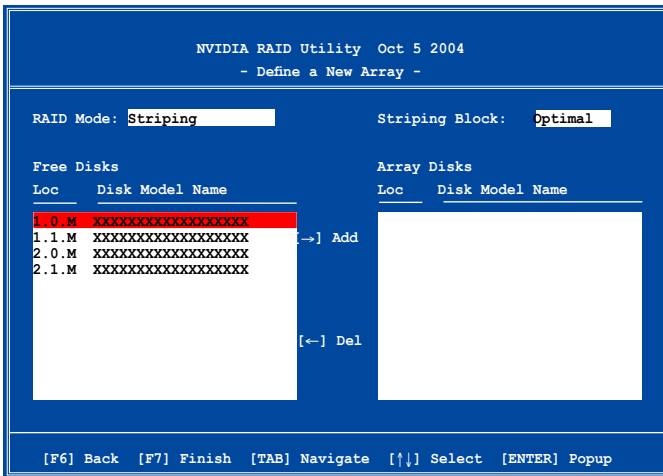

At the bottom of the screen are the navigation keys. These keys allow you to move through and select menu options.

## Creating a RAID Volume

To create a RAID volume:

1. From the NVIDIA® RAID utility Define a New Array menu, select RAID Mode then press <Enter>. The following submenu appears.

Use the up or down arrow keys to select a RAID mode then press <Enter>.

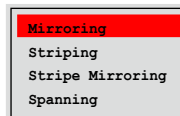

2. Press <TAB> select the Striping Block then press <Enter>. The following submenu appears:

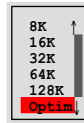

If you selected Striping or Stripe Mirroring, use the up or down arrow keys to select the stripe size for your RAID 0 array then press <Enter>. The available values range from 8 KB to 128 KB. The default selection is 128 KB. The strip value should be chosen based on the planned drive usage.

- 8 /16 KB - low disk usage
- 64 KB - typical disk usage
- 128 KB - performance disk usage



---

TIP: For server systems, we recommend using a lower array block size. For multimedia computer systems used mainly for audio and video editing, we recommend a higher array block size for optimum performance.

---

3. Press <TAB> to select the Free Disks area. Use the left or right arrow keys to assign the array disks.
4. Press <F7> to create RAID set. The following message box appears.

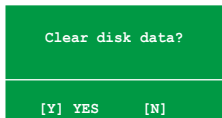

5. Press <Y> to clear the selected disks or <N> to proceed without clearing the disks. The following screen appears.



---

Take caution in using this option. All data on the RAID drives will be lost!

---

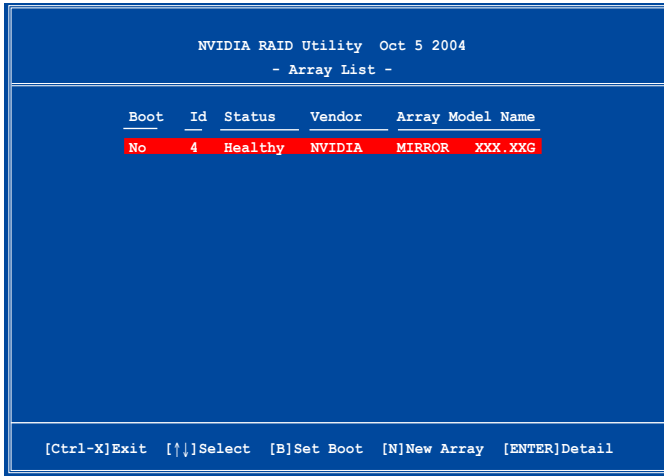

A new set of navigation keys is displayed on the bottom of the screen.

6. Press <Ctrl+X> to save settings and exit.

## Rebuilding a RAID array

To rebuild a RAID array:

1. From the Array List menu, use the up or down arrow keys to select a RAID array then press <Enter>. The RAID Array details appear.

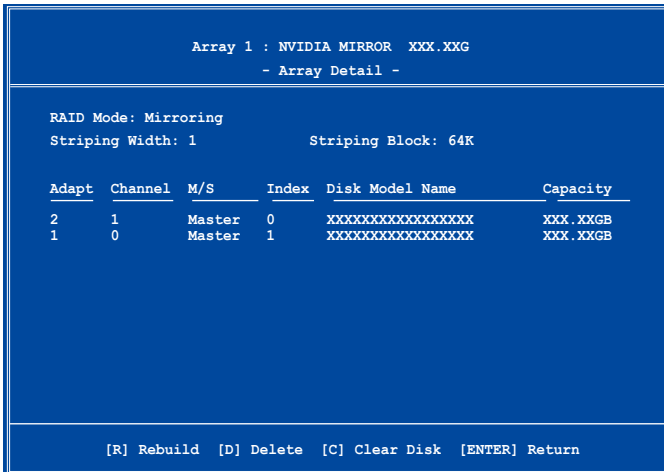

A new set of navigation keys is displayed on the bottom of the screen.

2. Press <R> to rebuild a RAID array. The following screen appears.

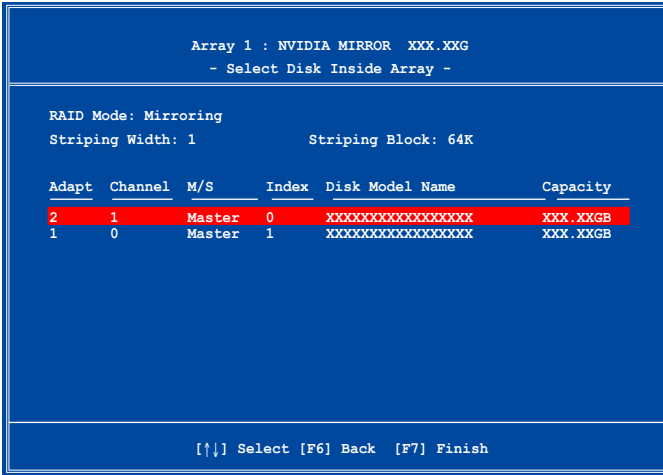

3. Use the up or down arrow keys to select a RAID array to rebuild, then press <F7>. The following confirmation message appears.

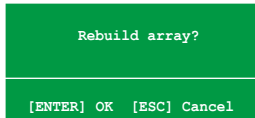

4. Press <Enter> to start rebuilding array or press <Esc> to cancel.
5. After the rebuild process, the Array list menu appears.



## Deleting a RAID array

To delete a RAID array:

1. From the Array List menu, use the up or down arrow keys to select a RAID array then press <Enter>. The RAID Array details appear.

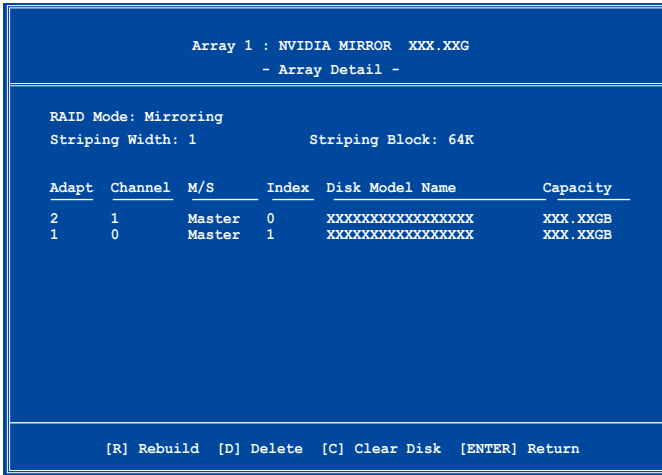

A new set of navigation keys is displayed on the bottom of the screen.

2. Press <D> to delete a RAID array. The following confirmation message appears.

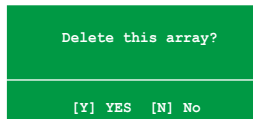

3. Press <Y> to delete array or press <N> to cancel.



Take caution in using this option. All data on the RAID drives will be lost!

4. If you selected Yes, the Define a New Array menu appears.

## Clearing a disk data

To clear disk data:

1. From the Array List menu, use the up or down arrow keys to select a RAID array then press <Enter>. The RAID Array details appear.

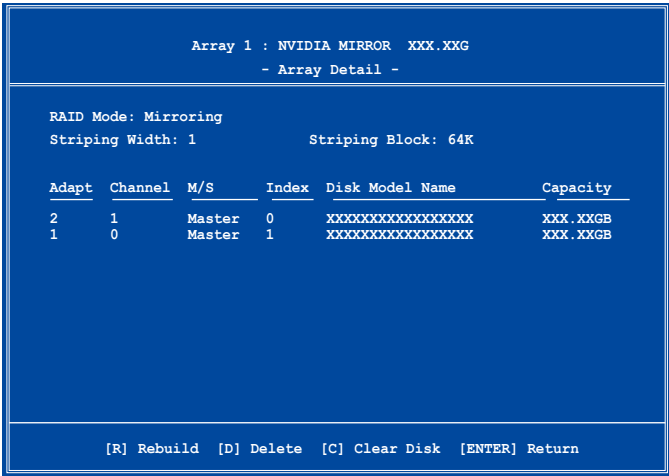

A new set of navigation keys is displayed on the bottom of the screen.

2. Press <C> to clear disk. The following confirmation message appears.

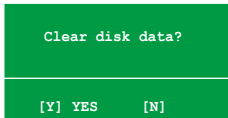

5. Press <Y> to clear the disk data or press <N> to cancel.



Take caution in using this option. All data on the RAID drives will be lost!

### 5.4.3 Silicon Image RAID configurations

The Silicon Image RAID controller supports RAID 0, RAID 1 and JBOD configurations. Use the Silicon Image RAID utility to configure a disk array.

#### Setting the BIOS RAID items

After installing the hard disk drives, make sure to set the necessary RAID items in the BIOS before setting your RAID configuration.

To set the BIOS RAID items:

1. Boot the system and press <Del> during the Power-On Self-Test (POST) to enter the BIOS Setup Utility.
2. From the Advanced > Onboard Devices Configuration menu item in the BIOS set the Silicon Image Controller item to RAID Mode. See section “4.4.6 Onboard Devices Configuration” for details.
3. Save your changes and Exit Setup.

#### Launching the Silicon Image Array Management Software

Launch the Silicon Image Array Management software from Windows® XP by clicking the Start button and selecting All Programs > Silicon Image > Sam



---

For details on the Silicon Image SATAraid™ RAID configuration, refer to the “Sil3132 User Guide” in your motherboard support CD.

---

## Entering the Silicon Image BIOS RAID Configuration Utility

To enter the Silicon Image BIOS RAID configuration utility:

1. Boot up your computer.
2. During POST, press <Ctrl+S> or <F4>.



The RAID BIOS setup screens shown in this section are for reference only, and may not exactly match the items on your screen.

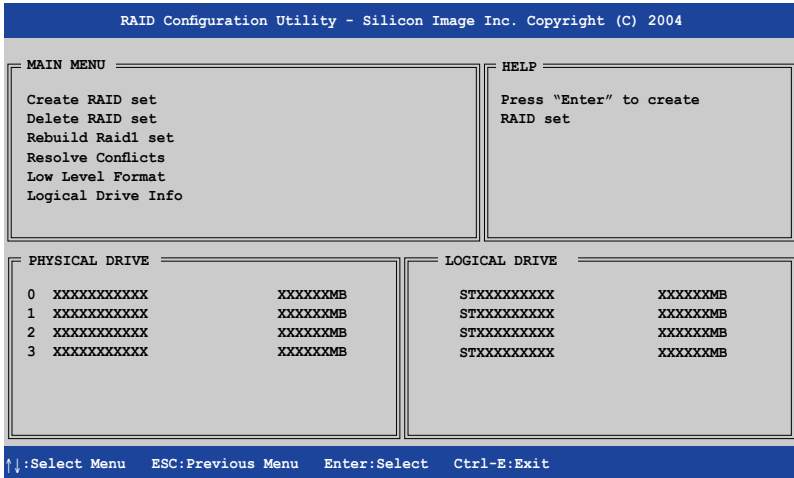

The Main Menu on the upper left corner allows you to select an operation to be performed. The Main Menu options include the following:

Create RAID set - creates a new legacy RAID set or allocates spare drives.

Delete RAID set - deletes a RAID set or deallocates a spare drive.

Rebuild RAID1 set - rebuilds a RAID 1 set (e.g., swapped drives).

Resolve Conflicts - automatically restores disrupted drives on a RAID set.

Low Level Format - creates a pattern of reference marks on a drive.

Formatting the disks erases all data previously stored in the drive.

Logical Drive Info - shows the current configuration of each RAID set.

On the upper right corner of the screen is the Help message box. The message describes the function of each menu item. At the bottom of the screen is the legend box. The keys on the legend box allow you to navigate through the setup menu options. The following lists the keys found in the legend box and their corresponding functions.

- ↑, ↓ : Select/Move to the next item
- ESC : Previous Menu
- Enter : Select
- Ctrl-E : Exit

## Creating a RAID 0 set (Striped)

To create a RAID set:

1. From the Silicon Image configuration utility main menu, select Create RAID set then press <Enter> to display an option menu.

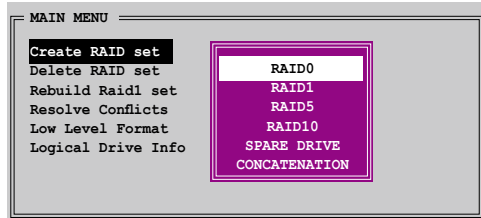

The RAID5, RAID10 or Spare Drive items will appear only when you use external SATA port multiplier.

2. Select RAID 0 then press <Enter> to display the following.

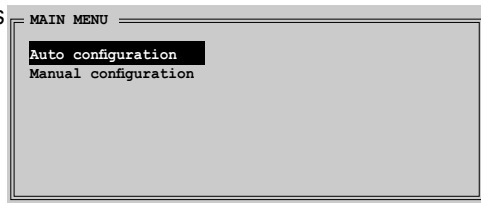

3. Select your desired method of configuration.  
Auto configuration
  - a. Select Auto Configuration the press <Enter>.
  - b. The utility prompts a message to input the RAID size, use the up or down arrow keys to set the RAID size then press <Enter>.
  - c. Press <Y> to confirm or <N> to return to the Main Menu.



By default, Auto configuration sets the stripe size to 64K and sets the logical drives based on the physical drives installed.

### Manual configuration

- a. Select Manual configuration and press <Enter>. The following pop-up menu appears.
- b. Use the up or down arrow keys to select a chunk size appropriate to your drive usage then press <Enter>.

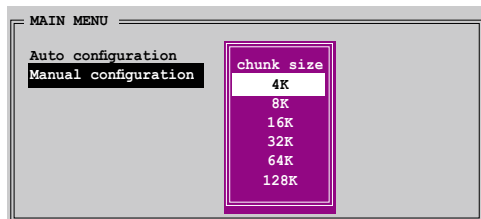



TIP: For server systems, we recommend using a lower array block size. For multimedia computer systems used mainly for audio and video editing, we recommend a higher array block size for optimum performance.

- c. The selection bar moves to the Physical Drive menu. Using the up or down arrow keys, select a drive then press <Enter> to set the first drive of the RAID set.

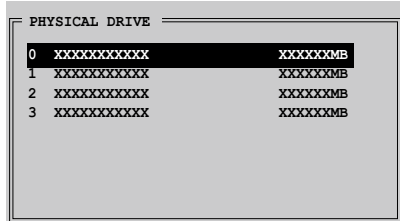

- d. Repeat step c to set the second, third, and fourth drive. The number of available drives depend on the installed and enabled physical drives in the system.
- e. The utility prompts a message to input the RAID size, use the up or down arrow keys to set the RAID size then press <Enter>.
- f. Press <Y> to confirm or <N> to return to the Main Menu.

## Creating a RAID 1 set (Mirrored)

To create a RAID 1 set:

1. From the Silicon Image configuration utility main menu, select Create RAID set then press <Enter>. The following sub-menu appears.

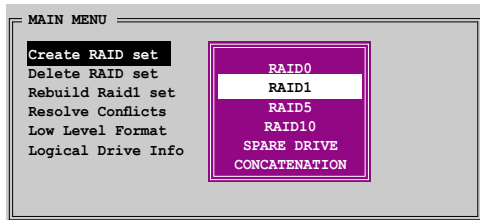

2. Select RAID 1 then press <Enter> to display the following.

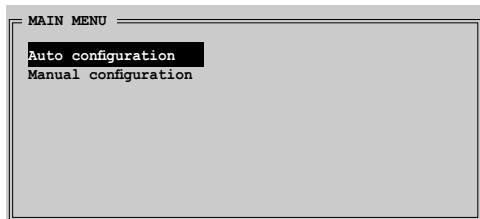

3. Select your desired method of configuration.

Auto configuration

- Select Auto Configuration then press <Enter>.
- The utility prompts a message to input the RAID size, use the up or down arrow keys to set the RAID size then press <Enter>.
- Press <Y> to confirm or <N> to return to the Main Menu.



- Auto-configuration creates a RAID 1 set without a backup copy of the current source disk data.
- When migrating a single hard disk drive to a RAID 1 set, use of the Manual configuration is recommended.

Manual configuration

- Select Manual configuration and press <Enter>. The selection bar moves to the Physical Drives menu.
- Using the up or down arrow keys, select the source drive and press <Enter>.
- Repeat step b to select the target drive.
- After selecting the source and target drives, the following pop-up menu appears.

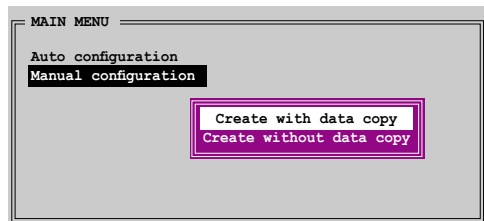
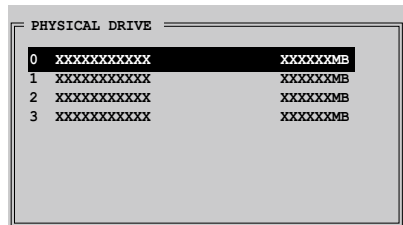

- The Create with data copy option allows you to copy the current data from the source drive to the mirror drive.
- Select Create with data copy if you have important data in your source drive.
- The Create without data copy option disables the disk copy function of the Mirrored set.
- If you selected Create without data copy, the RAID 1 set must be repartitioned and reformatted to guarantee the consistency of its contents.

- e. If you selected Create with data copy, the following pop-up menu appears.

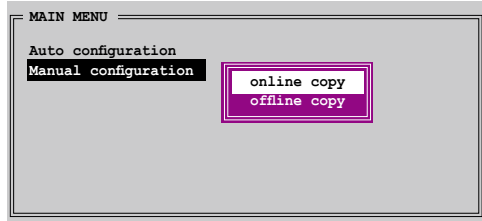

---

The online copy option automatically copies the data to the target drives on the background while writing to the source drives. The offline copy option allows you to copy the contents of the source drive to the target drives now.

---

- f. Use the up or down arrow keys to select desired copy method, then press <Enter>.
- g. The utility prompts a message to input the RAID size, use the up or down arrow keys to set the RAID size then press <Enter>.
- h. Press <Y> to confirm or <N> to return to the Main Menu.



---

A copy progress appears if you previously selected offline copy.

---



## Creating a CONCATENATION set

To create a CONCATENATION set:

1. From the Silicon Image configuration utility main menu, select Create RAID set then press <Enter>.
2. From the sub-menu Select CONCATENATION then press <Enter>.

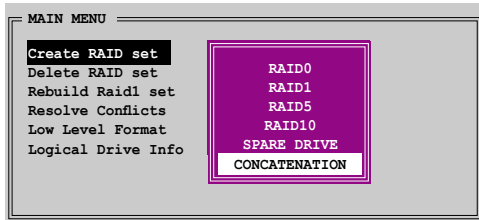

3. The selection bar moves to the Physical Drive menu. Using the up or down arrow keys, select a drive then press <Enter> to set a drive for the RAID set.
4. The utility prompts a message to input the RAID size, use the up or down arrow keys to set the RAID size then press <Enter>.
5. Press <Y> to confirm or <N> to return to the Main Menu.

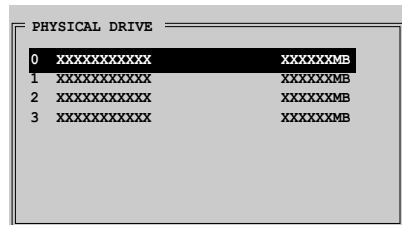

Configure a CONCATENATION set when using a single Serial ATA drive; otherwise, the system will not recognize the drive.

## 5.5 Creating a RAID driver disk

A floppy disk with the RAID driver is required when installing Windows® 2000/XP operating system on a hard disk drive that is included in a RAID set.

To create a RAID driver disk:

1. Place the motherboard support CD into the CD-ROM drive.
2. Select Make Disk tab.
3. From the Make Disk menu, select the RAID driver disk you want to create or browse the contents of the support CD to locate the driver disk utility.



---

Refer to section “5.2.4 Make Disk menu” for details.

---

4. Insert floppy disk to floppy disk drive.
5. Follow succeeding screen information to complete process.
6. Write-protect the floppy disk to avoid computer virus infection.

To install the RAID driver:

1. During the OS installation, the system prompts you to press the F6 key to install third-party SCSI or RAID driver.
2. Press <F6> then insert the floppy disk with RAID driver into the floppy disk drive.
3. Follow the succeeding screen instructions to complete the installation.



---

Due to chipset limitation, the Serial ATA ports supported by the NVIDIA chipset doesn't support Serial Optical Disk Drives (Serial ODD) under DOS.

---

This chapter tells how to install  
SLI-ready PCI Express graphics cards.

# **NVIDIA<sup>®</sup> SLI<sup>™</sup>** **technology support**

## Chapter summary

6.1	Overview .....	6-1
6.2	Dual graphics cards setup.....	6-2

## 6.1 Overview

The motherboard supports the NVIDIA® SLI™ (Scalable Link Interface) - Intel® Edition technology that allows you to install two identical PCI Express™ x16 graphics cards. Follow the installation procedures in this section.

### Requirements

- You should have two identical SLI-ready graphics cards that are NVIDIA® certified.
- Make sure that your graphics card driver supports the NVIDIA SLI technology. Download the latest driver from the NVIDIA website ([www.nvidia.com](http://www.nvidia.com)).
- Make sure that your power supply unit (PSU) can provide at least the minimum power required by your system. See “13. ATX power connectors” on page 2-28 for details.



- 
- The NVIDIA SLI technology supports Windows® XP™ 32-bit/64bit operating system only.
  - Visit the NVIDIA zone website (<http://www.nzone.com>) for the latest certified graphics card and supported 3D application list.
-

## 6.2 Dual graphics card setup

### 6.2.1 Installing SLI-ready graphics cards



Install only identical SLI-ready graphics cards that are NVIDIA®-certified. Different types of graphics cards will not work together properly.

To install the graphics cards:

1. Prepare two graphics cards. Each graphics card should have goldfingers for the SLI connector.



Goldfingers

2. Remove the metal bracket covers opposite the two PCI Express x16 slots.

3. Insert one graphics card into either the blue or black slot. Make sure that the card is properly seated on the slot.



4. Insert the second graphics card into the other slot. Make sure that the card is properly seated on the slot.

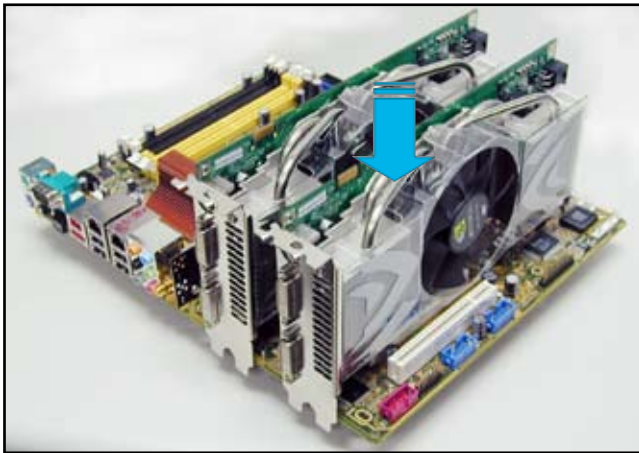

If required, connect an auxiliary power source to the PCI Express graphics cards.

5. Align and insert the SLI connector to the goldfingers on each graphics card. Make sure that the connector is firmly in place.

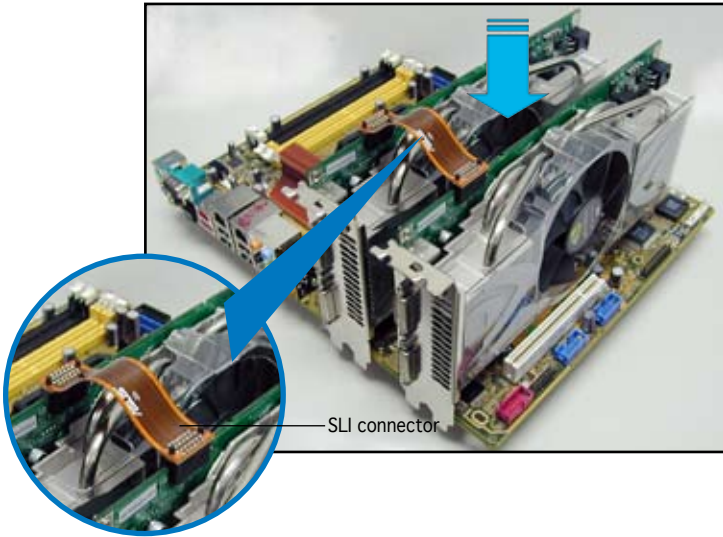

6. When installing two VGA cards using a 20-pin ATX PSU with sufficient +12v capability, we recommend that you connect the auxillary power source from the power supply to the graphics card. Refer to the PSU documentation for dual VGA power requirements.
7. Connect a VGA cable or a DVI-I cable to the graphics card/s.



---

We recommend to install an additional chassis fan for better thermal environment.

---



## 6.2.2 Installing the device drivers

Refer to the documentation that came with your graphics card package to install the device drivers.



Make sure that your PCI Express graphics card driver supports the NVIDIA SLI technology. Download the latest driver from the NVIDIA website ([www.nvidia.com](http://www.nvidia.com)).

## 6.2.3 Enabling the multi-GPU feature in Windows®

After installing your graphics cards and the device drivers, enable the Multi-Graphics Processing Unit (GPU) feature in the NVIDIA nView properties.

To enable the multi-GPU feature:

1. Click the NVIDIA Settings icon on your Windows taskbar.



NVIDIA Settings icon

2. From the pop-up menu, select nView Desktop Manager then click nView Properties.

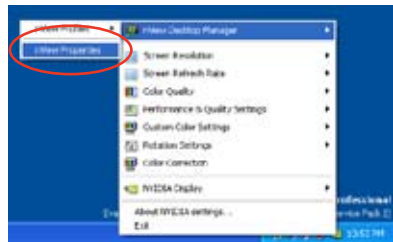

3. From the nView Desktop Manager window, select the Desktop Management tab.
4. Click Properties to display the Display Properties dialog box.



- From the Display Properties dialog box, select the Settings tab then click Advanced.



- Select the NVIDIA GeForce tab.

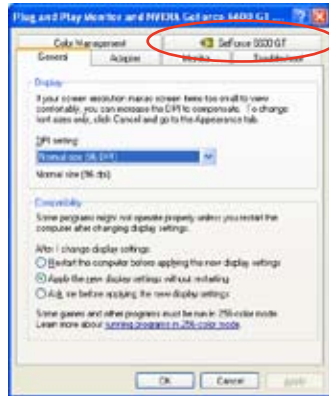

- Click the slider to display the following screen, then select the SLI multi-GPU item.

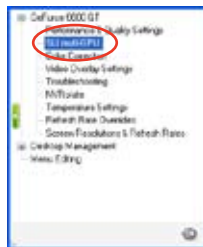

Slider



- Click the Enable SLI multi-GPU check box.
- Click OK when done.