

M2V

User Guide



Motherboard

E2582

First Edition

May 2006

Copyright © 2006 ASUSTeK COMPUTER INC. All Rights Reserved.

No part of this manual, including the products and software described in it, may be reproduced, transmitted, transcribed, stored in a retrieval system, or translated into any language in any form or by any means, except documentation kept by the purchaser for backup purposes, without the express written permission of ASUSTeK COMPUTER INC. (“ASUS”).

Product warranty or service will not be extended if: (1) the product is repaired, modified or altered, unless such repair, modification or alteration is authorized in writing by ASUS; or (2) the serial number of the product is defaced or missing.

ASUS PROVIDES THIS MANUAL “AS IS” WITHOUT WARRANTY OF ANY KIND, EITHER EXPRESS OR IMPLIED, INCLUDING BUT NOT LIMITED TO THE IMPLIED WARRANTIES OR CONDITIONS OF MERCHANTABILITY OR FITNESS FOR A PARTICULAR PURPOSE. IN NO EVENT SHALL ASUS, ITS DIRECTORS, OFFICERS, EMPLOYEES OR AGENTS BE LIABLE FOR ANY INDIRECT, SPECIAL, INCIDENTAL, OR CONSEQUENTIAL DAMAGES (INCLUDING DAMAGES FOR LOSS OF PROFITS, LOSS OF BUSINESS, LOSS OF USE OR DATA, INTERRUPTION OF BUSINESS AND THE LIKE), EVEN IF ASUS HAS BEEN ADVISED OF THE POSSIBILITY OF SUCH DAMAGES ARISING FROM ANY DEFECT OR ERROR IN THIS MANUAL OR PRODUCT.

SPECIFICATIONS AND INFORMATION CONTAINED IN THIS MANUAL ARE FURNISHED FOR INFORMATIONAL USE ONLY, AND ARE SUBJECT TO CHANGE AT ANY TIME WITHOUT NOTICE, AND SHOULD NOT BE CONSTRUED AS A COMMITMENT BY ASUS. ASUS ASSUMES NO RESPONSIBILITY OR LIABILITY FOR ANY ERRORS OR INACCURACIES THAT MAY APPEAR IN THIS MANUAL, INCLUDING THE PRODUCTS AND SOFTWARE DESCRIBED IN IT.

Products and corporate names appearing in this manual may or may not be registered trademarks or copyrights of their respective companies, and are used only for identification or explanation and to the owners' benefit, without intent to infringe.

Contents

Notices	vii
Safety information	viii
About this guide	ix
How this guide is organized	ix
Where to find more information	ix
Conventions used in this guide	x
Typography	x
M2V specifications summary	xi

Chapter 1: Product introduction

1.1 Welcome!	1-1
1.2 Package contents	1-1
1.3 Special features	1-2
1.3.1 Product Highlights	1-2
1.3.2 Unique ASUS features	1-4

Chapter 2: Hardware information

2.1 Before you proceed	2-1
2.2 Motherboard overview	2-2
2.2.1 Placement direction	2-2
2.2.2 Screw holes	2-2
2.2.3 Motherboard layout	2-3
2.2.4 Layout Contents	2-4
2.3 Central Processing Unit (CPU)	2-6
2.3.1 Installing the CPU	2-6
2.3.2 Installing the heatsink and fan	2-8
2.3.3 Connecting the CPU fan cable	2-10
2.4 System memory	2-11
2.4.1 Overview	2-11
2.4.2 Memory configurations	2-12
2.4.3 Installing a DIMM	2-13
2.4.4 Removing a DIMM	2-13
2.5 Expansion slots	2-14
2.5.1 Installing an expansion card	2-14
2.5.2 Configuring an expansion card	2-14
2.5.3 Interrupt assignments	2-15
2.5.4 PCI slots	2-16
2.5.5 PCI Express x1 slot	2-16

Contents

- 2.5.6 PCI Express x16 slot.....2-16
- 2.6 Jumpers.....2-17
- 2.7 Connectors2-19
 - 2.7.1 Rear panel connectors2-19
 - 2.7.2 Internal connectors.....2-21

Chapter 3: Powering up

- 3.1 Starting up for the first time.....3-1
- 3.2 Powering off the computer.....3-2
 - 3.2.1 Using the OS shut down function3-2
 - 3.2.2 Using the dual-function power switch.....3-2

Chapter 4: BIOS setup

- 4.1 Managing and updating your BIOS.....4-1
 - 4.1.1 Creating a bootable floppy disk.....4-1
 - 4.1.2 Using AFUDOS to update the BIOS.....4-2
 - 4.1.3 Using AFUDOS to copy BIOS from PC.....4-3
 - 4.1.4 Using ASUS EZ Flash to update the BIOS.....4-4
 - 4.1.5 ASUS CrashFree BIOS 3 Utilities4-5
 - 4.1.6 ASUS Update4-7
- 4.2 BIOS Setup program4-9
 - 4.2.1 BIOS menu screen.....4-10
 - 4.2.2 Menu bar4-10
 - 4.2.3 Navigation keys.....4-10
 - 4.2.4 Menu items.....4-11
 - 4.2.5 Sub-menu items4-11
 - 4.2.6 Configuration fields.....4-11
 - 4.2.7 Pop-up window.....4-11
 - 4.2.8 Scroll bar4-11
 - 4.2.9 General help.....4-11
- 4.3 Main menu4-12
 - 4.3.1 System Time4-12
 - 4.3.2 System Date4-12
 - 4.3.3 Legacy Diskette A4-12
 - 4.3.4 Primary and Secondary IDE Master/Slave4-13
 - 4.3.5 System Information4-14
- 4.4 Advanced menu.....4-15

Contents

4.4.1	JumperFree Configuration.....	4-15
4.4.2	USB Configuration.....	4-15
4.4.3	CPU Configuration	4-17
4.4.3	CPU Configuration	4-17
4.4.4	Chipset	4-21
4.4.5	Onboard Devices Configuration	4-22
4.4.6	PCI PnP.....	4-23
4.5	Power menu.....	4-25
4.5.1	Suspend Mode	4-25
4.5.2	Repost Video on S3 Resume	4-25
4.5.3	ACPI 2.0 Support	4-25
4.5.4	ACPI APIC Support	4-25
4.5.5	APM Configuration	4-26
4.5.6	Hardware Monitor.....	4-27
4.6	Boot menu	4-29
4.6.1	Boot Device Priority.....	4-29
4.6.2	Boot Settings Configuration.....	4-30
4.6.3	Security	4-31
4.7	Tools menu	4-34
4.8	Exit menu.....	4-35

Chapter 5: Software support

5.1	Installing an operating system	5-1
5.2	Support CD information	5-1
5.2.1	Running the support CD.....	5-1
5.2.2	Drivers menu	5-2
5.2.3	Utilities menu.....	5-3
5.2.4	Make disk menu	5-4
5.2.5	Manuals menu.....	5-5
5.2.6	ASUS Contact information	5-5
5.2.7	Other information.....	5-6
5.3	Software Information.....	5-8
	ASUS MyLogo2™.....	5-8
5.4	RAID configurations.....	5-10
5.4.1	Installing hard disks.....	5-11
5.4.2	VIA RAID configurations.....	5-12
5.5	Creating a RAID driver disk	5-19

Contents

- 5.6 Cool 'n' Quiet!™ Technology.....5-20
 - 5.6.1 Enabling Cool 'n' Quiet!™ Technology5-20
 - 5.6.2 Launching the Cool 'n' Quiet!™ software5-21

Notices

Federal Communications Commission Statement

This device complies with Part 15 of the FCC Rules. Operation is subject to the following two conditions:

- This device may not cause harmful interference, and
- This device must accept any interference received including interference that may cause undesired operation.

This equipment has been tested and found to comply with the limits for a Class B digital device, pursuant to Part 15 of the FCC Rules. These limits are designed to provide reasonable protection against harmful interference in a residential installation. This equipment generates, uses and can radiate radio frequency energy and, if not installed and used in accordance with manufacturer's instructions, may cause harmful interference to radio communications. However, there is no guarantee that interference will not occur in a particular installation. If this equipment does cause harmful interference to radio or television reception, which can be determined by turning the equipment off and on, the user is encouraged to try to correct the interference by one or more of the following measures:

- Reorient or relocate the receiving antenna.
- Increase the separation between the equipment and receiver.
- Connect the equipment to an outlet on a circuit different from that to which the receiver is connected.
- Consult the dealer or an experienced radio/TV technician for help.



The use of shielded cables for connection of the monitor to the graphics card is required to assure compliance with FCC regulations. Changes or modifications to this unit not expressly approved by the party responsible for compliance could void the user's authority to operate this equipment.

Canadian Department of Communications Statement

This digital apparatus does not exceed the Class B limits for radio noise emissions from digital apparatus set out in the Radio Interference Regulations of the Canadian Department of Communications.

This class B digital apparatus complies with Canadian ICES-003.

Safety information

Electrical safety

- To prevent electrical shock hazard, disconnect the power cable from the electrical outlet before relocating the system.
- When adding or removing devices to or from the system, ensure that the power cables for the devices are unplugged before the signal cables are connected. If possible, disconnect all power cables from the existing system before you add a device.
- Before connecting or removing signal cables from the motherboard, ensure that all power cables are unplugged.
- Seek professional assistance before using an adapter or extension cord. These devices could interrupt the grounding circuit.
- Make sure that your power supply is set to the correct voltage in your area. If you are not sure about the voltage of the electrical outlet you are using, contact your local power company.
- If the power supply is broken, do not try to fix it by yourself. Contact a qualified service technician or your retailer.

Operation safety

- Before installing the motherboard and adding devices on it, carefully read all the manuals that came with the package.
- Before using the product, make sure all cables are correctly connected and the power cables are not damaged. If you detect any damage, contact your dealer immediately.
- To avoid short circuits, keep paper clips, screws, and staples away from connectors, slots, sockets and circuitry.
- Avoid dust, humidity, and temperature extremes. Do not place the product in any area where it may become wet.
- Place the product on a stable surface.
- If you encounter technical problems with the product, contact a qualified service technician or your retailer.

About this guide

This user guide contains the information you need when installing the motherboard.

How this guide is organized

This manual contains the following parts:

- **Chapter 1: Product introduction**

This chapter describes the motherboard features and the new technologies it supports.

- **Chapter 2: Hardware information**

This chapter lists the hardware setup procedures that you have to perform when installing system components. It includes description of the jumpers and connectors on the motherboard.

- **Chapter 3: Powering up**

This chapter describes the power up sequence and ways of shutting down the system.

- **Chapter 4: BIOS setup**

This chapter tells how to change system settings through the BIOS Setup menus. Detailed descriptions of the BIOS parameters are also provided.

- **Chapter 5: Software support**

This chapter describes the contents of the support CD that comes with the motherboard package.

Where to find more information

Refer to the following sources for additional information and for product and software updates.

1. **ASUS websites**

The ASUS website provides updated information on ASUS hardware and software products. Refer to the ASUS contact information.

2. **Optional documentation**

Your product package may include optional documentation, such as warranty flyers, that may have been added by your dealer. These documents are not part of the standard package.

Conventions used in this guide

To make sure that you perform certain tasks properly, take note of the following symbols used throughout this manual.



DANGER/WARNING: Information to prevent injury to yourself when trying to complete a task.



CAUTION: Information to prevent damage to the components when trying to complete a task.



IMPORTANT: Information that you **MUST** follow to complete a task.



NOTE: Tips and additional information to aid in completing a task.

Typography

Bold text	Indicates a menu or an item to select.
<i>Italics</i>	Used to emphasize a word or a phrase.
<Key>	Keys enclosed in the less-than and greater-than sign indicates that you must press the enclosed key. Example: <Enter> indicates that you must press the Enter or Return key.
<Multiple key names>	If you must press two or more keys simultaneously, the key names are linked with a plus sign (+). Example: <Ctrl+Alt+D>
Command	Means that you must enter the command exactly as shown then supply the appropriate values that appear in brackets. Example: At the DOS prompt, type the command line: afudos /i[filename] In this example, you must supply a filename for [filename] . afudos /iM2V.ROM

M2V specifications summary

CPU	Socket AM2 for AMD Athlon™ 64 X2/Athlon™ 64FX/ Athlon™ 64/Sempron™ processor Supports AMD 64 architecture that enables simultaneous 32-bit and 64-bit computing Supports AMD Cool 'n' Quiet!™ Technology
Chipset	VIA K8T890 VIA VT8237A
System Bus	2000 MT/s
Memory	Dual-channel memory architecture 4 x 240-pin DDR2 DIMM sockets support ECC/non-ECC unbuffered 533/667/800 MHz DDR memory modules
Expansion slots	1 x PCIEX16 1 x PCIEX1 4 x PCI
Storage	VIA® VT8237A South Bridge: 2 x UltraDMA 133/100/66/33 2 x Serial ATA with RAID 0, RAID 1, and JBOD Marvell® 88SE6121: 1 x Serial ATA I/II 1 x External Serial ATA 3Gb/s hard disk(SATA On-the-Go)
AI Audio	Realtek® ALC660 6-channel CODEC Audio Sensing and Enumeration Technology S/PDIF out interface support
LAN	PCI-E Gb LAN controller
USB	Maximum of eight USB 2.0 ports
AI Overclocking Features	CPU and Memory voltage adjustable SFS (Stepless Frequency Selection) from 200 MHz up to 400 MHz at 1 MHz increment ASUS C.P.R. (CPU Parameter Recall)
Special features	ASUS EZ Flash ASUS CrashFree BIOS 3 ASUS MyLogo2™ ASUS Q-Fan2 Technology ASUS O. C. Profile
Back panel I/O	1 x Parallel port 1 x External SATA port 1 x PS/2 keyboard port 1 x PS/2 mouse port 4 x USB 2.0 ports 1 x S/PDIF output port 1 x RJ-45 port 1 x 6-channel audio ports

(continued on the next page)

M2V specifications summary

Internal I/O	2 x USB 2.0 connectors for 4 additional USB ports 1 x CPU fan connector 2 x Chassis fan connectors 24-pin/4-pin ATX 12V power connectors CD connector Front panel audio connector System panel connector Chassis Intrusion 3 x SATA connectors 2 x IDE connectors 1 x Floppy disk drive connector
BIOS features	4Mb Flash EEPROM AMI BIOS with enhanced ACPI, PnP, DMI2.0, Green
Industry standard	PCI 2.2, USB 2.0/1.1
Manageability	DMI 2.0, WOL by PME, WOR by PME
Power Requirement	ATX power supply (with 4-pin 12V plug)
Form Factor	ATX form factor: 12 in x 8.0 in (30.5 cm x 20.5 cm)
Support CD contents	Device drivers ASUS PC Probe II Anti-virus software (OEM version)

* Specifications are subject to change without notice.

Chapter 1

This chapter describes the motherboard features and the new technologies it supports.

Product introduction

Chapter summary

1.1	Welcome!	1-1
1.2	Package contents.....	1-1
1.3	Special features.....	1-2

1.1 Welcome!

Thank you for buying the ASUS® M2V motherboard!

The motherboard delivers a host of new features and latest technologies, making it another standout in the long line of ASUS quality motherboards!

Before you start installing the motherboard, and hardware devices on it, check the items in your package with the list below.

1.2 Package contents

Check your motherboard package for the following items.

- ✓ ASUS M2V motherboard
- ✓ ASUS motherboard support CD
- ✓ 1 x Serial ATA cable
- ✓ 1 x Serial ATA power cable
- ✓ 1 x 80-conductor ribbon cable for Ultra DMA 133/100/66 IDE drives
- ✓ 1 x Ribbon cable for a 3.5-inch floppy drive
- ✓ Q-connector Kit (Retail version only)
- ✓ I/O shield
- ✓ User guide



If any of the above items is damaged or missing, contact your retailer.

1.3 Special features

1.3.1 Product highlights

Latest processor technology



The motherboard comes with a 940-pin AM2 socket that supports AMD Athlon™ 64 X2/Athlon™ 64/Athlon™ FX/Sempron™ processor. With an integrated low-latency high-bandwidth memory controller and a highly scalable HyperTransport™ technology-based system bus, the motherboard provides a powerful platform for your diverse computing needs, increased office productivity, and enhanced digital media experience. See page 2-6.

AMD Cool 'n' Quiet!™ Technology



The motherboard supports the AMD Cool 'n' Quiet!™ Technology that dynamically and automatically changes the CPU speed, voltage and amount of power depending on the task the CPU performs. See pages 4-18 and 5-20.

DDR2 memory support



The motherboard supports DDR2 memory that features data transfer rates of 800/667/533 MHz to meet the higher bandwidth requirements of the latest 3D graphics, multimedia, and Internet applications. The dual-channel DDR2 architecture doubles the bandwidth of your system memory to boost system performance, eliminating bottlenecks with peak bandwidths of up to 10.7 GB/s. See pages 2-11 to 2-13 for details.

Serial ATA Technology Support



The motherboard supports the Serial ATA technology through the Serial ATA interfaces and the VIA VT8237A. The SATA specification allows for thinner, more flexible cables with lower pin count, reduced voltage requirement, and up to 150 MB/s data transfer rate.

The motherboard also supports the Serial ATA 3.0 Gb/s technology through the Serial ATA interfaces and the Marvell® 88SE6121 chipset. The Serial ATA 3 Gb/s specification provides twice the bandwidth of the current Serial ATA products with a host of new features, including Power Management (PM) Implementation Algorithm. Serial ATA allows for thinner, more flexible cables with lower pin count and reduced voltage required. See pages 2-21, 2-23, and 2-24 for details.

Serial ATA support

The motherboard provides a high-performance Serial ATA RAID controller that enhances hard disk performance and data backup protection without the cost of additional RAID cards.

The onboard VIA VT8237A RAID controller provides RAID 0, RAID 1, and JBOD configuration to two Serial ATA connectors. The onboard Marvell 88SE6121 controller supports two additional SATA 3.0 Gb/s connectors. See pages 2-23 and 5-10.

S/PDIF out

The motherboard's S/PDIF out function turns your computer into a high-end entertainment system with digital connectivity to powerful speaker systems. See page 2-21.

USB 2.0 technology

The motherboard implements the new Universal Serial Bus (USB) 2.0 specification, extending the connection speed from 12 Mbps on USB 1.1 to a fast 480 Mbps on USB 2.0 - supporting up to eight USB 2.0 ports. The higher bandwidth of USB 2.0 allows connection of devices such as high resolution video conferencing cameras, next generation scanners and printers, and fast storage units. USB 2.0 is backward compatible with USB 1.1. See pages 2-21.

1.3.2 Unique ASUS features

ASUS O.C. Profile



The motherboard features the ASUS O.C. Profile that allows users to conveniently store or load multiple BIOS settings. The BIOS settings can be stored in the CMOS or a separate file, giving users the freedom to share and distribute their favorite overclocking settings. See page 4-34.

6-channel audio



The motherboard comes with the Realtek ALC660 audio CODEC that provides 6-channel audio, audio jack-sensing and enumeration technology, and S/PDIF out support. See page 2-19 for details.

ASUS Q-Fan2 technology



The ASUS Q-Fan technology smartly adjusts the CPU and Chassis fan speed according to the system load and temperature to ensure quiet, cool, and efficient operation. See page 4-28.

ASUS CrashFree BIOS 3



The ASUS CrashFree BIOS 3 allows users to restore corrupted BIOS data from a USB flash disk containing the BIOS file. This utility saves users the cost and hassle of buying a replacement BIOS chip. See page 4-5 for details.

AI Overclocking

This feature allows convenient overclocking up to 30% (depending on the installed CPU and DRAM) to enhance system performance while maintaining system stability. See page 4-15.

ASUS Q-Connector



The ASUS Q-Connector allows you to connect or disconnect chassis front panel cables in one easy step with one complete module. This unique adapter eliminates the trouble of plugging in one cable at a time, making connection quick and accurate. See page 2-29.

ASUS MyLogo2™



This new feature present in the motherboard allows you to personalize and add style to your system with customizable boot logos. See pages 4-30, 5-7.

C.P.R. (CPU Parameter Recall)



The C.P.R. feature of the motherboard BIOS allows automatic re-setting to the BIOS default settings in case the system hangs due to overclocking. When the system hangs due to overclocking, C.P.R. eliminates the need to open the system chassis and clear the RTC data. Simply reboot the system to restore the previously saved settings. See page 2-18.

ASUS EZ Flash BIOS



With the ASUS EZ Flash, you can easily update the system BIOS even before loading the operating system. No need to use a DOS-based utility or boot from a floppy disk. See page 4-4.

Chapter 2

This chapter lists the hardware setup procedures that you have to perform when installing system components. It includes description of the jumpers and connectors on the motherboard.

Hardware information

Chapter summary

2.1	Before you proceed.....	2-1
2.2	Motherboard overview	2-2
2.3	Central Processing Unit (CPU).....	2-6
2.4	System memory.....	2-11
2.5	Expansion slots.....	2-14
2.6	Jumpers	2-17
2.7	Connectors	2-19

2.1 Before you proceed

Note of the following precautions before you install motherboard components or change any motherboard settings.



- Unplug the power cord from the wall socket before touching any component.
- Use a grounded wrist strap or touch a safely grounded object or to a metal object, such as the power supply case, before handling components to avoid damaging them due to static electricity.
- Hold components by the edges to avoid touching the ICs on them.
- Whenever you uninstall any component, place it on a grounded antistatic pad or in the bag that came with the component.
- Before you install or remove any component, ensure that the ATX power supply is switched off or the power cord is detached from the power supply. Failure to do so may cause severe damage to the motherboard, peripherals, and/or components.

Onboard LED

The motherboard comes with a standby power LED. When lit, this green LED indicates that the system is ON, in sleep mode, or in soft-off mode, a reminder that you should shut down the system and unplug the power cable before removing or plugging in any motherboard component. The illustration below shows the location of the onboard LED.

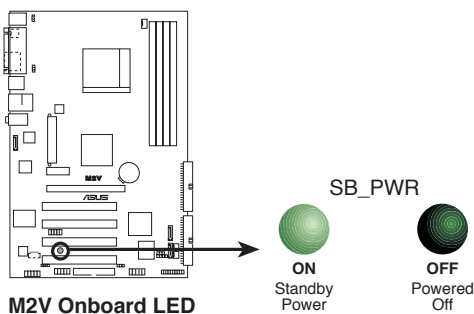

2.2 Motherboard overview

Before you install the motherboard, study the configuration of your chassis to ensure that the motherboard fits into it.



Unplug the power cord before installing or removing the motherboard. Failure to do so can cause you physical injury and damage motherboard components.

2.2.1 Placement direction

When installing the motherboard, make sure that you place it into the chassis in the correct orientation. The edge with external ports goes to the rear part of the chassis as indicated in the image below.

2.2.2 Screw holes

Place nine (6) screws into the holes indicated by circles to secure the motherboard to the chassis.



Do not overtighten the screws! Doing so can damage the motherboard.

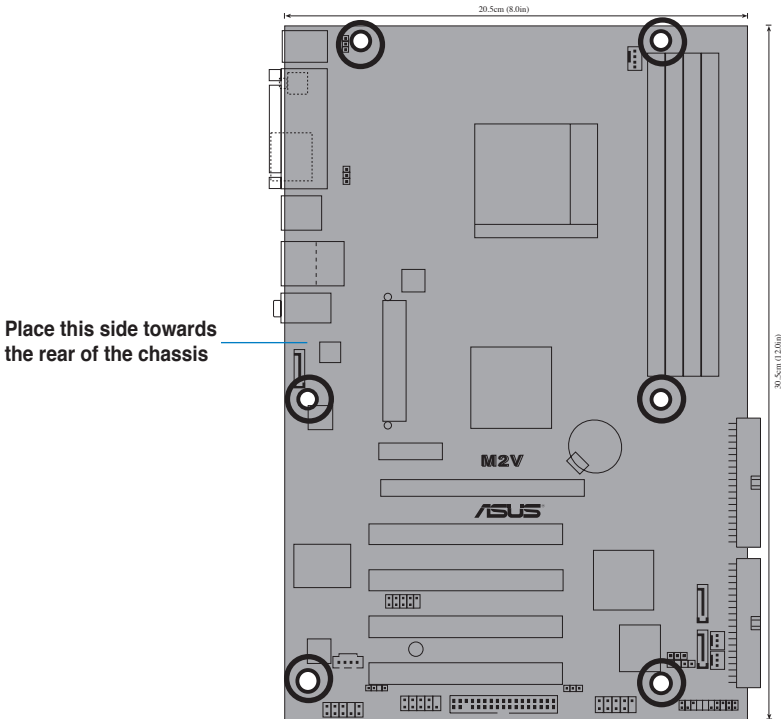

2.2.3 Motherboard layout

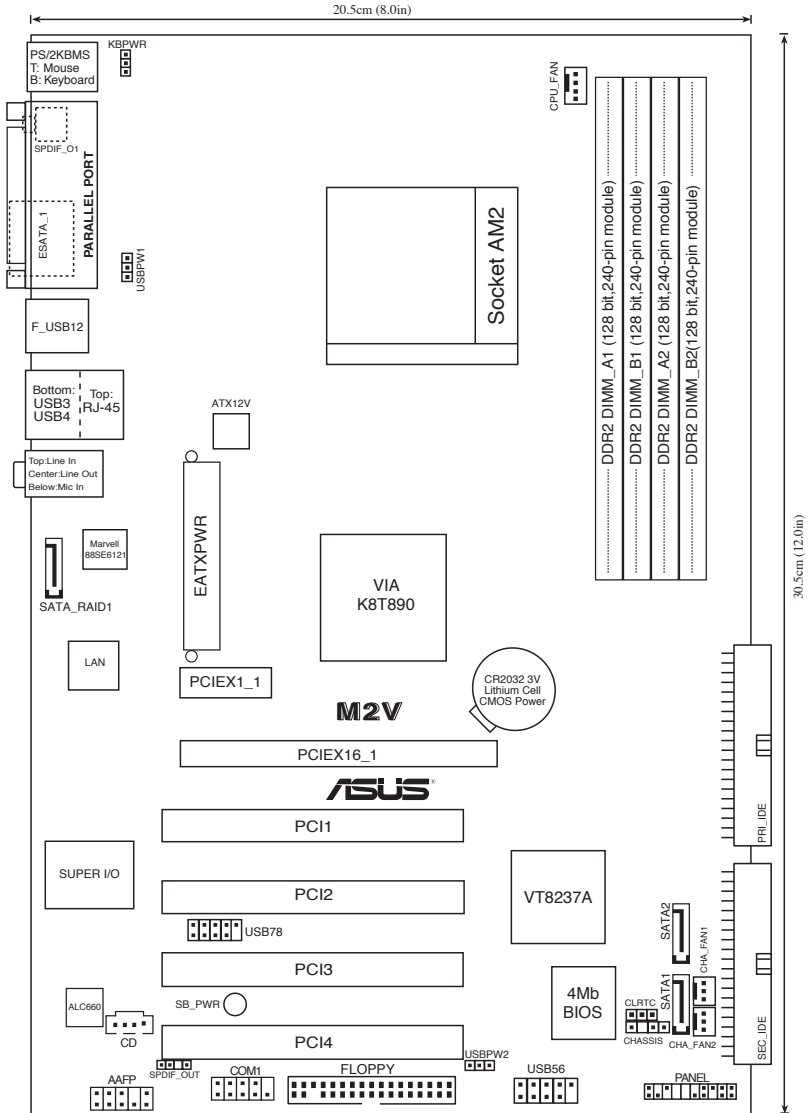

2.2.4 Layout Contents

Slots	Page
1. DDR2 DIMM slots	2-11
2. PCI slots	2-16
3. PCI Express x 1 slot	2-16
4. PCI Express x 16 slot	2-16

Jumpers	Page
1. Clear RTC RAM (3-pin CLRRTC)	2-17
2. Keyboard power (3-pin KBPWR)	2-18
3. USB device wake-up (3-pin USBPWR1, USBPWR2)	2-18

Rear Panel Connectors	Page
1. PS/2 mouse port	2-19
2. Parallel port	2-19
3. Gigabit LAN port (RJ-45)	2-19
4. Line In port	2-19
5. Line Out port	2-19
6. Microphone port	2-19
7. USB 2.0 ports 3 and 4	2-20
8. USB 2.0 ports 1 and 2	2-20
9. External SATA port	2-20
10. S/PDIF coaxial cable jack	2-20
11. PS/2 keyboard port	2-20

Internal Connectors	Page
1. Primary IDE connector (40-1 pin PRI_IDE)	2-21
2. Secondary IDE connector (40-1 pin SEC_IDE)	2-21
3. Floppy disk connector (34-1 pin FLOPPY)	2-22
4. Serial ATA connectors (7-pin SATA1, SATA2)	2-22
5. Marvell® 88SE6121 Serial ATA RAID connector (7-pin SATA_RAID1)	2-23
6. CPU fan connector (4-pin CPU_FAN)	2-24
7. Chassis fan connector (3-pin CHA_FAN)	2-24
8. CD connector (4-pin CD)	2-24
9. ATX power connector (24-pin ATXPWR)	2-25
10. ATA 12V power connector (4-pin ATX12V)	2-25
11. USB headers (10-1 pin USB56, USB78)	2-26
12. Front panel audio connector (10-1 pin FP_AUDIO)	2-27
13. System panel connector (20-pin PANEL)	2-27
- System power LED (3-pin PLED)	
- System warning speaker (4-pin SPEAKER)	
- Reset switch (2-pin RESET)	
- ATX Power switch (2-pin PWRSW)	
- Hard Disk activity LED (2-pin IDE_LED)	
14. Q-connector	2-29

2.3 Central Processing Unit (CPU)

The motherboard comes with a 940-pin AM2 socket designed for the AMD Athlon™ 64 X2/Athlon™ 64/Athlon™ FX/Sempron™ processor.



The AM2 socket has a different pinout from the 940-pin socket designed for the AMD Opteron™ processor. Make sure you use a CPU is designed for the AM2 socket. The CPU fits in only one correct orientation. DO NOT force the CPU into the socket to prevent bending the connectors on the socket and damaging the CPU!

2.3.1 Installing the CPU

To install a CPU:

1. Locate the CPU socket on the motherboard.

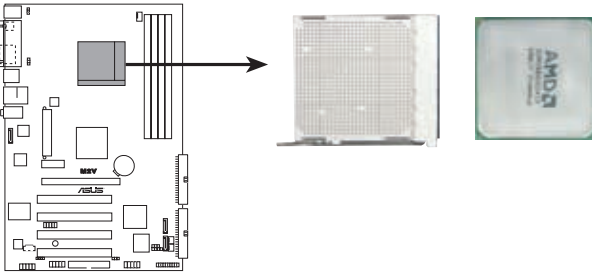

M2V CPU AM2 Socket 940

2. Unlock the socket by pressing the lever sideways, then lift it up to a 90°- 100° angle.

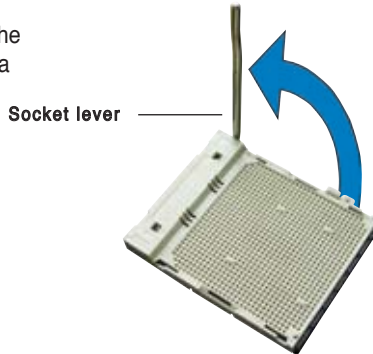

Make sure that the socket lever is lifted up to 90°-100° angle; otherwise, the CPU will not fit in completely.

3. Position the CPU above the socket such that the CPU corner with the gold triangle matches the socket corner with a small triangle.
4. Carefully insert the CPU into the socket until it fits in place.

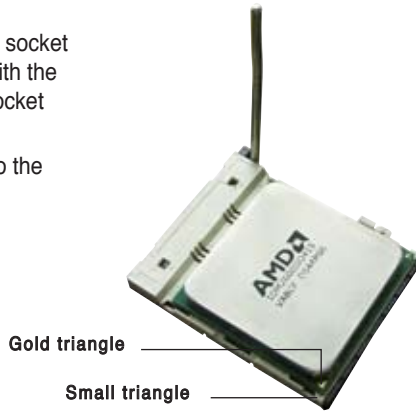

5. When the CPU is in place, push down the socket lever to secure the CPU. The lever clicks on the side tab to indicate that it is locked.
6. Install a CPU heatsink and fan following the instructions that came with the heatsink package.



2.3.2 Installing the heatsink and fan

The AMD Athlon™ 64FX or AMD Athlon 64™ processor require a specially designed heatsink and fan assembly to ensure optimum thermal condition and performance.



Make sure that you use only qualified heatsink and fan assembly.

Follow these steps to install the CPU heatsink and fan.

1. Place the heatsink on top of the installed CPU, making sure that the heatsink fits properly on the retention module base.



-
- The retention module base is already installed on the motherboard upon purchase.
 - You do not have to remove the retention module base when installing the CPU or installing other motherboard components.
-

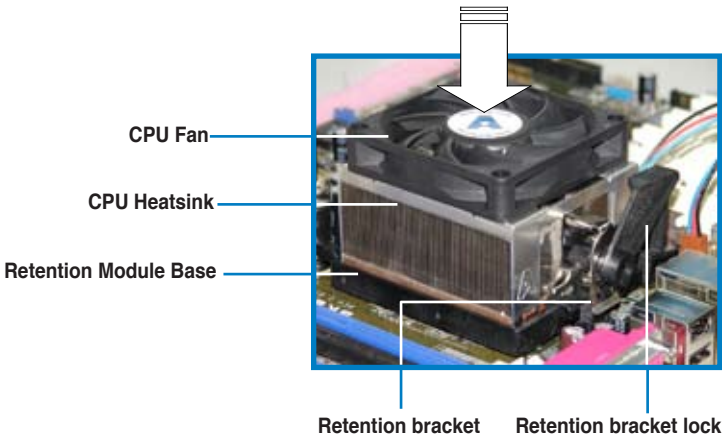

Your boxed CPU heatsink and fan assembly should come with installation instructions for the CPU, heatsink, and the retention mechanism. If the instructions in this section do not match the CPU documentation, follow the latter.

2. Attach one end of the retention bracket to the retention module base.

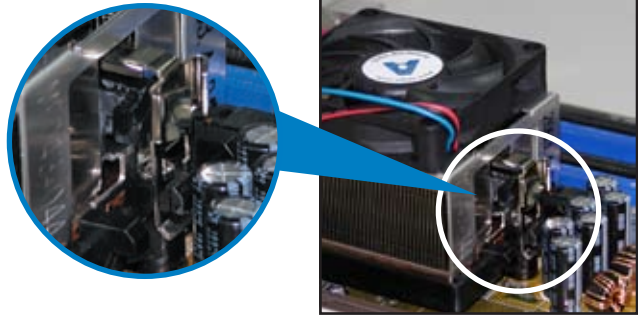

3. Align the other end of the retention bracket (near the retention bracket lock) to the retention module base. A clicking sound denotes that the retention bracket is in place.



Make sure that the fan and heatsink assembly perfectly fits the retention mechanism module base, otherwise you cannot snap the retention bracket in place.



4. Push down the retention bracket lock on the retention mechanism to secure the heatsink and fan to the module base.

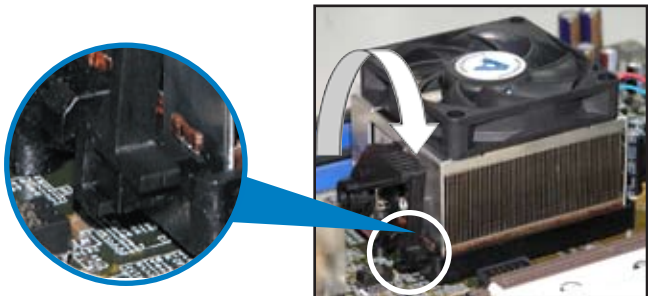

2.3.3 Connecting the CPU fan cable

When the heatsink and fan assembly is in place, connect the CPU fan cable to the connector on the motherboard labeled CPU_FAN.

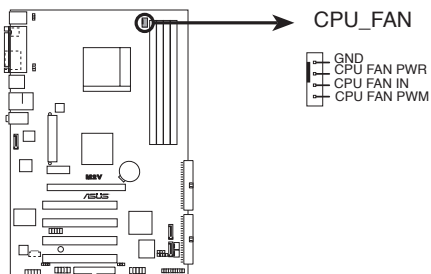

M2V CPU Fan Connector



- Do not forget to connect the CPU fan connector! CPU overheating and hardware monitoring errors may occur if you fail to plug this connector.
- This connector is also compatible with the old 3-pin CPU fan.

2.4 System memory

2.4.1 Overview

The motherboard comes with four Double Data Rate 2 (DDR2) Dual Inline Memory Modules (DIMM) sockets.

A DDR2 module has the same physical dimensions as a DDR DIMM but has a 240-pin footprint compared to the 184-pin DDR DIMM. DDR2 DIMMs are notched differently to prevent installation on a DDR DIMM socket.

The figure illustrates the location of the DDR2 DIMM sockets:

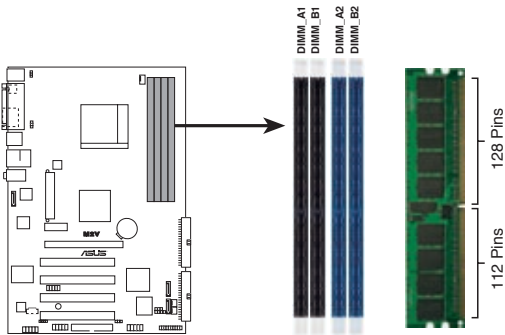

M2V 240-pin DDR2 DIMM Sockets

Channel	Sockets
Channel A	DIMM_A1 and DIMM_A2
Channel B	DIMM_B1 and DIMM_B2

2.4.2 Memory configurations

You may install 256 MB, 512 MB, 1 GB and 2GB unbuffered ECC/non-ECC DDR2 DIMMs into the DIMM sockets.



- Always install DIMMs with the same CAS latency. For optimum compatibility, we recommend that you obtain memory modules from the same vendor. Visit the ASUS website (www.asus.com) for the latest Qualified Vendors List.
- When using only one DDR DIMM module, install it into slot DIMM_A1 or DIMM_B1.
- For dual-channel memory configuration, install the DIMMs in slots DIMM_B1 and DIMM_A1 (yellow slots); install another pair of DIMMs in slots DIMM_B2 and DIMM_A2 (black slots).

Table 1 Recommended memory configurations

Mode	Sockets			
	DIMM_A1	DIMM_B1	DIMM_A2	DIMM_B2
Single-channel	—	Populated	—	—
	Populated	—	—	—
Dual-channel (1)	Populated	Populated	—	—
Dual-channel (2)*	Populated	Populated	Populated	Populated

* For dual-channel configuration (2), you may:

- install identical DIMMs in all four sockets

or

- install identical DIMM pair in DIMM_A1 and DIMM_B1 (yellow sockets)

DDR2 Qualified Vendors List

The following table lists the DDR2 800 memory modules that have been tested and qualified for use with this motherboard.

Table 2 DDR2 800 Qualified Vendors List

Size	Vendor	Model	Brand	SS/DS	Component	DIMM support		
						A*	B*	C*
512MB	KINGSTON	Heat-Sink Package	N/A	SS	KHX6400D2/512	V	V	-
1024MB	KINGSTON	K4T51083QC	N/A	DS	KVR800D2N5/1G	V	V	-
256MB	SAMSUNG	K4T56083QF-ZCE7	N/A	SS	M378T3253FZ3-CE7	V	V	V
256MB	SAMSUNG	K4T56083QF-ZCE7(ECC)	N/A	SS	M391T3253FZ3-CE7	V	V	V
512MB	SAMSUNG	EDD339XX	N/A	SS	M378T6553CZ3-CE7	V	V	V
512MB	Infineon	HYB18T256800AF25	N/A	DS	HYS64T64520HU-2.5-A	V	V	-
512MB	Infineon	HYB18T256800AF25F	N/A	DS	HYS64T64020HU-25F-A	V	V	V
512MB	Hynix	HY5PS12821BFP-S5	N/A	SS	HYMP564U64BP8-S5	V	V	V
1024MB	Hynix	HY5PS12821BFP-S5	N/A	DS	HYMP512U64BP8-S5	V	V	-
512MB	MICRON	5JAIIZ9DQQ	N/A	SS	MT8HTF6464AY-80EA3	V	V	V
1024MB	MICRON	5JAIIZ9DQQ	N/A	DS	MT16HTF12864AY-80EA3	V	V	-
512MB	MICRON	5ZD22D9GKX	N/A	SS	MT8HTF6464AY-80ED4	V	V	V
1024MB	MICRON	5ZD22D9GKX	N/A	DS	MT16HTF12864AY-80ED4	V	V	-
512MB	MICRON	6CD22D9GKX	N/A	SS	MT8HTF6464AY-80ED4	V	V	V
1024MB	MICRON	6CD22D9GKX	N/A	DS	MT16HTF12864AY-80ED4	V	V	-
512MB	CORSAIR	Heat-Sink Package	N/A	SS	CM2X512A-6400	V	V	-
1024MB	CORSAIR	Heat-Sink Package	N/A	DS	CM2X1024-6400PRO	V	V	-
1024MB	CORSAIR	Heat-Sink Package	N/A	DS	CM2X1024-6400C4	V	V	-
256MB	A-DATA	E2508AB-GE-E	N/A	SS	M20EL6F3G3170A1DOZ	V	V	-
256MB	A-DATA	E2508AB-GE-E	N/A	SS	M20EL6F3G3160A1DOZ	V	V	V
256MB	A-DATA	E2508AB-GE-E	N/A	SS	M20EL6F3G3160A1DOZ	V	V	V

A* - Supports one module inserted in DIMM_B1 (yellow) slot.

B* - Supports one pair of modules inserted into the yellow slots as one pair of Dual-channel memory configuration.

C* - Supports 4 modules inserted into both the yellow and black slots as two pairs of Dual-channel memory configuration.



Visit the ASUS website (www.asus.com) for the latest DDR2 800 Qualified Vendor List for this motherboard.

2.4.3 Installing a DIMM



Unplug the power supply before adding or removing DIMMs or other system components. Failure to do so can cause severe damage to both the motherboard and the components.

To install a DIMM:

1. Unlock a DIMM socket by pressing the retaining clips outward.
2. Align a DIMM on the socket such that the notch on the DIMM matches the break on the socket.
3. Firmly insert the DIMM into the socket until the retaining clips snap back in place and the DIMM is properly seated.

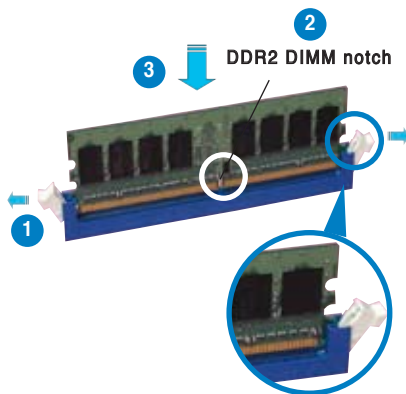

Unlocked retaining clip



- A DDR2 DIMM is keyed with a notch so that it fits in only one direction. Do not force a DIMM into a socket to avoid damaging the DIMM.
- The DDR2 DIMM sockets do not support DDR DIMMs. DO not install DDR DIMMs to the DDR2 DIMM sockets.

2.4.4 Removing a DIMM

To remove a DIMM:

1. Simultaneously press the retaining clips outward to unlock the DIMM.



Support the DIMM lightly with your fingers when pressing the retaining clips. The DIMM might get damaged when it flips out with extra force.

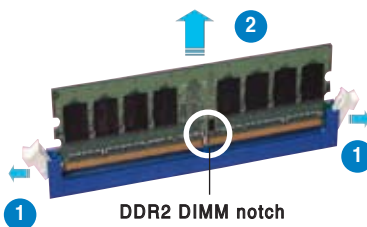

2. Remove the DIMM from the socket.

2.5 Expansion slots

In the future, you may need to install expansion cards. The motherboard has available PCI slots, PCI Express x1 slot and PCI Express x16 slot. The following sub-sections describe the slots and the expansion cards that they support.



Make sure to unplug the power cord before adding or removing expansion cards. Failure to do so may cause you physical injury and damage motherboard components.

2.5.1 Installing an expansion card

Follow these steps to install an expansion card.

1. Read the documentation that came with the expansion card and make the necessary hardware settings for the card.
2. Remove the system unit cover (if your motherboard is already installed in a chassis).
3. Remove the bracket opposite the slot that you intend to use. Keep the screw for later use.
4. Align the card connector with the slot and press firmly until the card is completely seated on the slot.
5. Secure the card to the chassis with screws.
6. Replace the system cover.

2.5.2 Configuring an expansion card

After installing the expansion card, configure the card by adjusting the software settings.

1. Turn on the system and change the necessary BIOS settings, if any. See Chapter 4 for information on BIOS setup.
2. Assign an IRQ to the card. Refer to the tables on the next page.
3. Install the software drivers for the expansion card.

2.5.3 Interrupt assignments

Standard Interrupt Assignments

IRQ	Priority	Standard Function
0	1	System Timer
1	2	Keyboard Controller
2	N/A	Programmable Interrupt
3*	11	IRQ Holder for PCI Steering
4*	12	Communications Port (COM1)
5*	13	Sound Card (sometimes LPT2)
6	14	Floppy Disk Controller
7*	15	Printer Port (LPT1)
8	3	System CMOS/Real Time Clock
9*	4	ACPI Mode when used
10*	5	IRQ Holder for PCI Steering
11*	6	IRQ Holder for PCI Steering
12*	7	PS/2 Compatible Mouse Port
13	8	Numeric Data Processor
14*	9	Primary IDE Channel
15*	10	Secondary IDE Channel

* These IRQs are usually available for ISA or PCI devices.

IRQ assignments for this motherboard

	A	B	C	D	E	F	G	H
PCI slot 1	shared	—	—	—	—	—	—	—
PCI slot 2	—	shared	—	—	—	—	—	—
PCI slot 3	—	—	shared	—	—	—	—	—
PCI slot 4	—	—	—	shared	—	—	—	—
PCI Express x1	—	—	—	—	—	—	—	shared
PCI Express x16	—	—	—	—	—	—	—	shared
Gigabit LAN	—	—	—	—	—	—	—	shared
Marvell 6121 SATA	—	—	—	—	—	—	—	shared
SATA	—	shared	—	—	—	—	—	—
USB1	shared	—	—	—	—	—	—	—
USB2	—	shared	—	—	—	—	—	—
USB3	—	—	shared	—	—	—	—	—
USB4	—	—	—	shared	—	—	—	—
HD audio	—	shared	—	—	—	—	—	—



When using PCI cards on shared slots, ensure that the drivers support “Share IRQ” or that the cards do not need IRQ assignments. Otherwise, conflicts will arise between the two PCI groups, making the system unstable and the card inoperable.

2.5.4 PCI slots

The PCI slots support PCI cards such as a LAN card, SCSI card, USB card, and other cards that comply with PCI specifications. The following figure shows a LAN card installed on a PCI slot.

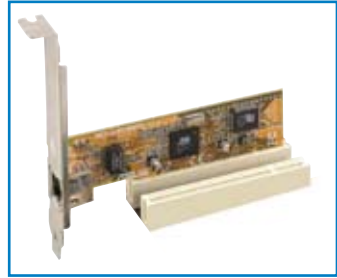

2.5.5 PCI Express x1 slot

This motherboard supports PCI Express x1 network cards, SCSI cards and other cards that comply with the PCI Express specifications. The figure below shows a network card installed on the PCI Express x1 slot.



2.5.6 PCI Express x16 slot

This motherboard supports PCI Express x16 graphic cards that comply with the PCI Express specifications. The figure shows a graphics card installed on the PCI Express x16 slot.



2.6 Jumpers

1. Clear RTC RAM (CLRTC)

This jumper allows you to clear the Real Time Clock (RTC) RAM in CMOS. You can clear the CMOS memory of date, time, and system setup parameters by erasing the CMOS RTC RAM data. The RAM data in CMOS, that include system setup information such as system passwords, is powered by the onboard button cell battery.

To erase the RTC RAM:

1. Turn OFF the computer and unplug the power cord.
2. Remove the onboard battery.
3. Move the jumper from pins 1-2 (default) to pins 2-3. Keep the cap on pins 2-3 for about 5~10 seconds, then move the cap back to pins 1-2.
4. Replace the battery.
5. Plug the power cord and turn ON the computer.
6. Hold down the key during the boot process and enter BIOS setup menu.
7. Load the BIOS default settings or key-in data.

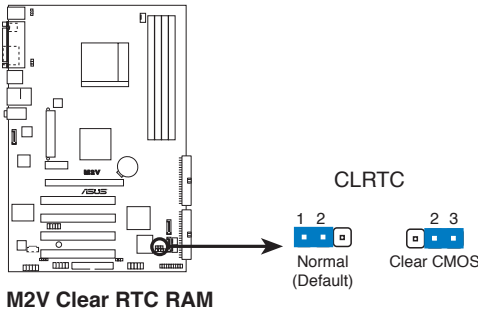

You do not need to clear the RTC when the system hands due to overclocking. For system failure due to overclocking, use the C.P.R. (CPU Parameter Recall) feature. Shut down and reboot the system so the BIOS can automatically reset the parameter settings to the default values.

2. Keyboard power (3-pin KBPWR)

This jumper allows you to enable or disable the keyboard wake-up feature. Set this jumper to pins 2-3 (+5VSB) if you wish to wake up the computer when you press a key on the keyboard. This feature requires an ATX power supply that can supply at least 1A on the +5VSB lead, and a corresponding setting in the BIOS .

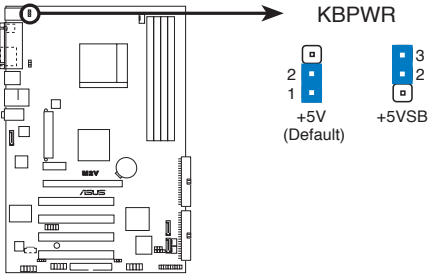

M2V Keyboard Power Setting

3. USB device wake-up (3-pin USBPW1, USBPW2)

Set these jumpers to +5V to wake up the computer from S1 sleep mode (CPU stopped, DRAM refreshed, system running in low power mode) using the connected USB devices. Set to +5VSB to wake up from S3 and S4 sleep modes (no power to CPU, DRAM in slow refresh, power supply in reduced power mode).

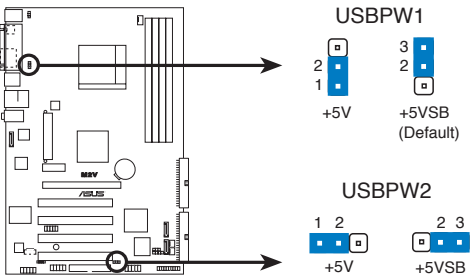

M2V USB Device Wake-Up



- The USB device wake-up feature requires a power supply that can provide 500mA on the +5VSB lead for each USB port. Otherwise, the system would not power up.
- The total current consumed must NOT exceed the power supply capability (+5VSB) whether under normal condition or in sleep mode.

2.7 Connectors

2.7.1 Rear panel connectors

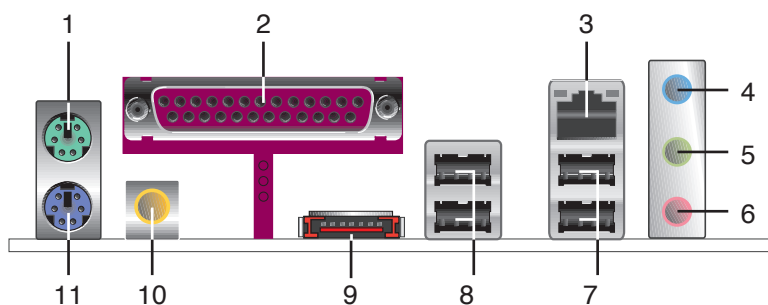

1. **PS/2 mouse port.** This green 6-pin connector is for a PS/2 mouse.
2. **Parallel port.** This 25-pin port connects a parallel printer, a scanner, or other devices.
3. **RJ-45 port.** This port allows connection to a Local Area Network (LAN) through a network hub.



The left LED is blinking in half duplex mode.

4. **Line-In port.** This Line In (light blue) port connects a tape player or other audio sources.
5. **Line-Out port.** This Line Out (lime) port connects a headphone or a speaker. In 4-channel and 6-channel mode, the function of this jack becomes Front Speaker Out.
6. **Microphone port.** This Mic (pink) port connects a microphone.

Audio 2, 4, or 6-channel configuration

	Headset/ 2-Speaker	4-Speaker	6-Speaker
Light Blue	Line In	Line In	Bass/Center
Lime	Line Out	Front Speaker Out	Front Speaker Out
Pink	Mic In	Rear Speaker Out	Rear Speaker Out

7. **USB 2.0 ports 3 and 4.** These two 4-pin Universal Serial Bus (USB) ports are available for connecting USB 2.0 devices.
8. **USB 2.0 ports 1 and 2.** These two 4-pin Universal Serial Bus (USB) ports are available for connecting USB 2.0 devices.
9. **External Serial ATA 3Gb/s port.** This port connects to an external SATA box or a Serial ATA port multiplier.



The external SATA port supports external Serial ATA 1.5Gb/s and 3Gb/s devices. Longer cables support higher power requirements to deliver signal up to two meters away, and enables improved hot-swap function.



Do not insert a different connector to this port.

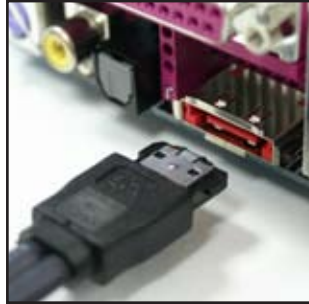

10. **S/PDIF coaxial out port.** This port connects to external audio output devices with coaxial cable connectors.
11. **PS/2 keyboard port.** This purple connector is for a PS/2 keyboard.

2.7.2 Internal connectors

1. IDE connector (40-1 pin PRI_IDE)

The onboard IDE connector is for the Ultra DMA 133/100/66 signal cable. There are three connectors on each Ultra DMA 133/100/66 signal cable: blue, black, and gray. Connect the blue connector to the motherboard's IDE connector, then select one of the following modes to configure your device.

	Drive jumper setting	Mode of device(s)	Cable connector
Single device	Cable-Select or Master	-	Black
Two devices	Cable-Select	Master	Black
		Slave	Gray
	Master	Master	Black or gray
	Slave	Slave	



- Pin 20 on the IDE connector is removed to match the covered hole on the Ultra DMA cable connector. This prevents incorrect insertion when you connect the IDE cable.
- Use the 80-conductor IDE cable for Ultra DMA 100/66 IDE devices.



If any device jumper is set as "Cable-Select," make sure all other device jumpers have the same setting.

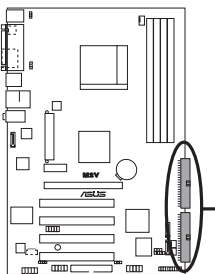

M2V IDE Connectors

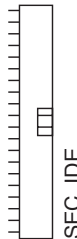
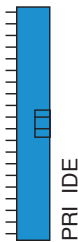

NOTE: Orient the red markings (usually zigzag) on the IDE ribbon cable to PIN 1.

2. Floppy disk drive connector (34-1 pin FLOPPY)

This connector supports the provided floppy drive ribbon cable. After connecting one end to the motherboard, connect the other end to the floppy drive. (Pin 5 is removed to prevent incorrect insertion when using ribbon cables with pin 5 plug).

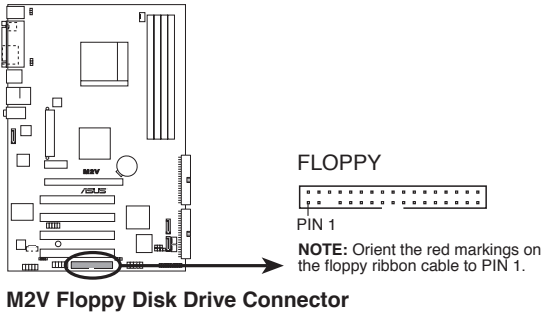

3. Serial ATA connectors (7-pin SATA1, SATA2)

These connectors support the thin Serial ATA cables for primary internal storage devices. The current Serial ATA interface allows up to 150 MB/s data transfer rate, faster than the standard parallel ATA with 133 MB/s (UltraDMA133).

You can configure a RAID 0, RAID 1, or JBOD set using these connectors.

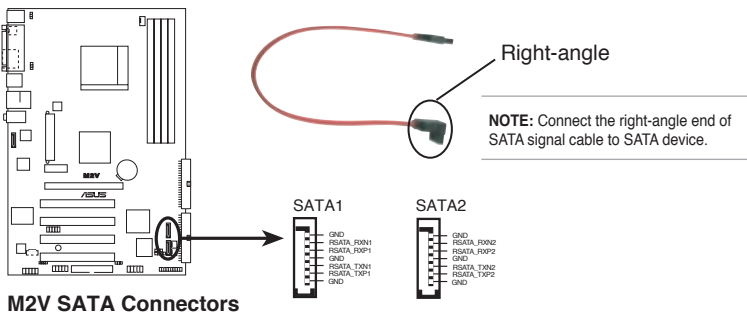



Important notes on Serial ATA solution:

- The Serial ATA cable is smaller and more flexible, allowing easier routing inside the chassis. The lower pin count of the Serial ATA cable eliminates the problem caused by the wide, flat ribbon cables of the Parallel ATA interface.
 - Hot plug support for Serial ATA drive and connections is not available on this motherboard.
 - Install Windows® XP Service Pack 1 or later versions when using Serial ATA drives.
-

4. Marvell® 88SE6121 Serial ATA connector (7-pin SATA_RAID1)

This connector is for a Serial ATA signal cable. This connector supports a Serial ATA 3.0 Gb/s hard disk drive.



The Marvell® 88SE6121 controller allows you to enable the hot-plug function for external device.



Do not install the operating system with the device connected to the Marvell® 88SE6121 Serial ATA connector.

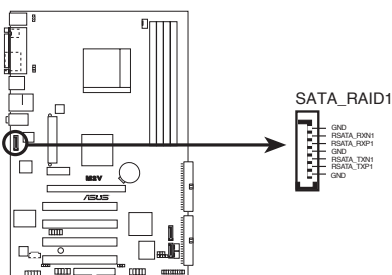

M2V SATA RAID Connector

5. CPU, Power and Chassis Fan Connectors (4-pin CPU_FAN, 3-pin CHA_FAN1, 3-pin CHA_FAN2)

The fan connectors support cooling fans of 350mA~740mA (8.88W max.) or a total of 1A~2.22A (26.64W max.) at +12V. Connect the fan cables to the fan connectors on the motherboard, making sure that the black wire of each cable matches the ground pin of the connector.



Do not forget to connect the fan cables to the fan connectors. Lack of sufficient air flow within the system may damage the motherboard components. These are not jumpers! DO NOT place jumper caps on the fan connectors!

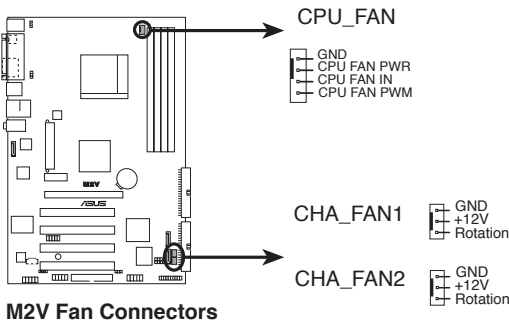

6. Internal audio connectors (4-pin CD)

These connectors allow you to receive stereo audio input from sound sources such as a CD-ROM, TV tuner, or MPEG card.

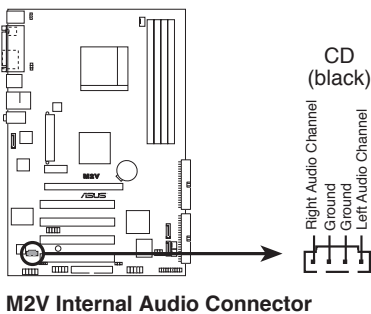

7. ATX power connectors (24-pin ATXPWR, 4-pin ATX12V)

These connectors are for ATX 12V power supply. The plugs from the power supply are designed to fit these connectors in only one orientation. Find the proper orientation and push down firmly until the connectors completely fit.

In addition to the 24-pin ATX power connector, this motherboard requires that you connect the 4-pin ATX +12V power plug to provide sufficient power to the CPU.



- Do not forget to connect the 4-pin ATX +12V power plug. Otherwise, the system does not boot up.
- Make sure that your ATX 12V power supply can provide 8A on the +12V lead and at least 1A on the +5-volt standby lead (+5VSB). The minimum recommended wattage is 300W, or 350W for a fully configured system. The system may become unstable or might not boot up, if the power is inadequate.

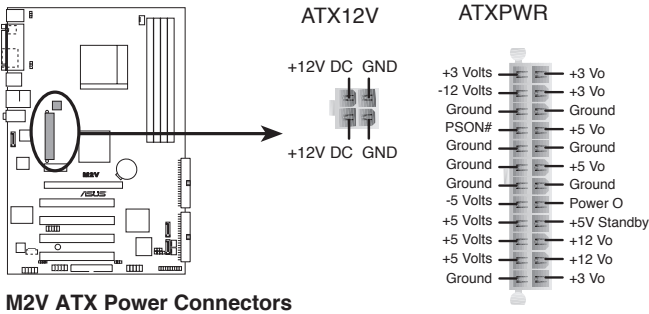

8. USB headers (10-1 pin USB56, USB78)

If the USB ports on the rear panel are inadequate, a USB header is available for additional USB ports. The USB header complies with USB 2.0 specification that supports up to 480 Mbps connection speed. This speed advantage over the conventional 12 Mbps on USB 1.1 allows faster Internet connection, interactive gaming, and simultaneous running of high-speed peripherals.

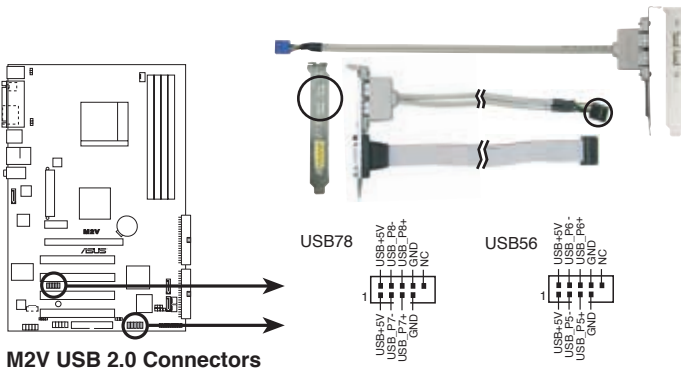

- NEVER connect a **1394 cable** to any of the USB (blue) connectors. Doing so will damage the motherboard!
- You may connect the USB cable to ASUS Q-Connector(Blue, USB) first, and then install the Q-Connector(USB) to the USB connector onboard.
- The picture above is for your reference, you need to purchase the cables separately.

9. Front panel audio connector (10-1 pin FP_AUDIO)

This is an interface for the front panel audio cable that allows convenient connection and control of audio devices.

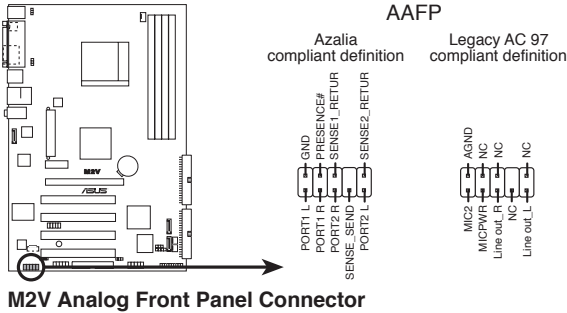

10. System panel connector (20-pin PANEL)

This connector accommodates several system front panel functions.

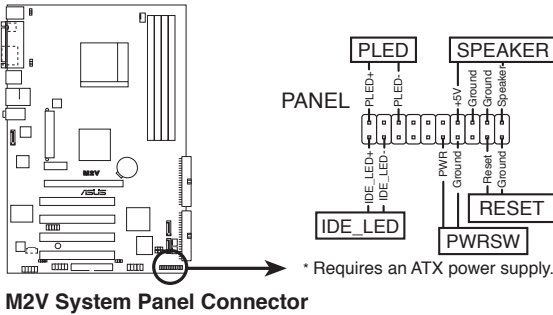

The System Panel connector is color-coded for easy and foolproof connection. Take note of the specific connector colors as described.

- **System Power LED Lead (3-1 pin PLED)**

This 3-1 pin connector connects to the system power LED. The LED lights up when you turn on the system power, and blinks when the system is in sleep mode.

- **System Warning Speaker Lead (4-pin SPEAKER)**

This 4-pin connector is for the case-mounted speaker. It allows you to hear system beeps and warnings.

- **Reset Switch Lead (2-pin RESET)**

This 2-pin connector is for the case-mounted reset switch to reboot the system without turning off the system power.

- **ATX Power Switch / Soft-Off Switch Lead (2-pin PWRSW)**

This connector is for the system power switch. Pressing the power switch turns the system between ON and SLEEP, or ON and SOFT OFF, depending on the BIOS or OS settings. Pressing the power switch while in the ON mode for more than four seconds turns the system OFF.

- **Hard disk activity LED (2-pin IDE_LED)**

This connector supplies power to the hard disk activity LED. Any read or write activity of an IDE device causes this LED to light up.

Q-Connector (System panel)

ASUS Q-Connector allows you to easily to connect the chassis front panel cables to the motherboard. Perform these steps to install ASUS Q-Connector.

Step 1

Connect the front panel cables to their respective connectors on the ASUS Q-Connector. Refer to the labels on the Q-Connector for proper connection and pin definition.



Step 2

Carefully connect the ASUS Q-Connector to the System panel connector.



The ASUS Q-Connector fits only in one orientation; if it doesn't fit, try reversing it.

Chapter 3

This chapter describes the power up sequence, the vocal POST messages and ways of shutting down the system.

Powering up

Chapter summary

- 3.1 Starting up for the first time3-1**
- 3.2 Powering off the computer3-2**

3.1 Starting up for the first time

1. After making all the connections, replace the system case cover.
2. Make sure that all switches are off.
3. Connect the power cord to the power connector at the back of the system chassis.
4. Connect the power cord to a power outlet that is equipped with a surge protector.
5. Turn on the devices in the following order:
 - a. Monitor
 - b. External SCSI devices (starting with the last device on the chain)
 - c. System power (if you are using an ATX power supply, you need to switch on the power supply as well as press the ATX power switch on the front of the chassis).
6. After applying power, the power LED on the system front panel case lights up. For ATX power supplies, the system LED lights up when you press the ATX power switch. If your monitor complies with “green” standards or if it has a “power standby” feature, the monitor LED may light up or switch between orange and green after the system LED turns on. The system then runs the power-on tests. While the tests are running, the BIOS beeps or additional messages appear on the screen. If you do not see anything within 30 seconds from the time you turned on the power, the system may have failed a power-on test. Check the jumper settings and connections or call your retailer for assistance.
7. At power on, hold down to enter BIOS Setup. Follow the instructions in Chapter 4.

3.2 Powering off the computer

3.2.1 Using the OS shut down function

If you are using Windows® 2000/XP:

1. Click the **Start** button then click **Shut Down...**
2. Make sure that the **Shut down** option button is selected, then click the **OK** button to shut down the computer.
3. The power supply should turn off after Windows® shuts down.

If you are using Windows® XP:

1. Click the **Start** button then select **Turn Off Computer**.
2. Click the **Turn Off** button to shut down the computer.
3. The power supply should turn off after Windows® shuts down.

3.2.2 Using the dual-function power switch

While the system is ON, pressing the power switch for less than four seconds puts the system to sleep mode or to soft-off mode, depending on the BIOS setting. If you press the power switch for more than four seconds, the system enters the soft-off mode regardless of the BIOS setting. See section “4.5 Power Menu” in Chapter 4.

Chapter 4

This chapter tells how to change the system settings through the BIOS Setup menus. Detailed descriptions of the BIOS parameters are also provided.

BIOS setup

Chapter summary

4.1	Managing and updating your BIOS	4-1
4.2	BIOS Setup program	4-9
4.3	Main menu.....	4-12
4.4	Advanced menu.....	4-15
4.5	Power menu	4-25
4.6	Boot menu.....	4-29
4.7	Tools menu	4-34
4.8	Exit menu	4-35

4.1 Managing and updating your BIOS

The following utilities allow you to manage and update the motherboard Basic Input/Output System (BIOS) setup.

1. **ASUS AFUDOS** - Updates the BIOS using a bootable floppy disk in DOS mode.
2. **ASUS EZ Flash** - Updates the BIOS using a floppy disk during POST.
3. **ASUS CrashFree BIOS 3** - Updates the BIOS using a bootable floppy disk or the motherboard support CD.
4. **ASUS Update** - Updates the BIOS in a Windows® environment.

Refer to the corresponding sections for details on these utilities.

Important notes



- Save a copy of the original motherboard BIOS file to a bootable floppy disk in case you need to restore the BIOS in the future. Copy the original motherboard BIOS using the AFUDOS utility.
- Visit the ASUS website (www.asus.com) and download the latest BIOS file for this motherboard using the ASUS Update utility.

4.1.1 Creating a bootable floppy disk

1. Do either one of the following to create a bootable floppy disk.

DOS environment

Insert a 1.44 MB floppy disk into the drive. At the DOS prompt, type:

```
format A:/S then press <Enter>.
```

Windows® 2000/XP environment

- a. Insert a 1.44 MB floppy disk into the floppy disk drive.
- b. From your Windows desktop, click on **Start**, then select **My Computer**.
- c. Select the **3 1/2 Floppy Drive** icon.
- d. Click **File** from the menu, then select **Format**. A **Format 3 1/2 Floppy Disk** window appears.
- e. If you are using Windows® XP, select **Create an MS-DOS startup disk** from the format options field, then click **Start**.

OR

If you are using Windows® 2000, select **Full** option button from the format type, then click **Start**.

2. Copy the original (or the latest) motherboard BIOS to the bootable floppy disk.

4.1.2 Using AFUDOS to update the BIOS

To update the BIOS using the AFUDOS.EXE utility:

1. Visit the ASUS website to download the latest BIOS file for your motherboard. Save the BIOS file to a bootable floppy disk.



Write the BIOS file name on a piece of paper. You need to type the exact BIOS file name at the prompt.

2. Copy the AFUDOS.EXE utility from the support CD to the bootable floppy disk that contains the BIOS file.
3. Boot the system from the floppy disk.
4. At the DOS prompt, type the command line:

```
afudos /i[filename]
```

where [filename] means the latest (or original) BIOS file that you copied to the bootable floppy disk.

5. Press <Enter>. The succeeding screen displays the status of the update process.



The BIOS information on the screen is for reference only. What you see on your screen may not be exactly the same as shown.

```
A:\>afudos /iM2V.ROM
AMI Firmware Update Utility - Version 1.10
Copyright (C) 2002 American Megatrends, Inc. All rights reserved.

Reading file .... done
Erasing flash .... done
Writing flash .... 0x0008CC00 (9%)
```



DO NOT shut down or reset the system while updating the BIOS!
Doing so can cause system boot failure!

When the BIOS update process is complete, the utility returns to the DOS prompt.

```
A:\>afudos /iM2V.ROM
AMI Firmware Update Utility - Version 1.10
Copyright (C) 2002 American Megatrends, Inc. All rights reserved.

Reading file ..... done
Erasing flash .... done
Writing flash ... 0x0008CC00 (9%)
Verifying flash .. done

A:\>
```

6. Reboot the system from the hard disk.

4.1.3 Using AFUDOS to copy BIOS from PC

You can use the AFUDOS.EXE utility to copy the current system BIOS to a floppy or hard disk and use it as a backup in case the system BIOS fails or gets corrupted.

To copy the BIOS from your PC using AFUDOS.EXE:

1. At the DOS prompt, type the command line:

```
afudos /o[filename]
```

where [filename] string of not more than eight (8) alpha-numeric characters for the main filename and three (3) alpha-numeric characters for the extension name.

2. Press <Enter>.



The BIOS information on the screen is for reference only. What you see on your screen might not be exactly the same as shown.

Main filename
Extension name

```
A:\>afudos /oMYBIOS03.ROM
AMI Firmware Update Utility - Version 1.10
Copyright (C) 2002 American Megatrends, Inc. All rights reserved.

Reading flash ..... 0x0008CC00 (9%)
```

3. The utility will copy the current system BIOS by default to the floppy disk. Make sure that the floppy disk has at least 600KB of free disk space and is not write-protected.

```
A:\>afudos /oMYBIOS03.com
AMI Firmware Update Utility - Version 1.10
Copyright (C) 2002 American Megatrends, Inc. All rights reserved.

Reading flash ..... done

A:\>
```

When the copy process is complete, the utility returns to the DOS prompt.

4.1.4 Using ASUS EZ Flash to update the BIOS

The ASUS EZ Flash feature allows you to easily update the BIOS without having to go through the long process of booting from a diskette and using a DOS-based utility. The EZ Flash is built-in to the BIOS firmware so it is accessible by simply pressing <Alt + F2> during the Power-On Self Tests (POST).

To update the BIOS using ASUS EZ Flash:

1. Visit the ASUS website (www.asus.com) to download the latest BIOS file for your motherboard and rename the downloaded file as **M2V.ROM**. Save the BIOS file to a floppy disk.
2. Reboot the system.
3. To launch EZ Flash, press <Alt+F2> during POST to display the following.

```
User recovery requested. Starting BIOS recovery...
Checking for floppy...
```



- If there is no floppy disk in the drive, the error message “Floppy not found!” appears.
- If the correct BIOS file is not in the floppy disk, the error message “Floppy not found!” is displayed. Make sure to rename the downloaded BIOS file as “M2V.ROM”.

4. Insert the floppy disk that contains the BIOS file. If all the necessary files are found in the floppy disk, EZ Flash performs the BIOS update process and automatically reboots the system when done.



DO NOT shut down or reset the system while updating the BIOS!
Doing so can cause system boot failure!

```
User recovery requested. Starting BIOS recovery...  
  
Checking for floppy...  
  
Floppy found!  
  
Reading file "M2V.ROM". Completed.  
  
Start flashing...  
  
Flashed successfully. Rebooting.
```

4.1.5 ASUS CrashFree BIOS 3 utility

The ASUS CrashFree BIOS 3 is an auto recovery tool that allows you to restore the BIOS file when it fails or gets corrupted during the updating process. You can update a corrupted BIOS file using the motherboard support CD or the floppy disk that contains the updated BIOS file.



Prepare the motherboard support CD or the floppy disk containing the updated motherboard BIOS before using this utility.

Recovering the BIOS from the support CD

To recover the BIOS from the support CD:

1. Turn on the system.
2. Insert the motherboard support CD to the optical drive.
3. The utility displays the following message and automatically checks the CD for the BIOS file.

```
Award BootBlock BIOS v1.0  
Copyright (c) 2000, Award Software, Inc.  
BIOS ROM checksum error  
Detecting IDE ATAPI device...
```

When found, the utility reads the BIOS file and starts flashing the corrupted BIOS file.

```
Award BootBlock BIOS v1.0
Copyright (c) 2000, Award Software, Inc.
BIOS ROM checksum error
Detecting IDE ATAPI device...
Found CDROM, try to Boot from it... Pass
```

4. Restart the system after the utility completes the updating process.

Recovering the BIOS from the USB flash disk

To recover the BIOS from the USB flash disk:

1. Insert the USB flash disk that contains BIOS file to the USB port.
2. Turn on the system.
3. The utility will automatically checks the devices for the BIOS file When found, the utility reads the BIOS file and starts flashing the corrupted BIOS file.
4. Restart the system after the utility completes the updating process.



-
- Use only a USB flash disk smaller than 8GB with single partition and FAT 32/16/12 format.
 - DO NOT shut down or reset the system while updating the BIOS! Doing so can cause system boot failure!
-

4.1.6 ASUS Update

The ASUS Update is a utility that allows you to update the motherboard BIOS in Windows® environment. This utility is available in the support CD that comes with the motherboard package. ASUS Update requires an Internet connection either through a network or an Internet Service Provider (ISP).

To install ASUS Update:

1. Insert the support CD into the CD-ROM drive. The **Drivers** menu appears.
2. Click the **Utilities** tab, then click **Install ASUS Update VX.XX.XX**. See page 5-3 for the **Utilities** menu screen.
3. The ASUS Update utility is copied into your system.

To update the BIOS using ASUS Update:

1. Launch the utility from the Windows desktop by clicking **Start > Programs > ASUS > ASUSUpdate > ASUSUpdate**. The ASUS Update initial screen appears.
2. Select your desired update method, then click **Next**.



3. If you select updating/ downloading from the Internet, select the ASUS FTP site nearest you to avoid network traffic, or choose **Auto Select**. Click **Next**.



4. From the FTP site, select the BIOS version that you wish to download. Click **Next**.
5. Follow the instructions on the succeeding screens to complete the update process.



6. If you select the option to update the BIOS from a file, a window prompts you to locate the file. Select the file, click **Open**, then follow the screen instructions to complete the update process.



4.2 BIOS Setup program

This motherboard supports a programmable firmware chip that you can update using the provided utility described in section “4.1 Managing and updating your BIOS.”

Use the BIOS Setup program when you are installing a motherboard, reconfiguring your system, or prompted to “Run Setup”. This section explains how to configure your system using this utility.

Even if you are not prompted to use the Setup program, you may want to change the configuration of your computer in the future. For example, you may want to enable the security password feature or change the power management settings. This requires you to reconfigure your system using the BIOS Setup program so that the computer can recognize these changes and record them in the CMOS RAM of the firmware hub.

The firmware hub on the motherboard stores the Setup utility. When you start up the computer, the system provides you with the opportunity to run this program. Press during the Power-On Self Test (POST) to enter the Setup utility. Otherwise, POST continues with its test routines.

If you wish to enter Setup after POST, restart the system by pressing <Ctrl>+<Alt>+<Delete>, or by pressing the reset button on the system chassis. You can also restart by turning the system off and then back on. Do this last option only if the first two failed.

The Setup program is designed to make it as easy to use as possible. As a menu-driven program, it lets you scroll through the various sub-menus and make your selections from the available options using the navigation keys.



The default BIOS settings for this motherboard apply for most conditions to ensure optimum performance. If the system becomes unstable after changing any BIOS settings, load the default settings to ensure system compatibility and stability. Select the **Load Default Settings** item under the Exit Menu. See section “4.7 Exit Menu.”



- The BIOS setup screens shown in this chapter are for reference purposes only, and may not exactly match what you see on your screen.
 - Visit the ASUS website (www.asus.com) to download the latest product and BIOS information.
-

4.2.1 BIOS menu screen

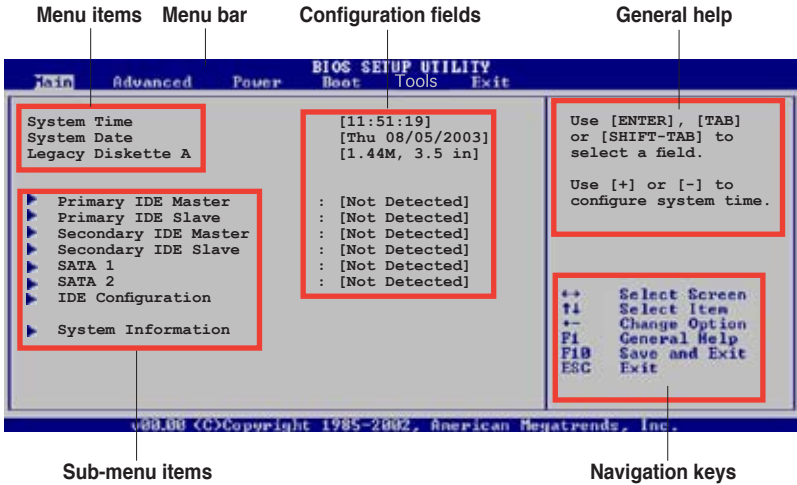

4.2.2 Menu bar

The menu bar on top of the screen has the following main items:

- Main** For changing the basic system configuration
- Advanced** For changing the advanced system settings
- Power** For changing the advanced power management (APM) configuration
- Boot** For changing the system boot configuration
- Exit** For selecting the exit options and loading default settings

To select an item on the menu bar, press the right or left arrow key on the keyboard until the desired item is highlighted.

4.2.3 Navigation keys

At the **bottom right corner** of a menu screen are the navigation keys for that particular menu. Use the navigation keys to select items in the menu and change the settings.



Some of the navigation keys differ from one screen to another.

4.2.4 Menu items

The highlighted item on the menu bar displays the specific items for that menu. For example, selecting **Main** shows the Main menu items.



Main menu items

The other items (Advanced, Power, Boot, and Exit) on the menu bar have their respective menu items.

4.2.5 Sub-menu items

An item with a sub-menu on any menu screen is distinguished by a solid triangle before the item. To display the sub-menu, select the item and press <Enter>.

4.2.6 Configuration fields

These fields show the values for the menu items. If an item is user-configurable, you may change the value of the field opposite the item. You can not select an item that is not user-configurable.

A configurable field is enclosed in brackets, and is highlighted when selected. To change the value of a field, select it then press <Enter> to display a list of options. Refer to “4.2.7 Pop-up window.”

4.2.7 Pop-up window

Select a menu item then press <Enter> to display a pop-up window with the configuration options for that item.

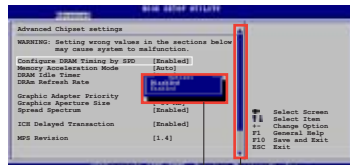

Pop-up window

Scroll bar

4.2.8 Scroll bar

A scroll bar appears on the right side of a menu screen when there are items that do not fit on the screen. Press **Up/Down arrow keys** or **PageUp/ PageDown keys** to display the other items on the screen.

4.2.9 General help

At the top right corner of the menu screen is a brief description of the selected item.

4.3 Main menu

When you enter the BIOS Setup program, the Main menu screen appears, giving you an overview of the basic system information.



Refer to section “4.2.1 BIOS menu screen” for information on the menu screen items and how to navigate through them.



4.3.1 System Time [xx:xx:xxxx]

Allows you to set the system time.

4.3.2 System Date [Day xx/xx/xxxx]

Allows you to set the system date.

4.3.3 Legacy Diskette A [1.44M, 3.5 in.]

Sets the type of floppy drive installed.

Configuration options: [Disabled] [360K, 5.25 in.] [1.2M , 5.25 in.] [720K, 3.5 in.] [1.44M, 3.5 in.] [2.88M, 3.5 in.]

4.3.4 Primary and Secondary IDE Master/Slave

While entering Setup, BIOS auto-detects the presence of IDE devices. There is a separate sub-menu for each IDE device. Select a device item then press <Enter> to display the IDE device information.



The values opposite the dimmed items (Device, Vendor, Size, LBA Mode, Block Mode, PIO Mode, Async DMA, Ultra DMA, and SMART monitoring) are auto-detected by BIOS and are not user-configurable. These items show N/A if no IDE device is installed in the system.

Type [Auto]

Selects the type of IDE drive. Setting to Auto allows automatic selection of the appropriate IDE device type. Select CDROM if you are specifically configuring a CD-ROM drive. Select ARMD (ATAPI Removable Media Device) if your device is either a ZIP, LS-120, or MO drive. Configuration options: [Not Installed] [Auto] [CDROM] [ARMD]

LBA/Large Mode [Auto]

Enables or disables the LBA mode. Setting to Auto enables the LBA mode if the device supports this mode, and if the device was not previously formatted with LBA mode disabled. Configuration options: [Disabled] [Auto]

Block (Multi-sector Transfer) [Auto]

Enables or disables data multi-sectors transfers. When set to Auto, the data transfer from and to the device occurs multiple sectors at a time if the device supports multi-sector transfer feature. When set to Disabled, the data transfer from and to the device occurs one sector at a time. Configuration options: [Disabled] [Auto]

PIO Mode [Auto]

Selects the PIO mode. Configuration options: [Auto] [0] [1] [2] [3] [4]

DMA Mode [Auto]

Selects the DMA mode. Configuration options: [Auto] [SWDMA0] [SWDMA1] [SWDMA2] [MWDMA0] [MWDMA1] [MWDMA2] [UDMA0] [UDMA1] [UDMA2] [UDMA3] [UDMA4] [UDMA5]

SMART Monitoring [Auto]

Sets the Smart Monitoring, Analysis, and Reporting Technology. Configuration options: [Auto] [Disabled] [Enabled]

32Bit Data Transfer [Disabled]

Enables or disables 32-bit data transfer. Configuration options: [Disabled] [Enabled]

4.3.5 System Information

This menu gives you an overview of the general system specifications. The items in this menu are auto-detected by BIOS.

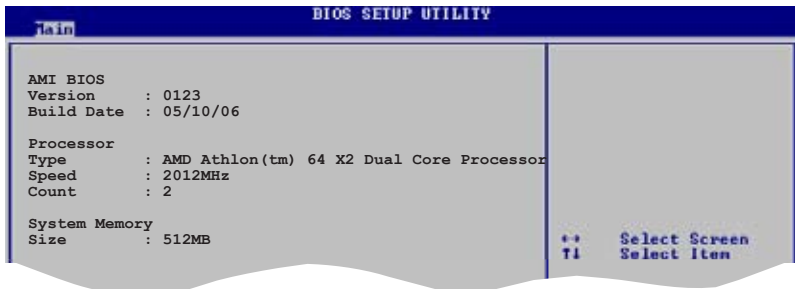

AMI BIOS

Displays the auto-detected BIOS information.

Processor

Displays the auto-detected processor information.

System Memory

Displays the auto-detected system memory.

4.4 Advanced menu

The Advanced menu items allow you to change the settings for the CPU and other system devices.



Take caution when changing the settings of the Advanced menu items. Incorrect field values can cause the system to malfunction.



4.4.1 JumperFree Configuration

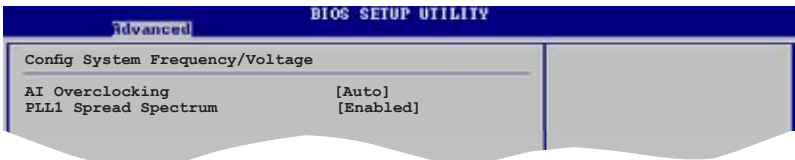

AI Overclocking [Auto]

Allows selection of CPU overclocking options to achieve desired CPU internal frequency. Select either one of the preset overclocking configuration options:

Manual - allows you to individually set overclocking parameters.

Auto - loads the optimal settings for the system.

Standard - loads the standard settings for the system.

Overclock Profile - loads overclocking profiles with optimal parameters for stability when overclocking.



The following item appears only when the AI Overclocking item is set to [Manual].

FSB Frequency [200]

The valid input value is from 200 to 400.

PLL1 Spread Spectrum [Enabled]

Allows you to enable or disable the PLL1 Spread Spectrum.

Configuration options: [Enabled] [Disabled]

DDR Voltage [1.90V]

Sets the DDR Voltage. Configuration options: [1.80V] [1.85V] [1.90V] [1.95V]

4.4.2 USB Configuration

The items in this menu allows you to change the USB-related features. Select an item then press <Enter> to display the configuration options.

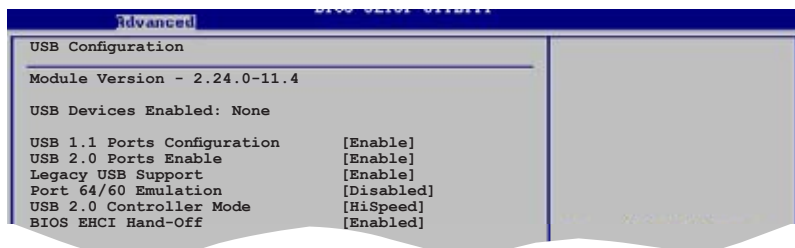

The Module Version and USB Devices Enabled items show the auto-detected values. If no USB device is detected, the item shows None.

USB 1.1 Ports Configuration [Enable]

Allows you to configure the USB 1.1 ports.

Configuration options: [Disabled] [Enable]

USB 2.0 Ports Enable [Enable]

Allows you to enable or disable the USB 2.0 ports.

Configuration options: [Disabled] [Enable]

Legacy USB Support [Enable]

Allows you to enable or disable support for USB devices on legacy operating systems (OS). Setting to Auto allows the system to detect the presence of USB devices at startup. If detected, the USB controller legacy mode is enabled. If no USB device is detected, the legacy USB support is disabled. Configuration options: [Disabled] [Enabled] [Auto]

Port 64/60 Emulation [Enabled]

Allows you to enable or disable the Port 64/60 Emulation. Configuration options: [Disabled] [Enabled].

USB 2.0 Controller Mode [HiSpeed]

Allows you to configure the USB 2.0 controller in HiSpeed (480 Mbps) or Full Speed (12 Mbps). Configuration options: [HiSpeed] [Full Speed]

BIOS EHCI Hand-Off [Enabled]

Allows you to enable or disable the BIOS EHCI hand-off support. Configuration options: [Disabled] [Enabled]

4.4.3 CPU Configuration

The items in this menu show the CPU-related information that the BIOS automatically detects.

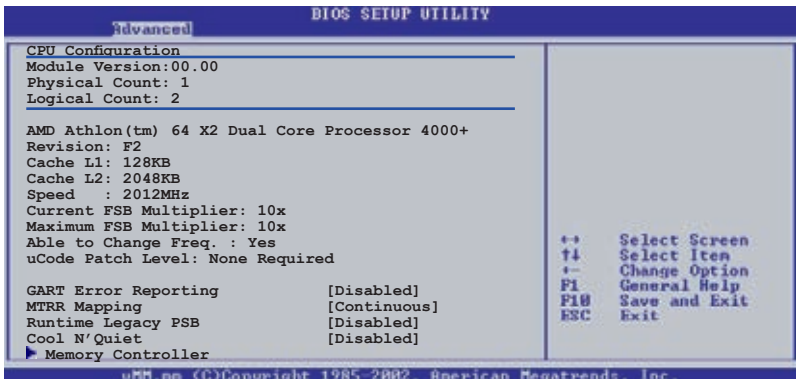

GART Error Reporting [Disabled]

This option should remain disabled for the normal operation. The driver developer may enable it for testing purpose.

MTRR Mapping [Continuous]

This option determines the method used for programming CPU MTRRs when 4GB or more memory is present. Discrete leaves the PCI hole below the 4GB boundary undescribed. Continuous explicitly describes the PCI hole as non-cachable

Runtime Legacy PSB [Disabled]

Allows you to enable or disable the Runtime Legacy PSB.

Configuration options: [Disabled] [Enabled]

Cool N'Quiet [Disabled]

Enables or disables the AMD Cool 'n' Quiet! technology feature.

Configuration options: [Disabled] [Enabled]

Memory Controller

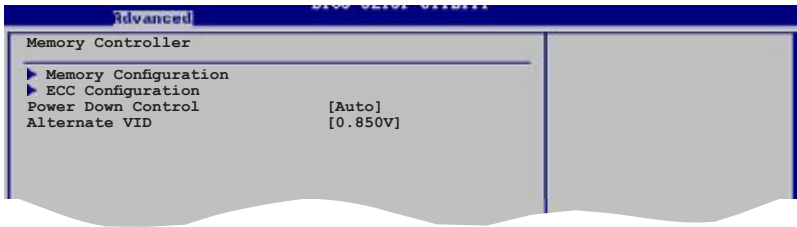

Memory Configuration

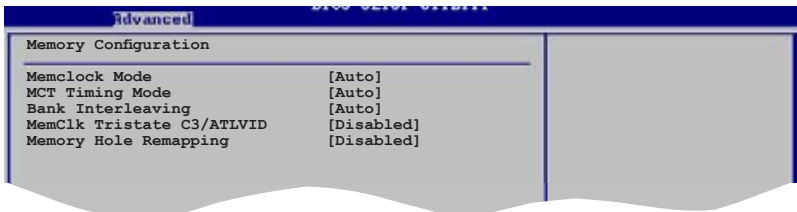

Memclock Mode [Auto]

Allows you to set the memory clock mode. Set by the code using [Auto] or select [Manual] to set using one of the standard values.

Configuration options: [Auto] [Manual] [Limit]

MCT Timing Mode [Auto]

Appears only when the Parallel Port Mode is set to [ECP]. This item allows you to set the Parallel Port ECP DMA.

Configuration options: [DMA0] [DMA1] [DMA3]

Bank Interleaving [Auto]

Sets whether to allow memory accesses to be spread out over BANKS on the same node or across nodes, decreasing access contention.

Configuration options: [Disabled] [Enabled]

MemClk Tristate C3/ATLVID [Disabled]

Allows you to enable or disable the MemCLK Tri-Stating During C3 and Alt VID. Configuration options: [Disabled] [Enabled]

Memory Hole Remapping [Disabled]

Allows you to enable or disable Memory Remapping around the memory hole. Configuration options: [Disabled] [Enabled]

ECC Configuration

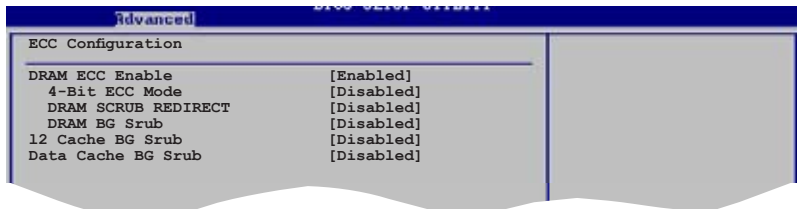

The screenshot shows a BIOS configuration window titled "Advanced" with a sub-section "ECC Configuration". The window contains a table of settings:

ECC Configuration	
DRAM ECC Enable	[Enabled]
4-Bit ECC Mode	[Disabled]
DRAM SCRUB REDIRECT	[Disabled]
DRAM BG Scrub	[Disabled]
12 Cache BG Scrub	[Disabled]
Data Cache BG Scrub	[Disabled]

DRAM ECC Enable [Disabled]

Enables or disables the DRAM ECC that allows hardware to report and correct memory errors automatically to maintain system integrity.

Configuration options: [Disabled] [Enabled]



The following item appears only when the **DRAM ECC** item is set to [Enabled].

4-Bit ECC Mode

Enables or disables the 4-Bit ECC mode.

Configuration options: [Disabled] [Enabled]

DRAM SCRUB REDIRECT [Disabled]

Sets the system to correct DRAM ECC Errors immediately when they occur, even if background scrubbing is on. Configuration options: [Disabled] [Enabled]

DRAM BG Scrub [Disabled]

Disables or sets the DRAM scrubbing functionality that corrects and rewrites memory errors so later reads are correct. During this while the memory is not being used improves performance. Configuration options: [Disabled] [40ns] [80ns] [160ns] [320ns] [640ns] [1.28us] [2.56us] [5.12us] [10.2us] [20.5us] [41.0us] [81.9us] [163.8us] [327.7us] [655.4us]

L2 Cache BG Scrub [Disabled]

Disables or sets the L2 data cache RAM to be corrected when idle. Configuration options: [Disabled] [40ns] [80ns] [160ns] [320ns] [640ns] [1.28us] [2.56us] [5.12us] [10.2us] [20.5us] [41.0us] [81.9us] [163.8us] [327.7us] [655.4us] [1.31ms] [2.62ms] [5.24ms] [10.49ms] [20.97ms] [42.00ms] [84.00ms]

Data Cache BG Scrub [Disabled]

Disables or sets the L1 data cache RAM to b corrected when idle. Configuration options: [Disabled] [40ns] [80ns] [160ns] [320ns] [640ns] [1.28us] [2.56us] [5.12us] [10.2us] [20.5us] [41.0us] [81.9us] [163.8us] [327.7us] [655.4us] [1.31ms] [2.62ms] [5.24ms] [10.49ms] [20.97ms] [42.00ms] [84.00ms]

Power Down Control [Auto]

Allows DIMMs to enter power down mode by deasserting the clock enable signal when DIMMs are not in use. Configuration options: [Auto] [Disabled]

Alternate VID [0.850V]

Specifies the alternate VID while in low power states.

Configuration options: [1.050V] [1.025V] [1.000V] [0.975V] [0.950V] [0.925V] [0.900V] [0.875V] [0.850V] [0.825V] [0.800V]

4.4.4 Chipset

The Chipset menu items allow you to change the advanced chipset settings. Select an item then press <Enter> to display the sub-menu.

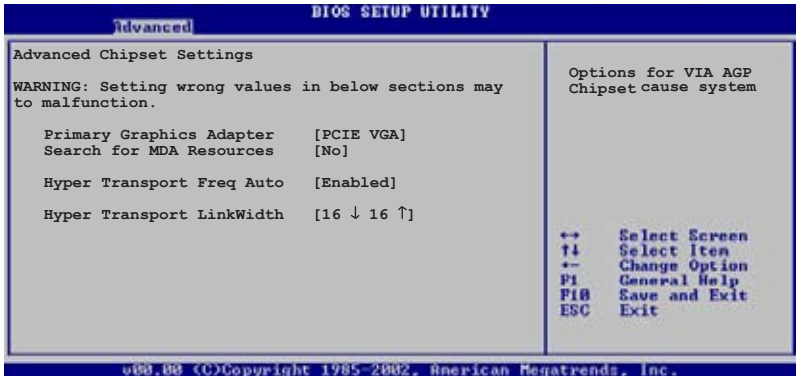

Primary Graphics Adapter [PCIE VGA]

Switches the PCI Bus scanning order while searching for a video card. This allows you to select the type of Primary VGA in case of multiple video controllers. Configuration options: [PCIE VGA] [PCI]

Search for MDA Resources [Yes]

Sets whether to allow search for MDA resources. Configuration options: [Yes] [No]

Hyper Transport Freq Auto [Enabled]

Allows you to enable or disable the Hyper Transport frequency selection. Configuration options: [Enabled] [Disabled]

Hyper Transport LinkWidth [16 ↓ 16 ↑]

Allows you to enable or disable the Hyper Transport link width selection. Configuration options: [16 ↓ 16 ↑] [8 ↓ 8 ↑]

4.4.5 Onboard Devices Configuration

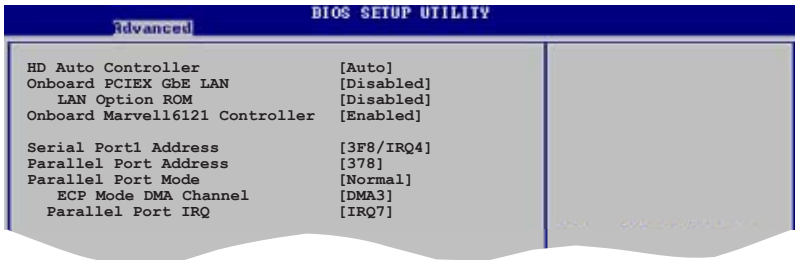

HD Audio Controller [Auto]

Enables or disables the High Definition Audio Controller [Auto]

Configuration options: [Auto] [Disabled]

Onboard PCIEX GbE LAN [Disabled]

Enables or disables the Onboard Onboard PCIEX GbE LAN.

Configuration options: [Disabled] [Enabled]

LAN Option ROM [Disabled]

Enables or disables the LAN Option.

Configuration options: [Disabled] [Enabled]

OnBoard Marvell6121 Controller [Enabled]

Enables or disables the Onboard Marvell6121 Controller.

Configuration options: [Disabled] [Enabled]

Serial Port1 Address [3F8/IRQ4]

Allows you to select the Serial Port1 base address.

Configuration options: [Disabled] [3F8/IRQ4] [3E8/IRQ4] [2E8/IRQ3]

Parallel Port Address [378]

Allows you to select the Parallel Port base addresses.

Configuration options: [Disabled] [378] [278] [3BC]

Parallel Port Mode [Normal]

Allows you to select the Parallel Port mode.

Configuration options: [Normal] [EPP] [ECP] [EPP+ECP]

ECP Mode DMA Channel [DMA3]

Allows you to select the Parallel Port ECP DMA.
Configuration options: [DMA0] [DMA1] [DMA3]

Parallel Port IRQ [IRQ7]

Allows you to select the Parallel Port IRQ.
Configuration options: [IRQ5] [IRQ7]

4.4.6 PCI PnP

The PCI PnP menu items allow you to change the advanced settings for PCI/PnP devices. The menu includes setting IRQ and DMA channel resources for either PCI/PnP or legacy ISA devices, and setting the memory size block for legacy ISA devices.



Take caution when changing the settings of the PCI PnP menu items. Incorrect field values can cause the system to malfunction.

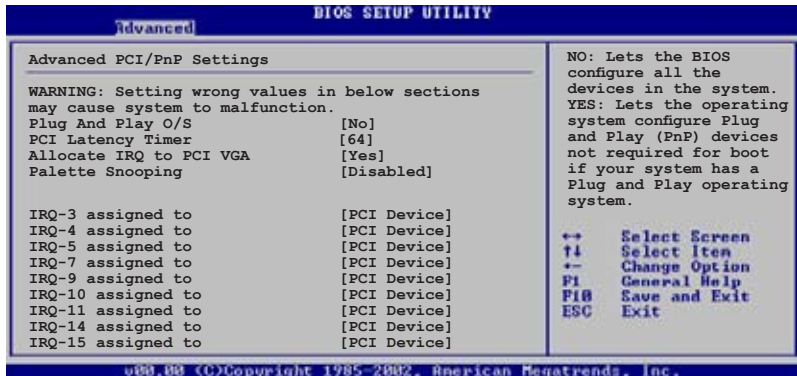

Plug and Play O/S [No]

When set to [No], BIOS configures all the devices in the system. When set to [Yes] and if you installed a Plug & Play operating system, the operating system configures the Plug & Play devices not required for boot.
Configuration options: [No] [Yes]

PCI Latency Timer [64]

Allows you to select the value in units of PCI clocks for the PCI device latency timer register. Configuration options: [32] [64] [96] [128] [160] [192] [224] [248]

Allocate IRQ to PCI VGA [Yes]

When set to [Yes], BIOS assigns an IRQ to PCI VGA card if the card requests for an IRQ. When set to [No], BIOS does not assign an IRQ to the PCI VGA card even if requested. Configuration options: [Yes] [No]

Palette Snooping [Disabled]

When set to [Enabled], the palette snooping feature informs the PCI devices that an ISA graphics device is installed in the system so that the latter can function correctly. Setting to [Disabled] deactivates this feature. Configuration options: [Disabled] [Enabled]

IRQ xx [Available]

When set to [Available], the specific IRQ is free for PCI/PnP devices to use. When set to [Reserved], the IRQ is reserved for legacy ISA devices. Configuration options: [Available] [Reserved]

4.5 Power menu

The Power menu items allow you to change the settings for the Advanced Power Management (APM) feature. Select an item then press <Enter> to display the configuration options.



4.5.1 Suspend Mode [Auto]

Allows you to select the ACPI state to be used for system suspend.
Configuration options: [S1 (POS) Only] [S3 Only] [Auto]

4.5.2 Repost Video on S3 Resume [No]

Determines whether to invoke VGA BIOS POST on S3/STR resume.
Configuration options: [No] [Yes]

4.5.3 ACPI 2.0 Support [ACPI v1.0]

Allows you to add more tables for ACPI 1.0 specifications. Select [ACPI v2.0], if you install Vista operating system.
Configuration options: [ACPI v1.0] [ACPI v2.0] [ACPI v3.0]

4.5.4 ACPI APIC Support [Enabled]

Enables or disables the ACPI support in the ASIC. When set to Enabled, the ACPI APIC table pointer is included in the RSDT pointer list.
Configuration options: [Disabled] [Enabled]

4.5.5 APM Configuration

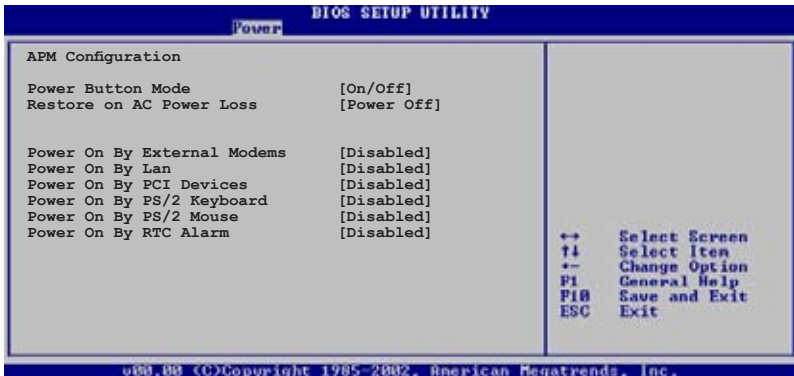

Power Button Mode [On/Off]

Allows the system to go into On/Off mode or suspend mode when the power button is pressed. Configuration options: [On/Off] [Suspend]

Restore on AC Power Loss [Power Off]

When set to Power Off, the system goes into off state after an AC power loss. When set to Power On, the system goes on after an AC power loss. When set to Last State, the system goes into either off or on state whatever the system state before the AC power loss.

Configuration options: [Power Off] [Power On] [Last State]

Power On By External Modems [Disabled]

Allows either settings of [Enabled] or [Disabled] for powering up the computer when the external modem receives a call while the computer is in Soft-off mode. Configuration options: [Disabled] [Enabled]



The computer cannot receive or transmit data until the computer and applications are fully running. Thus, connection cannot be made on the first try. Turning an external modem off and then back on while the computer is off causes an initialization string that turns the system power on.

Power On By Lan [Disabled]

Allows you to enable or disable the LAN-wake up feature.

Configuration options: [Disabled] [Enabled]

Power On By PCI Devices [Disabled]

Allows you to enable or disable the PME# to generate a wake event. This feature requires an ATX power supply that provides at least 1A on the +5VSB lead. Configuration options: [Disabled] [Enabled]

Power On By PS/2 Keyboard [Disabled]

Allows you to enable or disable the keyboard wake-up feature. This feature requires an ATX power supply that provides at least 1A on the +5VSB lead. Configuration options: [Disabled] [Enabled]

Power On By PS/2 Mouse [Disabled]

When set to [Enabled], this parameter allows you to use the PS/2 mouse to resume the system. This feature requires an ATX power supply that provides at least 1A on the +5VSB lead.

Configuration options: [Disabled] [Enabled]

Power On By RTC Alarm [Disabled]

Allows you to enable or disable RTC to generate a wake event. When this item is set to Enabled, the items RTC Alarm Date, RTC Alarm Hour, RTC Alarm Minute, and RTC Alarm Second appear with set values. This feature requires an ATX power supply that provides at least 1A on the +5VSB lead. Configuration options: [Disabled] [Enabled]

4.5.6 Hardware Monitor

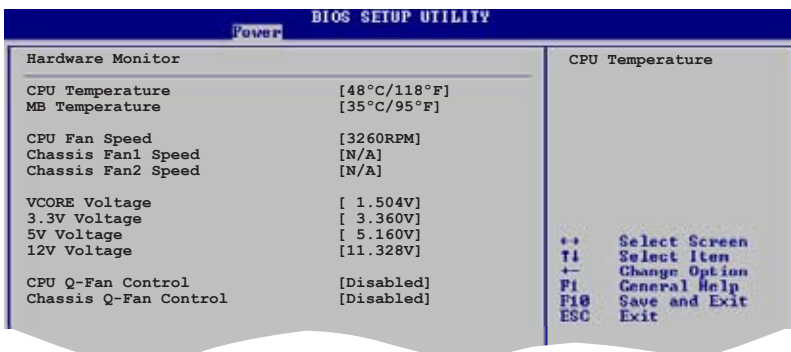

CPU Temperature [xxx °C/xxx °F]

MB Temperature [xxx °C/xxx °F]

The onboard hardware monitor automatically detects and displays the CPU, motherboard and power temperatures. Select Disabled if you do not wish to display the detected temperatures.

CPU Fan Speed [xxxxRPM] or [N/A]

Chassis Fan Speed [xxxxRPM] or [N/A]

The onboard hardware monitor automatically detects and displays the CPU and chassis fan speeds in rotations per minute (RPM). If any of the fans is not connected to the motherboard, the specific field shows N/A.

VCORE Voltage, +3.3V Voltage, +5V Voltage, +12V Voltage

The onboard hardware monitor automatically detects the voltage output through the onboard voltage regulators.

CPU Q-Fan Control [Disabled]

Allows you to enable or disable the CPU fan control function. When this field is set to [Enabled], the item **CPU Fan Ratio** appears.

Configuration options: [Disabled] [Enabled]

Chassis Q-Fan Control [Disabled]

Allows you to enable or disable the Chassis fan control function. When this field is set to [Enabled], the item **Chassis Fan Ratio** appears.

Configuration options: [Disabled] [Enabled]

4.6 Boot menu

The Boot menu items allow you to change the system boot options. Select an item then press <Enter> to display the sub-menu.

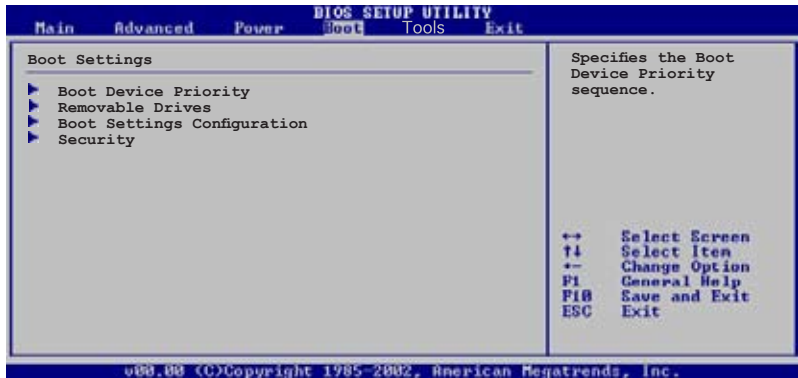

4.6.1 Boot Device Priority

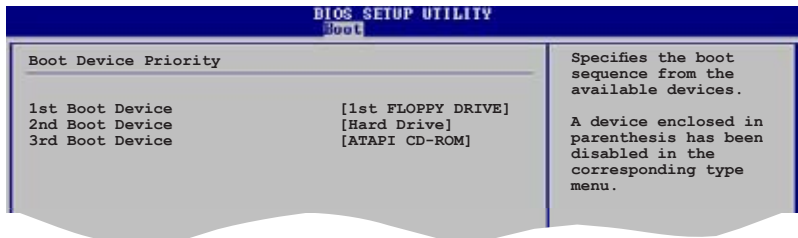

1st ~ xxth Boot Device [1st Floppy Drive]

These items specify the boot device priority sequence from the available devices. The number of device items that appear on the screen depends on the the number of devices installed in the system.

Configuration options: [xxxxx Drive] [Disabled]

4.6.2 Boot Settings Configuration

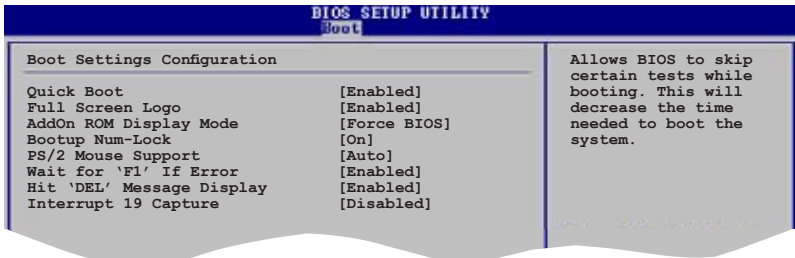

Quick Boot [Enabled]

Enabling this item allows the BIOS to skip some Power On Self Tests (POST) while booting to decrease the time needed to boot the system.

When set to [Disabled], BIOS performs all the POST items.

Configuration options: [Disabled] [Enabled]

Full Screen Logo [Enabled]

Allows you to enable or disable the full screen logo display feature.

Configuration options: [Disabled] [Enabled]



Make sure that the above item is set to [Enabled] if you want to use the ASUS MyLogo2™ feature.

Add On ROM Display Mode [Force BIOS]

Sets the display mode for option ROM.

Configuration options: [Force BIOS] [Keep Current]

Bootup Num-Lock [On]

Allows you to select the power-on state for the NumLock.

Configuration options: [Off] [On]

PS/2 Mouse Support [Auto]

Allows you to enable or disable support for PS/2 mouse.

Configuration options: [Disabled] [Enabled] [Auto]

Wait for 'F1' If Error [Enabled]

When set to Enabled, the system waits for F1 key to be pressed when error occurs. Configuration options: [Disabled] [Enabled]

Hit 'DEL' Message Display [Enabled]

When set to Enabled, the system displays the message "Press DEL to run Setup" during POST. Configuration options: [Disabled] [Enabled]

Interrupt 19 Capture [Disabled]

When set to [Enabled], this function allows the option ROMs to trap Interrupt 19. Configuration options: [Disabled] [Enabled]

4.6.3 Security

The Security menu items allow you to change the system security settings. Select an item then press <Enter> to display the configuration options.

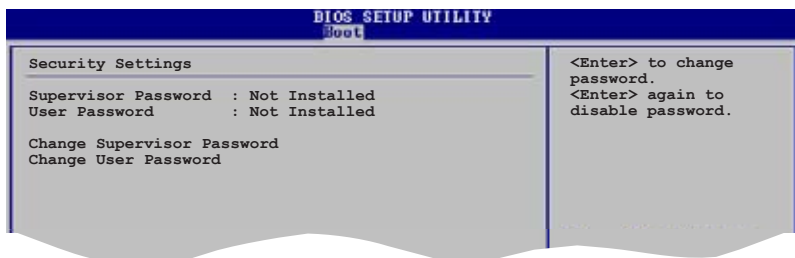

Change Supervisor Password

Select this item to set or change the supervisor password. The Supervisor Password item on top of the screen shows the default **Not Installed**. After you have set a password, this item shows **Installed**.

To set a Supervisor Password:

1. Select the Change Supervisor Password item and press <Enter>.
2. From the password box, type a password combination of at least six (6) letters and/or numbers, then press <Enter>.
3. Confirm the password when prompted.
The message "Password Installed" appears after you have successfully set your password.
The Supervisor Password item now shows **Installed**.

To change the supervisor password, follow the same steps as in setting a user password.

To clear the supervisor password, select the Change Supervisor Password then press <Enter>. The message “Password Uninstalled” appears.



If you forget your BIOS password, you can clear it by erasing the CMOS Real Time Clock (RTC) RAM. See section “2.6 Jumpers” for information on how to erase the RTC RAM.

After you have set a supervisor password, the other items appear to allow you to change other security settings.

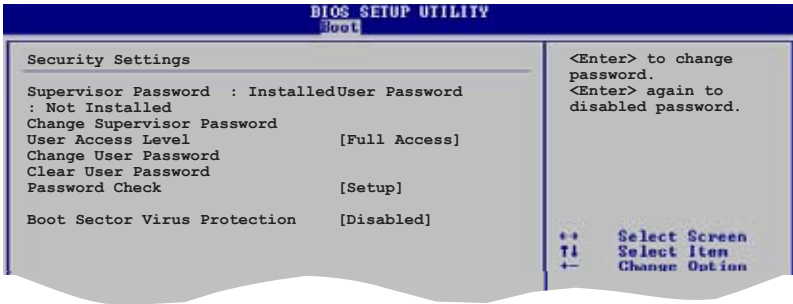

User Access Level (Full Access]

Allows you to select the access restriction to the Setup items.

Configuration options: [No Access] [View Only] [Limited] [Full Access]

No Access prevents user access to the Setup utility.

View Only allows access but does not allow change to any field.

Limited allows change only to selected fields, such as Date and Time.

Full Access allows viewing and changing all the fields in the Setup utility.

Change User Password

Select this item to set or change the user password. The User Password item on top of the screen shows the default **Not Installed**. After you have set a password, this item shows **Installed**.

To set a User Password:

1. Select the Change User Password item and press <Enter>.
2. On the password box that appears, type a password combination of at least six (6) letters and/or numbers, then press <Enter>.
3. Confirm the password when prompted.
The message "Password Installed" appears after you have successfully set your password.
The User Password item now shows **Installed**.

4.7 Tools menu

The Exit menu items allow you to load the optimal or failsafe default values for the BIOS items, and save or discard your changes to the BIOS items.



Save to/Load from Profile 1

Allows you to save Multi-language BIOS settings to profile1 or load BIOS file from profile1.

Save to/Load from Profile 2

Allows you to save Multi-language BIOS settings to profile1 or load BIOS file from profile2.

Start O.C. Profile

You may press Enter to run this utility to save/load CMOS.

4.8 Exit menu

The Exit menu items allow you to load the optimal or failsafe default values for the BIOS items, and save or discard your changes to the BIOS items.

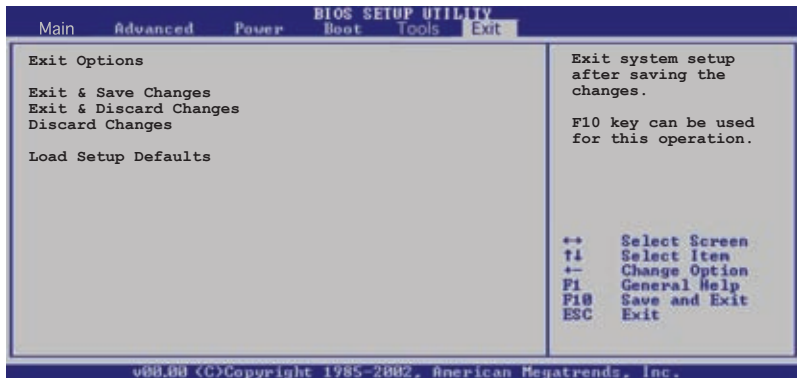

Pressing <Esc> does not immediately exit this menu. Select one of the options from this menu or <F10> from the legend bar to exit.

Exit & Save Changes

Once you are finished making your selections, choose this option from the Exit menu to ensure that the values you selected are saved to the CMOS RAM. An onboard backup battery sustains the CMOS RAM and stays on even when the PC is turned off. When you select this option, a confirmation window appears. Select **Yes** to save changes and exit.



If you attempt to exit the Setup program without saving your changes, the program prompts you with a message asking if you want to save your changes before exiting. Press <Enter> to save the changes while exiting.

Exit & Discard Changes

Select this option only if you do not want to save the changes that you made to the Setup program. If you made changes to fields other than System Date, System Time, and Password, the BIOS asks for a confirmation before exiting.

Discard Changes

Allows you to discard the selections you made and restore the previously saved values. After selecting this option, a confirmation appears. Select **Yes** to discard any changes and load the previously saved values.

Load Setup Defaults

This option allows you to load the default values for each of the parameters on the Setup menus. When you select this option or if you press <F5>, a confirmation window appears. Select **Yes** to load default values. Select **Exit Saving Changes** or make other changes before saving the values to the non-volatile RAM.

Chapter 5

This chapter describes the contents of the support CD that comes with the motherboard package.

Software support

Chapter summary

5.1	Installing an operating system.....	5-1
5.2	Support CD information.....	5-1
5.3	Software Information	5-8
5.4	RAID configurations.....	5-10
5.5	Creating a RAID driver disk.....	5-19
5.6	Cool 'n' Quiet!™ Technology	5-20

5.1 Installing an operating system

This motherboard supports Windows® 2000/XP/2003 Server operating systems (OS). Always install the latest OS version and corresponding updates to maximize the features of your hardware.



Motherboard settings and hardware options vary, so use the setup procedures presented in this chapter for general reference only. Refer to your OS documentation for more information.

5.2 Support CD information

The support CD that came with the motherboard contains useful software and several utility drivers that enhance the motherboard features.



The contents of the support CD are subject to change at any time without notice. Visit the ASUS website for updates.

5.2.1 Running the support CD

To begin using the support CD, simply insert the CD into your CD-ROM drive. The CD automatically displays the **Drivers** menu if Autorun is enabled in your computer.



Click an item to install

Click an icon to display more information



If **Autorun** is NOT enabled in your computer, browse the contents of the support CD to locate the file **ASSETUP.EXE** from the BIN folder. Double-click the **ASSETUP.EXE** to run the CD.

5.2.2 Drivers menu

The drivers menu shows the available device drivers if the system detects installed devices. Install the necessary drivers to activate the devices.



AMD Cool 'n' Quiet Driver

Installs the AMD Cool 'n' Quiet!™ Technology driver.

VIA Chipset Driver Program

Installs the VIA Chipset Driver Program.

Realtek Audio Driver

Installs the Realtek® audio controller and application.

Attansic L1 Gigabit Ethernet Driver

Installs the Attansic L1 Gigabit Ethernet driver.

Marvell 6121 SATA Controller Driver

Installs the Marvell® 6121 SATA Controller drivers.

USB 2.0 Driver

Installs the USB 2.0 driver.

5.2.3 Utilities menu

The Utilities menu shows the applications and other software that the motherboard supports.



ASUS Cool 'n' Quiet Utility

Installs the Cool 'n' Quiet! Technology software.

ASUS PC Probe II

This smart utility monitors the fan speed, CPU temperature, and system voltages, and alerts you of any detected problems. This utility helps you keep your computer in healthy operating condition.

ASUS Update

Allows you to download the latest version of the BIOS from the ASUS website.



Before using the ASUS Update, make sure that you have an Internet connection so you can connect to the ASUS website.

ASUS Screen Saver

Installs the ASUS screen saver.

Adobe Reader V7.0

Installs the Adobe Acrobat® Reader V7.0.

Microsoft DirectX 9.0c

Installs the Microsoft® DirectX 9.0c driver. The Microsoft DirectX® 9.0c is a multimedia technology that enhances computer graphics and sound. DirectX® improves the multimedia features of you computer so you can enjoy watching TV and movies, capturing videos, or playing games in your computer. Visit the Microsoft website (www.microsoft.com) for updates.

Anti-virus Utility

The anti-virus application scans, identifies, and removes computer viruses. View the online help for detailed information.

5.2.4 Make disk menu

The Make disk menu contains a list of drivers. Select and click an item to install the driver.



5.2.5 Manuals menu

The Manuals menu contains a list of supplementary user manuals. Click an item to open the manual.



Install the Adobe® Acrobat® Reader from the Utilities menu to open the manual files in PDF.

5.2.6 ASUS Contact information

Click the Contact tab to display the ASUS contact information. You can also find this information on the inside front cover of this user guide.

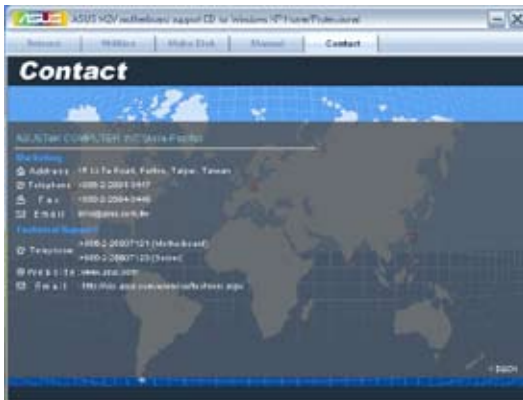

5.2.7 Other information

The icons on the top right corner of the screen give additional information on the motherboard and the contents of the support CD. Click an icon to display the specified information.

Motherboard Info

Displays the general specifications of the motherboard.



Browse this CD

Displays the support CD contents in graphical format.

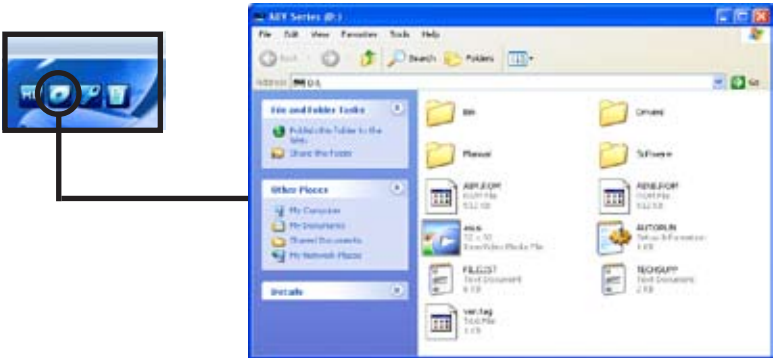

Technical Support Form

Displays the ASUS Technical Support Request Form that you have to fill out when requesting technical support.

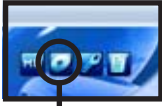
A screenshot of a Windows application window titled "TECHSUP - Microsoft". The window displays a form for requesting technical support. The form is divided into several sections: "ORIGINATOR INFORMATION" (Company Name, Phone, Email, Contact Name, Fax #), "HARDWARE DESCRIPTION" (Motherboard, CPU, RAM, Cache, Hard Disk, CD-ROM, Backup, Other Storage), and "ADD-IN CARD DESCRIPTION" (PCI Slot 1, PCI Slot 2, PCI Slot 3, PCI Slot 4). Each section contains a list of fields with labels and values, separated by dashed lines.

ORIGINATOR INFORMATION		
COMPANY NAME :	CONTACT NAME :	
PHONE (AREA) :	FAX # (AREA) :	
EMAIL ADDRESS :		

HARDWARE DESCRIPTION		
MOTHERBOARD :	REVISION # :	SIZE#MODEL :
CPU BRAND :	SPEED(MHz) :	
RAM BRAND :	SPEED(MHz) :	SIZE (MB) :
CACHE BRAND :	SPEED(MHz) :	SIZE (MB) :
HARD DISK :	MODEL NAME :	SIZE (MB) :
CD-ROM BRAND :	MODEL NAME :	
BACKUP BRAND :	MODEL NAME :	SIZE (MB) :
OTHER STORAGE :	MODEL NAME :	SIZE (MB) :

ADD-IN CARD DESCRIPTION (MODEL NAME/VENDOR)	
PCI SLOT 1 :	
PCI SLOT 2 :	
PCI SLOT 3 :	
PCI SLOT 4 :	

Filelist

Displays the contents of the support CD and a brief description of each in text format.

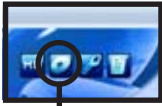
A screenshot of a Windows application window titled "FILELIST - Microsoft". The window displays a text-based file list for the support CD. The list is organized into sections: "Software" (including Windows XP SP2, Vista, and Windows Server 2003), "Drivers" (including SATA, IDE, and Network drivers), "Utilities" (including backup and recovery tools), and "Other" (including manuals and utilities). Each entry includes a file name and a brief description.

```
File List for the Technical Support Software for all series motherboards
-----
File Name      Description
-----
-----
Software
-----
-usb2001.inf   -usb2001.inf driver for USB 2.0 for Windows 2000
-usb2001.sys   -usb2001.sys driver for USB 2.0 for Windows XP
-usb2001.sys   -usb2001.sys driver for USB 2.0 for Windows 2003
-----
Drivers
-----
-ahci.sys     -AHCI driver for SATA driver & support for SATA 3Gb/s
-ata.sys      -ATA driver for SATA driver for Windows XP/2003
-----
USB
-----
-usb2001.inf  -usb2001.inf driver for USB 2.0 for Windows 2000/XP/2003
-usb2001.sys  -usb2001.sys driver for USB 2.0 for Windows XP
-usb2001.sys  -usb2001.sys driver for USB 2.0 for Windows 2003
-usb2001.sys  -usb2001.sys driver for USB 2.0 for Windows XP/2003
-----
Utilities
-----
-usb2001.inf  -usb2001.inf driver for USB 2.0 for Windows XP/2003/2003
-usb2001.sys  -usb2001.sys driver for USB 2.0 for Windows XP/2003/2003
-usb2001.sys  -usb2001.sys driver for USB 2.0 for Windows XP/2003/2003
-----
Other
-----
-usb2001.inf  -usb2001.inf driver for USB 2.0 for Windows XP/2003/2003
-usb2001.sys  -usb2001.sys driver for USB 2.0 for Windows XP/2003/2003
-usb2001.sys  -usb2001.sys driver for USB 2.0 for Windows XP/2003/2003
-----
```

5.3 Software Information

Most of the applications in the support CD have wizards that will conveniently guide you through the installation. View the online help or readme file that came with the software for more information.

This section provides details of the software applications that the motherboard supports.

ASUS MyLogo2™

The ASUS MyLogo2™ is automatically installed when you install the ASUS Update utility from the software menu. See section “5.2.3 Utilities menu”.



Before using ASUS MyLogo2™ feature, use the AFUDOS utility to make a copy of your original BIOS file, or obtain the latest BIOS version from the ASUS website.



Make sure that the BIOS Item Full Screen Logo is set to [Enabled] if you want to use ASUS MyLogo2™. See section “4.6.2 Boot Settings Configuration”.

Follow these steps to use ASUS MyLogo2.

1. Launch the ASUS Update utility.
See section “4.1.6 ASUS Update.”
2. When prompted for the BIOS update method, select the option “Update BIOS from a file.”
3. Specify the location of the BIOS file, such as from a floppy disk. Click **Next**.

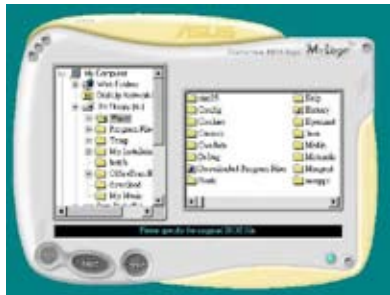

- From the selection that appears, choose a logo image. Click **Next**.



You can create your own boot logo image in GIF, JPG, or BMP file formats.

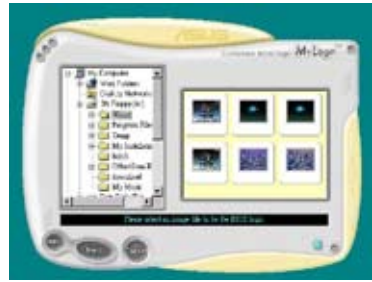

- When you click on an image, it displays larger on the MyLogo2™ screen.



- ASUS MyLogo2™ might encounter problems with complex images. If a problem occurs, replace with a simpler image or make the image smaller.
- To reduce the logo image, click on the arrow on the Ratio item and select your desired scale.



- The next screen prompts you to flash the original BIOS to update it with the new boot logo. Click **Flash** to update the BIOS.
- When finished, click **Exit**, then reboot your computer. Your system boots with the new boot logo.



Instead of starting from ASUS Update, you can also launch ASUS MyLogo2™ directly from the Windows Start menu to change your BIOS boot logo. After you have modified the BIOS file with the new logo, use the ASUS Update utility to upload the new BIOS.

5.4 RAID configurations

The motherboard comes with the VIA VT8237A controller integrated in the SouthBridge to support Redundant Array of Independent Disks (RAID) configurations. Using two Serial ATA hard disks, you can set up RAID 0, RAID 1, and JBOD configurations. The following defines the different RAID set configurations:

RAID 0 (called data striping) optimizes two identical hard disk drives to read and write data in parallel, interleaved stacks. Two hard disks perform the same work as a single drive but at a sustained data transfer rate, double that of a single disk alone, thus improving data access and storage.

RAID 1 (called data mirroring) copies and maintains an identical image of data from one drive to a second drive. If one drive fails, the disk array management software directs all applications to the surviving drive as it contains a complete copy of the data in the other drive. This RAID configuration provides data protection and increases fault tolerance to the entire system.

JBOD stands for Just a Bunch of Disks or also called spanning, refers to hard disks that are not yet configured according to RAID. The JBOD configuration stores the same data redundantly on multiple disks that appear as a single disk on the operating system. Spanning does not deliver any advantage over using separate disks independently and does not provide fault tolerance or performance benefits of RAID.



If you use either Windows® XP or Windows® 2000 operating system (OS), copy first the RAID driver from the support CD to a floppy disk before creating RAID configurations. Refer to section “5.5 □ Creating a RAID driver disk” for details.

5.4.1 Installing hard disks

The motherboard supports UltraDMA 133/100/66 and Serial ATA hard disk drives. For optimal performance, install identical Serial ATA hard disks of the same model and capacity when creating a disk array.



-
- If you are creating a **RAID 0 (striping)** array for performance, use two new drives.
 - If you are creating a **RAID 1 (mirroring)** array for protection, you can use two new drives or use an existing drive and a new drive with the same or larger size than the existing drive.
-

Installing Parallel ATA hard disks

To install the hard disks:

1. Set the jumpers of each hard disk as Master/Slave or Slave/Slave.
2. Install the hard disks into the drive bays.
3. Connect the HDD signal cables.
4. Connect a 4-pin power cable to the power connector on each drive.

Installing Serial ATA (SATA) hard disks

To install the SATA hard disks for RAID configuration:

1. Install the Serial ATA hard disks into the drive bays.
2. Connect the Serial ATA signal cables.
3. Connect the Serial ATA power cable to the power connector on each drive.

5.4.2 VIA RAID configurations

The motherboard includes a high performance IDE RAID controller integrated in the VIA VT8237A southbridge chipset. It supports RAID 0 and RAID 1 with two independent Serial ATA channels.



Refer to **VIA8237 SATA Quick Setup guide** found in the support CD for detailed information on RAID configurations under different operating systems.

Entering VIA Tech RAID BIOS Utility

1. Boot-up your computer.
2. During POST, press <Tab> to enter VIA RAID configuration utility. The following menu options will appear.



The RAID BIOS information on the setup screen shown below is for reference only. What you see on your screen may not exactly match what is shown here.

```
VIA Tech. RAID BIOS Ver 1.xx
```

<ul style="list-style-type: none">▶ Create Array▶ Delete Array▶ Create/Delete Spare▶ Select Boot Array▶ Serial Number View	<p>Create a RAID array with the hard disks attached to VIA RAID controller</p> <p>F1 : View Array/Disk Status ↑,↓ : Move to next item Enter : Confirm the selection ESC : Exit</p>
--	--

Channel	Drive Name	Array Name	Mode	Size (GB)	Status
Serial_Ch0	Master XXXXXXXXXXXX	ARRAY 0	SATA	999.99	XXXXXXXX
Serial_Ch1	Master XXXXXXXXXXXX	ARRAY 0	SATA	999.99	XXXXXXXX

On the upper-right side of the screen is the message and legend box. The keys on the legend box allows you to navigate through the setup menu options. The message describes the function of each menu item. The following lists the keys found in the legend box with their corresponding functions.

- <F1> : View Array/Disk Status
- ↑, ↓ : Move to the next item
- <Enter> : Confirm the selection
- <ESC> : Exit

Create Array

1. From the VIA RAID BIOS utility main menu, select **Create Array** then press **<Enter>**. The main menu items on the upper-left corner of the screen are replaced with create array menu options.

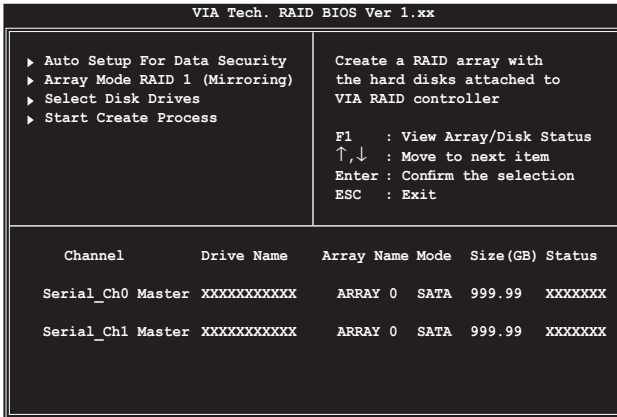

RAID 0 for performance

1. From the create array menu, select **Array Mode**, then press **<Enter>**. The supported RAID configurations appear on a pop-up menu.

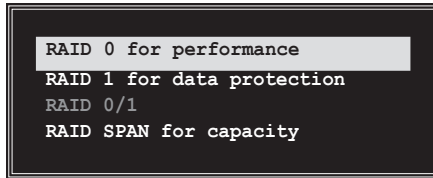

2. Select **RAID 0 for performance** then press **<Enter>**.

From this point, you may choose to auto-configure the RAID array by selecting **Auto Setup for Performance** or manually configure the RAID array for striped sets. If you want to auto-configure, proceed to the next step, otherwise, skip to step 5.

3. Select **Auto Setup for Performance** and press **<Enter>**. The following confirmation message appears.

```
Auto create array will destroy all
data on disks, Continue? (Y/N)
```

4. Press <Y> to confirm or <N> to return to the configuration options. If you selected <Y>, proceed to step 9.
5. Select **Select Disk Drives**, then press <Enter>. Use arrow keys to select disk drive, then press <Enter> to mark selected drive. An asterisk appears before a selected drive.
6. Select **Block Size**, then press <Enter> to set array block size. A list of valid array block sizes are displayed on a pop-up menu.



TIP: For server systems, use of a lower array block size is recommended. For multimedia computer systems used mainly for audio and video editing, a higher array block size is recommended for optimum performance.

Use arrow keys to move selection bar on items and press <Enter> to select.

7. Select **Start Create Process** and press <Enter> to set up hard disk for RAID system. The following confirmation message appears:

```
The data on the selected disks will
be destroyed. Continue? (Y/N)
```

8. Press <Y> to confirm or <N> to return to the configuration options.
9. Press <Esc> to go back to main menu.

RAID 1 for data protection

1. From the create array menu, select **Array Mode**, then press <Enter>. The supported RAID configurations appear on a pop-up menu.

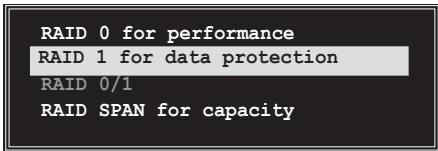

2. Select **RAID 1 for data protection** then press <Enter>.

- From this point, you can auto-configure the RAID array by selecting **Auto Setup for Data Security** or manually configure the RAID array for mirrored sets. If you want to auto-configure, proceed to the next step, otherwise, skip to step 6.
- Select **Auto Setup for Data Security** and press <Enter>. The following confirmation message appears.

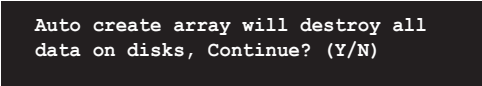

```
Auto create array will destroy all
data on disks, Continue? (Y/N)
```

- Press <Y> to confirm or <N> to return to the configuration options. If you selected <Y>, proceed to step 11.
- Select **Select Disk Drives**, then press <Enter>. Use arrow keys to select disk drive/s, then press <Enter>. An asterisk appears before a selected drive.
- Select **Start Create Process** and press <Enter> to setup hard disk for RAID system. The following inquiry appears:

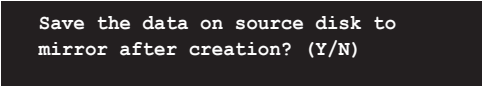

```
Save the data on source disk to
mirror after creation? (Y/N)
```

- If you select <Y> the utility will duplicate your data. Press <Y> anytime if you want to exit the duplication process.

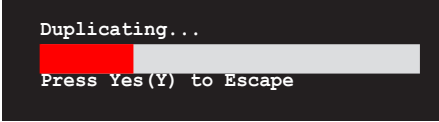

```
Duplicating...
Press Yes (Y) to Escape
```

- If you select <N>, the following confirmation message appears.

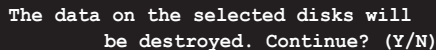

```
The data on the selected disks will
be destroyed. Continue? (Y/N)
```

- Press <Y> to confirm or <N> to return to the configuration options.
- Press <Esc> to go back to main menu.

RAID Span for capacity

1. From the create array menu, select **Array Mode**, then press <Enter>. The supported RAID configurations appear on a pop-up menu.

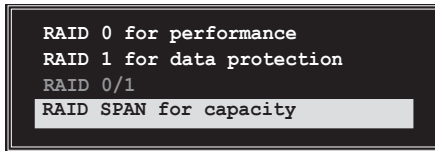

2. Select **RAID SPAN for capacity** then press <Enter>.
3. From this point, you can auto-configure the RAID array by selecting **Auto Setup for Capacity** or manually configure the RAID array for spanned sets. If you want to auto-configure, continue with next step; otherwise, proceed to step 6.
4. Select **Auto Setup for Capacity** and press <Enter>. The following confirmation message appears.

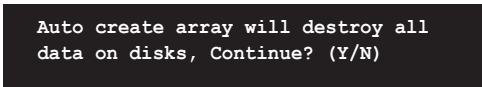

5. Press <Y> to confirm or <N> to return to the configuration options. If you selected <Y>, proceed to step 11.
6. Select **Select Disk Drives**, then press <Enter>. Use arrow keys to select disk drive/s, then press <Enter>. An asterisk appears before a selected drive.
7. Select **Start Create Process** and press <Enter> to start RAID system setup. The following inquiry appears:

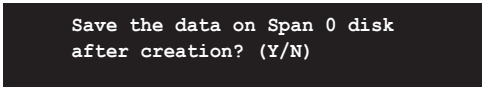

8. If you select <Y>, the utility will save your disk data on Span 0 disk then configure the RAID set. Proceed to step 11.
9. If you select <N>, the following confirmation message appears.

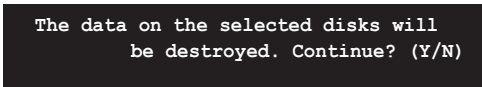

10. Press <Y> to confirm or <N> to return to the configuration options.
11. Press <Esc> to go back to main menu.

Delete Array

1. From the VIA RAID BIOS utility main menu, select **Delete Array** then press <Enter>.

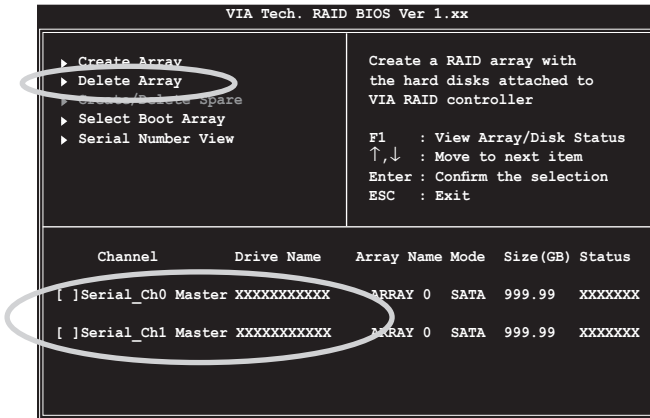

2. From the list of channel used for IDE RAID arrays, press <Enter> to select a RAID array to delete. The following confirmation message appears.

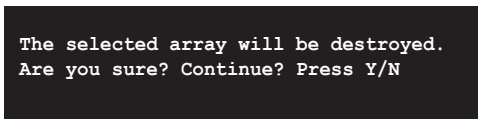

3. Press <Y> to confirm or <N> to return to the configuration options.

Select Boot Array

1. From the VIA RAID BIOS utility main menu, select **Select Boot Array** then press <Enter>.
2. From the list of channel used for IDE RAID arrays, press <Enter> to select a RAID array for boot. After selection, the **Status** of the selected array will change to Boot.
3. Press <ESC> to return to the menu items. Follow the same procedure to deselect the the boot array.

Serial Number View

1. From the VIA RAID BIOS utility main menu, select **Serial Number View** then press <Enter>.
2. From the list of channel used for IDE RAID arrays, use the arrow keys to move the selection bar on each item. The serial number for the selected drive is displayed at the bottom of the screen.



This option is useful for identifying same model disks.

```
VIA Tech. RAID BIOS Ver 1.xx

> Create Array
> Delete Array
> Create/Delete Spare
> Select Boot Array
> Serial Number View

Create a RAID array with
the hard disks attached to
VIA RAID controller

F1 : View Array/Disk Status
↑,↓ : Move to next item
Enter : Confirm the selection
ESC : Exit

Channel      Drive Name      Array Name Mode  Size(GB) Status
-----
Serial_Ch0 Master XXXXXXXXXXXX  ARRAY 0  SATA  999.99  XXXXXXXX
Serial_Ch1 Master XXXXXXXXXXXX  ARRAY 0  SATA  999.99  XXXXXXXX

Serial Number: XXXXXXXX
```

5.5 Creating a RAID driver disk

A floppy disk with the RAID driver is required when installing Windows® XP/2000 operating system. You can create a RAID driver disk using Makedisk.exe utility.

To create a RAID driver disk:

1. Insert the motherboard support CD into the CD-ROM drive and locate the Makedisk.exe utility in “**Drivers\Chipset\drvdisk\Makedisk.exe**” of the motherboard support CD.
2. Insert a clean floppy disk into the floppy disk drive and execute Makedisk.exe. Follow succeeding screen instructions to complete the process.
3. Write-protect the floppy disk to avoid computer virus infection.

To install the RAID driver:

1. During the OS installation, the system prompts you to press the **F6** key to install third-party SCSI or RAID driver.
2. Press <F6> then insert the floppy disk with RAID driver into the floppy disk drive.
3. Follow the succeeding screen instructions to complete the installation.



For additional information on RAID installation and configuration, refer to the Manuals menu of the support CD.

5.6 Cool ‘n’ Quiet!™ Technology

The motherboard supports the AMD Cool ‘n’ Quiet!™ Technology that dynamically and automatically change the CPU speed, voltage, and amount of power depending on the task the CPU performs.

5.6.1 Enabling Cool ‘n’ Quiet!™ Technology

To enable Cool ‘n’ Quiet!™ Technology:

1. Turn on the system and enter BIOS by pressing the key during the Power On Self-Tests (POST).
2. In the **Advanced > CPU Configuration > AMD CPU Cool & Quiet Configuration** menu, select the item **Cool N’Quiet** and set it to **Enabled**. See section “4.4 Advanced Menu” in the user guide.
3. In the **Power** menu, select the item **ACPI 2.0 Support** and set it to **Yes**. See section “4.5 Power Menu” in the user guide.
4. Save your changes and exit BIOS Setup.
5. Reboot your computer and set your Power Option Properties depending on your operating system.

Windows® 2000/XP

1. From the Windows® 2000/XP operating system, click the **Start** button. Select **Settings**, then **Control Panel**.
2. Make sure the Control Panel is set to Classic View.
3. Double-click the **Display** icon in the Control Panel then select the **Screen Saver** tab.
4. Click the **Power...** button. The following dialog box appears.
5. From the **Power schemes** combo list box, select **Minimal Power Management**.
6. Click **OK** to effect settings.

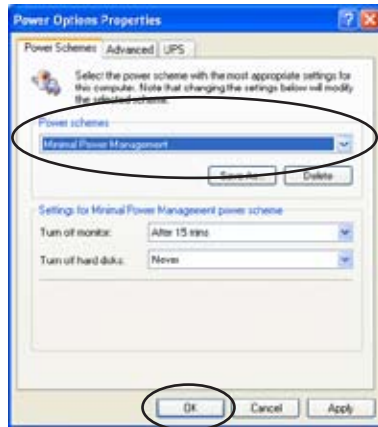

Make sure to install the Cool ‘n’ Quiet!™ driver and application before using this feature.

5.6.2 Launching the Cool 'n' Quiet!™ software

The motherboard support CD includes the Cool 'n' Quiet!™ software that enables you to view your system's real-time CPU Frequency and voltage.



Make sure to install the Cool 'n' Quiet!™ software from the motherboard support CD. Refer to section "5.2.3 Utilities menu", for details.

To launch the Cool 'n' Quiet!™ program:

1. If you are using Windows® 98SE/ME/2000, click the **Start** button. Select **Programs > ASUS > Cool & Quiet > Cool & Quiet**.
2. If you are using Windows® XP, click the **Start** button. Select **All Programs > ASUS > Cool & Quiet > Cool & Quiet**.
3. The Cool 'n' Quiet!™ technology screen appears and displays the current CPU Frequency and CPU Voltage.

