

***NOTEBOOK PC***

***USER'S MANUAL***

Product Name: **Notebook PC**  
Manual Revision: **1.01 E462**  
Release Date: **October 1999**

# SAFETY STATEMENTS

## Federal Communications Commission Statement

This device complies with FCC Rules Part 15. Operation is subject to the following two conditions:

- This device may not cause harmful interference, and
- This device must accept any interference received, including interference that may cause undesired operation.

This equipment has been tested and found to comply with the limits for a class B digital device, pursuant to Part 15 of the Federal Communications Commission (FCC) rules. These limits are designed to provide reasonable protection against harmful interference in a residential installation. This equipment generates, uses, and can radiate radio frequency energy and, if not installed and used in accordance with the instructions, may cause harmful interference to radio communications. However, there is no guarantee that interference will not occur in a particular installation. If this equipment does cause harmful interference to radio or television reception, which can be determined by turning the equipment off and on, the user is encouraged to try to correct the interference by one or more of the following measures:

- Reorient or relocate the receiving antenna.
- Increase the separation between the equipment and receiver.
- Connect the equipment into an outlet on a circuit different from that to which the receiver is connected.
- Consult the dealer or an experienced radio/TV technician for help.



**WARNING!** The use of a shielded-type power cord is required in order to meet FCC emission limits and to prevent interference to the nearby radio and television reception. It is essential that only the supplied power cord be used. Use only shielded cables to connect I/O devices to this equipment. You are cautioned that changes or modifications not expressly approved by the party responsible for compliance could void your authority to operate the equipment.

Reprinted from the Code of Federal Regulations #47, part 15.193, 1993. Washington DC: Office of the Federal Register, National Archives and Records Administration, U.S. Government Printing Office.

## Canadian Department of Communications Statement

This digital apparatus does not exceed the Class B limits for radio noise emissions from digital apparatus set out in the Radio Interference Regulations of the Canadian Department of Communications.

**This Class B digital apparatus complies with Canadian ICES-003.**

**Cet appareil numérique de la classe B est conforme à la norme NMB-003 du Canada.**

**For use with AC Adaptor Model ADP-45GB (Pour Utiliser Avec Modele ADP-45GB)**

## CTR 21 Approval (for Notebook PC with Modem)

### Danish

«Udstyret er i henhold til Rådets beslutning 98/482/EF EU-godkendt til at blive opkoblet på de offentlige telefonnet som enkeltforbundet terminal. På grund af forskelle mellem de offentlige telefonnet i de forskellige lande giver godkendelsen dog ikke i sig selv ubetinget garanti for, at udstyret kan fungere korrekt på samtlige nettermineringspunkter på de offentlige telefonnet.

I tilfælde af problemer bør De i første omgang henvende Dem til leverandøren af udstyret.»

### Dutch

„Dit apparaat is goedgekeurd volgens Beschikking 98/482/EG van de Raad voor de pan-Europese aansluiting van enkelvoudige eindapparatuur op het openbare geschakelde telefoonnetwerk (PSTN). Gezien de verschillen tussen de individuele PSTN's in de verschillende landen, biedt deze goedkeuring op zichzelf geen onvoorwaardelijke garantie voor een succesvolle werking op elk PSTN-netwerkaansluitpunt.

Neem bij problemen in eerste instantie contact op met de leverancier van het apparaat.”

### English

“The equipment has been approved in accordance with Council Decision 98/482/EC for pan-European single terminal connection to the public switched telephone network (PSTN). However, due to differences between the individual PSTNs provided in different countries, the approval does not, of itself, give an unconditional assurance of successful operation on every PSTN network termination point.

In the event of problems, you should contact your equipment supplier in the first instance.”

### Finnish

“Tämä laite on hyväksytty neuvoston päätöksen 98/482/EY mukaisesti liitettäväksi yksittäisenä laitteena yleiseen kytkentäiseen puhelinverkkoon (PSTN) EU:n jäsenvaltioissa. Eri maiden yleisten kytkentäisten puhelinverkkojen välillä on kuitenkin eroja, joten hyväksyntä ei sellaisenaan takaa häiriötöntä toimintaa kaikkien yleisten kytkentäisten puhelinverkkojen liityntäpisteissä.

Ongelmien ilmetessä ottakaa viipymättä yhteyttä laitteen toimittajaan.”

### French

«Cet équipement a reçu l'agrément, conformément à la décision 98/482/CE du Conseil, concernant la connexion paneuropéenne de terminal unique aux réseaux téléphoniques publics commutés (RTPC). Toutefois, comme il existe des différences d'un pays à l'autre entre les RTPC, l'agrément en soi ne constitue pas une garantie absolue de fonctionnement optimal à chaque point de terminaison du réseau RTPC.

En cas de problème, vous devez contacter en premier lieu votre fournisseur.»

### German

„Dieses Gerät wurde gemäß der Entscheidung 98/482/EG des Rates europaweit zur Anschaltung als einzelne Endeinrichtung an das öffentliche Fernsprechnetz zugelassen. Aufgrund der zwischen den öffentlichen Fernsprechnetzen verschiedener Staaten bestehenden Unterschiede stellt diese Zulassung an sich jedoch keine unbedingte Gewähr für einen erfolgreichen Betrieb des Geräts an jedem Netzabschlußpunkt dar.

Falls beim Betrieb Probleme auftreten, sollten Sie sich zunächst an ihren Fachhändler wenden.“

## Greek

«Ο εξοπλισμός έχει εγκριθεί για πανευρωπαϊκή σύνδεση μεμονωμένου τερματικού με το δημόσιο τηλεφωνικό δίκτυο μεταγωγής (PSTN), σύμφωνα με την απόφαση 98/482/ΕΚ του Συμβουλίου· ωστόσο, επειδή υπάρχουν διαφορές μεταξύ των εθνικών PSTN που παρέχονται σε διάφορες χώρες, η έγκριση δεν παρέχει απ' αυτής ανεπιφύλακτη εξασφάλιση επιτυχούς λειτουργίας σε κάθε σημείο απόληξης του δικτύου PSTN.

Εάν ανακύψουν προβλήματα, θα πρέπει κατ' αρχάς να απευθύνεστε στον προμηθευτή του εξοπλισμού σας.»

## Italian

«La presente apparecchiatura terminale è stata approvata in conformità della decisione 98/482/CE del Consiglio per la connessione paneuropea come terminale singolo ad una rete analogica PSTN. A causa delle differenze tra le reti dei differenti paesi, l'approvazione non garantisce però di per sé il funzionamento corretto in tutti i punti di terminazione di rete PSTN.

In caso di problemi contattare in primo luogo il fornitore del prodotto.»

## Portuguese

«Este equipamento foi aprovado para ligação pan-europeia de um único terminal à rede telefónica pública comutada (RTPC) nos termos da Decisão 98/482/CE. No entanto, devido às diferenças existentes entre as RTPC dos diversos países, a aprovação não garante incondicionalmente, por si só, um funcionamento correcto em todos os pontos terminais da rede da RTPC.

Em caso de problemas, deve entrar-se em contacto, em primeiro lugar, com o fornecedor do equipamento.»

## Spanish

«Este equipo ha sido homologado de conformidad con la Decisión 98/482/CE del Consejo para la conexión paneuropea de un terminal simple a la red telefónica pública conmutada (RTPC). No obstante, a la vista de las diferencias que existen entre las RTPC que se ofrecen en diferentes países, la homologación no constituye por sí sola una garantía incondicional de funcionamiento satisfactorio en todos los puntos de terminación de la red de una RTPC.

En caso de surgir algún problema, procede ponerse en contacto en primer lugar con el proveedor del equipo.»

## Swedish

”Utrustningen har godkänts i enlighet med rådets beslut 98/482/EG för alleuropeisk anslutning som enskild terminal till det allmänt tillgängliga kopplade telenätet (PSTN). På grund av de skillnader som finns mellan telenätet i olika länder utgör godkännandet emellertid inte i sig självt en absolut garanti för att utrustningen kommer att fungera tillfredsställande vid varje telenätsanslutningspunkt.

Om problem uppstår bör ni i första hand kontakta leverantören av utrustningen.”

## Nordic Cautions (for Notebook PC with Lithium-Ion Battery)

**CAUTION!** Danger of explosion if battery is incorrectly replaced. Replace only with the same or equivalent type recommended by the manufacturer. Dispose of used batteries according to the manufacturer's instructions. (English)

**VORSICHT!** Explosionsgefahr bei unsachgemäßen Austausch der Batterie. Ersatz nur durch denselben oder einem vom Hersteller empfohlenem ähnlichen Typ. Entsorgung gebrauchter Batterien nach Angaben des Herstellers. (German)

**ADVARSEL!** Lithiumbatteri - Eksplosionsfare ved fejlagtig håndtering. Udskiftning må kun ske med batteri af samme fabrikat og type. Levér det brugte batteri tilbage til leverandøren. (Danish)

**WARNING!** Explosionsfara vid felaktigt batteritype. Använd samma batterityp eller en ekvivalent typ som rekommenderas av apparattillverkaren. Kassera använt batteri enligt fabrikantens instruktion. (Swedish)

**VAROITUS!** Paristo voi räjähtää, jos se on virheellisesti asennettu. Vaihda paristo ainoastaan laitevalmistajan suositteluun tyypin. Hävitä käytetty paristo valmistajan ohjeiden mukaisesti. (Finnish)

**ATTENTION!** Il y a danger d'explosion s'il y a remplacement incorrect de la batterie. Remplacer uniquement avec une batterie du même type ou d'un type équivalent recommandé par le constructeur. Mettre au rebut les batteries usagées conformément aux instructions du fabricant. (French)

**ADVARSEL!** Eksplosjonsfare ved feilaktig skifte av batteri. Benytt samme batteritype eller en tilsvarende type anbefalt av apparatfabrikanten. Brukte batterier kasseres i henhold til fabrikantens instruksjoner. (Norwegian)

注意！この装置は、現在設置されている場所で妨害波の測定がされた情報技術装置です。この場所以外で使用する場合は、その場所で、再び妨害波の測定が必要となります。(Japanese)

## Macrovision Corporation Product Notice

This product incorporates copyright protection technology that is protected by method claims of certain U.S.A. patents and other intellectual property rights owned by Macrovision Corporation and other rights owners. Use of this copyright protection technology must be authorized by Macrovision Corporation, and is intended for home and other limited viewing uses only *unless otherwise authorized by Macrovision Corporation*. Reverse engineering or disassembly is prohibited.

# Contents

<b>SAFETY STATEMENTS</b>	<b>3</b>
Federal Communications Commission Statement .....	3
Canadian Department of Communications Statement .....	3
CTR 21 Approval (for Notebook PC with Modem) .....	4
Nordic Cautions (for Notebook PC with Lithium-Ion Battery) .....	6
Macrovision Corporation Product Notice .....	6
<b>SECTION 1</b>	
<b>INTRODUCTION</b>	<b>11</b>
About This Product .....	11
Item Checklist .....	11
About This User's Manual .....	12
Notes For This Manual .....	12
Hardware Features .....	13
Optional Features and Accessories .....	15
Caring Information .....	17
Transporting the Notebook PC .....	18
Opening the Display Panel .....	18
<b>SECTION 2</b>	
<b>COMPONENTS</b>	<b>19</b>
Front Side .....	19
Front Component Descriptions .....	19
Top Side .....	20
Top Component Descriptions .....	21
Rear Side .....	22
Rear Component Descriptions .....	22
Right Side .....	24
Right Component Descriptions .....	24
Left Side .....	26
Left Component Descriptions .....	26

<b>SECTION 3</b>	
<b>GETTING STARTED</b>	<b>27</b>
Power Connection .....	27
Powering ON Your Notebook PC .....	28
The Power-On Self Test (POST) .....	28
Save-to-Disk Partition .....	29
Restarting or Rebooting .....	29
LED Status Indicator Description .....	30
LED Status Indicators .....	30
Using the Keyboard .....	31
Specific Hot Keys .....	31
Keyboard as a Numeric Keypad .....	32
Numeric Keypad as Cursors .....	33
<b>SECTION 4</b>	
<b>USING THE NOTEBOOK PC</b>	<b>35</b>
Introduction .....	35
Floppy Disk Drive .....	35
CD-ROM Drive .....	35
Using the CD-ROM Drive .....	36
Listening to Audio CD .....	36
Hard Disk Drive .....	38
Important Handling Note .....	38
Removing and Upgrading the Hard Disk Drive Module .....	38
Using the Touchpad .....	39
Pointing Device .....	39
Caring for the Touchpad .....	41
PS/2 Connection (optional) .....	41
Display Panel .....	42
Display Definitions .....	42
Windows Driver .....	42
Display Panel Care .....	43
External Monitor Connection (optional) .....	43
PC Cards .....	44
32-bit CardBus & Zoomed Video Port .....	44
Removing a PC Card .....	45
Inserting a PC Card .....	45



Multimedia Sound System .....	46
External Audio Connections (optional) .....	46
IR Wireless Communication .....	46
Guidelines for using IR communication .....	46
Enabling Infrared .....	46
Universal Serial Bus Port .....	48
Driver Support .....	48
AC Power System .....	49
Battery Power System .....	49
Charging the Battery Pack .....	49
Using Battery Power .....	50
Inserting and Removing the Battery Pack .....	51
Battery Care .....	51
Power Management Modes .....	52
Full Power Mode & Maximum Performance .....	52
APM and ACPI .....	52
Suspend Mode .....	52
Standby Mode .....	53
Power State Summary .....	53
Thermal Power Control .....	53
System Memory Expansion .....	54
Processor Upgrades .....	54
Securing Your Notebook PC .....	54
Other Security Products .....	54
Notebook PC Usage Notes and Examples .....	55
<b>SECTION 5</b>	
<b>BIOS SETUP</b> .....	<b>57</b>
Updating Your BIOS .....	57
Creating a BIOS Update Floppy Disk .....	57
Updating BIOS Procedures .....	58
BIOS Setup Program .....	59
BIOS Menu Bar .....	60
Legend Bar .....	60
Main .....	62
Main Menu Details .....	62

IDE Primary Master .....	64
IDE Primary Slave .....	64
IDE Primary Master Menu Details .....	65
IDE Primary Slave Menu Details .....	66
Advanced Menu Details .....	67
Advanced .....	67
I/O Device Configuration Menu Details .....	69
I/O Device Configuration .....	69
Security .....	71
Security Menu Details .....	72
Power .....	73
Power Menu Details .....	73
Boot .....	75
Boot Menu Details .....	75
Exit .....	76
Exit Menu Details .....	76
Features .....	79
Usage .....	79
<b>APPENDIX</b> .....	<b>79</b>
Vehicle/Air Power Adapter Accessory .....	79
Internal Modem Model .....	81
Protocols and Compliancy .....	81
Glossary .....	83
Notebook PC Owner Information .....	86

# SECTION 1

## INTRODUCTION

### About This Product

The Notebook PC is the latest in PC technology with features that surpass most desktop PCs. Since the number of features and components are so numerous, there may be different models depending on the territory. Your retailer should provide you with a standard component checklist and a list of optional components for the Notebook PC. Your retailer should also provide you with warranty and technical support.

### Item Checklist

Check that your package is complete. If you discover damaged or missing items, please contact your retailer. Because this User's Manual is written for many territories, the following unchecked items may or may not be included and is therefore left to the retailer or user to check.

- Notebook PC with built-in Floppy and CD-ROM drive
- Battery Pack
- Power Cord/Adapter
- Warranty Card
- Carrying Case
- Hardware/Software Manual
- Notebook PC Support CD
- PS/2 Y-Adapter
- Built-in Modem (Optional)
- Microsoft Windows 98 CD (Optional)
- Vehicle/Air Power Adapter (Optional)
- Other: \_\_\_\_\_
- Other: \_\_\_\_\_

## About This User's Manual

You are reading the Notebook PC User's Manual. This User's Manual provides information on the various components in this Notebook PC and how to use them. There are only a few sections in this reference guide as follows:

1. **Introduction**  
Introduces you to the Notebook PC and this User's Manual.
2. **Components**  
Gives you information on the Notebook PC's components.
3. **Getting Started**  
Gives you information on getting started with the Notebook PC.
4. **Using**  
Gives you information on using the Notebook PC's components.
5. **BIOS Setup**  
Gives you information on configuring the BIOS software.
6. **Appendix**  
Gives you information on the optional accessories for the Notebook PC

## Notes For This Manual

This User's Manual was created using Macintosh versions of Adobe® PageMaker™ 6.52, Adobe® Photoshop™ 5.0.2, and Macromedia® Freehand™ 8.0.1. The body text type used in this manual is “Times” (MAC) or “Times New Roman” (Windows) and headings are “Helvetica” (MAC) or “Arial” (Windows). A few notes and warnings in bold are used throughout this guide that you should be aware of in order to complete certain tasks safely and completely. These notes have different degrees of importance as described below:



**NOTE:** Tips and information to aid in completing a task.



**TIP:** Tips and useful information for power users.



**IMPORTANT:** Information that must be followed in order to complete a task.



**WARNING!** Information to prevent damage to components, damage to data, or personal injury when trying to complete a task.

Text enclosed in <> represents a key on the keyboard; do not actually type the <> keys.

## Hardware Features

The Notebook PC features a wide range of standard features, upgrades, and options. The following gives you all of your current choices. Many future options are being developed for the Notebook PC to keep up with the latest technologies.

- **Processor: Pentium® 233MHz to Pentium® II 400MHz**

The Notebook PC uses Intel® Mobile Modules in order to support current and future Intel® processors. Current processors are Pentium® MMX 233MHz-266MHz and Pentium® II from 300MHz-400MHz.

- **BIOS: Programmable Phoenix BIOS**

The Notebook PC uses a programmable 256Kb flash EEPROM that supports Plug & Play.

- **Chipset: Intel 440BX**

The Notebook PC is equipped with an Intel 440BX chipset with I/O subsystems for improved performance.

- **Memory: 32MB to 160MB 66MHz SDRAM**

The Notebook PC includes a 64-bit memory bus with 32MB of 66MHz SDRAM built-in. A single 144-pin SO-DIMM socket is available for a 16MB, 32MB, 64MB, or a 128MB SO-DIMM.

- **Display: 12.1" or 13.3" Active Matrix TFT**

The Notebook PC comes with an active matrix TFT 12.1" 800x600 SVGA or 13.3" 1024x768 XGA LCD display.

- **Graphics: 4MB SGRAM**

The Notebook PC comes with an SMI 910 2D VGA chipset with 64bit graphics acceleration engine and 4MB SGRAM for its graphics controller. The 12.1" display panel allows resolutions up to 800x600, and the 13.3" display panel allows resolutions up to 1024x768. The built-in VGA port provides a 15-pin D-sub VGA connector for connecting a CRT monitor, a second LCD monitor, or a video projector. Dual view and dual application in Windows 95/98/NT with independent LCD and CRT resolutions and refresh rates. Switchable Portrait or Landscape display for 90-degree CRT rotation.

- **CRT Display Modes: 640x480 to 1024x768**

When using a CRT monitor on the external VGA port, three modes are possible: VGA (640x480), SVGA (800x600), and XGA (1024x768) with all resolutions up to 16.7M colors.

- **PC Cards: CardBus & Zoomed Video**

The Notebook PC comes with two Type I/II (or one Type III) PCMCIA 2.1 compliant sockets. The lower socket supports 32-bit CardBus and Zoomed Video™ to accommodate any Notebook PC expansion cards.

- **All-In-One Design: Hard Drive, Floppy, CD**

The Notebook PC is an all-in-one design with a hard disk drive, a 3.5" floppy disk drive, and a 24X CD-ROM drive built in.

- **Hard Drive: 4/6/10GB**

The Notebook PC comes with a removable 2.5" (6.35cm) wide and .374" (.95cm) high UltraDMA/33 IDE hard disk drive with capacities from 4, 6, and 10GB, and supports S.M.A.R.T. (Self Monitoring and Reporting Technology) to prevent hard disk failure and errors in advance.

- **Status LEDs:**

The Notebook PC has status LEDs to display power ON/suspend, battery charging, disk access, capital lock, and number lock statuses.

- **Keyboard: 85 keys (89 keys for Japanese)**

The Notebook PC provides desktop-like keys spaced 19mm apart with 2.5mm travel and Microsoft Windows function keys. A palm rest provides comfort while typing.

- **Interface: Serial, Parallel, Infrared, USB, Modem, PS/2**

The Notebook PC provides one 9-pin D-sub serial port that supports RS-232 and 16550 serial devices (e.g. mouse or modem); one 25-pin D-sub ECP/EPP parallel port that supports a parallel printer, scanner, zip drive, or other third-party parallel port devices; IrDA 1.1 compliant infrared port that supports 115.2Kb/s SIR (serial infrared) or 4Mb/s FIR (fast infrared) speeds for wireless file transfers or networking; three audio jacks for Speaker Out, Mic-In, and Line-In; mini D-sub VGA port for external monitor; USB port, modem jack (optional); and one mini-DIN for PS/2 keyboard or PS/2 mouse (simultaneous use with Y-adaptor).

- **Audio - 32-bit PCI Sound Blaster Pro compatible**

The Notebook PC provides PCI AC'97 stereo that is 32-bit PCI Sound Blaster Pro compatible with full duplex stereo audio and 3D sound. Three audio jacks are used for stereo line-in, mono microphone-in, and stereo headphone-out. Integrated microphone and stereo speakers provide quality audio with convenient access.

- **Power Management: APM 1.2 and ACPI 1.0**

The Notebook PC features APM 1.2 power management built into the BIOS. These features are designed to conserve power and extend working time. SMI power management, standby, suspend to disk, suspend to RAM, and ACPI 1.0 supported.

- **Battery: 9-cell Lithium Ion (Li-Ion)**

The Notebook PC supports Lithium-Ion battery pack, which provides 4.5Ah (48Wh). The battery should last approximately 3 hours under normal conditions and charging takes between 3 to 5 hours depending on whether the Notebook PC is powered OFF, powered ON, or in use during charging. When battery power is 10% or less, there are warning beeps from the speakers and warning messages through the Windows operating system.

- **Power Adapter: Output 19V DC, 2.4Ah, 50W**

The Notebook PC includes a very compact power adapter that can accept inputs from 100Volts to 240Volts AC 50/60Hz to accommodate any country. Output is 19 Volts DC 2.4 Amp or 50 Watts.

- **Pointing Device: Touchpad with scroll feature**

The Notebook PC features a pressure-sensitive touchpad that allows cursor movement as well as clicking through tapping the touchpad or through the two buttons below the touchpad. Software controlled scrolling is also available.

- **Heat Dissipation: Temperature-Controlled Fan**

The Notebook PC has two temperature-controlled cooling fans to save power when the fan is not required. The two fans and custom aluminum heatsinks with heat-ducts effectively dissipate the heat away from the processor when needed.

- **Portability: 6.2lbs (2.8kg)**

The Notebook PC has all the above features at only 6.2 pounds (2.8kg) and 11.6" wide x 9.1" deep x 1.5" high (294mm x 232mm x 38mm) slim dimensions.

## Optional Features and Accessories

- **Modem/Fax: 56K V.90 Model**

The Notebook PC comes in a model with or without a built-in 56K/19.2K modem/fax with V.90 compression and data correcting protocols for fast data transfers. The modem/fax supports video-conferencing I/F V.80 and host-based digital voice and data. Upgrading is not possible at a later time, a modem can only be added through a PCMCIA expansion card after purchase.

- **Vehicle/Air Adapter: Work hard or play hard on the road or in the sky!**

The vehicle/air adapter plugs into any vehicle's 12 Volt DC cigarette or utility socket or airplane's seat power (designed for passenger's use on certain airplanes). Produces an output of 19 Volts DC 2.64 Amp or 50 Watts





## Caring Information



**WARNING!** The following safety precautions will increase the life of the Notebook PC. Follow all precautions and instructions. Except as described in this manual, refer all servicing to qualified personnel. Do not use damaged power cords, accessories, or other peripherals. Do not use strong solvents such as thinners, benzene or other chemicals on or near the surface.

Disconnect the AC power and remove the battery pack(s) before cleaning. Wipe the Notebook PC using a clean cellulose sponge or chamois cloth dampened with a solution of nonabrasive detergent and a few drops of warm water and remove any extra moisture with a dry cloth.

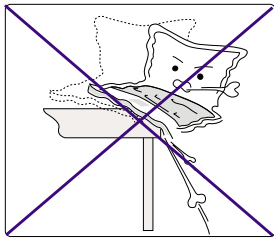

**DO NOT** place on uneven or unstable work surfaces. Seek servicing if the casing has been damaged.

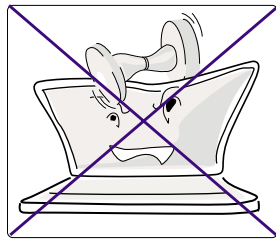

**DO NOT** place or drop objects on top and do not shove any foreign objects into the Notebook PC.

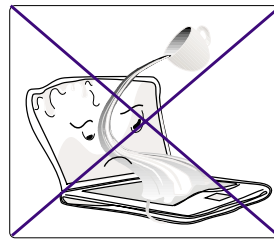

**DO NOT** expose to liquids, rain, or moisture. Seek servicing if liquid has been spilled into the Notebook PC.

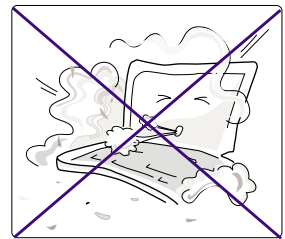

**DO NOT** expose to dirty or dusty environments.

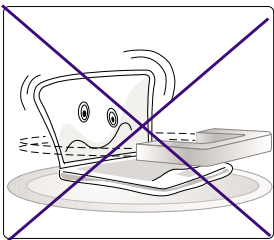

**DO NOT** expose to strong magnetic or electrical fields.

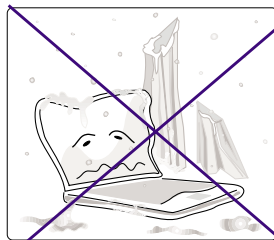

**DO NOT** expose to extreme temperatures (below 32°F/0°C or above 122°F/50°C) or to direct sunlight. Do not block the fan vents!

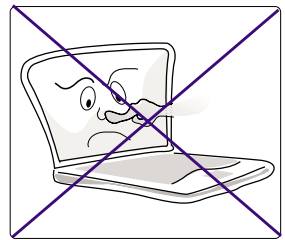
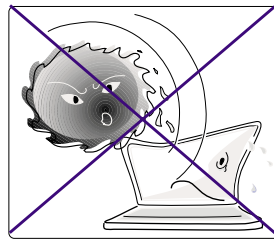

**DO NOT** press or touch the display panel. Do not place together with small items that may scratch or enter the Notebook PC.

## Transporting the Notebook PC

To prepare the Notebook PC for transport, you should turn it OFF and disconnect all external peripherals to prevent damage to the connectors. The hard disk drive's head retracts when the power is turned OFF to prevent scratching of the hard disk surface during transport. Therefore, you should not transport the Notebook PC while the power is still ON. Close the display panel and check that it is latched securely to the computer to protect the keyboard and display panel.

### Floppy Disks

Make sure that the 1.44MB floppy disk drive does not contain a diskette when transporting the Notebook PC. When a diskette is inserted into the floppy disk drive, the eject button protrudes out. If you attempt to transport the Notebook PC with a diskette in the drive, you risk damaging the eject button and also risk scratching the surface of the diskette when the floppy disk drive is jolted.

### Protection

Use a carrying case such as the one supplied with your Notebook PC to protect it from dirt, water, shock, and scratches.

### Battery

If you intend to use battery power, be sure to fully charge your battery pack and any optional battery packs before going on long trips. Remember that the power adapter charges the battery pack as long as it is plugged into the computer and an AC power source. When the power adapter is inserted, an orange LED will blink to show charging and will remain lit when the battery is fully charged. Be aware that it takes much longer to charge the battery pack when the Notebook PC is in use.

## Opening the Display Panel

Two spring-loaded latches on the front of the Notebook PC lock the display panel in the closed position when the Notebook PC is not in use. To open the display panel, slide the latch outward with your thumbs and raise the display panel with your thumbs and forefinger. Slowly adjust the display panel to a comfortable viewing position.



**WARNING!** When opening the display panel, do not force the display panel down to the table or else the hinges may break!

## SECTION 2

# COMPONENTS

### Front Side

Refer to the diagram below to identify the components on the front side of the Notebook PC.

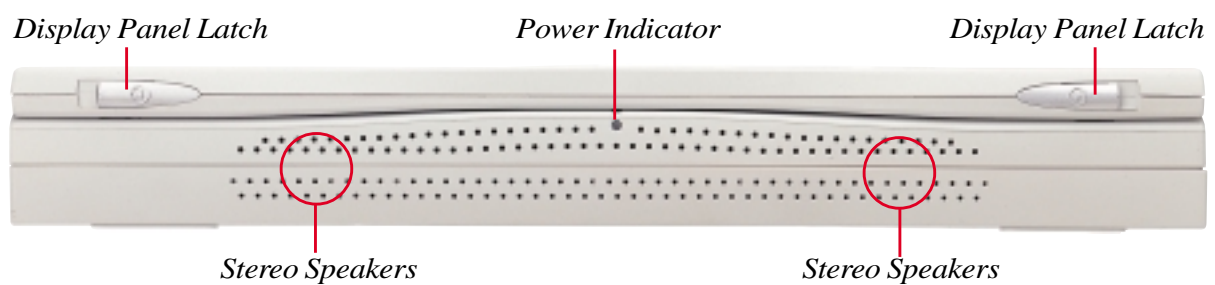

### Front Component Descriptions

The following describes the front components of the Notebook PC as shown by the picture above.

#### Display Panel Latches

The two display panel latches are used to lock the display panel in the closed position.



#### Power Indicator

The green LED will light when the power is ON and blink when in suspend-to-RAM mode. This LED will be OFF when in suspend-to-disk mode.

#### Stereo Speakers

The two built-in speakers allow you to hear stereo audio without additional attachments.

## Top Side

Refer to the diagram below to identify the components on the top side of the Notebook PC.

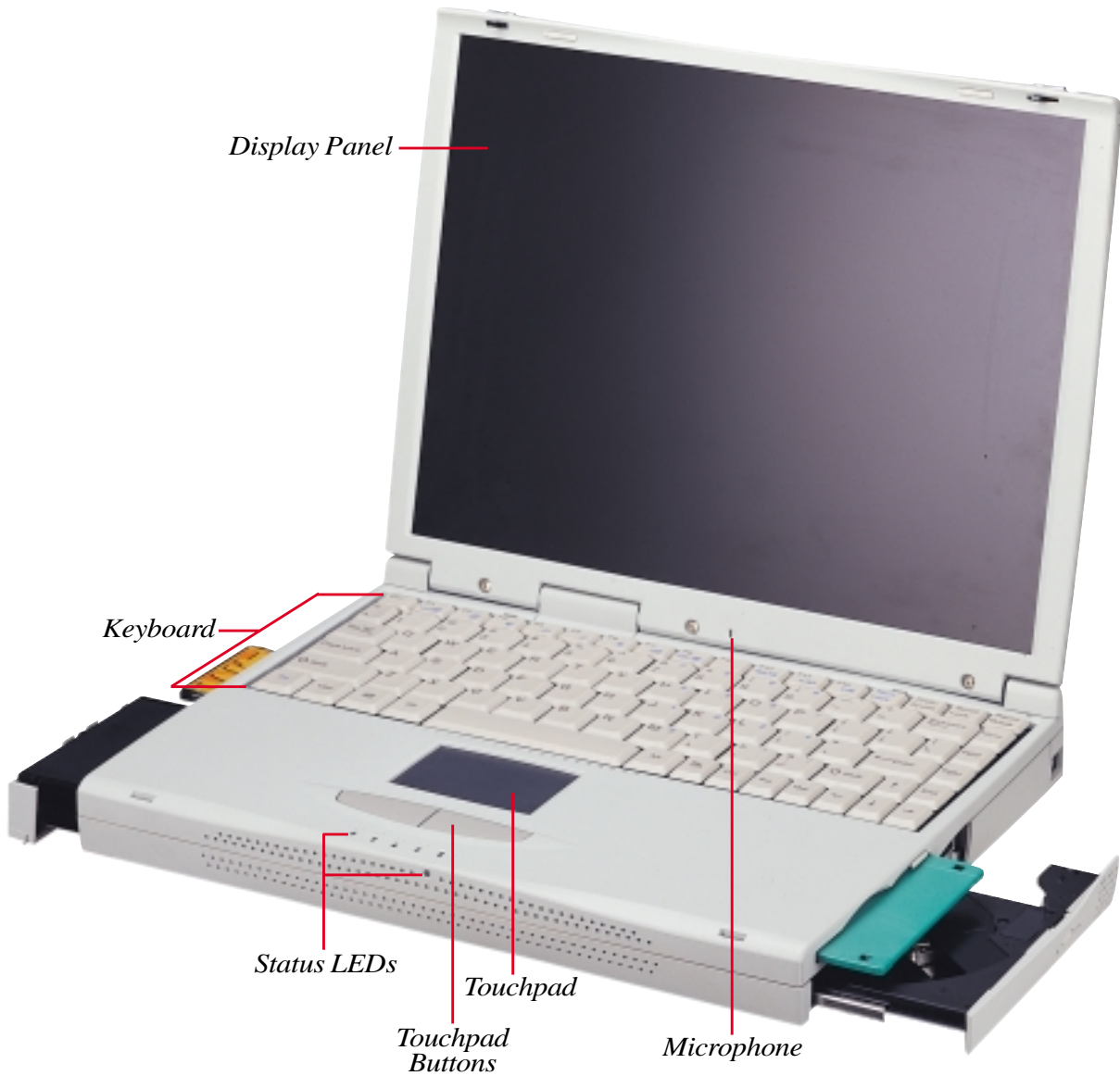

## Top Component Descriptions

The following describes the components of the Notebook PC as viewed from the top as shown by the illustration on the previous page.

### Display Panel

The display panel functions the same as a desktop monitor. It uses either a 12.1" or a 13.3" active matrix TFT LCD, which provides excellent viewing like that of desktop monitors. Unlike desktop monitors, the LCD panel does not produce any radiation or flickering, so it is easier on the eyes.

### Microphone

The built-in microphone provides a source for inputting mono audio for general note taking, voice-mail recording, or for use with Internet phone.

### Status LEDs

The Notebook PC has status LEDs to display battery charging, storage device access, capital lock, and number lock statuses.

### Keyboard

The keyboard provides full-sized 19mm keys with 2.5mm travel and palm rest. Two Windows™ function keys are provided to help ease navigation.

### Touchpad and Buttons

The touchpad with its two buttons is a pointing device that provides the same functions as a desktop mouse. A scrolling function for Web browsing or Microsoft Office navigation is available using the third-party software on the support CD.

## Rear Side

Refer to the diagram below to identify the components on the rear side of the Notebook PC.

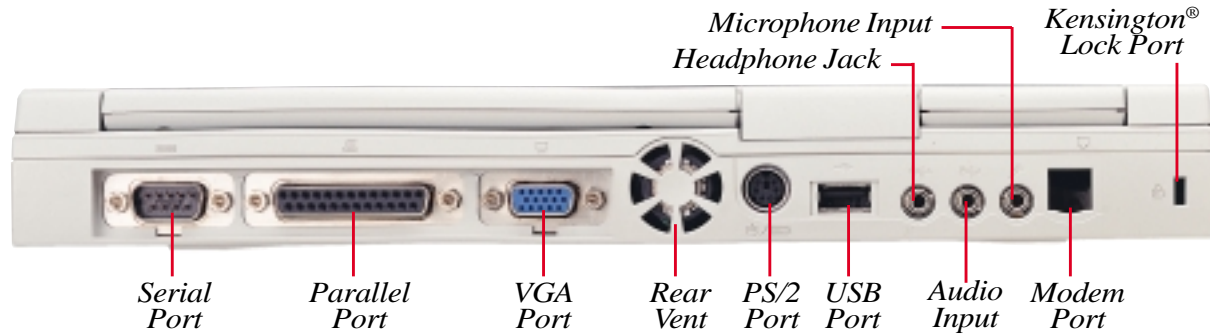

## Rear Component Descriptions

The following describes the components on the rear side of the Notebook PC as shown by the illustration above.

### Serial Port

The 9-pin D-sub serial port supports serial devices such as a drawing tablet, mouse, or modem.

### Parallel Port

The 25-pin D-sub parallel/porter port supports parallel devices such as a printer or a removable drive.

### VGA Port

The 15-pin D-sub VGA port supports a standard VGA-compatible device such as a monitor or projector.

## Cooling Fan

The cooling fan turns on when the temperature rises past a set threshold. The cooling fan is an extra feature needed for upgrading to faster processors in the future. Do not block the vent!

### PS/2 Port

The PS/2 port is for connecting an external PS/2 mouse or PS/2 keyboard to the Notebook PC if you do not want to use the built-in pointing device and keyboard. Simultaneous use requires the included Y-adapter.

### USB Port

The Universal Serial Bus (USB) port supports several USB compatible devices such as keyboards, pointers, modems, and printers connected in series.

### **Headphone Jack**

The stereo headphone jack is used to connect the Notebook PC's audio out to amplified speakers or headphones.

### **Audio Input**

The stereo audio input jack can be used to connect an external audio source for mixing or recoding audio from outside sources such as a vinyl record player, mini-disc player, or tape player.

### **Microphone Input**

The mono microphone jack can be used to connect an external microphone if the Notebook PC's built-in microphone is not sufficient.

### **Modem Port (optional)**

The port is optional at the time of purchase for modem or fax communications.

### **Kensington® Lock Port**

The Kensington® lock port allows the Notebook PC to be secured using Kensington® Notebook PC security products.

## Right Side

Refer to the diagram below to identify the components on the right side of the Notebook PC.

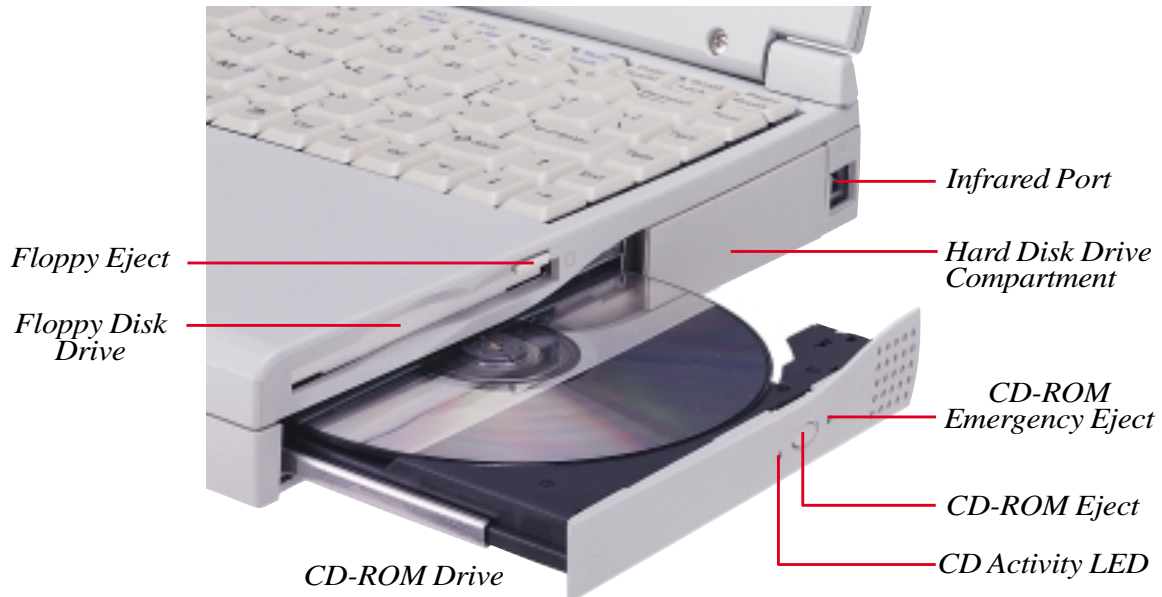

## Right Component Descriptions

The following describes the components on the right side of the Notebook PC as shown by the picture above.

### Floppy Disk Drive and Eject

This is a standard 1.44MB floppy disk drive with Japanese 3-mode floppy support. Unlike desktop PC floppy disk drives, the eject button of the Notebook PC is on top of the opening to allow easy floppy ejection from the top.



**WARNING!** The floppy disk drive's eject button protrudes out of the Notebook PC when a floppy disk is fully inserted and can be easily damaged if struck. Eject the floppy disk before transporting the Notebook PC.

### Infrared Port

The infrared (IrDA) communication port allows convenient wireless data transfers.



## **Hard Drive Compartment**

The hard drive compartment has a cover that is secured by the hard drive cover screw. When the cover is removed, the Notebook's PC hard disk drive can be seen.

## **CD-ROM Drive**

The Notebook PC comes with a 24X CD-ROM drive built-in.

### **CD-ROM Emergency Eject**

The CD-ROM emergency eject is used to eject a CD in case the electronic eject does not work. Do not use this in place of the electronic eject. Electronic eject may be initialized by the CD-ROM eject button or through software.

### **CD-ROM Eject**

The CD-ROM eject is an electronic eject button for opening the CD-ROM tray. You can also eject the CD through the software CD player or by right clicking the CD drive in "My Computer."

### **CD Activity LED**

The activity LED blinks proportionally to the CD-ROM drive activity and also blinks when electronically ejecting a CD.

## Left Side

Refer to the diagram below to identify the components on the left side of the Notebook PC.

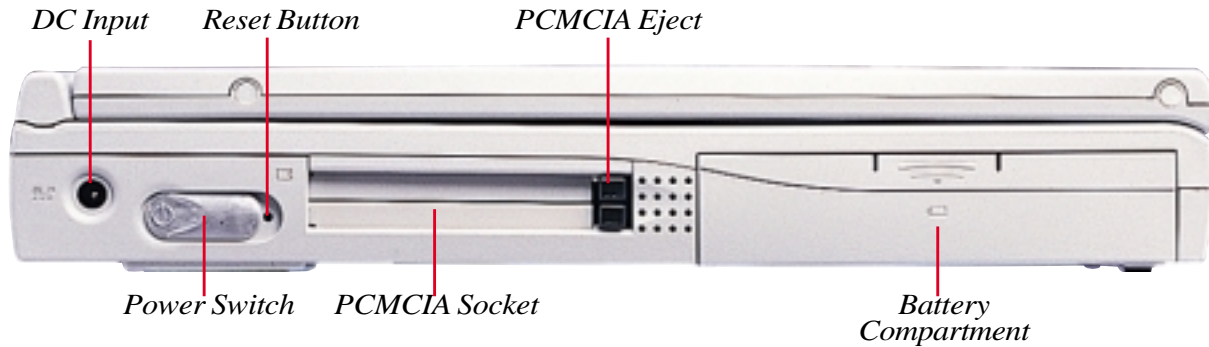

## Left Component Descriptions

The following describes the components on the left side of the Notebook PC as shown by the illustration above.

### DC Input

The supplied power adapter converts AC power to DC power for use with this jack.

### Power Switch

The power switch allows powering ON and OFF the Notebook PC. The momentary switch requires about one second to turn ON the power and about two seconds to turn OFF the power.

### Reset Button

The reset button is used for rebooting the Notebook PC if <CTRL><ALT><DEL> or turning OFF the power does not respond. To use this function, momentarily depress the button within the hole with a pen or pencil and the Notebook PC will reboot.

### PCMCIA

Two PCMCIA 2.1 compliant sockets for two Type I/II or one Type III PC card are available. The lower socket supports 32-bit CardBus and Zoomed Video to accommodate Notebook PC expansion options such as memory cards, fax/modems, SCSI adapters, high-speed network adapters, and video capture/conference cards.

### Battery Compartment

The battery compartment houses the 9-cell Li-Ion battery pack.

# SECTION 3

## GETTING STARTED

### Power Connection

Your Notebook PC comes with a universal AC-DC adapter. That means that you may connect the power cord to any 110V-120V as well as 220V-240V outlets without setting switches or using power converters. Different countries may require that an adapter be used to connect the provided US-standard AC power cord to a different standard. Most hotels will provide universal outlets to support different power cords as well as voltages. It is always best to ask an experienced traveler about AC outlet voltages when bringing power adapters to another country.



**TIP:** You can buy travel kits for the Notebook PC that includes power and modem converters/adapters for almost every country.

With the AC power cord connected to the AC-DC converter, connect the AC power cord to an AC outlet (preferably with surge-protection) and then connect the DC plug to the Notebook PC. Connecting the AC-DC adapter to the AC outlet first will allow you to test the AC outlet's power and the AC-DC converter itself for compatibility problems before connecting the DC power to the Notebook PC. The green power LED on the adapter will light if the power is within accepted ranges.



**WARNING!** Damage may occur if you use a different adapter to power the Notebook PC or use the Notebook PC's adapter to power other electrical devices. If there is smoke, burning scent, or extreme heat coming from the AC-DC adapter, seek servicing. Seek servicing if you suspect a faulty AC-DC adapter. You may damage both your battery pack(s) and the Notebook PC with a faulty AC-DC adapter.

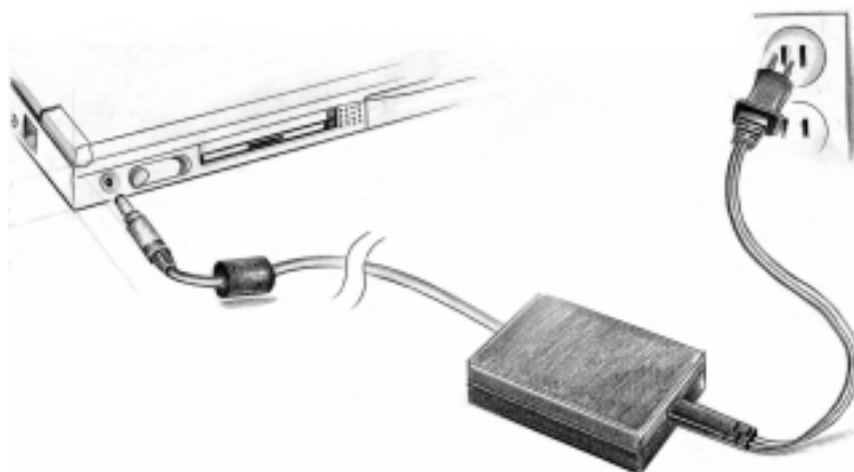

## Powering ON Your Notebook PC

Slide the power switch forward momentarily, and the Notebook PC's power-ON message will appear on the screen followed by a short beep. If necessary, you may adjust the brightness by using the hot keys. If you need to run the BIOS Setup to set or modify the system configuration, press [F2] upon bootup to enter the BIOS Setup. To turn OFF the Notebook PC, push and hold the power switch until the power turns OFF. To prevent accidental turning OFF the power, it is designed to take longer to turn OFF than to turn ON the power when using the power button.



**WARNING!** Never turn OFF or reset your Notebook PC while the hard disk or floppy disk is in use and the activity LED is lit; doing so can result in loss or destruction of your data. To protect the hard disk drive, always wait at least 5 seconds after turning OFF your Notebook PC before turning it back ON.



**NOTE:** Before bootup, the display panel will flash when the power is turned ON. This is part of the Notebook PC's test routine and is not a problem with the display.

### The Power-On Self Test (POST)

When you turn ON the Notebook PC, it will first run through a series of software-controlled diagnostic tests called the Power-On Self Test (POST). The software that controls the POST is installed as a permanent part of the Notebook PC's architecture. The POST includes a record of the Notebook PC's hardware configuration, which is used to make a diagnostic check of the system. This record is created by using the BIOS Setup program. If the POST discovers a difference between the record and the existing hardware, it will display a message on the screen prompting you to correct the conflict by running BIOS Setup. In most cases the record should be correct when you receive the Notebook PC. When the test is finished, you may get a message reporting "No operating system found" if the hard disk was not pre-loaded with an operating system. This indicates that the hard disk is correctly detected and ready for the installation of a new operating system.

The S.M.A.R.T. (Self Monitoring and Reporting Technology) will check the hard disk drive during POST and will give a warning message if the hard disk drive requires servicing. If any critical hard disk drive warning is given during bootup, backup your data immediately and run Windows disk checking program. To run Windows's disk checking program: (1) right-click any hard disk drive icon in "My Computer", (2) choose Properties, (3) click the Tools tab, (4) click Check Now, (5) select a hard disk drive, (6) select Thorough to also check for physical damages, and (7) click Start. Third party disk utilities such as Symantec's Norton Disk Doctor can also perform the same functions but with greater ease and more features.



**WARNING!** If warnings are still given during bootup after running a software disk checking utility, you should take your Notebook PC in for servicing. Continued use may result in data loss.

## Save-to-Disk Partition

The Notebook PC supports Advanced Power Management to save battery power and extend its working time. One type of power management is “Save-to-Disk.” Save-to-Disk is a suspend mode where your operating system and application data is saved to a separate partition and retrieved when the Notebook PC comes out of suspend mode. A partition is a space on the hard disk drive equivalent to having a second hard disk drive. If you would like the Notebook PC to support the Save-to-Disk mode, run the **PHDISK.EXE** utility to setup a Save-to-Disk partition on your hard disk. The Save-to-Disk partition must be larger than the total system memory of the Notebook PC. To check whether a Save-to-Disk partition exist on your hard drive, run **FDISK.EXE** located in Windows’ command directory or Windows rescue floppy disk. You can also compare your working partition’s size with the hard drive’s size as shown in BIOS setup.



**WARNING!** All other partitions and their data will be cleared by the PHDISK.EXE utility. This must be done BEFORE you install an operating system onto your hard disk. The included hard disk drive comes with the Save-to-Disk partition pre-configured from the factory.

## Restarting or Rebooting

After installing drivers (please see the “Drivers and Utilities Guide”), installing applications, or making configuration changes, you may be prompted to restart the system to update the operating system and complete the installation process. To restart the system, press the <Ctrl><Alt><Del> keys simultaneously. This is known as a “warm boot.” If this “warm boot” does not restart the Notebook PC, you can reset the Notebook PC by using a “cold boot” which is switching the Notebook PC’s power OFF and then back ON. Remember to wait 5 seconds before switching the Notebook PC back ON.



**NOTE:** If neither of these methods work, you can press the reset button located in a small hole next to the power switch.

## LED Status Indicators

There are several LED status indicators on the front edge of the Notebook PC. The LED status indicators give information on the Notebook PC's current operating and keyboard statuses. The following illustration shows the meaning of each status LED.

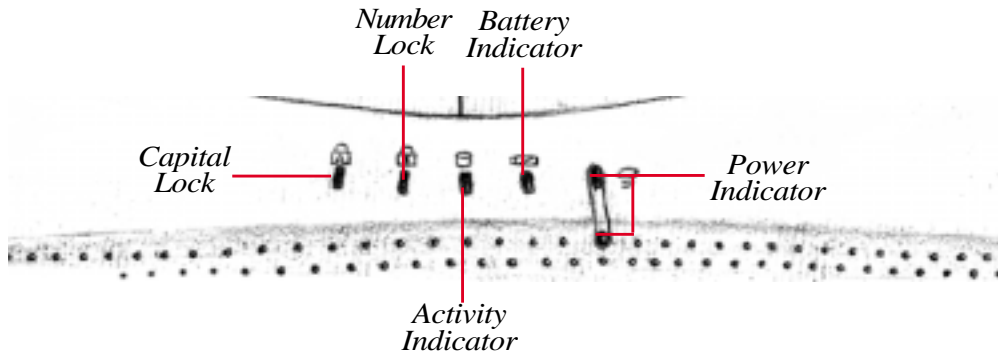

## LED Status Indicator Description

The following gives a description for each of the LED status indicators.

### Capital Lock

Indicates that capital lock [Caps Lock] is activated when lighted. Capital lock allows some of the keyboard letters to type using capitalized letters (e.g. A, B, C). When the capital lock light is OFF, the typed letters will be in the lower case form (e.g. a,b,c).

### Number Lock

Indicates that number lock [Num Lk] is activated when lit. Number lock allows some of the keyboard letters to act as numbers for easier numeric data input.

### Activity Indicator

Indicates that the Notebook PC is accessing the floppy, hard disk, CD/DVD-ROM drive. The light flashes proportional to the access time.

### Battery Indicator

Indicates that the battery is being charged when flashing and fully charged when it is OFF. This LED only lights when the power adapter is used. This LED will not light if there is no battery installed.



















### Power Indicator

The green LED will light when the power is ON and blink when in suspend-to-RAM mode. This LED will be OFF when in suspend-to-disk mode.

# Using the Keyboard

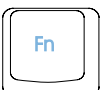
## Specific Hot Keys

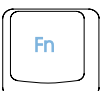
The following table defines the orange-labeled hot keys on the Notebook PC's keyboard. The orange-labeled commands can only be accessed by first pressing and holding the  (function) key while pressing a key with an blue-labeled command.

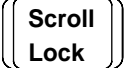
		Places the Notebook PC in suspend mode (either Save-to-RAM or Save-to-Disk depending on BIOS setup). This is not the same as “stand by” in MS Windows.
		Toggles the numeric keypad ON and OFF
		Increases the display brightness (OSD)
		Decreases the display brightness (OSD)
		Toggles the display panel ON and OFF (OSD)
		Toggles between LCD and external displays (OSD)
		Toggles the speakers ON and OFF (OSD)
		Increases the speaker volume (OSD)
		Decreases the speaker volume (OSD)
< F n > not used		Toggles the keypad as numbers ON and OFF
< F n > not used		Toggles the keypad as cursors ON and OFF

(OSD) stands for on screen display. OSD provides a large clear status displayed on the LCD panel for the function selected.

## Microsoft Windows™ Keys

There are two special Windows™ keys on the keyboard as described below.

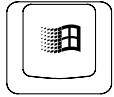

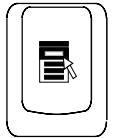

The key with the Windows™ Logo activates the Start menu button at the bottom left of the screen.



The other key, which looks like a Windows™ menu with a small cursor, activates the properties menu and is equivalent to pressing the right mouse button on a Windows object.

## Keyboard as a Numeric Keypad

The numeric keypad is embedded in the keyboard and consists of 15 keys that make number intensive input more convenient. These dual-purpose keys are labeled in orange on the keycaps. Numeric assignments are located at the upper right hand corner of each key as shown in the figure. When the numeric keypad is engaged by pressing , the number lock LED will light. If an external keyboard is connected, pressing the  key on either the Notebook PC or external keyboard will enable/disable NumLock on both keyboards in unison. To disable the Notebook PC numeric keypad while keeping the keypad on an external keyboard activated, press the  keys on the Notebook PC.

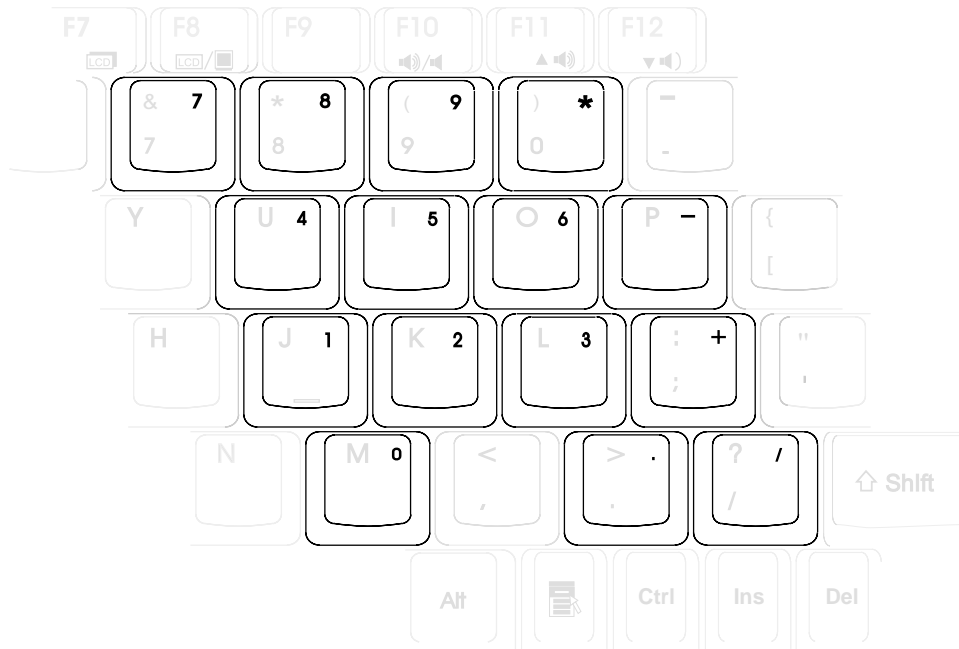

**NOTE:** The large bold characters are exaggerated here for your reference. They are not printed on the keyboard as shown here.



## Numeric Keypad as Cursors

The numeric keypad can be used as cursors. To enable the cursor keypad, press  (the number lock LED will light) and then press <Shift> and the function desired. For example <Shift><8> represents a cursor up command.

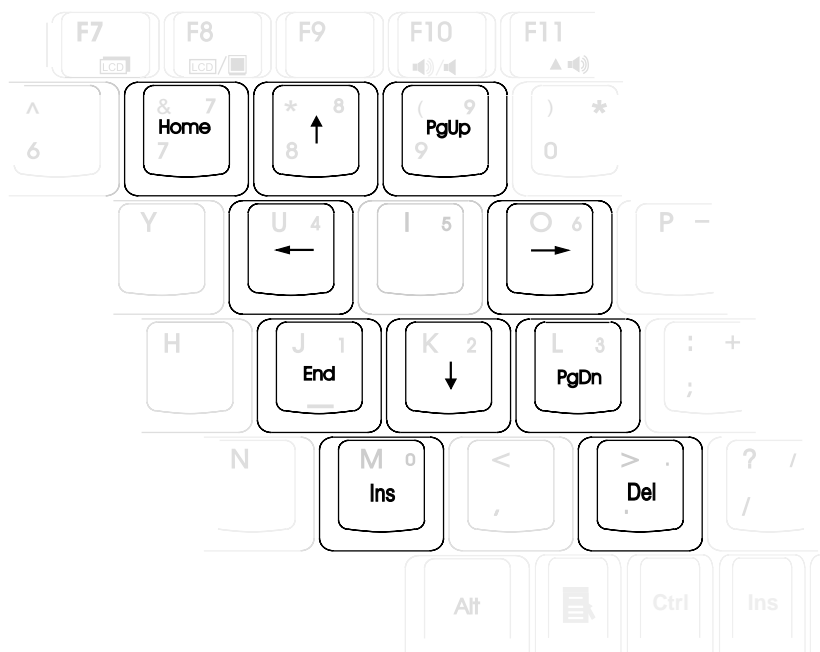

**NOTE:** The large bold characters are exaggerated here for your reference. They are not printed on the keyboard as shown here.



## SECTION 4

# USING THE NOTEBOOK PC

### Introduction

This Section describes the basic features and procedures for using your Notebook PC. Topics covered include the floppy drive, CD-ROM drive, hard disk drive, pointing device, and other input and output devices.

### Floppy Disk Drive

The Notebook PC features a 3.5-inch floppy disk drive that accepts standard 1.44MB (or 720KB) floppy diskettes. The eject button is placed on the top edge of the floppy disk drive for easy access, unlike desktop PCs with the eject button on the bottom of the floppy disk drive. The floppy activity can be monitored through the activity LED on the front edge of the Notebook PC.



**WARNING!** Because the eject button protrudes out when a floppy diskette is inserted, you must remove the floppy diskette during transport to prevent breakage of the eject button.

### CD-ROM Drive

The Notebook PC includes a CD-ROM drive. The CD-ROM drive can support all the popular formats: Audio/Music CDs; Photo CDs; MS-DOS MSCDEX Mode 1 and Mode 2; CD-ROM/XA; CD-I; and Video CDs.



## Using the CD-ROM Drive

Compact Disc Read Only Memory (CD-ROM or CD) discs and equipment must be handled with care because of the precise mechanics involved. Keep in mind the important safety instructions from your CD suppliers. Unlike desktop CD drives, the Notebook PC uses a hub to hold the CD in place regardless of the angle. When inserting a CD, it is important that the CD be pressed into the center hub or else the CD drive tray cannot be closed.

## Listening to Audio CD

Insert the audio CD and Windows will automatically open an audio player and begin playing. You can adjust the volume through the function keys on the keypad or through double-clicking the Windows speaker icon on the taskbar. Applications control the individual volume such as “CD Player” or “Wave”. The main “Volume Control” controls the maximum limit which applications can use.

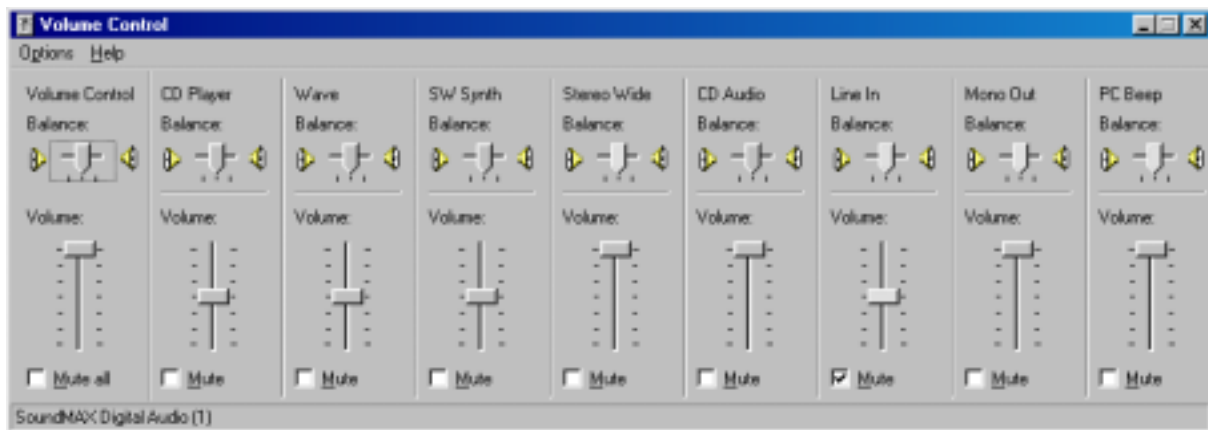

## Using a CD

A CD drive letter should be present after bootup regardless of a CD has been inserted. After the CD is properly inserted, data can be accessed just like with hard disk drives; except that nothing can be written to or changed on the CD.

## Removing a CD

Remove the CD by slowly lifting the CD off the tray by holding the edge of the CD. Do not touch the bottom-side of the CD where data is read.



**NOTE:** The CD drive eject button is electronic and requires that the Notebook PC be powered ON in order to eject the CD drive tray. Only one CD may be used at one time on this CD drive.

## Inserting a CD



1. Press the CD drive eject button and the CD drive tray will eject out partially.
2. Hold the CD drive's front panel and slide the CD drive tray completely out.

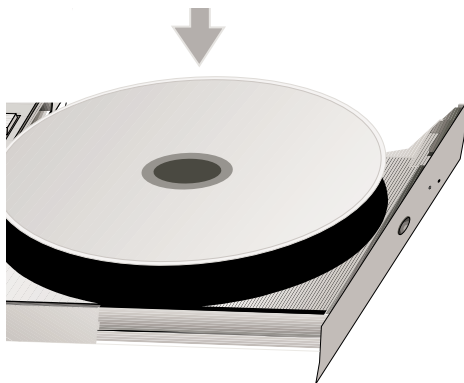

3. Place a CD with the printed side facing up.
4. Snap the CD onto the hub by pressing on both sides of the CD's center. **The hub should be higher than the CD when correctly mounted.** Slowly push the CD drive tray back into the Notebook PC.

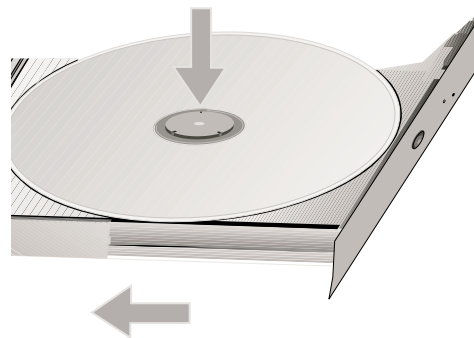

## Hard Disk Drive

Hard disk drives have higher capacities and operate at much faster speeds than floppy disk drives and CD-ROM drives. Enhanced IDE drives provide a reliable, fast, and cost-effective mass storage solution in the PC storage industry. The high speed transfer modes supported are Ultra DMA/33 up to 33MB/sec and PIO mode 4 up to 16.6MB/sec.

The Notebook PC comes with a removable 2.5" (6.35cm) wide and .374" (.95cm) high UltraDMA/33 IDE hard disk drive with capacities from 4, 6, and 10GB, and supports S.M.A.R.T. (Self Monitoring and Reporting Technology) to prevent hard disk failure and errors in advance.

### Important Handling Note

Improper handling during transit may damage the hard disk drive. Handle the Notebook PC carefully and keep it away from static electricity and strong vibrations or impact. The hard disk drive is the most sensitive component of the Notebook PC and will likely be the first or only component that is damaged if the Notebook PC is dropped.



**IMPORTANT:** The hard disk drive compartment screw must be secured properly before transit.

### Removing and Upgrading the Hard Disk Drive Module

The Notebook PC is shipped with a single hard disk drive. You may upgrade to a higher capacity hard disk drive up to 6GB (larger capacities will have to slim down before it will fit in this Notebook PC) or have multiple hard disk drives (to be used one at a time) for multiple operating systems or multiple uses. When removing or inserting the hard disk drive, the Notebook PC's power must be turned OFF. The large black screw (see Bottom Side in Section 2) securing the hard disk drive tray can be unscrewed using a coin.

Turn the hard drive compartment screw counterclockwise using a coin and the hard disk drive tray can be easily pulled out.

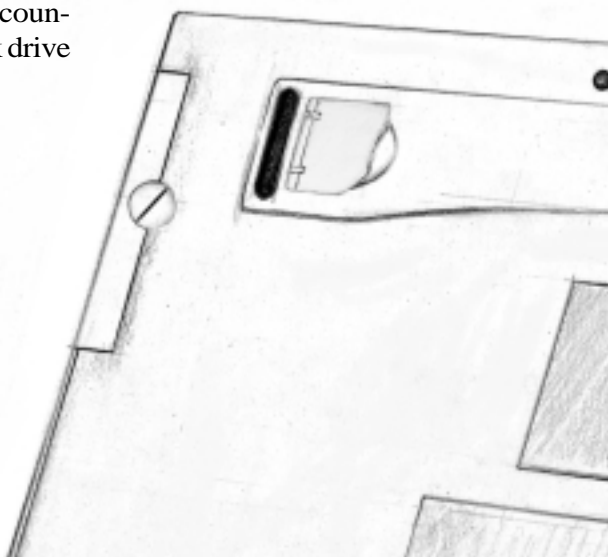

## Pointing Device

The Notebook PC's integrated touchpad pointing device is fully compatible with the two-button PS/2 mouse. The touchpad is pressure sensitive and contains no moving parts; therefore, mechanical failures are unlikely. A device driver is still required for working with some application software. See the Driver & Utility Guide for information on drivers and utilities for the touchpad.

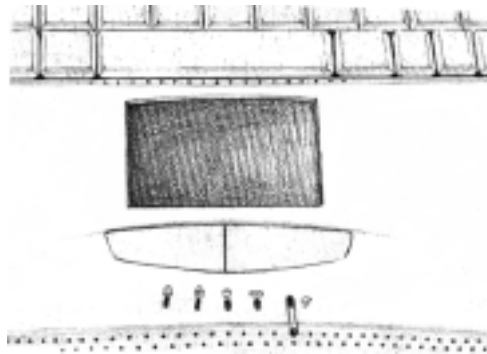

## Using the Touchpad

Light pressure with the tip of your finger is all that is required to operate the touchpad. Do not use pens or any other items with sharp tips because they may scratch the pad and damage it permanently. The Touchpad's primary function is to move the cursor around on the screen with the use of your fingertip. The illustrations shown below describe how to use the touchpad under Windows.

**Moving the cursor** - Place your finger in the center of the touchpad and do the following to move the cursor:

**Up** - Slide your finger forward

**Left** - Slide your finger to the left

**Down** - Slide your finger backward

**Right** - Slide your finger to the right

**Clicking/Tapping** - With the cursor over an item, press the left button or use the fingertip to touch the touchpad lightly and leaving the finger on the touchpad until the item is selected. The selected item will change color.

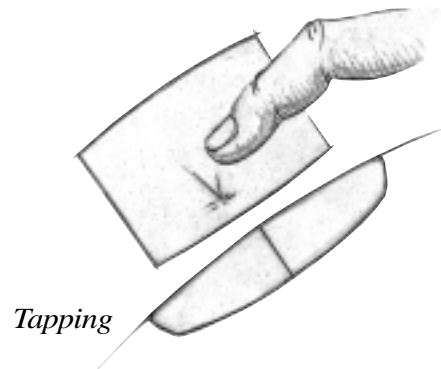
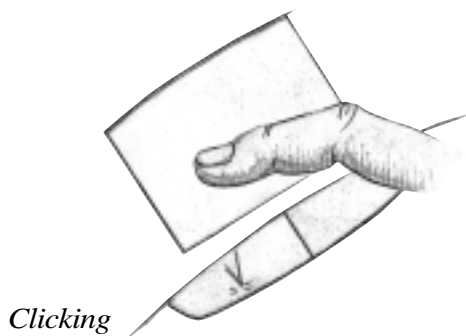

**Double-clicking/Double-tapping** - This is a common skill for launching a program directly from the corresponding icon you select. Move the cursor over the icon you wish to execute, press the left button or tap the pad twice in rapid succession, and the system launches the corresponding program. If the interval between the clicks or taps is too long, the operation will not be executed. You can set the double-click speed using the Windows Control Panel “Mouse.”

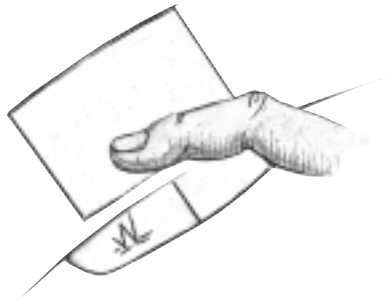

*Double-Clicking*



*Double-Tapping*

**Dragging** - Dragging means to pick up an item and place it anywhere on the screen you wish. You can move the cursor over the item you select, and while keeping the left button depressed, moving the cursor to the desired location, then release the button. Or, you can simply double-tap on the item and hold while dragging the item with your fingertip.

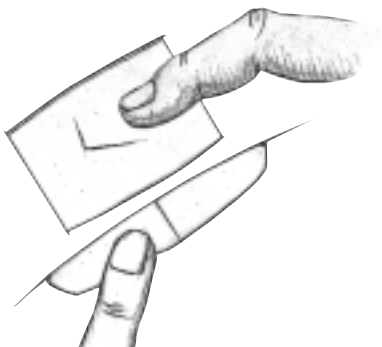

*Dragging-Clicking*

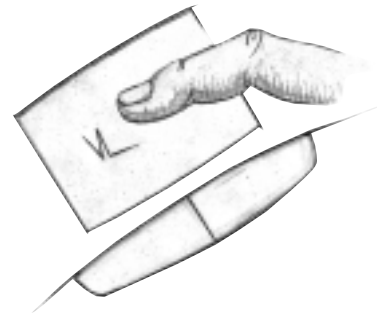

*Dragging-Tapping*



**NOTE:** A scrolling function is available after setting up the included touchpad utility to allow easy windows or web navigation. Basic functions can be adjusted in Windows control panel to allow comfortable clicking and tapping.



## Caring for the Touchpad

The touchpad is a pressure sensitive device. If not properly cared for, it can be easily damaged. Take note of the following precautions.

- Make sure the touchpad does not come into contact with dirt, liquids or grease.
- Do not touch the touchpad if your fingers are dirty or wet.
- Do not rest heavy objects on the touchpad or the touchpad buttons.



**NOTE:** The touchpad responds to movement not force. Do not tap the surface too hard. Tapping too hard does not increase the responsiveness of the touchpad. The touchpad responds best to light pressure.

## PS/2 Connection (optional)

Either a PS/2 mouse or PS/2 keyboard may be connected to the single PS/2 port. If you wish to connect two PS/2 devices, you need to use a PS/2 Y-adapter as shown in this illustration.



**TIP:** Since USB provides easy daisy chaining of many devices, it is recommended that either the external keyboard and/or the external mouse be of the USB type for quicker and more convenient connection.

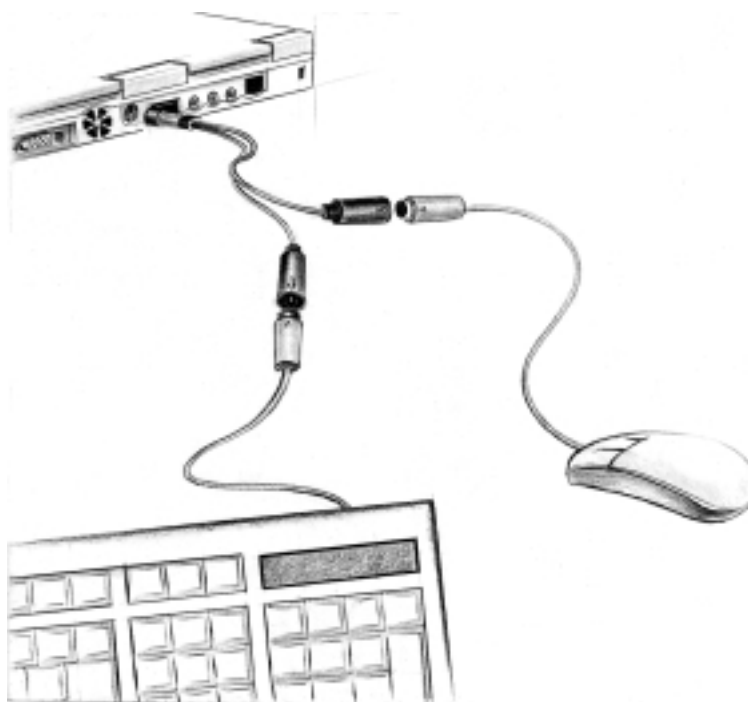

## Display Panel

Besides modem and LAN models, the Notebook PC also comes in two display sizes. You may choose from a 12.1" (800x600) or a 13.3" (1024x768) Thin-Film-Transistor (TFT) Active Matrix display panel. You can also connect an external CRT or LCD monitor through the built-in VGA connector on the rear of the Notebook PC.



**TIP:** The provided driver and BIOS allows "Stretch" capability. For example, when using applications that only displays to 640x480, you can stretch this size to cover the entire display.

## Display Definitions

- high-16/18 bit or 262,144 colors
- true-24 bit or 16 million colors
- virtual-only 800x600 is seen but when the cursor reaches the edge of the screen, panning will occur to cover a 1024x768 area.

## Windows Driver

Besides the display driver that must be installed for the integrated graphics controller, the display panel should also be set to "Laptop Display Panel" through "Display Properties." This is explained in more detail in the support CD User's Manual.



**NOTE:** When the display panel is closed, the display panel will be turned OFF to conserve power.

## Display Panel Care

The LCD screen is very delicate and requires careful handling. Pay attention to the following precautions:

- When not in use, keep the display panel closed to prevent dust accumulation.
- Do not use chemical cleaners on the screen. Wipe only with a dry cloth or tissue.
- Do not put your fingers or any objects directly on the screen.
- Do not press or lay any objects on the machine when it is closed.
- Do not carry the Notebook PC with small or sharp objects (e.g. paper clips or staples) that may enter the Notebook PC and scratch the display panel.

## External Monitor Connection (optional)

As you can see here, connecting an external monitor is just like on desktop PC. Just plug in the VGA cable and its ready. You can view the Notebook PC display panel while simultaneously allow others to view the external monitor. For large audiences, try connecting a computer video projector.

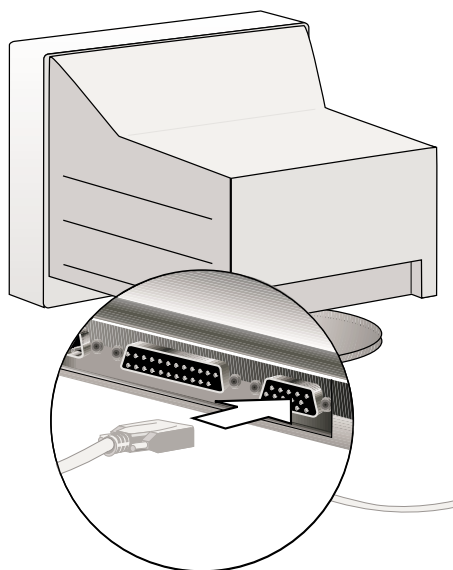

## PC Cards

The Notebook PC has two PC Card sockets designed to interface with two Type I/II or one Type III card. It allows you to expand and customize your computer to meet a wide range of application needs. The PC Card standard accommodates a number of function, communication, and data storage expansion options such as Memory/Flash Cards, FAX/Modems, Networking Adapters, and MPEG I/II decoder cards. The Notebook PC supports PCMCIA 2.1, 32bit CardBus, and Zoomed Video (ZV).

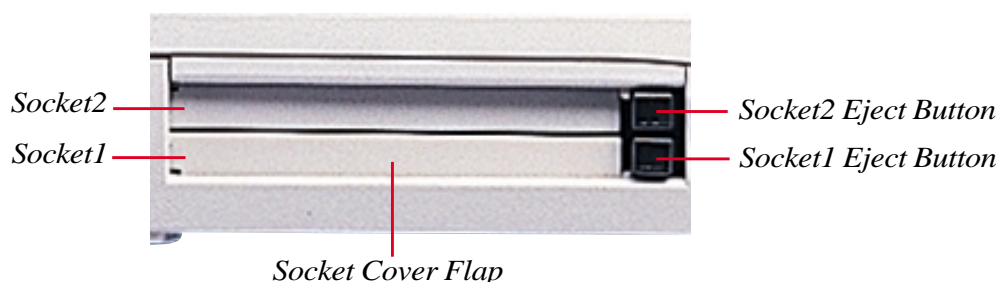

### 32-bit CardBus & Zoomed Video Port (lower socket)

CardBus support (lower socket) allows PC Cards and their hosts to use 32-bit bus mastering and operate at speeds of up to 33MHz, transferring data in burst modes comparable with PCI's 132MB/sec. By comparison, the standard 16-bit PC Card bus can handle only 20MB/sec. Since the Notebook PC is equipped with CardBus' broader, faster data pathway, it can handle bandwidth-hungry operations, such as 100Mbps Fast Ethernet, Fast SCSI peripherals, and ISDN-based video conference that are cutting-edge even for desktop systems. The CardBus peripherals support plug and play.

The CardBus socket is backward-compatible with 16-bit PC Cards serving at 5 volts operation while CardBus operates at 3.3 volts to reduce power consumption.

As part of the Notebook PC's advanced architecture, the Zoomed Video specification provides for full frame-rate video display channel for applications like MPEG decoders for movies and games, TV tuners, live video input, video capturing, and video conferencing. The Zoomed Video (ZV) port (lower socket) allows video data on a PC Card to be transferred directly into the VGA frame buffer, bypassing the CPU and PCI system bus. It can promise a high quality real-time full-motion video playback without holding back the CPU and system bus performance.

## Inserting a PC Card

1. Insert the PC card, with the connector side first and label side up, into the socket until it is flush with the Notebook PC's side.
2. Carefully connect any cables or adapters needed by the PC card. Usually a sticker or marking is used on one side of the connector to show the top side.

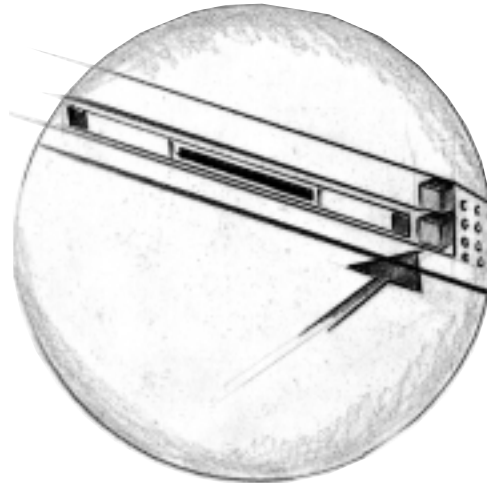

## Removing a PC Card

To remove the PC card, remove all cables or adapters attached to the PC card.

1. Press the eject button once to extend it. Press the extended eject button firmly back into the Notebook PC to eject the PC card.
2. Slowly slide the PC card out of the Notebook PC.

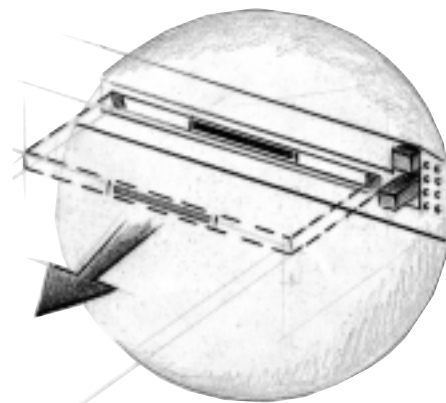
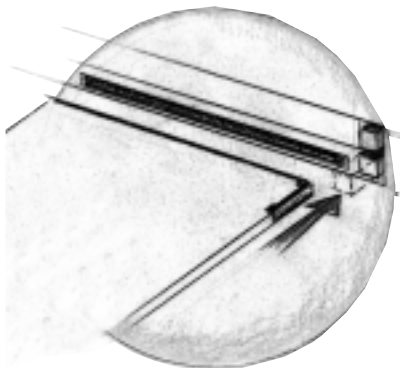

## Multimedia Sound System

The multimedia sound system features an integrated digital audio controller that produces rich, vibrant sound in high quality 16-bit stereo. With a pair of integrated stereo speakers, a built-in microphone, and both input and output audio jacks for external audio devices, the Notebook PC fulfills most multimedia computing needs. All audio features are software controlled.



### The Notebook PC's multimedia sound system features:

- Full Duplex operation
- 3D sound effect support
- 16-bit digitized audio playback
- A built-in microphone for convenient recording
- Two integrated stereo speakers
- Digitized audio recording through the Notebook PC's built-in microphone or external source

## External Audio Connections (optional)

The rear of the Notebook PC provides access for connecting a headphone or microphone just like on personal tape recorders.



**TIP: Memorize the speaker ON/OFF hotkey in case you need to mute the sound quickly. Its two keys   (<Fn><F10>) simultaneously.**

## IR Wireless Communication

The Notebook PC is equipped with an Infrared (IR) Communication Port located on the rear side. The IR port comes with IrDA Serial Infrared Data Link Version 1.1 compliance, which allows you to perform point-to-point wireless communications. You can use a SIR/FIR-specified application to transmit or receive data files with other systems equipped with an infrared port. You must set these modes in the BIOS before you start to install the IR driver and file-transferring applications. FIR (Fast Infrared) supports up to 4Mbps and SIR (Serial Infrared) supports up to 115.2Kbps.

### Guidelines for using IR communication

Follow the guidelines listed below when using the Infrared (IR) Communication:

- Make sure the IR Mode in the BIOS Setup is properly set to the mode you would like to use.
- The angle between two Infrared Communication Ports should not exceed ( $\pm 15^\circ$ ).
- The distance between the Notebook PC's IR and target device IR should not exceed 40 inches (1 m).
- Do not move either the Notebook PC or the other device during transmission of data.
- An error may occur if IR transmission is conducted in an environment with high levels of noise or vibration.

### Enabling Infrared

Infrared communication must be enabled in MS Windows. Right click on the infrared icon on the Windows taskbar and select "Enable infrared communication."

When infrared communication is enabled, moving the cursor over the icon will give its status.



**IMPORTANT:** Disable the infrared communication when you are not using the IR for long periods because the IR consumes a great deal of Windows resources which will decrease the Notebook PC's performance.

## Universal Serial Bus Port

Universal Serial Bus (USB) is a peripheral bus standard developed by PC and telecommunication industry leaders that will bring plug and play of computer peripherals outside the system, eliminating the need to install internal expansion cards and drivers.

The Notebook PC is equipped with one USB port, which uses a shielded receptacle connector. This allows computer peripherals to be automatically configured as soon as they are physically attached, without the need to reboot or run setup. USB will also allow up to 127 devices to run simultaneously on a single computer, with peripherals such as monitors and keyboards acting as additional plug-in sites, or hubs.

The Notebook PC's built-in USB host controller initiates data transfer at a full-speed of 12Mbps for digital cameras and a low-speed of 1.5Mbps for keyboards and mice. The host also manages the logical connection of devices.

## Driver Support

The Windows 98 operating system comes already equipped with a standard driver that allows your Notebook PC to recognize USB peripherals. However, new peripheral products may need software driver upgrades. Contact an authorized dealer for more information.



## AC Power System

The Notebook PC power is comprised of two parts, the power adapter and the battery power system. The power adapter converts AC power from a wall outlet to the DC power required by the Notebook PC. The battery pack consists of a set of Lithium-Ion (Li-Ion) battery cells housed together. There is one battery pack inserted in the Notebook PC. The AC Adapter's primary function is to provide power to the Notebook PC which also charges the battery pack. When the power adapter is connected to the Notebook PC, it provides power to the Notebook PC and the integrated battery charger as long as it is plugged into an electrical outlet.

## Battery Power System

The Notebook PC is designed to work with a removable battery pack located inside the battery pack compartment. A fully charged pack will provide several hours of battery life, which can be further extended by using power management features through the BIOS setup. The battery system implements the Smart Battery standard under the Windows environment, which allows the battery to accurately report the amount of charge percentage left in the battery. Additional battery packs are optional and can be purchased separately through a Notebook PC retailer. Before using the Notebook PC on battery power for the first time, check the battery icon in the Windows task bar to make sure that the battery is fully charged. Charging the battery takes a few hours when the Notebook PC is powered OFF.

### Lithium-Ion (Li-Ion) Battery Advantages (compared with traditional Nickel Metal Hydride (NiMH))

- No memory - means connect the power adapter anytime you like for maximum convenience. You don't have to wait until the battery is completely used up.
- No overheating - means safer and cooler usage and charging. This is better for your battery and your Notebook PC, so don't get burned with cheaper battery packs!
- Higher capacity vs. weight - means longer usage per charge. You no longer have to carry a dozen heavy battery packs to get through the day because Li-Ion battery packs are lighter and more efficient than NiMH battery packs.
- Longer life - means fewer battery purchases. This cuts down your battery replacement cost.

## Charging the Battery Pack

You can charge the battery pack by using the power adapter. When the power adapter is plugged in, the inserted battery pack will automatically recharge whether your Notebook PC is ON or OFF. It takes a few hours to receive a full charge when the power is OFF but takes much longer when the Notebook PC is in use. The battery is charging when the orange LED is flashing. When the LED is no longer flashing, the battery pack is fully charged.



**NOTE: The battery will stop charging if the temperature is too high or the battery voltage is too high.**

## Using Battery Power

A fully-charged Li-Ion battery pack will provide the system approximately 3 hours of working power. But the actual figure will vary depending on how you use the power saving features, your general work habits, the Notebook PC's CPU, main memory size and the type of display panel.

The "Battery Warning" beeps are automatically enabled in Windows 95/98 and will continually sound when down to 10% (configurable in Windows 98) power. The processor will also be throttled down to decrease power use.

In DOS, POWER.EXE must be enabled to use the Low Battery Warning Beep function in DOS. In Windows 3.1, W31-APM must be enabled to use the battery warning beep feature. POWER.EXE must be loaded via a DEVICE= line in CONFIG.SYS to report the status of the battery while using DOS or Windows 3.x. POWER.EXE is not necessary when running Windows 95/98. For additional information, see your DOS and Windows 3.1 User's Manuals for details.

"Low Battery" condition (3% or less) will force the Notebook PC to enter Suspend-to-Disk, regardless of power management settings but the threshold is configurable in Windows 98.



**NOTE: Battery Warning and Battery Low conditions will immediately stop upon application of the power adapter.**

## Checking Battery Power

To check the remaining battery power, move your cursor over the power icon. The power icon is a "battery" when not using AC power and a "plug" when using AC power. Double click on the icon for more information and settings.

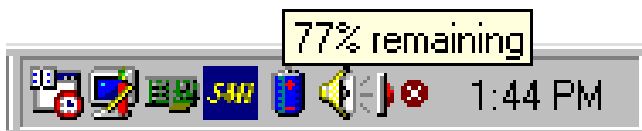

*Power icon using battery.*



*Power icon using AC power. The charging (lightning) icon appears if the battery is not fully charged.*



**NOTE: If you ignore the low battery warning, eventually the Notebook PC will enter suspend mode (either Save-to-Disk or Save-to-RAM depending on BIOS setup).**



**WARNING!** Save-to-RAM will not last long when the battery power is depleted.

## Inserting and Removing the Battery Pack

### To remove the battery pack:

1. Exit the operating system and turn OFF the power.
2. Unlock the battery by sliding the battery compartment cover downward with your thumb while pressing inward.
3. Slide the battery pack out like a drawer.

### To insert the battery pack:

1. Correctly orientate the battery pack so that the label faces upward.
2. Insert the battery pack completely into the Notebook PC with the connector first, making sure that the battery compartment cover is in the lowered position.
3. Slide the battery compartment cover up so that it is flush with the Notebook PC.

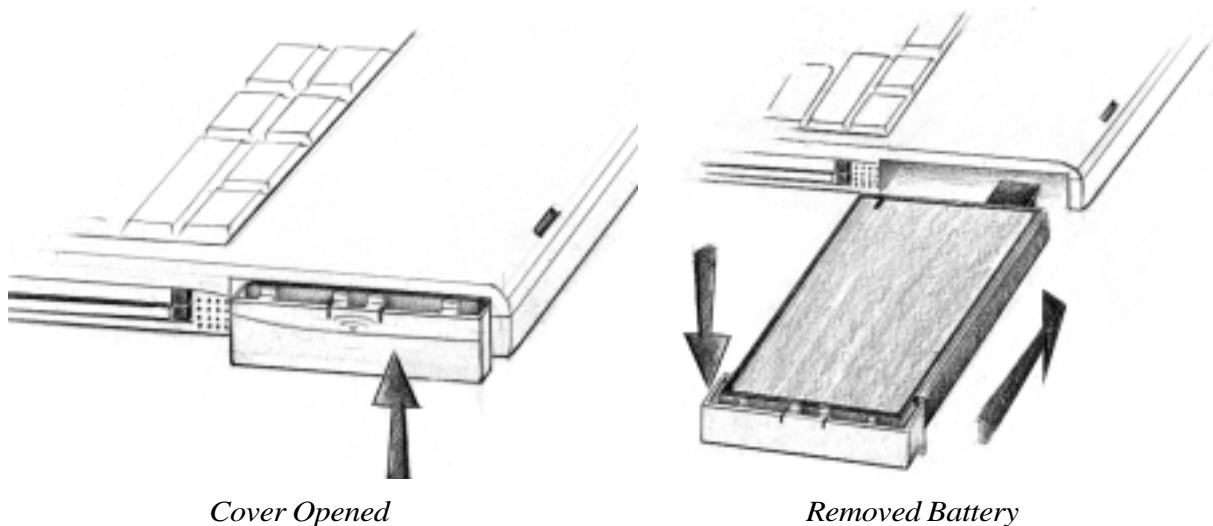

*Cover Opened*

*Removed Battery*

## Battery Care

The Li-Ion battery pack has no “Memory Effect” (officially called “Voltage Depressor”) but like all rechargeable batteries, the number of charges is limited. Fully draining and charging the battery once a day every day will last over a year but how long beyond that will depend on your environment temperature and humidity. Make sure that the battery is used in a temperature range between 50°F and 85°F, taking into account that the Notebook PC’s internal temperature is higher than the outside. Any temperatures above or below this range will shorten the life of the battery. But in any case, the battery’s usage time will eventually be too short to use and a new one must be purchased.



**WARNING!** Never attempt to remove the battery pack while the power is ON or if the system has not yet entered into the suspend mode as this may result in the loss of working data.

## Power Management Modes

The Notebook PC has a number of automatic or adjustable power saving features that you can use to maximize battery life and lower Total Cost of Ownership (TCO). You can control some of these features through the Power menu in the BIOS Setup. The power management features are designed to save as much electricity as possible by putting components into a low power consumption mode as often as possible but also allow full operation on demand. These low power modes are referred to as Standby mode and Suspend mode. The Standby mode is a simple function provided by the operating system and the suspend mode is an intense power saver provided by the Notebook PC's BIOS. When the Notebook PC is in either one of the power saving modes, the green power LED (next to the touchpad buttons) will blink.

## Full Power Mode & Maximum Performance

The Notebook PC operates in Full Power mode when the power management function is disabled by configuring the BIOS Setup. When the Notebook PC is operating in Full Power Mode, the Power LED remains ON. If you are conscious of both system performance and power consumption, select "Maximum Performance" instead of disabling all power management features.

## APM and ACPI

Advanced Power Management (APM) was developed by Intel and Microsoft for DOS/Windows 3.1/95/98 which controls only the main system power functions. Advanced Configuration and Power Management (ACPI) on the hand was developed by Intel, Microsoft, and Toshiba especially for Windows 98 to control power management and Plug and Play features on system devices designed on the Wired for Management (WfM) 2.0 baseline. Because not all external peripherals are ACPI compliant, only APM is installed by default (using the command "**setup.exe**"). Since this Notebook PC is both ACPI and WfM 2.0 compliant, you can install Windows 98 using the command "**setup /p j**". ACPI cannot be installed after Windows 98 is installed. Reinstallation with "**setup /p j**" is required on existing Windows 98 systems.

## Suspend Mode

In Suspend-to-RAM (STR) and Suspend-to-Disk (STD), the CPU clock is stopped and most of the Notebook PC devices are put in their lowest active state. The suspend mode is the lowest power state of the Notebook PC. The Notebook PC enters Suspend when the system remains idle for a specified amount of time. The timeout setting of both Hard Disk and Video can be set by the BIOS Setup. To resume system operation, press any key. The Power LED will blink when the Notebook PC is in either one of the power saving modes.

## Standby Mode

In addition to reducing the CPU clock, this mode puts devices including the LCD backlight in their lower active state. The Notebook PC enters Standby mode when the system remains idle for a specified amount of time. The timeout can be set through the BIOS Setup. To resume system operation, press any key on the keyboard, touchpad, or external mouse (or moving the mouse).

### A Customized Power-saving Example

The timeout settings for System Standby, Auto Suspend, Hard Disk Off, and Video Off specify the amount of time the system must be inactive before the next power management level is enabled. The example below demonstrates this function. If the Hard Disk Timeout is set to **2** minutes, the Standby Timeout to **8** minutes, and Auto Suspend Timeout to **10** minutes, the following power management events will take place:

1. After **2** minutes of system idle, the hard disk spins down.
2. After **6** additional minutes (a total of 8 minutes of system idle) the system enters Standby.
3. After **2** minutes in the system Standby mode (a total of **10** minutes of system idle), the system suspends to memory or to disk (depending on BIOS setup).

After the system has suspended, operation can be returned or resumed to the point in your application where it was suspended.

## Power State Summary

Power State	Entry Event	Exit Event
<b>Stand by</b>	<ul style="list-style-type: none"> <li>• Stand by through Windows Start button,</li> <li>• Timer as set though “Power Management” in Windows Control Panel or BIOS setup</li> </ul>	<ul style="list-style-type: none"> <li>• Any device</li> <li>• Battery low</li> </ul>
<b>STR</b>	<ul style="list-style-type: none"> <li>• Timer as set through BIOS setup</li> <li>• Hotkey &lt;Fn&gt;&lt;F1&gt;</li> </ul>	<ul style="list-style-type: none"> <li>• Ring indicator</li> <li>• Schedule Alarm</li> <li>• Power button</li> </ul>
<b>STD</b>	<ul style="list-style-type: none"> <li>• Timer as set through BIOS setup</li> <li>• Hotkey &lt;Fn&gt;&lt;F1&gt;</li> <li>• Battery Extremely Low</li> </ul>	<ul style="list-style-type: none"> <li>• Schedule Alarm</li> <li>• Power button</li> </ul>
<b>Soft OFF</b>	<ul style="list-style-type: none"> <li>• Power button</li> <li>• “Shut down” through Windows Start button</li> </ul>	<ul style="list-style-type: none"> <li>• Schedule Alarm</li> <li>• Power button</li> </ul>

## Thermal Power Control

There are three power control methods for controlling the Notebook PC’s thermal state. These power control cannot be configured by the user and should be known in case the Notebook PC should enter these states. The following temperatures represent the chassis temperature (not CPU).

- The fan can be turned ON or OFF for active cooling when over 131°F (55°C)
- The processor can be throttled (decreased/increased CPU speed) for passive cooling when over 158°F (70°C).
- The system can be shutdown for critical cooling when over 185°F (85°C).

## System Memory Expansion

Under some circumstances, you may find additional memory is required. This is particularly true as applications become more complex. Expanding system memory is one method of increasing system performance by decreasing hard disk access. The Notebook PC comes with 32MB 64-bit high speed SDRAM built-in. One standard 144-pin SO-DIMM socket is available for system memory expansion using common 3.3 Volt 66MHz SDRAM SO-DIMM modules. Currently, SO-DIMM memory sizes are available in 16MB, 32MB, 64MB, or 128MB for each module. The maximum memory size you can expand the Notebook PC to is 160MB using a 128MB SO-DIMM. The BIOS will automatically detect the amount of memory in the system and configure CMOS accordingly during the POST (Power-On-Self-Test) process. There is no hardware or software (including BIOS) setup required after the memory is installed. Only purchase expansion modules from your authorized retailer to ensure compatibility and reliability. The memory module must be installed by a certified Notebook PC technician.

## Processor Upgrades

Please visit your authorized service center or retailer.

## Securing Your Notebook PC

For system and hard disk drive security, see BIOS setup “Security”. A third party lock such as the ones by Kensington® can be used to secure your Notebook PC physically to an unmovable object. The cable wraps around an object and the “T” shaped end inserts into the Kensington® lock port as shown in this illustration and a key is used to secure the lock in place. For more information, please read the documentation that comes with the Notebook PC lock.

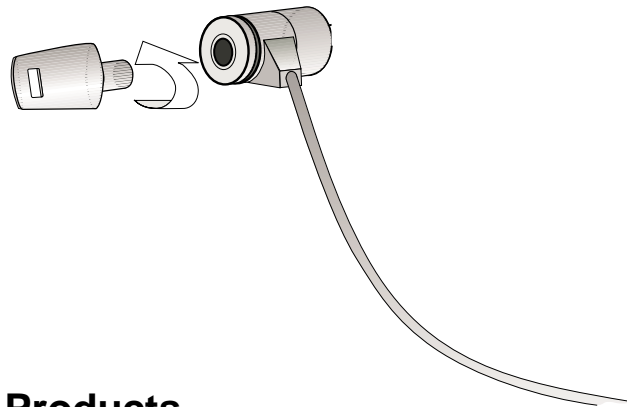

## Other Security Products

Another good security product is the PCMCIA lock. The dummy PCMCIA card with a cable inserts into the PCMCIA socket on the Notebook PC and mechanisms inside the dummy PCMCIA secures itself to the PCMCIA socket.

# Notebook PC Usage Notes and Examples

## From Desk to Desk

You may want to move your Notebook PC from desk to desk to show something to others, or ask others to review or edit your work. When moving the Notebook PC from desk to desk at work, you can free yourself from all the external peripherals and bring just the Notebook PC.

### Be sure to:

1. Keep the battery pack fully charged.
2. Log out of the network.
3. Suspend to disk or power OFF the Notebook PC.
4. Disconnect all devices.

## Between Home and Office

If you require working on the Notebook PC between home and office or between two or more offices be sure to:

1. Remove any floppy disk and CD disc.
2. Make sure that your battery pack is fully charged.
3. Log out of the network.
4. Suspend to disk or power OFF the Notebook PC.
5. Close the display panel so that it locks in place.
6. Disconnect all devices.
7. Carry the Notebook PC in a carrying bag.

## Between Countries

If you are traveling between countries, it is vital that you travel light but complete. With the modem model Notebook PC, you simplify accessories to a minimum. A third-party modem and power travel kit is vital for those who wish to use their Notebook PC in uncertain territories. Do not forget to bring extra battery packs so that you do not have to worry about finding power outlets everywhere you go.

### Be sure to:

1. Check the AC Power standard in the target country and carry extra battery packs.
2. Check the modem protocol.
3. Make sure that all accessories have their own compartment separate from the Notebook PC.





# SECTION 5

## BIOS SETUP

### Updating Your BIOS

**PHLASH.EXE** is a Flash Memory Writer utility that updates the BIOS by uploading a new BIOS file to the programmable flash ROM on the Notebook PC's motherboard. This file works only in DOS mode. To determine the BIOS version, check the code (e.g. BIOS Ver. XXXXX) displayed on the upper left-hand corner of your screen just before entering BIOS setup (after pressing the F2 key). Larger numbers represent a newer BIOS version.

### Creating a BIOS Update Floppy Disk

PHLASH works only in DOS mode. It will not work with DOS prompt in Windows and will not work with certain memory drivers that may be loaded when you boot from your hard drive. It is recommended that you reboot using a bootable floppy disk.

1. Download an updated BIOS file from the Internet (WWW or FTP) (see Contact Information) and decompress it to a bootable floppy disk.
2. From the support CD, copy **PHLASH**, **PLATFORM.BIN**, and the original **BIOS** to the same bootable floppy disk.

### Making a Bootable Floppy Disk

Making a bootable floppy disk requires that system files be available to the system, therefore it is necessary to do it from a bootable system. There are three methods in making a bootable diskette:

- Use Windows format by right-clicking on the floppy drive and selecting **Format**. Select the option "Copy system files," enter a label if you wish, and click **Start** to begin.
- Type **FORMAT A:/S** at the DOS prompt. (the "/S" command transfers system files after formatting)
- If you already have a floppy disk you would like to make bootable without having to re-format it, type **SYS A:** from the DOS prompt to transfer system files.



**NOTE: In all cases, DO NOT copy AUTOEXEC.BAT & CONFIG.SYS to the floppy disk in order to prevent loading drivers or utilities that may conflict with the BIOS update utility.**

## Updating BIOS Procedures

**WARNING!** Only update your BIOS if you have problems with your Notebook PC and you know that the new BIOS revision will solve your problems (read the BIOS release information provided on the download site before using). Careless updating can result in your Notebook PC having more problems!

1. Boot from the BIOS floppy disk you created earlier. **NOTE:** BIOS setup must specify “Floppy Drive” as the first item in the boot sequence. (see Boot Menu)
2. At the “A:\” prompt, type “**phlash/mode=3 xxxx.rom** (xxxx being the name of the BIOS file) and then press <Enter>.

**WARNING!** If you encounter problems while updating the new BIOS, DO NOT turn off your system since this might prevent your system from booting up. Just repeat the process, and if the problem still persists, restore the original BIOS file from the support CD. If the Flash Memory Writer utility was not able to successfully update a complete BIOS file, your system may not be able to boot up. If this happens, your system will need servicing.

3. The PHLASH utility will automatically update the BIOS. When the BIOS has been successfully programmed, you will be asked to press any key to restart the system. The Notebook PC should power OFF when a key is pressed, if not turn OFF the power manually.
4. Assuming that you have successfully flashed the BIOS, turn ON the power and immediately press [F2] on system bootup to enter the BIOS setup. Select the “Load Setup Defaults” on the “Exit” menu and then [Enter]. Go back to the other menus if you require BIOS configuration changes (previous BIOS settings are lost after updating the BIOS). Then select “Exit Saving Changes” to exit the BIOS setup. If the screen resolution has changed after you restart the Notebook PC, change your “Screen area” to **800 by 600** pixels (12.1” display) or **1024 by 768** pixels (13.3” display) through your operating system.

## BIOS Setup Program

This Notebook PC supports a programmable EEPROM that stores the BIOS software and can be updated using the provided utility as described in *Flash Memory Writer Utility*. This Section will guide you through the BIOS setup program by providing clear explanations for all the options. A default configuration has already been set. If you are either installing new devices or expanding main memory, you will need to enter the BIOS Setup to reconfigure your Notebook PC.

A battery backed-up CMOS RAM is used to record some basic system hardware information: clock, date, time, the error handling, and etc., even when the power is off. When the Notebook PC is turned back on, the system is configured with the values stored in the CMOS RAM.

The settings made in the BIOS Setup program intimately affect how the Notebook PC performs. It is important, therefore, to first understand all the Setup options, and second, to make settings appropriate for the way you use the Notebook PC.

The BIOS (Basic Input and Output System) Setup is a menu driven software utility that enables you to make changes to the system configuration and tailor your Notebook PC to reflect installed hardware, alter performance, and setup power saving functions. BIOS setup is used if you are setting up the Notebook PC for the first time, reconfiguring your system, or prompted to “**Run Setup**” during bootup. This section describes how to configure your system using this utility.

Even if you are not prompted to use the Setup program, at some time in the future you may want to change the configuration of your Notebook PC. For example, you may want to enable the Security Password Feature or make changes to the power management settings. It will then be necessary to reconfigure your system using the BIOS setup program so that the computer can recognize these changes and record them in the CMOS RAM of the EEPROM.

The Setup program has been designed to make it as easy to use as possible. It is a menu-driven program, which means you can scroll through the various sub-menus and make your selections among the predetermined choices.

When you start up the computer, the system provides you with the opportunity to run this program. This appears during the Power-On Self Test (POST). Press <F2> to call up the Setup utility. If you are a little bit late in pressing the mentioned key, POST will continue with its test routines, thus preventing you from calling up Setup. If you still need to call Setup, restart the system by pressing <Ctrl> + <Alt> + <Delete>, or by pressing the Reset button if available. You can also restart by turning the system OFF and then back ON again. But do so only if the first two methods fail.

**To access the BIOS Setup program, press the <F2> key immediately when you see the splash screen during bootup (about 1 second after powering ON). If you are late, you will have to restart your Notebook PC and try again. There are no other methods to enter the BIOS setup.**



**NOTE:** Because the BIOS software is constantly being updated, the following BIOS screens and descriptions are for reference purposes only and may not exactly reflect your BIOS screens.

## BIOS Menu Bar

The top of the screen has a menu bar with the following selections:

<b>MAIN</b>	Use this menu to make changes to the basic system configuration.
<b>ADVANCED</b>	Use this menu to enable and make changes to the advanced features
<b>SECURITY</b>	Use this menu to set a password to control bootup and control access to the BIOS setup menu.
<b>POWER</b>	Use this menu to configure and enable Power Management features.
<b>BOOT</b>	Use this menu to configure the default system device used to locate and load the Operating System.
<b>EXIT</b>	Use this menu to exit the current menu or specify how to exit the Setup program.

To access the menu bar items, press the right or left arrow key on the keyboard until the desired item is highlighted.

## Legend Bar

At the bottom of the Setup screen you will notice a legend bar. The keys in the legend bar allow you to navigate through the various setup menus. The following table lists the keys found in the legend bar and those that are not with their corresponding alternates and functions.

### Navigation Key(s) Function Description

---

<b>&lt;F1&gt; or &lt;Alt H&gt;</b>	Displays the General Help screen from anywhere in the BIOS Setup
<b>&lt;Esc&gt; or &lt;Alt X&gt;</b>	Jumps to the Exit menu or returns to the main menu from a sub-menu
<b>← or → (keypad arrow)</b>	Selects the menu item to the left or right
<b>↑ or ↓ (keypad arrows)</b>	Moves the highlight up or down between fields
<b>- (minus) or &lt;F5&gt;</b>	Scrolls backward through the values for the highlighted field
<b>+ (plus) or &lt;F6&gt; or space</b>	Scrolls forward through the values for the highlighted field
<b>&lt;Enter&gt;</b>	Brings up a selection menu for the highlighted field
<b>&lt;Home&gt; or &lt;PgUp&gt;</b>	Moves the cursor to the first field
<b>&lt;End&gt; or &lt;PgDn&gt;</b>	Moves the cursor to the last field
<b>&lt;F9&gt;</b>	Resets the current screen to its Setup Defaults
<b>&lt;F10&gt;</b>	Saves changes and exits Setup

## General Help

In addition to the Item Specific Help window, the BIOS setup program also provides a General Help screen. This screen can be called up from any menu by simply pressing <F1> or the <Alt> + <H> combination. The General Help screen lists the legend keys with their corresponding alternates and functions.

## Saving Changes and Exiting the Setup Program

See *Exit Menu* for detailed information on saving changes and exiting the setup program.

## Scroll Bar

When a scroll bar appears to the right of a help window, it indicates that there is more information to be displayed that will not fit in the window. Use <PgUp> and <PgDn> or the up and down arrow keys to scroll through the entire help document. Press <Home> to display the first page, press <End> to go to the last page. To exit the help window, press <Enter> or <Esc>.

## Sub-Menu

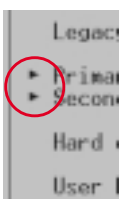

Note that a right pointer symbol (as shown in the left view) appears to the left of certain fields. This pointer indicates that a sub-menu can be launched from this field. A sub-menu contains additional options for a field parameter. To call up a sub-menu, simply move the highlight to the field and press <Enter>. The sub-menu will then immediately appear. Use the legend keys to enter values and move from field to field within a sub-menu just as you would within a menu. Use the <Esc> key to return to the main menu.

Take some time to familiarize yourself with each of the legend keys and their corresponding functions. Practice navigating through the various menus and sub-menus. If you accidentally make unwanted changes to any of the fields, use the set default hot key <F5>. While moving around through the Setup program, note that explanations appear in the Item Specific Help window located to the right of each menu. This window displays the help text for the currently highlighted field.

# Main

When the Setup program is accessed, the main menu screen appears as shown:

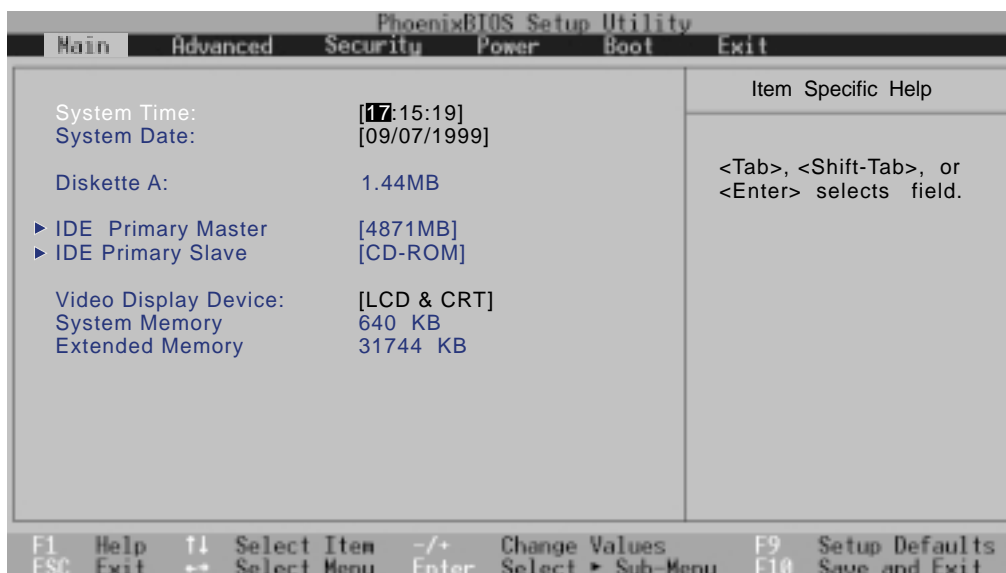

**NOTE:** In the following BIOS item descriptions, the item headings in square brackets represent the default settings for those fields.

## Main Menu Details

### System Time: (real-time display)

Sets your system to the time that you specify (usually the current time). The format is hour, minute, second. Insert the appropriate information. Use the [Tab] or [Shift] + [Tab] keys to move between the hour, minute, and second fields.

### System Date: (real-time display)

Sets your system to the date that you specify (usually the current date). The format is month, day, year. Type in the appropriate information. Use the [Tab] or [Shift] + [Tab] keys to move between the month, day, and year fields.

### Diskette A: (auto-detect)

The information is set for the type of floppy drive installed. This is a display-only field.

### >IDE Primary Master (described later)

### >IDE Primary Slave (described later)

### **Video Display Device: [LCD & CRT]**

This field allows you to select and enable video display devices, such as an LCD panel, an external CRT/LCD monitor, or both. The configuration options are: [LCD] [CRT] [LCD & CRT]

### **System Memory: (auto-detect)**

This field displays the amount of conventional memory detected by the system during bootup. You do not need to make changes to this field. This is a display only field.

### **Extended Memory: (auto-detect)**

This field displays the amount of extended memory detected by the system during bootup. The amount 31744 is the onboard memory from the factory, any amount over that is the memory added to the memory expansion slot. You do not need to make changes to this field. This is a display only field.

## IDE Primary Master

This field is used to configure the IDE Hard Disk installed in the system. To configure a hard disk drive, move the cursor to highlight the **Primary Master** field and press the Enter key to enter the sub-menu.

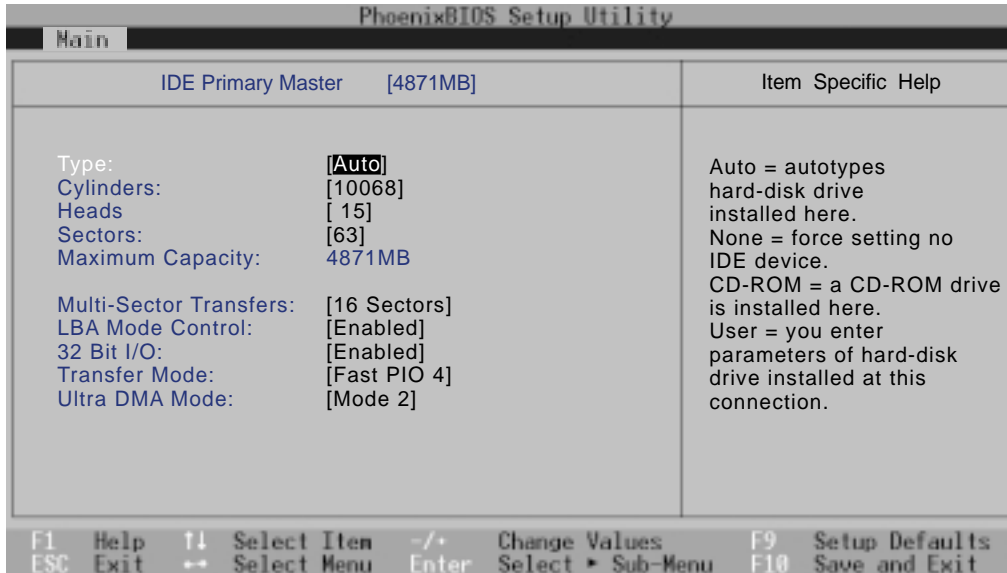

**NOTE:** Before attempting to configure a hard disk drive, make sure you have the configuration information supplied by the manufacturer of the drive. Incorrect settings may cause your system to not recognize the installed hard disk. To allow the BIOS to detect the drive type automatically, select [AUTO].

## IDE Primary Slave

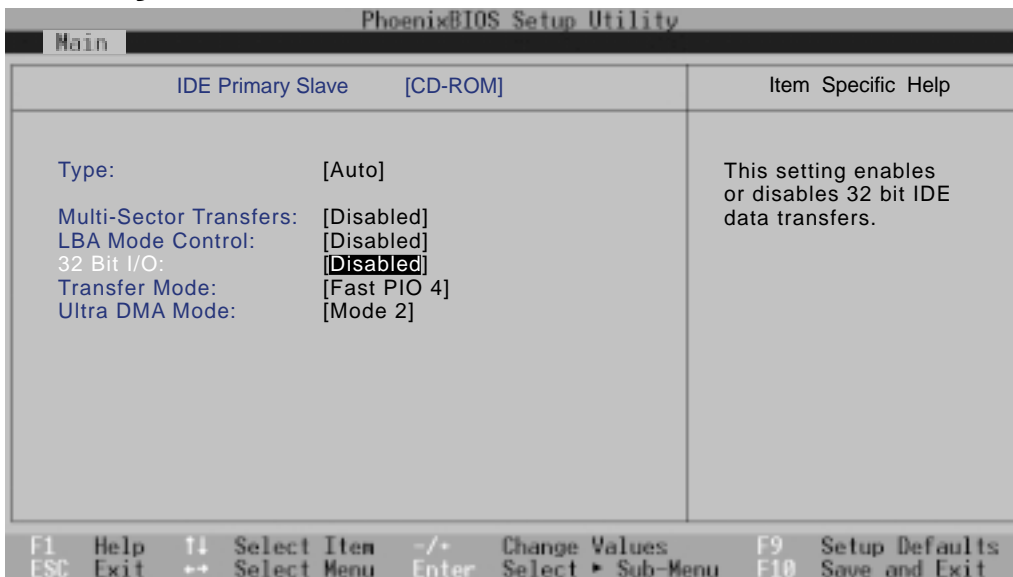



## IDE Primary Master Menu Details

### Type: [Auto]

Select **Auto** to automatically detect an IDE type drive. This option only works with standard built-in IDE drives. If automatic detection is successful, the correct values will be filled in for the remaining fields on this sub-menu.

To configure a drive, select **User**. Manually enter the number of cylinders, heads and sectors per track for your drive. Refer to your drive documentation or look on the drive for this information. If no drive is installed or if you are removing a drive and not replacing it, select **None**. Set the type to **CD-ROM** to support an inserted CD-ROM or DVD drive module and **Removable ATAPI** to support an inserted storage device module with an IDE interface as the primary master.

### Cylinders: (auto-detect or user defined)

This field configures the number of cylinders. Refer to your drive documentation to determine the correct value to enter into this field. **NOTE:** To make changes to this field, the **Type** field must be set to **User**.

### Heads: (auto-detect or user defined)

This field configures the number of read/write heads. Refer to your drive documentation to determine the correct value to enter into this field. **NOTE:** To make changes to this field, the **Type** field must be set to **User**.

### Sectors: (auto-detect or user defined)

This field configures the number of sectors per track. Refer to your drive documentation to determine the correct value to enter into this field. **NOTE:** To make changes to this field, the **Type** field must be set to **User**.

### Maximum Capacity: (auto-detect or user defined)

This field shows the drive's maximum capacity calculated automatically by the BIOS from the drive information you entered.

### Multi-Sector Transfers: (auto-detect or user defined)

This option automatically sets the number of sectors per block to the highest number supported by the drive. This field can also be configured manually. Note that when this field is automatically configured, the set value may not always be the fastest value for the drive. Refer to the documentation that came with your hard drive to determine the optimal value and set it manually. **NOTE:** To make changes to this field, the **Type** field must be set to **User**. The configuration options are: [Disabled] [2 Sectors] [4 Sectors] [8 Sectors] [16 Sectors]

### LBA Mode Control: (auto-detect or user defined)

When Logical Block Addressing is enabled, 28-bit addressing of the hard drive is used without regard for cylinders, heads, or sectors. Note that Logical Block Access may decrease the access speed of the hard disk. However, LBA Mode is necessary for drives with greater than 504MB in storage capacity. **NOTE:** To make changes to this field, the **Type** field must be set to **User**. The configuration options are: [Disabled] [Enabled]

### 32 Bit I/O: [Enabled]

When enabled, this option speeds up communication between the CPU and the IDE controller. This option supports PCI local bus only. ISA bus is not supported. The configuration options are: [Disabled] [Enabled]

### Transfer Mode: (auto-detect or user defined)

When enabled, this option speeds up communication between the system and the IDE controller by using enhanced I/O transfer modes (PIO Modes). **NOTE:** To make changes to this field, the **Type** field must be set to **User**. The configuration options are: [Standard] [Fast PIO 1] [Fast PIO 2] [Fast PIO 3] [Fast PIO 4]

### Ultra DMA Mode: (auto-detect or user defined)

This field auto detects Ultra DMA capability (for improved transfer speeds and data integrity) for compatible IDE devices. Set to Disable to suppress Ultra DMA capability. **NOTE:** To make changes to this field, the **Type** field must be set to **User**. The configuration options are: [Disabled] [Mode 0] [Mode 1] [Mode 2]



**NOTE:** After using the legend keys to make your selections on this sub-menu, press the [Esc] key to exit back to the Main menu. When the Main menu appears, you will notice that the drive size appear in the field for the hard disk drive that you just configured.

## IDE Primary Slave Menu Details

In this field, indicate the size of the disk drive or the device type, such as a CD-ROM drive. The arrow head icon indicates that this field contains a sub-menu. The sub-menu is used to configure the IDE Hard Disk installed in the system.

To configure a hard disk drive, move the cursor to highlight the **IDE Primary Slave** field, and press [Enter]. The following sub-menu screen will appear. The fields and options on this sub-menu are the same as the previous menu described earlier. Set the type as CD-ROM in this field to support an inserted CD-ROM or DVD drive module.



**NOTE:** After using the legend keys to make your selections in this sub-menu, press the [Esc] key to return to the Main menu.

## Advanced

Selecting “Advanced” from the main menu bar displays the following screen:

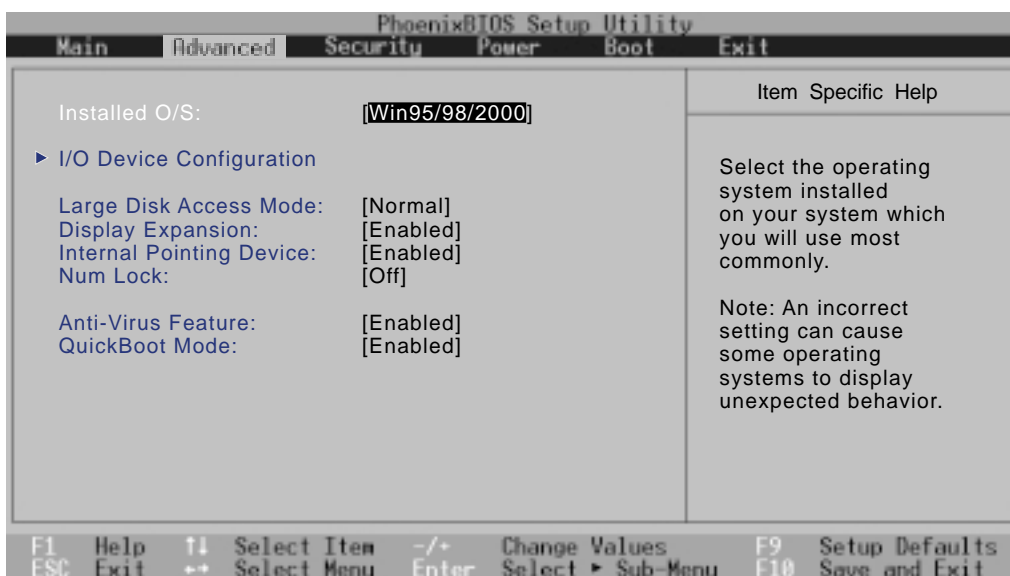

### Advanced Menu Details

#### Installed O/S: [Win95/98/2000]

This field gives the operating system information to the BIOS so that plug and play information can be set accordingly. Examples of Plug and Play operating systems are: Windows 95, Windows 98, and Windows 2000. The configuration options are: [Other] [Win95/98/2000]

#### >I/O Device Configuration: (see next section)

Pressing [Enter] when this field is highlighted calls up a sub-menu for configuring the Notebook PC's serial and parallel ports. See the Advanced sub-menu for descriptions of each sub-menu items.

#### Large Disk Access Mode: [Normal]

Specifies the type of operating system in use. The default, Normal, should be always used unless UNIX or Novell Netware is being used. The configuration options are: [Large] [Normal]

**NOTE: The Large Disk Access mode controls how the disk controller accesses the disk volume. Setting the option to Large may cause the hardware not to recognize DOS, Windows or other DOS based operating system disk formats.**

#### Display Expansion: [Enabled]

Allows lower resolution screens (such as those in DOS applications) to be stretched to fill the Notebook PC's display screen. The configuration options are: [Disabled] [Enabled]

### **Internal Pointing Device: [Enabled]**

This field allows you to enable or disable the internal touchpad. Disable the internal touchpad if you wish to use an external mouse with a scroll knob. The configuration options are: [Disabled] [Enabled]

### **Num Lock: [Off]**

Specifies the number lock function of the keypad when power is on. Auto keeps the last status during shutdown. The configuration options are: [Auto] [On] [Off]

### **Anti-Virus Feature: [Enabled]**

Protects the boot sector and partition table of your hard disk against accidental modifications. The configuration options are: [Disabled] [Enabled]

### **QuickBoot Mode: [Enabled]**

When Enabled, the system boots up faster than normal. The configuration options are: [Disabled] [Enabled]

## I/O Device Configuration

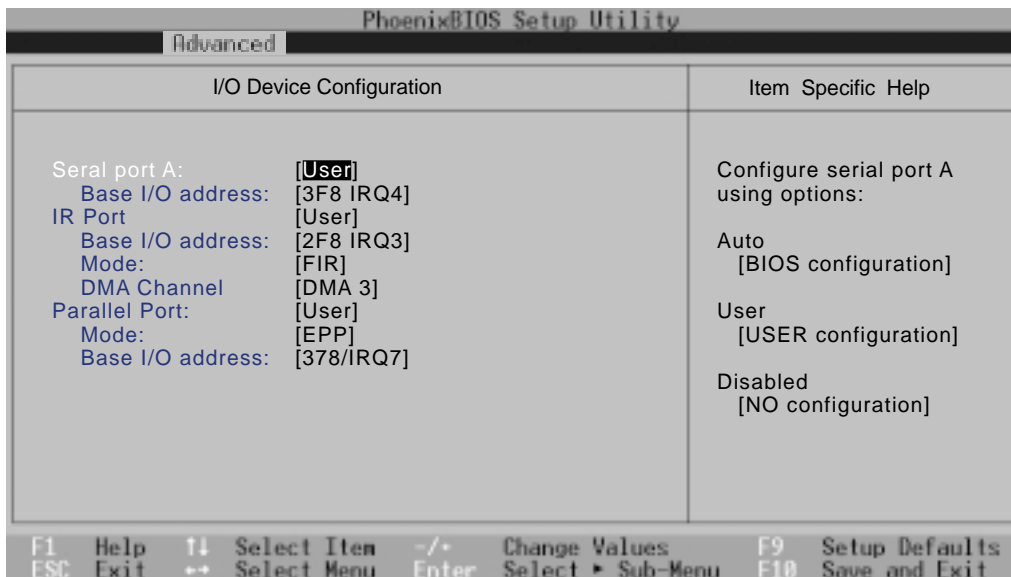

**NOTE:** The presence of sub-items in this menu is dependent on certain relevant settings.



**CAUTION!** Changing the default address and IRQ settings for COM1, COM2 and the LPT Port can cause conflicts with other system devices or installed peripherals.

### I/O Device Configuration Menu Details

#### Serial port A: [User]

This field allows you to configure the Notebook PC serial COM1 port. The configuration options are: [Disabled] [User] [Auto]

#### Base I/O address: [3F8H IRQ4]

This field allows you to configure the Notebook PC serial COM1 port. The configuration options are: [3F8, IRQ 4] [2F8, IRQ 3] [3E8, IRQ 4] [2E8, IRQ 10] [Disabled]

#### IR Port: [User]

This field allows you to configure the Notebook PC's serial IR port. The configuration options are: [Disabled] [User] [Auto]

**Base I/O address: [2F8 IRQ 3]**

This field allows you to configure the Notebook PC's serial IR port. The configuration options are: [3F8, IRQ 4] [2F8, IRQ 3] [3E8, IRQ 4] [2E8, IRQ 10] [Disabled]

**Mode: [FIR]**

This field allows you to select either Standard Infrared (SIR) or Fast Infrared (FIR) communication mode. The configuration options are: [IrDA SIR] [FIR]

**DMA channel: [DMA 3]**

The **DMA Channel** field allows you to configure the Parallel port DMA Channel for the selected **ECP** mode. **NOTE:** This field is only available when the **Parallel port** field is set to **User** and the **Mode** field is set to **ECP**. The configuration options are: [DMA 1] [DMA 3]

**Parallel port: [User]**

This field allows you to configure the Notebook PC parallel port. The configuration options are: [Disabled] [User] [Auto]

**Mode: [EPP]**

The **Mode** field allows you to configure the Notebook PC parallel port transmission mode. The configuration options are: [Output Only] [Bi-directional] [ECP] [EPP]

**EPP Mode:** When the **EPP** mode is selected, the standard and bidirectional modes are also available. The EPP operates on a two phase cycle. First, the host selects the register within a device for subsequent operations. Second, the host performs a series of read and/or write byte operations to the selected register. There are four operations supported by EPP: Address Write, Data Write, Address Read, and Data Read. All operations are performed asynchronously.

**ECP Mode:** The port is both software and hardware compatible with existing parallel ports so that it may be used as a standard printer mode if ECP is not required. ECP mode provides an automatic high burst-bandwidth channel that supports DMA for ECP in both the forward (host to peripheral) and reverse (peripheral to host) direction.

The **Output only** mode allows data output only. However, EPP and ECP are Bidirectional modes, allowing both data input and output. The EPP and ECP modes are only supported with EPP and ECP aware peripherals.

**Base I/O address: [378H/IRQ7]**

This field allows you to configure the Notebook PC parallel port. The configuration options are: [Disabled] [3BCH/IRQ7] [378H/IRQ7] [278H/IRQ5]



**NOTE:** After using the legend keys to make your selections for the I/O Device Configuration sub-menu, press the [Esc] key to exit back to the Advanced menu.

## Security

The Notebook PC's advanced system of security allows you to set a password to prevent unauthorized access to system resources, data, and the BIOS Setup Program. This Section covers each parameter of the Security Setup. Selecting "Security" from the main menu bar displays the following screen:

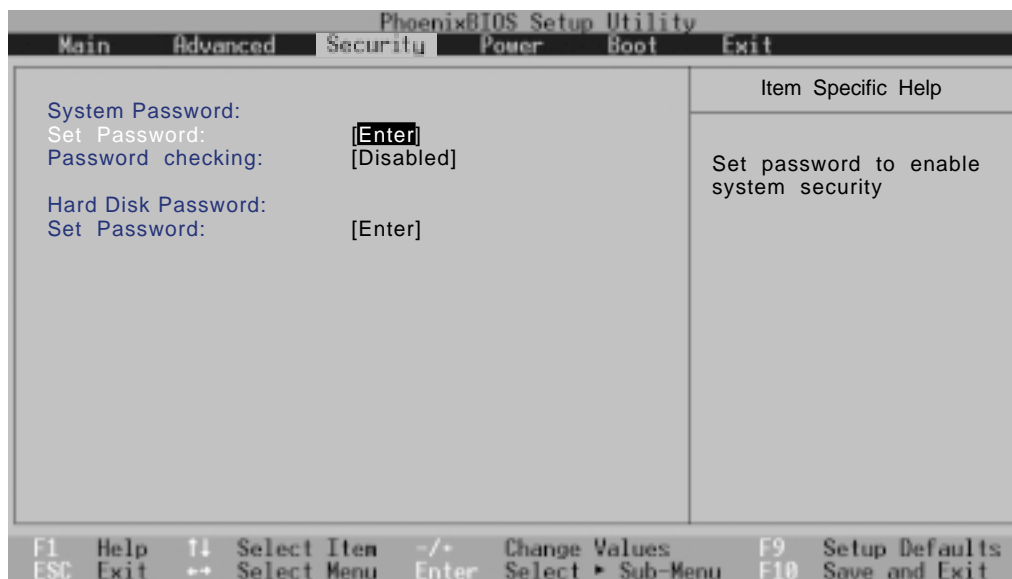

### A Note about Passwords

The BIOS Setup program allows you to specify passwords in the Security menu. The passwords control access to the BIOS and certain Security menu options during system startup. The passwords are not case sensitive. In other words, it makes no difference whether you enter a password using upper or lowercase letters.

The BIOS Setup program allows you to specify two separate passwords: a Supervisor password and a User password. When disabled, anyone may access all BIOS Setup program functions. When enabled, the Supervisor password is required for entering the BIOS Setup program and having full access to all Security menu options.

## Security Menu Details

### Set Password

This field allows you to set the User password. To set the User password, highlight this field and press [Enter].

Type the password and press [Enter]. You can type up to eight alphanumeric characters. Symbols and other keys are ignored. To confirm the password, type the password again and press the [Enter]. The User password is now set. This password allows full access to the BIOS Setup menus.

To clear the password, highlight this field and press [Enter]. The same dialog box as above will appear. Press [Enter] twice. The password is now cleared.

### Password checking

This option requires prior setting of the User password to function. When enabled, the system will then require the User password before the system can bootup. When set to **Always**, the system will then require either the User password before allowing access to the system when resuming from Save to Disk. Furthermore, booting from a diskette or CD-ROM will be disabled. The options for this field are:

[Disabled] [On Boot] [Always]

“On Boot” asks for a password when you enter BIOS setup and when booting from CD, floppy, or hard disk drive. “Always” asks for a password during the “On Boot” items plus when resuming from Save-to-Memory and Save-to-Disk.

### Hard Disk Password:

This function is set in the same way as the System Boot Entry above. Hard disk password places a protection on each hard disk drive partition so that a password is necessary in order to access the hard disk drive. If someone tries to access the hard disk drive from another computer, it would appear as if there is no usable partition on the hard disk drive. If the hard disk drive is used on this or another Notebook PC with this function, a password will be asked when the hard disk drive is accessed.

**NOTE: If used as a primary hard disk drive, the Notebook PC will access the hard disk drive when the Notebook PC is turned ON.**



## Power

The Power menu of the Setup program allows you to enable and adjust the advanced features of the Notebook PC, which are designed to conserve power. Enabling these features will extend the life of the battery pack between charges. To make changes to power management settings, select Power Savings from the menu bar. The following menu appears:

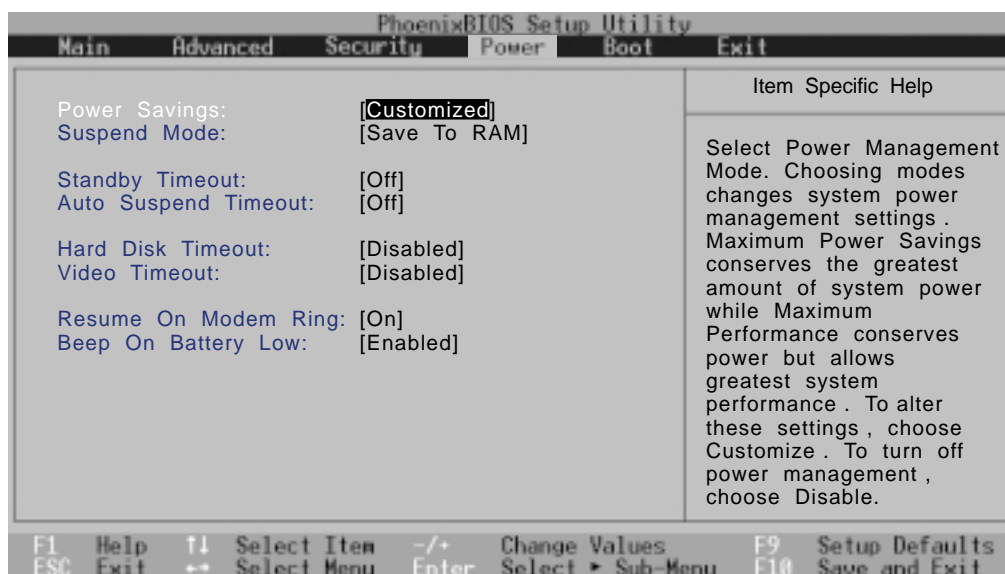

### Power Menu Details

#### Power Savings: [Customized]

This option must be enabled to use any of the automatic power saving features. The configuration options are: [Disabled] [Customized] [Maximum Power Savings] [Maximum Performance]

If this menu item is set to Disabled, power management features will not function regardless of other field settings on this menu. The Customized option allows you to make your own selections in the Power menu. When set to **Maximum Power Savings**, system power will be conserved to its greatest amount. The next four fields will then be set to predefined values that ensure maximum power savings.

When this field is set to **Maximum Performance**, best system performance is achieved with some power conservation. The next four fields will then be set to predefined values that ensure maximum power savings.

#### Suspend Mode: [Save to Ram]

This field determines the type of suspend mode when the Notebook PC enters power saving. The configuration options are: [Save To Ram] [Save To Disk]

### **Standby Timeout: [Off]**

This option is only enabled when **Customized** is selected in the **Power Savings** field. This field allows you to specify the period of inactivity before the system automatically switches to Standby mode. In Standby mode, various devices including the LCD backlight are powered off and the system enters a low power CPU state. The configuration options are: [Off] [1 Minutes] [2 Minutes] [4 Minutes] [6 Minutes] [8 Minutes] [12 Minutes] [16 Minutes]

If Advanced Power Management (APM) is installed, this function will be controlled by APM and may function differently depending on the APM settings.

### **Auto Suspend Timeout: [Off]**

This field determines how much system idle time must pass before the system enters Suspend mode. When this field is set to **Off**, the system cannot enter Suspend mode, which is the lowest power state for the Notebook PC. The configuration options are: [Off] [5 Minutes] [10 Minutes] [15 Minutes] [20 Minutes] [30 Minutes] [40 Minutes] [60 Minutes]

### **Hard Disk Timeout: [Disable]**

This field allows you to specify the period of inactivity required before the hard disk spins down and enters power saving mode. The configuration options are: [Disable] [1 Minute] [2 Minutes] [4 Minutes] [6 Minutes] [8 Minutes] [10 Minutes] [15 Minutes]

### **Video Timeout: [Disable]**

This field allows you to specify the period of inactivity required before the display panel turns off. The configuration options are: [Disable] [1 Minute] [2 Minutes] [4 Minutes] [6 Minutes] [8 Minutes] [10 Minutes] [15 Minutes]

### **Beep On Battery Low: [Enabled]**

This field allows you to enable or disable the low battery warning beep. The configuration options are: [Disabled] [Enabled]

## Boot

The Boot menu allows the user to specify the order in which the Notebook PC is to check for a device to boot the system. To make changes, select **Boot** from the menu bar and the following screen appears:

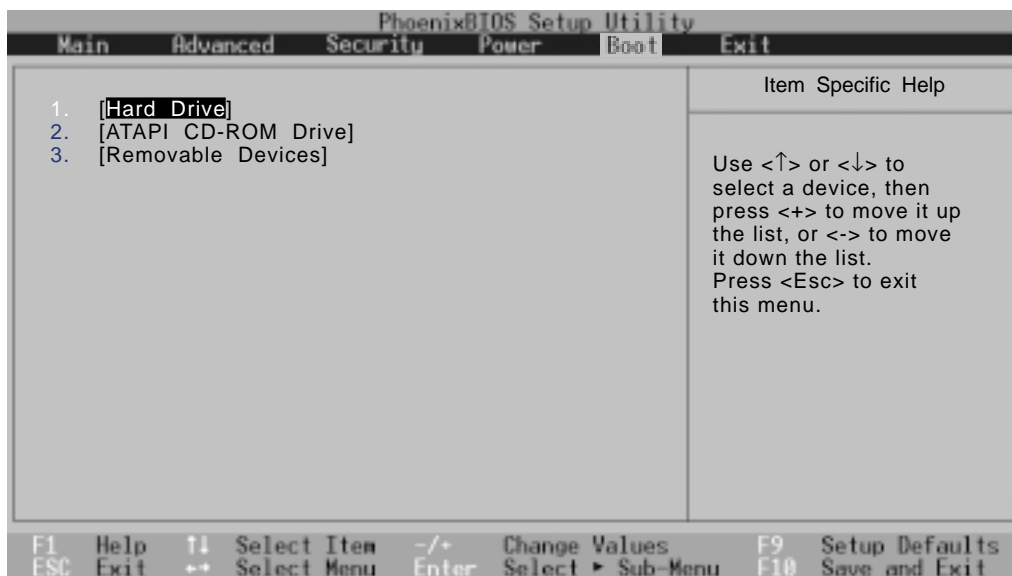

## Boot Menu Details

### Boot Sequence

1. [Hard Drive]
2. [ATAPI CD-ROM Drive]
3. [Removable Devices]

The Boot menu allows you to select among the three possible boot devices listed using the up and down arrow keys. By using the [+] or [Space] keys, you can promote devices and by using the [-] key, you can demote devices. Promotion or demotion of devices alters the priority which the system uses to search for a boot device on system power up.

## Exit

Once you have made all of your selections from the various menus in the Setup program, you should save your changes and exit Setup. Select **Exit** from the menu bar to display the following menu:

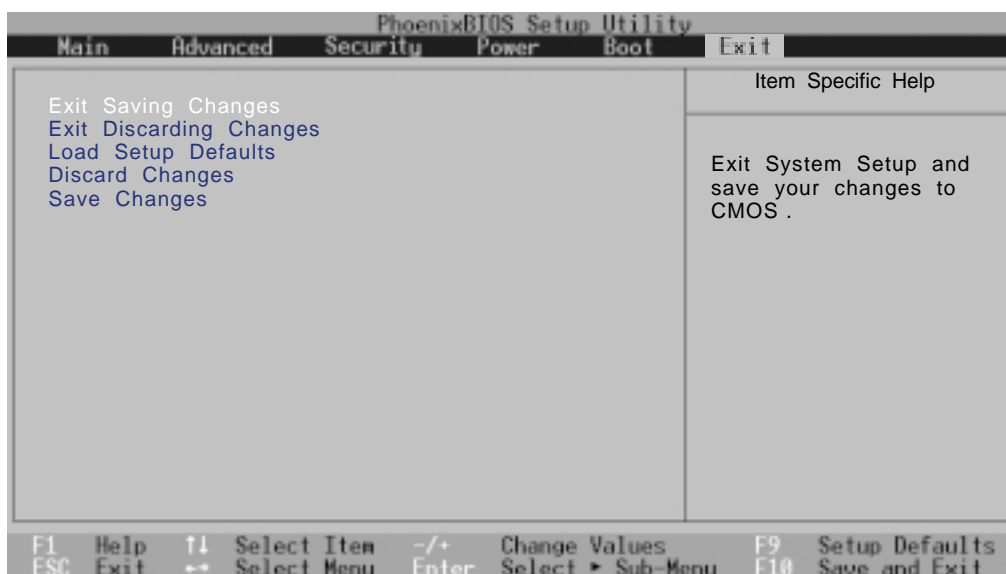

**NOTE:** Pressing the [Esc] key does not exit this menu. You must select one of the options from this menu or a menu bar item to exit this menu.

## Exit Menu Details

### Exit Saving Changes

Once you are finished making your selections, choose this option from the Exit menu to ensure the values you selected are saved to the CMOS RAM. The CMOS RAM is sustained by an onboard backup battery and stays on even when the Notebook PC is turned off. Once this option is selected, a confirmation is asked. Select **Yes** to save changes and exit.

### Exit Discarding Changes

This option should only be used if you do not want to save the changes you have made to the Setup program. If you have made changes to the fields other than system date, system time and password, the system will ask for confirmation before exiting.

## **Load Setup Defaults**

This option allows you to load the default values for each of the parameters on the Setup menus. When this option is selected or if [F9] is pressed, a confirmation is requested. Select **Yes** to load default values. You can now select **Exit Saving Changes** or make other changes before saving the values to the nonvolatile RAM.

## **Discard Changes**

This option allows you to discard the selections you made and restore the values you previously saved. After selecting this option, all selections are updated and a confirmation is requested. Select **Yes** to discard any changes and load the previously saved values.

## **Save Changes**

This option saves your selections without exiting the Setup program. You can then return to other menus and make changes. After selecting this option, all selections are saved and a confirmation is requested. Select **Yes** to save any changes to the nonvolatile RAM.



# APPENDIX

## Vehicle/Air Power Adapter Accessory

This section is provided for the optional vehical/air power adapter accessory for the Notebook PC. The main purpose of the vehicle/air power adapter is to provide a source of power for using the Notebook PC and/or charging the Notebook PC's battery from a 12VDC recepticle such as those found in vehicles and certain airplanes.

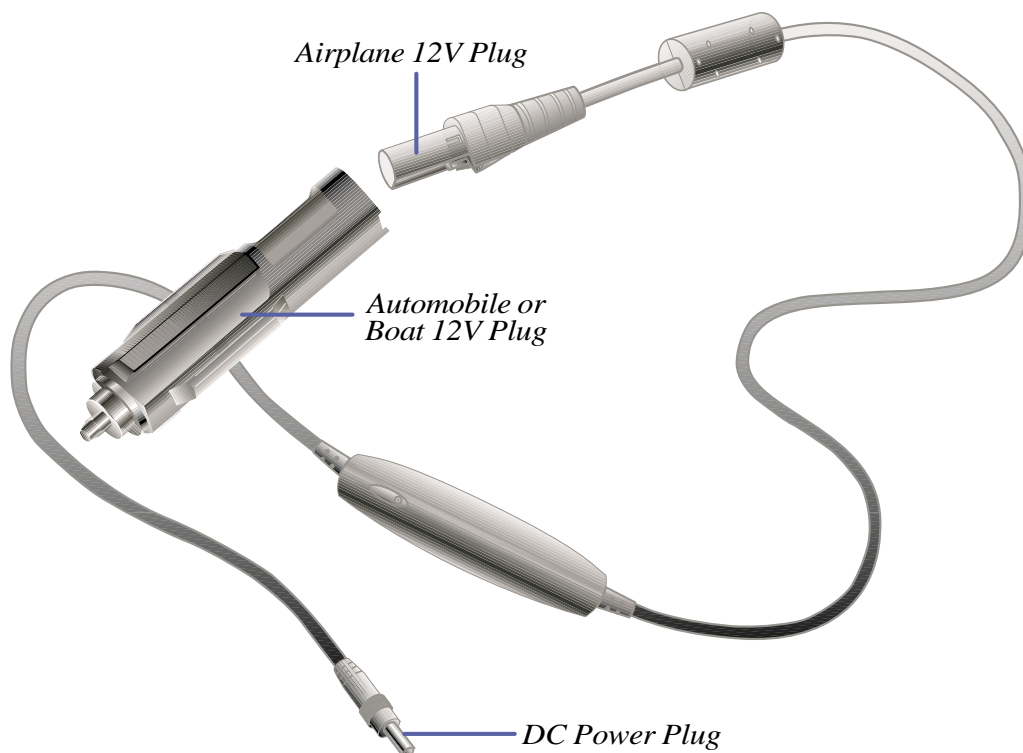

### Features

The vehical/air power adater plugs into any vehicle's 12 volt DC cigarette or utility recepticle and produces an output of 19 Volts DC 2.64 Amp/hour or 50 Watts. These recepticles may be found in automobiles, airplanes, boats, power generators, and portable power units.

### Usage

Connect the 12Volt plug into the automobile's or boat's cigarette or utility socket firmly. For airplanes, remove the adapter as shown in the illustration above.





# Internal Modem Model

## Protocols and Compliancy

The Notebook PC with internal modem model complies with JATE (Japan), FCC (US, Canada, Korea, Taiwan), and CTR21. The internal modem has been approved in accordance with Council Decision 98/482/EC for pan-European single terminal connection to the public switched telephone network (PSTN). However due to differences between the individual PSTNs provided in different countries, the approval does not, of itself, give an unconditional assurance of successful operation on every PSTN network termination point. In the event of problems you should contact your equipment supplier in the first instance.

### Overview

On 4th August 1998 the European Council Decision regarding the CTR 21 has been published in the Official Journal of the EC. The CTR 21 applies to all non voice terminal equipment with DTMF-dialling which is intended to be connected to the analogue PSTN (Public Switched Telephone Network).

CTR 21 (Common Technical Regulation) for the attachment requirements for connection to the analogue public switched telephone networks of terminal equipment (excluding terminal equipment supporting the voice telephony justified case service) in which network addressing, if provided, is by means of dual tone multi-frequency signalling.

### Network Compatibility Declaration

Statement to be made by the manufacturer to the Notified Body and the vendor: "This declaration will indicate the networks with which the equipment is designed to work and any notified networks with which the equipment may have interworking difficulties"

### Network Compatibility Declaration

Statement to be made by the manufacturer to the user: "This declaration will indicate the networks with which the equipment is designed to work and any notified networks with which the equipment may have interworking difficulties. The manufacturer shall also associate a statement to make it clear where network compatibility is dependent on physical and software switch settings. It will also advise the user to contact the vendor if it is desired to use the equipment on another network."

Up to now the Notified Body of CETECOM issued several pan-European approvals using CTR 21. The results are Europe's first modems which do not require regulatory approvals in each individual European country.

### Non-Voice Equipment

Answering machines and loud-speaking telephones can be eligible as well as modems, fax machines, auto-dialers and alarm systems. Equipment in which the end-to-end quality of speech is controlled by regulations (e.g. handset telephones and in some countries also cordless telephones) is excluded.

**This table shows the countries currently under the CTR21 standard.**

<u>Country</u>	<u>Applied</u>	<u>More Testing</u>
Austria <sup>1</sup>	Yes	No
Belgium	Yes	No
Czech Republic	No	not applicable
Denmark <sup>1</sup>	Yes	Yes
Finland	Yes	No
France	Yes	No
Germany	Yes	No
Greece	Yes	No
Hungary	No	not applicable
Iceland	Yes	No
Ireland	Yes	No
Italy	?	?
Israel	No	No
Lichtenstein	Yes	No
Luxemburg	Yes	No
The Netherlands <sup>1</sup>	Yes	Yes
Norway	Yes	No
Poland	No	not applicable
Portugal	No	not applicable
Spain	No	not applicable
Sweden	Yes	No
Switzerland	Yes	No
United Kingdom	Yes	No

This information was copied from CETECOM and is supplied without liability. For updates to this table, you may visit [http://www.cetecom.de/technologies/ctr\\_21.html](http://www.cetecom.de/technologies/ctr_21.html)

<sup>1</sup> National requirements will apply only if the equipment may use pulse dialling (manufacturers may state in the user guide that the equipment is only intended to support DTMF signalling, which would make any additional testing superfluous).

In The Netherlands additional testing is required for series connection and caller ID facilities.

## Glossary

### **ACPI (Advanced Configuration and Power Management Interface)**

Modern standard for reducing power usage in computers.

### **AUTOEXEC.BAT**

AUTOEXEC.BAT is a special-purpose file that is automatically executed by DOS whenever the computer is turned ON or restarted. This file contains important commands that help configure the system to work with certain software and devices. Windows 95 and later has its own startup files and may not use or may ignore parts of the AUTOEXEC.BAT file.

### **BIOS (Basic Input/Output System)**

BIOS is a set of routines that affect how the computer transfers data between computer components, such as memory, disks, and the display adapter. The BIOS instructions are built into the computer's read-only memory. BIOS parameters can be configured by the user through the BIOS Setup program. The BIOS can be updated using the provided utility to copy a new BIOS file into the EEPROM.

### **Bit (Binary Digit)**

Represents the smallest unit of data used by the computer. A bit can have one of two values: 0 or 1.

### **Boot**

Boot means to start the computer operating system by loading it into system memory. When the manual instructs you to "boot" your system (or computer), it means to turn ON your computer. "Reboot" means to restart your computer. When using Windows 95 or later, selecting "Restart" from "Start | Shut Down..." will reboot your computer.

### **Bus Master IDE**

PIO (Programmable I/O) IDE requires that the CPU be involved in IDE access and waiting for mechanical events. Bus master IDE transfers data to/from the memory without interrupting the CPU. Bus master IDE driver and bus master IDE hard disk drives are required to support bus master IDE mode.

### **Byte (Binary Term)**

One byte is a group of eight contiguous bits. A byte is used to represent a single alphanumeric character, punctuation mark, or other symbol.

### **Clock Throttling**

Chipset function which allows the processor's clock to be stopped and started at a known duty cycle. Clock throttling is used for power savings, thermal management, and reducing processing speed.

### **COM Port**

COM is a logical device name used by to designate the computer serial ports. Pointing devices, modems, and infrared modules can be connected to COM ports. Each COM port is configured to use a different IRQ and address assignment.

**CPU (Central Processing Unit)**

The CPU, sometimes called “Processor,” actually functions as the “brain” of the computer. It interprets and executes program commands and processes data stored in memory.

**Device Driver**

A device driver is a special set of instructions that allows the computer’s operating system to communicate with devices such as VGA, audio, ethernet, printer, or modem.

**DOS (Disk Operating System)**

DOS is the foundation on which all other programs and software applications operate, including Windows. DOS is responsible for allocating system resources such as memory, CPU time, disk space, and access to peripheral devices. For this reason, DOS constitutes the basic interface between you and your computer.

**Hardware**

Hardware is a general term referring to the physical components of a computer system, including peripherals such as printers, modems, and pointing devices.

**IDE (Integrated Drive Electronics)**

IDE devices integrate the drive control circuitry directly on the drive itself, eliminating the need for a separate adapter card (in the case for SCSI devices). UltraDMA/33 IDE devices can achieve up to 33MB/Sec transfer.

**LPT Port (Line Printer Port)**

Logical device name reserved by DOS for the computer parallel ports. Each LPT port is configured to use a different IRQ and address assignment.

**MMX**

A set of 57 new instructions based on a technique called Single Instruction, Multiple Data (SIMD), which is built into the new Intel Pentium PP/MT (P55C) and Pentium II (Klamath) CPU as well as other x86-compatible microprocessors. The MMX instructions are designed to accelerate multimedia and communications applications, such as 3D video, 3D sound, video conference.

**North Bridge**

The CPU to PCI interface, also contains the memory and cache controllers.

**PCI Bus (Peripheral Component Interconnect Local Bus)**

PCI bus is a specification that defines a 32-bit data bus interface. PCI is a standard widely used by expansion card manufacturers.

**Peripherals**

Peripherals are devices attached to the computer via I/O ports. Peripheral devices allow your computer to perform an almost limitless variety of specialized tasks.

**POST (Power On Self Test)**

When you turn on the computer, it will first run through the POST, a series of software-controlled diagnostic tests. The POST checks system memory, the motherboard circuitry, the display, the keyboard, the diskette drive, and other I/O devices.

**PS/2 Port**

PS/2 ports are based on IBM Micro Channel Architecture. This type of architecture transfers data through a 16-bit or 32-bit bus. A PS/2 mouse and/or keyboard may be used on ATX motherboards.

**RAM (Random Access Memory)**

There are several different types of RAM such as DRAM (Dynamic RAM), EDO DRAM (Extended Data Output DRAM), SDRAM (Synchronous DRAM).

**ROM (Read Only Memory)**

ROM is nonvolatile memory used to store permanent programs (called firmware) used in certain computer components. Flash ROM (or EEPROM) can be reprogrammed with new programs (or BIOS).

**SCSI (Small Computer System Interface)**

High speed parallel interface defined by the X3T9.2 committee of the American National Standards Institute (ANSI) for connecting many peripheral devices.

**SMB (System Management Bus)**

The SMB is used for managing smart batteries, reading SDRAM configuration information, and other miscellaneous system functions.

**SMI (System Management Interrupt)**

A non-maskable interrupt that causes the system to enter SMM. SMM functions include power management, USB legacy keyboard control, security, hot keys, and thermal monitoring.

**SMM (System Management Mode)**

This is the mode of operation while SMI is active.

**South Bridge**

The PCI to ISA interface, also contains many legacy devices.

**System Disk**

A system disk contains the core file of an operating system and is used to boot up the operating system.

**UltraDMA/33**

UltraDMA/33 is a new specification to improve IDE transfer rates. Unlike traditional PIO mode, which only uses the rising edge of IDE command signal to transfer data, UltraDMA/33 uses both rising edge and falling edge. Hence, the data transfer rate is double of the PIO mode 4 or DMA mode 2. (16.6MB/s x2 = 33MB/s).

**USB (Universal Serial Bus)**

A new 4-pin serial peripheral bus that allows plug and play computer peripherals such as keyboard, mouse, joystick, scanner, printer and modem/ISDN to be automatically configured when they are attached physically without having to install drivers or reboot. With USB, the traditional complex cables from back panel of your PC can be eliminated.

# Notebook PC Owner Information

This page is provided for recording information concerning your Notebook PC for future reference or for technical support. Keep this User's Manual in a secured location if passwords are filled out.

Owner's Name: \_\_\_\_\_ Owner's Telephone: \_\_\_\_\_

Manufacturer: \_\_\_\_\_ Model: \_\_\_\_\_

Retailer: \_\_\_\_\_ Telephone: \_\_\_\_\_

Display Size: \_\_\_\_\_ Serial Number: \_\_\_\_\_ Purchase Date: \_\_\_\_\_

Hard Disk Drive Manufacturer: \_\_\_\_\_ Capacity: \_\_\_\_\_

2nd Hard Disk Drive Manufacturer: \_\_\_\_\_ Capacity: \_\_\_\_\_

BIOS Version: \_\_\_\_\_ Date: \_\_\_\_\_

Accessories: \_\_\_\_\_ Serial Number: \_\_\_\_\_

Accessories: \_\_\_\_\_ Serial Number: \_\_\_\_\_

## Software

Operating System: \_\_\_\_\_ Serial Number: \_\_\_\_\_

Software: \_\_\_\_\_ Serial Number: \_\_\_\_\_

Software: \_\_\_\_\_ Serial Number: \_\_\_\_\_

## Security

Bootup Password: \_\_\_\_\_ Hard Drive Password: \_\_\_\_\_

## Network

User's Name: \_\_\_\_\_ Password: \_\_\_\_\_ Domain: \_\_\_\_\_

User's Name: \_\_\_\_\_ Password: \_\_\_\_\_ Domain: \_\_\_\_\_