

NOTEBOOK PC

USER'S MANUAL

Product Name: **Notebook PC**
Manual Revision: **1.01 E548**
Release Date: **April 2000**

SAFETY STATEMENTS

Federal Communications Commission Statement

This device complies with FCC Rules Part 15. Operation is subject to the following two conditions:

- This device may not cause harmful interference, and
- This device must accept any interference received, including interference that may cause undesired operation.

This equipment has been tested and found to comply with the limits for a class B digital device, pursuant to Part 15 of the Federal Communications Commission (FCC) rules. These limits are designed to provide reasonable protection against harmful interference in a residential installation. This equipment generates, uses, and can radiate radio frequency energy and, if not installed and used in accordance with the instructions, may cause harmful interference to radio communications. However, there is no guarantee that interference will not occur in a particular installation. If this equipment does cause harmful interference to radio or television reception, which can be determined by turning the equipment off and on, the user is encouraged to try to correct the interference by one or more of the following measures:

- Reorient or relocate the receiving antenna.
- Increase the separation between the equipment and receiver.
- Connect the equipment into an outlet on a circuit different from that to which the receiver is connected.
- Consult the dealer or an experienced radio/TV technician for help.



WARNING! The use of a shielded-type power cord is required in order to meet FCC emission limits and to prevent interference to the nearby radio and television reception. It is essential that only the supplied power cord be used. Use only shielded cables to connect I/O devices to this equipment. You are cautioned that changes or modifications not expressly approved by the party responsible for compliance could void your authority to operate the equipment.

Reprinted from the Code of Federal Regulations #47, part 15.193, 1993. Washington DC: Office of the Federal Register, National Archives and Records Administration, U.S. Government Printing Office.

Canadian Department of Communications Statement

This digital apparatus does not exceed the Class B limits for radio noise emissions from digital apparatus set out in the Radio Interference Regulations of the Canadian Department of Communications.

**This Class B digital apparatus complies with Canadian ICES-003.
Cet appareil numérique de la classe B est conforme à la norme NMB-003 du Canada.
For use with AC Adaptor Model ADP-45GB (Pour Utiliser Avec Modele ADP-45GB)**

Nordic Cautions (for Notebook PC with Lithium-Ion Battery)



CAUTION! Danger of explosion if battery is incorrectly replaced. Replace only with the same or equivalent type recommended by the manufacturer. Dispose of used batteries according to the manufacturer's instructions. (English)

VORSICHT! Explosionsgefahr bei unsachgemäßen Austausch der Batterie. Ersatz nur durch denselben oder einem vom Hersteller empfohlenem ähnlichen Typ. Entsorgung gebrauchter Batterien nach Angaben des Herstellers. (German)

ADVARSELI! Lithiumbatteri - Eksplosionsfare ved fejlagtig håndtering. Udskiftning må kun ske med batteri af samme fabrikat og type. Levér det brugte batteri tilbage til leverandøren. (Danish)

WARNING! Explosionsfara vid felaktigt batteribyte. Använd samma batterityp eller en ekvivalent typ som rekommenderas av apparattillverkaren. Kassera använt batteri enligt fabrikantens instruktion. (Swedish)

VAROITUS! Paristo voi räjähtää, jos se on virheellisesti asennettu. Vaihda paristo ainoastaan laitevalmistajan suosittelemaan tyyppiin. Hävitä käytetty paristo valmistagan ohjeiden mukaisesti. (Finnish)

ATTENTION! Il y a danger d'explosion s'il y a remplacement incorrect de la batterie. Remplacer uniquement avec une batterie du même type ou d'un type équivalent recommandé par le constructeur. Mettre au rebut les batteries usagées conformément aux instructions du fabricant. (French)

ADVARSEL! Eksplosjonsfare ved feilaktig skifte av batteri. Benytt samme batteritype eller en tilsvarende type anbefalt av apparatfabrikanten. Brukte batterier kasseres i henhold til fabrikantens instruksjoner. (Norwegian)

注意！この装置は、現在設置されている場所で妨害波の測定がされた情報技術装置です。この場所以外で使用する場合は、その場所で、再び妨害波の測定が必要となります。(Japanese)

Macrovision Corporation Product Notice

This product incorporates copyright protection technology that is protected by method claims of certain U.S.A. patents and other intellectual property rights owned by Macrovision Corporation and other rights owners. Use of this copyright protection technology must be authorized by Macrovision Corporation, and is intended for home and other limited viewing uses only *unless otherwise authorized by Macrovision Corporation*. Reverse engineering or disassembly is prohibited.

CTR 21 Approval (for Notebook PC with built-in Modem)

Danish	<p>«Udstyret er i henhold til Rådets beslutning 98/482/EF EU-godkendt til at blive opkoblet på de offentlige telefonnet som enkeltforbundet terminal. På grund af forskelle mellem de offentlige telefonnet i de forskellige lande giver godkendelsen dog ikke i sig selv ubetinget garanti for, at udstyret kan fungere korrekt på samtlige nettermineringspunkter på de offentlige telefonnet.</p> <p>I tilfælde af problemer bør De i første omgang henvende Dem til leverandøren af udstyret.»</p>
Dutch	<p>„Dit apparaat is goedgekeurd volgens Beschikking 98/482/EG van de Raad voor de pan-Europese aansluiting van enkelvoudige eindapparatuur op het openbare geschakelde telefoonnetwerk (PSTN). Gezien de verschillen tussen de individuele PSTN's in de verschillende landen, biedt deze goedkeuring op zichzelf geen onvoorwaardelijke garantie voor een succesvolle werking op elk PSTN-netwerkaansluitpunt.</p> <p>Neem bij problemen in eerste instantie contact op met de leverancier van het apparaat.»</p>
English	<p>“The equipment has been approved in accordance with Council Decision 98/482/EC for pan-European single terminal connection to the public switched telephone network (PSTN). However, due to differences between the individual PSTNs provided in different countries, the approval does not, of itself, give an unconditional assurance of successful operation on every PSTN network termination point.</p> <p>In the event of problems, you should contact your equipment supplier in the first instance.”</p>
Finnish	<p>“Tämä laite on hyväksytty neuvoston päätöksen 98/482/EY mukaisesti liitettäväksi yksittäisenä laitteena yleiseen kytkentäiseen puhelinverkkoon (PSTN) EU:n jäsenvaltioissa. Eri maiden yleisten kytkentäisten puhelinverkkojen välillä on kuitenkin eroja, joten hyväksyntä ei sellaisenaan takaa häiriötöntä toimintaa kaikkien yleisten kytkentäisten puhelinverkkojen liityntäpisteissä.</p> <p>Ongelmien ilmetessä otakaa viipymättä yhteyttä laitteen toimittajaan.”</p>
French	<p>«Cet équipement a reçu l'agrément, conformément à la décision 98/482/CE du Conseil, concernant la connexion paneuropéenne de terminal unique aux réseaux téléphoniques publics commutés (RTPC). Toutefois, comme il existe des différences d'un pays à l'autre entre les RTPC, l'agrément en soi ne constitue pas une garantie absolue de fonctionnement optimal à chaque point de terminaison du réseau RTPC.</p> <p>En cas de problème, vous devez contacter en premier lieu votre fournisseur.»</p>
German	<p>„Dieses Gerät wurde gemäß der Entscheidung 98/482/EG des Rates europaweit zur Anschaltung als einzelne Endeinrichtung an das öffentliche Fernsprechnetz zugelassen. Aufgrund der zwischen den öffentlichen Fernsprechnetzen verschiedener Staaten bestehenden Unterschiede stellt diese Zulassung an sich jedoch keine unbedingte Gewähr für einen erfolgreichen Betrieb des Geräts an jedem Netzabschlußpunkt dar.</p> <p>Falls beim Betrieb Probleme auftreten, sollten Sie sich zunächst an ihren Fachhändler wenden.“</p>
Greek	<p>«Ο εξοπλισμός έχει εγκριθεί για πανευρωπαϊκή σύνδεση μεμονωμένου τερματικού με το δημόσιο τηλεφωνικό δίκτυο μεταγωγής (PSTN), σύμφωνα με την απόφαση 98/482/ΕΚ του Συμβουλίου· ωστόσο, επειδή υπάρχουν διαφορές μεταξύ των επιμέρους PSTN που παρέχονται σε διάφορες χώρες, η έγκριση δεν παρέχει ως' εαυτής ανεπιφύλακτη εξασφάλιση επιτυχούς λειτουργίας σε κάθε σημείο απόληξης του δικτύου PSTN.</p> <p>Εάν ανακύψουν προβλήματα, θα πρέπει κυτ' αρχής να απευθύνεστε στον προμηθευτή του εξοπλισμού σας.»</p>

Italian

«La presente apparecchiatura terminale è stata approvata in conformità della decisione 98/482/CE del Consiglio per la connessione paneuropea come terminale singolo ad una rete analogica PSTN. A causa delle differenze tra le reti dei differenti paesi, l'approvazione non garantisce però di per sé il funzionamento corretto in tutti i punti di terminazione di rete PSTN.

In caso di problemi contattare in primo luogo il fornitore del prodotto.»

Portuguese

«Este equipamento foi aprovado para ligação pan-europeia de um único terminal à rede telefónica pública comutada (RTPC) nos termos da Decisão 98/482/CE. No entanto, devido às diferenças existentes entre as RTPC dos diversos países, a aprovação não garante incondicionalmente, por si só, um funcionamento correcto em todos os pontos terminais da rede da RTPC.

Em caso de problemas, deve entrar-se em contacto, em primeiro lugar, com o fornecedor do equipamento.»

Spanish

«Este equipo ha sido homologado de conformidad con la Decisión 98/482/CE del Consejo para la conexión paneuropea de un terminal simple a la red telefónica pública conmutada (RTPC). No obstante, a la vista de las diferencias que existen entre las RTPC que se ofrecen en diferentes países, la homologación no constituye por sí sola una garantía incondicional de funcionamiento satisfactorio en todos los puntos de terminación de la red de una RTPC.

En caso de surgir algún problema, procede ponerse en contacto en primer lugar con el proveedor del equipo.»

Swedish

«Utrustningen har godkänts i enlighet med rådets beslut 98/482/EG för alleuropeisk anslutning som enskild terminal till det allmänt tillgängliga kopplade telenätet (PSTN). På grund av de skillnader som finns mellan telenätet i olika länder utgör godkännandet emellertid inte i sig självt en absolut garanti för att utrustningen kommer att fungera tillfredsställande vid varje telenätsanslutningspunkt.

Om problem uppstår bör ni i första hand kontakta leverantören av utrustningen.»

Contents

SAFETY STATEMENTS	2
Federal Communications Commission Statement	2
Canadian Department of Communications Statement	2
Nordic Cautions (for Notebook PC with Lithium-Ion Battery)	3
Macrovision Corporation Product Notice	3
CTR 21 Approval (for Notebook PC with built-in Modem)	4
SECTION 1	
INTRODUCING THE NOTEBOOK PC	9
About This User's Manual	10
Notes For This Manual	10
Caring Information	11
Transportation Precautions	12
SECTION 2	
KNOWING THE PARTS	13
Top Side	14
Front Side	16
Left Side	17
Right Side	18
Rear Side	20
SECTION 3	
GETTING STARTED	23
Inserting and Removing the Battery Pack	24
Using the Battery Pack	25
Before using your Notebook PC on the road	25
Battery Care	25
Operating Systems	25
Support Software	25
Power Connection	26
Powering ON Your Notebook PC	27
The Power-On Self Test (POST)	27
Save-to-Disk Partition	28
Restarting or Rebooting	28
LED Status Indicators	29
Using the Keyboard	30
Colored Hot Keys	30
Microsoft Windows™ Keys	31
Keyboard as a Numeric Keypad	31
Keyboard as Cursors	32

SECTION 4

USING THE NOTEBOOK PC

	33
Floppy Disk Drive	34
CD/DVD-ROM Drive	35
Laser Safety	35
CDRH Regulations	35
DVD-ROM Drive (optional)	36
Overview	36
Regional Playback Information	37
Region Definitions	37
Using the CD-ROM Drive	38
Listening to Audio CD	39
Pointing Device	40
Using the Touchpad	40
Caring for the Touchpad	42
PS/2 Connection (optional)	42
External Display Connections (optional)	43
PC Cards (PCMCIA)	44
32-bit CardBus & Zoomed Video Port	44
Inserting a PC Card (PCMCIA)	45
Removing a PC Card (PCMCIA)	45
External Audio Connections (optional)	46
Printer Connection (optional)	46
IR Wireless Communication	47
Guidelines for using IR communication	47
Enabling Infrared	47
Universal Serial Bus	48
Driver Support	48
AC Power System	48
Battery Power System	49
Charging the Battery Pack	49
Using Battery Power	50
Power Management Modes	51
Full Power Mode & Maximum Performance	51
APM and ACPI	51
Suspend Mode	51
Standby Mode	52
Power State Summary	52
Thermal Power Control	53
System Memory Expansion	53
Processor Upgrades	53
Modem and Network Connections (optional)	54
Modem Connection	54
Network Connection	54
Securing Your Notebook PC	55
Other Security Products	55

SECTION 5**CONFIGURING THE BIOS****57**

Updating Your BIOS	58
Creating a BIOS Update Floppy Disk	58
Updating BIOS Procedures	59
BIOS Setup Program	60
BIOS Menu Bar	61
BIOS Legend Bar	61
Main Menu	63
IDE Primary Master	64
IDE Primary Slave	67
Advanced Menu	68
I/O Device Configuration	70
Security Menu	72
System Boot Entry	73
Hard Disk Unlock:	73
Password Usage Summary	73
The Power Menu	74
Boot Menu	76
Exit Menu	77

APPENDIX**78**

PortBar Accessory	80
Features	80
Usage	80
Docking Solution	81
Vehicle/Air Power Adapter Accessory	82
Features	82
Usage	82
Internal Modem Compliancy	83
Protocols and Compliancy	83
Glossary	85

INDEX**88**

Owner Information	90
-------------------------	----

————— **SECTION 1**
INTRODUCING THE NOTEBOOK PC

About This User's Manual
Caring Information
Transportation Precautions

About This User's Manual

You are reading the Notebook PC User's Manual. This User's Manual provides information on the various components in the Notebook PC and how to use them. The following are major sections of this User's Manuals:

1. Introducing the Notebook PC

Introduces you to the Notebook PC and this User's Manual.

2. Knowing the Parts

Gives you information on the Notebook PC's components.

3. Getting Started

Gives you information on getting started with the Notebook PC.

4. Using the Notebook PC

Gives you information on using the Notebook PC's components.

5. Configuring the BIOS

Gives you information on configuring the BIOS software.

6. Appendix

Introduces you to optional accessories and gives additional information.

Notes For This Manual

This User's Manual was created using Macintosh versions of Adobe® PageMaker™ 6.52, Adobe® Photoshop™ 5.0.2, and Macromedia® Freehand™ 8.0.1. The body text type used in this manual is "Times" (MAC) or "Times New Roman" (Windows™) and headings are "Helvetica" (MAC) or "Arial" (Windows™). A few notes and warnings in bold are used throughout this guide that you should be aware of in order to complete certain tasks safely and completely. These notes have different degrees of importance as described below:



WARNING! Information to prevent damage to components, damage to data, or personal injury.



TIP: Tips and useful information for power (advanced) computer users.



IMPORTANT: Information that must be followed in order to complete a task.



NOTE: Tips and information to aid in completing a task.

Text enclosed in < > represents a key on the keyboard; do not actually type the < > and enclosed letters.

Caring Information



WARNING! The following safety precautions will increase the life of the Notebook PC. Follow all precautions and instructions. Except as described in this manual, refer all servicing to qualified personnel. Do not use damaged power cords, accessories, or other peripherals. Do not use strong solvents such as thinners, benzene or other chemicals on or near the surface.

Disconnect the AC power and remove the battery pack(s) before cleaning. Wipe the Notebook PC using a clean cellulose sponge or chamois cloth dampened with a solution of nonabrasive detergent and a few drops of warm water and remove any extra moisture with a dry cloth.

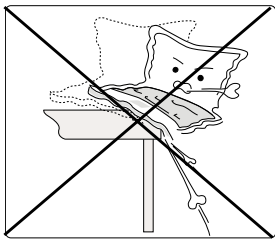

DO NOT place on uneven or unstable work surfaces. Seek servicing if the casing has been damaged.

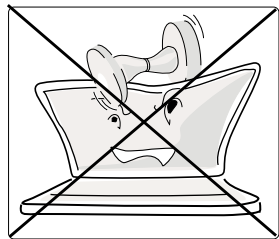

DO NOT place or drop objects on top and do not shove any foreign objects into the Notebook PC.

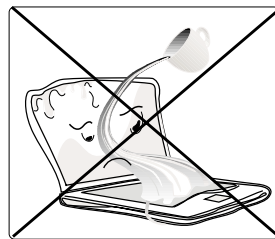

DO NOT expose to liquids, rain, or moisture. Seek servicing if liquid has been spilled into the Notebook PC.

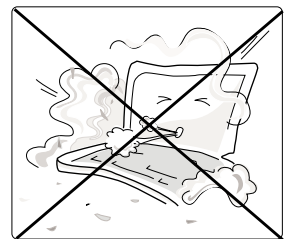

DO NOT expose to dirty or dusty environments.

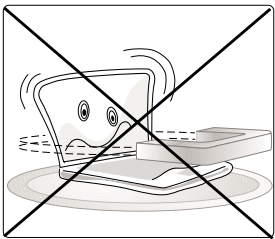

DO NOT expose to strong magnetic or electrical fields.

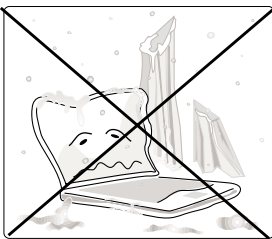

DO NOT expose to extreme temperatures (below 0°C (32°F) or above 50°C (122°F)) or to direct sunlight. Do not block the fan vents!

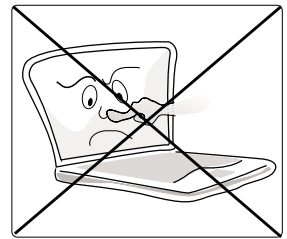
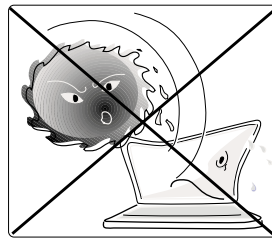

DO NOT press or touch the display panel. Do not place together with small items that may scratch or enter the Notebook PC.



NOTE: The surface glaze is easily dulled if not properly cared for. Be careful not to rub or scap the Notebook PC surfaces.

Transportation Precautions

To prepare the Notebook PC for transport, you should turn it OFF and disconnect all external peripherals to prevent damage to the connectors. The hard disk drive's head retracts when the power is turned OFF to prevent scratching of the hard disk surface during transport. Therefore, you should not transport the Notebook PC while the power is still ON. Close the display panel and check that it is latched securely in the closed position to protect the keyboard and display panel.

Remove Floppy Disks

Make sure that the 1.44MB floppy disk drive does not contain a diskette when transporting the Notebook PC. When a diskette is inserted into the floppy disk drive, the eject button protrudes out. If you attempt to transport the Notebook PC with a diskette in the drive, you risk damaging the eject button and also risk scratching the surface of the diskette when the floppy disk drive is jolted.

Cover Your Notebook PC

Use a carrying case such as the one supplied with your Notebook PC to protect it from dirt, water, shock, and scratches.

Charge Your Batteries

If you intend to use battery power, be sure to fully charge your battery pack and any optional battery packs before going on long trips. Remember that the power adapter charges the battery pack as long as it is plugged into the computer and an AC power source. Be aware that it takes much longer to charge the battery pack when the Notebook PC is in use.

Travelling Precautions

Contact your airline if you want to use the Notebook PC on the airplane. Most airlines will have restrictions for using electronic devices. Most airlines will allow electronic use only between and not during take-offs and landings.



IMPORTANT: There are three main types of airport security devices: X-ray machines (used on items placed on conveyor belts), magnetic detectors (used on people walking through security checks), and magnetic wands (hand-held devices used on people or individual items). You can send your Notebook PC and diskettes through airport X-ray machines. However, it is recommended that you do not send your Notebook PC or diskettes through airport magnetic detectors or expose them to magnetic wands.

SECTION 2

KNOWING THE PARTS

Top Side
Front Side
Left Side
Right Side
Rear Side

Top Side

Refer to the diagram below to identify the components on the top side of the Notebook PC.

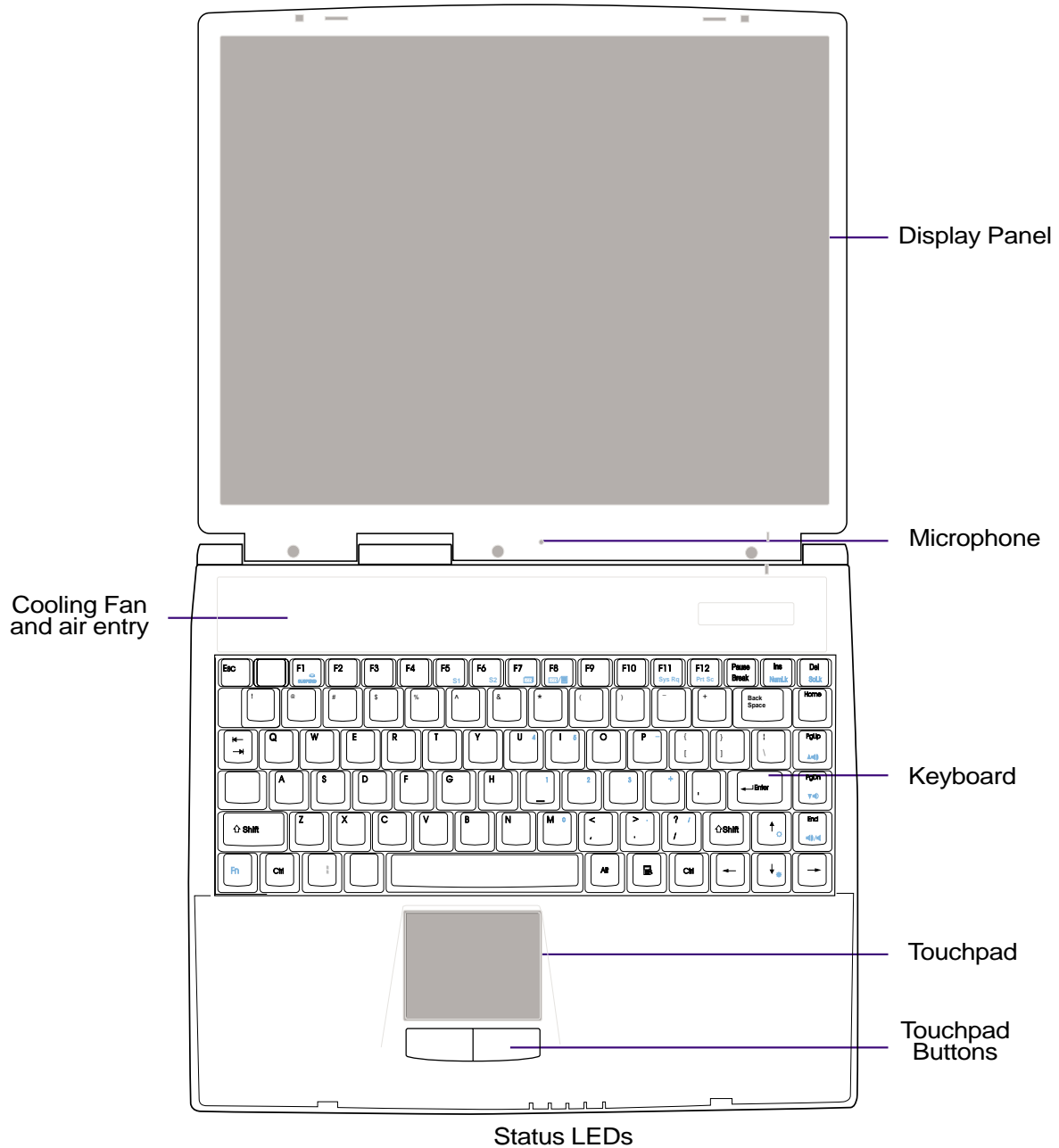

Very Light All-in-One: Including the battery pack weighs only **6.28lbs (2.85Kg)**.

The following describes the components of the Notebook PC as viewed from the top as shown by the illustration on the previous page.

Display Panel

The display panel functions the same as a desktop monitor. The Notebook PC uses a 1024x768 14.1" active matrix TFT LCD, which provides excellent viewing like that of desktop monitors. Unlike desktop monitors, the LCD panel does not produce any radiation or flickering, so it is easier on the eyes.



NOTE: While the Notebook PC is ON, closing the display panel will turn OFF the display to conserve power and opening the display panel will turn the display back ON.

Opening the Display Panel

One spring-loaded latch on the front of the Notebook PC locks the display panel in the closed position when the Notebook PC is not in use. To open the display panel, slide the latch to the left with your thumb and raise the display panel with the same thumb. This design allows a single hand to unlock and open the display panel. Slowly tilt the display panel forward or backward to a comfortable viewing angle.



WARNING! When opening, do not force the display panel down to the table or else the hinges may break! Never lift the Notebook PC by the display panel!

Display Panel Care

The LCD screen is very delicate and requires careful handling. Pay attention to the following precautions:

- When not in use, keep the display panel closed to prevent dust accumulation.
- Do not use chemical cleaners on the screen. Wipe only with a dry cloth or tissue.
- Do not put your fingers or any objects directly on the screen.
- Do not press or lay any objects on the machine when it is closed.
- Do not carry the Notebook PC with small or sharp objects (e.g. paper clips or staples) that may enter the Notebook PC and scratch the display panel.



Microphone

The built-in microphone provides a source for inputting mono audio for general note taking, voicemail recording, or for use with Internet phone software. See "Rear Side" for external microphone connection.

Cooling Fan

The cooling fan turns ON when the temperature rises past a set threshold. The cooling fan is an extra feature needed for upgrading to faster processors in the future. The top screen allows cool air to enter the Notebook PC. Do not block the area above the keyboard!

Keyboard

The keyboard provides full-sized 19mm keys with 3mm travel and palm rest. Two Windows™ function keys are provided to help ease navigation in the Windows™ operating system.

Touchpad and Buttons

The touchpad with its two buttons is a pointing device that provides the same functions as a desktop mouse. A scrolling function for Web browsing or Microsoft® Office navigation is available using the third-party software on the support CD.

Status LEDs

The Notebook PC has status LEDs to display capital lock, number lock, storage device access, battery charging, and power statuses. Details are described later in this manual.

Front Side

Refer to the diagram below to identify the components on the front side of the Notebook PC.

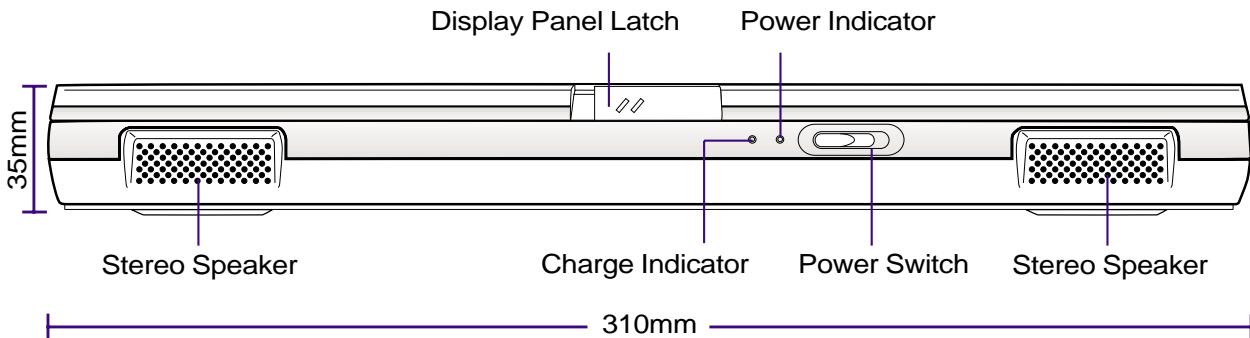

The following describes the front components of the Notebook PC as shown by the picture above.

Stereo Speakers

The two built-in speakers allow you to hear stereo audio without additional attachments. The multimedia sound system features an integrated digital audio controller that produces rich, vibrant sound in high quality 16-bit stereo. With a pair of integrated stereo speakers, a built-in microphone, and both input and output audio jacks for external audio devices, the Notebook PC fulfills most multimedia computing needs. All audio features are software controlled.

Display Panel Latch

The display latch is used to lock the display panel in the closed position. Slide the latch to the left to release the display panel.

Charge Indicator

Indicates that the battery is being charged when ON and fully charged when OFF. This LED only lights when the power adapter is used. This LED will not light if there is no battery installed. Slow flash means the battery power is low and require charging. Quick flashing means that the battery pack cannot be charged and needs replacing.

Power Indicator

The green LED will light to indicate that the Notebook PC is turned ON and blink when the Notebook PC is in Suspend-To-RAM mode. This LED will be OFF when the Notebook PC is in Suspend-To-Disk mode.

Power Switch

The power switch allows powering ON and OFF the Notebook PC. The switch normally rests on the left and is activated when moved to the right and released. To prevent accidental turning OFF the power, it is designed to take longer to turn OFF than to turn ON the power. The momentary sliding switch requires about one second to turn ON the power and about two seconds to turn OFF the power.

Left Side

Refer to the diagram below to identify the components on the left side of the Notebook PC.

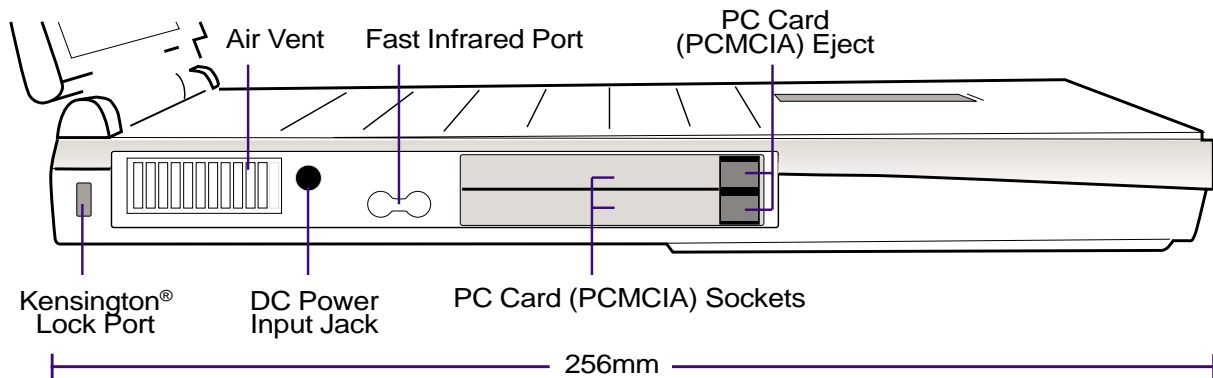

The following describes the components on the left side of the Notebook PC as shown by the illustration above.

Kensington® Lock Port

The Kensington® lock port allows the Notebook PC to be secured using Kensington® compatible Notebook PC security products. These security products usually include a metal cable and lock that prevents the Notebook PC to be removed from a fixed object. Some security products may also include a motion detector to sound an alarm when moved.

Air Vent

The left side fan vent allows warm air to exit the Notebook PC in order to cool the Notebook PC's internal components. Do not block any air vents!

DC Power Input Jack

The supplied power adapter converts AC power to DC power for use with this jack. Power supplied through this jack will supply power to the Notebook PC as well as charge the internal battery pack.

Fast Infrared Port

The fast infrared (IrDA) communication port allows convenient wireless data communication with infrared-equipped devices or computers up to 4Mbps/sec. This allows easy wireless synchronization with PDAs or mobile phones and even wireless printing to printers. If your office supports IrDA networking, you can wirelessly connect to the network anywhere where there is a direct line of sight to an IrDA node. Small offices can use IrDA technology to share a printer between several closely placed Notebook PCs and even send files to each other without a network.

PC Card (PCMCIA) Sockets and Eject

Two PCMCIA 2.1 compliant sockets for two Type I or Type II or one Type III PC card are available. The lower socket includes support for 32-bit CardBus and Zoomed Video. This allows accommodation of all Notebook PC expansion options such as memory cards, fax/modems, SCSI adapters, high-speed network adapters, and video capture/conference cards. The two eject buttons allow easy ejection of the PC cards.

Right Side

Refer to the diagram below to identify the components on the right side of the Notebook PC.

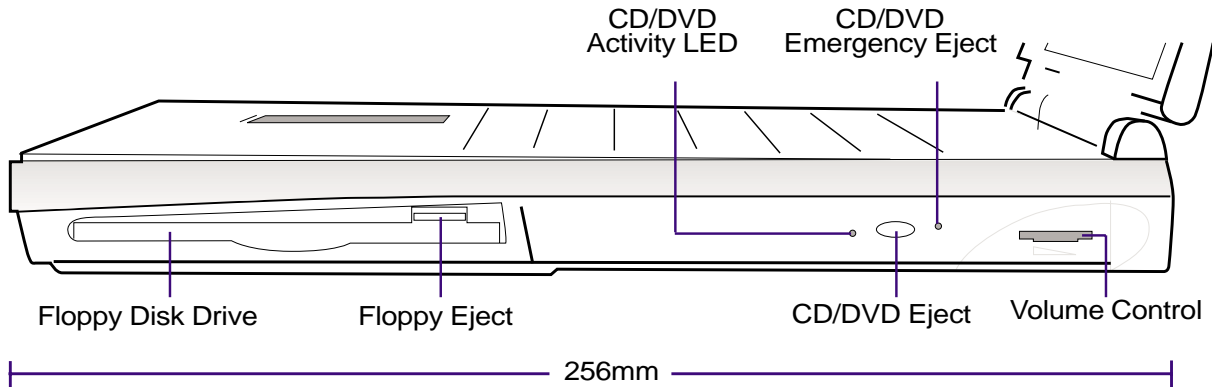

The following describes the components on the right side of the Notebook PC as shown by the illustration above.

Floppy Disk Drive and Floppy Eject

This is a standard 1.44MB floppy disk drive with Japanese 3-mode floppy support. Floppy disk activity should be seen through the activity LED next to the power button. Unlike desktop PC floppy disk drives, the eject button of the Notebook PC is on top of the opening to allow easy floppy ejection from the top.



WARNING! The floppy disk drive's eject button protrudes out of the Notebook PC when a floppy disk is fully inserted and can be easily damaged if struck. Eject the floppy disk before transporting the Notebook PC.

CD/DVD-ROM Drive

The Notebook PC comes in a 24X CD-ROM model or a 6X DVD-ROM model (the DVD-ROM is also capable of reading CDs at 24X).

CD/DVD-ROM Activity LED

The activity LED blinks proportionally to the CD/DVD-ROM drive activity and also blinks when electronically ejecting a CD/DVD.

CD/DVD-ROM Eject and Emergency Eject

The CD/DVD-ROM eject is an electronic eject button for opening the tray. You can also eject the CD/DVD through the software CD/DVD player or by right clicking the CD/DVD drive in Windows™ "My Computer." The emergency eject is used to eject a CD/DVD in case the electronic eject does not work. Do not use this in place of the electronic eject.

Volume Control

The volume control wheel allows fast adjustment of the master audio output volume. For maximum volume, the digital volume controlled through Windows™ “Volume Control” on the taskbar must also be maximized.

Hard Disk Drive

The hard disk drive is fixed internally. There is no removable hard disk drive bay.

Rear Side

Refer to the diagram below to identify the components on the rear side of the Notebook PC.

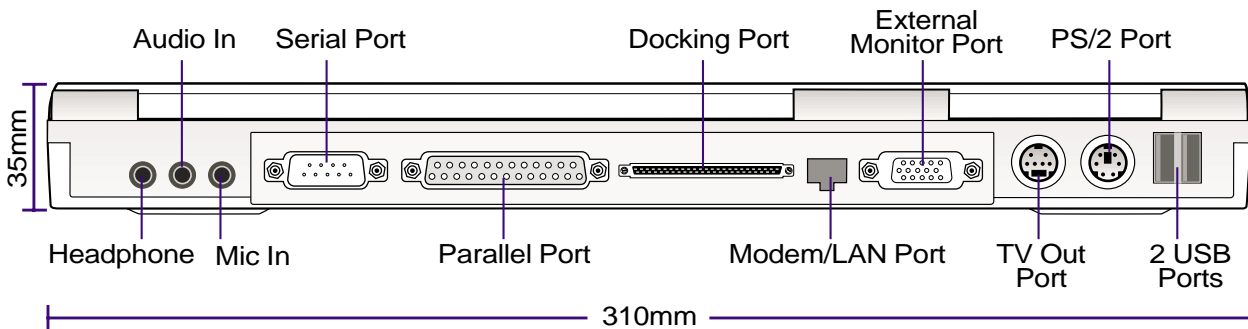

The following describes the components on the rear side of the Notebook PC as shown by the illustration above.

Headphone (Jack)

The stereo headphone jack is used to connect the Notebook PC's audio out signal to amplified speakers or headphones. Using this jack automatically disables the built-in speakers.

Audio In (Jack)

The audio in provides stereo input from audio sources.

Mic In (Microphone Jack)

The mono microphone jack can be used to connect an external microphone or output signals from audio devices. Using this jack automatically disables the built-in microphone.

Serial Port

The 9-pin D-sub serial port supports serial devices such as a drawing tablet, mouse, or modem.

Parallel Port

The 25-pin D-sub parallel/printer port supports parallel devices such as a printer or a removable drive.

Docking Port

The docking port is an expansion bus for connection to an optional proprietary PortBar.

Modem/LAN Port (modem or LAN models only)

The dual purpose port (available on internal modem or LAN models) supports an RJ11 telephone cable or an RJ45 Ethernet cable. The modem supports up to 56K V.90 transfers, and the LAN supports 10Base-T or 100Base-TX standard or duplex networks.



NOTE: The built-in modem and fast-Ethernet is also available by a dealer (not by user) upgrade if you did not choose them at the time of purchase. A modem and/or LAN can be user-installed as a PCMCIA card.



WARNING! The built-in modem does not support the voltage used in digital phone systems. Do not connect the modem port to a digital phone system or else damage will occur to the Notebook PC.

External Monitor Port

The 15-pin D-sub monitor port supports a standard VGA-compatible device such as a monitor or projector to allow viewing on a larger external display. An external monitor can also be used for dual-view or dual-application support to allow referencing data on one display while working on the other display. This feature can really increase your productivity!

TV-Out Port

For times when you need a really big display, try the TV-Out function. TV-Out allows a high definition connection to a television or video device using a Super VHS (S-Video) cable (not provided). An adapter is provided for use with RCA inputs available on all standard video devices. This port support NTSC or PAL formats.

PS/2 Port

The PS/2 port is for connecting an external PS/2 mouse or PS/2 keyboard to the Notebook PC if you do not want to use the built-in pointing device and keyboard. Simultaneous use requires the optional PS/2 Y-adapter.

USB Port

Universal Serial Bus (USB) supports many USB compatible devices such as keyboards, pointing devices, video cameras, modems, hard disk drives, printers, monitors, and scanners connected in a series up to 12Mbits/sec. In order to connect more USB devices, you can purchase a third party USB hub. USB supports hot-swapping of devices so that peripherals can be connected or disconnected while the Notebook PC is ON.

SECTION 3

GETTING STARTED

Inserting/Removing Battery Pack
Using the Battery Pack
Operating Systems
Power Connection
Powering ON Your Notebook PC
Save-to-Disk Partition
Restarting or Rebooting
LED Status Indicators
Using the Keyboard

Inserting and Removing the Battery Pack



Your Notebook PC may or may not have its battery pack inserted. If your Notebook PC does not have its battery pack inserted, there will be a large opening on the bottom of the Notebook PC. Use the following procedures to install or remove the battery pack.

To insert the battery pack:

1. Insert the battery pack with the connector side over the connectors in the battery compartment as indicated by arrow [1].

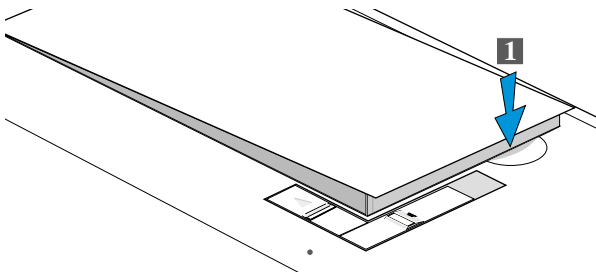

2. Slide the longer (battery) latch as indicated by arrow [2].

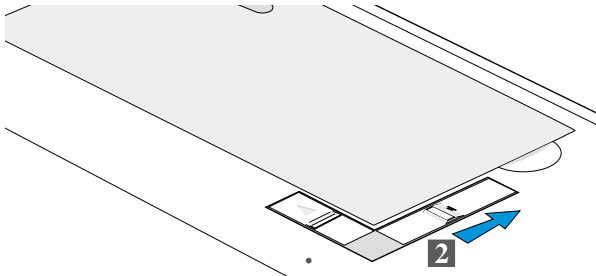

3. The shorter (safety) latch will automatically snap behind the longer latch as indicated by arrow [3].

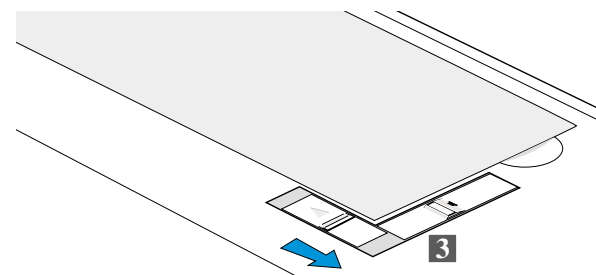

To remove the battery pack:

1. Slide the shorter (safety) latch as indicated by arrow [1].

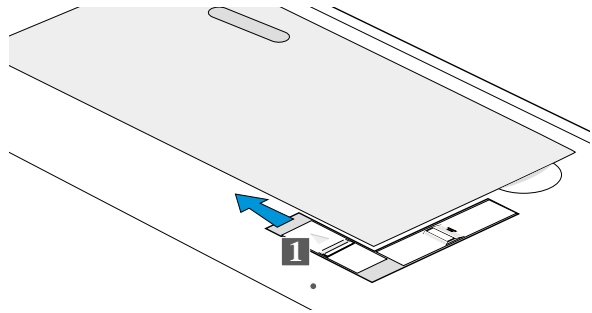

2. Slide the longer (battery) latch as indicated by arrow [2].

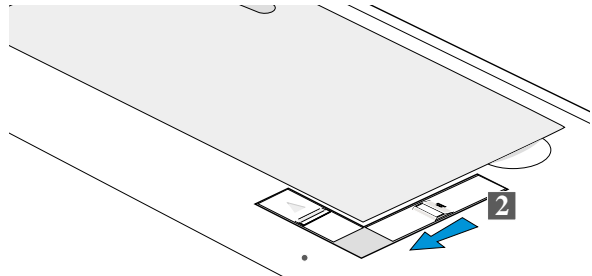

3. While holding the longer (battery) latch, lift up on the battery pack at the indentation as indicated by arrow [3].

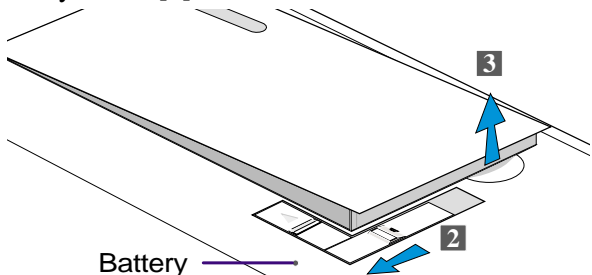

WARNING! Never attempt to remove the battery pack while the battery power LED is ON, as this may result in the loss of working data.

Using the Battery Pack

Before using your Notebook PC on the road

Before you use your Notebook PC on the road, you will have to charge the battery pack. The battery pack begins to charge as soon as the Notebook PC is connected to external power. Fully charge the battery pack before using it for the first time. A new battery pack must completely charge before the Notebook PC is disconnected from external power. The battery pack is fully charged when the battery charge light turns OFF. It takes about 3 hours to fully charge the battery when the Notebook PC is turned OFF and about 5 hours when the Notebook PC is turned ON.

Battery Care

The Li-Ion battery pack has no “Memory Effect” (officially called “Voltage Depressor”) but like all rechargeable batteries, the number of charges is limited. Fully draining and charging the battery once a day every day will last over a year but how long beyond that will depend on your environment temperature and humidity. Make sure that the battery is used in a temperature range between 10°C and 29°C (50°F and 85°F), taking into account that the Notebook PC’s internal temperature is higher than the outside. Any temperatures above or below this range will shorten the life of the battery. But in any case, the battery’s usage time will eventually be too short to use and a new one must be purchased.

Operating Systems

This Notebook PC offers its customers the choice of a pre-installed operating system such as Microsoft Windows 95, Windows 98, or Windows NT 4.0. The choices and languages will depend on territory.

Support Software

This Notebook PC will come with a support CD that provides BIOS, drivers and applications to enable hardware features, extend functionality, help manage your Notebook PC, or add functionality not provided by the native operating system. If updates or replacement of the support CD is necessary, contact your dealer for web sites to download individual software drivers and utilities.

The support CD contains all drivers, utilities and software for all popular operating systems including those that have been pre-installed. The support CD does not include the operating system itself. The support CD is necessary even if your Notebook PC came pre-configured in order to provide additional software not included as part of the factory pre-install.

A recovery CD is optional and includes an image of all the drivers and utilities included on the factory installed hard drive as well as the operating system itself. The recovery CD provides a comprehensive recovery solution that quickly restores the Notebook PC’s operating system and software to its original working state provided that your hard disk drive is in good working order. Contact your retailer if you require such a solution.

Power Connection

Your Notebook PC comes with a universal AC-DC adapter. That means that you may connect the power cord to any 110V-120V as well as 220V-240V outlets without setting switches or using power converters. Different countries may require that an adapter be used to connect the provided US-standard AC power cord to a different standard. Most hotels will provide universal outlets to support different power cords as well as voltages. It is always best to ask an experienced traveler about AC outlet voltages when bringing power adapters to another country.



TIP: You can buy travel kits for the Notebook PC that includes power and modem adapters for almost every country.

With the AC power cord connected to the AC-DC converter, connect the AC power cord to an AC outlet (preferably with surge-protection) and then connect the DC plug to the Notebook PC. Connecting the AC-DC adapter to the AC outlet first will allow you to test the AC outlet's power and the AC-DC converter itself for compatibility problems before connecting the DC power to the Notebook PC. The green power LED on the adapter will light if the power is within accepted ranges.



WARNING! Damage may occur if you use a different adapter to power the Notebook PC or use the Notebook PC's adapter to power other electrical devices. If there is smoke, burning scent, or extreme heat coming from the AC-DC adapter, seek servicing. Seek servicing if you suspect a faulty AC-DC adapter. You may damage both your battery pack(s) and the Notebook PC with a faulty AC-DC adapter.



NOTE: This Notebook PC may come with either a two or three-prong plug depending on territory. If a three-prong plug is provided, you must use a grounded AC outlet or use a properly grounded adapter to ensure safe operation of the Notebook PC.

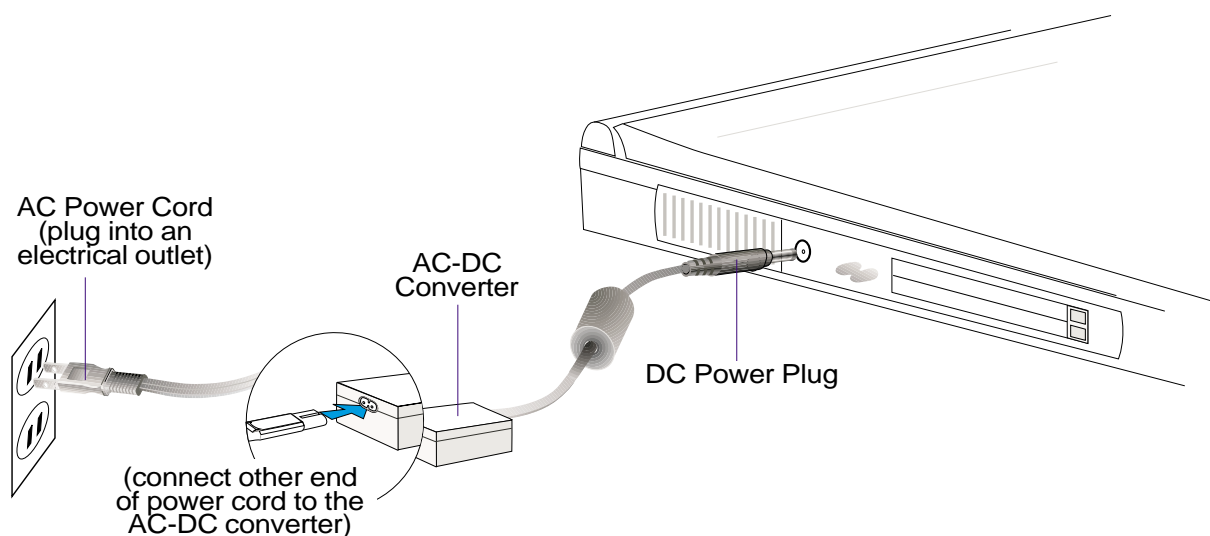

Powering ON Your Notebook PC

The Notebook PC's power-ON message will appear on the screen followed by a short beep when you turn it ON. If necessary, you may adjust the brightness by using the hot keys. If you need to run the BIOS Setup to set or modify the system configuration, press [F2] upon bootup to enter the BIOS Setup.



WARNING! Never turn OFF or reset your Notebook PC while the hard disk or floppy disk is in use and the activity LED is lit; doing so can result in loss or destruction of your data. To protect the hard disk drive, always wait at least 5 seconds after turning OFF your Notebook PC before turning it back ON.



NOTE: Before bootup, the display panel will flash when the power is turned ON. This is part of the Notebook PC's test routine and is not a problem with the display.

The Power-On Self Test (POST)

When you turn ON the Notebook PC, it will first run through a series of software-controlled diagnostic tests called the Power-On Self Test (POST). The software that controls the POST is installed as a permanent part of the Notebook PC's architecture. The POST includes a record of the Notebook PC's hardware configuration, which is used to make a diagnostic check of the system. This record is created by using the BIOS Setup program. If the POST discovers a difference between the record and the existing hardware, it will display a message on the screen prompting you to correct the conflict by running BIOS Setup. In most cases the record should be correct when you receive the Notebook PC. When the test is finished, you may get a message reporting "No operating system found" if the hard disk was not pre-loaded with an operating system. This indicates that the hard disk is correctly detected and ready for the installation of a new operating system.

The S.M.A.R.T. (Self Monitoring and Reporting Technology) will check the hard disk drive during POST and will give a warning message if the hard disk drive requires servicing. If any critical hard disk drive warning is given during bootup, backup your data immediately and run Windows disk checking program. To run Windows' disk checking program: (1) right-click any hard disk drive icon in "My Computer", (2) choose Properties, (3) click the Tools tab, (4) click Check Now, (5) select a hard disk drive, (6) select Thorough to also check for physical damages, and (7) click Start. Third party disk utilities such as Symantec's Norton Disk Doctor can also perform the same functions but with greater ease and more features.



WARNING! If warnings are still given during bootup after running a software disk checking utility, you should take your Notebook PC in for servicing. Continued use may result in data loss.

Save-to-Disk Partition

The Notebook PC supports Advanced Power Management to save battery power and extend its working time. One type of power management is “Save-to-Disk.” Save-to-Disk is a suspend mode where your operating system and application data is saved to a separate partition and retrieved when the Notebook PC comes out of suspend mode. A partition is a space on the hard disk drive equivalent to having a second hard disk drive. If you would like the Notebook PC to support the Save-to-Disk mode, run the **PHDISK.EXE** utility to setup a Save-to-Disk partition on your hard disk. The Save-to-Disk partition must be larger than the total system memory of the Notebook PC. To check whether a Save-to-Disk partition exist on your hard drive, run **FDISK.EXE** located in Windows’ command directory or Windows rescue floppy disk. You can also compare your working partition’s size with the hard drive’s size as shown in BIOS setup. See the Drivers and Utilities Support CD User’s Manual for detailed usage instructions.



WARNING! All other partitions and their data will be cleared by the PHDISK.EXE utility. This must be done BEFORE you install an operating system onto your hard disk. The included hard disk drive comes with the Save-to-Disk partition pre-configured from the factory.

Restarting or Rebooting

After installing drivers (please see the “Drivers and Utilities Guide”), installing applications, or making configuration changes, you may be prompted to restart the system to update the operating system and complete the installation process. To restart the system, press the <Ctrl><Alt> keys simultaneously. This is known as a “warm boot.” If this “warm boot” does not restart the Notebook PC, you can reset the Notebook PC by using a “cold boot” which is switching the Notebook PC’s power OFF and then back ON. Remember to wait 5 seconds before switching the Notebook PC back ON.

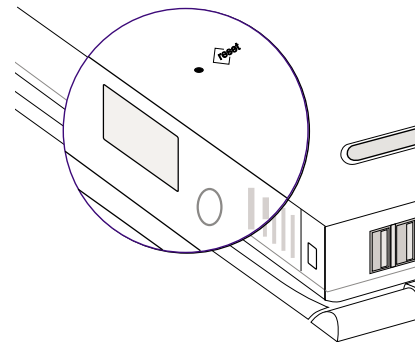

NOTE: If neither of these methods work, you can press the reset button located in a small hole on the bottom-left side of the Notebook PC .

Powering OFF the Notebook PC

For operating systems equipped with APM or ACPI (Windows 98/2000), the Notebook PC can be powered OFF by using **Start | Shut Down... | Shut down**. For operating systems without proper power management (DOS, Windows NT), you must power OFF the Notebook PC by holding the power switch for 2 seconds (as opposed to 1 second to power ON) after closing applications and exiting operating systems. This is necessary in order to prevent accidental power-OFFs. It will take 4 seconds to power OFF the Notebook PC if you do it while the Notebook PC hangs and stopped responding,

LED Status Indicators

There are several LED status indicators on the Notebook PC. The LED status indicators give information on the Notebook PC's current operating and keyboard statuses. The following illustration shows the meaning of each status LED.

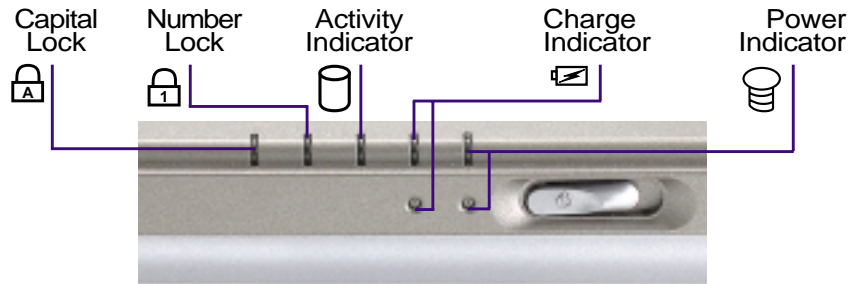

The following gives a description for each of the LED status indicators.

Capital Lock

Indicates that capital lock [Caps Lock] is activated when lighted. Capital lock allows some of the keyboard letters to type using capitalized letters (e.g. A, B, C). When the capital lock light is OFF, the typed letters will be in the lower case form (e.g. a,b,c).

Number Lock

Indicates that number lock [Num Lk] is activated when lit. Number lock allows some of the keyboard letters to act as numbers for easier numeric data input.

Activity Indicator

Indicates that the Notebook PC is accessing the floppy, hard disk, CD/DVD-ROM drive. The light flashes proportional to the access time.

Charge Indicator

Indicates that the battery is being charged when ON and fully charged when OFF. This LED only lights when the power adapter is used. This LED will not light if there is no battery installed. Slow flash means the battery power is low and require charging. Quick flashing means that the battery pack cannot be charged and needs replacing.













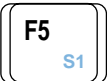

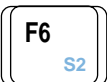
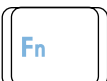



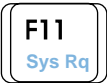

Power Indicator

The green LED will light when the power is ON and blink when in suspend-to-RAM mode. This LED will be OFF when in suspend-to-disk mode.

Using the Keyboard

Colored Hot Keys

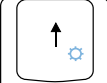
The following defines the colored hot keys on the Notebook PC's keyboard. The colored commands can only be accessed by first pressing and holding the function key while pressing a key with a colored command.

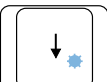
		Suspend: Places the Notebook PC in suspend mode (either Save-to-RAM or Save-to-Disk depending on BIOS setup). This is not the same as “stand by” in MS Windows.
		S1: Programmable Key 1. Using the provided software, a set of instructions can be assigned to this key.
		S2: Programmable Key 2. Using the provided software, a set of instructions can be assigned to this key.
		LCD: Toggles the display panel ON and OFF. This is a quick way to hide your work.
		LCD/Monitor Icons: Toggles between the Notebook PC's LCD display and an external monitor in this series: Notebook PC LCD -> External Monitor -> Both
		TV Icon: Toggles the TV output ON and OFF. This allows you to independently hide the TV display when using TV output, such as in between presentations.
		Sys Rq: Submits a “System Request” command. This function is used by terminals in order send a line of input to the SSCP, typically a logoff message, which will then disconnect the terminal from the connected application.
		Prt Sc: Submits a “Print Screen” command. In DOS, this will print the screen to the LPT1 port. In Windows, this will capture your screen into memory.
		Num Lk: Toggles the numeric keypad (number lock) ON and OFF. Allows you to use a larger portion of the keyboard for number entering.
		Scr Lk: Toggles the “Scroll Lock” ON and OFF. Allows you to use a larger portion of the keyboard for cell navigation.
		Open Sun: Increases the display brightness. If the display appears too dark, use this command.
		Solid Sun: Decreases the display brightness. If the display appears to bright, use this command.



NOTE: Hot Keys work only on the Notebook PC's own keyboard and not on any externally connected keyboards.

Microsoft Windows™ Keys

There are two special Windows™ keys on the keyboard as described below.

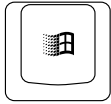





The key with the Windows™ Logo activates the Start menu located at the bottom left of the Windows™ desktop.



The other key, which looks like a Windows™ menu with a small cursor, activates the properties menu and is equivalent to pressing the right mouse button on a Windows™ object.

Keyboard as a Numeric Keypad

The numeric keypad is embedded in the keyboard and consists of 15 keys that make number intensive input more convenient. These dual-purpose keys are labeled in orange on the key caps. Numeric assignments are located at the upper right hand corner of each key as shown in the figure. When the numeric keypad is engaged by pressing  , the number lock LED will light. If an external keyboard is connected, pressing the  on the external keyboard will enable/disable NumLock on both keyboards in unison. To disable the Notebook PC's numeric keypad while keeping the keypad on an external keyboard activated, press the   keys on the Notebook PC.

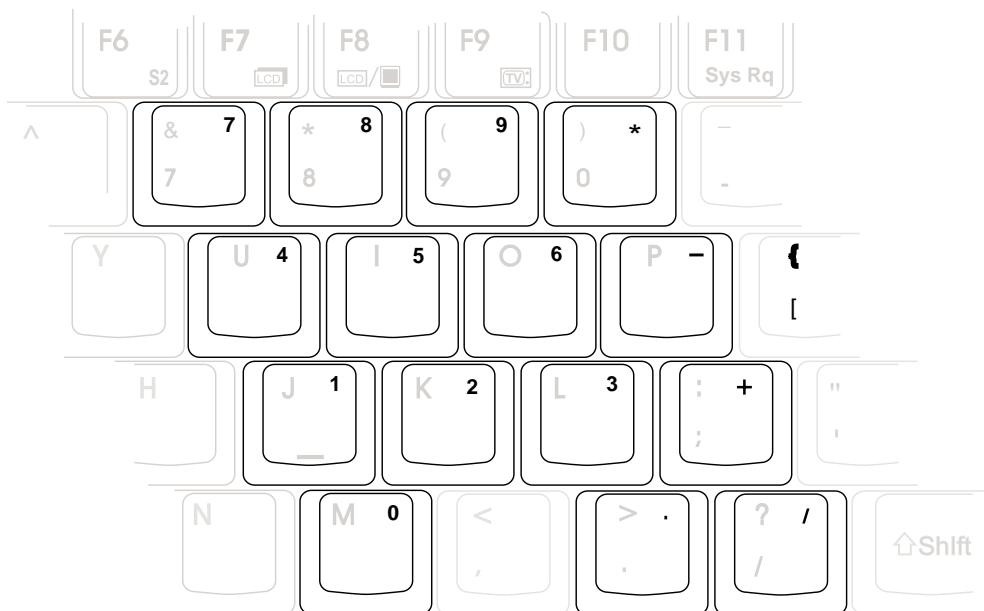

Keyboard as Cursors

The keyboard can be used as cursors while Number Lock is ON or OFF in order to increase navigation ease while entering numeric data in spreadsheets or similar applications.

With Number Lock OFF, press  and one of the cursor keys shown below. For example <Fn><8> for up, <Fn><K> for down, <Fn><U> for left, and <Fn><O> for right.

With Number Lock ON, use <Shift> and one of the cursor keys shown below. For example <Shift><8> for up, <Shift><K> for down, <Shift><U> for left, and <Shift><O> for right.



NOTE: The second status LED (from the left) will light when Number Lock is ON and turn OFF when Number Lock is OFF.

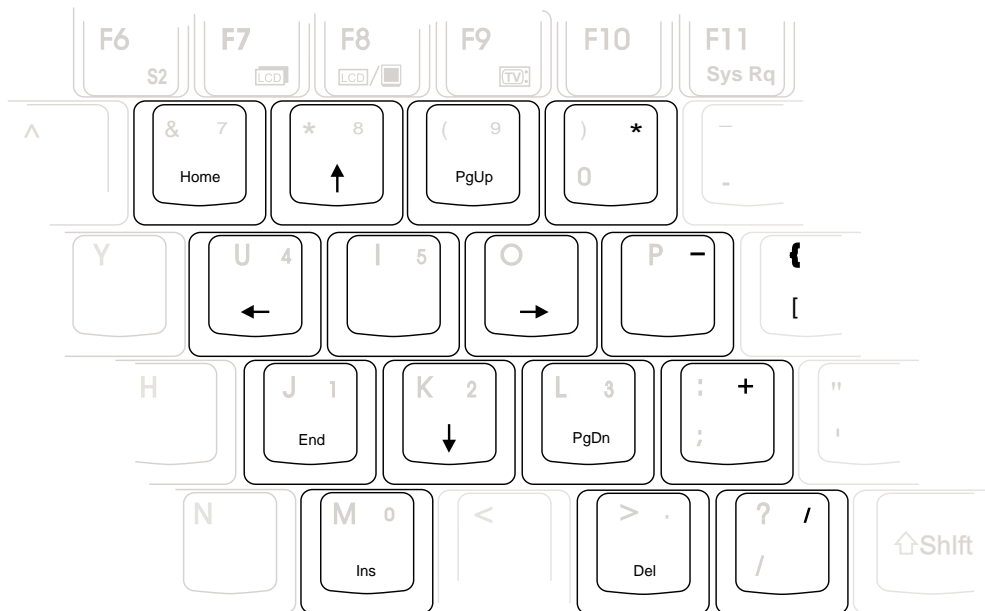

NOTE: The large bold characters and symbols are printed here for your reference. They are not labeled on the keyboard as shown here.

SECTION 4

USING THE NOTEBOOK PC

Floppy Disk Drive
CD-ROM Drive
DVD-ROM Drive
Pointing Device
PS/2 Connection
External Monitor Connection
PC Cards (PCMCIA)
External Audio Connections
IR Wireless Communication
Universal Serial Bus
AC Power System
Battery Power System
Power Management Modes
System Memory Expansion
Processor Upgrades
Modem and Network
Securing Your Notebook PC

This Section describes the basic features and procedures for using your Notebook PC. Topics covered include the floppy drive, CD/DVD-ROM drive, pointing device, and other input and output devices.

Floppy Disk Drive

The Notebook PC features a slim 3.5-inch floppy disk drive that accepts a standard 1.44MB (or 720KB) floppy diskette. The eject button is placed on the top edge of the floppy disk drive for easy access, unlike desktop PCs with the eject button on the bottom of the floppy disk drive. The floppy activity can be monitored through the activity indicator LED on the front of the Notebook PC.



WARNING! Because the eject button protrudes out when a floppy diskette is inserted, you must remove the floppy diskette during transport to prevent breakage of the eject button.

CD/DVD-ROM Drive



NOTE: The letters “CD-ROM” or “CD” will mainly be used in all documentation because of its wide familiarity, although “CD/DVD-ROM” or “CD/DVD” should be more appropriate with the DVD-ROM model Notebook PC. Please substitute where appropriate.

The CD-ROM (Compact Disc Read Only Memory) drive can support all the popular formats: Audio/Music CDs; Photo CDs; MS-DOS MSCDEX Mode 1 / Mode 2; CD-ROM/XA; CD-I; and Video CDs.

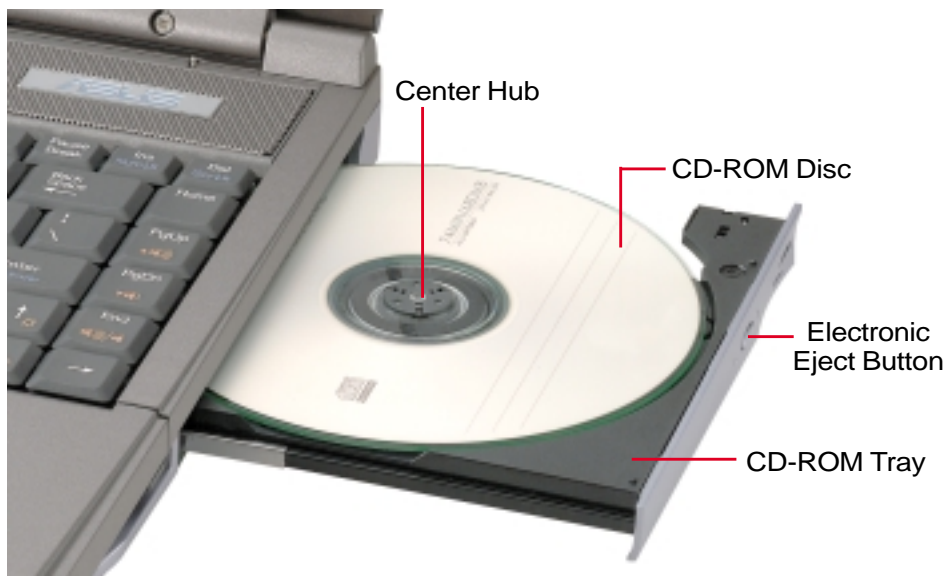

Laser Safety

This system is classified as a Class 1 laser product. The Notebook PC’s CD/DVD-ROM drive uses a laser reader that complies with laser product standards set by government agencies for Class 1 laser products. It does not emit hazardous light; the beam is totally enclosed during all modes of customer operation and maintenance.

CDRH Regulations

The Center for Devices and Radiological Health (CDRH) of the U.S. Food and Drug Administration implemented regulations for laser products on August 2, 1976. These regulations apply to laser products manufactured from August 1, 1976. Compliance is mandatory for products marketed in the United States.



WARNING: Use of controls or adjustments or performance of procedures other than those specified herein or in the laser product installation guide may result in hazardous radiation exposure.

DVD-ROM Drive (optional)

Overview

The Notebook PC comes in a DVD-ROM drive or a CD-ROM drive model. For DVD support on your Notebook PC, you must select the DVD-ROM drive at the time of purchase instead of the standard CD-ROM. Future upgrades can be done by an authorized dealer. In order to view DVD titles, you must install the provided MPEG2 video decoder software and the DVD viewer software included on the DVD module driver support CD. The DVD-ROM drive allows the use of both CD and DVD discs.

Definitions

DVD, which stands for Digital Versatile Disc, is the next generation of optical disc storage technology. The DVD specification supports discs with capacities from 4.7GB to 17GB and access rates up to 22.16MBytes/s. The Notebook PC's DVD-ROM drive is only single-sided; double-sided DVD (8.5GB and higher) requires manually reversing the disc in order to access the reverse side.

It's essentially a bigger, faster CD that can hold video as well as audio and computer data. With these capacities and access rates, DVD discs can provide you with dramatically-enhanced high-color, full-motion videos, better graphics, sharper pictures, and Dolby® Digital Surround for a theater-like experience. DVD aims to encompass home entertainment, computers, and business information with a single digital format, eventually replacing audio CD, videotape, laserdisc, CD-ROM, and perhaps even video game cartridges. DVD has widespread support from all major electronics companies, all major computer hardware companies, and most major movie and music studios.

Software

To meet customer requirements for a complete Digital Versatile Disk (DVD) solution, a software playback solution is provided. The provided software has been optimized for playback of MPEG2 (Motion Picture Experts Group specifications for data compression) encoded video clips as well as encrypted DVD movie titles. Decoding digital MPEG2 video is accomplished through software only, eliminating the need for expensive hardware. Although the software will function on Intel 233-333MHz based notebooks, playback quality is reduced since loss of video frames (video images look as though they're skipping sections of the movie) during playback may occur. Software playback performance on Intel's 400MHz processor platforms or faster is required to sustain 30 fps (Frames Per Second) which approaches the quality of most hardware playback solutions.



NOTE: Since MPEG2 video decoding is done through software, a processor of at least 400MHz Pentium II is recommended to provide real-time playback without frame skips. An MPEG2 hardware decoder PCMCIA card is required on Notebook PCs with slower processors for smooth DVD playback.

Regional Playback Information

Playback of DVD movie titles involves decoding MPEG2 video, digital AC3 audio and decryption of CSS protected content. CSS (sometimes called copy guard) is the name given to the content protection scheme adopted by the motion picture industry to satisfy a need to protect against unlawful content duplication.

Although the design rules imposed on CSS licensors are many, one rule that is most relevant is playback restrictions on regionalized content. In order to facilitate geographically staggered movie releases, DVD video titles are released for specific geographic regions as defined in “Region Definitions” below. Copyright laws require that all DVD movies be limited to a particular region (usually coded to the region at which it is sold). While DVD movie content may be released for multiple regions, CSS design rules require that any system capable of playing CSS encrypted content must only be capable of playing one region. The region setting may be changed up to five times using the viewer software, then it can only play DVD movies for the last region setting. Changing the region code after that will require factory resetting which is not covered by warranty. If resetting is desired, shipping and resetting costs will be at the expense of the user.

Region Definitions

Region 1

Canada, US, US Territories

Region 2

Czech, Egypt, Finland, France, Germany, Gulf States, Hungary, Iceland, Iran, Iraq, Ireland, Italy, Japan, Netherlands, Norway, Poland, Portugal, Saudi Arabia, Scotland, South Africa, Spain, Sweden, Switzerland, Syria, Turkey, UK, Greece, Former Yugoslav Republics, Slovakia

Region 3

Burma, Indonesia, South Korea, Malaysia, Philippines, Singapore, Taiwan, Thailand, Vietnam

Region 4

Australia, Caribbean (Except US Territories), Central America, New Zealand, Pacific Islands, South America

Region 5

CIS, India, Pakistan, Rest of Africa, Russia, North Korea

Region 6

China

Using the CD-ROM Drive

CD-ROM discs and equipment must be handled with care because of the precise mechanics involved. Keep in mind the important safety instructions from your CD suppliers. Unlike desktop CD-ROM drives, the Notebook PC uses a hub to hold the CD in place regardless of the angle. When inserting a CD, it is important that the CD be pressed onto the center hub or else the CD-ROM drive tray will scratch the CD.



WARNING! If the CD disc is not properly locked onto the center hub, the CD can be damaged when the tray is closed. Always watch the CD closely while closing the tray slowly to prevent damage.



NOTE: The CD drive eject button is electronic and requires that the Notebook PC be powered ON in order to eject the CD drive tray. Only one CD may be used at one time on this CD drive.

Inserting a CD

1. While the Notebook PC's power is ON, press the CD drive eject button and the CD drive tray will eject out partially.

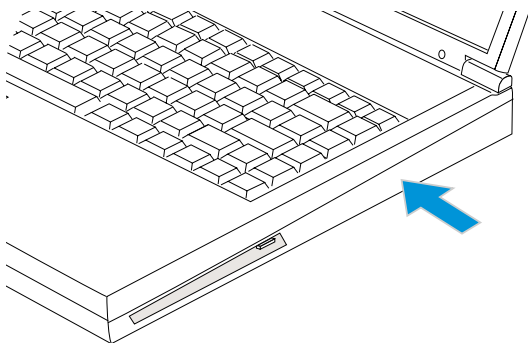

2. Hold the CD drive's front panel and slide the CD drive tray completely out. Be careful not to touch the CD drive's lens and other mechanisms.

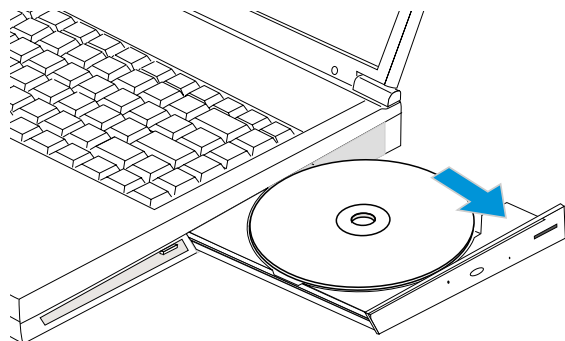

3. Hold the CD by the edge and face the printed side up. Snap the CD onto the hub by pressing on both sides of the CD's center. **The hub should be higher than the CD when correctly mounted.**
4. Slowly push the CD drive tray back into the Notebook PC. The drive will begin reading the table of contents (TOC) on the CD. Once the drive stops, the CD is ready to be used.

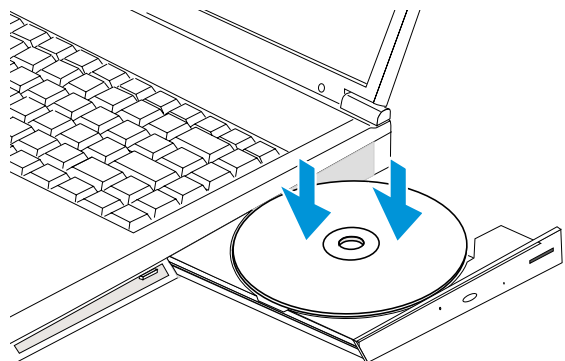

Using a CD

A CD drive letter should be present regardless of the presence of a CD disc in the drive. After the CD is properly inserted, data can be accessed just like with hard disk drives; except that nothing can be written to or changed on the CD. Vibration is normal for all high-speed CD-ROM drives due to unbalance CDs or CD printings. To decrease vibration, do not place labels on the CD and use the Notebook PC on an even surface.

Removing a CD

Remove the CD by slowly lifting the CD off the tray by holding the edge of the CD. Do not touch the bottom-side of the CD where data is read from.

Listening to Audio CD

Both the CD-ROM and DVD-ROM drive can play audio CDs, but only the DVD-ROM drive can play DVD audio. Insert the audio CD and Windows™ will automatically open an audio player and begin playing. Depending on the DVD audio disc and installed software, it may require that you open a DVD player to listen to DVD audio. You can adjust the volume through the volume control knob on the CD/DVD-ROM drive face, function keys on the keypad, or by the Windows™ speaker icon on the taskbar.

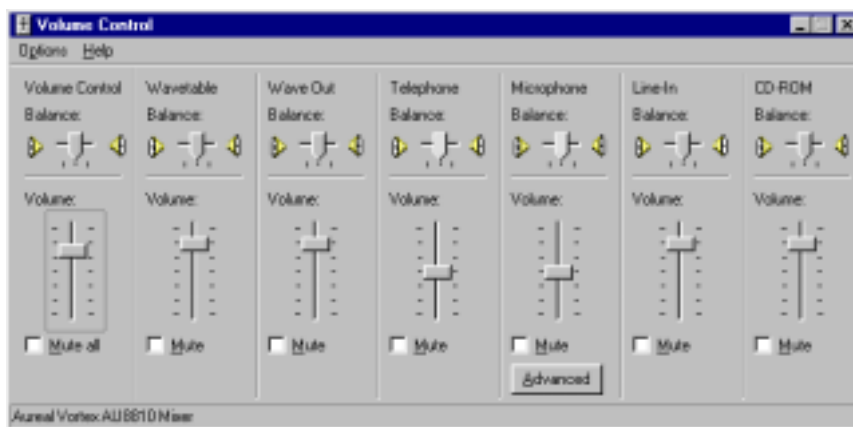
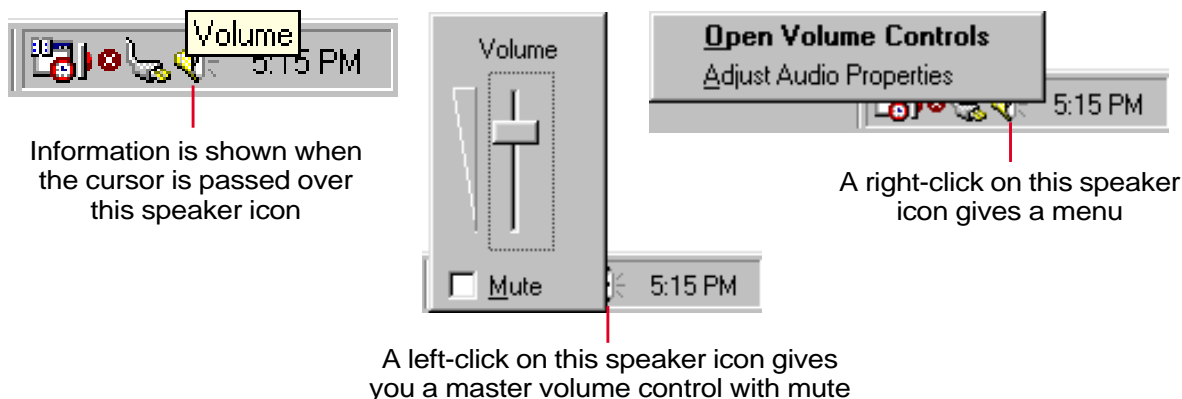

a double-click on the speaker icon gives this detailed control panel

Pointing Device

The Notebook PC's integrated touchpad pointing device is fully compatible with all two/three-button and scrolling knob PS/2 mice. The touchpad is pressure sensitive and contains no moving parts; therefore, mechanical failures can be avoided. A device driver is still required for working with some application software. See the **Driver & Utility Guide** for information on drivers and utilities for the touchpad.



Using the Touchpad

Light pressure with the tip of your finger is all that is required to operate the touchpad. Because the touchpad is electrostatic sensitive, objects cannot be used in place of your fingers. The touchpad's primary function is to move the cursor around or select items displayed on the screen with the use of your fingertip. The following illustrations demonstrate proper use of the touchpad.

Moving the cursor - Place your finger in the center of the touchpad and do the following to move the cursor:

↑ **Up** - Slide your finger forward

Left - Slide your finger to the left

Down - Slide your finger backward

Right - Slide your finger to the right

Clicking/Tapping - With the cursor over an item, press the left button or use the fingertip to touch the touchpad lightly and leaving the finger on the touchpad until the item is selected. The selected item will change color. The following two examples produce the same results.

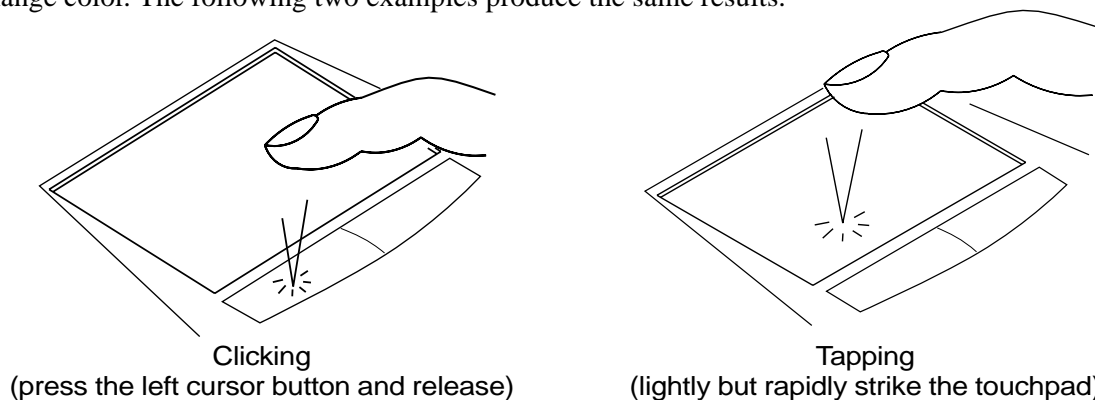

Double-clicking/Double-tapping - This is a common skill for launching a program directly from the corresponding icon you select. Move the cursor over the icon you wish to execute, press the left button or tap the pad twice in rapid succession, and the system launches the corresponding program. If the interval between the clicks or taps is too long, the operation will not be executed. You can set the double-click speed using the Windows Control Panel “Mouse.” The following two examples produce the same results.

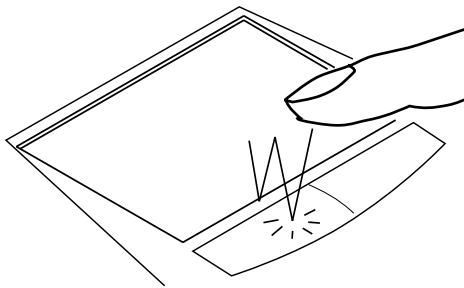

Double-Clicking
(press the left button twice and release)

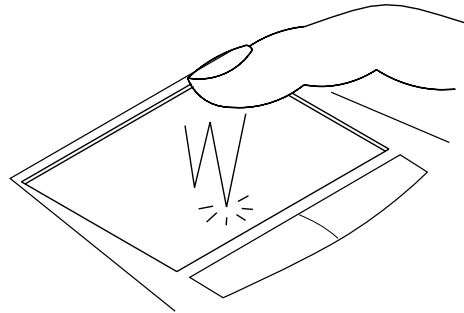

Double-Tapping
(lightly but rapidly strike the touchpad twice)

Dragging - Dragging means to pick up an item and place it anywhere on the screen you wish. You can move the cursor over the item you select, and while keeping the left button depressed, moving the cursor to the desired location, then release the button. Or, you can simply double-tap on the item and hold while dragging the item with your fingertip. The following two examples produce the same results.

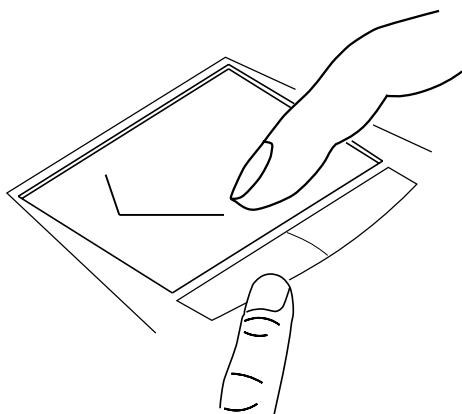

Dragging-Clicking
(hold left button and slide finger on touchpad)

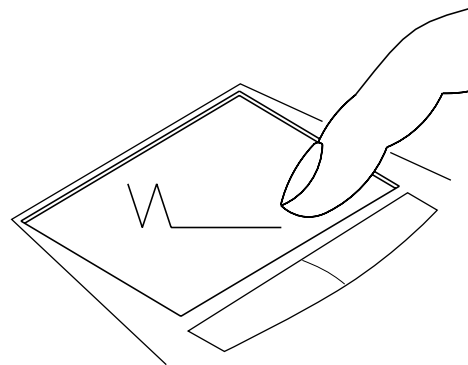

Dragging-Tapping
(lightly strike the touchpad twice, sliding finger on touchpad during second strike)



NOTE: A scrolling function is available after setting up the included touchpad utility to allow easy windows or web navigation. Basic functions can be adjusted in Windows control panel to allow comfortable clicking and tapping.

Caring for the Touchpad

The touchpad is a pressure sensitive device. If not properly cared for, it can be easily damaged. Take note of the following precautions.

- Make sure the touchpad does not come into contact with dirt, liquids or grease.
- Do not touch the touchpad if your fingers are dirty or wet.
- Do not rest heavy objects on the touchpad or the touchpad buttons.
- Do not scratch the touchpad with your finger nails or any hard objects.



NOTE: The touchpad responds to movement not force. Do not tap the surface too hard. Tapping too hard does not increase the responsiveness of the touchpad. The touchpad responds best to light pressure.

PS/2 Connection (optional)

Either a PS/2 mouse or PS/2 keyboard may be connected to the single PS/2 port. If you wish to connect two PS/2 devices, you need to buy an optional PS/2 Y-adapter as shown in this illustration.

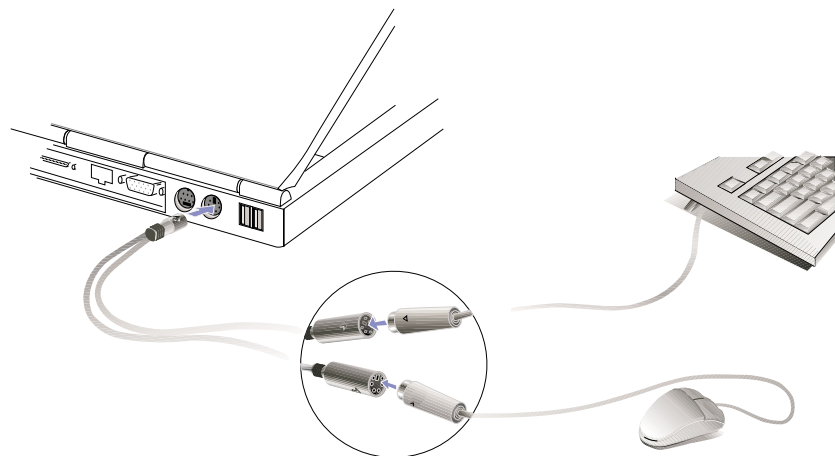

TIP: Since USB provides easy daisy chaining of many devices, it is recommended that either the external keyboard and/or the external mouse be of the USB type for quicker and more convenient connection.

External Display Connections (optional)

Monitor Out Example

As you can see here, connecting an external monitor is just like on desktop PC. Just plug in the VGA cable and its ready to use. You can view the Notebook PC display panel while simultaneously allowing others to view the external monitor. For large audiences, try connecting a computer video projector.

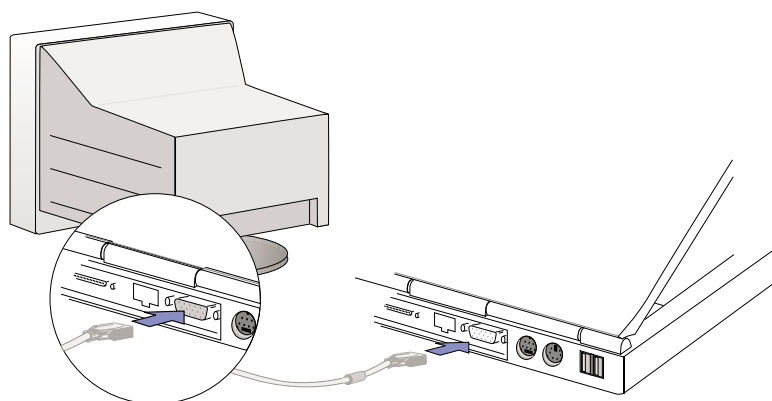

TV-Out Example

The TV-out connector provides output to standard video devices that do not support the personal computer 15-pin RS-232 interface. The TV-out can be used with the S-Video interface (cable not included) or RCA interface (with the provided adapter). The S-Video interface provides better picture clarity and should be used whenever possible.

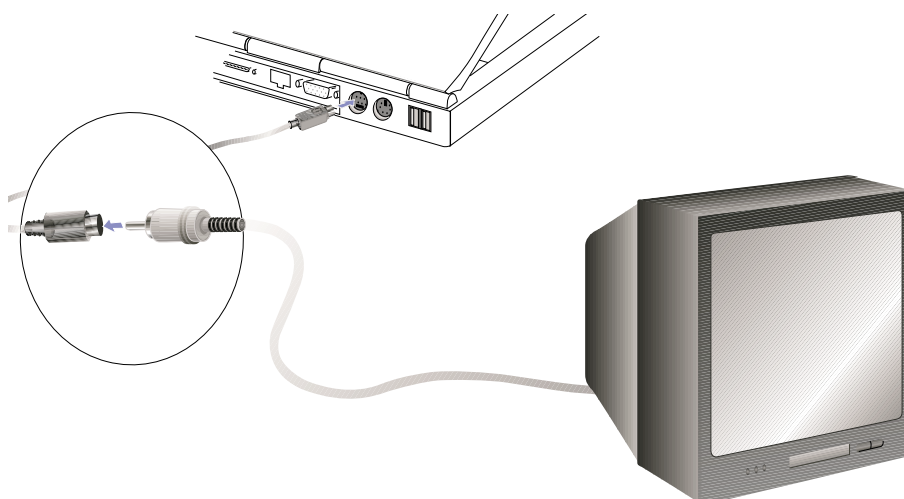

PC Cards (PCMCIA)

The Notebook PC has two PC Card (or sometimes referred to as PCMCIA) sockets located behind two spring hinged flaps are designed to allow expansion just like with desktop computer expansion slots. This allows you to customize your Notebook PC to meet a wide range of application needs. The sockets can interface with two Type I or Type II PC cards or one Type III PC card. PC cards are about the size of a few stacked credit cards and have a 68-pin connector at one end. The PC Card standard accommodates a number of function, communication, and data storage expansion options such as memory/flash cards, fax/modems, networking adapters, SCSI adapters, MPEG I/II decoder cards, and even wireless modem or LAN cards. The Notebook PC supports PCMCIA 2.1, 32bit CardBus, and Zoomed Video (ZV) standards.

The three different PC Cards actually have different thicknesses. Type I cards are 3.3mm, Type II cards are 5mm, and Type III cards are 10.5mm thick. Type I and Type II cards can be used in either the lower or upper socket. Type III cards take up both sockets and must be inserted from the lower socket.



TIP: A PCMCIA MPEG I / II decoder card is recommended for slower Notebook PCs that experience frame skips during DVD playback. It is also great for the power user who wishes to work while watching a DVD movie.

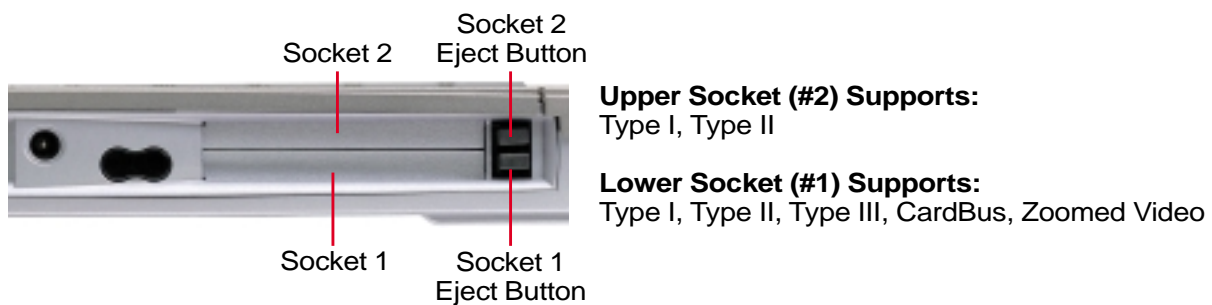

32-bit CardBus & Zoomed Video Port

CardBus support allows PC Cards and their hosts to use 32-bit bus mastering and operate at speeds of up to 33MHz, transferring data in burst modes comparable with PCI's 132MB/sec. By comparison, the standard 16-bit PC Card bus can handle only 20MB/sec. Since the Notebook PC is equipped with CardBus' broader, faster data pathway, it can handle bandwidth-hungry operations, such as 100Mbps Fast Ethernet, Fast SCSI peripherals, and ISDN-based video conference that are cutting-edge even for desktop systems. The CardBus peripherals support plug and play.

The CardBus socket is backward-compatible with 16-bit PC Cards serving at 5 volts operation while CardBus operates at 3.3 volts to reduce power consumption.

As part of the Notebook PC's advanced architecture, the Zoomed Video specification provides for full frame-rate video display channel for applications like MPEG decoders for movies and games, TV tuners, live video input, video capturing, and video conferencing. The Zoomed Video (ZV) Port allows video data on a PC Card to be transferred directly into the VGA frame buffer, bypassing the CPU and PCI system bus. It can promise a high quality real-time full-motion video playback without holding back the CPU and system bus performance.

Inserting a PC Card (PCMCIA)

1. Insert the PC card with the connector side first and the label side up against either the upper or lower socket flap. The socket flap is spring hinged and will fold in easily when pushed. The PC card is fully inserted when it is flush with the Notebook PC's side.

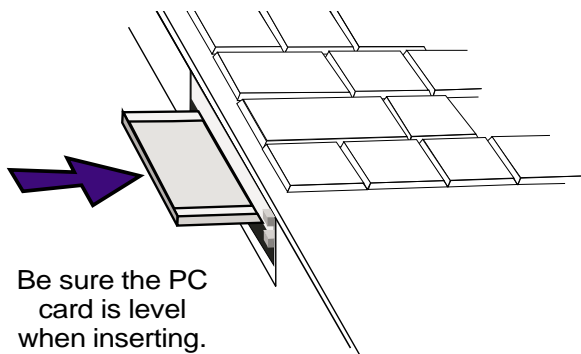

Be sure the PC card is level when inserting.

2. Carefully connect any cables or adapters needed by the PC card. Usually connectors can only be inserted in one orientation. Look for a sticker, icon, or marking on one side of the connector representing the top side.

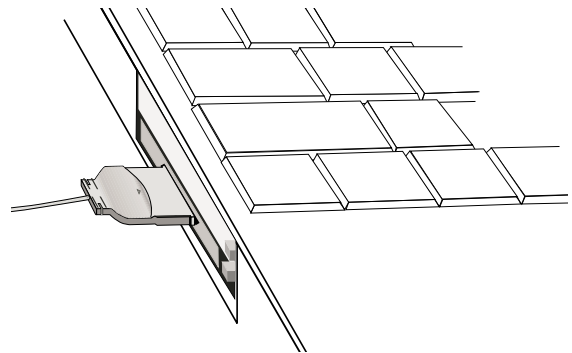

When PC cards are inserted and running, they draw power from the Notebook PC even when they are not in use. You must stop the PC card service to turn OFF the PC card.



IMPORTANT: Stopping the PC card service is also necessary before removing a PC card.

Removing a PC Card (PCMCIA)

To remove the PC card, first remove all cables or adapters attached to the PC card, then double-click the PC card icon on the taskbar and stop the PC card you want to remove.

1. Press in the toggle eject button and release. Press again on the now extended eject button. Pushing the extended button will again recess the spring loaded toggle button.

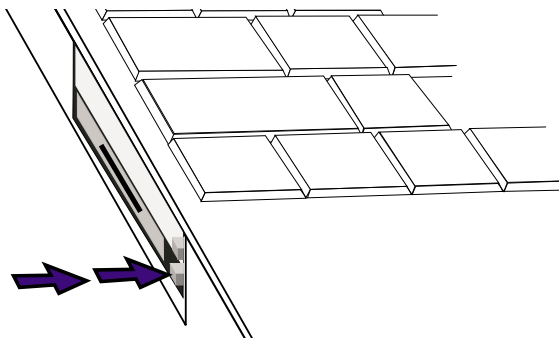

The recessed spring loaded toggle button will extend when pushed in.

2. Slowly pull the ejected PC card out of the socket.

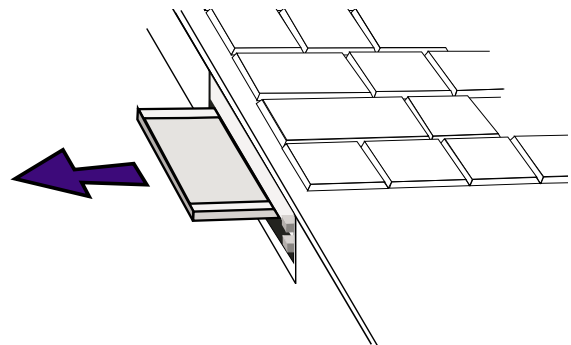

External Audio Connections (optional)

The Notebook PC provides easy access for connecting a stereo headphone, mono microphone, and a stereo audio source just like on some personal tape recorders.

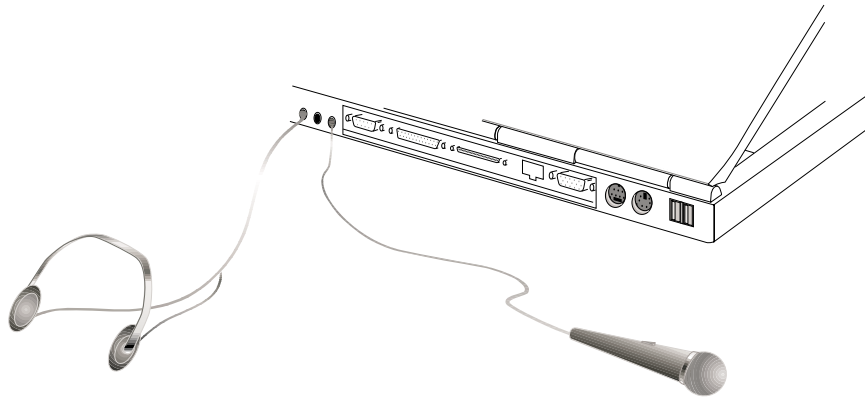

Printer Connection (optional)

The rear of the Notebook PC provides easy access for connecting a standard black/white or color inkjet or laser printer to the parallel port. One or more USB printers can be connected to the USB ports also conveniently located on the rear of the Notebook PC.

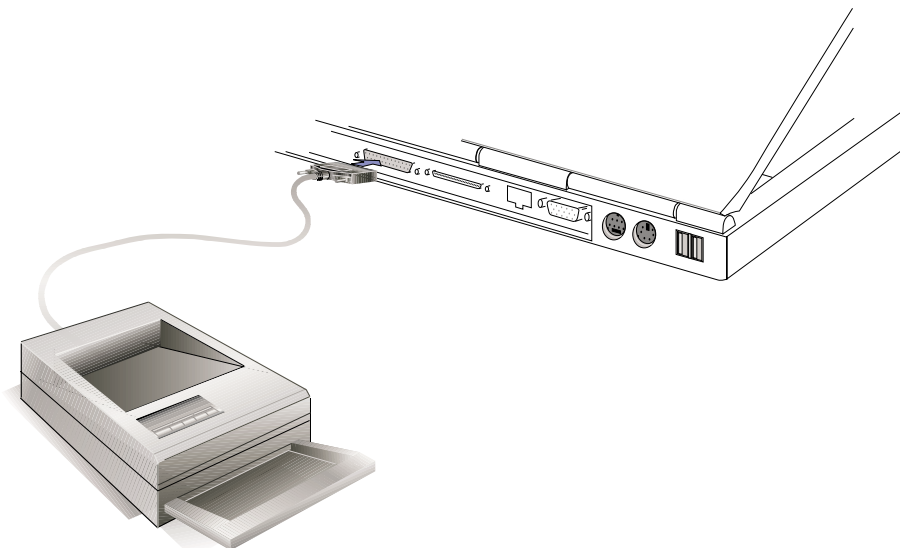

IR Wireless Communication

The Notebook PC is equipped with a conveniently located Infrared (IR) Communication Port (see **2. Knowing the Parts** for location). The IR port comes with IrDA (Infrared Data Association) Serial Infrared Data Link Version 1.1 compliance, which allows you to perform point-to-point wireless communications. You can use a SIR/FIR-specified application to transmit or receive data files with other systems equipped with an infrared port. You must set these modes in the BIOS before you start to install the IR driver and file-transferring applications. FIR (Fast Infrared) supports up to 4Mbps and SIR (Serial Infrared) supports up to 115.2Kbps. See the Drivers and Utilities Support CD User's Manual for detailed setup instructions.

Guidelines for using IR communication

Follow the guidelines listed below when using the Infrared (IR) Communication:

- Make sure the IR Mode in the BIOS Setup is properly set to the mode you would like to use.
- The angle between two Infrared communication ports should not exceed ($\pm 15^\circ$).
- The distance between the Notebook PC's IR and target device IR should not exceed 40 inches (1 m).
- Do not move either the Notebook PC or the other device during transmission of data.
- An error may occur if IR transmission is conducted with high levels of noise or vibration.
- Avoid direct sunlight, flashing incandescent light, fluorescent light, and other infrared devices such as remote controls close to the infrared port.

Enabling Infrared

Infrared communication must be enabled in MS Windows. Right click on the infrared icon on the Windows taskbar and select "Enable infrared communication."

When infrared communication is enabled, moving the cursor over the icon will give its status.

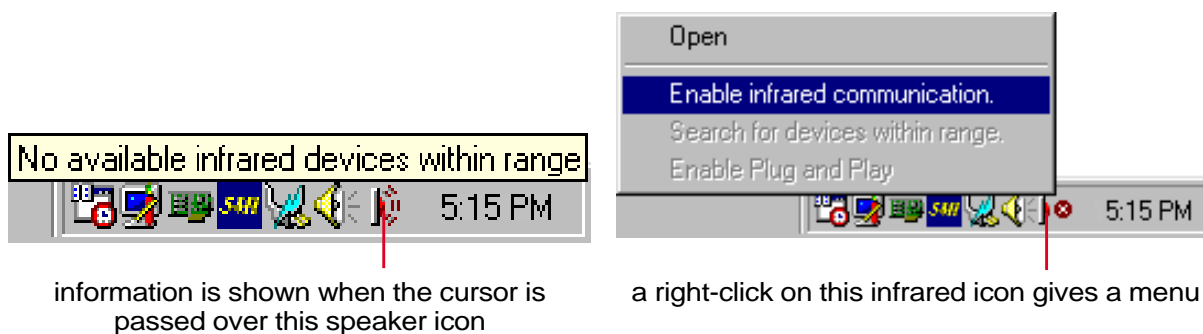

IMPORTANT: Disable the infrared communication when you are not using the IR for long periods because the IR consumes a great deal of Windows resources which will decrease the Notebook PC's performance.

Universal Serial Bus

Universal Serial Bus (USB) is a peripheral bus standard developed by PC and telecommunication industry leaders that will bring plug and play of computer peripherals outside the system, eliminating the need to install internal expansion cards and drivers.

The Notebook PC is equipped with two USB ports. This allows computer peripherals to be automatically configured as soon as they are physically attached, without the need to reboot or run setup. USB will also allow up to 127 devices to run simultaneously on a single computer, with peripherals such as monitors and keyboards acting as additional plug-in sites, or hubs.

The Notebook PC's built-in USB host controller initiates data transfer at a full-speed of up to 12Mbps for devices such as external hard disk drives, CD/DVD-ROM drives, tape drives, digital cameras. Low speed transfers of up to 1.5Mbps are used for keyboards and mice. The USB controller automatically manages the logical connection of devices and speeds.

Driver Support

The Windows 98 operating system comes already equipped with a standard driver that allows your Notebook PC to recognize USB peripherals. However, new peripherals usually require additional USB drivers. Read your peripheral documentation or contact an authorized dealer if you have any problems using USB peripherals.

AC Power System

The Notebook PC power is comprised of two parts, the power adapter and the battery power system. The power adapter converts AC power from a wall outlet to the DC power required by the Notebook PC. The battery pack consists of a set of Lithium-Ion (Li-Ion) battery cells housed together. Only one battery pack can be inserted into the Notebook PC. The AC Adapter's primary function is to provide power to the Notebook PC which also charges the battery pack. When the power adapter is connected to the Notebook PC, it provides power to the Notebook PC and charges the internal battery at the same time as long as it is plugged into an electrical outlet.



IMPORTANT: To protect your Notebook PC from damage, use only the power adapter that came with this Notebook PC because each power adapter has its own power output ratings.

Battery Power System

The Notebook PC is designed to work with a removable battery pack located inside the battery pack compartment. A fully charged pack will provide several hours of battery life, which can be further extended by using power management features through the BIOS setup. The battery system implements the Smart Battery standard under the Windows environment, which allows the battery to accurately report the amount of charge percentage left in the battery. Additional battery packs are optional and can be purchased separately through a Notebook PC retailer. Before using the Notebook PC on battery power for the first time, check the battery icon in the Windows task bar to make sure that the battery is fully charged. Charging the battery takes a few hours when the Notebook PC is powered OFF.

Lithium-Ion (Li-Ion) Battery Advantages (compared with traditional Nickel Metal Hydride (NiMH))

- No memory - means connect the power adapter anytime you like for maximum convenience. You don't have to wait until the battery is completely used up.
- No overheating - means safer and cooler usage and charging. This is better for your battery and your Notebook PC, so don't get burned with cheaper battery packs!
- Higher capacity vs. weight - means longer usage per charge. You no longer have to carry a dozen heavy battery packs to get through the day because Li-Ion battery packs are lighter and more efficient than NiMH battery packs.
- Longer life - means fewer battery purchases. This cuts down your battery replacement cost.

Charging the Battery Pack

You can charge the battery pack by using the power adapter. When the power adapter is plugged in, the inserted battery pack will automatically recharge whether your Notebook PC is ON or OFF. It takes a few hours to receive a full charge when the power is OFF but takes much longer when the Notebook PC is in use. When the orange charge LED is flashing, charging is required. The battery is charging when the orange LED is solid. When the LED is no longer lit, the battery pack is fully charged.



NOTE: The battery will stop charging if the temperature is too high or the battery voltage is too high.

Using Battery Power

A fully-charged Li-Ion battery pack will provide the system approximately 2-4 hours of working power. But the actual figure will vary depending on how you use the power saving features, your general work habits, the Notebook PC's CPU, main memory size, and the size of the display panel.

The "Battery Warning" beeps are automatically enabled in Windows 95/98 and will continually sound when down to 10% (configurable in Windows 98) power. The processor will also be throttled down to decrease power use.

In DOS, POWER.EXE must be enabled to use the Low Battery Warning Beep function in DOS. In Windows 3.1, W31-APM must be enabled to use the battery warning beep feature. POWER.EXE must be loaded via a DEVICE= line in CONFIG.SYS to report the status of the battery while using DOS or Windows 3.x. POWER.EXE is not necessary when running Windows 95/98. For additional information, see your DOS and Windows 3.1 User's Manuals for details.

"Low Battery" condition (3% or less) will force the Notebook PC to enter suspend mode, regardless of power management settings but the threshold is configurable in Windows 98.



NOTE: Battery Warning and Battery Low conditions will immediately stop upon application of the power adapter.

Checking Battery Power

To check the remaining battery power, move your cursor over the power icon. The power icon is a "battery" when not using AC power and a "plug" when using AC power. Double click on the icon for more information and settings.



Power icon using battery.



Power icon using AC power. The charging (lightning) icon appears over the "plug" icon if the battery is not fully charged. When fully charged, only the "plug" icon will remain.



NOTE: If you ignore the low battery warning, eventually the Notebook PC will enter suspend mode (either Save-to-Disk or Save-to-RAM depending on BIOS setup).



WARNING! Save-to-RAM will not last long when the battery power is depleted.



WARNING! Never attempt to remove the battery pack while the power is ON or if the system has not yet entered into the suspend mode as this may result in the loss of working data.

Power Management Modes

The Notebook PC has a number of automatic or adjustable power saving features that you can use to maximize battery life and lower Total Cost of Ownership (TCO). You can control some of these features through the Power menu in the BIOS Setup when APM (non-ACPI) is used. ACPI power management settings are made through the operating system. The power management features are designed to save as much electricity as possible by putting components into a low power consumption mode as often as possible but also allow full operation on demand. These low power modes are referred to as Standby mode and Suspend mode. The Standby mode is a simple function provided by the operating system and the suspend mode is an intense power saver provided by the Notebook PC's BIOS. When the Notebook PC is in either one of the power saving modes, the green power LED (on the front of the Notebook PC) will blink.

Full Power Mode & Maximum Performance

The Notebook PC operates in Full Power mode when the power management function is disabled by configuring the BIOS Setup. When the Notebook PC is operating in Full Power Mode, the Power LED remains ON. If you are conscious of both system performance and power consumption, select "Maximum Performance" instead of disabling all power management features.

APM and ACPI

Advanced Power Management (APM) was developed by Intel and Microsoft for DOS/Windows 3.1/95/98 which controls only the main system power functions. Advanced Configuration and Power Management (ACPI) on the hand was developed by Intel, Microsoft, and Toshiba especially for Windows 98 to control power management and Plug and Play features on system devices designed on the Wired for Management (WfM) 2.0 baseline. ACPI is the new standard in power management for Notebook PCs because of its benefits over APM. If installing Windows 98 using a BIOS dated 12/1/1999 or later, ACPI will be automatically installed. Older Notebook PCs will require an updated BIOS (dated 12/1/1999 or later) along with a reinstall of Windows 98 to utilize ACPI features.

Suspend Mode

In Suspend-to-RAM (STR) and Suspend-to-Disk (STD), the CPU clock is stopped and most of the Notebook PC devices are put in their lowest active state. The suspend mode is the lowest power state of the Notebook PC. The Notebook PC enters Suspend when the system remains idle for a specified amount of time or manually using the <Fn><F1> keys. The timeout setting of both Hard Disk and Video can be set by the BIOS Setup. To resume system operation, press any key. The Power LED will blink when the Notebook PC is in STR mode. There will be no indications when the Notebook PC is in STD mode.

Standby Mode

In addition to reducing the CPU clock, this mode puts devices including the LCD backlight in their lower active state. The Notebook PC enters Standby mode when the system remains idle for a specified amount of time. The timeout can be set through the BIOS Setup. To resume system operation, press any key on the keyboard, touchpad, or external mouse (or moving the mouse).

A Customized Power-Saving Example

The timeout settings for System Standby, Auto Suspend, Hard Disk Off, and Video Off specify the amount of time the system must be inactive before the next power management level is enabled. The example below demonstrates this function. The following power management events will take place if:

- The Hard Disk Timeout is set to **2** minutes
- The Standby Timeout to **8** minutes
- Auto Suspend Timeout to **10** minutes

1. After **2** minutes of system idle, the hard disk spins down.
2. After **6** additional minutes (a total of 8 minutes of system idle) the system enters Standby.
3. After **2** minutes in the system Standby mode (a total of **10** minutes of system idle), the system suspends to memory or to disk (depending on BIOS setup).

After the system has suspended (see ENTRY EVENT below), operation can be returned or resumed (see EXIT EVENT below) to the point in your application where it was suspended.

Power State Summary

STATE	ENTRY EVENT	EXIT EVENT
Stand by	<ul style="list-style-type: none">• Stand by through Windows Start button,• Timer as set though “Power Management” in Windows Control Panel or BIOS setup	<ul style="list-style-type: none">• Any device• Battery low• ----
STR (Suspend to RAM)	<ul style="list-style-type: none">• Timer as set through BIOS setup• Hotkey <Fn><F1>	<ul style="list-style-type: none">• Ring indicator• Power button
STD (Suspend to Disk)	<ul style="list-style-type: none">• Timer as set through BIOS setup• Hotkey <Fn><F1>• Battery Extremely Low	<ul style="list-style-type: none">• Power button• ----• ----
Soft OFF	<ul style="list-style-type: none">• Power button• “Shut down” through Windows Start button	<ul style="list-style-type: none">• Power button• ----

Thermal Power Control

There are three power control methods for controlling the Notebook PC's thermal state. These power control cannot be configured by the user and should be known in case the Notebook PC should enter these states. The following temperatures represent the chassis temperature (not CPU).

- The fan will turn ON for active cooling when temperature exceeds 70°C (158°F) when AC power is used and 80°C (176°F) when only using battery power.
- The processor will throttle (decrease CPU speed) for passive cooling when temperature exceeds 70°C (158°F).
- The system will shutdown for critical cooling when temperature exceeds 90°C (194°F).

System Memory Expansion

Under some circumstances, you may find additional memory is required. This is particularly true as applications become more complex. Expanding system memory is one method of increasing system performance by decreasing hard disk access. The Notebook PC comes with 64MB 64-bit high speed SDRAM built-in. One standard 144-pin SO-DIMM (Small Outline Dual Inline Memory Module) socket is available for system memory expansion using common **3.3 Volt 100MHz SDRAM SO-DIMM** modules. Currently, SO-DIMM memory sizes are available in 16MB, 32MB, 64MB, or 128MB for each module. The maximum memory size you can expand the Notebook PC to is 192MB using a 128MB SO-DIMM. The BIOS will automatically detect the amount of memory in the system and configure CMOS accordingly during the POST (Power-On-Self-Test) process. There is no hardware or software (including BIOS) setup required after the memory is installed. Only purchase expansion modules from your authorized retailer to ensure compatibility and reliability. The memory module must be installed by a certified Notebook PC technician.



IMPORTANT: Be aware that stores may also carry EDO DRAM. EDO DRAM is not supported on this Notebook PC.

Processor Upgrades

Please visit your authorized service center or retailer for upgrades. The Notebook PC uses an Intel® microPGA2 socket in order to support future processor upgrades. Current processors are Pentium® III (with 256KB level 2 cache built-in) from 450-700MHz+ and Celeron (with 128KB level 2 cache built-in) from 450MHz-600MHz+. Faster processors are just around the corner.

Modem and Network Connections (optional)

The built-in modem and network model will come with an RJ-45 port which can accept either an RJ-45 network cable or an RJ-11 telephone wire. RJ-11 telephone wires are the standard wires used to connect telephones to telephone outlets found in the walls of residential homes and some commercial buildings (most commercial buildings have telephone wiring designed for phone systems). RJ-45 network cables are found connecting network computers to network hubs or switches usually found in businesses.



NOTE: The built-in modem and network can also be installed by a certified Notebook PC technician if you choose to upgrade your non-modem/network model after purchase. Modem and/or network can also be installed as a PC card (PCMCIA).



WARNING! Only use analog telephone outlets. The built-in modem does not support the voltage used in digital phone systems. Do not connect the RJ-11 to digital phone systems found in many commercial buildings or else damage will occur!

Modem Connection

The telephone wire used to connect the Notebook PC's internal modem should have either two or four wires (only two wires (line 1) is used by the modem) and should have an RJ-11 connector on both ends. Connect one end to the modem/network port and the other end to an analog telephone wall socket (the ones found in residential buildings). Once the driver is setup, the modem is ready to use.



NOTE: When you are connected to an online service, do not place the Notebook PC in suspend (or sleep mode) or else you will disconnect the modem connection.

Modem Protocols

The Notebook PC with internal modem complies with JATE (Japan), FCC (US, Canada, Korea, Taiwan, and others), and CTR21 (see Appendix for supported countries) for almost worldwide protocol support.

Network Connection

Connect a network cable, with RJ-45 connectors on each end, to the modem/network port on the Notebook PC and the other end to a hub or switch. For 100BASE-TX speeds, your network cable must be category 5 (not category 3) with twisted-pair wiring. If you plan on running the interface at 100Mbps, it must be connected to a 100BASE-TX hub (not a 100BASE-T4 hub). For 10Base-T, use category 3, 4, or 5 twisted-pair wiring. Duplex transfers (up to 200Mbps) is supported on this Notebook PC but requires connection to a switch with "duplex" enabled. The software default is to use the fastest setting so no user-intervention is required.

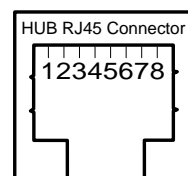

Twisted-Pair Cable

The cable used to connect the Ethernet card to a host (generally a Hub) is called a straight-through Twisted Pair Ethernet (TPE). The end connectors are called RJ-45 connectors, which are not compatible with the standard RJ-11 telephone connectors. If connecting two computers together without a hub in between, a crossover twisted-pair is required.

Securing Your Notebook PC

For system and hard disk drive security, see BIOS setup “Security”. A third party lock such as the ones by Kensington® can be used to secure your Notebook PC physically to an unmovable object. The cable wraps around an object and the “T” shaped end inserts into the Kensington® lock port as shown in this illustration and a key or combination dial is used to secure the lock in place. For more information, you can read advertisements in Notebook (sometimes referred to as “Mobile” or “Portable”) PC magazines.

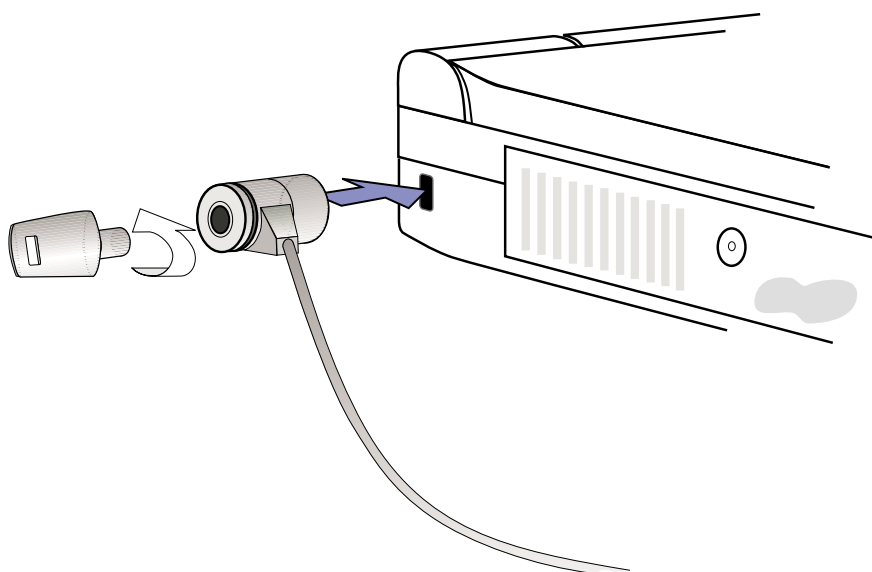

Other Security Products

Another good security product is the PCMCIA lock. The dummy PCMCIA card with a cable inserts into the PCMCIA socket on the Notebook PC and mechanisms inside the dummy PCMCIA secures itself to the PCMCIA socket.

SECTION 5

CONFIGURING THE BIOS

Updating Your BIOS
BIOS Setup Program
Main Menu
IDE Primary Master
IDE Primary Slave
Advanced Menu
I/O Device Configuration
Security Menu
Password Usage Summary
The Power Menu
Boot Menu
Exit Menu

Updating Your BIOS

PHLASH.EXE is a Flash Memory Writer utility that updates the BIOS by uploading a new BIOS file to the programmable flash ROM on the Notebook PC's motherboard. This file works only in DOS mode. To determine the BIOS version, check the code (e.g. BIOS Ver. XXXXX) displayed on the upper left-hand corner of your screen just before entering BIOS setup (after pressing the F2 key). Larger numbers represent a newer BIOS version.

Creating a BIOS Update Floppy Disk

PHLASH works only in DOS mode. It will not work with DOS prompt in Windows and will not work with certain memory drivers that may be loaded when you boot from your hard drive. It is recommended that you reboot using a floppy disk.



1. Download an updated BIOS file from the Internet (WWW or FTP) (see Contact Information).
2. Type **FORMAT A:/S** at the DOS prompt to create a bootable floppy disk. **DO NOT** copy **AUTOEXEC.BAT** & **CONFIG.SYS** to the floppy disk.
3. Copy **PHLASH**, **PLATFORM.BIN**, and the original **BIOS** (from the support CD) and new **BIOS** (from the internet) files to the just created bootable floppy disk.

Updating BIOS Procedures



WARNING! Only update your BIOS if you have problems with your Notebook PC and you know that the new BIOS revision will solve your problems (read the BIOS release information provided on the download site before using). Careless updating can result in your Notebook PC having more problems!



1. Boot from the BIOS floppy disk you created earlier. **NOTE:** BIOS setup must specify “Floppy Drive” as the first item in the boot sequence. (see Boot Menu)
2. At the “A:\” prompt, type “**phlash/mode=3 xxxx.rom** (xxxx being the name of the BIOS file) and then press <Enter>.



WARNING! If you encounter problems while updating the new BIOS, **DO NOT** turn off your system since this might prevent your system from booting up. Just repeat the process, and if the problem still persists, restore the original BIOS file from the support CD. If the Flash Memory Writer utility was not able to successfully update a complete BIOS file, your system may not be able to boot up. If this happens, your system will need servicing.

3. The PHLASH utility will automatically update the BIOS. When the BIOS has been successfully programmed, you will be asked to press any key to power OFF the Notebook PC.
4. Assuming that you have successfully flashed the BIOS, power ON the Notebook PC and press <F2> on system bootup to enter the BIOS setup. Select the “Load Setup Defaults” on the “Exit” menu and then [Enter]. Go back to the other menus if you require BIOS configuration changes (previous BIOS settings are lost after updating the BIOS). Then select “Exit Saving Changes” to exit the BIOS setup. If the screen resolution has changed after you restart the Notebook PC, change your “Screen area” to **1024 by 768** pixels (14.1” display) through your operating system.

BIOS Setup Program

This Notebook PC supports a programmable EEPROM that stores the BIOS software and can be updated using the provided utility as described in *Flash Memory Writer Utility*. This Section will guide you through the BIOS setup program by providing clear explanations for all the options. A default configuration has already been set. If you are either installing new devices or expanding main memory, you will need to enter the BIOS Setup to reconfigure your Notebook PC.

A battery backed-up CMOS RAM is used to record some basic system hardware information: clock, date, time, the error handling, and etc., even when the power is off. When the Notebook PC is turned back on, the system is configured with the values stored in the CMOS RAM.

The settings made in the BIOS Setup program intimately affect how the Notebook PC performs. It is important, therefore, to first understand all the Setup options, and second, to make settings appropriate for the way you use the Notebook PC.

The BIOS (Basic Input and Output System) Setup is a menu driven software utility that enables you to make changes to the system configuration and tailor your Notebook PC to reflect installed hardware, alter performance, and setup power saving functions. BIOS setup is used if you are setting up the Notebook PC for the first time, reconfiguring your system, or prompted to “**Run Setup**” during bootup. This section describes how to configure your system using this utility.

Even if you are not prompted to use the Setup program, at some time in the future you may want to change the configuration of your Notebook PC. For example, you may want to enable the Security Password Feature or make changes to the power management settings. It will then be necessary to reconfigure your system using the BIOS setup program so that the computer can recognize these changes and record them in the CMOS RAM of the EEPROM.

The Setup program has been designed to make it as easy to use as possible. It is a menu-driven program, which means you can scroll through the various sub-menus and make your selections among the predetermined choices.

When you start up the computer, the system provides you with the opportunity to run this program. This appears during the Power-On Self Test (POST). Press <F2> to call up the Setup utility. If you are a little bit late in pressing the mentioned key, POST will continue with its test routines, thus preventing you from calling up Setup. If you still need to call Setup, restart the system by pressing <Ctrl> + <Alt> + <Delete>, or by pressing the Reset button if available. You can also restart by turning the system OFF and then back ON again. But do so only if the first two methods fail.

To access the BIOS Setup program, press the <F2> key immediately when you see the splash screen during bootup (about 1 second after powering ON). You can also press the <ESC> key and select “Enter Setup”. If you are late, you will have to restart your Notebook PC and try again. There are no other methods to enter the BIOS setup.



NOTE: Because the BIOS software is constantly being updated, the following BIOS screens and descriptions are for reference purposes only and may not exactly reflect your BIOS screens.

BIOS Menu Bar

The top of the screen has a menu bar with the following selections:

MAIN	Use this menu to make changes to the basic system configuration.
ADVANCED	Use this menu to enable and make changes to the advanced features
SECURITY	Use this menu to set a password to control bootup and control access to the BIOS setup menu.
POWER	Use this menu to configure and enable Power Management features.
BOOT	Use this menu to configure the default system device used to locate and load the Operating System.
EXIT	Use this menu to exit the current menu or specify how to exit the Setup program.

To access the menu bar items, press the right or left arrow key on the keyboard until the desired item is highlighted.

BIOS Legend Bar

At the bottom of the Setup screen you will notice a legend bar. The keys in the legend bar allow you to navigate through the various setup menus. The following table lists the keys found in the legend bar and those that are not with their corresponding alternates and functions.

Navigation Key(s) Function Description

<F1> or <Alt H>	Displays the General Help screen from anywhere in the BIOS Setup
<Esc> or <Alt X>	Jumps to the Exit menu or returns to the main menu from a sub-menu
← or → (keypad arrow)	Selects the menu item to the left or right
↑ or ↓ (keypad arrows)	Moves the highlight up or down between fields
- (minus) or <F5>	Scrolls backward through the values for the highlighted field
+ (plus) or <F6> or space	Scrolls forward through the values for the highlighted field
<Enter>	Brings up a selection menu for the highlighted field
<Home> or <PgUp>	Moves the cursor to the first field
<End> or <PgDn>	Moves the cursor to the last field
<F9>	Resets the current screen to its Setup Defaults
<F10>	Saves changes and exits Setup

General Help

In addition to the Item Specific Help window, the BIOS setup program also provides a General Help screen. This screen can be called up from any menu by simply pressing <F1> or the <Alt> + <H> combination. The General Help screen lists the legend keys with their corresponding alternates and functions.

Saving Changes and Exiting the Setup Program

See *Exit Menu* for detailed information on saving changes and exiting the setup program.

Scroll Bar

When a scroll bar appears to the right of a help window, it indicates that there is more information to be displayed that will not fit in the window. Use <PgUp> and <PgDn> or the up and down arrow keys to scroll through the entire help document. Press <Home> to display the first page, press <End> to go to the last page. To exit the help window, press <Enter> or <Esc>.

Sub-Menu



Note that a right pointer symbol (as shown in the left view) appears to the left of certain fields. This pointer indicates that a sub-menu can be launched from this field. A sub-menu contains additional options for a field parameter. To call up a sub-menu, simply move the highlight to the field and press <Enter>. The sub-menu will then immediately appear. Use the legend keys to enter values and move from field to field within a sub-menu just as you would within a menu. Use the <Esc> key to return to the main menu.

Take some time to familiarize yourself with each of the legend keys and their corresponding functions. Practice navigating through the various menus and sub-menus. If you accidentally make unwanted changes to any of the fields, use the set default hot key <F5>. While moving around through the Setup program, note that explanations appear in the Item Specific Help window located to the right of each menu. This window displays the help text for the currently highlighted field.

Main Menu

When the Setup program is accessed, the main menu screen appears as shown:

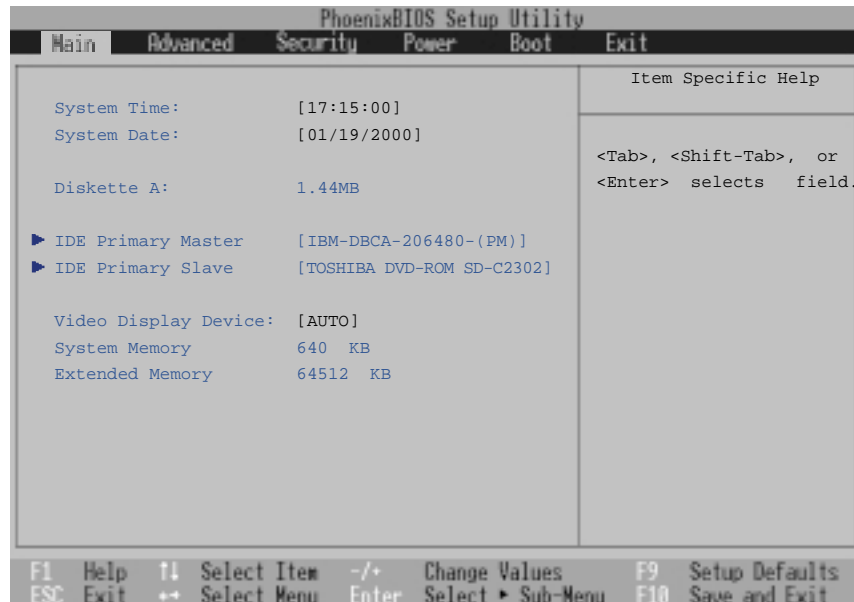

NOTE: In the following BIOS item descriptions, the item headings in square brackets represent the default settings for those fields.

System Time:

Sets your system to the time that you specify (usually the current time). The format is hour, minute, second. Insert the appropriate information. Use the [Tab] or [Shift] + [Tab] keys to move between the hour, minute, and second fields.

System Date:

Sets your system to the date that you specify (usually the current date). The format is month, day, year. Type in the appropriate information. Use the [Tab] or [Shift] + [Tab] keys to move between the month, day, and year fields.

Diskette A:

This is a display-only field. The information is set for the type of floppy drive installed.

>IDE Primary Master (described later)

>IDE Primary Slave (described later)

Video Display Device: [AUTO]

This field allows you to select and enable video display devices, such as an LCD panel, an external CRT/LCD monitor, or both. The configuration options are: [AUTO] [LCD] [CRT]

System Memory:

This field displays the amount of conventional memory detected by the system during bootup. This should show 640 KB for almost all computers and Notebook PCs. You do not need to make changes to this field. This is a display only field.

Extended Memory:

This field displays the amount of extended memory detected by the system during bootup. For example 64512 KB means you have 64MB of system memory. Unfortunately, this will not tell you how much is onboard and how much is added to the SO-DIMM socket. You must visually inspect the SO-DIMM socket if you are considering expanding your memory. You do not need to make changes to this field. This is a display only field.

IDE Primary Master

This field is used to configure the IDE Hard Disk installed in the system. To configure a hard disk drive, move the cursor to highlight the **IDE Primary Master** field and press the Enter key to enter the sub-menu.

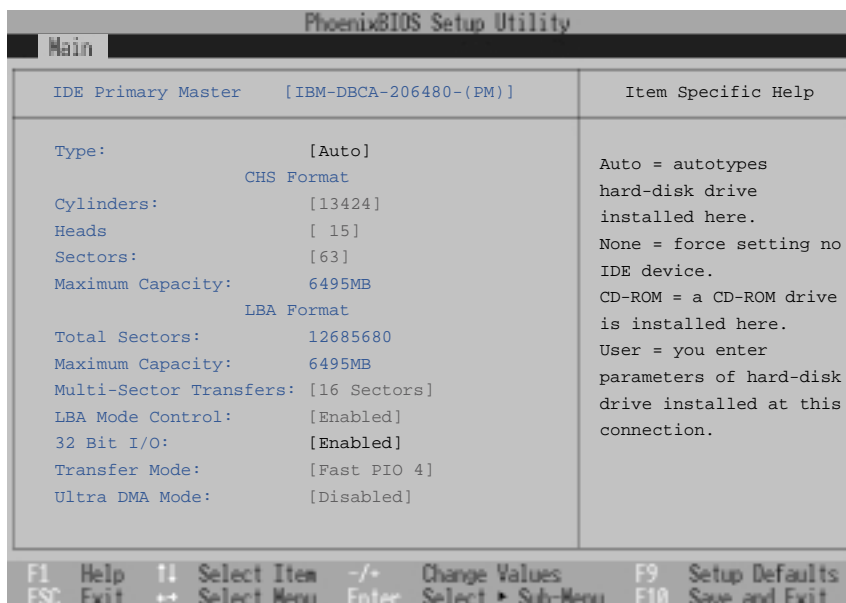

NOTE: Before attempting to configure a hard disk drive, make sure you have the configuration information supplied by the manufacturer of the drive. Incorrect settings may cause your system to not recognize the installed hard disk. To allow the BIOS to detect the drive type automatically, select [AUTO].

Type: [Auto]

Select **Auto** to automatically detect an IDE type drive. This option only works with standard built-in IDE drives. If automatic detection is successful, the correct values will be filled in for the remaining fields on this sub-menu.

To configure a drive manually, select **User**. Manually enter the number of cylinders, heads and sectors per track for your drive. Refer to your drive documentation or look on the drive for this information. If no drive is installed or if you are removing a drive and not replacing it, select **None**. Set the type to **CD-ROM** to support a CD-ROM or DVD-ROM drive.

Cylinders:

This field configures the number of cylinders. Refer to your drive documentation to determine the correct value to enter into this field. **NOTE:** To make changes to this field, the **Type** field must be set to **User**.

Heads:

This field configures the number of read/write heads. Refer to your drive documentation to determine the correct value to enter into this field. **NOTE:** To make changes to this field, the **Type** field must be set to **User**.

Sectors:

This field configures the number of sectors per track. Refer to your drive documentation to determine the correct value to enter into this field. **NOTE:** To make changes to this field, the **Type** field must be set to **User**.

Maximum Capacity:

This field shows the drive's maximum capacity calculated automatically by the BIOS from the drive information you entered.

Multi-Sector Transfers:

This option automatically sets the number of sectors per block to the highest number supported by the drive. This field can also be configured manually. Note that when this field is automatically configured, the set value may not always be the fastest value for the drive. Refer to the documentation that came with your hard drive to determine the optimal value and set it manually. **NOTE:** To make changes to this field, the **Type** field must be set to **User**. The configuration options are: [Disabled] [2 Sectors] [4 Sectors] [8 Sectors] [16 Sectors]

LBA Mode Control:

When Logical Block Addressing is enabled, 28-bit addressing of the hard drive is used without regard for cylinders, heads, or sectors. Note that Logical Block Access may decrease the access speed of the hard disk. However, LBA Mode is necessary for drives with greater than 504MB in storage capacity. **NOTE:** To make changes to this field, the **Type** field must be set to **User**. The configuration options are: [Disabled] [Enabled]

32 Bit I/O: [Enabled]

When enabled, this option speeds up communication between the CPU and the IDE controller. This option supports PCI local bus only. ISA bus is not supported. **NOTE:** To make changes to this field, the **Type** field must be set to **User**. The configuration options are: [Disabled] [Enabled]

Transfer Mode:

When enabled, this option speeds up communication between the system and the IDE controller by using enhanced I/O transfer modes (PIO Modes). **NOTE:** To make changes to this field, the **Type** field must be set to **User**. The configuration options are: [Standard] [Fast PIO 1] [Fast PIO 2] [Fast PIO 3] [Fast PIO 4]

Ultra DMA Mode:

This field auto detects Ultra DMA capability (for improved transfer speeds and data integrity) for compatible IDE devices. Set to Disable to suppress Ultra DMA capability. **NOTE:** To make changes to this field, the **Type** field must be set to **User**. The configuration options are: [Disabled] [Mode 0] [Mode 1] [Mode 2]



NOTE: After using the legend keys to make your selections on this sub-menu, press the [Esc] key to exit back to the Main menu. When the Main menu appears, you will notice that the drive size appear in the field for the hard disk drive that you just configured.

IDE Primary Slave

In this field, indicate the size of a disk drive or the device type, such as a CD-ROM drive. The arrow head icon indicates that this field contains a sub-menu. The sub-menu is used to configure the IDE Hard Disk installed in the system.

To configure a hard disk drive, move the cursor to highlight the **IDE Primary Slave** field, and press [Enter]. The following sub-menu screen will appear. The fields and options on this sub-menu are the same as the previous menu described earlier. Set the type as CD-ROM in this field to support an inserted CD-ROM or DVD drive module.

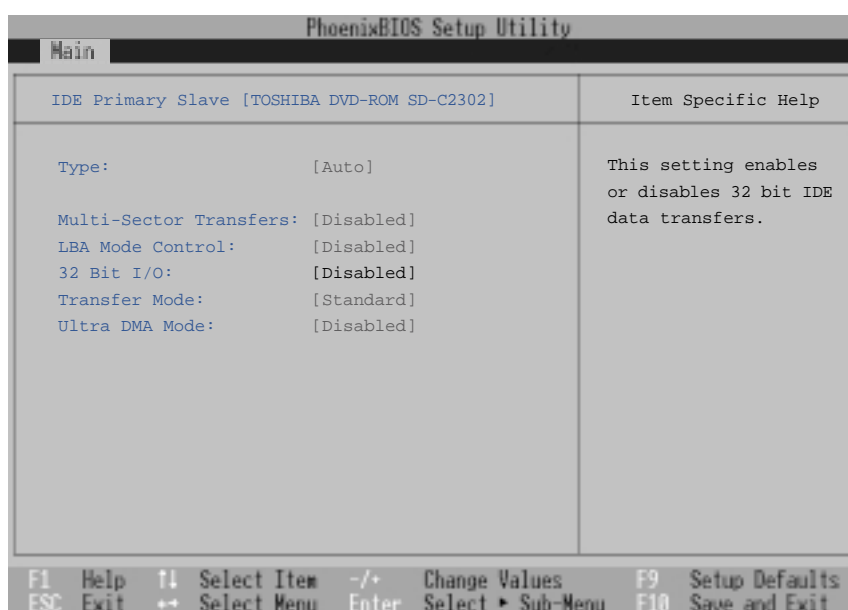

NOTE: After using the legend keys to make your selections in this sub-menu, press the [Esc] key to return to the Main menu.

Advanced Menu

Selecting Advanced from the main menu bar display the Advanced menu as shown below.

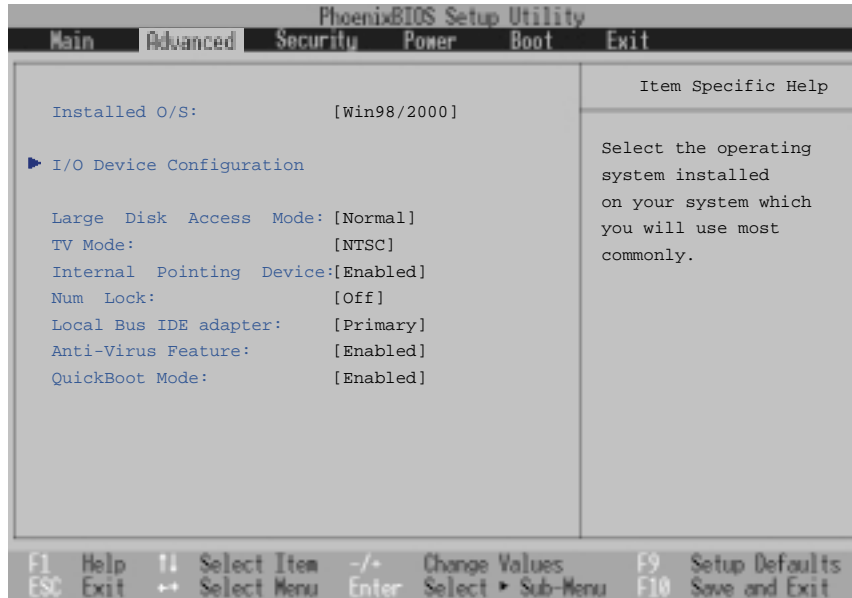

Installed O/S: [Win98/2000]

This field gives operating system information to the BIOS so that plug and play information can be set accordingly. Select the appropriate operating system or select “Other” if your operating system is not listed. [Other] [Win95] [Win98/2000]

>I/O Device Configuration: (described later)

Pressing [Enter] when this field is highlighted calls up a sub-menu for configuring the Notebook PC’s serial and parallel ports. See the Advanced sub-menu for descriptions of each sub-menu items.

Large Disk Access Mode: [Normal]

Specifies the type of operating system in use. The default, Normal, should be always used unless UNIX or Novell Netware is being used. Available configurations are:[Large] [Normal]



NOTE: The Large Disk Access mode controls how the disk controller accesses the disk volume. Setting the option to Large may cause the hardware not to recognize DOS, Windows or other DOS based operating system disk formats.

TV Mode: [NTSC]

This sets the video synchronization mode for your video output device (television or video projector). The setting depends on the territory that your video output device is manufactured for. The configuration options are: [NTSC] [PAL] [J-NTSC]

Internal Pointing Device: [Enabled]

This field allows you to enable or disable the internal pointing device. The configuration options are: [Disabled] [Enabled]

Num Lock: [Auto]

Specifies the number lock function of the keypad when power is on. Auto keeps the last status during shutdown. The configuration options are: [Auto] [On] [Off]

Local Bus IDE adapter: [Primary]

This allows you to select the IDE function. The configuration options are: [Primary] [Both]

Anti-Virus Feature: [Enabled]

Protects the boot sector and partition table of your hard disk against intentional modifications by viruses or accidental modifications by software other than those provided with this Notebook PC. The configuration options are: [Disabled] [Enabled]

QuickBoot Mode: [Enabled]

When enabled, the system skips certain tests and boots up faster than normal. Disabled is used for testing purposes. The configuration options are: [Disabled] [Enabled]

I/O Device Configuration

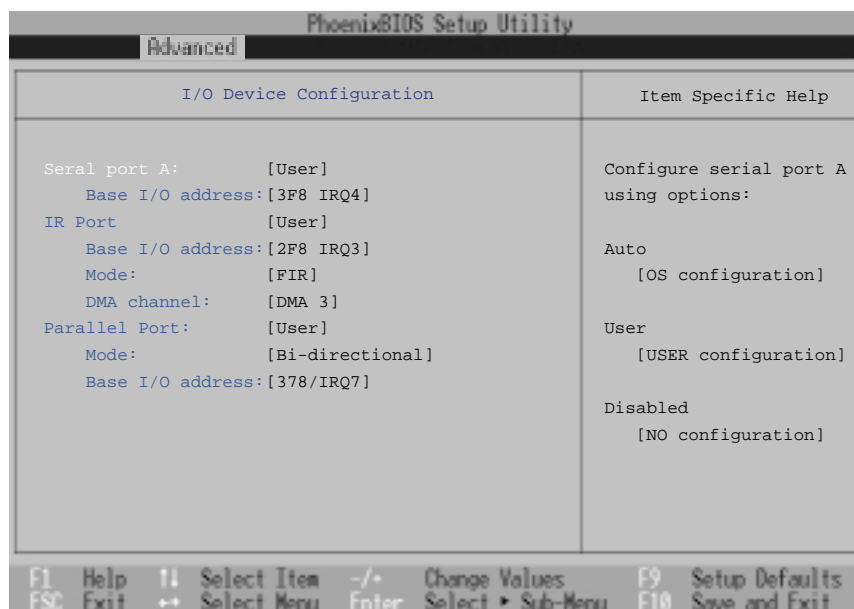

NOTE: The presence of sub-items in this menu is dependent on certain relevant settings.



WARNING! Changing the default address and IRQ settings for COM1, COM2 and the LPT Port can cause conflicts with other system devices or installed peripherals.

Serial Port A: [User]

This field allows you to configure the Notebook PC serial COM1 port. The configuration options are: [Disabled] [User] [Auto]

Base I/O address: (when User is selected in Serial Port A:)

When **User** is selected, the **Base I/O address** field allows you to set the serial port IRQ and I/O address. The configuration options are: [3F8, IRQ 4] [2F8, IRQ 3] [3E8, IRQ 4] [2E8, IRQ 3]

IR port: [User]

This field allows you to configure the Notebook PC's serial IR port. The configuration options are: [Disabled] [User] [Auto]

Base I/O address: (when User is selected in IR port)

When **User** is selected, the **Base I/O address** field allows you to set the serial port IRQ and I/O addresses. The configuration options are: [3F8 IRQ4] [2F8 IRQ3] [3E8 IRQ4] [2E8 IRQ3]

Mode: (when User is selected in IR port)

When **User** is selected, the **Mode** field allows you to select either Standard Infrared (SIR) or Fast Infrared (FIR) communication mode. The configuration options are: [SIR] [FIR]

DMA channel: (when User is selected in IR port)

The **DMA Channel** field allows you to configure the Parallel port DMA Channel for the selected **ECP** mode. **NOTE:** This field is only available when the **Parallel port** field is set to **User** and the **Mode** field is set to **ECP**. The configuration options are: [DMA 1] [DMA 3]

Parallel port: [User]

This field allows you to configure the Notebook PC parallel port. The configuration options are: [Disabled] [User] [Auto]

Mode: (when User is selected in Parallel port)

The **Mode** field allows you to configure the Notebook PC parallel port transmission mode. The configuration options are: [Output only] [Bidirectional] [ECP] [EPP]

The **Output only** mode allows data output only. However, EPP and ECP are Bidirectional modes, allowing both data input and output. The EPP and ECP modes are only supported with EPP and ECP aware peripherals.

ECP Mode: The port is both software and hardware compatible with existing parallel ports so that it may be used as a standard printer mode if ECP is not required. ECP mode provides an automatic high burst-bandwidth channel that supports DMA for ECP in both the forward (host to peripheral) and reverse (peripheral to host) direction.

EPP Mode: When the **EPP** mode is selected, the standard and bidirectional modes are also available. The EPP operates on a two phase cycle. First, the host selects the register within a device for subsequent operations. Second, the host performs a series of read and/or write byte operations to the selected register. There are four operations supported by EPP: Address Write, Data Write, Address Read, and Data Read. All operations are performed asynchronously.

Base I/O address: (when User is selected in Parallel port)

Options in the field of **Base I/O address** are used to choose the I/O (port) address for the Parallel port. **NOTE:** This field is only available when the **Parallel port** field is set to **User**. The configuration options are: [378 / IRQ7] [378 / IRQ5] [278 / IRQ7] [278 / IRQ5]



NOTE: After using the legend keys to make your selections for the I/O Device Configuration sub-menu, press the [Esc] key to exit back to the Advanced menu.

Security Menu

The Notebook PC's advanced system of security allows you to set a password to prevent unauthorized access to system resources, data, and the BIOS Setup Program. This Section covers each parameter of the Security Setup. Selecting Security from the menu bar displays the following menu:

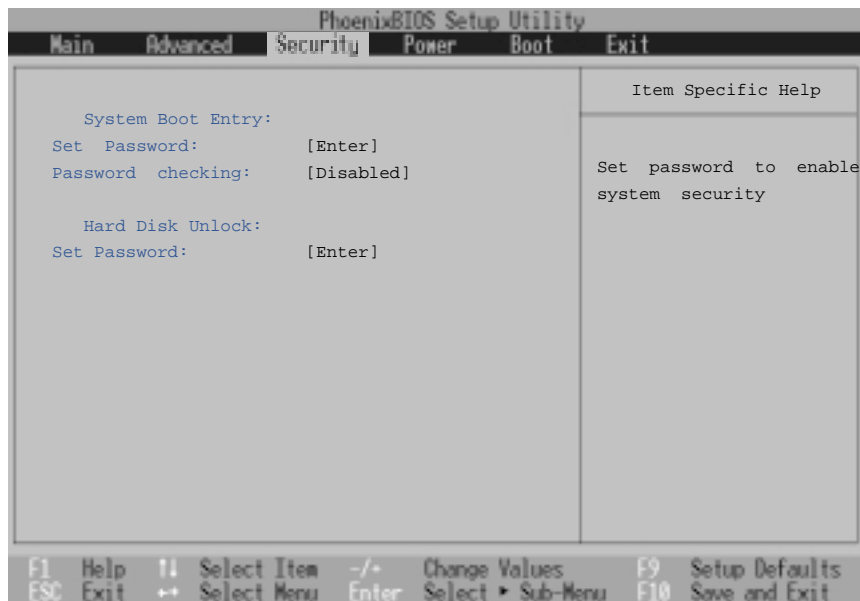

The BIOS Setup program allows you to specify passwords in the Security menu. The passwords control access to the BIOS and certain Security menu options during system startup. The passwords are not case sensitive. In other words, it makes no difference whether you enter a password using upper or lowercase letters.

The BIOS Setup program allows you to specify two separate passwords: a Supervisor password and a User password. When disabled, anyone may access all BIOS Setup program functions. When enabled, the Supervisor password is required for entering the BIOS Setup program and having full access to all Security menu options.

System Boot Entry

Set Password:

This field allows you to set the User password. To set the User password, highlight this field and press [Enter].

Type the password and press [Enter]. You can type up to eight alphanumeric characters. Symbols and other keys are ignored. To confirm the password, type the password again and press the [Enter]. The User password is now set. This password allows full access to the BIOS Setup menus.

To clear the password, highlight this field and press [Enter]. The same dialog box as above will appear. Press [Enter] twice. The password is now cleared.

Password checking: [Disabled]

This option requires prior setting of the User password to function. When enabled, the system will then require the User password before the system can bootup. When set to **Always**, the system will then require either the User password before allowing access to the system when resuming from suspend. The configuration options are: [Disabled] [On Boot] [Always]

Hard Disk Unlock:

This function is set in the same way as the System Boot Entry above. Hard disk password places a protection on each hard disk drive partition so that a password is necessary in order to access the hard disk drive. If someone tries to access the hard disk drive from another computer, it would appear as if there is no usable partition on the hard disk drive. If the hard disk drive is used on this or another Notebook PC with this function, a password will be asked when the hard disk drive is accessed.

Password Usage Summary

There are several security passwords available to protect the Notebook PC. The following are situations where passwords can be applied.

Power ON: The BIOS will prompt for a password before booting the operating system. If three failed attempts are detected, the BIOS will halt the Notebook PC.

Resume: The BIOS will prompt for a password when resuming from STR/STD mode (APM) or Standby/Hibernation mode (ACPI). If three failed attempts are detected, the BIOS will not allow the Notebook PC to wake up.

BIOS Setup: The BIOS will prompt for a password when entering BIOS setup. If three failed attempts are detected, the BIOS will halt the Notebook PC.

Hard Drive: The BIOS will prompt for a password during system bootup (POST) and Resume. If three failed attempts are made, the BIOS will freeze the Notebook PC.

The Power Menu

The Power menu of the Setup program allows you to manually enable and adjust certain power saving features of the Notebook PC, which are necessary for systems without APM or ACPI. For Windows 98 with APM or ACPI, all power saving controls (except “Suspend Mode”) are made through the operating system. Enabling these features will extend the life of the battery pack between charges. To make changes to power management settings, select Power Savings from the menu bar. The following menu appears:

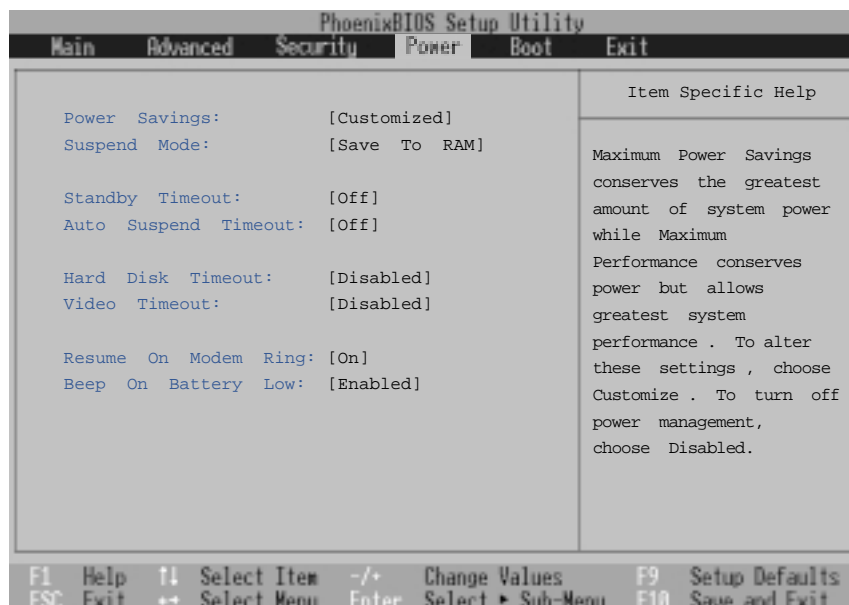

Power Savings: [Customized]

This option must be enabled to use any of the automatic power saving features. The configuration options are: [Disabled] [Customized] [Maximum Power Savings] [Maximum Performance]

If this menu item is set to Disabled, power management features will not function regardless of other field settings on this menu. The Customized option allows you to make your own selections in the Power menu. When set to **Maximum Power Savings**, system power will be conserved to its greatest amount. The next four fields will then be set to predefined values that ensure maximum power savings.

When this field is set to **Maximum Performance**, best system performance is achieved with some power conservation. The next four fields will then be set to predefined values that ensure maximum power savings

Suspend Mode: [Save to RAM]

This field determines the type of suspend mode when the Notebook PC enters power savings mode or when “Stand by” is selected from “Start – Shut Down”. The configuration options are: [Save To RAM] [Save To Disk]

Standby Timeout: [Off]

This option is only enabled when **Customized** is selected in the **Power Savings** field. This field allows you to specify the period of inactivity before the system automatically switches to Standby mode. In Standby mode, various devices including the LCD backlight are powered off and the system enters a low power CPU state. The configuration options are: [Off] [1 Minutes] [2 Minutes] [4 Minutes] [6 Minutes] [8 Minutes] [12 Minutes] [16 Minutes]

If Advanced Power Management (APM) is used, this function will be controlled by APM and may function differently depending on the APM settings.

Auto Suspend Timeout: [Off]

This field determines how much system idle time must pass before the system enters Suspend mode. When this field is set to **Off**, the system cannot enter Suspend mode, which is the lowest power state for the Notebook PC. The configuration options are: [Off] [5 Minutes] [10 Minutes] [15 Minutes] [20 Minutes] [30 Minutes] [40 Minutes] [60 Minutes]

Hard Disk Timeout: [Disabled]

This field allows you to specify the period of inactivity required before the hard disk spins down and enters power saving mode. The configuration options are: [Disabled] [1 Minute] [2 Minutes] [4 Minutes] [6 Minutes] [8 Minutes] [10 Minutes] [15 Minutes]

Video Timeout: [Disabled]

This field allows you to specify the period of inactivity required before the display panel turns off. The configuration options are: [Disabled] [1 Minute] [2 Minutes] [4 Minutes] [6 Minutes] [8 Minutes] [10 Minutes] [15 Minutes]

Resume On Modem Ring: [On]

This field is only available when Installed O/S is set to [Other] or [Win95] in the Advanced Menu. When this field is set to **On**, a modem ring will cause the system to resume from Suspend mode. **NOTE:** The Notebook PC’s internal modem is optional. The configuration options are: [Off] [On]

Beep On Battery Low: [Enabled]

This field is only available when Installed O/S is set to [Other] or [Win95] in the Advanced Menu. This option allows you to enable or disable the low battery warning beep. The configuration options are: [Disabled] [Enabled]

Boot Menu

The Boot menu allows the user to specify the order in which the Notebook PC is to check for a device to boot the system. To make changes, select **Boot** from the menu bar and the following screen appears:

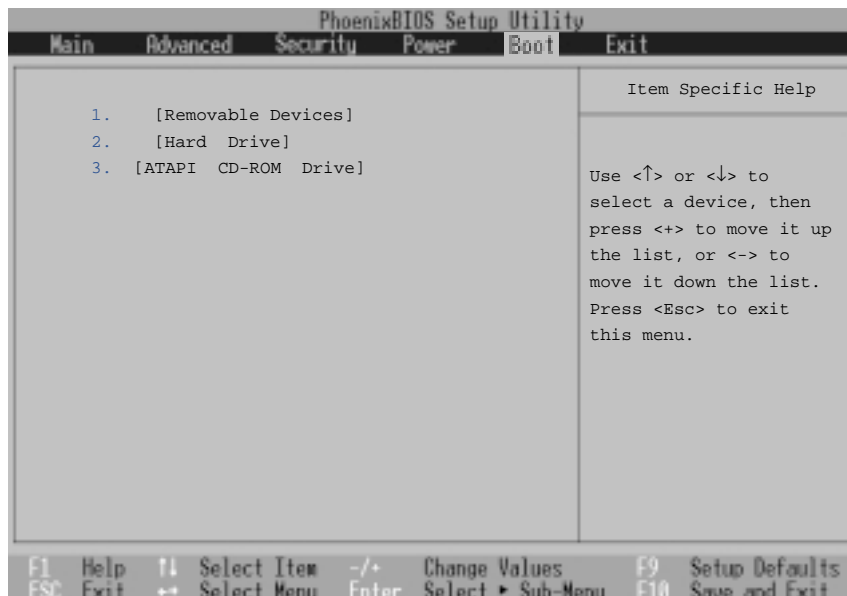

Boot Sequence

1. **[Removable Devices]**
2. **[Hard Drive]**
3. **[ATAPI CD-ROM Drive]**

The Boot menu allows you to select among the three possible boot devices listed using the up and down arrow keys. By using the [+] or [Space] keys, you can promote devices and by using the [-] key, you can demote devices. Promotion or demotion of devices alters the priority which the system uses to search for a boot device on system power up. The following are explanations of the devices listed in the boot sequence:

Removable Devices refer to floppy disks used in the built-in floppy disk drive.

Hard Drive refers to the internal built-in hard disk drive.

ATAPI CD-ROM Drive refers to either the built-in CD-ROM drive or DVD-ROM drive.

Exit Menu

Once you have made all of your selections from the various menus in the Setup program, you should save your changes and exit Setup. Select **Exit** from the menu bar to display the following menu:

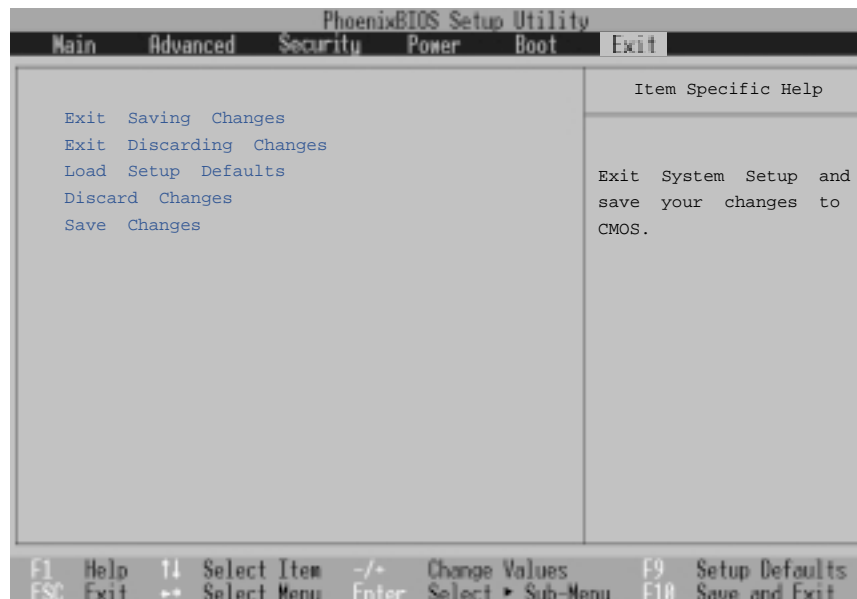

NOTE: Pressing the [Esc] key does not exit this menu. You must select one of the options from this menu or a menu bar item to exit this menu.

Exit Saving Changes

Once you are finished making your selections, choose this option from the Exit menu to ensure the values you selected are saved to the CMOS RAM. The CMOS RAM is sustained by an onboard backup battery and stays on even when the Notebook PC is turned off. Once this option is selected, a confirmation is asked. Select **Yes** to save changes and exit.

Exit Discarding Changes

This option should only be used if you do not want to save the changes you have made to the Setup program. If you have made changes to the fields other than system date, system time, and password, the system will ask for confirmation before exiting.

Load Setup Defaults

This option allows you to load the default values for each of the parameters on the Setup menus. When this option is selected or if [F9] is pressed, a confirmation is requested. Select **Yes** to load default values programmed into the BIOS file (the default values may change from one BIOS version to another). You can now select **Exit Saving Changes** or make other changes before saving the values to the EEPROM.

Discard Changes

This option allows you to discard the selections you made and restore the values you previously saved. After selecting this option, all selections are updated and a confirmation is requested. Select **Yes** to discard any changes and load the previously saved values.

Save Changes

This option saves your selections without exiting the Setup program. You can then return to other menus and make changes. After selecting this option, all selections are saved and a confirmation is requested. Select **Yes** to save any changes to the EEPROM.

APPENDIX

PortBar Accessory

Vehicle/Air Power Adapter

Internal Modem Compliancy

Glossary

Index

Owner Information

PortBar Accessory

This section is provided for the optional PortBar accessory for the Notebook PC. The main purpose of the PortBar is to provide a simple inexpensive desktop docking solution as compared to traditional bulky port replicators.

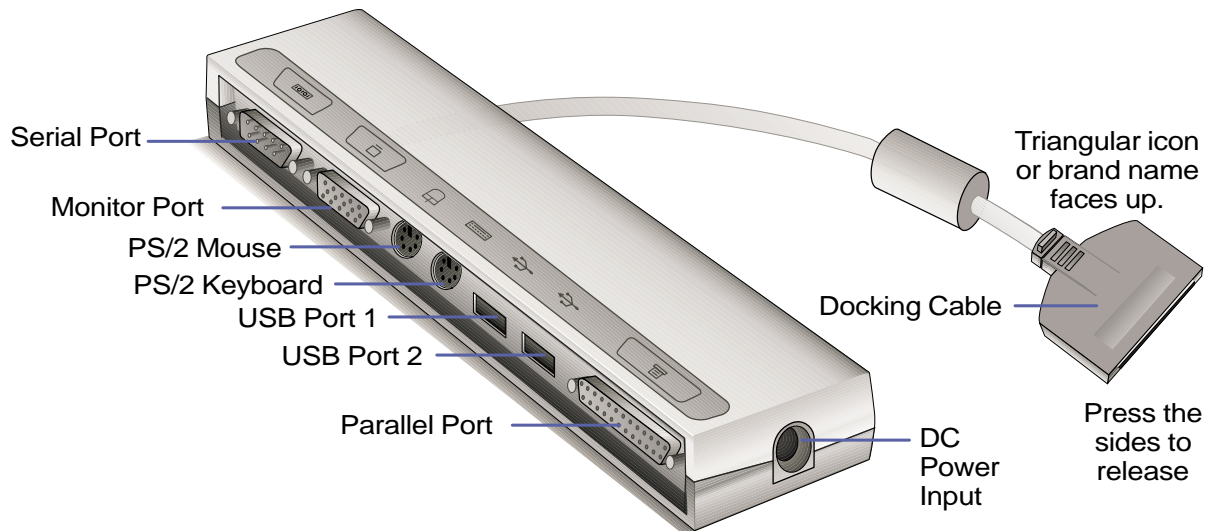

Features

The PortBar features a DC-in pass-through for powering the PortBar and the Notebook PC, serial port, parallel port, two PS/2 ports, VGA port, and two USB ports.

Usage

If you require a simple inexpensive docking solution, just use a PortBar to connect your desktop devices and then quickly connect or disconnect all the devices through a single easy-to-use connector. The PortBar's Plug & Play feature allows it to be connected or disconnected while the Notebook PC is ON or OFF (hot-dockable). Except for the device connected to the serial port, other devices should function normally while hot-dockable. If any device does not function or cannot be seen, you can refresh devices by: (1) right clicking the "My Computer" icon on the desktop, (2) selecting "Properties" on the menu, (3) selecting the "Device Manager" tab, (4) clicking the "Refresh" button, and (5) clicking "OK" button to finish.

Docking Solution

For long-term use of the Notebook PC or if the Notebook PC is intended to be a desktop replacement computer, the PortBar provides a convenient docking solution. A desktop PS/2 mouse, PS/2 keyboard, monitor, printer, serial device, and Notebook PC power can all be connected to the PortBar. The PortBar requires USB devices to be connected to the Notebook PC. When the Notebook PC is used on a permanent desk, the single docking connector can be easily used to connect or disconnect all of these desktop peripherals at once. The result is a complete desktop computer with a space-saving flat panel! When portability is required simply remove the PortBar connector (and other cables if used) and you're off!



TIP: A second power adapter will be useful so that you do not have to get under your desk to unplug the power cord each time you transport your Notebook PC. With a second power adapter kept within the carrying case, you will always have it with you when you take off in a hurry.

Vehicle/Air Power Adapter Accessory

This section is provided for the optional vehicle/air power adapter accessory for the Notebook PC. The main purpose of the vehicle/air power adapter is to provide a source of power for using the Notebook PC and/or charging the Notebook PC's battery from a 12V DC receptacle such as those found in vehicles and certain airplanes.

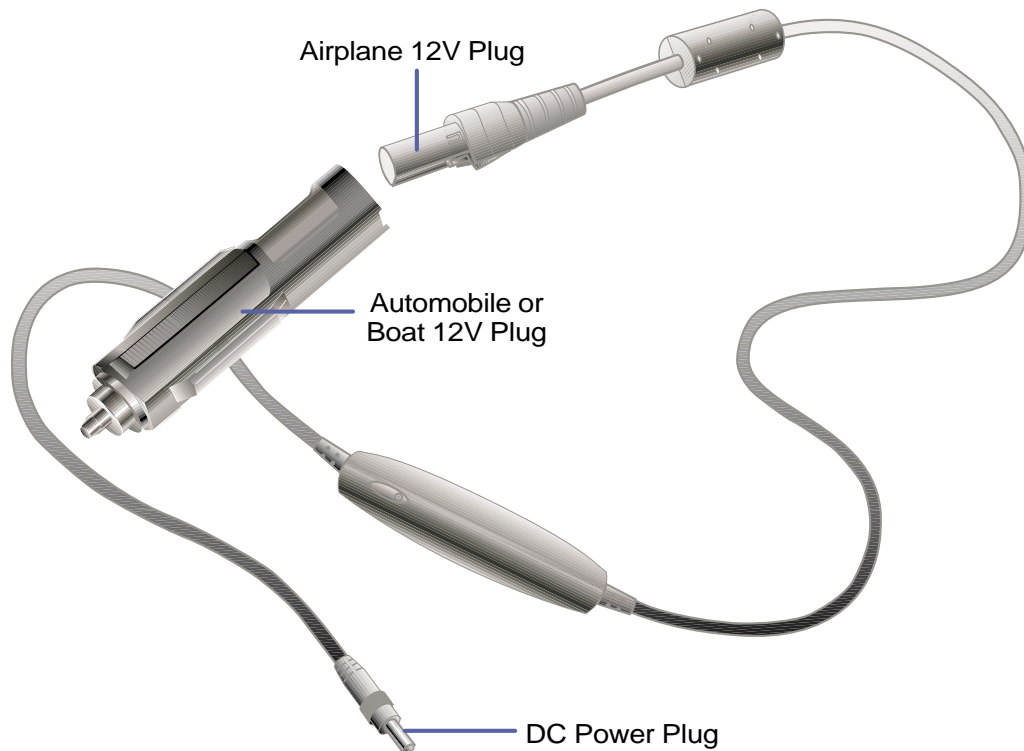

Features

The vehicle/air power adapter plugs into any vehicle's 12 volt DC cigarette or utility receptacle and produces an output of 19 Volts DC 2.64 Amp/hour or 50 Watts. These receptacles may be found in automobiles, airplanes, boats, power generators, and portable power units.

Usage

Connect the volt plug into the automobile's or boat's cigarette or utility socket firmly. For airplanes, remove the adapter as shown in the illustration above. The DC power plug is same as the main power adapter and can be connected to either the Notebook PC or to the PortBar accessory.

Internal Modem Compliancy

Protocols and Compliancy

The Notebook PC with internal modem model complies with JATE (Japan), FCC (US, Canada, Korea, Taiwan), and CTR21. The internal modem has been approved in accordance with Council Decision 98/482/EC for pan-European single terminal connection to the public switched telephone network (PSTN). However due to differences between the individual PSTNs provided in different countries, the approval does not, of itself, give an unconditional assurance of successful operation on every PSTN network termination point. In the event of problems you should contact your equipment supplier in the first instance.

Overview

On 4th August 1998 the European Council Decision regarding the CTR 21 has been published in the Official Journal of the EC. The CTR 21 applies to all non voice terminal equipment with DTMF-dialling which is intended to be connected to the analogue PSTN (Public Switched Telephone Network).

CTR 21 (Common Technical Regulation) for the attachment requirements for connection to the analogue public switched telephone networks of terminal equipment (excluding terminal equipment supporting the voice telephony justified case service) in which network addressing, if provided, is by means of dual tone multifrequency signalling.

Network Compatibility Declaration

Statement to be made by the manufacturer to the Notified Body and the vendor: "This declaration will indicate the networks with which the equipment is designed to work and any notified networks with which the equipment may have inter-working difficulties"

Network Compatibility Declaration

Statement to be made by the manufacturer to the user: "This declaration will indicate the networks with which the equipment is designed to work and any notified networks with which the equipment may have inter-working difficulties. The manufacturer shall also associate a statement to make it clear where network compatibility is dependent on physical and software switch settings. It will also advise the user to contact the vendor if it is desired to use the equipment on another network."

Up to now the Notified Body of CETECOM issued several pan-European approvals using CTR 21. The results are Europe's first modems which do not require regulatory approvals in each individual European country.

Non-Voice Equipment

Answering machines and loud-speaking telephones can be eligible as well as modems, fax machines, auto-dialers and alarm systems. Equipment in which the end-to-end quality of speech is controlled by regulations (e.g. handset telephones and in some countries also cordless telephones) is excluded.

This table shows the countries currently under the CTR21 standard.

<u>Country</u>	<u>Applied</u>	<u>More Testing</u>
Austria ¹	Yes	No
Belgium	Yes	No
Czech Republic	No	not applicable
Denmark ¹	Yes	Yes
Finland	Yes	No
France	Yes	No
Germany	Yes	No
Greece	Yes	No
Hungary	No	not applicable
Iceland	Yes	No
Ireland	Yes	No
Italy	Pending	Pending
Israel	No	No
Lichtenstein	Yes	No
Luxemburg	Yes	No
The Netherlands ¹	Yes	Yes
Norway	Yes	No
Poland	No	not applicable
Portugal	No	not applicable
Spain	No	not applicable
Sweden	Yes	No
Switzerland	Yes	No
United Kingdom	Yes	No

This information was copied from CETECOM and is supplied without liability. For updates to this table, you may visit http://www.cetecom.de/technologies/ctr_21.html

¹ National requirements will apply only if the equipment may use pulse dialling (manufacturers may state in the user guide that the equipment is only intended to support DTMF signalling, which would make any additional testing superfluous).

In The Netherlands additional testing is required for series connection and caller ID facilities.

Glossary

ACPI (Advanced Configuration and Power Management Interface)

Modern standard for reducing power usage in computers.

AUTOEXEC.BAT

AUTOEXEC.BAT is a special-purpose file that is automatically executed by DOS whenever the computer is turned ON or restarted. This file contains important commands that help configure the system to work with certain software and devices. Windows 95 and later has its own startup files and may not use or may ignore parts of the AUTOEXEC.BAT file.

BIOS (Basic Input/Output System)

BIOS is a set of routines that affect how the computer transfers data between computer components, such as memory, disks, and the display adapter. The BIOS instructions are built into the computer's read-only memory. BIOS parameters can be configured by the user through the BIOS Setup program. The BIOS can be updated using the provided utility to copy a new BIOS file into the EEPROM.

Bit (Binary Digit)

Represents the smallest unit of data used by the computer. A bit can have one of two values: 0 or 1.

Boot

Boot means to start the computer operating system by loading it into system memory. When the manual instructs you to "boot" your system (or computer), it means to turn ON your computer. "Reboot" means to restart your computer. When using Windows 95 or later, selecting "Restart" from "Start | Shut Down..." will reboot your computer.

Bus Master IDE

PIO (Programmable I/O) IDE requires that the CPU be involved in IDE access and waiting for mechanical events. Bus master IDE transfers data to/from the memory without interrupting the CPU. Bus master IDE driver and bus master IDE hard disk drives are required to support bus master IDE mode.

Byte (Binary Term)

One byte is a group of eight contiguous bits. A byte is used to represent a single alphanumeric character, punctuation mark, or other symbol.

Clock Throttling

Chipset function which allows the processor's clock to be stopped and started at a known duty cycle. Clock throttling is used for power savings, thermal management, and reducing processing speed.

COM Port

COM is a logical device name used by to designate the computer serial ports. Pointing devices, modems, and infrared modules can be connected to COM ports. Each COM port is configured to use a different IRQ and address assignment.

CPU (Central Processing Unit)

The CPU, sometimes called “Processor,” actually functions as the “brain” of the computer. It interprets and executes program commands and processes data stored in memory.

Device Driver

A device driver is a special set of instructions that allows the computer’s operating system to communicate with devices such as VGA, audio, Ethernet, printer, or modem.

Hardware

Hardware is a general term referring to the physical components of a computer system, including peripherals such as printers, modems, and pointing devices.

IDE (Integrated Drive Electronics)

IDE devices integrate the drive control circuitry directly on the drive itself, eliminating the need for a separate adapter card (in the case for SCSI devices). UltraDMA/33 IDE devices can achieve up to 33MB/Sec transfer.

LPT Port (Line Printer Port)

Logical device name reserved by DOS for the computer parallel ports. Each LPT port is configured to use a different IRQ and address assignment.

MMX

A set of 57 new instructions based on a technique called Single Instruction, Multiple Data (SIMD), which is built into the new Intel Pentium PP/MT (P55C) and Pentium II (Klamath) CPU as well as other x86-compatible microprocessors. The MMX instructions are designed to accelerate multimedia and communications applications, such as 3D video, 3D sound, video conference.

North Bridge

The CPU to PCI interface, also contains the memory and cache controllers.

PCI Bus (Peripheral Component Interconnect Local Bus)

PCI bus is a specification that defines a 32-bit data bus interface. PCI is a standard widely used by expansion card manufacturers.

Peripherals

Peripherals are devices attached to the computer via I/O ports. Peripheral devices allow your computer to perform an almost limitless variety of specialized tasks.

POST (Power On Self Test)

When you turn on the computer, it will first run through the POST, a series of software-controlled diagnostic tests. The POST checks system memory, the motherboard circuitry, the display, the keyboard, the diskette drive, and other I/O devices.

PS/2 Port

PS/2 ports are based on IBM Micro Channel Architecture. This type of architecture transfers data through a 16-bit or 32-bit bus. A PS/2 mouse and/or keyboard may be used on ATX motherboards.

RAM (Random Access Memory)

There are several different types of RAM such as DRAM (Dynamic RAM), EDO DRAM (Extended Data Output DRAM), SDRAM (Synchronous DRAM).

ROM (Read Only Memory)

ROM is nonvolatile memory used to store permanent programs (called firmware) used in certain computer components. Flash ROM (or EEPROM) can be reprogrammed with new programs (or BIOS).

SCSI (Small Computer System Interface)

High speed parallel interface defined by the X3T9.2 committee of the American National Standards Institute (ANSI) for connecting many peripheral devices.

SMB (System Management Bus)

The SMB is used for managing smart batteries, reading SDRAM configuration information, and other miscellaneous system functions.

SMI (System Management Interrupt)

A non-maskable interrupt that causes the system to enter SMM. SMM functions include power management, USB legacy keyboard control, security, hot keys, and thermal monitoring.

SMM (System Management Mode)

This is the mode of operation while SMI is active.

South Bridge

The PCI to ISA interface, also contains many legacy devices.

System Disk

A system disk contains the core file of an operating system and is used to boot up the operating system.

UltraDMA/33

UltraDMA/33 is a new specification to improve IDE transfer rates. Unlike traditional PIO mode, which only uses the rising edge of IDE command signal to transfer data, UltraDMA/33 uses both rising edge and falling edge. Hence, the data transfer rate is double of the PIO mode 4 or DMA mode 2. ($16.6\text{MB/s} \times 2 = 33\text{MB/s}$).

USB (Universal Serial Bus)

A new 4-pin serial peripheral bus that allows plug and play computer peripherals such as keyboard, mouse, joystick, scanner, printer and modem/ISDN to be automatically configured when they are attached physically without having to install drivers or reboot. With USB, the traditional complex cables from back panel of your PC can be eliminated.

Index

Symbols

32 Bit I/O 66

A

AC Power System 48
Activity Indicator 29
Advanced Menu 68
Anti-Virus Feature 69
APM and ACPI 51
Audio In (Jack) 20
Auto Suspend Timeout 75

B

Base I/O address 70, 71
Battery Pack 24
Battery Power System 49
Beep On Battery Low 75
BIOS Legend Bar 61
BIOS Menu Bar 61
BIOS Setup Program 60
Boot Menu 76
Boot Sequence 76

C

Canadian Department of Communications 2
Capital Lock 29
CardBus 44
Caring 11
CD-ROM Drive 35
CD/DVD-ROM Drive 18
Charge Indicator 16, 29
Colored Hot Keys 30
Cooling Fan 15
CTR 21 4
Cylinders 65

D

DC Power Input Jack 17
Discard Changes 78
Diskette A 63
Display Panel 15
Display Panel Latch 16
DMA channel 71
Docking Port 20
DVD-ROM Drive 36

E

Exit Discarding Changes 77
Exit Menu 77
Exit Saving Changes 77
Extended Memory 64
External Audio Connections 46
External Display Connection 43
External Monitor Port 21

F

Fast Infrared Port 17
Federal Communications Commission 2
Floppy Disk Drive 34
Floppy Disk Drive and Floppy Eject 18

G

Glossary 85

H

Hard Disk Timeout 75
Hard Disk Unlock 73
Headphone (Jack) 20
Heads 65

I

I/O Device Configuration 70
IDE Primary Master 64
IDE Primary Slave 67
Installed O/S 68
Internal Modem Compliancy 83
Internal Pointing Device 69
IR port 70
IR Wireless Communication 47

K

Kensington® Lock Port 17
Keyboard 15

L

Large Disk Access Mode 68
LBA Mode Control 65
LED Status Indicators 29
Load Setup Defaults 78
Local Bus IDE adapter 69

M

Macrovision 3
Main Menu 63
Maximum Capacity 65
Mic In (Microphone Jack) 20
Microphone 15
Microsoft Windows™ Keys 31
Modem and Network Connections 54
Modem/LAN Port 20
Monitor Out Example 43
Multi-Sector Transfers 65

N

Network Connection 54
Nordic Cautions 3
Num Lock 69
Number Lock 29
Numeric Keypad, alternate 31

O

Owner Information 90

P

Parallel Port 20
Parallel port 71
Password checking 73
PC Card (PCMCIA) Sockets and Eject 17
PC Cards (PCMCIA) 44
Pointing Device 40
PortBar Accessory 80
Power Connection 26
Power Indicator 16, 29
Power Management Modes 51
Power Savings 74
Power State Summary 52
Power Switch 16
Power-On Self Test (POST) 27
Powering ON 27
Processor Upgrades 53
PS/2 Port 21

Q

QuickBoot Mode 69

R

Region Definitions 37
Regional Playback Information 37
Restarting or Rebooting 28
Resume On Modem Ring 75

S

Save Changes 78
Save-to-Disk Partition 28
Sectors 65
Securing Your Notebook PC 55
Security Menu 72
Serial Port 20
Serial Port A 70
Set Password 73
Standby Mode 52
Standby Timeout 75
Status LEDs 15
Stereo Speakers 16
Suspend Mode 51, 75
System Date 63
System Memory 64
System Memory Expansion 53
System Time 63

T

The Power Menu 74
Thermal Power Control 53
Touchpad and Buttons 15
Touchpad, Caring 42
Touchpad, Using 40
Transfer Mode 66
Transportation 12
TV Mode 69
TV-Out Example 43
TV-Out Port 21
Twisted-Pair Cable 54
Type 65

U

Ultra DMA Mode 66
Universal Serial Bus 48
Updating Your BIOS 58
User's Manual 10

V

Vehicle/Air Power Adapter Accessory 82
Video Display Device 64
Video Timeout 75
Volume Control 19

Z

Zoomed Video Port 44

Owner Information

This page is provided for recording information concerning your Notebook PC for future reference or for technical support. Keep this User's Manual in a secured location if passwords are filled out.

Owner's Name: _____ Owner's Telephone: _____

Manufacturer: _____ Model: _____

Retailer: _____ Telephone: _____

Display Size: _____ Purchase Date: _____ Serial Number: _____

Hard Disk Drive Manufacturer: _____ Capacity: _____

2nd Hard Disk Drive Manufacturer: _____ Capacity: _____

BIOS Version: _____ Date: _____

Accessories: _____ Serial Number: _____

Accessories: _____ Serial Number: _____

SOFTWARE

Operating System: _____

Software: _____ Serial Number: _____

Software: _____ Serial Number: _____

SECURITY

Bootup Password: _____ Hard Drive Password: _____

NETWORK

User's Name: _____ Password: _____ Domain: _____

User's Name: _____ Password: _____ Domain: _____

ASUS[®] Means Business!

ASUSTeK COMPUTER INC. (ASUS) was established on April 1st, 1989. Since then, ASUS has been devoted to providing Leading Edge Technology and Best Value Solutions at the highest quality to all its customers.

ASUS' annual sales revenue for 1998 reached 1.09 billion USD with a net capital of 245 million USD. The annual motherboard sales volume for 1998 reached 8.8 million and 13.5 million by the end of 1999. Currently, ASUS is capable of producing well over 1,000,000 motherboards and over 100,000 notebook PCs monthly.

ASUS' strong research and development (R&D) team is able to provide advanced products a step further than our competitors to assure more competition and variance in the computer industry. ASUS currently offers motherboards, CD/DVD-ROM Drives, Notebook PCs, Servers, SCSI cards, Graphics cards, Network cards, and broadband modems. ASUS is working on developing many new computer-related products for the near future.

ASUS has been recognized by customers worldwide for consistently delivering products of the highest quality and reliability. This is the reason why leading European, American, and Asian system integrators and OEM customers have chosen ASUS as their strategic partner.

Being a leading computer manufacturer, ASUS has

- successfully launched the worlds Lightest and Slimmest Notebook PC in August 1999
- released the world's first RIVA TNT2 VGA cards with 3D spectacles in May 1999
- released the first 50X CD-ROM drive in April 1999
- introduced the first 40X CD-ROM drive in February 1999
- honorably received ISO-14000 Certification in November 1998
- successfully launched the first Lightest notebook computer in 1998
- introduced the first 34X CD-ROM drive in 1998
- successfully launched its first Notebook PC in 1997
- introduced the ASUSPRO server series in 1997
- ranked No. 1 in both innovation and quality in Sep. 1995 (reported by Asian Sources magazine)
- ranked #5 in business management in Taiwan in 1995 (reported by China Credit Information Service, Ltd.)
- has been the first to introduce and mass produce dual Pentium-based motherboards in 1994
- received the highest rating in terms of compatibility and quality in 1994 (reported by C.t. magazine)
- has been certified for the fulfillment of ISO 9002

ASUS is committed to quality and has implemented a Total Quality Program. During the design phase, the R&D department goes through an intense design review and simulation process. During the manufacturing phase, advanced SMT and auto-testing equipments are being used. All ASUS products go through rigorous testing in the production line, and dynamic aging in the burn-in room. ASUS' quality control program includes: Incoming Quality Control, In Process Quality Control, Reliability Testing, and Environment Testing. To fulfill the social responsibilities of an enterprise, many policies are required to minimize any likely impacts that the plant's production activities may have toward the environment. Thus, ASUS has setup Environmental and Occupational Health & Safety Policies to protect the environment.

ASUS' strong technical support team is prepared to deliver quick and effective solutions before and after sales. The use of sophisticated catalogues, sales kits, test reports, quality manuals, technical bulletins, World Wide Web, and technical Q&A are used in pre-sales activities. For after sales activities, the technical support team is bonded tightly with the R&D team to solve a majority of questions from phone calls, newsgroups, and e-mails. Finally, the introduction of the new GSM (Global Service Member) Program is specially designed for international travelers to provide the best possible warranty service for ASUS products around the world.

Visit www.asus.com for updated specifications

ASUS® Barebone Servers

	Pentium® III Pentium® II Support	PC100 ECC Max. Memory (GB)	Ultra2 SCSI Onboard (Channels)	5.25" Fixed Storage Devices	Hot-Swap Trays
AP100	1	1	1	3	0
AP200	2	1	1	3	0
AP2000	2	1	1	4	3 or 5*
AP2500	2	1	1	4	3 or 5*
AP3000	2 Xeon™	2	2	4	3 or 5*
AP6000	2	1	1	4	8**
AP7500	2	1	1	4	8**
AP8000	2 Xeon™	2	2	4	8**

* Three 1.6-inch or five 1-inch SCA-2 SCSI hard drives

** Eight 1.6-inch or 1-inch SCSI hard drives

Mid-Range Servers

AP6000
AP7500
AP8000

Value Servers

AP2000
AP2500
AP3000

Group Servers

AP100
AP200

ASUS PCI-DA2100/2200 Series SCSI RAID Card



AR1000 RAID Subsystem

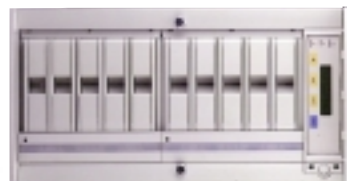

Rack Mountable

Visit www.asus.com for updated specifications

ASUS® 8x DVD-ROM Drive



- Industry-leading performance for even the most demanding applications
- Maximum transfer rate: 8X DVD-ROM / 40X CD-ROM
- High speed digital audio extraction
- Supports UltraDMA/33 transfer mode
- Complies with MPC3 standard
- Supports Multi-Read function

ASUS® Ultra-Fast CD-ROM



- Supports high speed CD-Audio playback
- Supports high speed digital audio extraction
- Supports UltraDMA/33 transfer mode
- Compatible with all CD formats
- Supports multi-read function (CD-R/CD-RW)

Visit www.asus.com for updated specifications

AGP-V6800 Series

Span the Graphics Globe
with DDR Intelligence



GeForce²⁵⁶ DDR

- Powered by the world's latest GeForce256[™] DDR GPU
- 300MHz DDR video memory – delivers extra performance at high resolutions with 32-bit color
- Optimized for D3D & OpenGL VR game playing and stereoscopic video/picture viewing
- Real-time 30 frames/sec 704x480 video capture
- VideoSecurity – auto-notification system to monitor environmental deviation
- Models available:
 1. AGP-V6800 : GeForce256[™] DDR, 32MB DDR SGRAM, VGA
 2. AGP-V6800 Deluxe : GeForce256[™] DDR, 32MB DDR SGRAM, VGA, TV-out, Video-in, VR 3D glasses



ASUS
www.asus.com

Visit www.asus.com for updated specifications

ASUS® Goes Mobile!



L8400 Series

Compact Professional Notebook PC

- 14.1" TFT Color Display
- 450MHz to 700MHz+
- 64MB to 192MB Memory
- 2X AGP 3D w/8MB VRAM
- 100MHz Processor Side Bus

M8300/8200 Series

Thin & Light Convertible Notebook PC

- 13.3" or 12.1" TFT Color Display
- 366MHz to 650MHz+
- 64MB to 192MB Memory
- Supports Two Hard Drives



L7300/7200 Series

All-in-One Compact Notebook PC

- 13.3" or 12.1" TFT Color Display
- 366MHz to 650MHz+
- 64MB to 192MB Memory

Visit www.asus.com for updated specifications

