

ASUS[®] AP1720-E2

Dual Intel[®] Xeon[™] 5U Rackmount Server
800/533MHz Front Side Bus

User Guide



E1733

**First Edition V1
October 2004**

Copyright © 2004 ASUSTeK COMPUTER INC. All Rights Reserved.

No part of this manual, including the products and software described in it, may be reproduced, transmitted, transcribed, stored in a retrieval system, or translated into any language in any form or by any means, except documentation kept by the purchaser for backup purposes, without the express written permission of ASUSTeK COMPUTER INC. ("ASUS").

ASUS provides this manual "as is" without warranty of any kind, either express or implied, including but not limited to the implied warranties or conditions of merchantability or fitness for a particular purpose. In no event shall ASUS, its directors, officers, employees, or agents be liable for any indirect, special, incidental, or consequential damages (including damages for loss of profits, loss of business, loss of use or data, interruption of business and the like), even if ASUS has been advised of the possibility of such damages arising from any defect or error in this manual or product.

Specifications and information contained in this manual are furnished for informational use only, and are subject to change at any time without notice, and should not be construed as a commitment by ASUS. ASUS assumes no responsibility or liability for any errors or inaccuracies that may appear in this manual, including the products and software described in it.

Product warranty or service will not be extended if: (1) the product is repaired, modified or altered, unless such repair, modification or alteration is authorized in writing by ASUS; or (2) the serial number of the product is defaced or missing.

Products and corporate names appearing in this manual may or may not be registered trademarks or copyrights of their respective companies, and are used only for identification or explanation and to the owners' benefit, without intent to infringe.

Contents

Notices	v
Safety information	vi
About this guide	vii
Chapter 1: Product introduction	
1.1 System package contents	1-2
1.2 System specifications	1-3
1.3 Front panel features	1-4
1.4 Rear panel features	1-6
1.5 Internal features	1-7
1.6 LED information	1-10
Chapter 2: Hardware setup	
2.1 Chassis cover	2-2
2.1.1 Removing the side cover	2-2
2.1.2 Re-installing the side cover	2-3
2.2 Motherboard information	2-4
2.3 Central Processing Unit (CPU)	2-5
2.3.1 Overview	2-5
2.3.2 Installing the CPU	2-5
2.3.3 Installing the CPU heatsink and fan	2-7
2.4 System memory	2-10
2.4.1 Overview	2-10
2.4.2 Memory configurations	2-10
2.4.2 Installing a DIMM	2-12
2.4.3 Removing a DIMM	2-12
2.5 Front panel assembly	2-13
2.5.1 Removing the front panel assembly	2-13
2.5.2 Re-installing the front panel assembly	2-15
2.6 5.25-inch drives	2-16
2.7 Hard disk drives	2-19
2.7.1 Installing a hot-swap SATA/SCSI hard disk drive	2-19
2.7.2 Installing an internal IDE/SATA HDD	2-21
2.8 Expansion cards	2-26
2.8.1 Installing a standard size expansion card	2-26
2.8.2 Installing a long expansion card	2-28
2.8.3 Removing an expansion card	2-29

Contents

2.9	Cable connections	2-30
2.9.1	Motherboard connections	2-30
2.9.2	SATA backplane connections	2-31
2.9.3	SCSI backplane connections	2-34
2.10	Removable components	2-39
2.10.1	Chassis fan	2-39
2.10.2	HDD fan	2-41
2.10.3	SATA/SCSI backplane	2-44
2.10.4	Floppy disk drive	2-46
2.10.5	Front I/O board	2-48
2.10.6	Chassis footpads and roller wheels	2-50
2.10.7	Power supply modules	2-52

Chapter 3: Installation options

3.1	Installing a second SCSI drive cage	3-2
3.2	Installing an IDE drive cage	3-5
3.3	Upgrading to a dual or redundant power supply	3-7
3.4	Installing a power supply module	3-9
3.5	Mounting the system to a rack	3-11
3.5.1	Remove the footpads or roller wheels	3-11
3.5.2	Remove the top cover	3-11
3.5.3	Attach the rack rails	3-11

Chapter 4: Motherboard info

4.1	Motherboard layout	4-2
4.2	Jumpers	4-4
4.3	Connectors	4-8

Chapter 5: BIOS setup

5.1	Managing and updating your BIOS	5-2
5.1.1	Creating a bootable floppy disk	5-2
5.1.2	AwardBIOS Flash Utility	5-3
5.1.3	ASUS EZ Flash Utility	5-7
5.2	BIOS Setup program	5-8
5.2.1	BIOS menu screen	5-9
5.2.2	Menu bar	5-9
5.2.3	Navigation keys	5-9
5.2.4	General help	5-10

5.2.5	Sub-menu	5-10
5.2.6	Scroll bar	5-10
5.2.7	Pop-up window	5-10
5.3	Main menu	5-11
5.3.1	Primary IDE Master	5-12
5.3.2	Primary IDE Slave	5-15
5.3.3	Secondary IDE Master	5-15
5.3.4	Secondary IDE Slave	5-15
5.3.5	Third IDE Master	5-16
5.3.6	Fourth IDE Master	5-16
5.4	Advanced menu	5-17
5.4.1	Advanced BIOS Features	5-17
5.4.2	CPU Configuration	5-18
5.4.3	Memory Configuration	5-19
5.4.4	Chipset	5-20
5.4.5	Onboard Device	5-23
5.4.6	PCIPnP	5-28
5.4.7	USB Configuration	5-30
5.5	Power menu	5-31
5.5.1	APM Configuration	5-32
5.5.2	Hardware Monitor	5-35
5.6	Boot menu	5-37
5.6.1	Boot Device Priority	5-37
5.6.2	Hard Disk Boot Priority	5-38
5.6.3	Removable Device Priority	5-38
5.6.4	Boot Settings Configuration	5-39
5.6.5	Security	5-41
5.7	Exit menu	5-43

Appendix: Reference information

A.1	600 W single power supply	A-2
A.1.1	General description	A-2
A.1.2	Specifications	A-3
A.2	600 W dual/redundant power supply	A-4
A.2.1	General description	A-4
A.2.2	Specifications	A-5
A.3	Simple fixes	A-6

Notices

Federal Communications Commission Statement

This device complies with Part 15 of the FCC Rules. Operation is subject to the following two conditions:

- This device may not cause harmful interference, and
- This device must accept any interference received including interference that may cause undesired operation.

This equipment has been tested and found to comply with the limits for a Class B digital device, pursuant to Part 15 of the FCC Rules. These limits are designed to provide reasonable protection against harmful interference in a residential installation. This equipment generates, uses and can radiate radio frequency energy and, if not installed and used in accordance with manufacturer's instructions, may cause harmful interference to radio communications. However, there is no guarantee that interference will not occur in a particular installation. If this equipment does cause harmful interference to radio or television reception, which can be determined by turning the equipment off and on, the user is encouraged to try to correct the interference by one or more of the following measures:

- Reorient or relocate the receiving antenna.
- Increase the separation between the equipment and receiver.
- Connect the equipment to an outlet on a circuit different from that to which the receiver is connected.
- Consult the dealer or an experienced radio/TV technician for help.



WARNING! The use of shielded cables for connection of the monitor to the graphics card is required to assure compliance with FCC regulations. Changes or modifications to this unit not expressly approved by the party responsible for compliance could void the user's authority to operate this equipment.

Canadian Department of Communications Statement

This digital apparatus does not exceed the Class B limits for radio noise emissions from digital apparatus set out in the Radio Interference Regulations of the Canadian Department of Communications.

This class B digital apparatus complies with Canadian ICES-003.

Safety information

Electrical Safety

- Before installing or removing signal cables, ensure that the power cables for the system unit and all attached devices are unplugged.
- To prevent electrical shock hazard, disconnect the power cable from the electrical outlet before relocating the system.
- When adding or removing any additional devices to or from the system, ensure that the power cables for the devices are unplugged before the signal cables are connected. If possible, disconnect all power cables from the existing system before you add a device.
- If the power supply is broken, do not try to fix it by yourself. Contact a qualified service technician or your dealer.

Operation Safety

- Any mechanical operation on this server must be conducted by certified or experienced engineers.
- Before operating the server, carefully read all the manuals included with the server package.
- Before using the server, make sure all cables are correctly connected and the power cables are not damaged. If any damage is detected, contact your dealer as soon as possible.
- To avoid short circuits, keep paper clips, screws, and staples away from connectors, slots, sockets and circuitry.
- Avoid dust, humidity, and temperature extremes. Place the server on a stable surface.



This product is equipped with a three-wire power cable and plug for the user's safety. Use the power cable with a properly grounded electrical outlet to avoid electrical shock.

Lithium-Ion Battery Warning

CAUTION! Danger of explosion if battery is incorrectly replaced. Replace only with the same or equivalent type recommended by the manufacturer. Dispose of used batteries according to the manufacturer's instructions.

CD-ROM Drive Safety Warning

CLASS 1 LASER PRODUCT

Heavy System

CAUTION! This server system is heavy. Ask for assistance when moving or carrying the system.

About this guide

Audience

This user guide is intended for system integrators, and experienced users with at least basic knowledge of configuring a server.

Contents

This guide contains the following parts:

1. Chapter 1: Product Introduction

This chapter describes the general features of the AP130-E1 server. It includes sections on front panel and rear panel specifications.

2. Chapter 2: Hardware setup

This chapter lists the hardware setup procedures that you have to perform when installing or removing system components.

3. Chapter 3: Installation options

This chapter describes how to install optional components into the barebone server.

4. Chapter 4: Motherboard information

This chapter includes the motherboard layout and brief descriptions of the jumpers and internal connectors.

5. Chapter 5: BIOS setup

This chapter tells how to change the system settings through the BIOS Setup menus. Detailed descriptions of the BIOS parameters are also provided.

6. Appendix: Reference information

This appendix gives information on the standard or redundant power supply that came with the barebone server. This section also provides a troubleshooting guide for solving common problems when using the barebone server.

Conventions

To make sure that you perform certain tasks properly, take note of the following symbols used throughout this manual.



WARNING: Information to prevent injury to yourself when trying to complete a task.



CAUTION: Information to prevent damage to the components when trying to complete a task.



IMPORTANT: Information that you **MUST** follow to complete a task.



NOTE: Tips and information to aid in completing a task.

Reference

Visit the ASUS websites worldwide that provide updated information for all ASUS hardware and software products. Refer to the ASUS contact information for details.

Chapter 1

This chapter describes the general features of the barebone server. It includes sections on the front panel and rear panel specifications.



1.1 System package contents

Check your ASUS AP1720-E2 package with the items on the following table. The package contents vary for the following configurations:

- **AS8** (eight hot-swap SCSI hard disk drives)
- **AS4** (four hot-swap SCSI hard disk drives)
- **AA4** (four hot-swap SATA hard disk drives)
- **AI4** (four internal SATA/IDE hard disk drives)

Item Description	Configurations			
	AS8	AS4	AA4	AI4
ASUS AK25 5U rackmount chassis with:	●	●	●	●
• ASUS NCCH-DL motherboard	●	●	●	●
• 600 W single or redundant power supply*	●	●	●	●
• SATA backplane board			1	
• SCSI backplane board	2	1		
• ASUS U320 SCSI card and cable	●	●		
• 52x CD-ROM drive	●	●	●	●
• Floppy disk drive	●	●	●	●
• Chassis fan	●	●	●	●
• HDD fan	2	1	1	
• Hot-swap HDD trays (including HDD screws)	8	4	4	
• Internal HDD rails (4 pairs)				●
• Chassis roller wheels (1 set)	●	●	●	●
• Front I/O board	●	●	●	●
• SATA signal cable (4 sets)			●	●
• SATA power cable				●
• SMBus cable	●	●	●	●
• Dummy covers (4 pieces)		4	4	8
AC power cable	●	●	●	●
System screws and cables	●	●	●	●
System keys (2 pcs.)	●	●	●	●
Bundled CDs				
• AP1720-E2 support CD with ASWM**	●	●	●	●
• TrendMicro® ServerProtect® CD	●	●	●	●
Documentation				
• ASUS AP1720-E2 user guide	●	●	●	●
• ASUS NCCH-DL user guide	●	●	●	●
Optional items				
• ASUS AK25 rackmount rail kit	●	●	●	●
• ASUS AK25 internal HDD cage (non-hot swap)	●	●	●	●
• ASUS AK25 600 W 2+1 redundant power supply	●	●	●	●

* All models support a 600 W single or redundant power supply.

** ASUS System Web-based Management

1.2 System specifications

The ASUS AP1720-E2 is a barebone server system featuring the ASUS NCCH-DL motherboard. The server supports dual Intel® Xeon™ processors in 604-pin sockets, and includes the latest technologies through the chipsets embedded on the motherboard.

Chassis	Pedestal or rackmount 5U with removable front door bezel and chassis foot stand or roller-wheels.
System dimension	431 mm (H) x 220 mm (W) x 510 mm (D)
Motherboard	ASUS NCCH-DL (ATX form factor: 12 in x 9.8 in)*
Chipset	Intel® E82875P Memory Controller Hub (MCH) Intel® 6300ESB I/O Controller Hub (ICH)
Processor	Socket 604 for Intel® Xeon™ Nocona/Prestonia CPU with 800/533MHz FSB and on-die 1MB/512KB L2 cache with full speed
Memory	4 x 184-pin DDR sockets for up to 4GB memory Supports PC3200/2700/2100 unbuffered ECC or non-ECC DDR DIMMs
LAN	Intel® 82547GI Gigabit LAN controller(CSA)
RAID	Promise® PDC20319 controller (supports RAID 0/RAID 1/RAID 0+1/Multi-RAID)
Expansion slots	1 x AGP Pro/8X slot 2 x 64-bit/66Mhz 3.3V PCI-X slots** 2 x 32-bit/33Mhz 5V PCI slots
Drive bays	1 x 3.25-inch FDD bay 3 x 5.25-inch drive bays
Front I/O	1 x IEEE 1394 port 1 x Headphone port 1 x Microphone port
Rear panel I/O	1 x Parallel port 2 x Serial ports 1 x LAN (RJ-45) port 4 x USB 2.0 ports 1 x IEEE 1394 port 1 x PS/2 keyboard port 1 x PS/2 mouse port Line In / Line Out / Microphone ports
Management	ASUS Server Web-based Management (ASWM) 2.0
Hardware monitors	Voltage, temperature, and fan speed monitoring Automatic System Restart (ASR) feature
Power supply	600 W power supply <i>(with 24-pin and 8-pin power plugs)</i> or 600 W redundant power supply <i>(optional)</i>

* Refer to Chapter 4 "Motherboard information" for information on the internal connectors.

** In AS8/AS4 models, the ASUS U160/U320 SCSI card occupies one 64-bit PCI-X slot.

1.3 Front panel features

The AP1720-E2 chassis displays a stylish front bezel with lock. The bezel covers the system components on the front panel and serves as security. Open the bezel to access the front panel components.

The drive bays, power and reset buttons, LED indicators, CD-ROM drive, floppy drive, IEEE 1394 and front panel audio ports are located on the front panel. For future installation of 5.25-inch devices, two drive bays are available.



If you wish to access front I/O ports and floppy disk drive without opening the bezel, hold the tab and move the sliding panel (rightmost panel) to the left as shown.

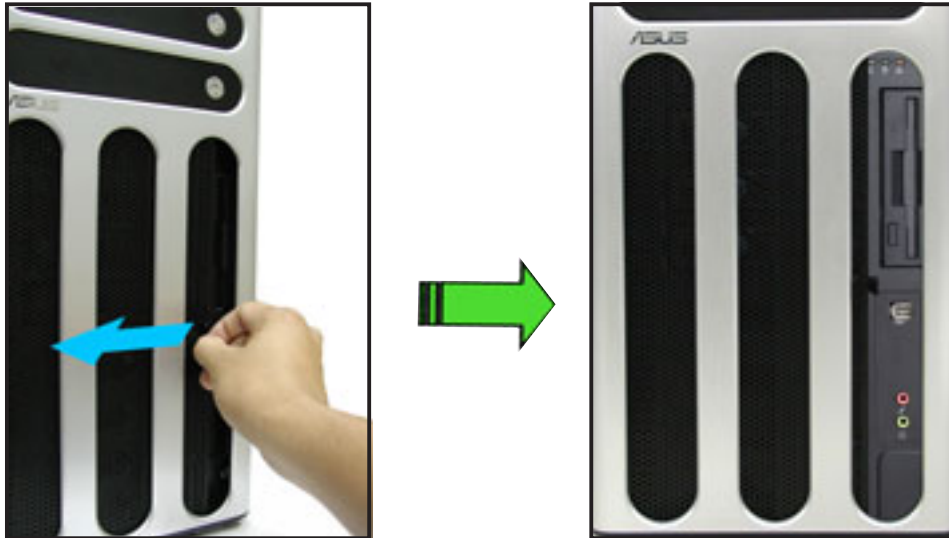

1.4 Rear panel features

The rear panel includes a slot for the motherboard rear I/O ports, expansion slots, a chassis lock and intrusion switch, a vent for the system fan, and power supply module.

Single power supply models

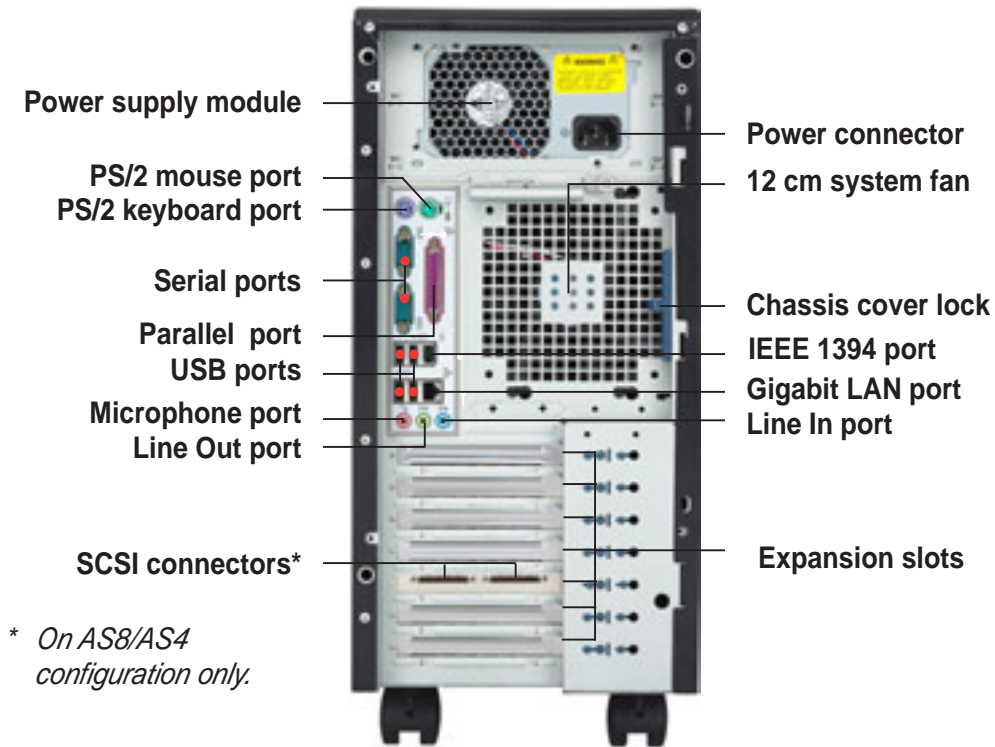

Redundant power supply models

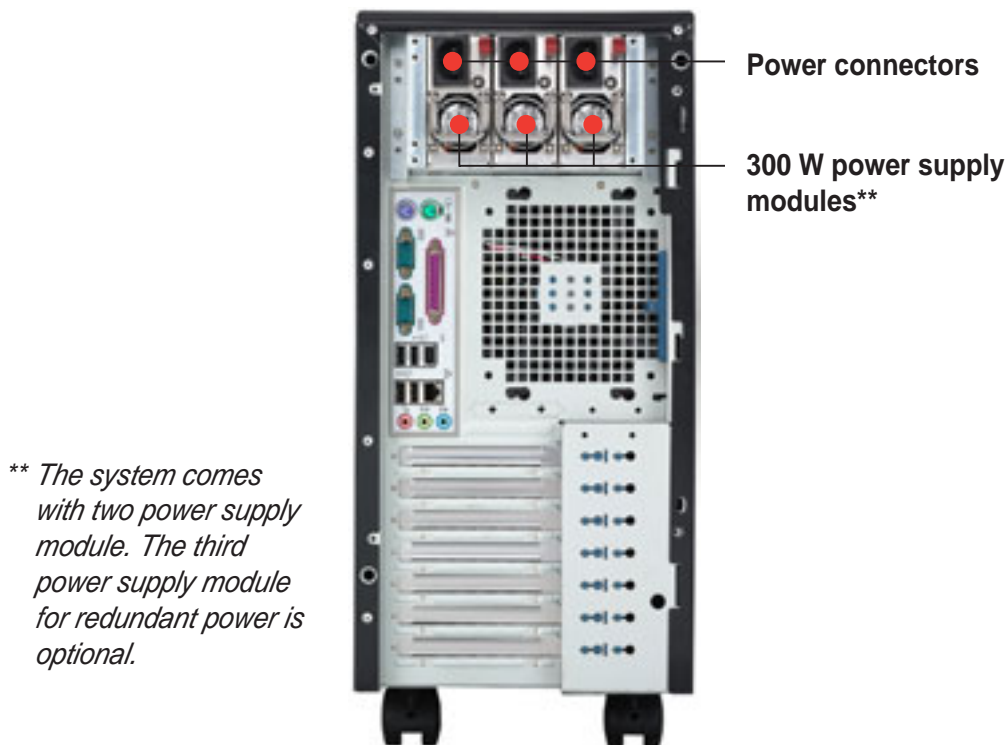

1.5 Internal features

The barebone server system includes the basic components as shown.

AI4 (four internal IDE/SATA configuration)

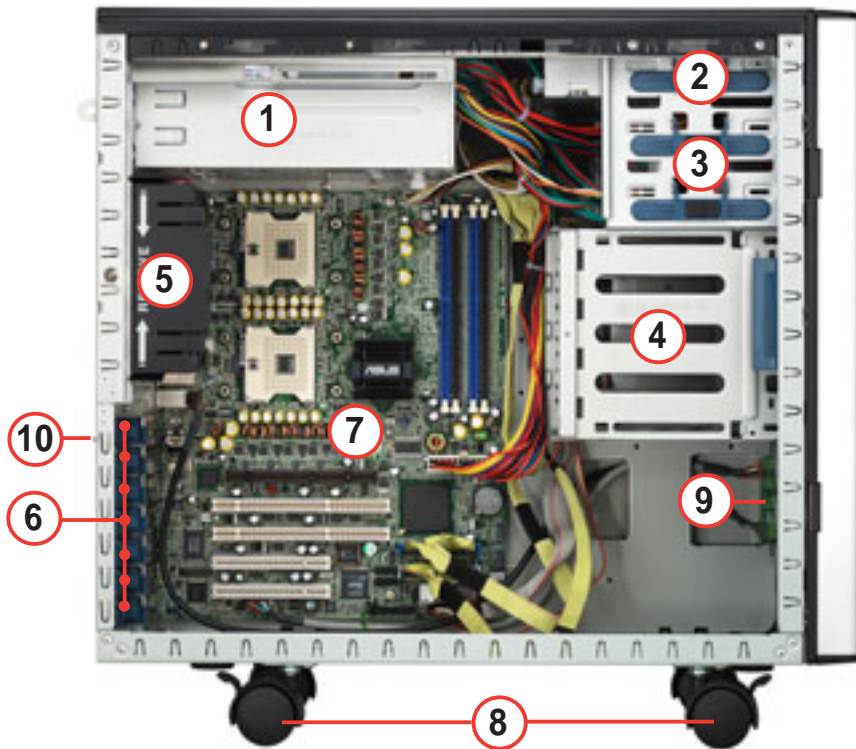

- | | |
|-----------------------------|------------------------------|
| 1. Power supply cage | 6. Expansion card locks |
| 2. CD-ROM drive | 7. NCCH-DL motherboard |
| 3. 2 x 5.25-inch drive bays | 8. Chassis roller wheels |
| 4. Hard disk drive cage | 9. Front I/O board |
| 5. Chassis fan | 10. Chassis intrusion switch |

AA4 (four hot-swap SATA configuration)

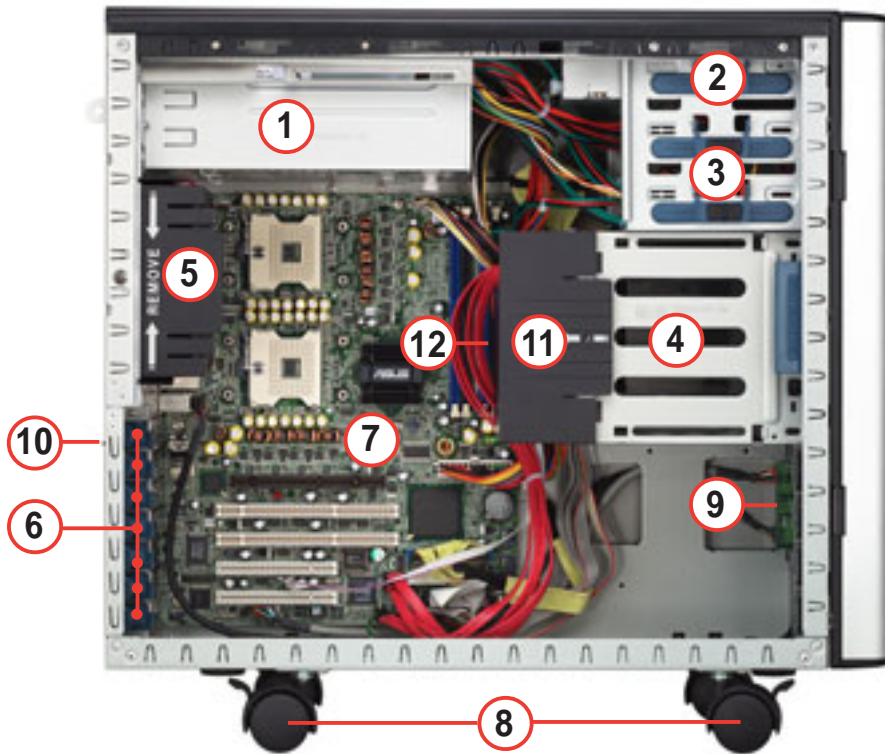

AS4 (four hot-swap SCSI configuration)

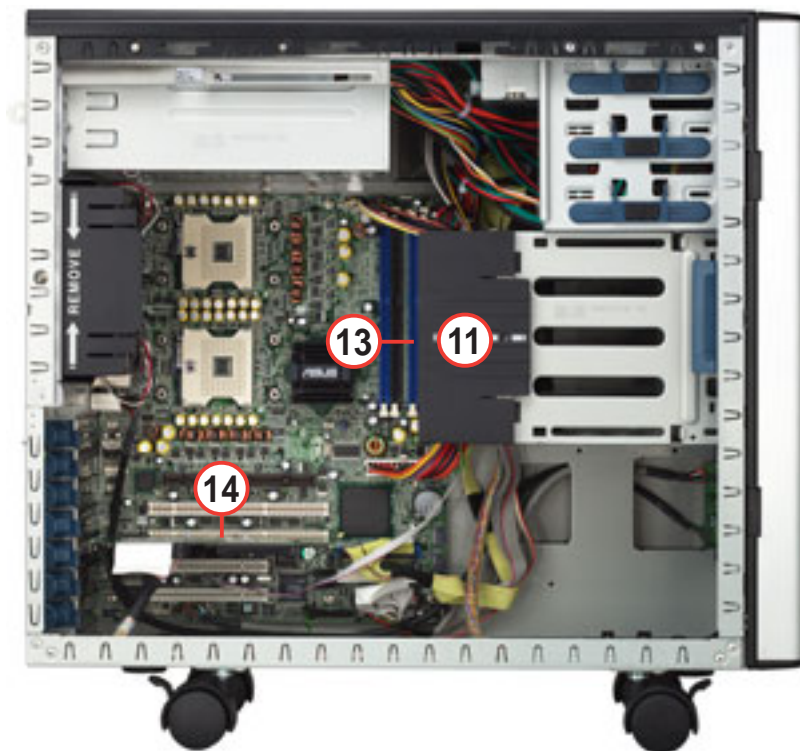

AS8 (eight hot-swap SCSI configuration)

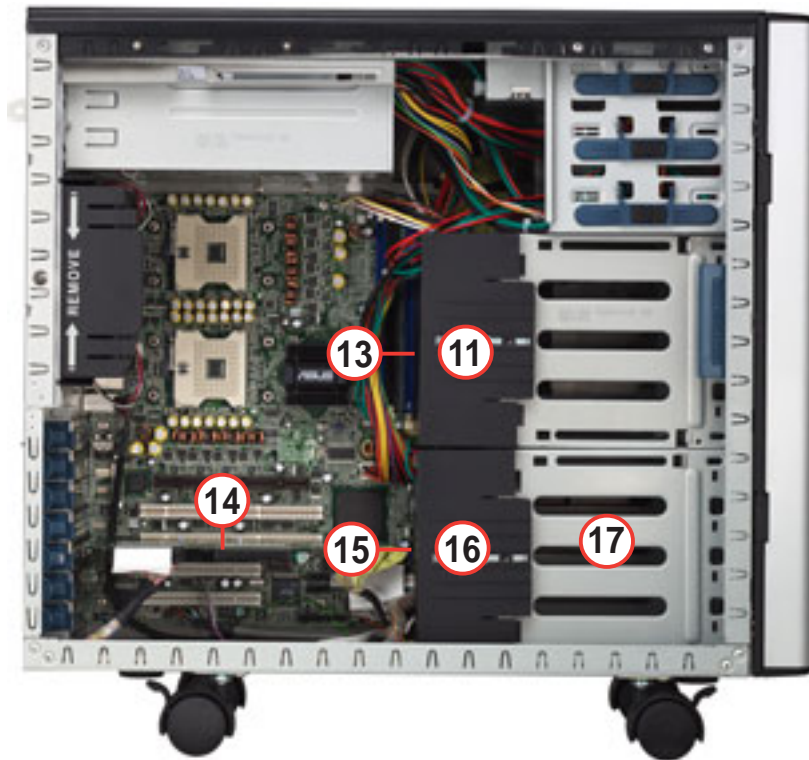



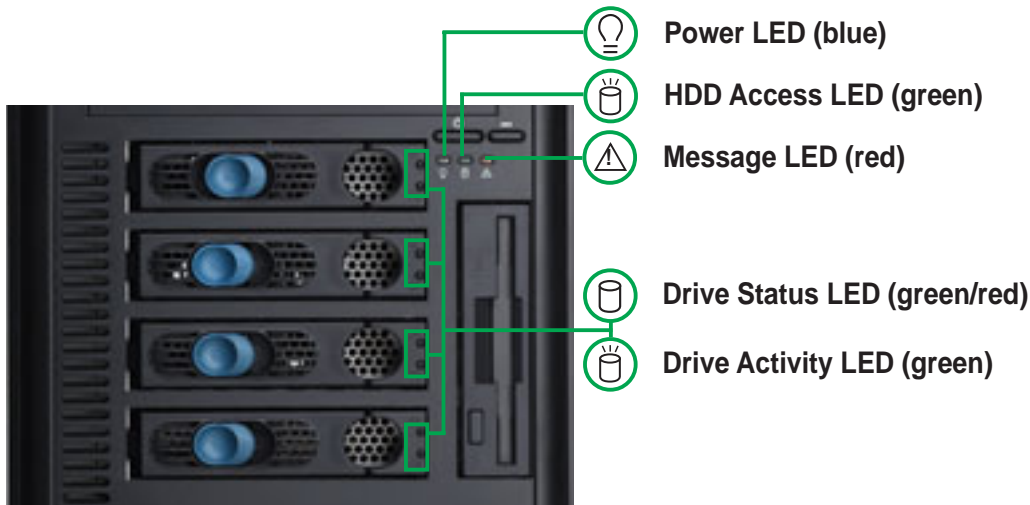

1. Power supply cage
2. CD-ROM drive
3. 2 x 5.25-inch drive bays
4. Hard disk drive cage
5. Chassis fan
6. Expansion card locks
7. NCCH-DL motherboard
8. Chassis roller wheels
9. Front I/O board
10. Chassis intrusion switch
11. HDD fan
12. SATA backplane (hidden)
13. SCSI backplane (hidden)
14. ASUS U160/U320 SCSI card
15. Second SCSI backplane (hidden)
16. Second HDD fan
17. Second hard disk drive cage

1.6 LED information

The barebone system comes with five LED indicators. Refer to the following table for the LED status description.



LED	Icon	Display status	Description
System			
Power LED		ON Blinking	System power ON System is in suspend mode
HDD Access LED		OFF Blinking	No activity Read/write data into the HDD
Message LED		OFF Blinking	System is normal; no incoming event ASMS indicates a HW monitor event
Hard disk drives			
Drive Status LED		Green Red Red and Green blinking alternately*	Installed HDD is in good condition HDD failure HDD rebuilding using the RAID card SAF-TE** function
Drive Activity LED		Blinking	Read/write data into the HDD

* For SCSI models only (AS8/AS4)

** SCSI Access Fault-Tolerant Enclosure (on AS8/AS4 models only)



- The Power, HDD Access, and Message LEDs are visible even if the system front bezel is closed.
- For AA4 configuration:
 1. The Drive Activity LEDs do not light up
 2. The Drive Status LEDs only light up green to indicate that the installed Serial ATA HDD is in good condition.

Chapter 2

This chapter lists the hardware setup procedures that you have to perform when installing or removing system components.



ASUS AP1720-E2 barebone server

Hardware setup

2.1 Chassis cover

The chassis features a “screwless design” that allows convenient assembly and disassembly. You can simply push or slide mechanical bolts and locks to remove the cover.

2.1.1 Removing the side cover

1. Push up the chassis lock on the rear panel to release the side cover.

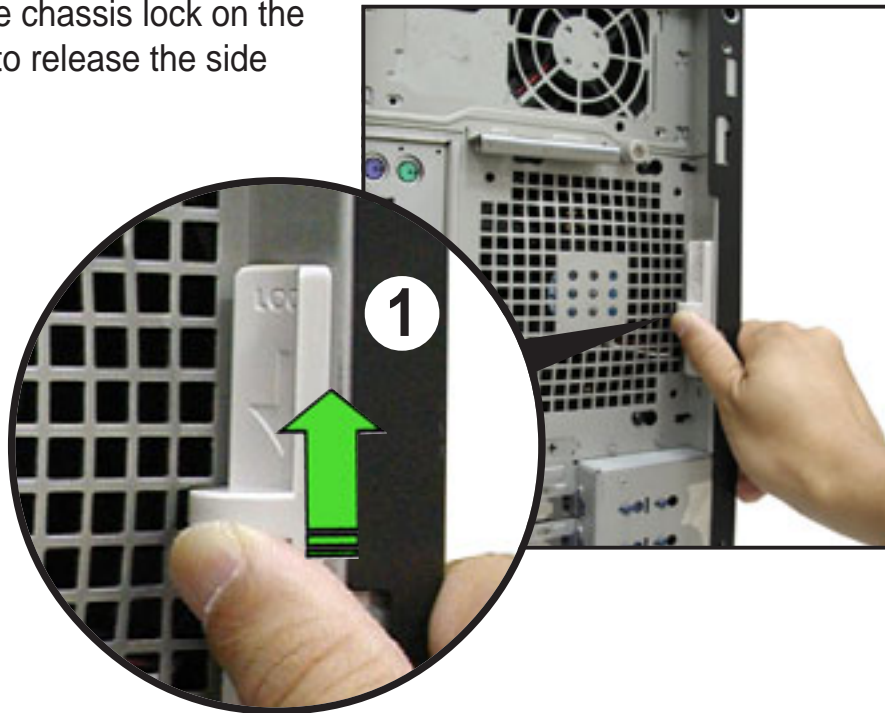

2. Slide the side cover for about half an inch toward the rear until it is disengaged from the chassis.

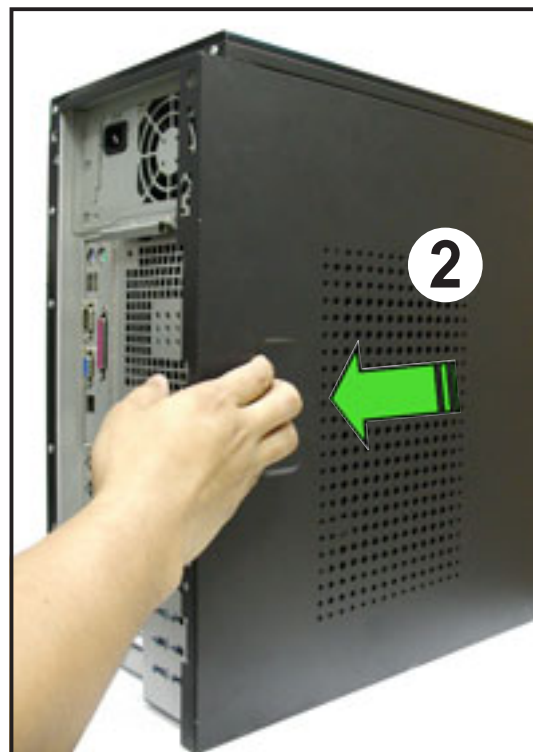

Viewing the internal structure

Without the side cover, the internal structure and installed components of the barebone server vary depending on the model you purchased. Refer to section “1.5 Internal features” for the different model configurations.

Perform the procedures in the succeeding sections to install the CPU, system memory, disk drives, and expansion cards; replace fans and power supply; and connect the system cables.



You may need to remove some of the installed components to access the DIMM sockets and internal connectors. Refer to section “2.10 Removable components” for instructions.

2.1.2 Re-installing the side cover

To re-install the side cover:

1. Match and insert the hooks of the cover to the elongated holes on the side of the chassis. All the six hooks (three each on the top and bottom) of the cover must properly fit the designated holes.
2. Slide the cover toward the front until it snaps in place.
3. Push down the chassis lock to secure the side cover.

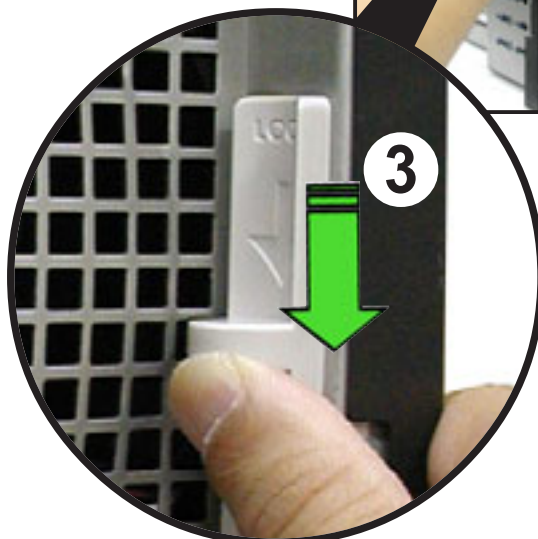
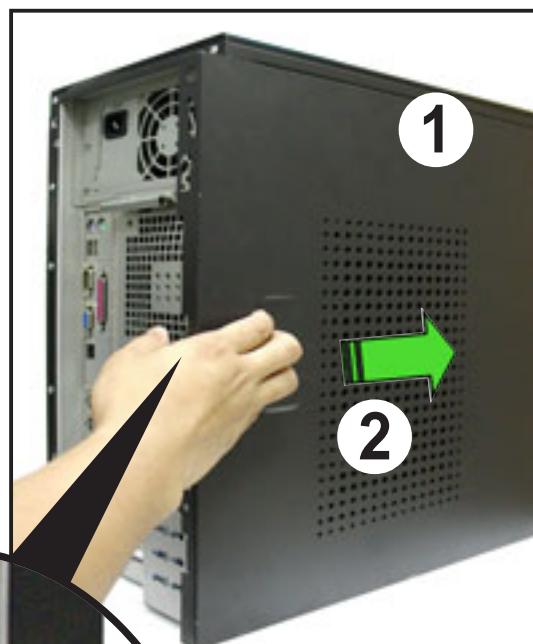

2.2 Motherboard information

The barebone server comes with the ASUS NCCH-DL motherboard already installed. The motherboard is secured to the chassis by ten (10) screws as indicated by circles in the illustration below.



Refer to “Chapter 4 Motherboard information” for detailed information on the motherboard.

This side towards
the rear of the chassis

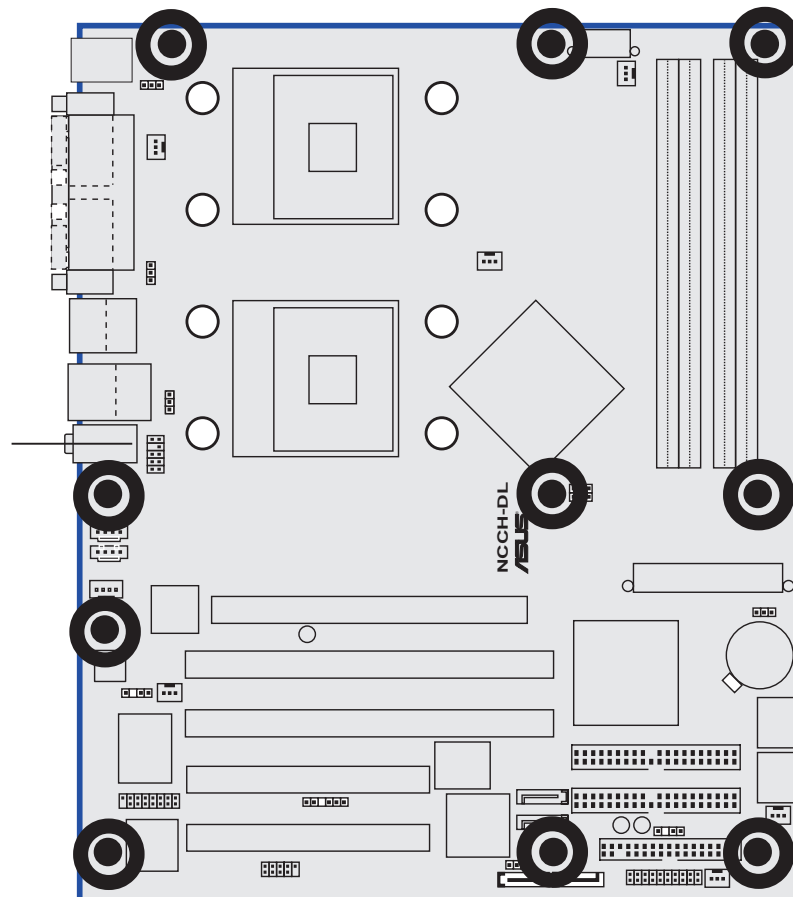

Make sure to unplug the power cord before installing or removing any motherboard component or connection. Failure to do so may cause you physical injury and may damage motherboard components.

2.3 Central Processing Unit (CPU)

2.3.1 Overview

The motherboard comes with dual surface mount 604-pin Zero Insertion Force (ZIF) sockets. The sockets are designed for the Intel® Xeon™ Processor in the 604-pin package.

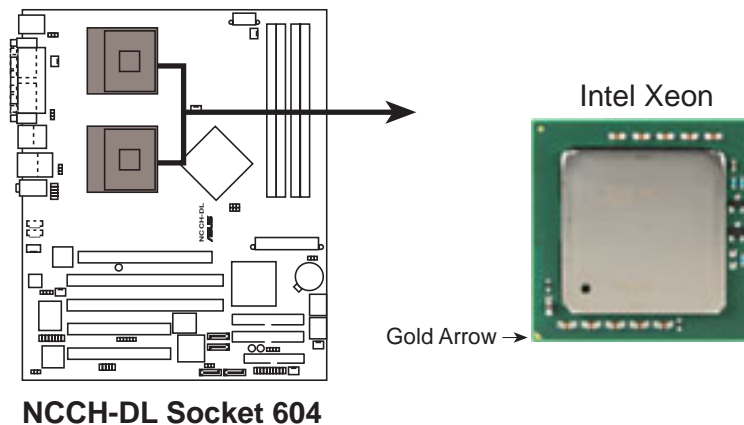

Before installing the CPU, remove the chassis fan attached to the inner side of the rear panel to allow enough space for the installation. Refer to section “2.10 Removable components” for details.

2.3.2 Installing the CPU

Note in the above illustration that the CPU has a gold triangular mark on one corner. This mark indicates the processor Pin 1 that should match a specific corner of the CPU socket.



If installing only one CPU, use the socket CPU1.

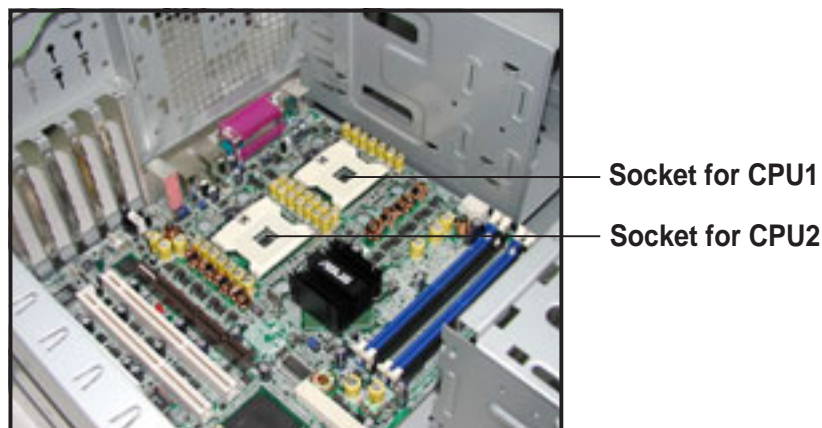



Incorrect installation of the CPU into the socket may bend the pins and severely damage the CPU!

Follow these steps to install a CPU.

1. Locate the 604-pin ZIF sockets on the motherboard. Flip up the socket lever and push it all the way to the other side.



Make sure that the socket lever is pushed back all the way, otherwise the CPU does not fit in completely.

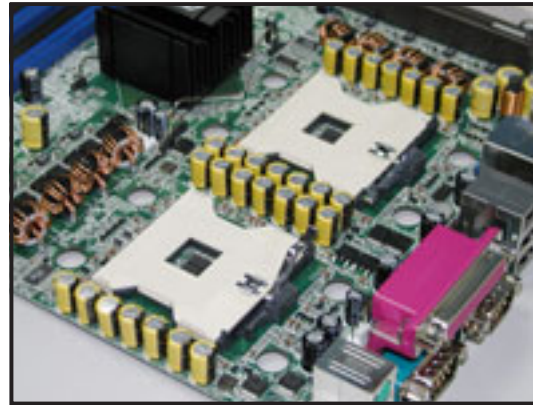

2. Position the CPU above the socket as shown.
3. Carefully insert the CPU into the socket until it fits in place.



The CPU fits only in one correct orientation. DO NOT force the CPU into the socket to prevent bending the pins and damaging the CPU!

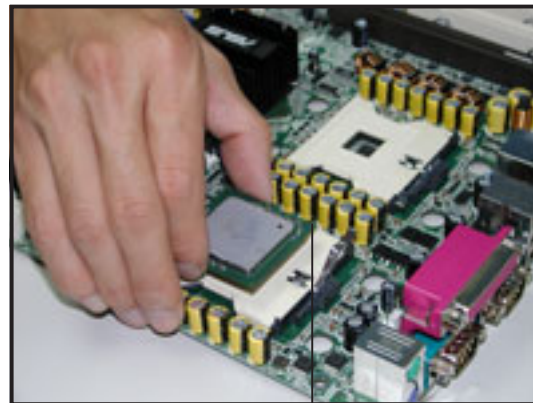

Marked corner
(gold arrow)

4. Carefully push down the socket lever to secure the CPU. The lever clicks on the side tab to indicate that it is locked.
5. Apply the thermal interface material (thermal grease) to the top of the CPU. This thermal grease should come with the CPU package.
6. Repeat steps 1 to 5 if you wish to install a second CPU.



2.3.3 Installing the CPU heatsink and fan

The Intel® Xeon™ processors require an Intel® certified heatsink and fan assembly to ensure optimum thermal condition and performance.

When you buy a boxed Intel® CPU, the package includes the heatsink, fan, retention brackets, screws, thermal grease, installation manual, and other items that are necessary for CPU and CPU heatsink and fan installation.

Important notes



- This system does not support Intel® Xeon™ FSB 533 box fan and heatsink assembly. When installing Intel® Xeon™ FSB 533 CPU(s), it is recommended that you use Nocona-compatible fan and heatsink assembly. Visit the ASUS website for details and a list of CPU fan and heatsink assembly qualified for use on this system.
- When installing Intel® Xeon™ FSB 800 boxed CPU(s), it is recommended that you use the fan and heatsink assembly (ies) included in the CPU package(s).
- Refer to the installation manual that came with the CPU package for details on fan and heatsink assembly installation.

CPU heatsink (top view)

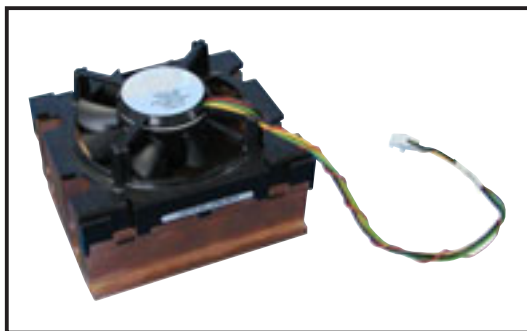

CPU heatsink (bottom view)

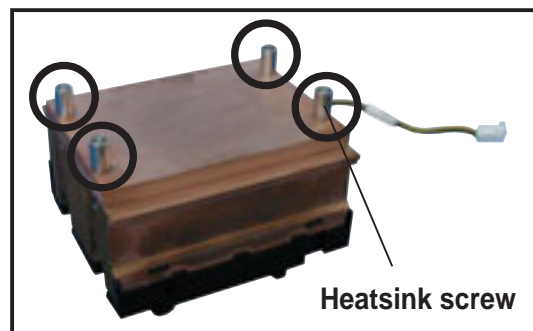

Before installing the CPU heatsinks:

- Make sure that you have applied the thermal grease on top of the CPU before installing the fan and heatsink assembly.
- Ensure that the jumpers FM_CPU1 and FM_CPU2 are set correctly depending on the pin definition of your CPU fan cables. Refer to the motherboard user guide for information.
- Remove the chassis fan to have more space for the CPU fan and heatsink assembly installation. Refer to section “2.10 Removable components” for details.

To install the CPU heatsink and fan:

1. Place the heatsink on top of the installed CPU, making sure that the four screws on the heatsink align with the screw holes on the CEK spring.

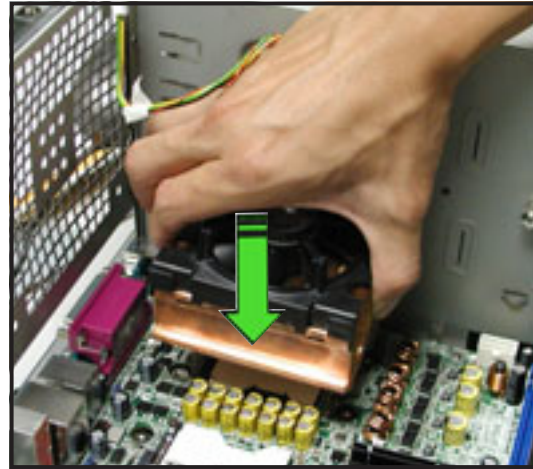

The CEK springs come pre-installed under the CPU sockets to support the weight of the CPU heatsinks. It is recommended that you keep the springs installed to prevent motherboard breakage.

2. Use a Phillips screwdriver to tighten the four heatsink screws in a diagonal sequence.

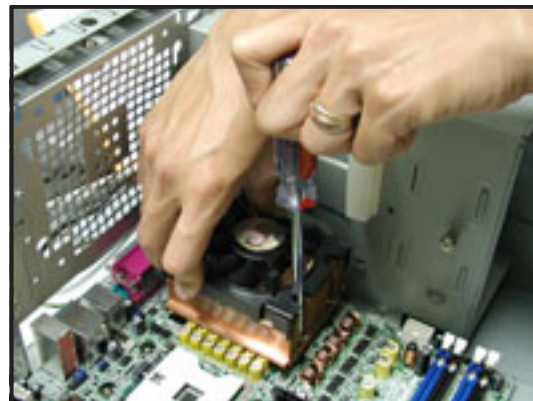
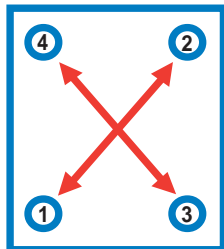

3. Connect the fan cable to the 4-pin connector labeled CPU_FAN1.

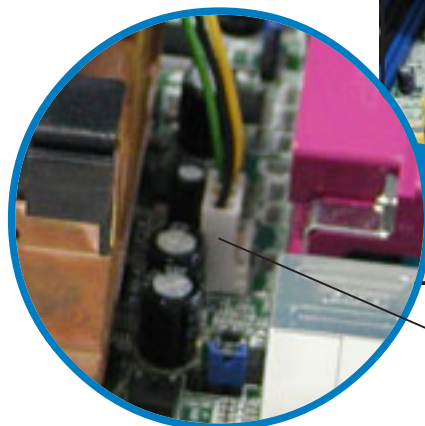

CPU1 fan connector (CPU_FAN1)

- Repeat steps 1 to 3 to install the other heatsink if you have installed a second CPU, then connect the fan cable to the 4-pin connector labeled CPU_FAN2. The heatsinks appear as shown when installed.

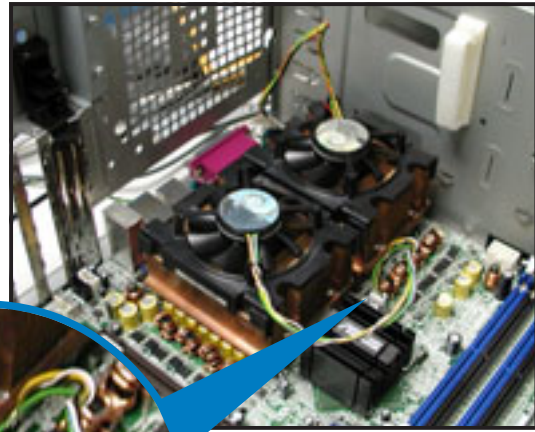

CPU2 fan connector (CPU_FAN2)

2.4 System memory

2.4.1 Overview

The motherboard comes with four Double Data Rate (DDR) Dual Inline Memory Module (DIMM) sockets.

The following figure illustrates the location of the DDR DIMM sockets.

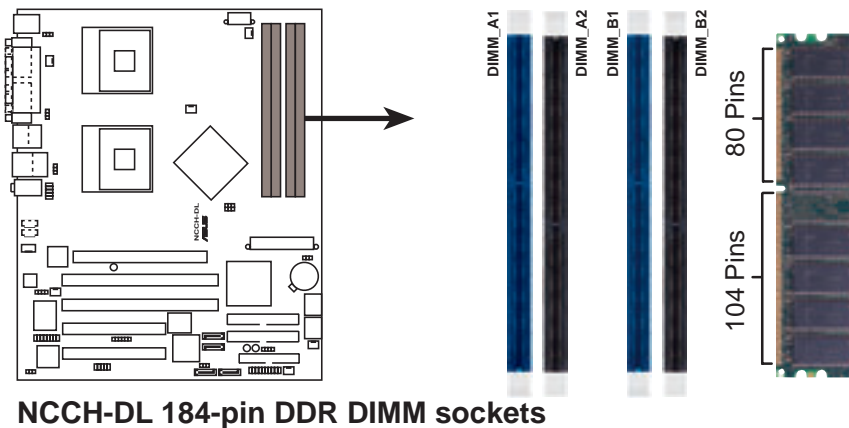

2.4.2 Memory configurations

You may install unbuffered ECC or non-ECC 64MB, 128MB, 256MB, 512MB, and 1GB DDR DIMMs into the DIMM sockets using the recommended memory configurations.

Important notes



1. Installing DDR DIMMs other than the recommended configurations may cause memory sizing error or system boot failure. Use any of the recommended configurations in Table 1.
2. In dual-channel configurations, install only **identical** (the same type and size) DDR DIMM pairs for each channel.
3. Always install DIMMs with the same CAS latency. For optimum compatibility, it is recommended that you obtain memory modules from the same vendor.
4. Make sure that the memory frequency matches the CPU FSB (Front Side Bus). Refer to Table 2.
5. DIMMs installed into **any three** sockets will function in single-channel mode.
6. When all four sockets are populated with 1GB DIMMs (total 4GB), the system may detect only about 3.6+ GB (less than 4 GB) due to resource allocation on onboard devices.

Table 1 Recommended memory configurations

Mode		Sockets			
		DIMM_A1 (blue)	DIMM_A2 (black)	DIMM_B1 (blue)	DIMM_B2 (black)
Single-channel	(1)	Populated	—	—	—
	(2)	—	Populated	—	—
	(3)	—	—	Populated	—
	(4)	—	—	—	Populated
Dual-channel	(1)	Populated	—	Populated	—
	(2)	—	Populated	—	Populated
	(3)*	Populated	Populated	Populated	Populated

* For dual-channel configuration (3), you may:

- install identical DIMMs in all four sockets, or
- install identical DIMM pair in DIMM_A1 and DIMM_B1 (blue sockets) and identical DIMM pair in DIMM_A2 and DIMM_B2 (black sockets)

Table 2 Memory frequency/CPU FSB synchronization

CPU FSB	DDR DIMM Type	Memory Frequency
800 MHz	PC3200	400 MHz
533 MHz	PC2700	333 MHz
400 MHz	PC2100	266 MHz



Obtain DDR DIMMs only from ASUS qualified vendors for better system performance. Visit the ASUS website (www.asus.com) for the latest QVL.

2.4.2 Installing a DIMM



Make sure to unplug the power supply before adding or removing DIMMs or other system components. Failure to do so may cause damage to both the motherboard and the components.

Follow these steps to install a DIMM.



To access the DIMM sockets, you may need to remove the HDD fan. Refer to section “2.10 Removable components” for instructions.

1. Unlock a DIMM socket by pressing the retaining clips outward.
2. Align a DIMM on the socket such that the notch on the DIMM matches the break on the socket.

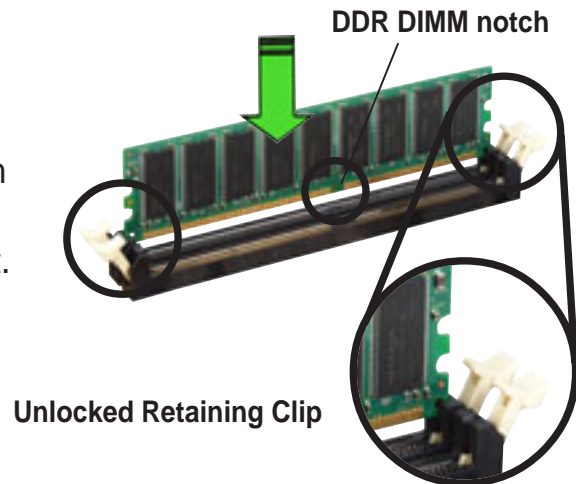

3. Firmly insert the DIMM into the socket until the retaining clips snap back in place and the DIMM is properly seated.

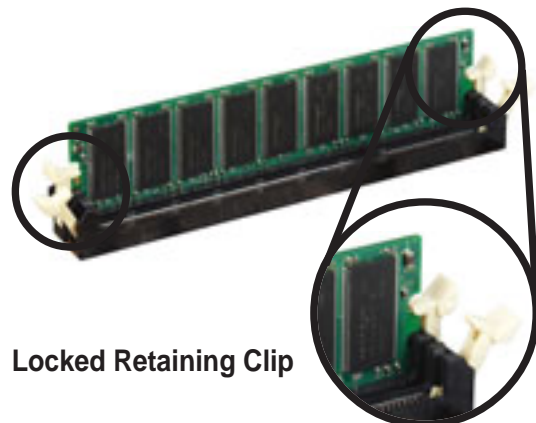

2.4.3 Removing a DIMM

Follow these steps to remove a DIMM.

1. While supporting the DIMM with your fingers, press the retaining clips outward simultaneously to release the DIMM from the socket.
2. Remove the DIMM from the socket.

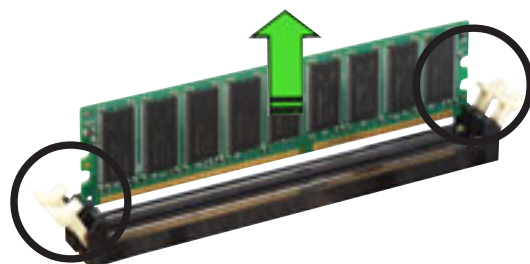

2.5 Front panel assembly

2.5.1 Removing the front panel assembly



Before you can install a 5.25-inch drive, you should first remove the front panel assembly (front bezel and front panel cover). The front panel assembly is attached to the chassis through four **hooked tabs** on the left side and four **hinge-like tabs** on the right side.

To remove the front panel assembly:

1. Pull the lock lever (blue bar) on the front edge of the chassis outward to release the front panel assembly.

Lock lever



2. Pull and swing the left edge of the front panel outward.



3. Unhook the hinge-like tabs from the holes on the right side of the front panel to completely detach the front panel assembly from the chassis.



Do not use too much force when removing the front panel assembly.

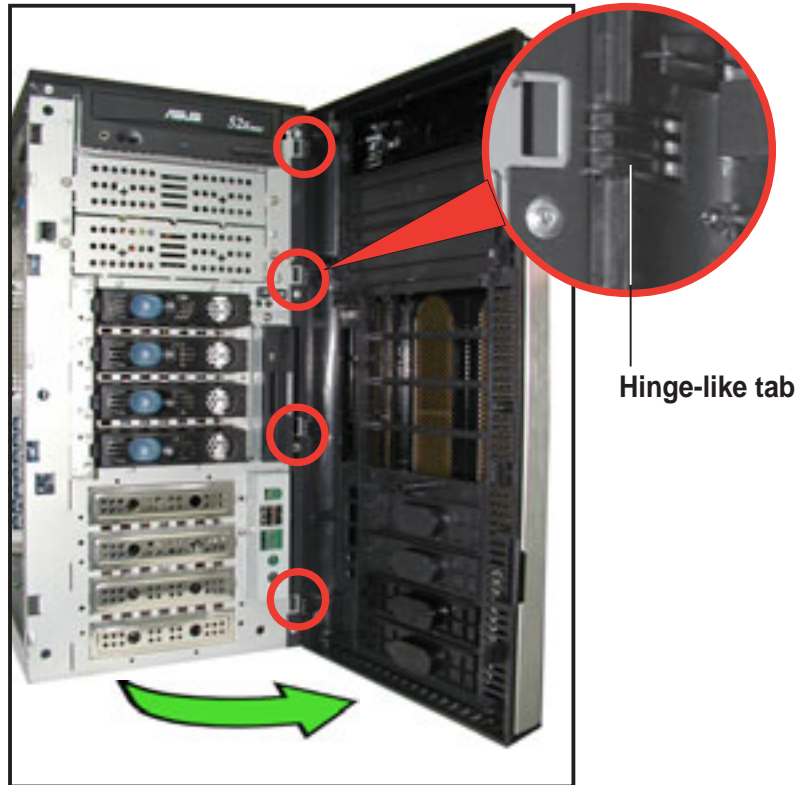

2.5.2 Re-installing the front panel assembly

To re-install the front panel assembly (front bezel and front panel cover):

1. Insert the four hinge-like tabs to the holes on the right edge of the chassis.
2. Swing the front panel to the left and fit the four (4) hooked tabs to the left side of the chassis until the tabs snap back in place.

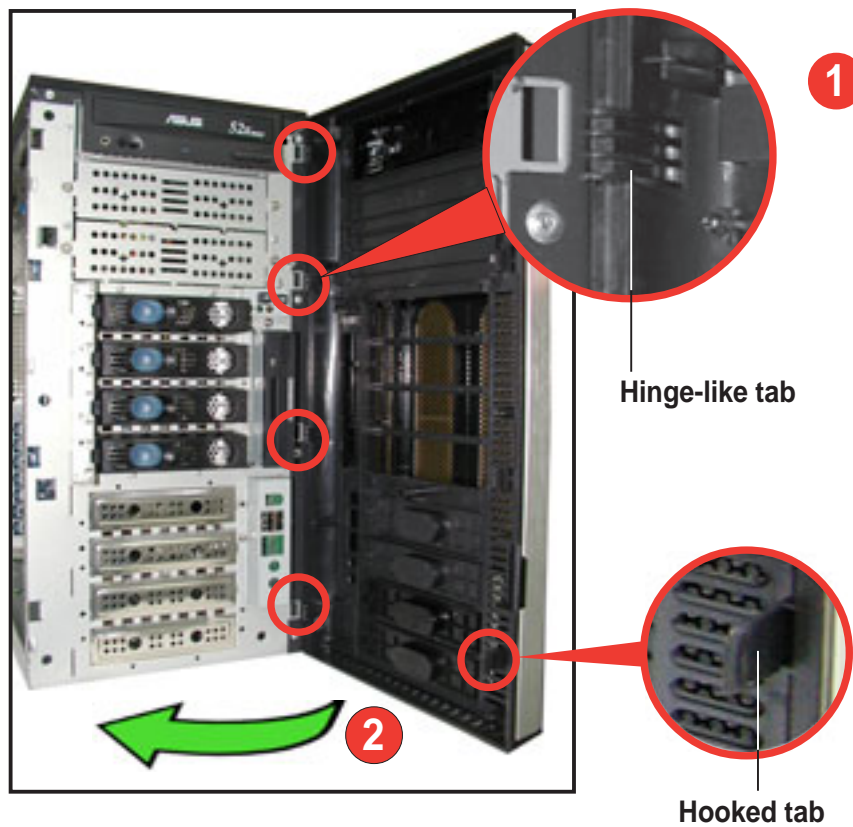

2.6 5.25-inch drives



If you have previously used and powered up the system, and that it may be connected to an AC power source, make sure to unplug the power cable before installing or removing any system components. Failure to do so may cause damage to the motherboard and other system components!

Three 5.25-inch drive bays are located on the upper front part of the chassis. A CD-ROM drive that comes standard with the system package occupies the uppermost bay (*labeled 1*). The two lower bays (*labeled 2 and 3*) are available for additional 5.25-inch devices.

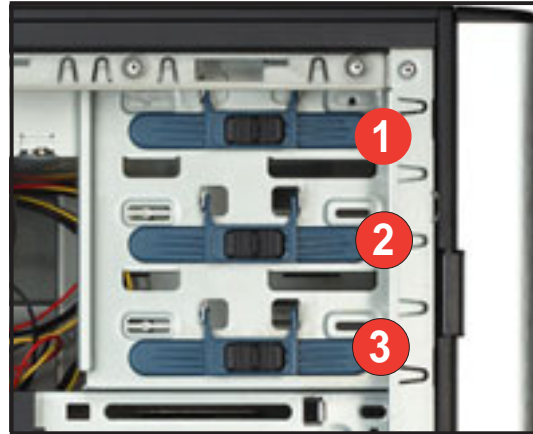

To install a 5.25-inch drive:

1. Use a Phillips (cross) screwdriver to remove the screws that secure the metal cover of the bay where you wish to install the drive.

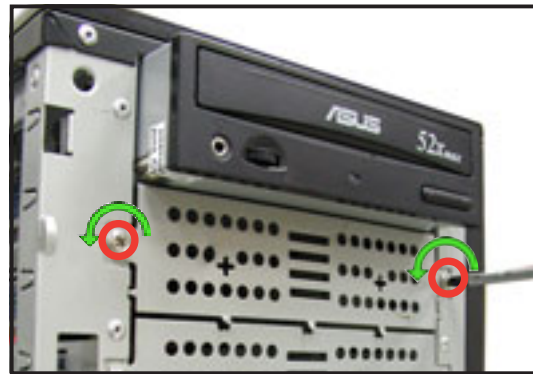

2. From the side of the drive bay, slide the drive bay lock by pushing it to the left to release the drive lock bar.

Drive lock bar

Drive bay lock

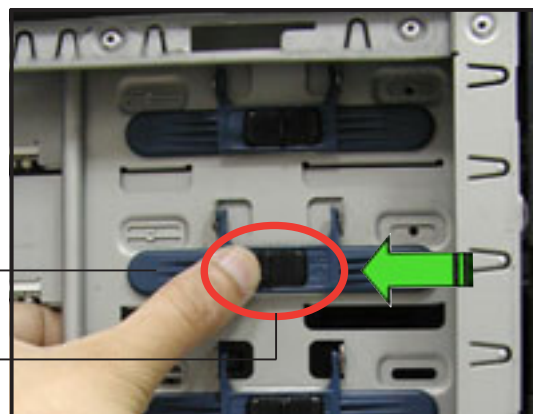

- When released, pull up the drive bay lock bar. Underneath the lock bar are two pegs that match the holes on the drive bay. This mechanism secures the drive to the bay in place of screws.

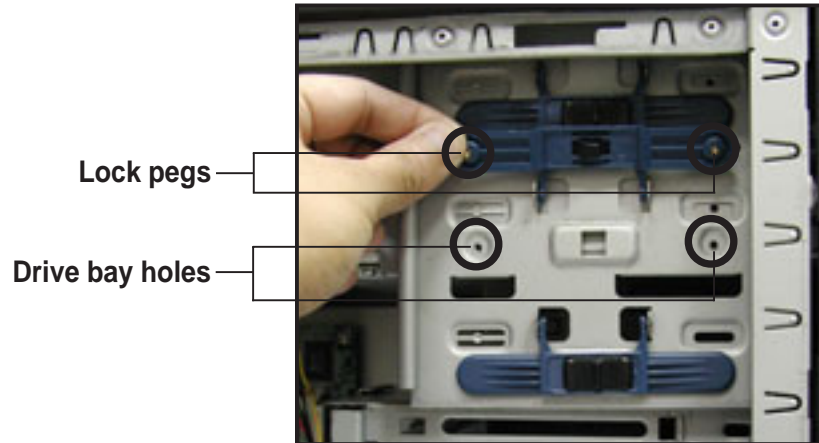

- While holding up the drive lock bar, carefully insert a 5.25-inch drive into the bay, until the back of the drive aligns to the rear edge of the drive cage.



Due to space constraints inside the chassis, do not insert the drive all the way at this time. This will allow you enough space to easily connect the drive cables.

- Connect the IDE cable to the IDE connector on the back of the drive.
- Connect a 4-pin plug from the power supply to the power connector on the back of the drive.

IDE cable



Power plug

7. Make sure that the drive and bay holes align as shown. When in place, the drive protrudes about an inch from the front panel.



8. Pull down the bar lock and insert the lock pegs to the drive/bay holes, then push the drive lock to the right to secure the drive.

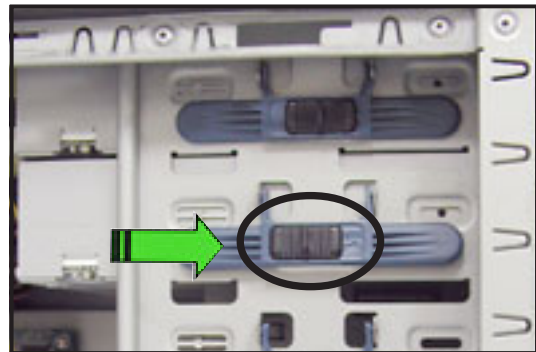

9. On the front panel assembly, detach the plastic bay cover opposite the 5.25-inch drive that you installed by pressing the two hooked tabs on each side of the bay cover.

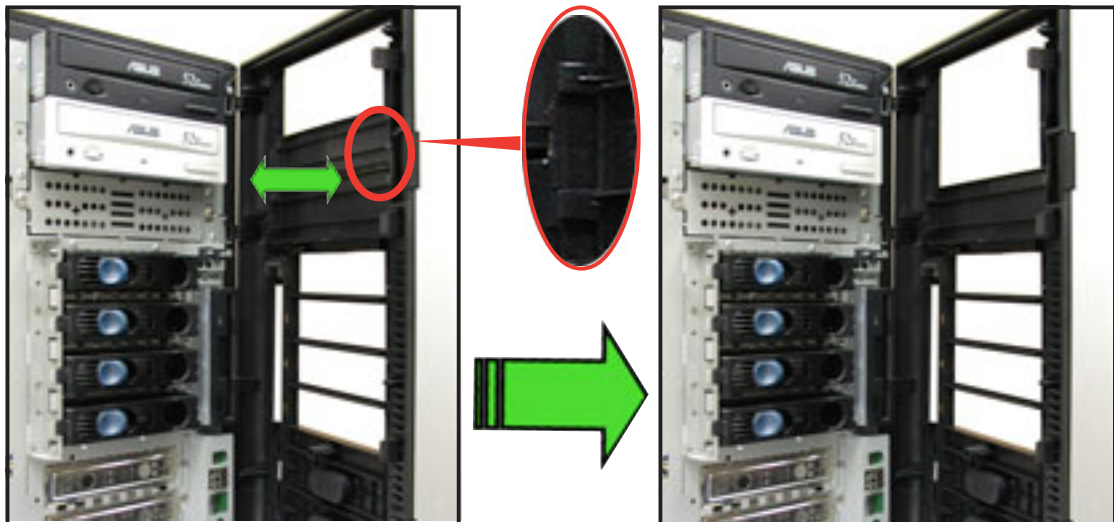

10. Re-install the front panel assembly when done. Refer to section “2.5.2 Re-installing the front panel assembly” for instructions.

2.7 Hard disk drives

2.7.1 Installing a hot-swap SATA/SCSI hard disk drive

If you purchased an AS8, AS4, or AA4 configured model, follow these instructions to install a hot-swap SATA or SCSI hard disk drive (HDD).

1. Open the front bezel to access the hot-swap drive trays.
2. Release a drive tray by pushing the spring lock to the right, then pulling the tray lever outward. The drive tray ejects slightly after you pull out the lever.



3. Firmly hold the tray lever and pull the drive tray out of the bay.

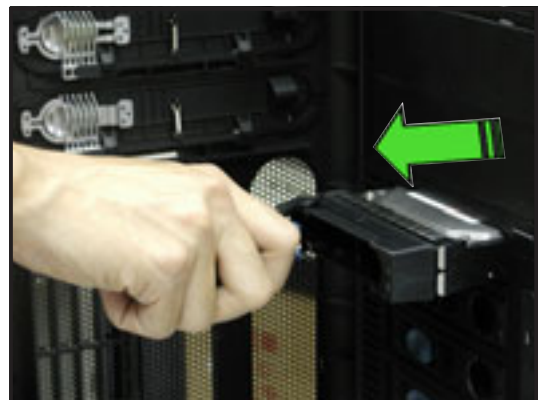

4. An empty drive tray requires a metal bracket for support. Use a Phillips (cross) screwdriver to remove the bracket when you are ready to install a hard disk in the drive tray.

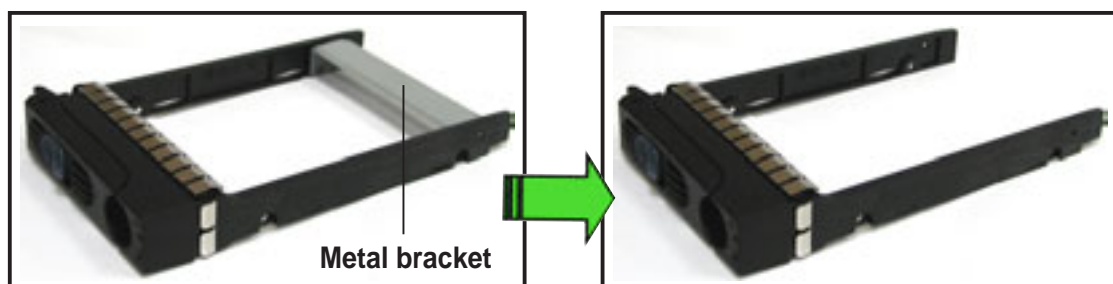

5. Place a SATA or an SCA SCSI hard disk to the drive tray, and secure it with four screws.



6. Carefully insert drive tray and push it all the way to the depth of the bay until just a small fraction of the tray edge protrudes.



7. Push the tray lever until it clicks, and secures the drive tray in place. The drive tray is correctly placed when its front edge aligns with the bay edge.



2.7.2 Installing an internal IDE/SATA HDD

If you purchased an internal IDE/SATA model (AI4), your package comes with specially designed hard disk drive rails. Depending on which bay you wish to install your hard disk drive, the orientation of the drive rails vary so that the screw holes match those on the drive.

For identification purposes, the drive rails are referred to as “Rail 1” and “Rail 2” as shown below.

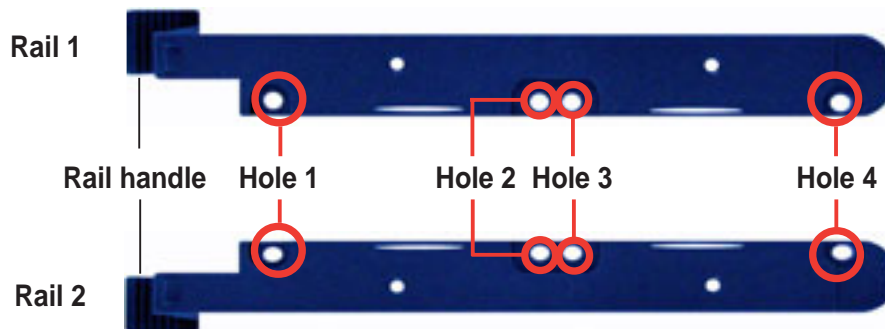

Take note of the correct orientation of the drive rails. There is only one **correct** way to attach the rails when installing drives on the hard disk drive cage.

Installing an IDE hard disk drive to the first hard disk drive cage

To install an IDE hard disk drive to the first hard disk drive cage:

1. Remove the front panel assembly. Refer to section 2.5.1 for instructions.
2. Use a Phillips (cross) screwdriver to attach **Rail 1** to the side of the drive as shown. The rail end should be on the side of the drive connectors.

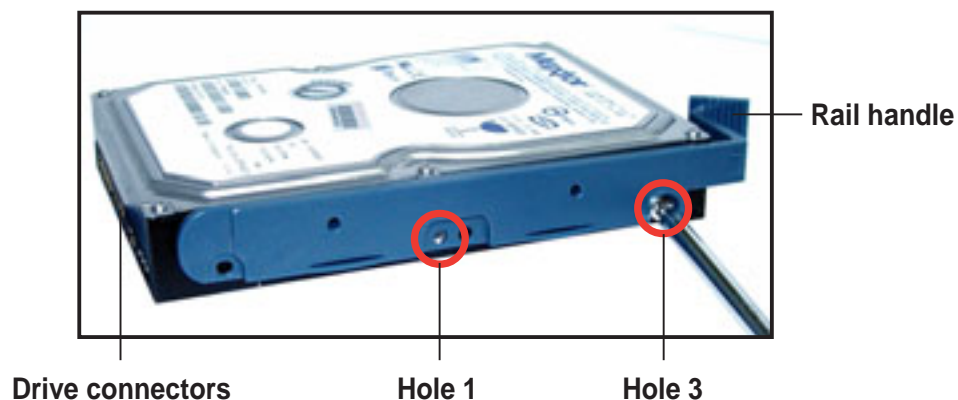

3. Attach **Rail 2** to the other side of the drive as shown. The rail end should be on the side of the drive connectors.

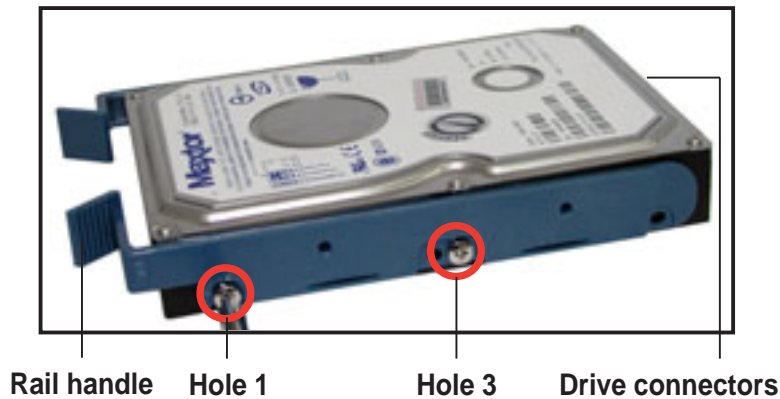

4. Check the HDD jumper setting. Refer to the label pasted on the HDD for the description of jumper settings. The setting "Cable Select" is recommended.
5. Carefully insert the drive into a bay on the front panel.



6. Push the drive all the way to the depth of the bay until the rail locks clicks, indicating that the drive is securely in place.



7. Connect the IDE and power cables to their corresponding connectors on the back of the drive.
8. Follow steps 2 to 6 if you wish to install other hard disk drives.
9. Re-install the front panel assembly when done.



Installing a Serial ATA HDD to the first hard disk drive cage

To install a Serial ATA hard disk drive to the first hard disk drive cage:

1. Follow instructions 1 to 6 of the previous section.
2. Connect the 15-pin SATA power plug to the power connector at the back of the drive.



3. Connect the other end of the SATA power cable to a 4-pin plug (female) from the power supply unit.

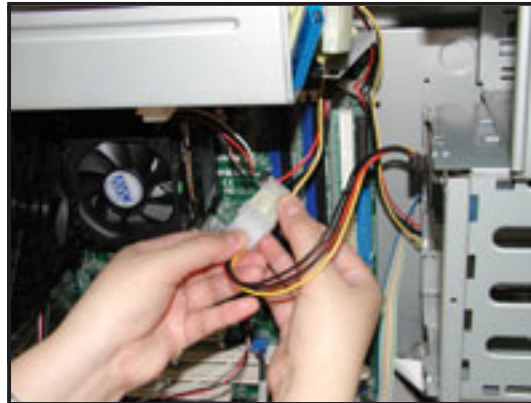

4. Connect one end of the supplied 7-pin SATA cable to the SATA connector at the back of the drive, then connect the other end to a SATA connector on the motherboard. Refer to the motherboard user guide for the location of the SATA connectors.



Installing an IDE/SATA HDD to the internal HDD cage

Follow these instructions to install an IDE or Serial ATA hard disk drive to the optional internal hard disk drive cage (non-swap).

1. Install the internal HDD cage following the instructions on Chapter 3 “Installation options”.
2. Follow steps 1 of 4 of the section “Installing an IDE hard disk drive to the first hard disk drive cage”.
3. Carefully insert the drive into a bay on the second drive cage as shown.



4. Connect the signal and power cables to their corresponding connectors on the back of the drive. Refer to the preceding sections for details.
5. Follow steps 2 to 4 if you wish to install additional hard disk drives.
6. Re-install the side cover when done. Refer to section “2.1.2 Installing the side cover.”

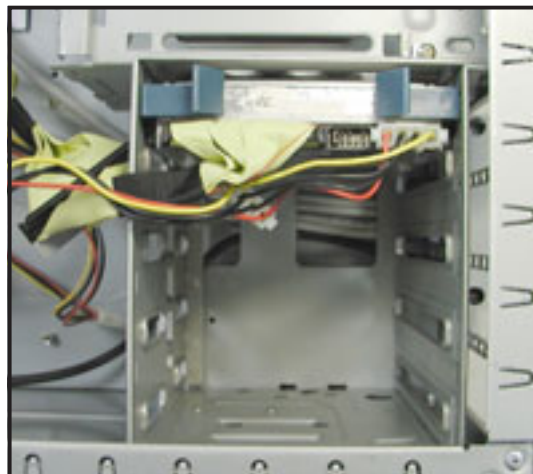

Installing an HDD dummy cover

The HDD dummy covers come pre-installed on the front panel bezel. In case you removed the covers, follow these steps to re-install them.

To install an HDD dummy cover:

1. From the inside of the front panel assembly, insert the flat end of a dummy cover into the slot as shown. The end with the hook tab should be close to the front panel LEDs.

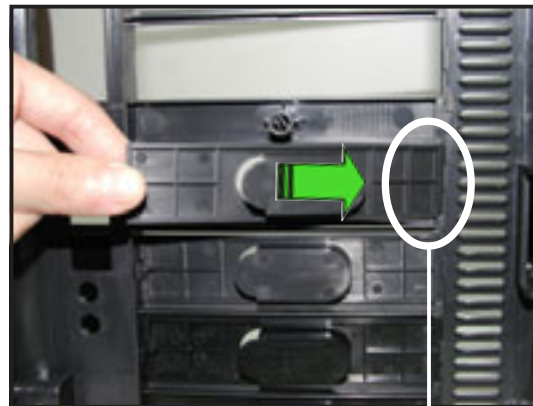

Flat end

2. Press the dummy cover into the slot opening until the hook tab clicks in place.

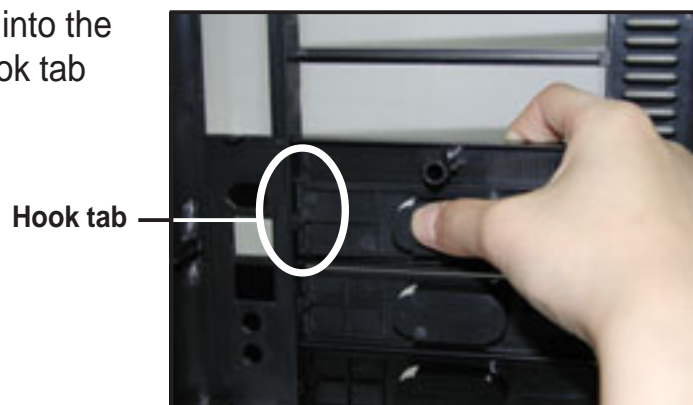

3. When installed, the dummy cover appears as shown.



2.8 Expansion cards

The chassis is designed with a screwless expansion slot frame on the rear panel. This design feature allows you to install or remove an expansion card in less steps.



Make sure to unplug the power cord before installing or removing expansion cards. Failure to do so may cause physical injury, and damage to the card and motherboard components!

2.8.1 Installing a standard size expansion card

To install a standard size expansion card:

1. Remove the plastic card lock opposite the slot where you wish to install the expansion card. Release the card lock by pressing the center tabs and pushing outward. Set the card lock aside for later use.

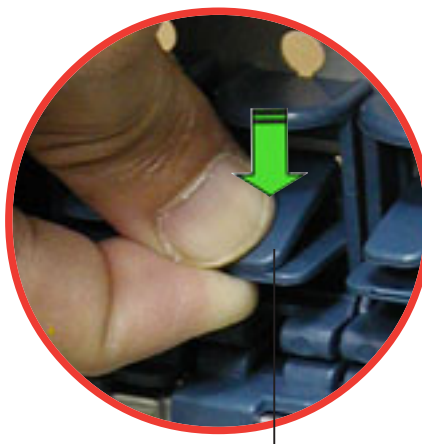

Card lock tab

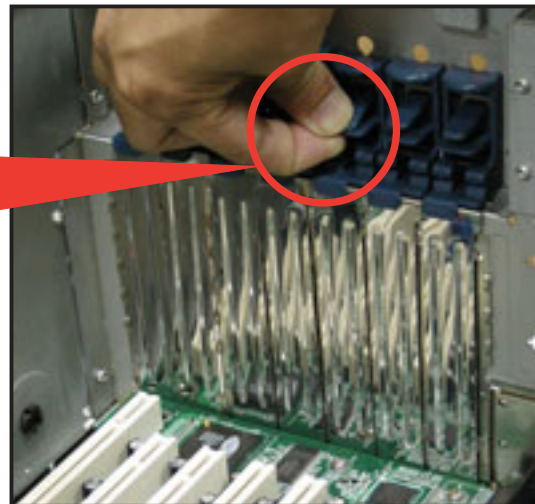

2. Carefully install an expansion card making sure that it is properly seated on the slot.

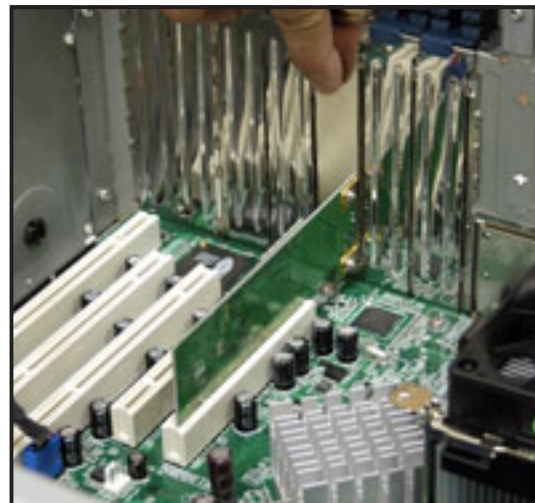

3. When the card is in place, secure it with the plastic card lock that you removed earlier.

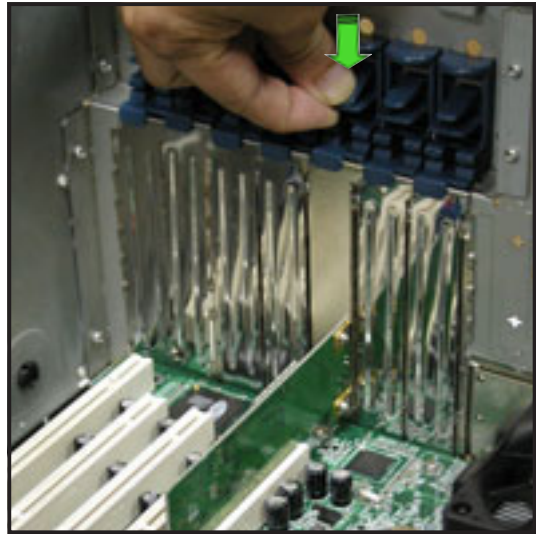
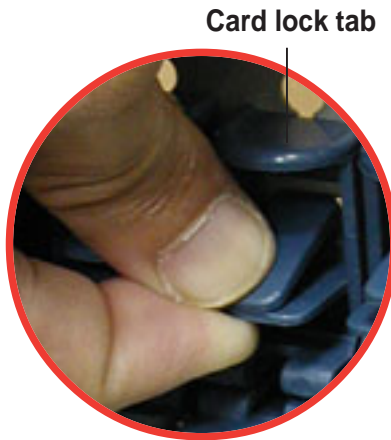

2.8.2 Installing a long expansion card

If you wish to install a long expansion card, such as some types of RAID cards, you need to remove the lower hot swap drive cage (for AS8 models or separately purchased second hot-swap HDD cage) and install an internal (non-hot swap) drive cage with long card guides that keep the expansion cards firmly seated on the slots.



1. The internal drive cage is optional and separately purchased. See section “Chapter 3: Installation options” for instructions on installing the drive cage.
2. The **AS4**, **AA4**, and **AI4** models support long expansion cards.

To install a long expansion card:

1. Remove the plastic card lock opposite the slot where you wish to install the expansion card. Release the card lock by pressing the center tabs and pushing outward. Set the card lock aside for later use.

2. Tilt the long card as shown while aligning the metal bracket with the slot opening on the rear panel.

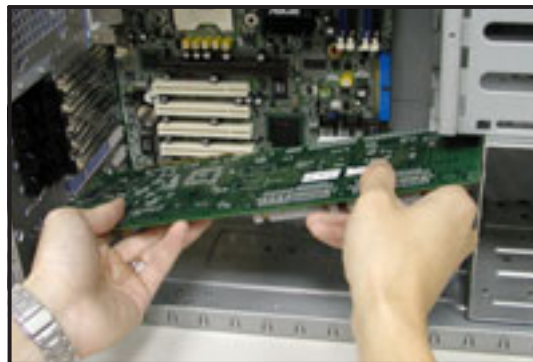

3. When the card is inside the chassis, push down the end of the card until it is level with the PCI slot.



4. Push the card connector into the PCI slot until it is securely seated.
5. When the card is in place, secure it with the plastic card lock that you removed earlier.



2.8.3 Removing an expansion card

To remove an expansion card:

1. Remove the plastic card lock that secures the expansion card.

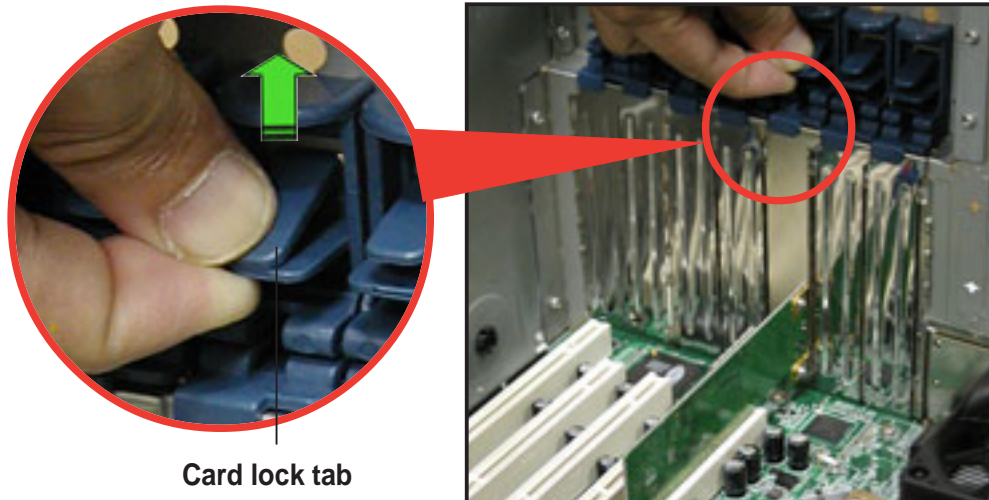

2. Firmly hold the expansion card and pull it out of the slot.
3. Place the plastic card lock back where you removed it.

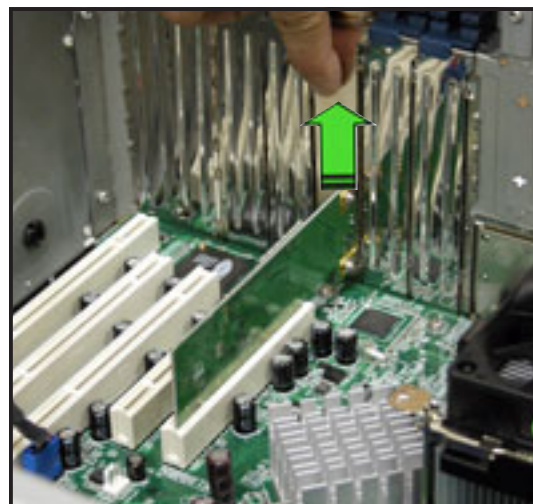

2.9 Cable connections



- The bundled system cables are pre-connected before shipment. You do not need to disconnect these cables unless you will remove pre-installed components to install additional devices.
- Refer to this section when reconnecting cables to ensure correct cable connections.

2.9.1 Motherboard connections

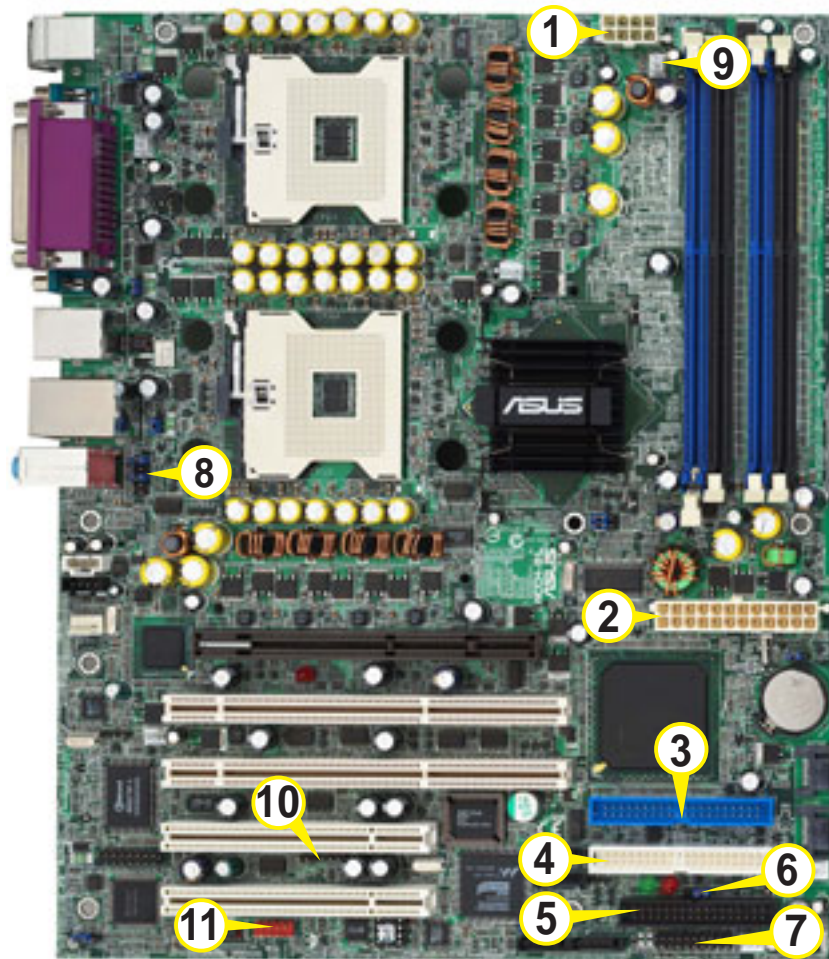

Standard cables connected to the motherboard

- | | |
|----------------------------------|--------------------------------|
| 1. 8-pin 12V power | 7. Front panel cable |
| 2. 24-pin ATX power | 8. Front panel audio |
| 3. Primary IDE cable | 9. Chassis fan cable |
| 4. Secondary IDE (optical drive) | 10. SMBus cable to backplane |
| 5. Floppy disk drive | 11. Front panel IEEE 1394 port |
| 6. Chassis intrusion | |



Refer to the motherboard user guide for detailed information on the connectors.

2.9.2 SATA backplane connections (in AA4 models only)

A SATA backplane comes pre-installed in the AP1720-E2 AA4 model. The SATA backplane has four 15-pin SATA connectors to support Serial ATA hard disk drives. The backplane design incorporates a hot swap feature to allow easy connection or removal of SATA hard disks. The LED on the backplane connect to the front panel LED to indicate HDD status. See section “1.6 LED information” for details.

Front side

The front side of the SATA backplane faces the front panel when installed. This side includes four SATA connectors for the hot swap drive trays.

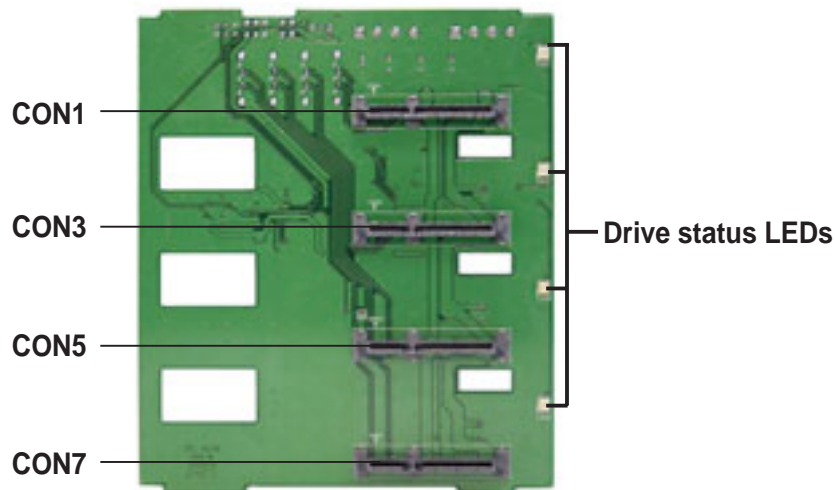

Each SATA connector is labeled (CON1, CON3, CON5, CON7) so you can easily determine their counterpart connectors at the back side of the backplane. Refer to the table below for reference.

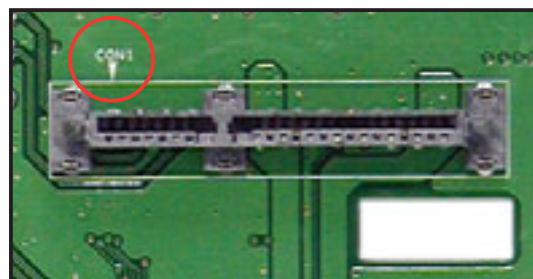

HDD Device	Front side connector	Back side connector
HDD 1	CON1	CON2
HDD 2	CON3	CON4
HDD 3	CON5	CON6
HDD 4	CON7	CON8

Back side

The back side of SATA backplane faces the rear panel when installed. This side includes the power connectors, SATA interfaces for the SATA RAID card, and SMBus connectors.

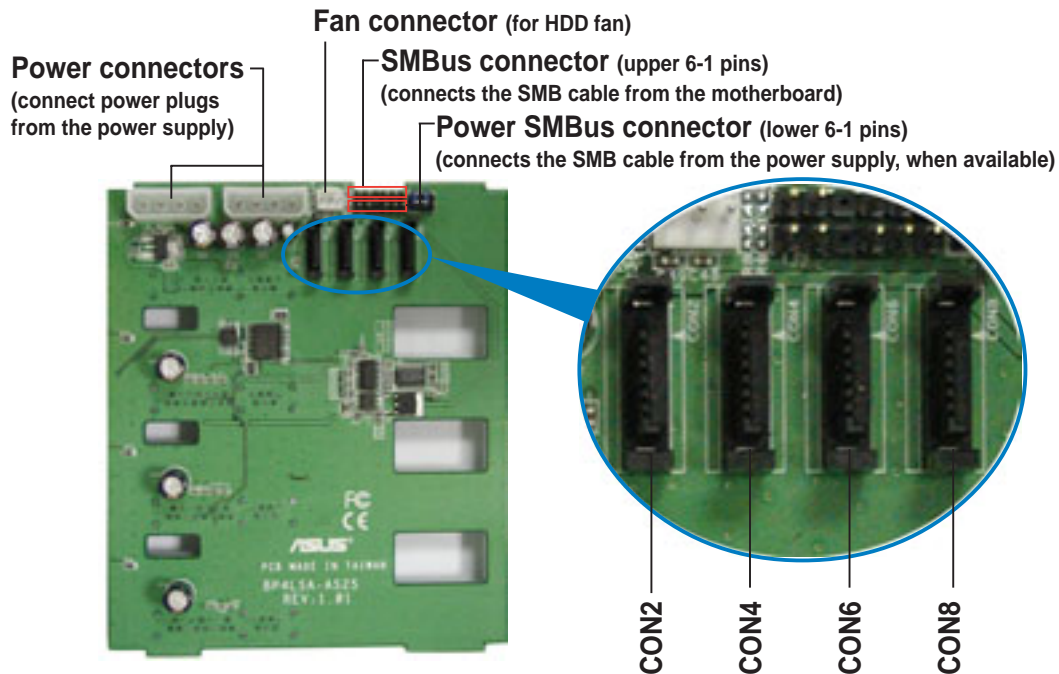

The back side SATA connectors are attached to the motherboard SATA connectors via the supplied SATA cables. Refer to the illustration on the right for the location of the SATA connectors. Refer to the table below for the default SATA cable connections.

Backplane ID	Connected to (on motherboard)	Controlled by
CON2	SATA_RAID1	Promise® 20319
CON4	SATA_RAID2	Promise® 20319
CON6	SATA_RAID3	Promise® 20319
CON8	SATA_RAID4	Promise® 20319

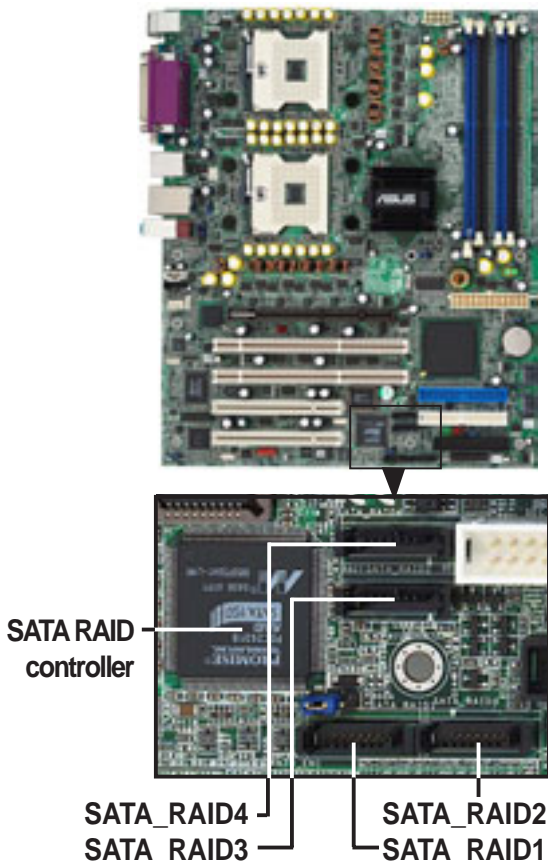

SATA backplane jumper settings and HDD ID assignments

The 6-pin jumper **J1** allows you to define your desired SATA configuration. The picture below shows the location of jumper J1 with pins 1-3 and 2-4 shorted.

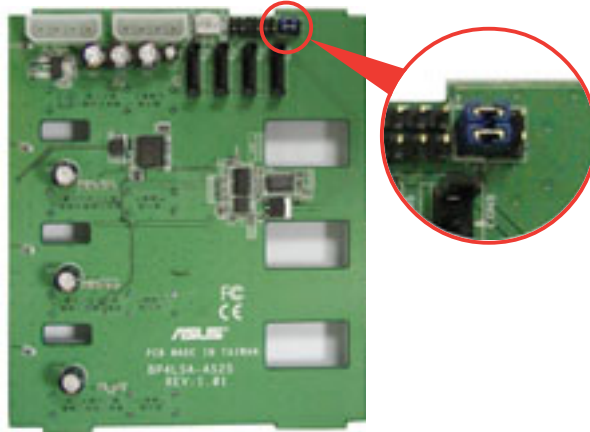

Refer to the table for the jumper settings and the appropriate ID# for each SATA HDD bay.

J1 setting <i>(1-3 shorted, 2-4 shorted)</i>		
Device	SATA BP ID	
Drive Bay 1	CON2	
Drive Bay 2	CON4	
Drive Bay 3	CON6	
Drive Bay 4	CON8	

2.9.3 SCSI backplane connections (in AS8 and AS4 models only)

Two SCSI backplanes come pre-installed in the AP1720-E2 AS8 model. One SCSI backplane comes pre-installed in the AS4 model. The SCSI backplane has four 68-pin SCSI connectors to support SCA SCSI hard disks. The backplane design incorporates a hot swap feature to allow easy connection or removal of SCSI hard disks. The LEDs on the backplane connect to the front panel LEDs to indicate HDD access, HDD failure, thermal failure, or fan failure. See section “1.6 LED information.”

Front side

The front side of the SCSI backplane faces the front panel when installed. This side includes four SCSI connectors for the hot swap drive trays.

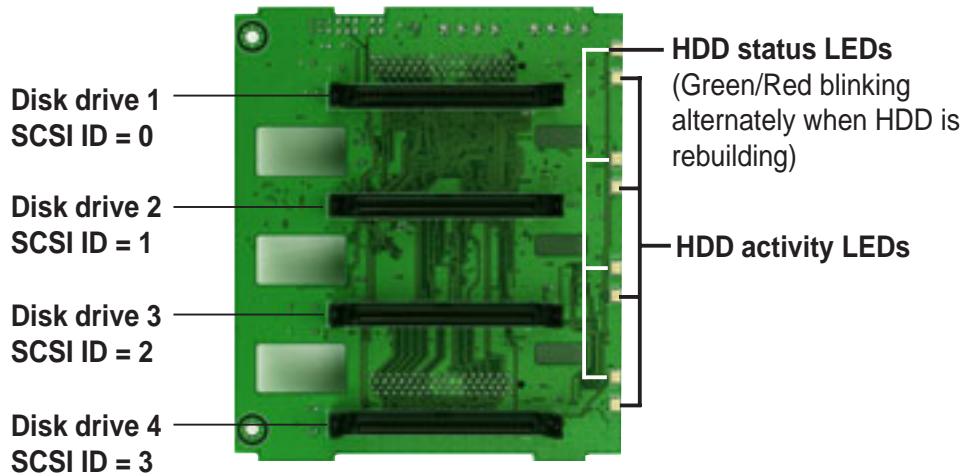

Back side

The back side of SCSI backplane faces the rear panel when installed. This side includes the power connectors, SCSI interfaces for the SCSI/RAID card and terminator, and SMBus connectors.

The picture shows a two-backplane configuration in a cascade connection.

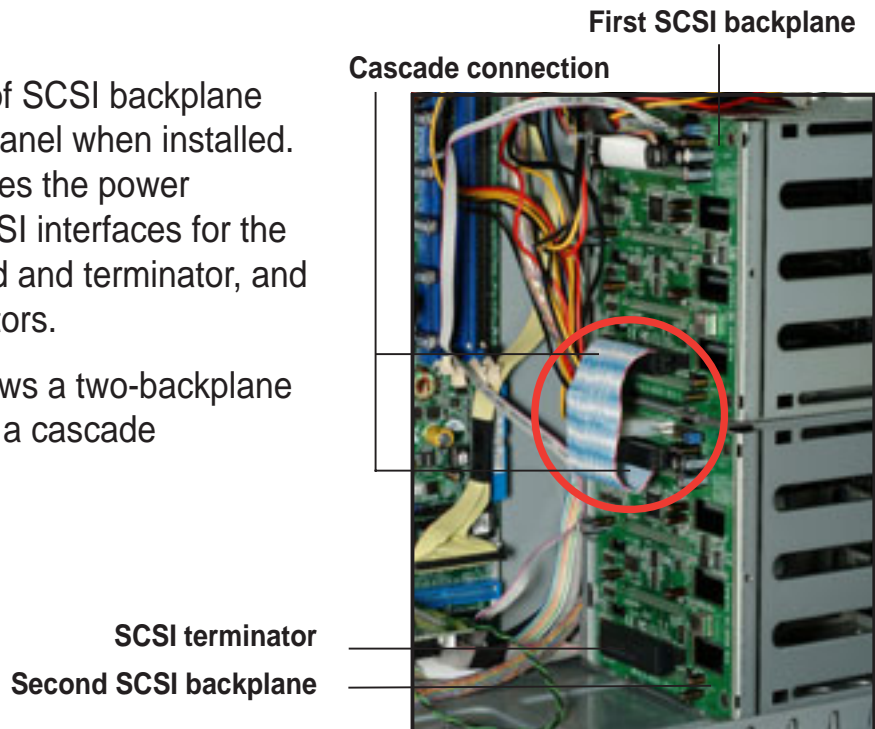

One-backplane configuration

In a **one-backplane** configuration:

- the upper SCSI interface of the backplane connects to the SCSI/RAID card
- a SCSI multi-mode terminator (LVD/SE) is connected to the lower SCSI interface of the backplane

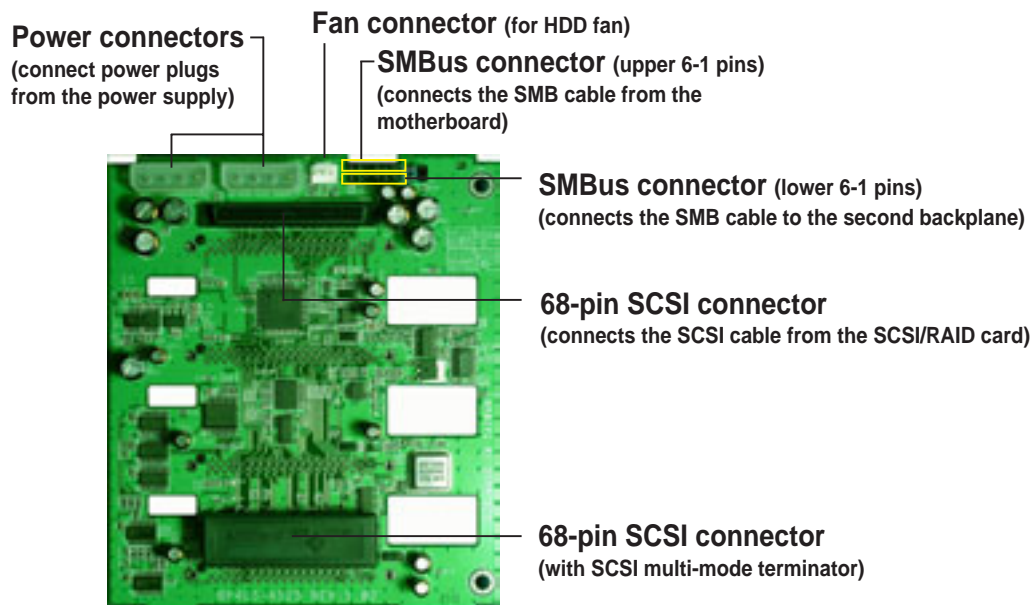

Two-backplane configuration

In a **two-backplane** configuration:

- the upper SCSI interface of the first backplane connects to the SCSI card
- the lower SCSI interface connects to the upper SCSI interface of the second backplane
- a SCSI multi-mode terminator (LVD/SE) is placed on the lower SCSI interface of the second backplane

First backplane

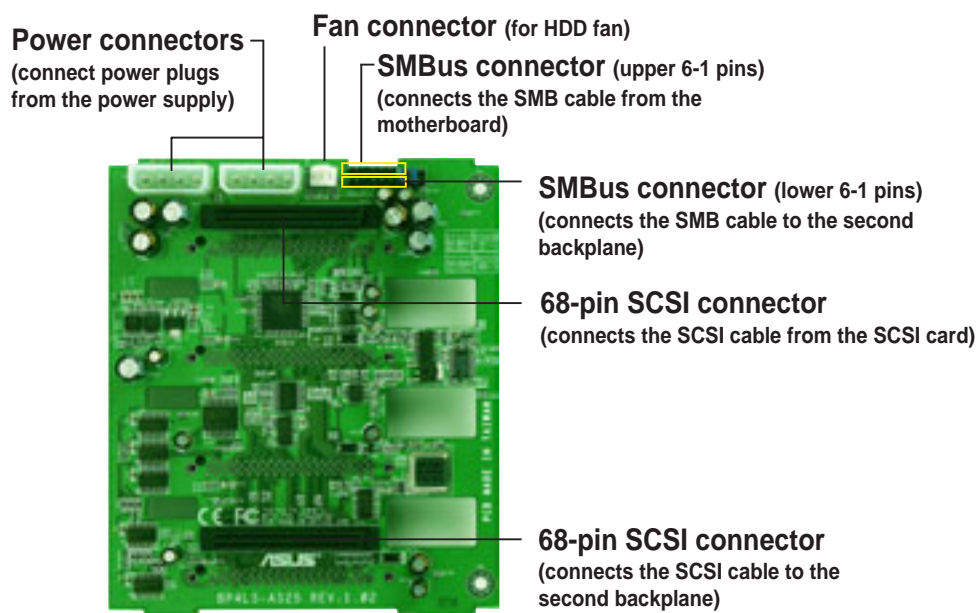

Second backplane

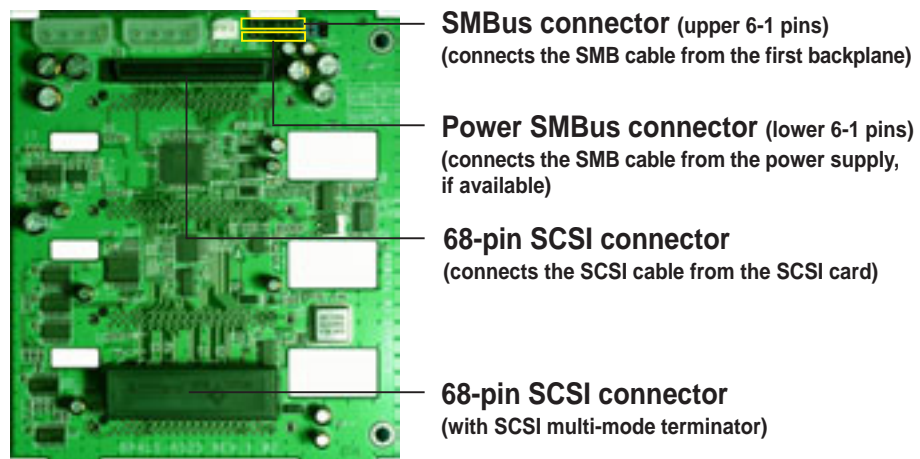

SCSI backplane jumper settings and HDD ID assignments

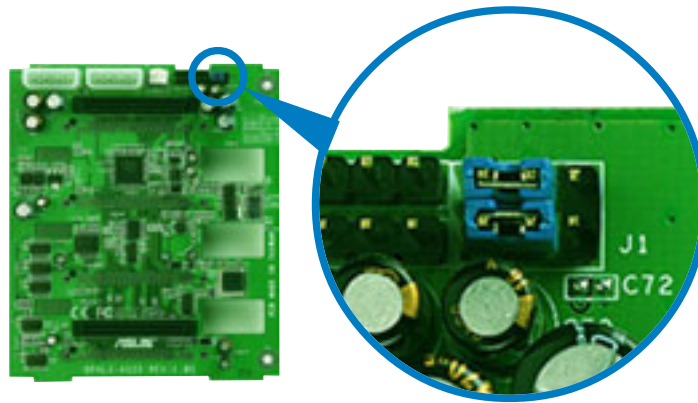

The 6-pin jumper **J1** on each of the SCSI backplanes allows you to define your desired SCSI configuration.

The picture below shows the location of jumper J1 with pins 1-3 and 2-4 shorted.



Refer to the following tables for the jumper settings and the appropriate ID# for each SCSI HDD bay.

Cascade configuration	
First backplane (BPB1)	
J1 setting (<i>1-3 shorted, 2-4 shorted</i>)	
Device	SCSI ID#
Drive Bay 1	ID0
Drive Bay 2	ID1
Drive Bay 3	ID2
Drive Bay 4	ID3
GEM SAF-TE	ID15
Second backplane (BPB2)	
J1 setting (<i>3-5 shorted, 4-6 shorted</i>)	
Device	SCSI ID#
Drive Bay 5	ID4
Drive Bay 6	ID5
Drive Bay 7	ID6
Drive Bay 8	ID8
GEM 318 SAF-TE	ID11

Non-Cascade configuration	
First backplane (BPB1)	
J1 setting (1-3 shorted, 2-4 shorted) 	
Device	SCSI ID#
Drive Bay 1	ID0
Drive Bay 2	ID1
Drive Bay 3	ID2
Drive Bay 4	ID3
GEM 318 SAF-TE	ID15 (SCSI channel-0)
Second backplane (BPB2)	
J1 setting (1-3 shorted, 2-4 shorted) 	
Device	SCSI ID#
Drive Bay 5	ID0
Drive Bay 6	ID1
Drive Bay 7	ID2
Drive Bay 8	ID3
GEM 318 SAF-TE	ID15 (SCSI channel-1)



In a non-cascade configuration, you must install a SCSI multi-mode terminator on both backplanes.

2.10 Removable components

You may need to remove previously installed system components when installing or removing system devices, or when you need to replace defective components. This section tells how to remove the following components:

1. Chassis fan
2. HDD fans
3. SATA/SCSI backplanes
4. Floppy disk drive module
5. Front I/O board
6. Chassis footpads and roller wheels
7. Power supply modules

2.10.1 Chassis fan

To remove the chassis fan:

1. Disconnect the 3-pin fan cable from the connector SYSTEM_FAN on the motherboard.
2. Press the tabs on the outer corners of the system fan, then pull the fan out of the chassis.
3. Lift the chassis fan case lock hooks, then push the fan from the center of the case until it is detached.

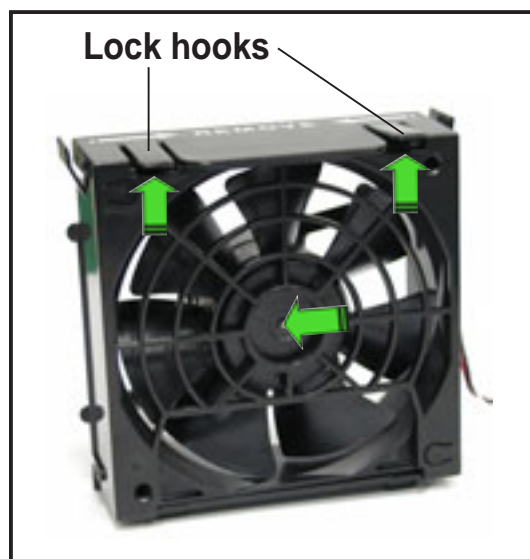
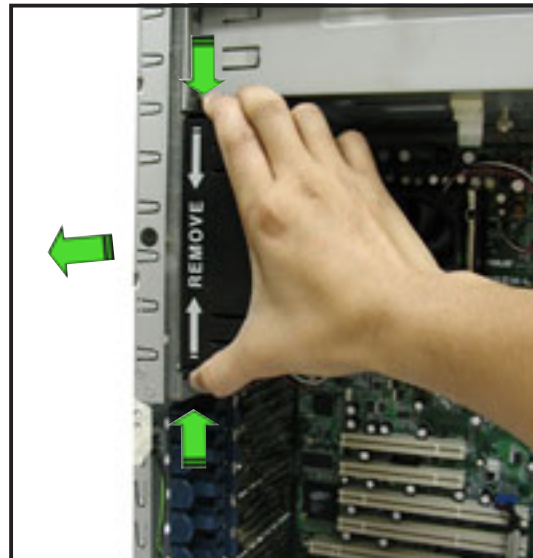

4. Pull the fan out from the fan case, then set aside.



To re-install the chassis fan:

1. Insert the new fan to the chassis fan cage.



2. Firmly hold the chassis fan on the side with the tabs and position it into its slot, making sure that the four hooks underneath the fan match the corresponding holes on the rear panel.

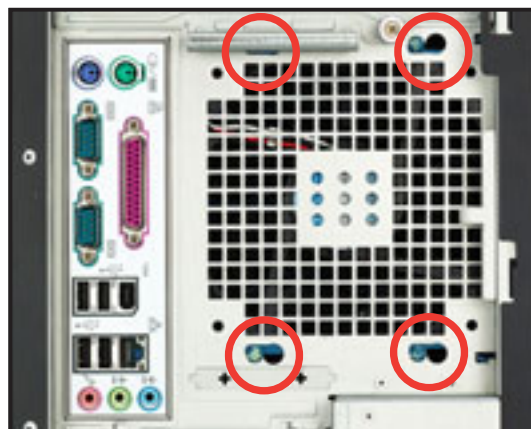

3. Push the fan into the chassis until the four hooks lock securely into the holes on the rear panel.
4. Re-connect the 3-pin fan cable from the connector SYSTEM_FAN on the motherboard.

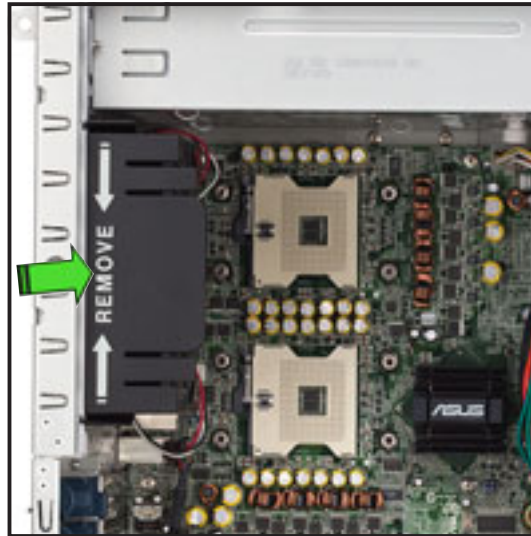

2.10.2 HDD fan

To remove the HDD fan:

1. Loosen the thumb screw that secures the HDD fan cage to the chassis.
2. Hold the outer side of the fan cage, then pull sideways to release it from the chassis.
3. Disconnect the 3-pin fan cable from the fan connector on the backplane before completely detaching the fan cage from the chassis.

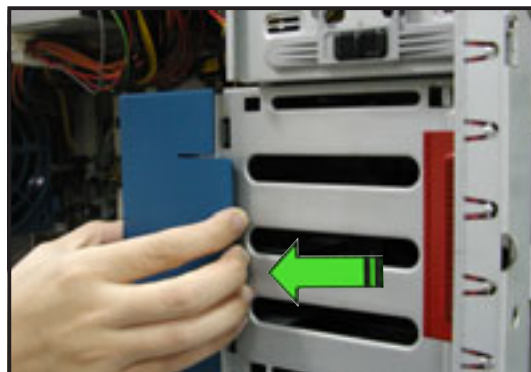
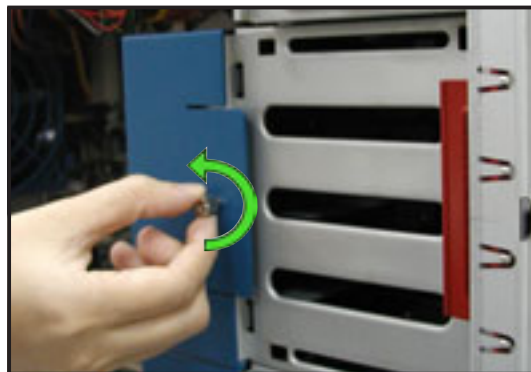

Due to space constraints inside the chassis, some cables may interfere with the removal of the fan cage. To easily remove the fan cage, try to slightly push it inward (toward the motherboard) before pulling it out of the chassis.

4. Locate four hooks inside the HDD fan case.

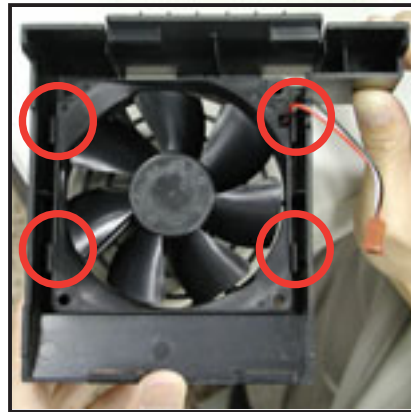

5. Press the fan case hooks outwards until the fan detaches from the case.

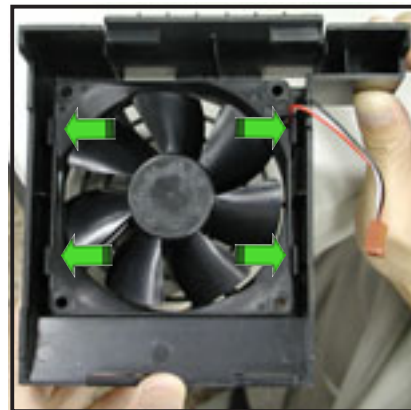

6. Slightly press the center of the fan vent to flush the fan out from the case. Set the HDD fan aside.



To re-install the HDD fan:

1. Insert a new HDD fan to the fan case until it clicks in place..

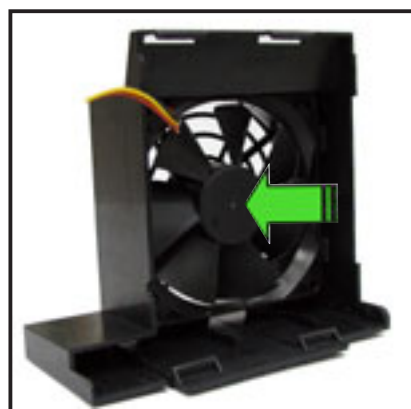

2. Re-connect the 3-pin fan cable to the fan connector on the backplane.

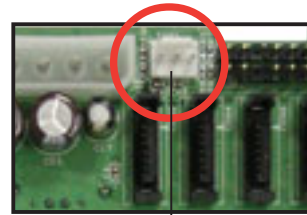

Fan connector on backplane (FAN1)

3. Hold the outer side of the HDD fan cage and hook the two side tabs to the inner edge of the drive cage. Make sure that the system cables are not caught up when you place the HDD fan.

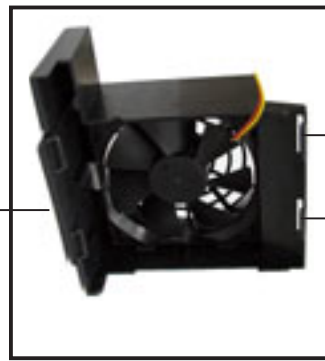

Outer side of fan cage

Side tabs



Inner edge of drive cage

4. Push the outer edge of the fan cage sideways to fit it to the drive cage. You hear a click when the fan cage correctly fits in place.

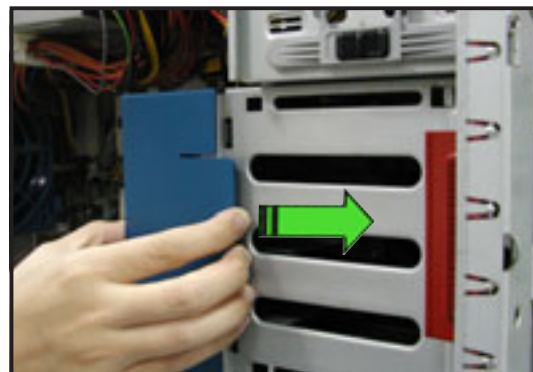

5. Secure the fan cage with the thumb screw.



2.10.3 SATA/SCSI backplane

To remove the SATA/SCSI backplane:

1. Remove the HDD fan cage. Refer to section “2.10.2 HDD fans” for instructions.
2. Disconnect all cables from the SATA/SCSI backplane.



When disconnecting a cable, hold and firmly pull the cable plug. DO NOT pull the cable itself. Doing so may damage the cable!



3. From the inner edge, push the backplane outward so that the outer edge protrudes slightly from the slot.
4. From the outer edge, firmly hold the backplane and carefully slide it out.



To re-install a SATA/SCSI backplane:

1. Position the backplane into its slot with the component side facing the rear panel, and the power connectors on top.
2. Align the backplane with the rail-like dents on the slot to ensure that it fits securely.

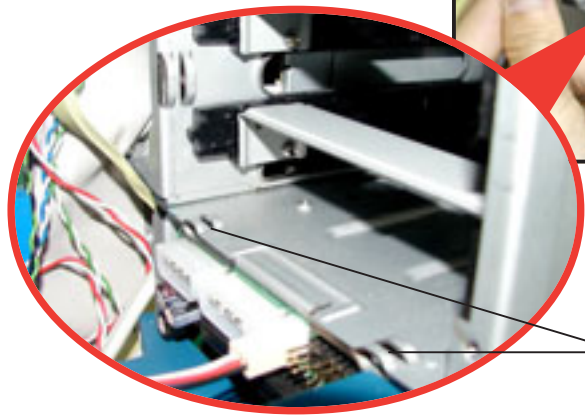

Rail-like dents

3. Slide the backplane into the slot until it fits. If correctly installed, the outer edge of the backplane aligns with the corner of the drive cage.
4. Connect the appropriate cables to the backplane. Refer to sections "2.9.2 SATA backplane connections" and "2.9.3 SCSI backplane connections" for details.



2.10.4 Floppy disk drive



You need to remove the front panel assembly before you can remove the floppy disk drive. Refer to section “2.5.1 Removing the front panel assembly” for instructions.

To remove the floppy disk drive:

1. Remove the screw that secures the drive to the chassis.

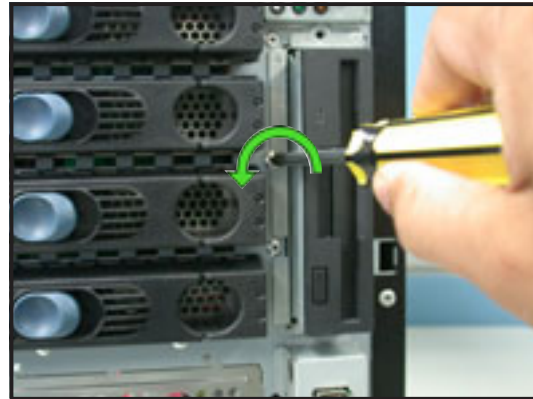

2. Carefully pull out the drive from the chassis until you see the cables connected to the drive.

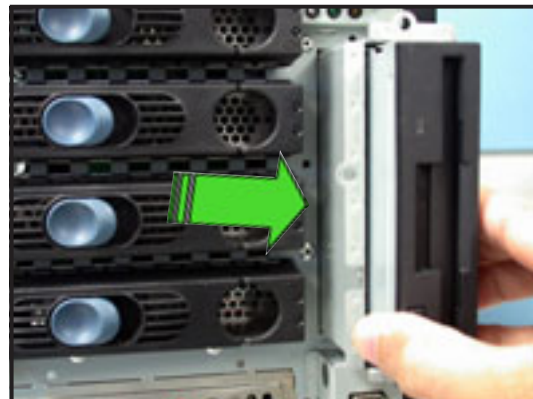

3. Disconnect the floppy disk cable and power cable from the drive to completely release the drive.



To install a floppy disk drive:

1. Position the floppy drive vertically with the eject button on the left side (close to the HDDs).
2. Connect the drive signal cable and power cable.

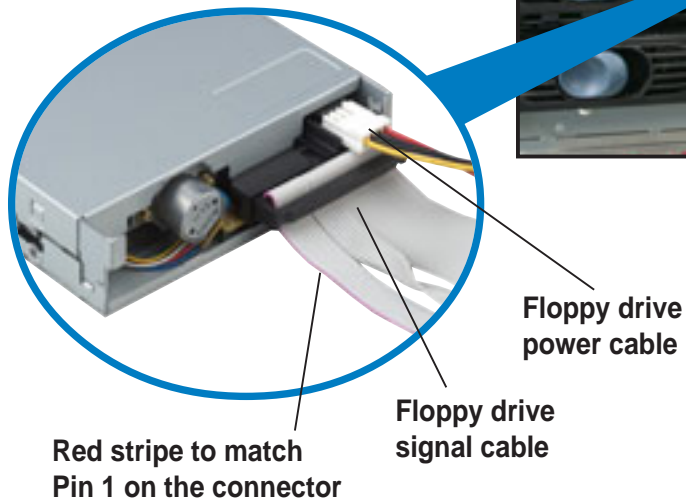

3. Carefully push the drive into the bay until the drive cage fits the front edge of the bay.

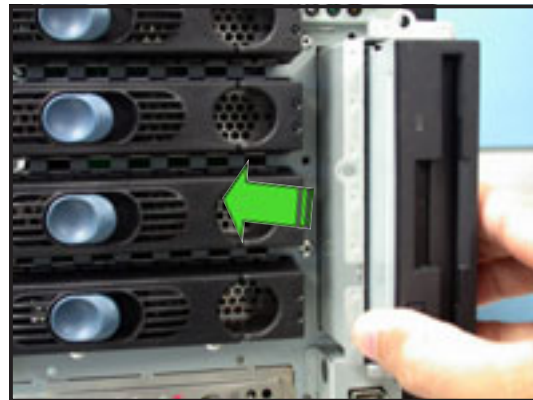

4. Secure the drive cage with a screw.

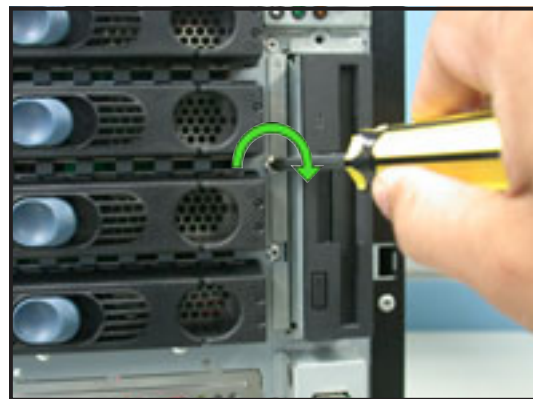

2.10.5 Front I/O board



You need to remove the front panel assembly before you can remove the front I/O board. Refer to section “2.5.1 Removing the front panel assembly” for instructions.

To remove the front I/O board:

1. Remove the screw that secures the front I/O board bracket to the front panel.

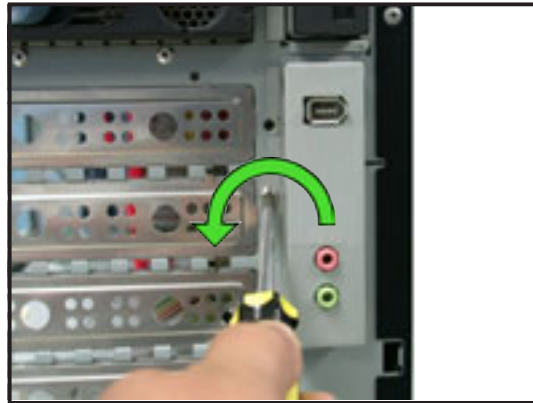

2. Carefully pull out the bracket until you see the cables connected to the I/O board.
3. Disconnect all the cables from the I/O board.



4. Remove the screw that secures the I/O board to the bracket.

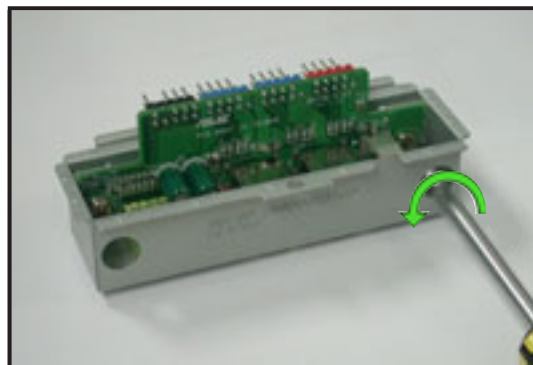

To install the front I/O board:

1. Place the I/O board in the bracket, component side up. Secure the front I/O board to the bracket with a screw.

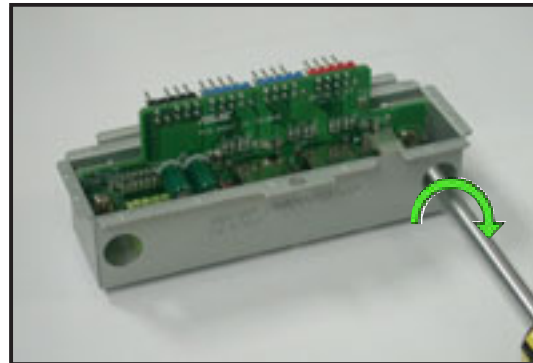

2. Position the I/O board into the bay with the component side to the left (close to the HDDs). Connect the I/O cables to the connectors on the back of the I/O board.



IEEE 1394
cable plug

Front panel
audio cable plug

3. Insert the I/O board into the bay until the bracket fits the front edge of the bay.
4. Secure the I/O board bracket with a screw.

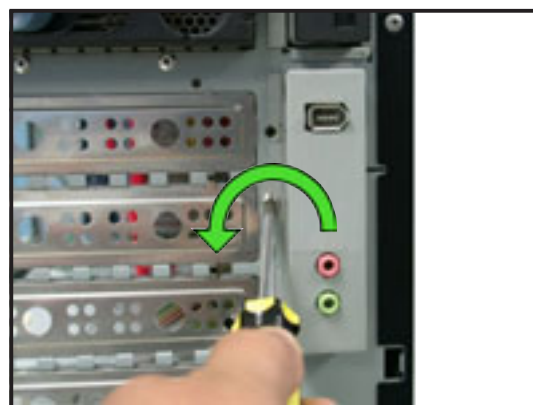

2.10.6 Chassis footpads and roller wheels

The barebone server system is shipped with four footpads attached to the bottom of the chassis for stability. You need to remove these footpads if:

- if you want to replace the footpads with the bundled roller wheels
- you wish to install the system to a rack
(Refer to “Chapter 3 Installation options” of this user guide, and to the “Rackmount Kit” user guide for instructions)

To remove the footpads:

1. Lay the system chassis on its side.
2. Use a flat screwdriver to flip out the top layer of a footpad.

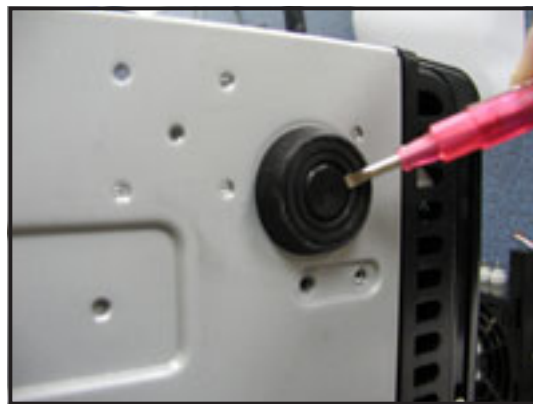

3. Remove the footpad by rotating it counterclockwise.

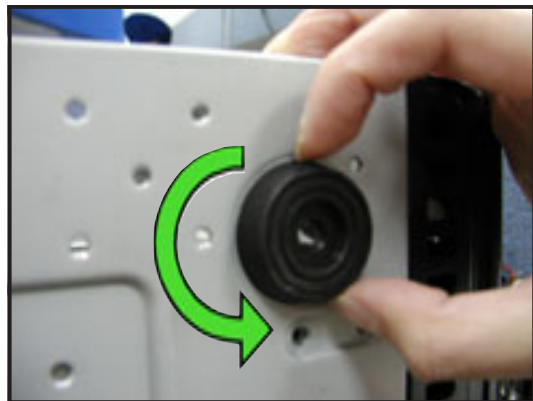

4. Repeat steps 2 and 3 to remove the other three footpads.

For convenient transport, install the roller wheels the came with the system package. Each wheel has a brake lock to stabilize the chassis in place.

To install the chassis wheels:

1. Lay the chassis in its side.
2. Locate the designated screw holes for each of the four wheel sets. Take note of the numbers alongside each hole when placing screws.

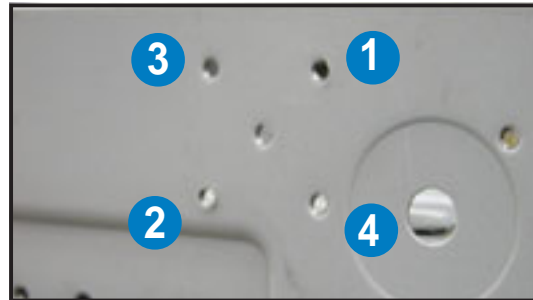

3. Secure each wheel to the bottom of the chassis using four screws.
4. Repeat steps 2 and 3 to install the other three wheels.



Remove the chassis roller wheels if you wish to mount the system to a rack.

To remove the chassis wheels:

1. Lay the system chassis on its side.
2. Use a Phillips screwdriver to remove the screws that secure the wheels to the bottom of the chassis.
3. Repeat step 2 to remove the other three roller wheels.



2.10.7 Power supply modules

The barebone server system power supply modules come in three configurations:



600 W single power supply
(110 V / 220 V autoswitch)



2 x 300 W dual power supply
(110 V / 220 V autoswitch)



3 x 300 W redundant power supply
(110 V / 220 V autoswitch)

Refer to this section when removing or installing power supply modules to the barebone system.



You **MUST** disconnect all power cable plugs from the motherboard and other installed devices before removing the 600 W single power supply.

The picture below shows the motherboard and device connectors where the power plugs are connected. Refer to the Appendix at the end of this document for the power supply specifications.

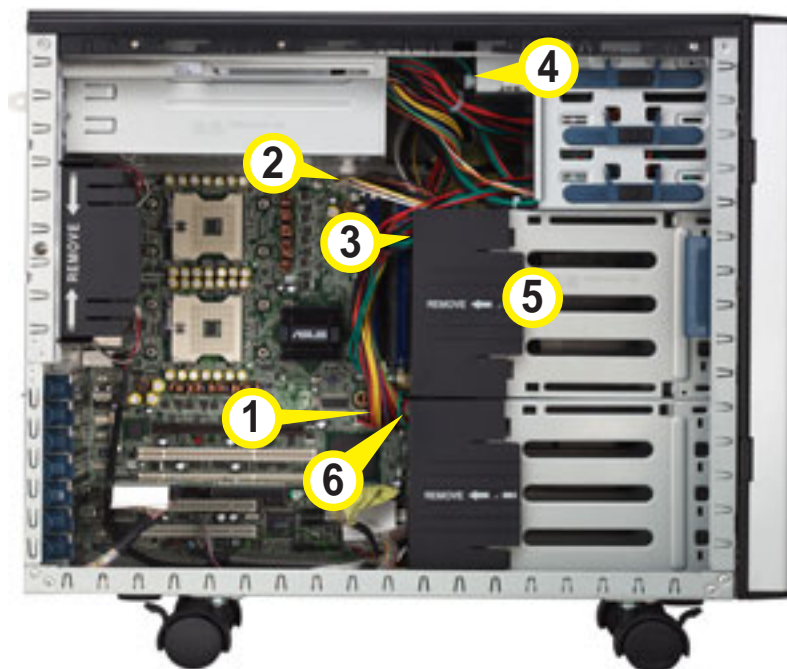

- 1 24-pin ATX (motherboard power connector)
- 2 8-pin +12V (motherboard power connector)
- 3 2 x 4-pin plugs (SCSI/SATA backplane; *hidden*)
- 4 4-pin plug (optical drive)
- 5 4-pin plug (floppy disk drive; *hidden*)
- 6 2 x 4-pin plugs (second SCSI backplane, if available; *hidden*)



Make sure to unplug **ALL** power cables from the system devices before removing the power supply module.

To remove the 600 W single power supply module:

1. Loosen the thumbscrew that secures the power supply metal plate. Do not remove the thumb screw from the metal plate.



Thumbscrew

2. Hold the metal plate bar and push it downward to release the plate from the chassis. Remove the metal plate completely.



Metal plate bar

3. Use one hand to push the power supply module from inside the power supply cage, then carefully pull out the module from the chassis.



To install a 600 W single power supply module:

1. Firmly hold the power supply module and insert it into the power supply cage.
2. Push the power supply all the way in until its outer end aligns with the rear panel.

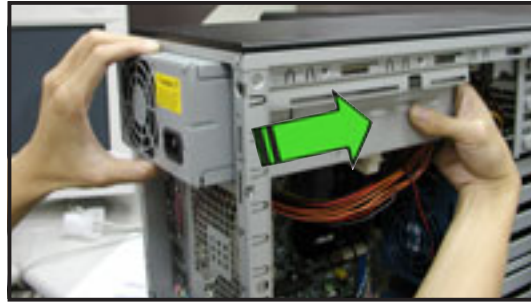

Be careful with the power supply cables when inserting the power supply module into the cage. Due to space constraints, the cables may get entangled with the installed components or other cables, causing the cables to break!

3. Place the metal plate flat on the outer end of the power supply module, flushed to the top of the chassis, while matching the four hooks with their corresponding holes on the rear panel.

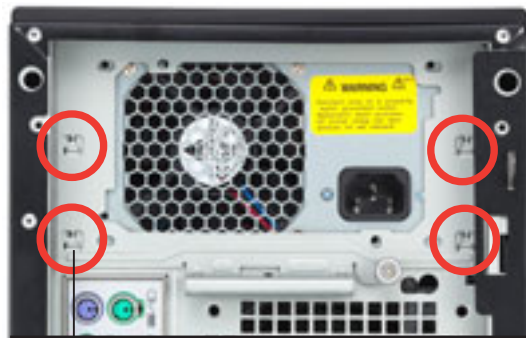

Hook matched to a hole

4. Hold the metal plate bar and push it upward to lock the hooks to their holes. At the same time, you may also push the top of the metal plate to fit it completely.
5. Secure the metal plate with the thumb screw.



To remove a 600 W dual or redundant power supply:

1. Loosen four screws on the metal brackets that secure the power supply to the chassis.



2. Use one hand to push the power supply module from inside the power supply cage, then carefully pull out the power supply module from the chassis.
3. Set the power supply aside.



To install a 600 W dual or redundant power supply:

1. Insert the power supply cables and plugs to the power supply cage.



Be careful with the power supply cables when inserting the power supply module into the cage. Due to space constraints, the cables may get entangled with the installed components or other cables, causing the cables to break!

2. Use a power supply module handle to push the power supply until it fits in place.



3. Secure the power supply to the chassis with two screws on the metal brackets on each side.



The standard server system comes with two power supply modules with no redundant power function. To achieve redundant power supply function, you must install an optional third power supply module.

Chapter 3

This chapter describes how to install optional components into the barebone server.



ASUS AP1720-E2 barebone server

Installation options



The items required for the optional configurations described in this chapter are not included in the standard barebone system package. These items are purchased separately.

3.1 Installing a second SCSI drive cage

Perform this installation if you wish to upgrade your 4-SCSI configuration system (AS4 model) to an 8-SCSI configuration (AS8).

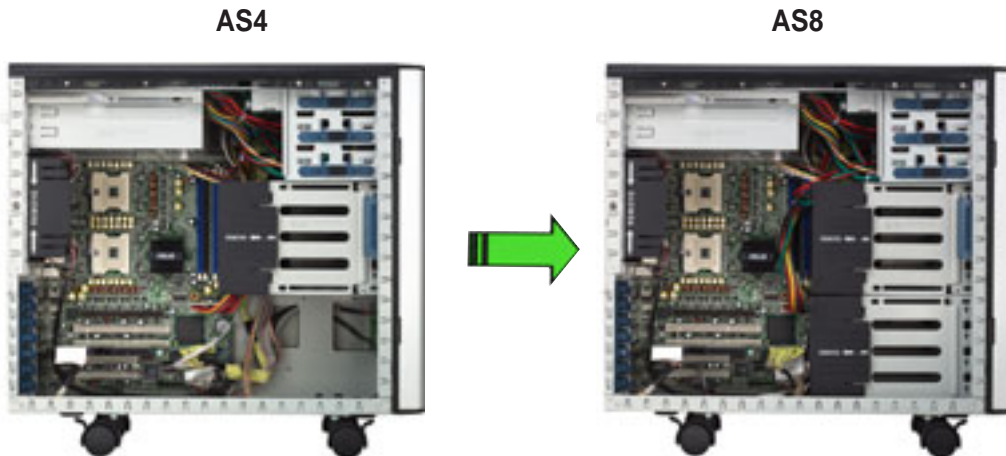

Clear the space under the first SCSI drive cage. Make sure that you disconnect all pre-connected cables so they do not get in the way when you install the second drive cage.

To install a second SCSI drive cage:

1. Position the drive cage in the same orientation as the first drive cage. Note that the lock tab on top of the cage faces the rear panel.

Cage lock tab



2. Carefully slide the drive cage toward the front panel until it fits in place.



3. Make sure that the cage lock tab snaps to the bottom of the first drive cage. When properly installed, the cage should align with the first drive cage.

Cage lock tab snapped securely to the bottom of first drive cage

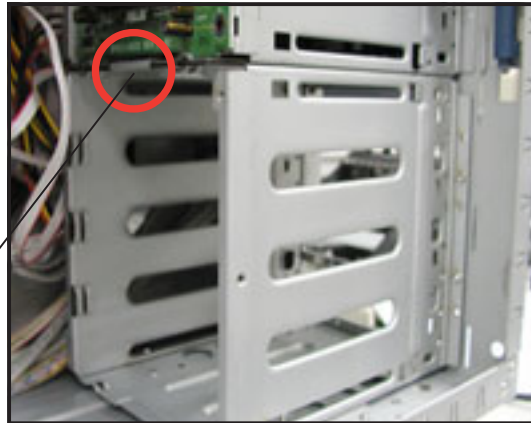

4. From the front side, secure the right side of the cage with two screws.

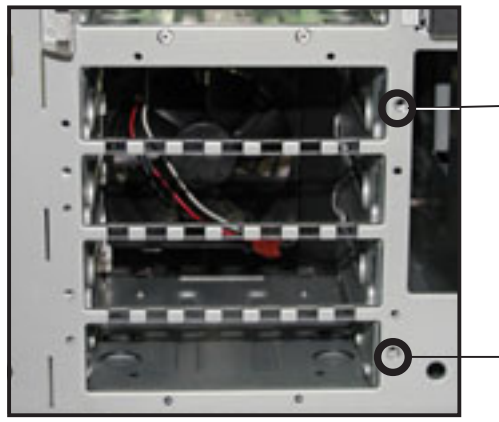

Front screw holes

5. Position the support bracket for the drive trays to the left side of the cage with the three protruding tabs matching the elongated holes on the chassis.

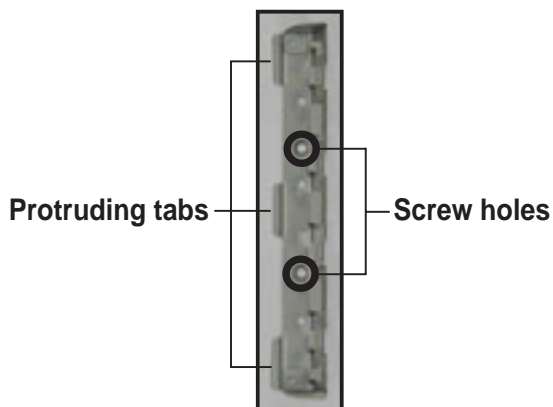

SCSI drive tray support bracket



Elongated holes for bracket

6. Insert the tabs into the holes. You may need to swing the bracket a bit from left to right and back to fully insert the tabs.
7. When the tabs are fully inserted in the holes, swing the bracket to the right until one side is flat to the chassis.

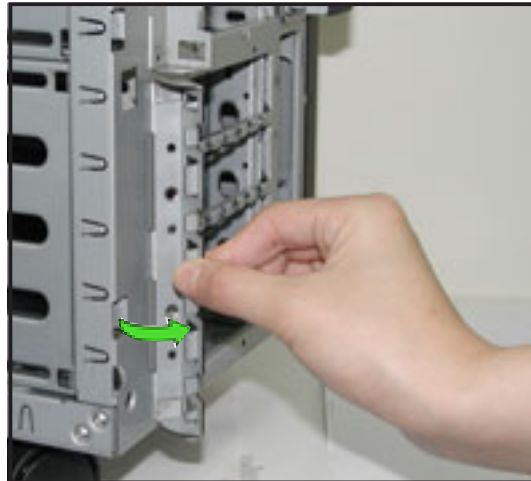

8. Secure the bracket with two screws in the holes indicated.

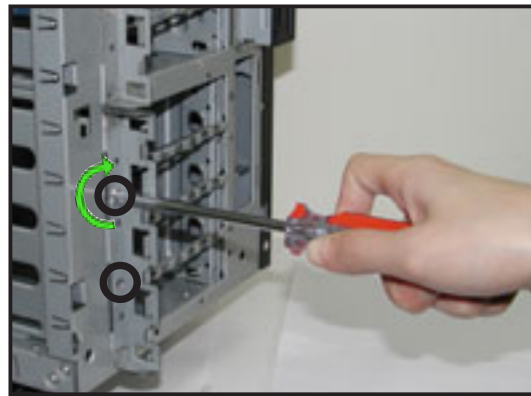

Securing the bracket with the two screws also secures the left side of the SCSI drive cage.

3.2 Installing an IDE drive cage

Perform this installation if you wish to upgrade your 4-SCSI configuration system (AS4 model) to a combination 4-SCSI/4-IDE configuration.

4-SCSI configuration



4-SCSI/4-IDE configuration



Clear the space under the first SCSI drive cage. Make sure that you disconnect all pre-connected cables so they do not get in the way when you install the second drive cage.

To install an IDE drive cage:

1. Position the drive cage into the bay with the screw hole tab on top and facing out.



Screw hole

2. Carefully slide the drive cage toward the front panel until it fits in place.

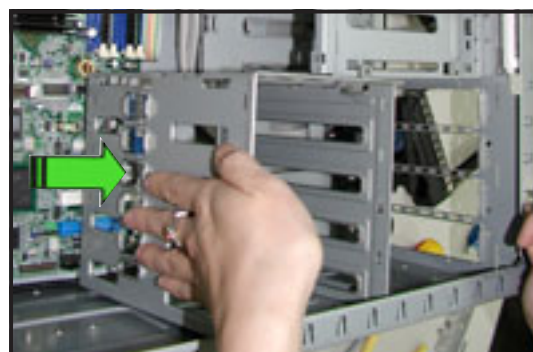

3. Make sure that the drive cage is fits snugly to the bay as shown. The drive cage is properly installed when it is parallel to the front panel, and the screw hole matches the hole of the first drive cage.



Screw hole

4. Secure the drive cage with a screw.

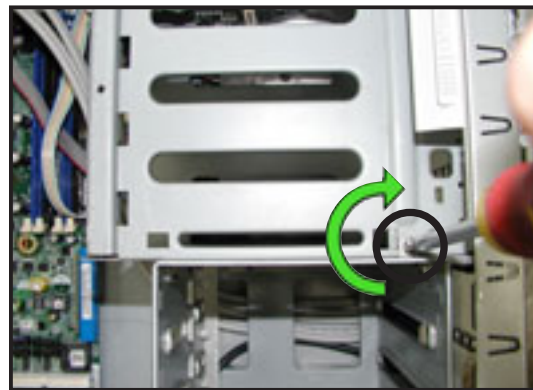

3.3 Upgrading to a dual or redundant power supply

Perform this installation if you wish to upgrade your barebone server system from 600 W single power supply to 600 W dual or redundant power supply.

1. Remove the single power supply following the instructions in the section “2.10 Removable components”.
2. Lay the system on its side on a flat surface, then remove the metal stopper screw under the power supply cage.
Keep the screw for later use.



3. Locate and remove the metal stopper from inside the power supply cage.
Keep the metal stopper for later use.



4. Insert the power supply cables and plugs to the power supply cage.



5. Push the power supply halfway to the power supply cage, then attached the a metal bracket on each side of the power supply with two screws.



6. Push the power supply to the power supply cage until the metal brackets and the chassis screw holes align.



7. Secure the power supply to the chassis with two screws on each metal bracket.



3.4 Installing a power supply module

Perform this installation if you wish to upgrade your barebone server system from 600 W dual to 600 W redundant power supply.

1. Press down the rubber lever of the dummy module to unlock.



2. Use the module handle to pull the dummy module out from the power supply case.



3. Insert the power supply module to the empty bay with the power connector on top.



4. Push the power supply module inside the bay until it is aligned with the other power supply modules.



The pictures shows the power supply module when installed.



3.5 Preparing the system for rack mounting

3.5.1 Remove the footpads or roller wheels

Refer to section “2.10.7 Chassis roller wheels and footpads” for instructions on removing the footpads or roller wheels.

3.5.2 Remove the top cover

To remove the top cover:

1. Remove the side cover. Refer to section “2.1.1 Removing the side cover” for instructions.
2. Remove the front panel assembly. Refer to section “2.5.1 Removing the front panel assembly” for instructions.
3. Locate the lock tab underneath the top cover and press it outward to release the cover.
4. Slide the top cover toward the front panel, then lift it up from the chassis.

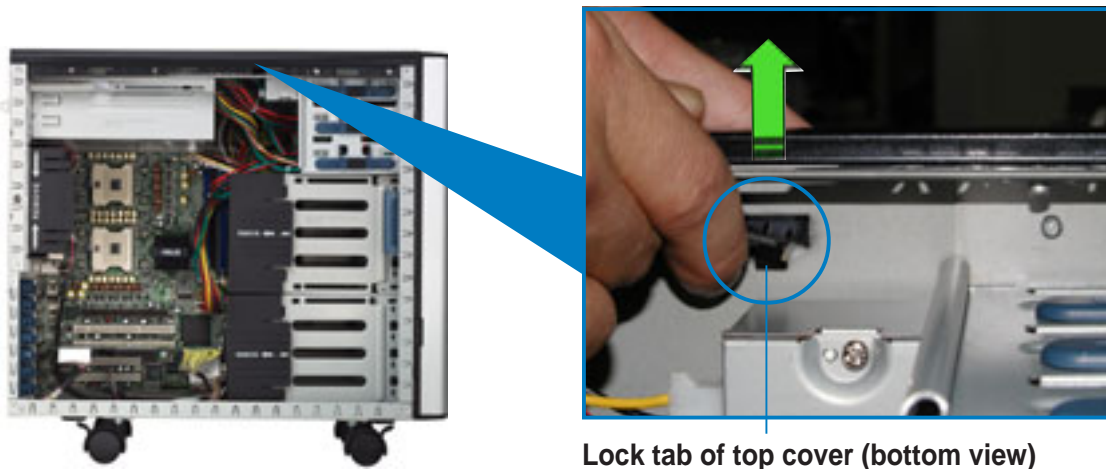

Lock tab of top cover (bottom view)

3.5.3 Attach the rack rails

Refer to the Rackmount Rail Kit installation guide for instructions on how to attach the rails and on the barebone server system and the corresponding rails on the industrial rack.



The AK25 Rackmount Rail Kit is an optional item and is purchased separately.

Chapter 4

This chapter includes the motherboard layout and brief descriptions of the jumpers and internal connectors.



ASUS AP1720-E2 barebone server

Motherboard info

4.1 Motherboard layout

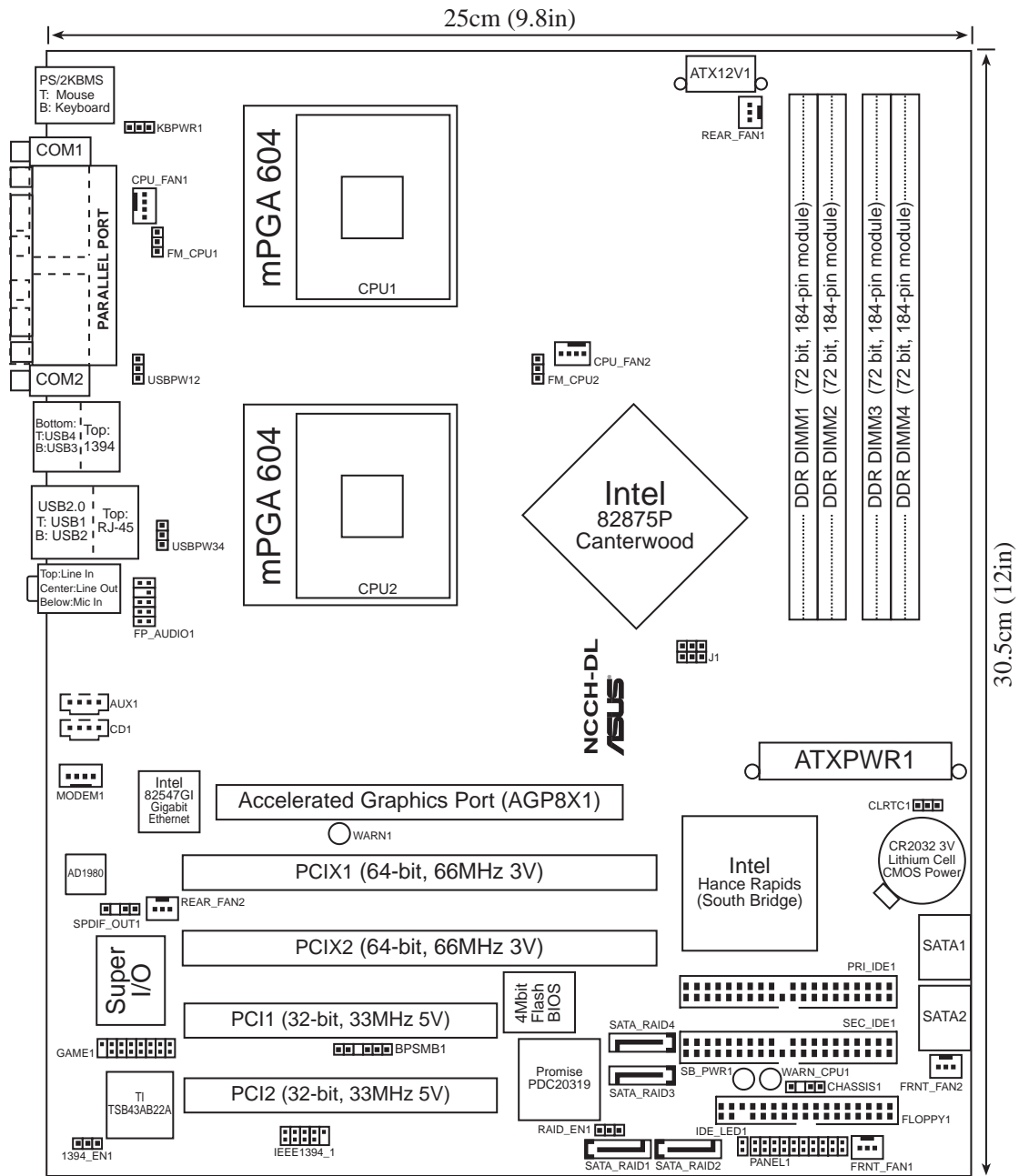

Layout contents

Jumpers	
1. Keyboard power (3-pin KBPWR1)	4-4
2. RAID controller setting (3-pin RAID_EN1)	4-4
3. USB device wake-up (3-pin USBPW12, USBPW34)	4-5
4. CPU external frequency selection (3-pin J1)	4-5
5. Clear RTC RAM (3-pin CLRTC1)	4-6
6. IEEE 1394 setting (3-pin 1394_EN)	4-7
7. CPU fan pin selection (3-pin FM_CPU1, FM_CPU2)	4-7
Internal connectors	
1. Floppy disk drive connector (34-1 pin FLOPPY1)	4-8
2. Serial ATA connectors (7-pin SATA1, SATA2)	4-8
3. IDE connectors (40-1 pin PRI_IDE [blue], SEC_IDE [white])	4-9
4. GAME/MIDI connector (16-1 pin GAME1)	4-9
5. IEEE 1394 connector (10-1 pin IE1394_1)	4-10
6. Chassis intrusion connector (4-1 pin CHASSIS1)	4-10
7. Serial ATA RAID connectors (7-pin SATA_RAID1/2)	4-11
8. Backplane SMBus connector (6-1 pin BPSMB1)	4-11
9. Power connectors (24-pin ATXPWR1, 8-pin ATX12V1)	4-12
10. Hard disk activity LED connector (2-pin IDELED1)	4-12
11. Front panel audio connector (10-1 pin FP_AUDIO1)	4-13
12. Internal audio connectors (4-pin CD1, AUX1, MODEM1)	4-13
13. CPU and system fan connectors (3-pin CPU_FAN1/2, REAR_FAN1/2, FRNT_FAN1/2)	4-14
14. System panel connector (20-pin PANEL)	4-14
- System Power LED (3-pin PLED)	4-15
- Message LED (2-pin MLED)	4-15
- System warning speaker (4-pin SPKR)	4-15
- Hard disk activity (2-pin HD_LED)	4-15
- Power switch / Soft-off switch (2-pin PWR_SW)	4-15
- Reset switch (2-pin RESET)	4-15
- System Management Interrupt (2-pin SMI)	4-15

4.2 Jumpers

1. Keyboard power (3-pin KBPWR1)

This jumper allows you to enable (pins 2-3) or disable (pins 1-2) the keyboard wake-up feature. Set this jumper to pins 2-3 (+5VSB) if you wish to wake up the computer when you press a key on the keyboard. This feature requires an ATX power supply that can supply at least 1A on the +5VSB lead, and a corresponding setting in the BIOS. Refer to Chapter 5 for information.

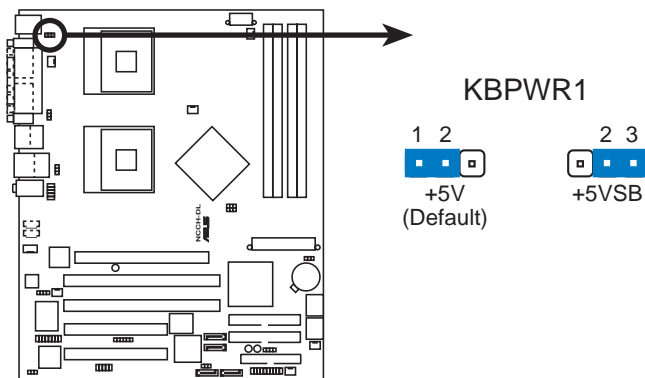

NCCH-DL Keyboard power setting

2. RAID controller setting (3-pin RAID_EN1)

This jumper allows you enable or disable the Promise® PDC20319 RAID controller.

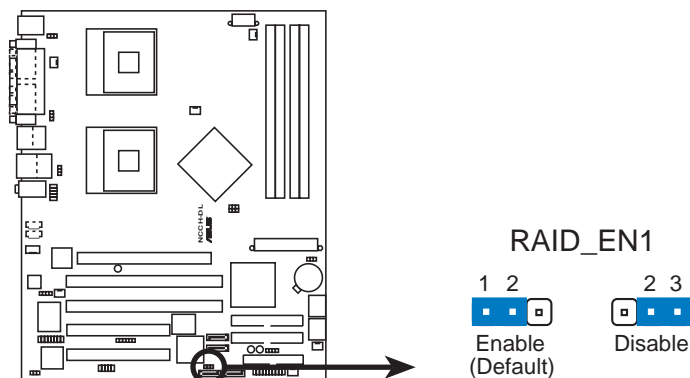

NCCH-DL RAID controller setting

3. USB device wake-up (3-pin USBPW12, USBPW34)

Set these jumpers to +5V to wake up the computer from S1 sleep mode (CPU stopped, DRAM refreshed, system running in low power mode) using the connected USB devices. Set to +5VSB to wake up from S3 and S4 sleep modes (no power to CPU, DRAM in slow refresh, power supply in reduced power mode).

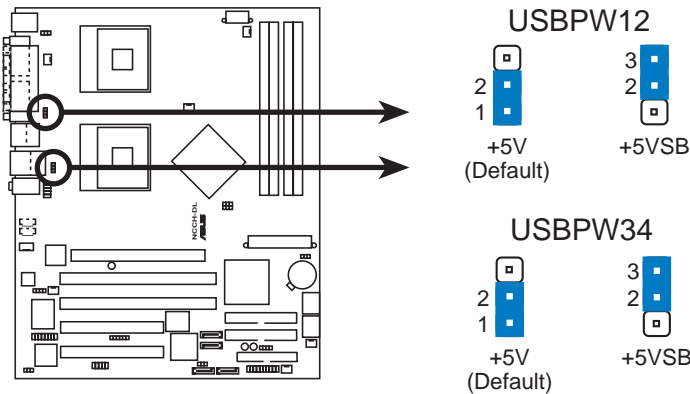

NCCH-DL USB device wake up



1. The USB device wake-up feature requires a power supply that can provide 500mA on the +5VSB lead for each USB port. Otherwise, the system would not power up.
2. The total current consumed must NOT exceed the power supply capability (+5VSB) whether under normal condition or in sleep mode.

4. CPU external frequency selection (6-pin J1)

This jumper allows you to select the CPU external frequency (or bus clock).



To ensure system stability, it is recommended that you keep the default setting.

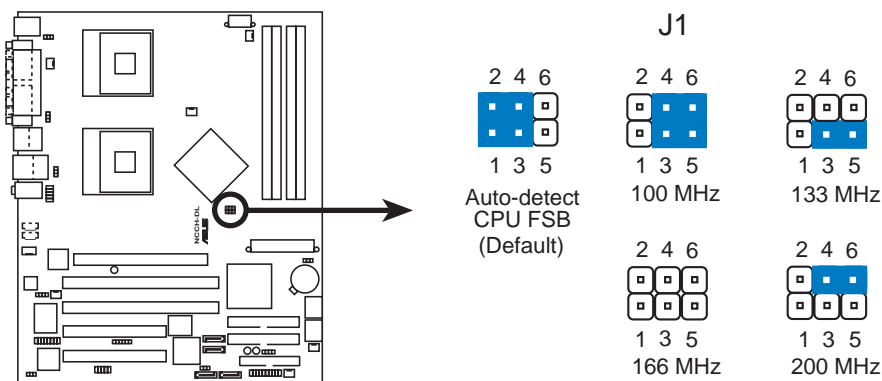

NCCH-DL CPU external frequency selection

5. Clear RTC RAM (3-pin CLRTC1)

This jumper allows you to clear the Real Time Clock (RTC) RAM in CMOS. The RAM data in CMOS, that include system setup information such as system date, time, and system setup parameters, and passwords, is powered by the onboard button cell battery.

To erase the RTC RAM:

1. Turn OFF the computer and unplug the power cord.
2. Remove the onboard battery.
3. Move the jumper cap from pins 1-2 (default) to pins 2-3. Keep the cap on pins 2-3 for about 5~10 seconds, then move the cap back to pins 1-2.
4. Re-install the battery.
5. Plug the power cord and turn ON the computer.
6. Hold down the key during the boot process and enter BIOS setup to re-enter data.

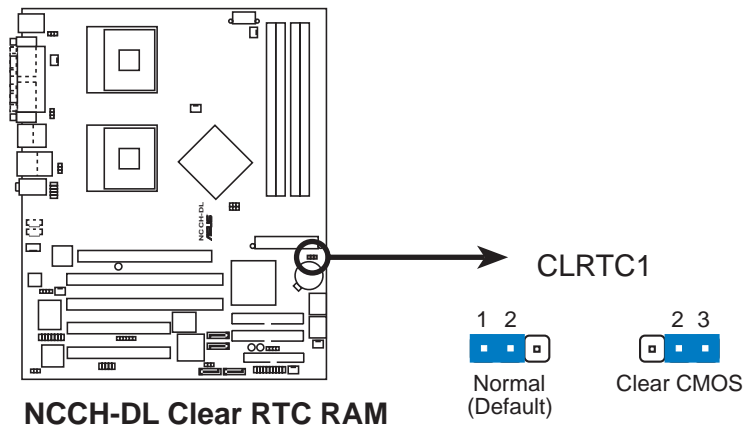

Except when clearing the RTC RAM, never remove the cap on CLRTC1 jumper default position. Removing the cap will cause system boot failure!

6. CPU fan pin selection (3-pin FM_CPU1, FM_CPU2)

These jumpers allow you to connect either a 3-pin or a 4-pin fan cable plug to the CPU fan connectors (CPU_FAN1, CPU_FAN2). Set these jumpers to pins 1-2 if you are using a 3-pin fan cable plug, or to pins 2-3 if you are using a 4-pin plug.

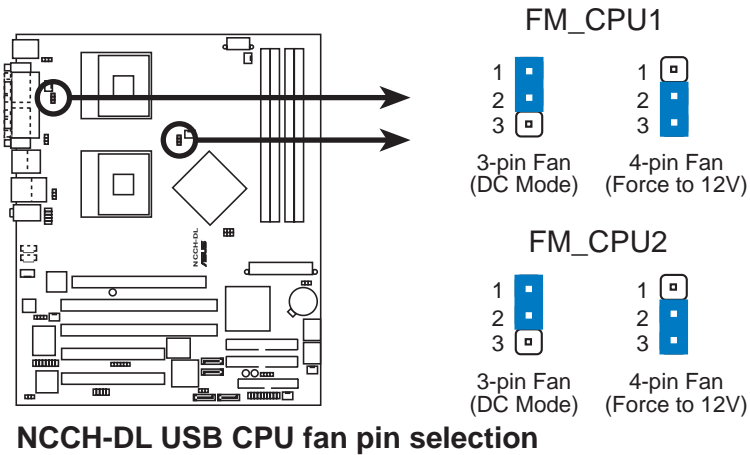

7. IEEE 1394 setting (3-pin 1394_EN)

These jumpers allow you to enable or disable the onboard IEEE 1394 controller. Set to pins 1-2 to activate the 1394 feature.

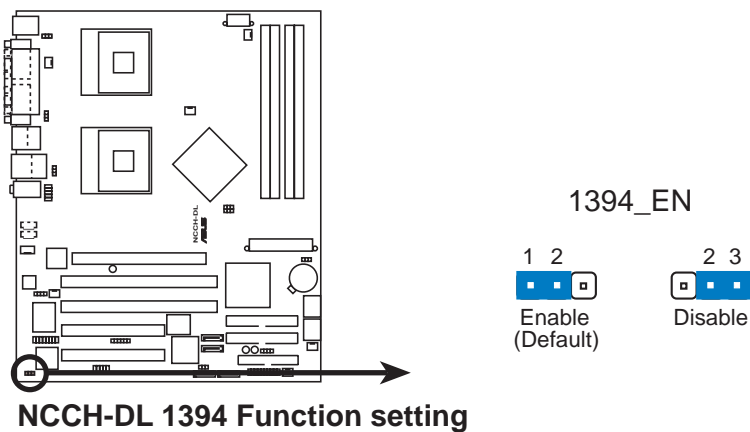

4.3 Connectors

1. Floppy disk drive connector (34-1 pin FLOPPY1)

This connector supports the provided floppy drive ribbon cable. After connecting one end to the motherboard, connect the other end to the floppy drive.

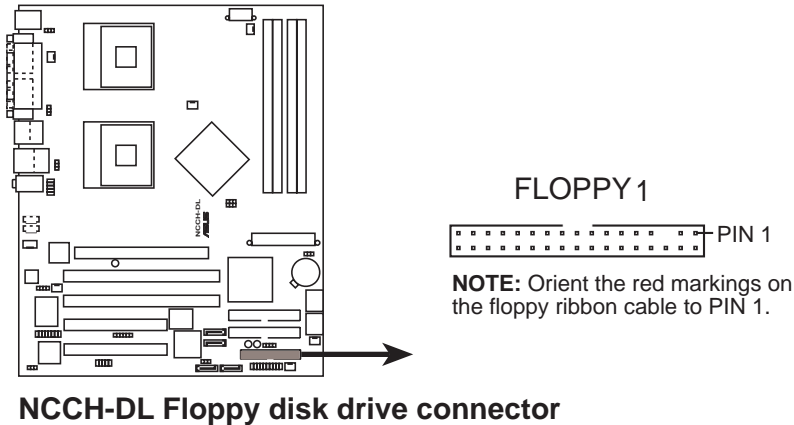

2. Serial ATA connectors (7-pin SATA1, SATA2)

These next generation connectors support the thin Serial ATA cables for Serial ATA hard disks. The current Serial ATA interface allows up to 150 MB/s data transfer rate, faster than the standard parallel ATA with 133 MB/s (Ultra ATA/133).

If you installed Serial ATA hard disks, you may create a RAID 0/RAID 1 configuration using the RAID feature of the Intel® 6300ESB ICH. Refer to page 5-26 to 5-27 for the SATA configuration.

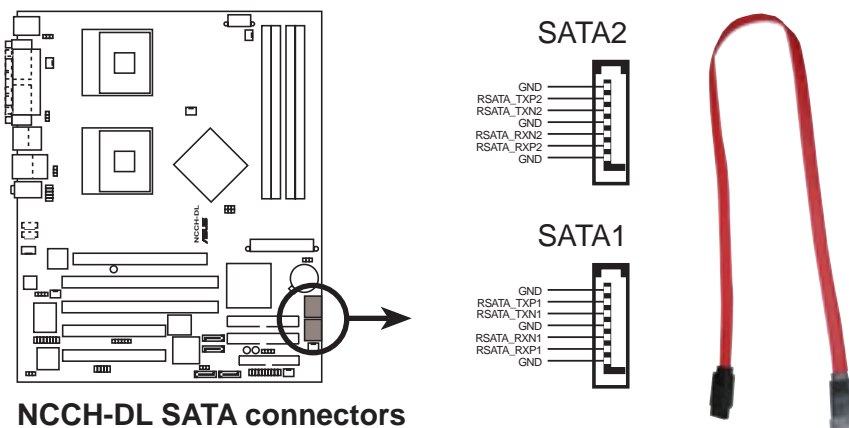

3. IDE connectors (40-1 pin PRI_IDE [blue], SEC_IDE [white])

This connector supports the provided UltraDMA/100/66 IDE hard disk ribbon cable. Connect the cable's blue connector to the primary (recommended) or secondary IDE connector, then connect the gray connector to the UltraDMA/100/66 slave device (hard disk drive) and the black connector to the UltraDMA/100/66 master device.



- Refer to the hard disk drive label or documentation when setting the device as master or slave.
- Pin 20 on each IDE connector is removed to match the covered hole on the UltraDMA cable connector. This prevents incorrect orientation when you connect the cables.

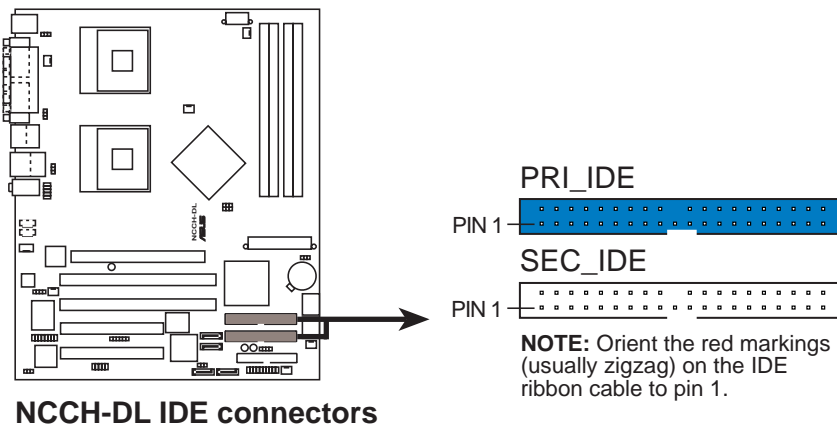

NCCH-DL IDE connectors

4. GAME/MIDI connector (16-1 pin GAME1)

This connector supports a GAME/MIDI module. Connect the GAME/MIDI cable to this connector. The GAME/MIDI port on the module connects a joystick or a game pad for playing games, and MIDI devices for playing or editing audio files.

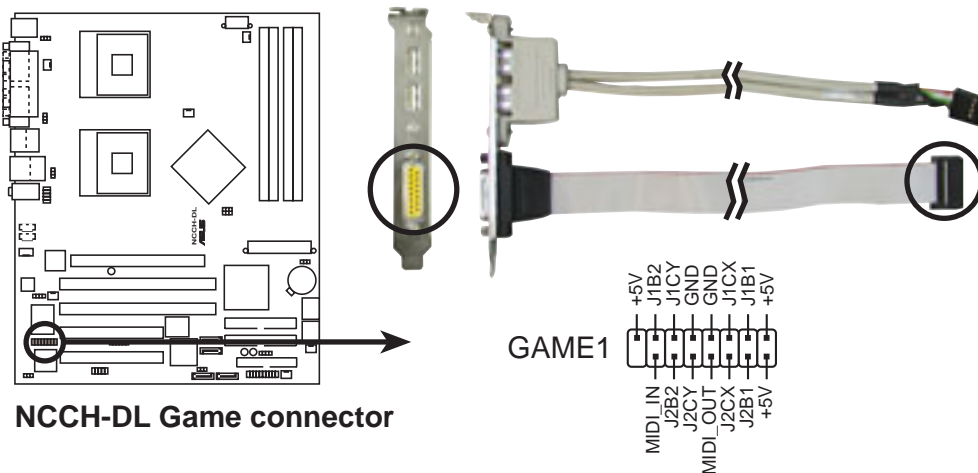

NCCH-DL Game connector

5. IEEE 1394 connector (10-1 pin IE1394_1)

This connector is for a 1394 module. Attach the 10-1 pin 1394 cable plug from the module to this connector. You may also connect a 1394-compliant internal hard disk to this connector.

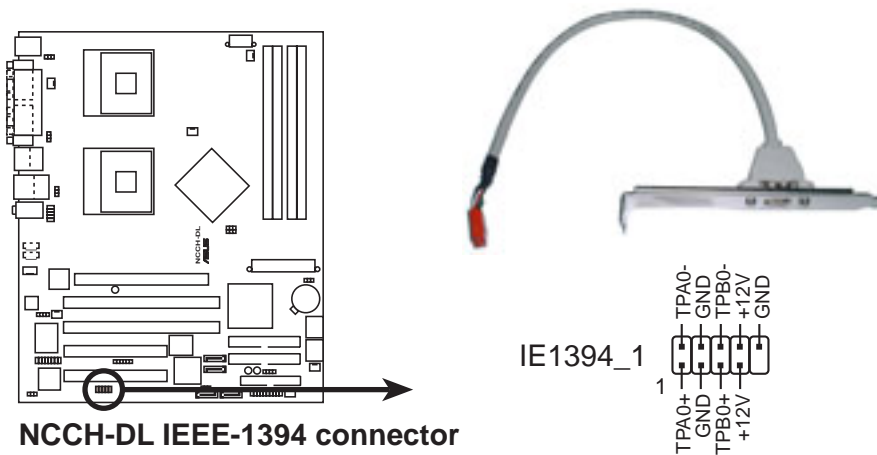

6. Chassis intrusion connector (4-1 pin CHASSIS1)

This lead is for a chassis designed with intrusion detection feature. This requires an external detection mechanism such as a chassis intrusion sensor or microswitch. When you remove any chassis component, the sensor triggers and sends a high-level signal to this lead to record a chassis intrusion event.

By default, the pins labeled “Chassis Signal” and “Ground” are shorted with a jumper cap. If you wish to use the chassis intrusion detection feature, remove the jumper cap from the pins.

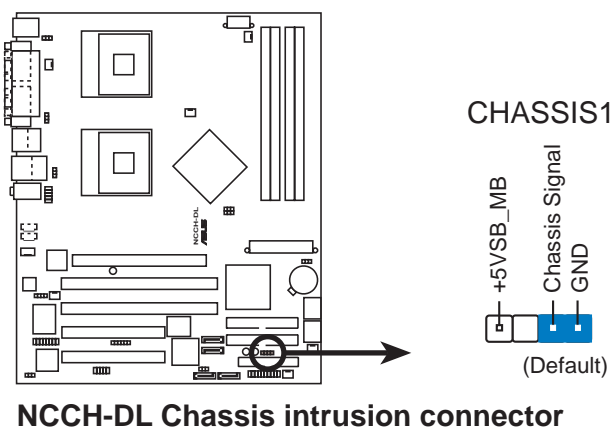

7. Serial ATA RAID connectors (7-pin SATA_RAID1, SATA_RAID2)

These Serial ATA connectors support SATA hard disks that you may configure as a RAID set. Through the onboard Promise® PDC20319 RAID controller, you may create a RAID0, RAID1, or RAID0+1 configuration. Configure the onboard device and SATA items in BIOS to use the RAID feature. Refer to page 5-26 and 5-27 for information.

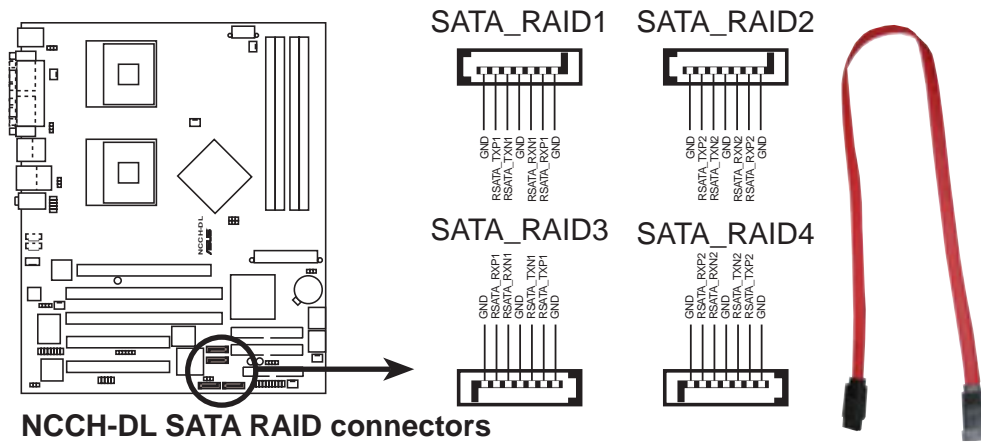

8. Backplane SMBus connector (6-1 pin BPSMB1)

This connector allows you to connect SMBus (System Management Bus) devices. Devices communicate with an SMBus host and/or other SMBus devices using the SMBus interface.

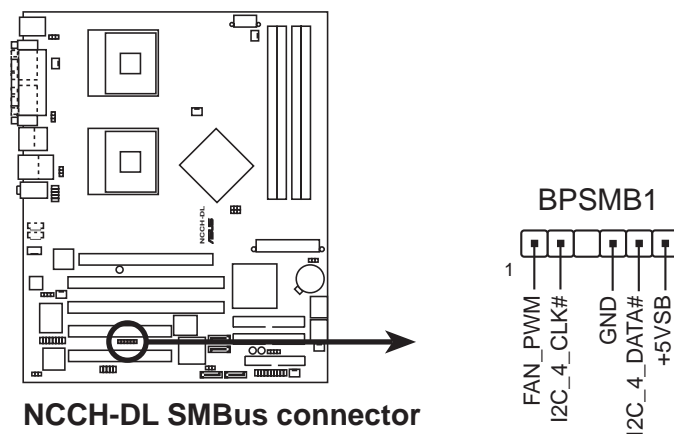

9. Power connectors (24-pin ATXPWR1, 8-pin ATX12V1)

These connectors connect to an SSI-type 12V power supply. The plugs from the power supply are designed to fit these connectors in only one orientation. Find the proper orientation and push down firmly until the connectors completely fit.



1. Do not forget to connect the 8-pin +12V power plug. Otherwise, the system does not boot up.
2. When using Intel® Xeon™ 800 MHz processor, make sure that your power supply can provide a total of 27A, minimum of three +12V output leads and at least 1A on the +5V standby lead (+5VSB).
3. The minimum recommended wattage is 600W. The system may become unstable or may not boot up if the power is inadequate.

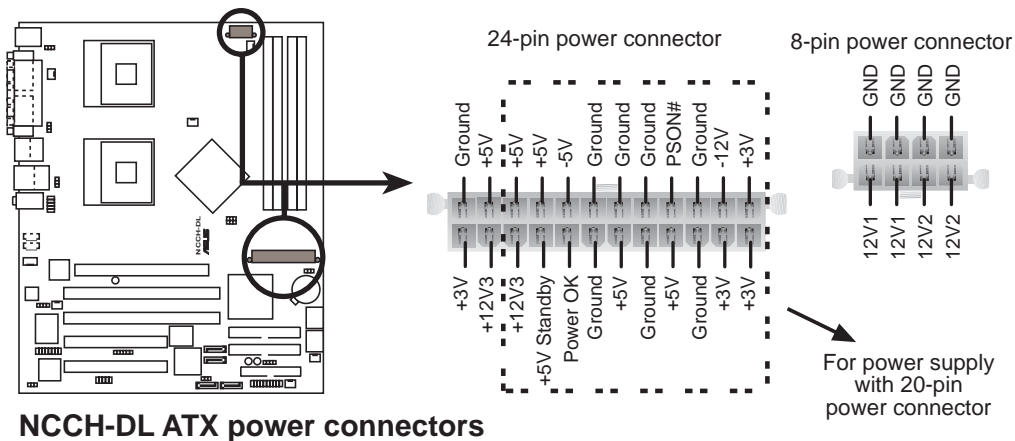

10. Hard disk activity LED connector (2-pin IDELED1)

This connector supplies power to the hard disk activity LED. The read or write activities of any device connected to the primary or secondary IDE connector cause this LED to light up.

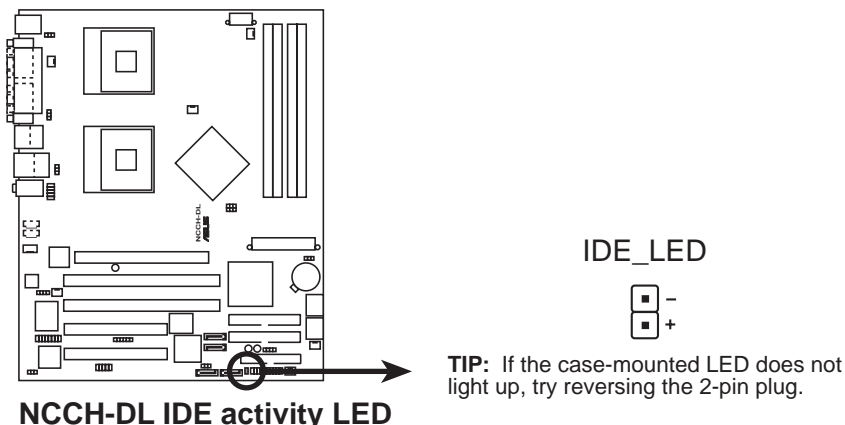

11. Front panel audio connector (10-1 pin FP_AUDIO1)

This is an interface for the Intel front panel audio cable that allow convenient connection and control of audio devices.

By default, the pins labeled LINE OUT_R/BLINE_OUT_R and the pins LINE OUT_L/BLINE_OUT_L are shorted with jumper caps. Remove the caps only when you are connecting the front panel audio cable.

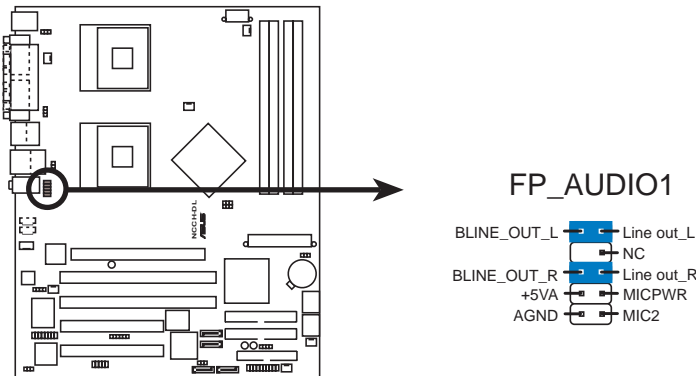

NCCH-DL Front panel audio connector

12. Internal audio connectors (4-pin CD1, AUX1, MODEM1)

These connectors allow you to receive stereo audio input from sound sources such as a CD-ROM, TV tuner, or MPEG card. The MODEM connector allows the onboard audio to interface with a voice modem card with a similar connector. It also allows the sharing of mono_in (such as a phone) and a mono_out (such as a speaker) between the audio and a voice modem card.

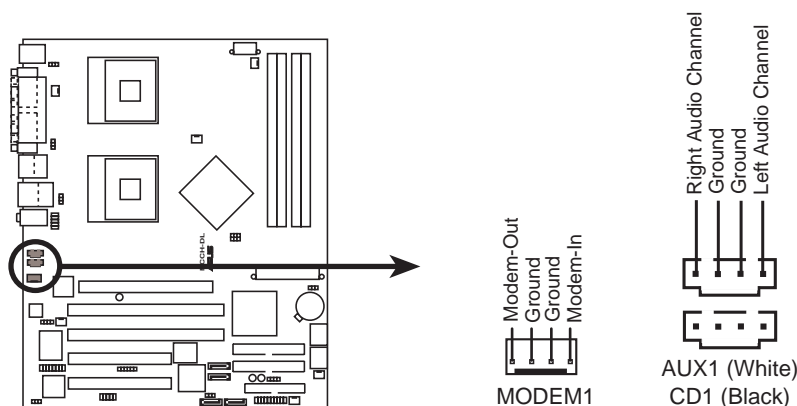

NCCH-DL Internal audio connectors

13. CPU and system fan connectors (4-pin CPU_FAN1/2, 3-pin REAR_FAN1/2, 3-pin FRNT_FAN1/2)

The fan connectors support cooling fans of 350mA~740mA (8.88W max.) or a total of 2.1A~4.44A (53.28W max.) at +12V. Connect the fan cables to the fan connectors on the motherboard, making sure that the black wire of each cable matches the ground pin of the connector.



The CPU fan connectors support either a 3-pin or a 4-pin fan cable plug. Both connectors are slotted to ensure connection in correct orientation.

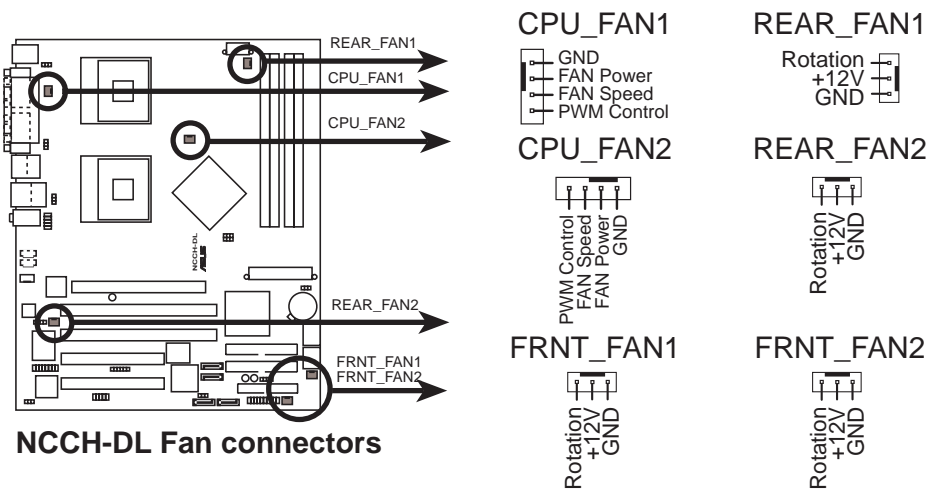

NCCH-DL Fan connectors



Do not forget to connect the fan cables to the fan connectors. Lack of sufficient air flow within the system may damage the motherboard components. These are not jumpers! DO NOT place jumper caps on the fan connectors!

14. System panel connector (20-pin PANEL1)

This connector accommodates several system front panel functions.

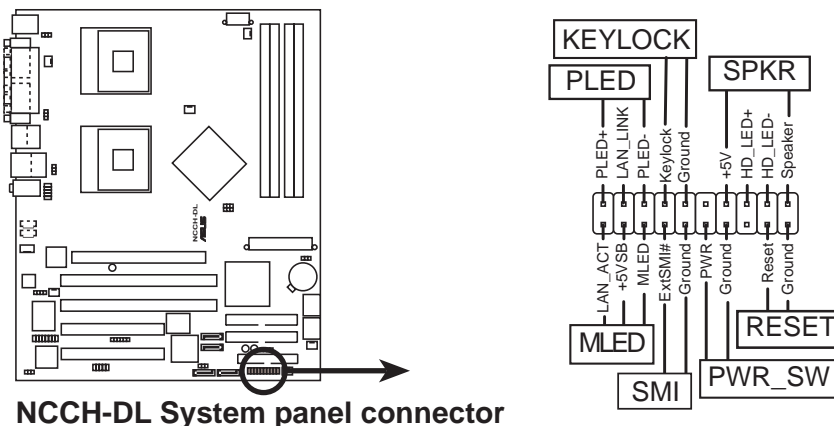

NCCH-DL System panel connector

- **System Power LED (3-pin PLED)**

This lead connects to the system power LED. The LED lights up when you turn on the system power, and blinks when the system is in sleep mode.
- **Message LED (2-pin MLED)**

This lead connects to the message LED cable on the front panel and indicates the booting status. The LED blinks when the system is in the boot process until the operating system is loaded.
- **System warning speaker (4-pin SPEAKER)**

This lead connects to the case-mounted speaker and allows you to hear system beeps and warnings.
- **Hard disk activity (2-pin HD_LED)**

This lead connects the HDD LED cable. The read or write activities of the device connected to the any of IDE connectors cause the IDE LED to light up.
- **Power switch / Soft-off switch (2-pin PWR_SW)**

This lead connects a switch that controls the system power. Pressing the power switch turns the system between ON and SLEEP, or ON and SOFT OFF, depending on the BIOS or OS settings. Pressing the power switch while in the ON mode for more than 4 seconds turns the system OFF.
- **Reset switch (2-pin RESET)**

This lead connects to the chassis-mounted reset switch for rebooting the system without turning off the system power.
- **System Management Interrupt (2-pin SMI)**

This lead connects to the chassis-mounted suspend switch. This feature allows you to manually put the system into suspend mode, or “green” mode, where system activity is instantly decreased to save power and to expand the life of certain system components.

Chapter 5

This chapter tells how to change the system settings through the BIOS Setup menus. Detailed descriptions of the BIOS parameters are also provided.



ASUS AP1720-E2 barebone server

BIOS setup

5.1 Managing and updating your BIOS



-
- The **original BIOS file** for this motherboard is in the support CD.
 - Copy the original BIOS to a **bootable floppy disk** in case you need to restore the BIOS in the future.
-

5.1.1 Creating a bootable floppy disk

1. Do either one of the following to create a bootable floppy disk.

DOS environment

Insert a 1.44 MB floppy disk into the drive. At the DOS prompt, type:

format a: /s , then press the <Enter> key

Windows® XP environment

- a. Insert a new 1.44 MB floppy disk in the floppy disk drive.
 - b. From the Windows desktop, click **Start > My Computer**.
 - c. In the **My Computer** window, click the **3 1/2 Floppy** icon.
 - d. From the Menu bar, click **File > Format**.
 - e. Select “**Create an MS-DOS Startup Disk**” in the **Format Options** field, then click **Start**.
2. Copy the original (or the latest) motherboard BIOS to the bootable floppy disk.

5.1.2 AwardBIOS Flash Utility

Updating the BIOS

To update the BIOS using this utility.

1. Download the latest BIOS file from the ASUS web site. Rename the file to ***.BIN** and save it to a floppy disk.



Save only the updated BIOS file in the floppy disk to avoid loading the wrong BIOS file.

2. Copy the AwardBIOS Flash Utility (awdfash.exe) from the Software folder of the support CD to the floppy disk with the latest BIOS file.
3. Boot the system in DOS mode using the bootable floppy disk you created earlier.
4. When the **A:>** appears, replace the bootable floppy disk with the floppy disk containing the new BIOS file and the Award BIOS Flash Utility.
5. At the prompt, type **awdfash** then press <Enter>. The Award BIOS Flash Utility screen appears.

```
AwardBIOS Flash Utility for ASUS V1.06
(C) Phoenix Technologies Ltd. All Rights Reserved
For Canterwood - NCCH-DL          DATE: 06/01/2004
Flash Type - SST 49LF004A/B /3.3V
File Name to Program : 
Message: Please input File Name!
```

6. Type the BIOS file name in the **File Name to Program** field, then press <Enter>.

```
AwardBIOS Flash Utility for ASUS V1.06
(C) Phoenix Technologies Ltd. All Rights Reserved
For Canterwood - NCCH-DL          DATE: 06/01/2004
Flash Type - SST 49LF004A/B /3.3V
File Name to Program : 1001.bin
Message: Do You Want To Save BIOS (Y/N)
```

7. The utility prompts you to save the current BIOS file. Press <Y> to save the current BIOS file to the floppy disk, or <N> to continue.



If you wish to save the current BIOS file, make sure that the floppy disk has enough disk space to save the file. See the next section for details on saving the current BIOS file.

8. The utility verifies the BIOS file in the floppy disk and starts flashing the BIOS file.

```
AwardBIOS Flash Utility for ASUS V1.06
(C) Phoenix Technologies Ltd. All Rights Reserved
For Canterwood - NCCH-DL          DATE: 06/01/2004
Flash Type - SST 49LF004A/B /3.3V
File Name to Program : 1001.bin
Save current BIOS as :
Message:
```

- The utility displays a **Flashing Complete** message indicating that you have successfully flashed the BIOS file. Press <F1> to restart the system.

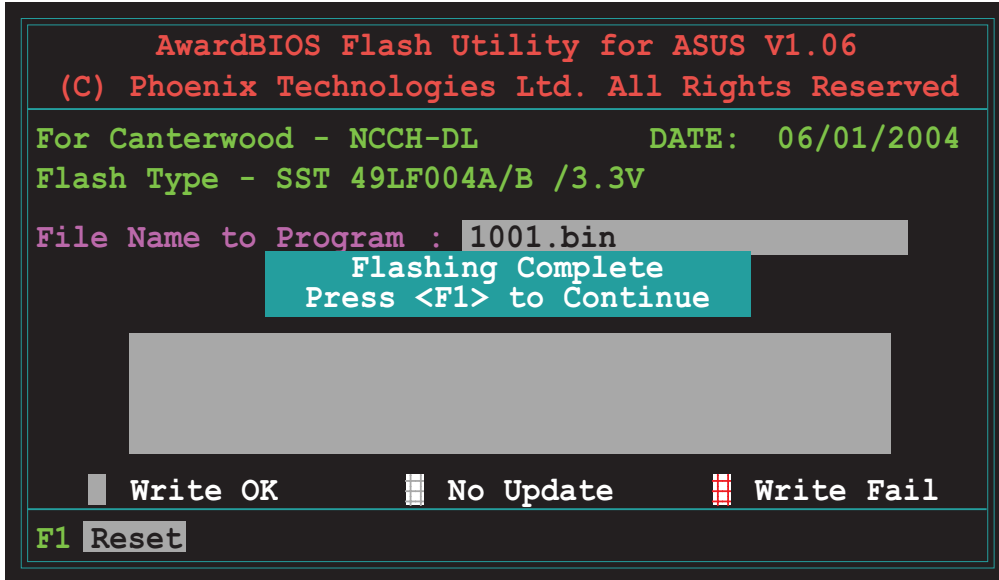

Saving the current BIOS file

The AwardBIOS Flash utility allows you to save your original or current BIOS to a floppy disk before you update. You can load the saved BIOS file if the new BIOS file gets corrupted during the flashing process.

To save the current BIOS file:

- Follow steps 1 to 6 of the previous section.
- Press <Y> when the utility prompts you to save the current BIOS file. The following screen appears.

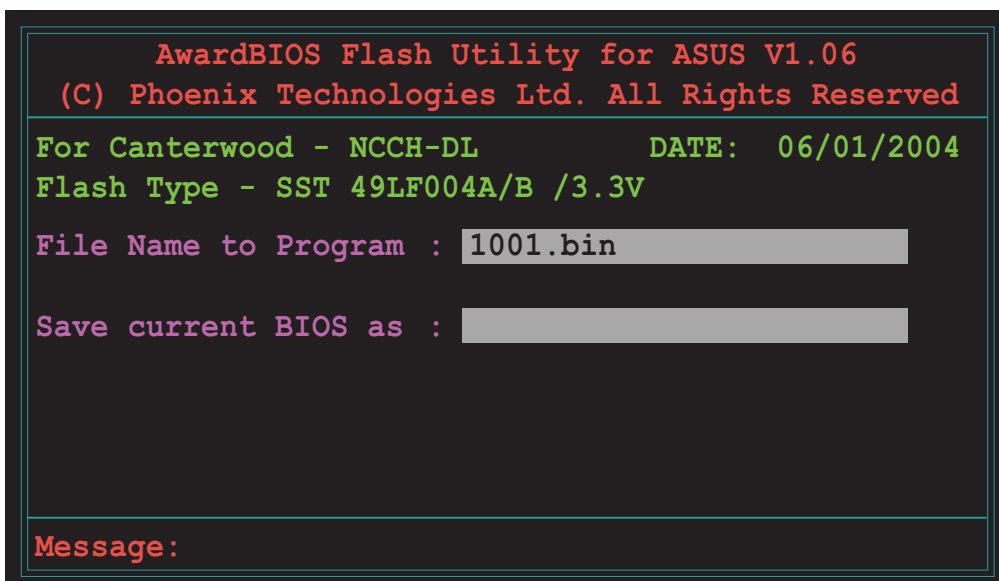

3. Type a filename for the current BIOS file in the **Save current BIOS as** field, then press <Enter>.

```
AwardBIOS Flash Utility for ASUS V1.06
(C) Phoenix Technologies Ltd. All Rights Reserved

For Canterwood - NCCH-DL          DATE: 06/01/2004
Flash Type - SST 49LF004A/B /3.3V

File Name to Program : 1001.bin
Checksum : DAD6H
Save current BIOS as : old.bin

Message: Please Wait!
```

4. The utility saves the current BIOS file to the floppy disk, then returns to the BIOS flashing process.

```
AwardBIOS Flash Utility for ASUS V1.06
(C) Phoenix Technologies Ltd. All Rights Reserved

For Canterwood - NCCH-DL          DATE: 06/01/2004
Flash Type - SST 49LF004A/B /3.3V

File Name to Program : 1001.bin
Now Backup System BIOS to
File!

Message: Please Wait!
```

5.1.3 ASUS EZ Flash Utility

The ASUS EZ Flash feature allows you to update the BIOS without having to go through the long process of booting from a floppy disk and using a DOS-based utility. The EZ Flash utility is built-in the BIOS chip so it is accessible by pressing <Alt> + <F2> during the Power-On Self Tests (POST).

To update the BIOS using EZ Flash:

1. Visit the ASUS website (www.asus.com) to download the latest BIOS file for the motherboard and rename the same to NCCH-DL.ROM.
2. Save the BIOS file to a floppy disk, then restart the system.
3. Press <Alt> + <F2> during POST to display the following.

```
EZFlash starting BIOS update
Checking for floppy...
```

4. Insert the floppy disk that contains the BIOS file to the floppy disk drive. When the correct BIOS file is found, EZ Flash performs the BIOS update process and automatically reboots the system when done.



A “Floppy not found!” error message appears if there is no floppy disk in the drive. A “NCCH-DL.ROM not found!” error message appears if the correct BIOS file is not found in the floppy disk. Make sure that you rename the BIOS file to NCCH-DL.ROM.

```
EZFlash starting BIOS update
Checking for floppy...
Floppy found!
Reading file "NCCH-DL.rom". Completed.
Start erasing.....|
Start programming...|
Flashed successfully. Rebooting.
```



Do not shutdown or reset the system while updating the BIOS to prevent system boot failure!

5.2 BIOS Setup program

This motherboard includes a Flash ROM that you can update using the provided utility described in section “5.1 Managing and updating your BIOS.”

Use the BIOS Setup program when you are installing a motherboard, reconfiguring your system, or prompted to “Run Setup”. This section explains how to configure your system using this utility.

Even if you are not prompted to use the Setup program, you may want to change the configuration of your computer in the future. For example, you may want to enable the security password feature or make changes to the power management settings. This requires you to reconfigure your system using the BIOS Setup program so that the computer can recognize these changes and record them in the CMOS RAM of the Flash ROM.

The Flash ROM on the motherboard stores the Setup utility. When you start up the computer, the system provides you with the opportunity to run this program. Press <Delete> during the Power-On Self Test (POST) to enter the Setup utility, otherwise, POST continues with its test routines.

If you wish to enter Setup after POST, restart the system by pressing <Ctrl> + <Alt> + <Delete>, or by pressing the reset button on the system chassis. You can also restart by turning the system off and then back on. Do this last option only if the first two failed.

The Setup program is designed to make it as easy to use as possible. It is a menu-driven program, which means you can scroll through the various sub-menus and make your selections among the predetermined choices.



Because the BIOS software is constantly being updated, the following BIOS setup screens and descriptions are for reference purposes only, and may not exactly match what you see on your screen.

5.2.4 General help

On the right side of the menu screen is a brief description of the selected item.

5.2.5 Sub-menu

An item with a sub-menu on any menu screen is distinguished by a solid triangle before the item. To display the sub-menu, select the item and press <Enter>.

5.2.6 Scroll bar

A scroll bar appears on the right side of a menu screen when there are items that do not fit on the screen. Press **Up/Down arrow keys** or **PageUp/PageDown keys** to display the other items on the screen.

5.2.7 Pop-up window

Select an item in the menu, then press <Enter> to display a pop-up window with the configuration options for that item.

5.3 Main menu

When you enter the BIOS Setup program, the Main menu screen appears giving you an overview of the basic system information.



Refer to section “5.2.1 BIOS menu screen” for information on the menu screen items and how to navigate through them.

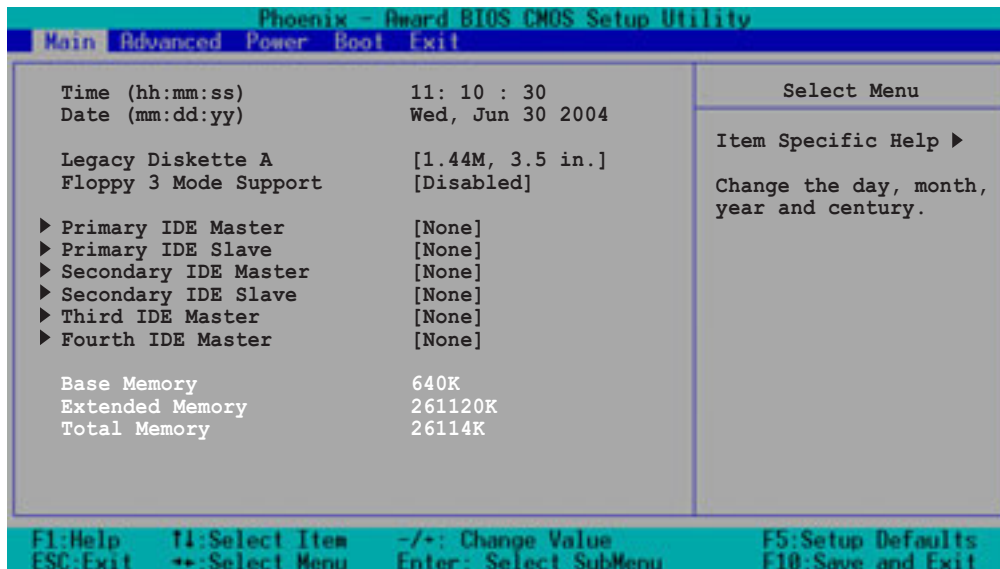

Time (hh:mm:ss)

Sets the system to the time that you specify (usually the current time). The format is hour:minute:second. Valid values for hour, minute, and second are Hour: (00 to 23), Minute: (00 to 59), Second: (00 to 59). Use the <Tab> key to move between the hour, minute, and second fields.

Date (mm:dd:yy)

Sets the system to the date that you specify (usually the current date). The format is month:day:year. Valid values for month, day, and year are Month: (Jan to Dec), Day: (1 to 31), Year: (1999 to 2099). Use the <Tab> key to move between the month, day, and year fields.

Legacy Diskette A [1.44M, 3.5 in.]

Sets the type of floppy drive installed. Configuration options: [None] [360K, 5.25 in.] [1.2M , 5.25 in.] [720K , 3.5 in.] [1.44M, 3.5 in.] [2.88M, 3.5 in.]

Floppy 3 Mode Support [Disabled]

This is required to support older Japanese floppy drives. The Floppy 3 Mode feature allows reading and writing of 1.2MB (as opposed to 1.44MB) on a 3.5-inch floppy disk. Configuration options: [Disabled] [Enabled]

Base/Extended/Total Memory [xxxK]

The base memory, extended memory, and total memory values are auto-detected. These fields are not user-configurable.

5.3.1 Primary IDE Master

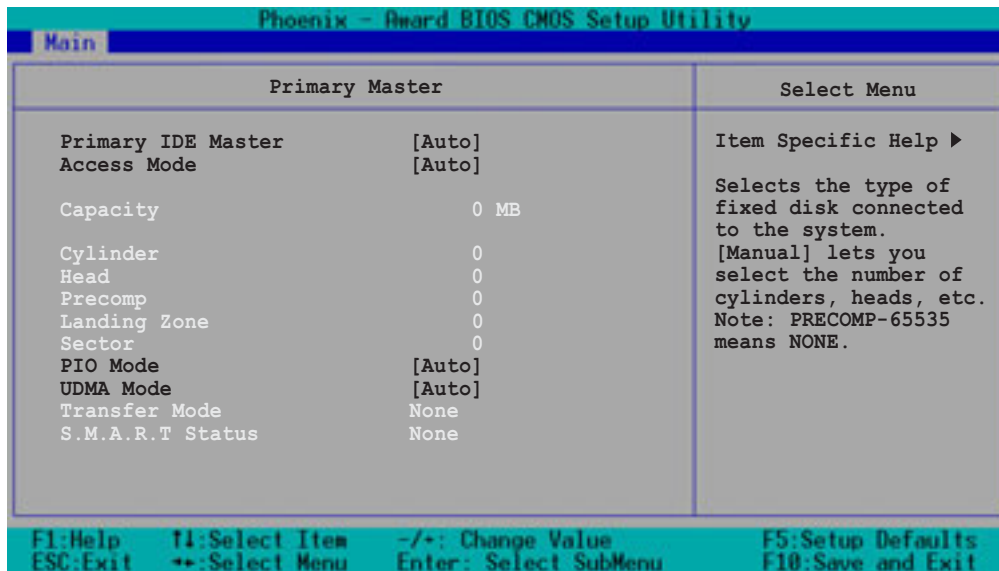

Primary IDE Master [Auto]

Select [Auto] to automatically detect an IDE drive. If automatic detection is successful, the setup BIOS automatically fills in the correct values for the remaining fields on this sub-menu.

If automatic detection fails, this may be because the IDE drive is too old or too new. If the drive was already formatted on a previous system, the BIOS may detect incorrect parameters. In these cases, select [Manual] to manually enter the IDE drive parameters. Refer to the section “Manually detecting an IDE drive.”

If no drive is installed or if you are removing a drive and not replacing it, select [None]. Configuration options: [None] [Auto] [Manual]

Access Mode [Auto]

Allows selection of the sector addressing mode. The default [Auto] allows automatic detection of an IDE drive. Configuration options: [CHS] [LBA] [Large] [Auto]



-
- Most of the IDE drive information items are grayed out when the items **Primary IDE Master** and **Access Mode** are set to [Auto].
 - If you wish to manually configure the IDE drive items, set the Primary IDE Master to [Manual], and the Access Mode to [CHS].
-

PIO Mode [Auto]

Sets the PIO mode for the IDE drive. The settings Mode 0 to 4 allow successive increase in performance. Configuration options: [Auto] [Mode 0] [Mode 1] [Mode 2] [Mode 3] [Mode 4]

UDMA Mode [Auto]

When this item is set to [Auto], the UDMA capability allows improved transfer speeds and data integrity for supported IDE drives. Configuration options: [Disabled] [Auto]

Manually detecting an IDE drive

If you wish to manually enter the drive information, set the Primary IDE Master item to [Manual], and the Access Mode item to [CHS].

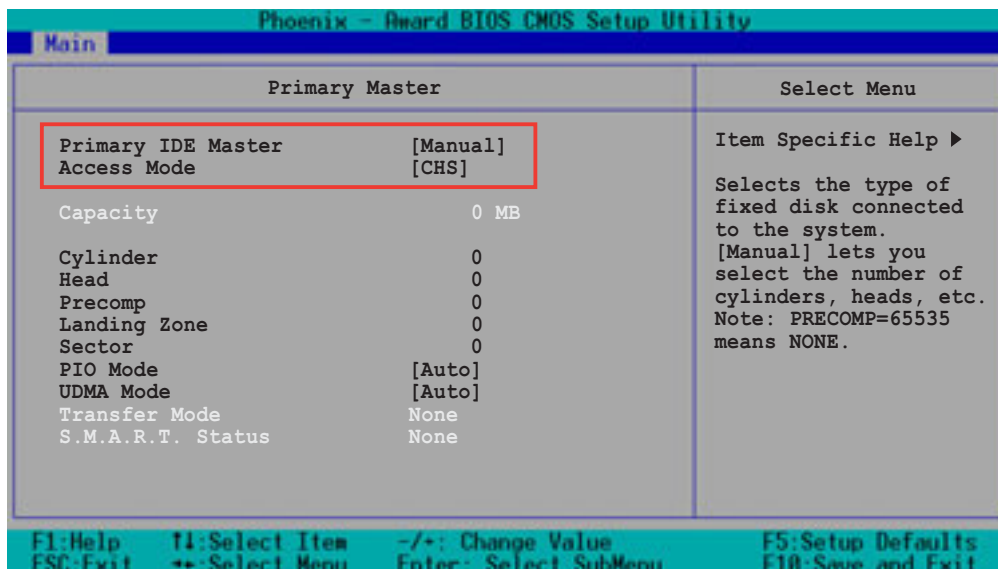

Before attempting to manually configure an IDE drive, make sure that you have the correct configuration information supplied by the drive manufacturer. Incorrect settings may cause the system to fail to recognize the installed IDE drive!

To manually enter the number of cylinder, head, precomp, landing zone, and sector per track for the drive, highlight an item, key-in the value that you obtained from the drive documentation, then press <Enter>. Refer to the drive documentation or the drive label for this information.

To enter a value, you may also highlight the item, then press <Enter> to display a pop-up menu. Type in the value from the drive documentation, then press <Enter>.

Capacity [xxxxx MB]

Displays the auto-detected hard disk capacity. The value is not user-configurable.

Cylinder

Shows the number of the hard disk cylinders.

Head

Shows the number of the hard disk read/write heads.

Precomp

Displays the precompressed volumes on the hard disk, if any, on the motherboard.

Landing Zone

Displays the drive's maximum usable capacity as calculated by the BIOS based on the drive information you entered.

Sector

Shows the number of sectors per track.

Transfer Mode

Shows the data transfer mode if the IDE hard disk drive supports the feature. Otherwise, this item is grayed out and shows the value [None].

S.M.A.R.T. Status

Shows the Smart Monitoring, Analysis, and Reporting Technology (S.M.A.R.T.) status if the IDE hard disk drive supports the feature. Otherwise, this item is grayed out and shows the value [None].



After entering the IDE hard disk drive information, use a disk utility, such as FDISK, to partition and format new IDE drives. This is necessary so that you can write or read data from the hard disk. Make sure to set the partition of the Primary IDE hard disk drive to "Active."

5.3.2 Primary IDE Slave

When configuring a drive as **Primary IDE Slave**, refer to section "5.3.1 Primary IDE Master" for the menu item descriptions.

5.3.3 Secondary IDE Master

When configuring a drive as **Secondary IDE Master**, refer to section "5.3.1 Primary IDE Master" for the menu item descriptions.

5.3.4 Secondary IDE Slave

When configuring a drive as **Secondary IDE Slave**, refer to section "5.3.1 Primary IDE Master" for the menu item descriptions.

5.3.5 Third IDE Master

When configuring a drive as **Third IDE Master**, refer to section “4.3.1 Primary IDE Master” for the menu item descriptions which are not discussed in this section.

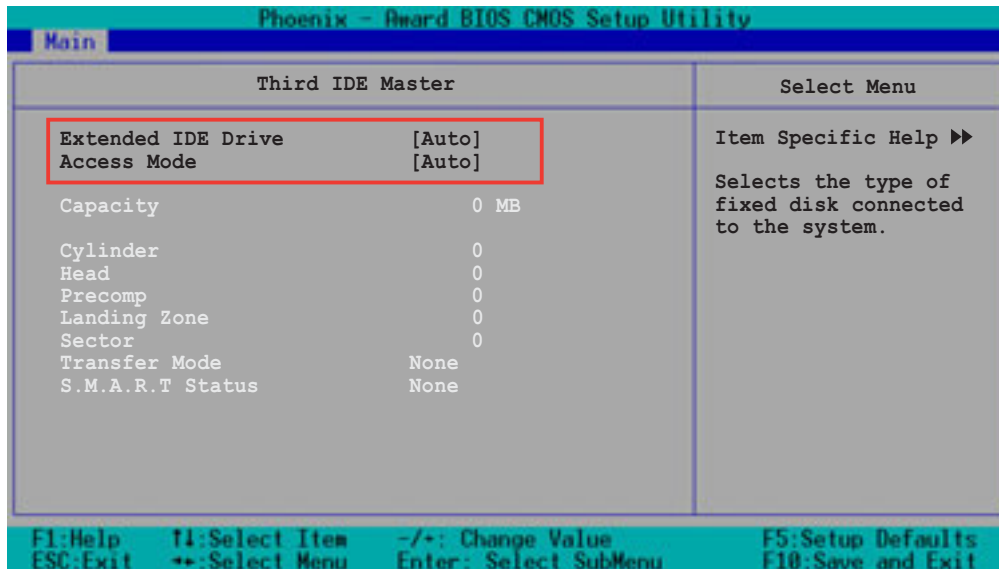

Extended IDE Drive [Auto]

When set to [Auto], allows automatic selection of the extended IDE drive installed, if any. Set this item to [None] if there is no extended IDE drive, or if you do not wish to detect the drive even if installed. Configuration options: [None] [Auto]

Access Mode [Auto]

Configuration options: [Large] [Auto]

5.3.6 Fourth IDE Master

When configuring a drive as **Fourth IDE Master**, refer to section “4.3.1 Primary IDE Master” and section “5.3.5 Third IDE Master” for the menu item descriptions.



The items **Third IDE Master** and **Fourth IDE Master** appear only if you set the **On-Chip Serial ATA** item in SATA Configuration menu to either [Auto] or [Enhanced Mode]. See page 5-26 for information.

5.4 Advanced menu

The Advanced menu items allow you to change the settings for the CPU, memory, chipset, and other system devices.



Take caution when changing the settings of the Advanced menu items. Incorrect field values may cause the system to malfunction!

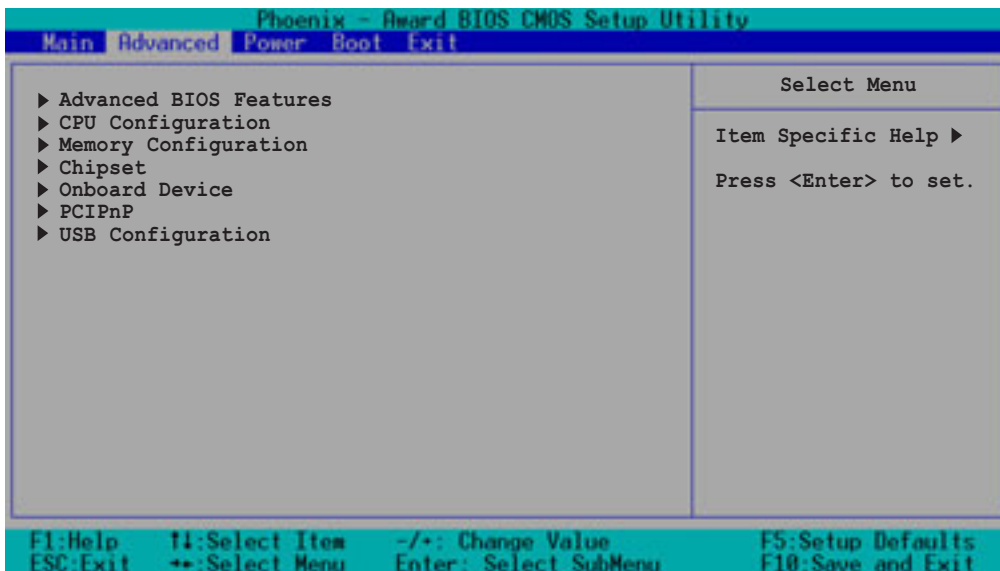

5.4.1 Advanced BIOS Features

This menu shows the chipset and DRAM Vcore voltage settings. Select an item then press <Enter> to display a pop-up menu with the configuration options.

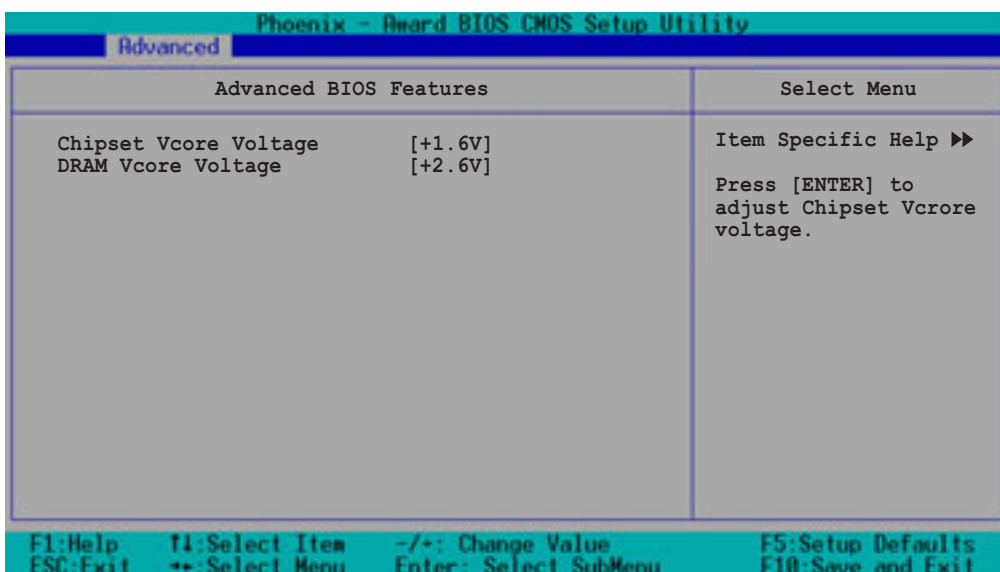



Setting to very high Vcore voltages may cause the system to become unstable!

Chipset Vcore Voltage [+1.6V]

Allows adjustment of the chipset Vcore voltage.
Configuration options: [+1.5V] [+1.6V] [+1.7V] [+1.8V]

DRAM Vcore Voltage [+2.6V]

Allows adjustment of the DRAM Vcore voltage.
Configuration options: [+2.8V] [+2.7V] [+2.6V]

5.4.2 CPU Configuration

This menu shows the CPU configuration settings. Select an item then press <Enter> to display a pop-up menu with the configuration options.

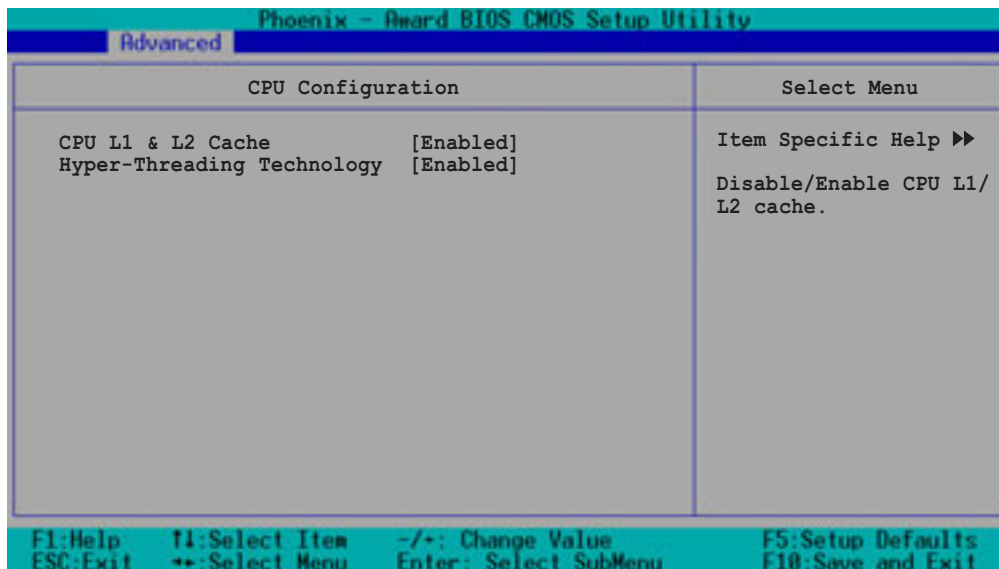

CPU L1 & L2 Cache [Enabled]

Allows you to enable or disable the CPU L1 and L2 cache.
Configuration options: [Disabled] [Enabled]

Hyper-Threading Technology [Enabled]

Allows you to enable or disable the CPU Hyper-Threading Technology feature. Set this item to [Enabled] if you are using an operating system that is optimized for Hyper-Threading Technology, such as Windows XP or Linux kernel later than version 2.4. Otherwise, set this item to [Disabled].
Configuration options: [Disabled] [Enabled]

5.4.3 Memory Configuration

This menu shows the memory configuration settings. Select an item then press <Enter> to display a pop-up menu with the configuration options.

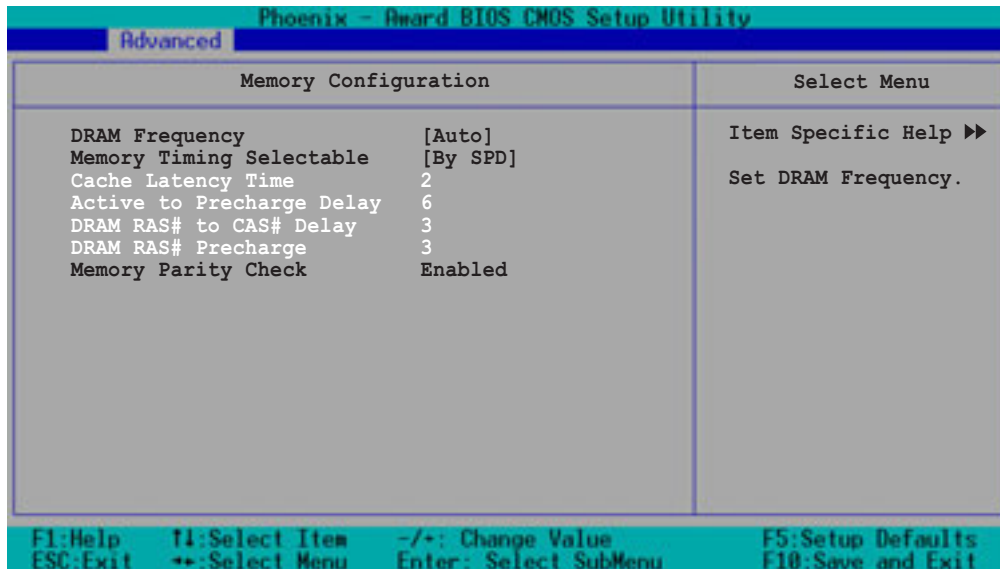

DRAM Frequency [Auto]

This item sets the DRAM operating frequency.

Configuration options: [DDR266] [DDR333] [DDR400] [Auto]

Memory Timing Selectable [By SPD]

The DRAM clock are set according to the DRAM SPD (Serial Presence Detect). Select [By SPD] for automatic DRAM clock detection. Select [Manual] to allow setting the succeeding memory items to optimal timings.

Configuration options: [Manual] [By SPD]



The items CAS Latency Time, Active to Precharge Delay, DRAM RAS# to CAS# Delay, and DRAM RAS# Precharge are configurable only when the Memory Timing Selectable item is set to [Manual].

CAS Latency Time [2]

This item sets the latency (in clocks) between the DRAM read command and the time the data actually becomes available.

Configuration options: [2] [2.5] [3]

Active to Precharge Delay [6]

This item controls the number of DRAM clocks used for DRAM parameters. Configuration options: [8] [7] [6] [5]

DRAM RAS# to CAS# Delay [3]

Controls the latency between the DRAM active command and the read/write command. Configuration options: [4] [3] [2]

DRAM RAS# Precharge [3]

This item controls the idle clocks after issuing a precharge command to the DDR SDRAM. Configuration options: [4] [3] [2]

Memory Parity Check [Enabled]

Allows memory parity checking option ECC (Error-Correcting Code). Configuration options: [Disabled] [Enabled]

5.4.4 Chipset

This menu shows the chipset configuration settings. Select an item then press <Enter> to display a sub-menu with additional items, or show a pop-up menu with the configuration options.

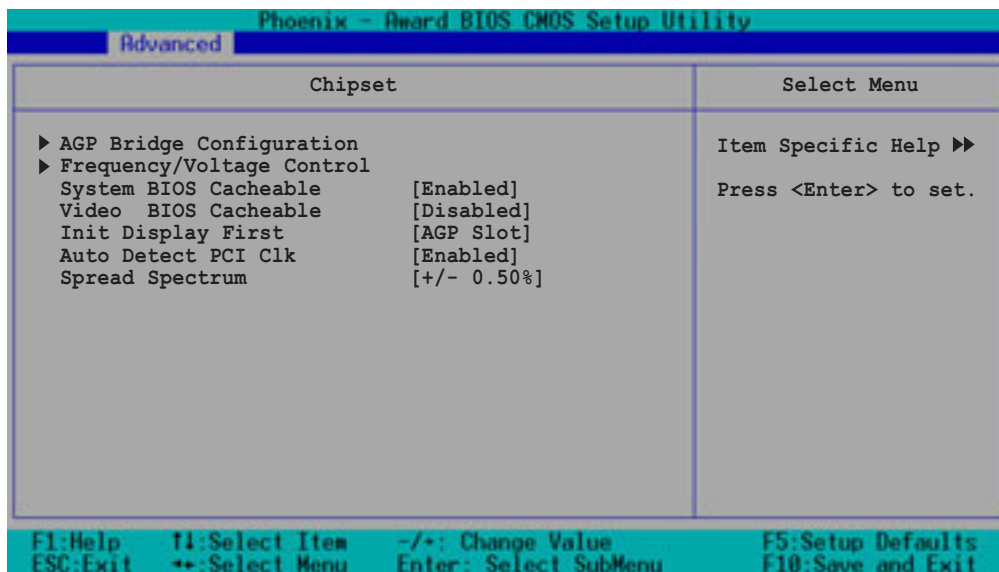

System BIOS Cacheable [Enabled]

Allows you to enable or disable the cache function of the system BIOS. Configuration options: [Disabled] [Enabled]

Video BIOS Cacheable [Disabled]

Allows you to enable or disable the cache function of the video BIOS. Setting to [Enabled] improves the display speed by caching the display data. Configuration options: [Disabled] [Enabled]

Init Display First [AGP Slot]

Allows you to select the graphics controller to use as primary boot device.
Configuration options: [PCI VGA Card] [AGP Slot]

Auto Detect PCI Clk [Enabled]

Allows you to select the maximum PCI bus speed to be programmed.
Configuration options: [Enabled] [Disabled]

Spread Spectrum [- 0.50%]

Allows you to select the clock generator spread spectrum. Configuration options: [Disabled] [+/- 0.1%] [+/- 0.2%] [+/- 0.3%] [+/- 0.4%] [+/- 0.5%] [+/- 0.6%] [+/- 0.7%] [+/- 0.8%] [+/- 0.9%] [+/- 1.0%]

AGP Bridge Configuration

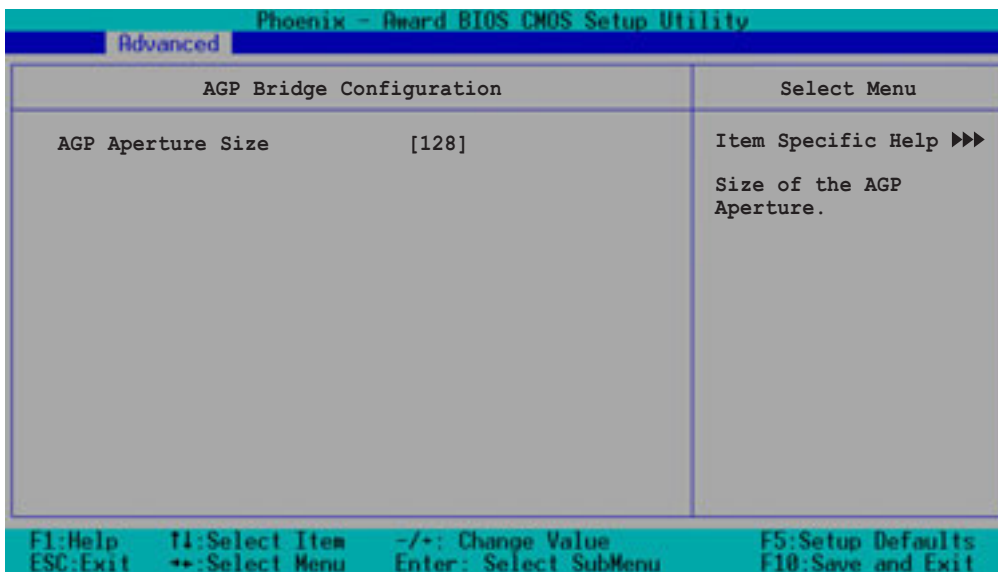

AGP Aperture Size [128]

Allows you to select the size of mapped memory for AGP graphic data.
Configuration options: [4] [8] [16] [32] [64] [128] [256]

Frequency/Voltage Control

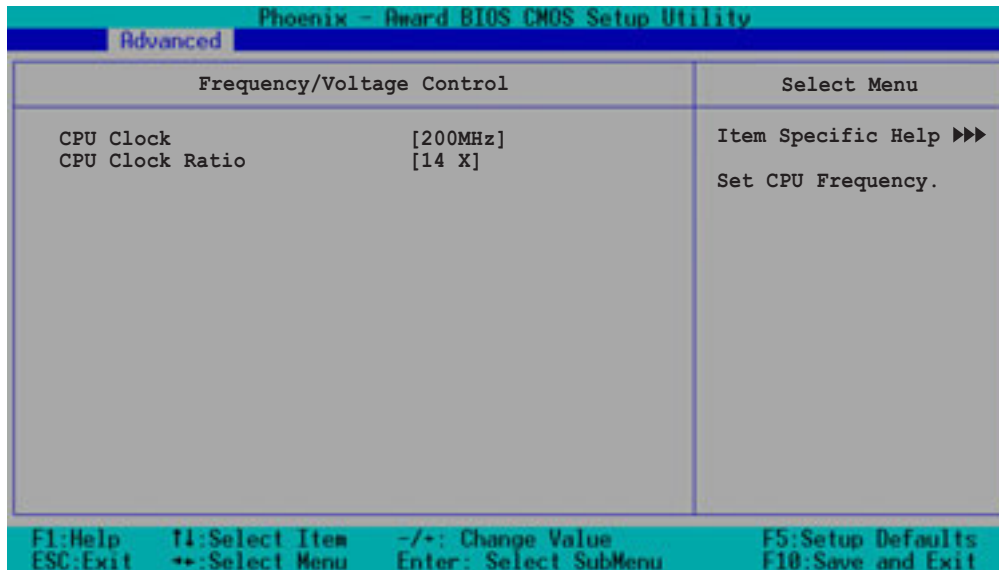

Take caution when overclocking the CPU. Overclocking may cause the system to become unstable!

CPU Clock [200MHz]

Allows you to set the CPU frequency. Key-in a value within the specified range, then press <Enter>. Configuration options: [Min=200] [Max=233]



The minimum and maximum configuration values for the **CPU Clock** depend on the installed CPU. These values are detected by BIOS.

CPU Clock Ratio [18 X]

Sets the ratio between the CPU core clock and the Front Side Bus (FSB) frequency. Key-in a value within the specified range, then press <Enter>. Configuration options: [Min=12] [Max=18]



The minimum and maximum configuration values for the **CPU Clock Ratio** depend on the installed CPU. These values are detected by BIOS.

5.4.5 Onboard Device

This menu shows the onboard device configuration settings. Select an item then press <Enter> to display a sub-menu with additional items, or show a pop-up menu with the configuration options.

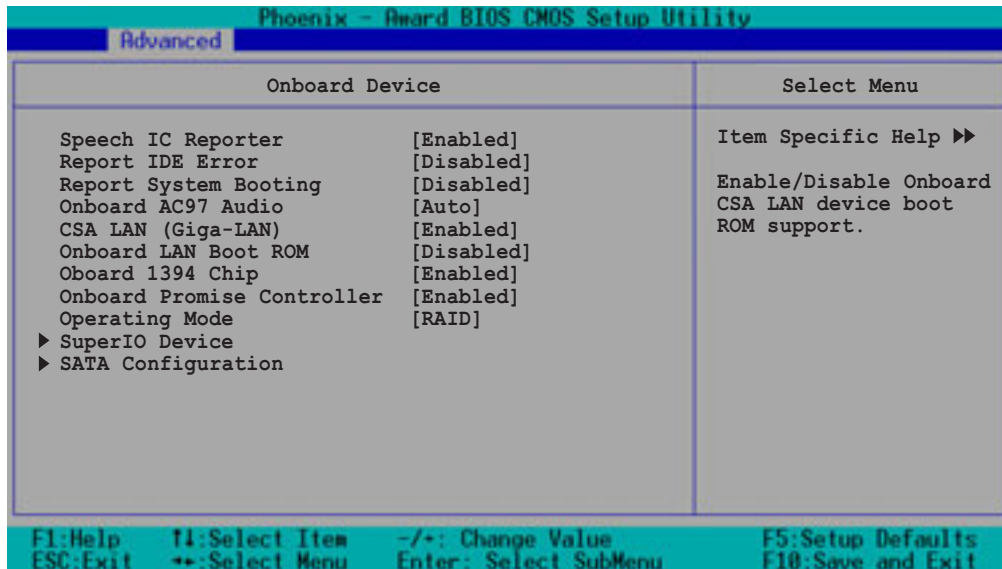

Speech IC Reporter [Enabled]

Allows you to enable or disable the onboard speech controller.
Configuration options: [Disabled] [Enabled]

Report IDE Error [Disabled]

Allows you enable or disable reporting of IDE errors, if any.
Configuration options: [Disabled] [Enabled]

Report System Booting [Disabled]

Allows you enable or disable reporting of system boot errors, if any.
Configuration options: [Disabled] [Enabled]

Onboard AC97 Audio [Auto]

Allows you enable or disable the onboard AC97 audio controller.
Configuration options: [Auto] [Enabled]

CSA LAN (Giga-LAN) [Enabled]

Allows you enable or disable the onboard Gigabit LAN controller.
Configuration options: [Disabled] [Enabled]

Onboard LAN Boot ROM [Disabled]

Allows you to enable or disable the onboard LAN device boot ROM.
Configuration options: [Disabled] [Enabled]

Onboard 1394 [Enabled]

Allows you to enable or disable the onboard IEEE 1394 controller.
Configuration options: [Disabled] [Enabled]

Onboard Promise Controller [Enabled]

Allows you to enable or disable the onboard Promise® RAID controller.

Operating Mode [IDE]

Allows you to set the RAID controller operating mode. This item is configurable only when the **Onboard Promise Controller** item is set to [Enabled]. Configuration options: [IDE] [RAID]

SuperIO Device

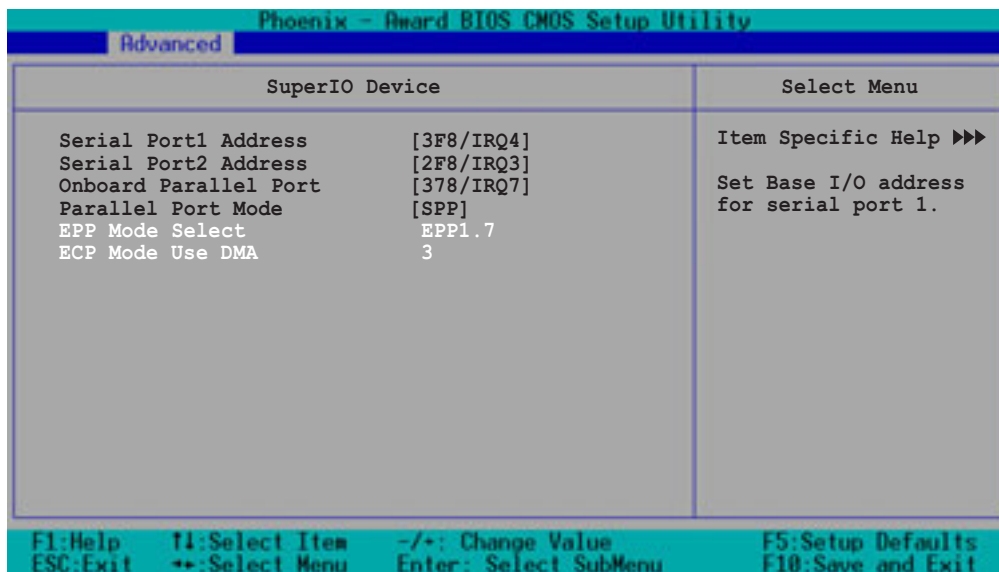

Serial Port 1 Address [3F8/IRQ4]

Serial Port 2 Address [2F8/IRQ3]

Allow you to select the serial port base addresses. Configuration options: [Disabled] [3F8/IRQ4] [2F8/IRQ3] [3E8/IRQ4] [2E8/IRQ3] [Auto]

Onboard Parallel Port [378/IRQ7]

Allows you to select the parallel port base address.

Configuration options: [Disabled] [378/IRQ7] [278/IRG5] [3BC/IRQ7]

Parallel Port Mode [SPP]

Allows you to select the parallel port mode.

Configuration options: [SPP] [EPP] [ECP] [ECP+EPP] [Normal]

EPP Mode Select [EPP1.7]

Allows you to select the EPP mode. This item becomes configurable only if the **Parallel Port Mode** is set to [EPP] or [ECP+EPP].

Configuration options: [EPP 1.7] [EPP 1.9]

ECP Mode Use DMA [3]

Allows you to select the ECP mode. This item becomes configurable only if the **Parallel Port Mode** is set to [ECP] or [ECP+EPP].

Configuration options: [1] [3]

Game Port Address [201]

Allows you to select the game port address.

Configuration options: [Disabled] [201] [209]

MIDI Port Address [330]

Allows you to select the MIDI port address.

Configuration options: [Disabled] [201] [209]

MIDI Port IRQ [10]

Allows you to select the MIDI port IRQ.

Configuration options: [Disabled] [5] [10]

SATA Configuration

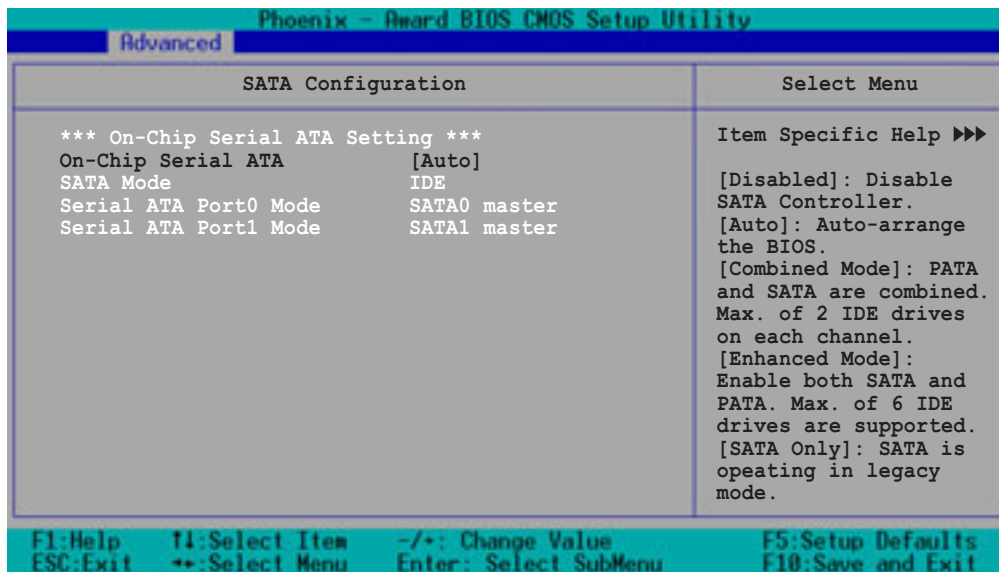

**On-Chip Serial ATA Setting



The items **SATA Mode**, **Serial ATA Port0 Mode**, and **Serial ATA Port1 Mode** are not configurable when the On-Chip Serial ATA item is set to [Disabled].

On-chip Serial ATA [Auto]

This item allows you to configure your serial ATA devices if present. Configuration options: [Disabled] [Auto] [Combined Mode] [Enhanced Mode] [SATA Only]



Setting the **On-chip Serial ATA** item to [Auto] or [Enhanced Mode] enables the items **Third IDE Master** and **Fourth IDE Master** in the Main menu. See page 4-14 for more information.

- Setting to [**Auto**] allows BIOS to automatically configure the SATA devices.
- Setting to [**Combined Mode**] allows you to install parallel ATA and serial ATA devices at the same time. You may install **two IDE devices on any of the parallel ATA channels**, and **one IDE device on each serial ATA channel** for a maximum of **four** devices.
- Setting to [**Enhanced Mode**] allows you to install Parallel ATA and Serial ATA devices at the same time, with a maximum of **six** IDE devices on each channel.



-
1. Use the [Enhanced Mode] option if you installed a native operating system like Winows 2000/XP.
 2. You may not use this option if you are using Linux RedHat 8 or 9 version operating system, as they do not support native mode.
-

- d. Setting to [**SATA Only**] allows you to install IDE devices on the Serial ATA channels only.
- e. Setting to [**Disabled**] disables the onboard SATA controller. The RAID feature is also disabled.

SATA Mode [IDE]

When this item is set to [IDE], SATA operates in IDE mode. When set to [RAID], SATA operates in RAID mode. The RAID feature allows configuration of the installed IDE devices into a disk array.

Configuration options: [IDE] [RAID]

Serial ATA Port0 Mode [SATA0 Master]

Serial ATA Port1 Mode [SATA1 Master]

Allow you to set the SATA Port0 and Serial ATA Port1 modes. The options for these items vary depending on the setting of the **On-Chip Serial ATA** item. Configuration options: [Primary Master] [Primary Slave]

[Secondary Master] [Secondary Slave] [SATA0 Master] [SATA1 Master]

5.4.6 PCIPnP

This menu shows the PCIPnP configuration settings. Select an item then press <Enter> to display a pop-up menu with the configuration options.

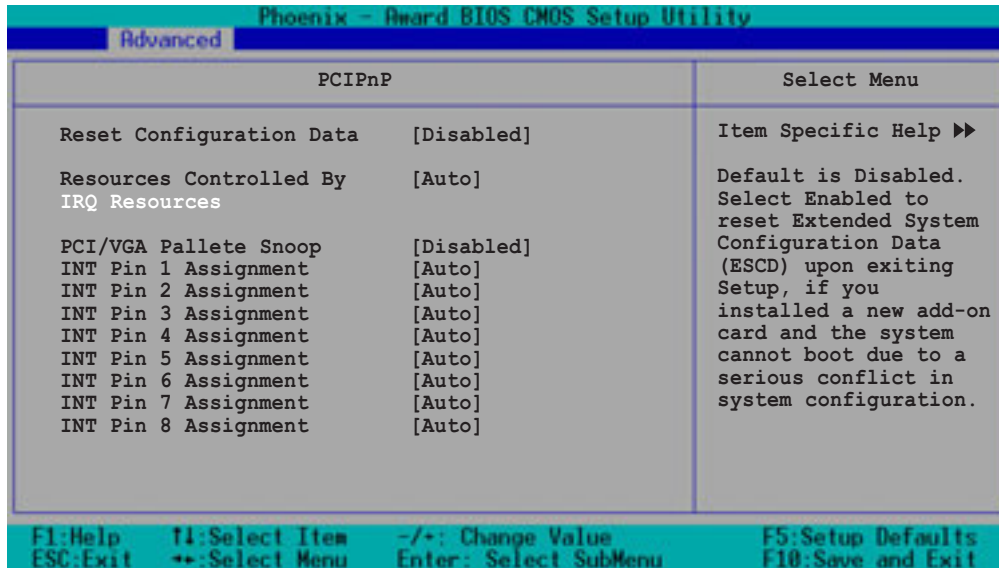

Reset Configuration Data [Disabled]

Allows you to enable or disabled resetting of the Extended System Configuration Data (ESCD) when you exit the Setup. The ESCD includes information on non-PnP devices. Set this item to [Enabled] if you installed an expansion card that conflicts with other devices and cause system boot failure. Configuration options: [Disabled] [Enabled]

Resources Controlled By [Auto]

When set to [Auto], allows BIOS to automatically configure of all boot and Plug and Play devices. When set to [Manual], you can assign the available IRQ Resources to the PCI devices. Configuration options: [Auto] [Manual]



When the item **Resources Controlled By** is set to [Auto], the item IRQ Resources is grayed out and not user-configurable. Refer to the section “IRQ Resources” for information on how to enable this item.

PCI/VGA Pallette Snoop [Disabled]

Some non-standard VGA cards, like graphics accelerators or MPEG video cards, may not show colors properly. Setting this field to [Enabled] corrects this problem. If you are using a standard VGA card, leave this field to the default setting [Disabled]. Configuration options: [Disabled] [Enabled]

INT Pin 1~8 Assignment [Auto]

Allows you to select the appropriate interrupt to the specific devices to avoid conflict. Configuration options: [Auto] [3] [4] [5] [7] [9] [10] [11] [12] [14] [15]

IRQ Resources



Set the item **Resources Controlled By** to [Manual] to enable the item **IRQ Resources** and assign the interrupts depending on the type of installed PCI devices.

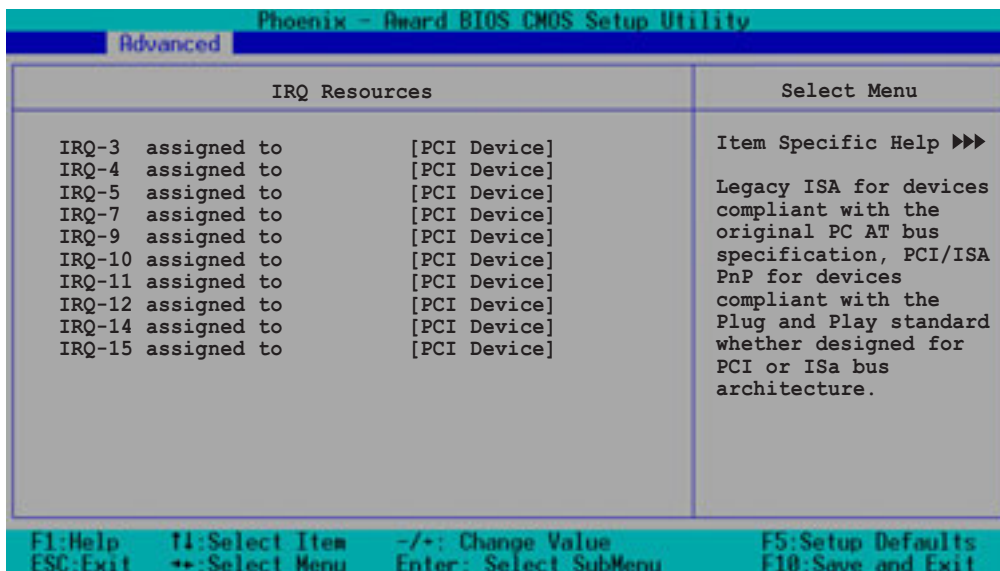
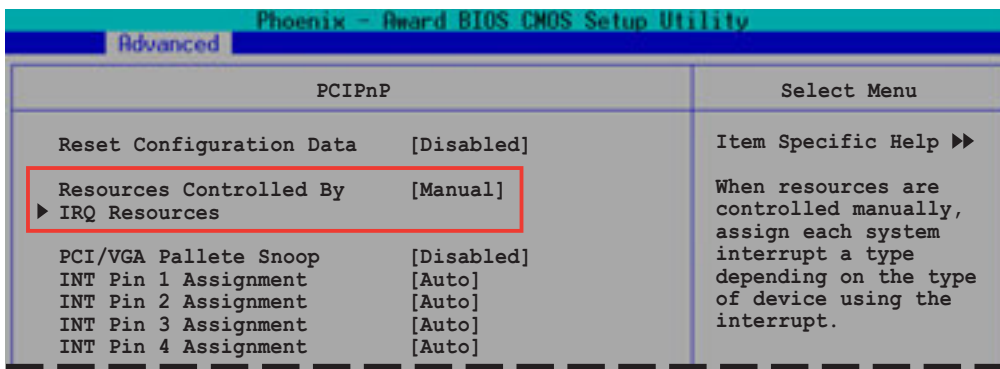

IRQ-xx assigned to [PCI device]

The IRQ Resources sub-menu is activated when the Resources Controlled by parameter is set to [Manual]. Select [PCI Device] to assign an IRQ address to a Plug and Play device. Setting to [Reserved] reserves the IRQ address. Configuration options: [PCI Device] [Reserved]

5.4.7 USB Configuration

This menu shows the USB configuration settings. Select an item then press <Enter> to display a pop-up menu with the configuration options.

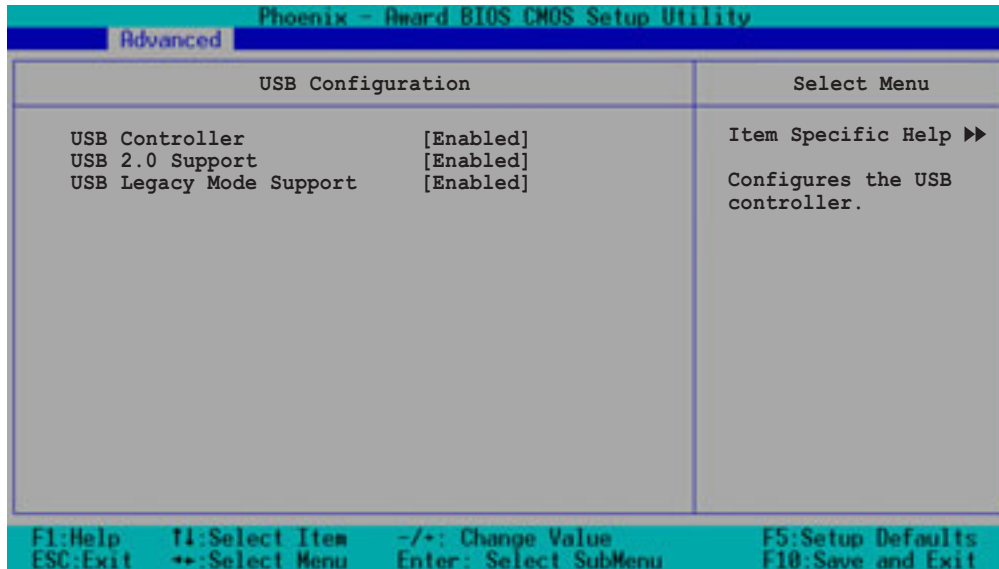

USB Controller [Enabled]

Allows you enable or disable the USB controller. Configuration options: [Disabled] [Enabled]

USB 2.0 Support [Enabled]

Allows you to enable or disable the EHCI controller. Setting this item to [Enabled] allows the built-in high speed USB support in the BIOS to turn on automatically when you install high speed USB devices. Configuration options: [Disabled] [Enabled]

USB Legacy Mode Support [Enabled]

Allows you enable or disable support for the legacy USB devices. Configuration options: [Disabled] [Enabled]

5.5 Power menu

The Power menu items allow you to change the power management settings. Select an item then press <Enter> to display the configuration options.

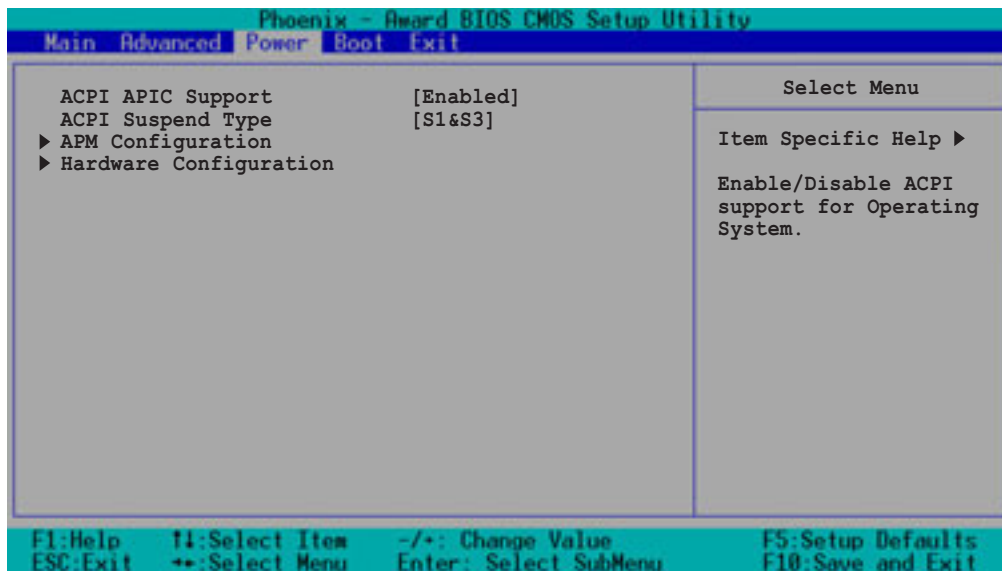

ACPI APIC Support [Enabled]

Allows you to enable or disable the ACPI feature on the operating system. Configuration options: [Disabled] [Enabled]

ACPI Suspend Type [S1&S3]

Allows you to select the ACPI state that you wish to use for system suspend. Configuration options: [S1(POS)] [S3(STR)] [S1&S3]

5.5.1 APM Configuration

This menu shows the Advanced Power Management (APM) configuration settings. Select an item then press <Enter> to display a pop-up menu with the configuration options.

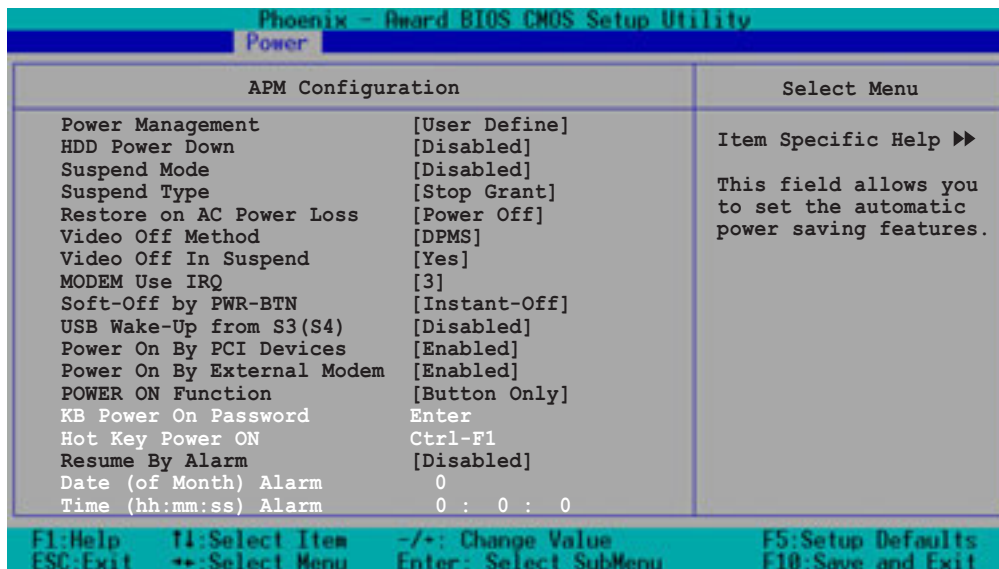

Power Management [User Define]

Allows you to set the automatic power saving features.

Configuration options: [User Define] [Min. Saving] [Max. Saving]

HDD Power Down [Disabled]

Shuts down any IDE hard disk drives in the system after a period of inactivity as set in this field. This feature does not affect SCSI hard drives.

Configuration options: [Disabled] [1 Min] ... [15 Min]

Suspend Mode [Disabled]

Sets the time period before the system goes into suspend mode.

Configuration options: [Disabled] [1 Min] [2 Min] [4 Min] [8 Min] [12 Min] [20 Min] [30 Min] [40 Min] [1 Hr]

Suspend Type [Stop Grant]

Allows you to select the suspend type.

Configuration options: [Stop Grant] [PwrOn Suspend]

Restore on AC Power Loss [Power Off]

When set to [Power Off], the system goes into "off state" after an AC power interruption. When set to [Power On], the system turns on automatically after an power interruption. When set to [Last State], the system goes into whatever was the system state (on or off) before the power interruption.

Configuration options: [Power Off] [Power On] [Last State]

Video Off Method [DPMS]

This item determines the video off features. The Display Power Management System (DPMS) feature allows the BIOS to control the video display card if it supports the DPMS feature. [Blank Screen] only blanks the screen. Use this for monitors without power management or “green” features. Configuration options: [Blank Screen] [V/H SYNC+Blank] [DPMS]

Video Off In Suspend [Yes]

This item determines when to activate the video off feature for monitor power management. Configuration options: [Yes] [No]

MODEM Use IRQ [3]

Allows you to select the IRQ assignment for the modem. Configuration options: [NA] [3] [4] [5] [7] [9] [10] [11]

Soft-Off by PWR-BTTN [Instant-Off]

When set to [Instant-Off], the system goes to soft off when you press the power button for **less** than 4 seconds. When set to [Delay 4 Sec], press the power button for **more** than 4 seconds to power off the system. Configuration options: [Instant-Off] [Delay 4 Sec.]

USB Wake-Up from S3(S4) [Disabled]

Allows you to enable or disable system wake-up from S3 or S4 state through a USB keyboard/mouse event. Configuration options: [Disabled] [Enabled]

Power On By PCI Devices [Enabled]

Allows you to enable or disable the PME to generate a wake-up event. Configuration options: [Disabled] [Enabled]

Power On By External Modem [Enabled]

Allows you to enable or disable system power up when the external modem receives a call while in soft-off mode. Configuration options: [Disabled] [Enabled]

Power On Function [BUTTON ONLY]

Allows you to select a device to turn the system power on. Configuration options: [Password] [Hot Key] [Mouse Left] [Mouse Right] [Any KEY] [BUTTON ONLY] [PS/2 Mouse]

KB Power On Password [Enter]

Allows you to set a password to turn the system power on. Highlight this item then press enter to set a password.



To configure this item, you should set the **Power On Function** item to [Password].

Hot Key Power On [Ctrl-F1]

Allows you to set a hot key combination to turn the system power on. Configuration options: [Ctrl-F1] ... [Ctrl-F12]



To configure this item, you should set the **Power On Function** item to [Hot Key].

Resume by Alarm [Disabled]

Allows you to enable or disable RTC to generate a wake event. When this item is enabled, you can set the date and time of alarm using the two following items. Configuration options: [Disabled] [Enabled]

Date (of Month) Alarm [0]

To set the date of alarm, highlight this item and press <Enter> to display a pop-up menu. Key-in a value within the specified range then press <Enter>. Configuration options: [Min=0] [Max=31]

Time (hh:mm:ss) Alarm [0 : 0 : 0]

To set the time of alarm:

1. Highlight this item and press <Enter> to display a pop-up menu for the hour field.
2. Key-in a value (Min=0, Max=23), then press <Enter>.
3. Press tab to move to the minutes field, then press <Enter>.
4. Key-in a minute value (Min=0, Max=59), then press <Enter>.
5. Press tab to move to the seconds field, then press <Enter>.
6. Key-in a value (Min=0, Max=59), then press <Enter>.

5.5.2 Hardware Monitor

This menu shows the hardware monitoring status. Select an item, then press <Enter> to display a pop-up menu with the configuration options.

Hardware Monitor	Select Menu
▶ Voltage Monitor	Item Specific Help >>
System Temperature1	39°C/102°F
CPU1 Temperature	45°C/113°F
CPU2 Temperature	N/A
Front Fan1 Speed	0 RPM
CPU Fan1 Speed	5152 RPM
CPU Fan2 Speed	0 RPM
Front Fan2 Speed	0 RPM
Rear Fan1 Speed	0 RPM
Rear Fan2 Speed	0 RPM

F1:Help F4:Select Item -/+ : Change Value F5:Setup Defaults
ESC:Exit <+>:Select Menu Enter: Select SubMenu F10:Save and Exit



The CPU temperatures and fan speeds are auto-detected.

Voltage Monitor

Voltage Monitor	Select Menu
CPU VCORE A (V)	1.45V
+12V Voltage	11.79V
+3.3V Voltage	3.26V
+5VCC Voltage	4.96V
VBAT Voltage	3.10V
+5VSB Voltage	4.75V

F1:Help F4:Select Item -/+ : Change Value F5:Setup Defaults
ESC:Exit <+>:Select Menu Enter: Select SubMenu F10:Save and Exit

CPU VCORE Voltage, +12V Voltage, +3.3V Voltage, +5VCC Voltage, VBAT Voltage, +5VSB Voltage

Auto-detected voltages through the onboard voltage regulators.

Smart Q-Fan Configuration

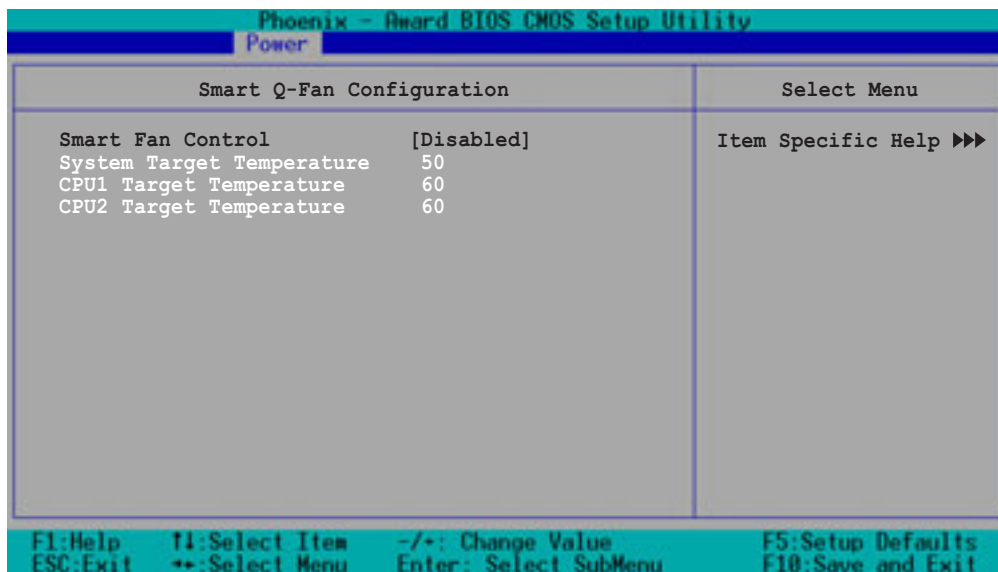

Smart Fan Control [Disabled]

Allows you to enable or disable the Smart Fan feature. Configuration options: [Disabled] [Enabled]



1. The **System/CPU1/CPU2 Target Temperature** items become configurable only when you set Smart Fan Control to [Enabled].
2. When the actual system/CPU1/CPU2 temperature becomes equal to the target temperature set in the following fields, the respective fan will run at full speed.

System Target Temperature [50]

Allows you to set the target temperature for the system. Configuration options: [Min=20] [Max=50]

CPU1 Target Temperature [60]

Allows you to set the target temperature for CPU1. Configuration options: [Min=30] [Max=60]

CPU2 Target Temperature [60]

Allows you to set the target temperature for CPU1. Configuration options: [Min=30] [Max=60]

5.6 Boot menu

The Boot menu items allow you to change the system boot settings. Select an item then press <Enter> to display a sub-menu with additional items, or show a pop-up menu with the configuration options.

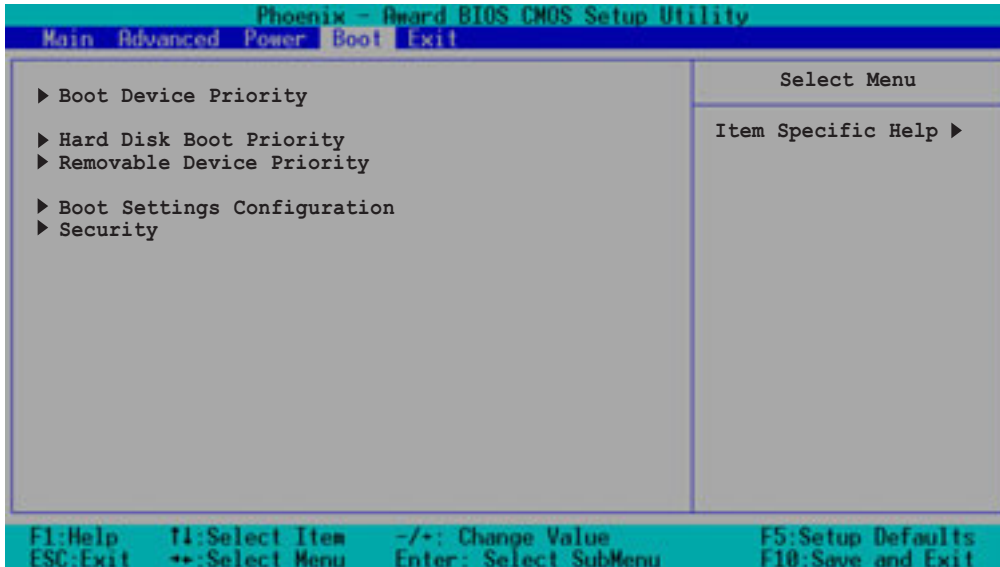

5.6.1 Boot Device Priority

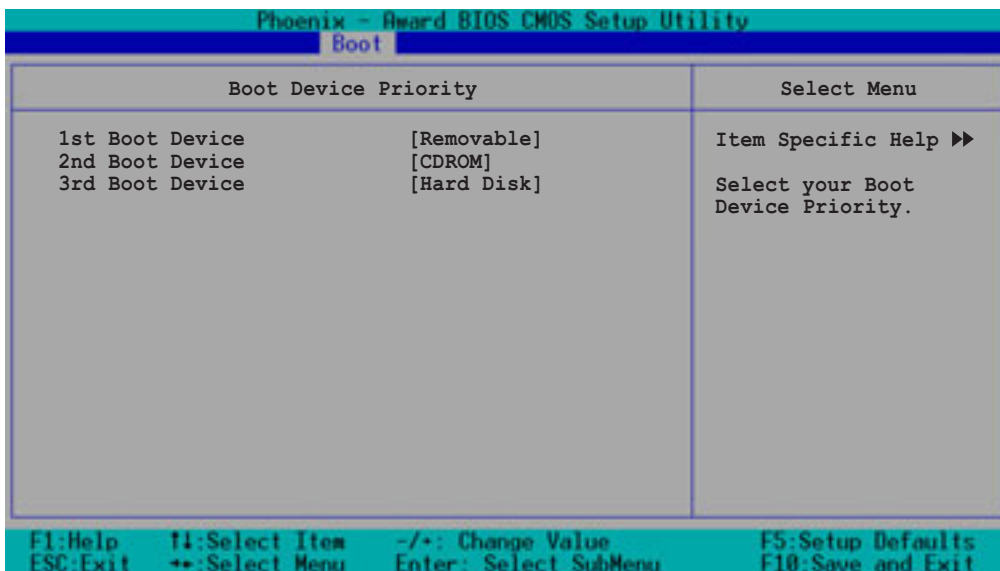

1st Boot Device [Removable]

2nd Boot Device [CDROM]

3rd Boot Device [Hard Disk]

These items allow you to select your boot device priority. Configuration options: [Removable] [Hard Disk] [CDROM] [Legacy LAN] [Disabled]

5.6.2 Hard Disk Boot Priority

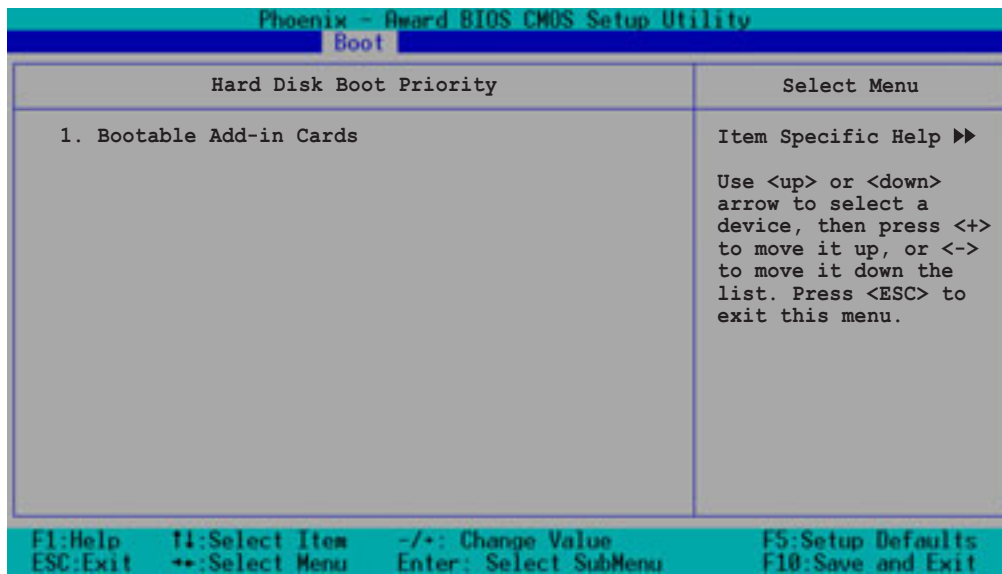

5.6.3 Removable Device Priority

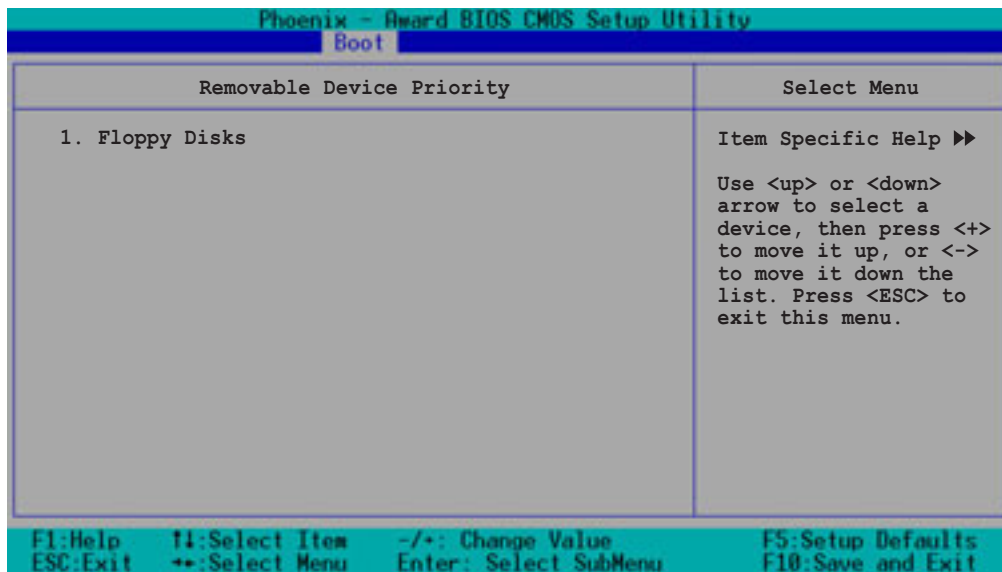

5.6.4 Boot Settings Configuration

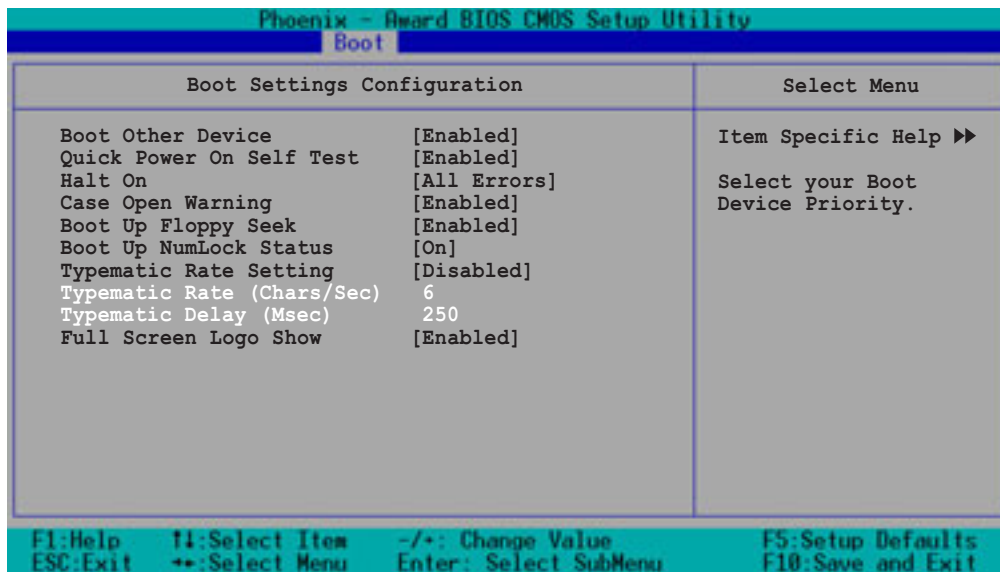

Boot Other Device [Enabled]

Allows you to enable or disable selection of other boot device.

Configuration options: [Disabled] [Enabled]

Quick Power On Self Test [Enabled]

This field speeds up the Power-On-Self Test (POST) routine by skipping retesting a second, third, and fourth time.

Configuration options: [Disabled] [Enabled]

Halt On [All Errors]

Sets the system to halt on errors according to the system functions specified in each option. Configuration options: [All Errors] [No Errors] [All, But Keyboard] [All, But Diskette] [All, But Disk/Key]

Case Open Warning [Enabled]

Allows you to enable or disable the case open status feature. Setting to [Enabled] clear the case open status.

Configuration options: [Disabled] [Enabled]

Boot Up Floppy Seek [Enabled]

When enabled, the BIOS will seek the floppy disk drive to determine whether the drive has 40 or 80 tracks.

Configuration options: [Disabled] [Enabled]

Boot Up NumLock Status [On]

Allows you to select the power-on state for the NumLock.
Configuration options: [On] [Off]

Typematic Rate Setting [Disabled]

Allows you to enable or disable the keyboard typematic rate setting. Set to [Enabled] to configure the Type Rate and Type Delay items.
Configuration options: [Disabled] [Enabled]



The items **Typematic Rate (Chars/Sec)** and **Typematic Delay** become configurable only when the item Typematic Setting is enabled.

Typematic Rate (Chars/Sec) [6]

Allows you to select the rate at which character repeats when you hold a key. Configuration options: [6] [8] [10] [12] [15] [20] [24] [30]

Typematic Delay (Msec) [250]

Allows you to set the delay before key strokes begin to repeat.
Configuration options: [250] [500] [750] [1000]

Full Screen Logo Show [Enabled]

Allows you to enable or disable the ASUS Mylogo2™ feature.
Configuration options: [Disabled] [Enabled]



The ASUS MyLogo2 is automatically installed when you install ASUS Update from the support CD. You need to launch ASUS Update, then ASUS MyLogo2 to change the full screen logo.

5.6.5 Security

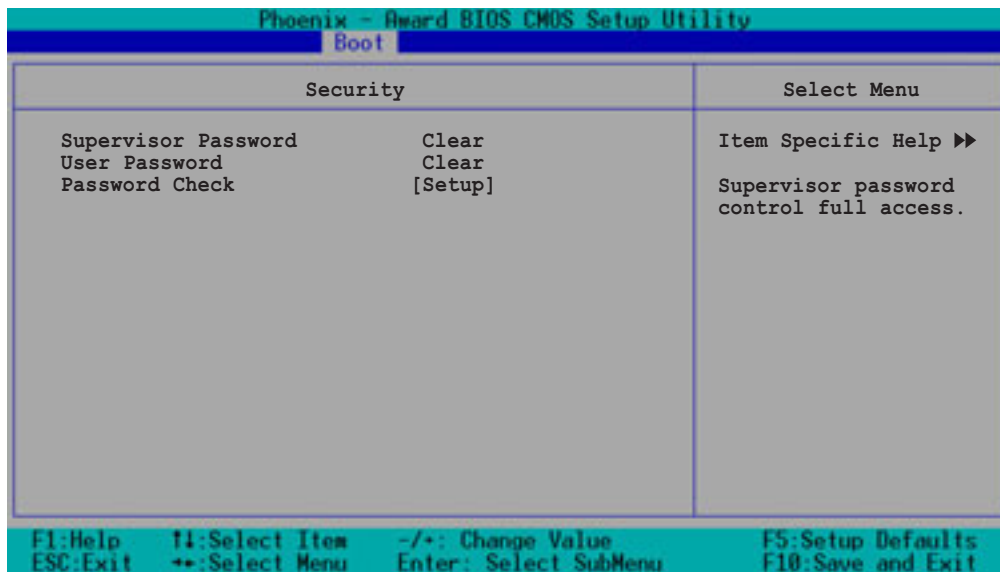

Supervisor Password [Clear]

User Password [Clear]

These fields allow you to set passwords.

To set a password:

1. Highlight an item then press <Enter>.
2. Type in a password using eight (8) alphanumeric characters, then press <Enter>.
3. When prompted, confirm the password by typing the exact characters again, then press <Enter>. The password field setting is changed to [Set].

To clear the password:

1. Highlight the password field, and press <Enter> twice. The following message appears:
"PASSWORD DISABLED!!! Press any key to continue..."
2. Press any key to return to the menu.

A note about passwords

The Supervisor password is required to enter the BIOS Setup program preventing unauthorized access. The User password is required to boot the system preventing unauthorized use.

Forgot the password?

If you forget your password, you can clear it by erasing the CMOS Real Time Clock (RTC) RAM. The RAM data containing the password information is powered by the onboard button cell battery. If you need to erase the CMOS RAM, refer to section “2.6 Jumpers” for instructions.

Password Check [Setup]

This field requires you to enter the password before entering the BIOS setup or the system. Select [Setup] to require the password before entering the BIOS Setup. Select [System] to require the password before entering the system. Configuration options: [Setup] [System]

5.7 Exit menu

The Exit menu items allow you to load the BIOS setup default settings, save or discard any changes you made, or exit the Setup utility.

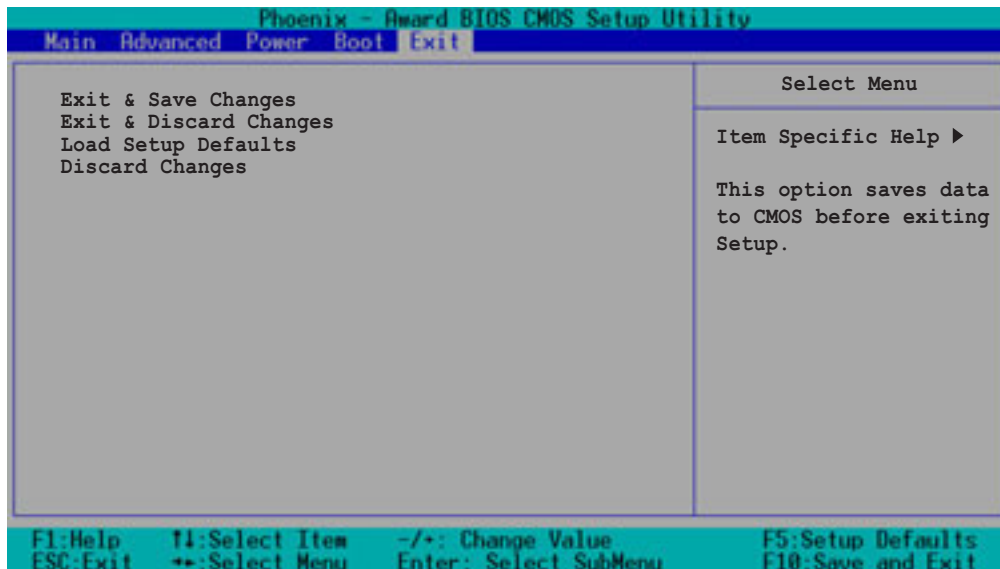

Exit & Save Changes

Select this option then press <Enter>, or simply press <F10>, to save your changes to CMOS before exiting the Setup utility.

When a confirmation window appears (with a blinking [Y]):

- press <Enter> to save and exit
- type [N], then press <Enter>, or simply press <Esc>, to cancel the command and return to the Exit menu

Exit & Discard Changes

Select this option then press <Enter> if you wish to exit the Setup utility without saving your changes.

When a confirmation window appears (with a blinking [Y]):

- press <Enter> to discard your changes and exit
- type [N], then press <Enter>, or simply press <Esc>, to cancel the command and return to the Exit menu

Load Setup Defaults

Select this option then press <Enter>, or simply press <F5>, to load the optimized values for each of the Setup menu items.

When a confirmation window appears (with a blinking [Y]):

- press <Enter> to load the default values
- type [N], then press <Enter>, or simply press <Esc>, to cancel the command and return to the Exit menu

Discard Changes

Select this option to discard the changes that you made, and restore the previously saved values.

When a confirmation window appears (with a blinking [Y]):

- press <Enter> to discard any changes, and load the previously saved values
- type [N], then press <Enter>, or simply press <Esc>, to cancel the command and return to the Exit menu

Appendix

This appendix gives information on the standard and redundant power supply that came with the barebone server. This section also provides a troubleshooting guide for solving common problems when using the barebone server.



ASUS AP1720-E2 barebone server

A.1 600 W single power supply

A.1.1 General description

The 600 W SSI-type single power supply with universal AC input includes PFC and ATX-compliant output cables and connectors. The power supply has nine plugs labeled P1 to P10 (no P3). Take note of the devices to which you should connect the plugs.

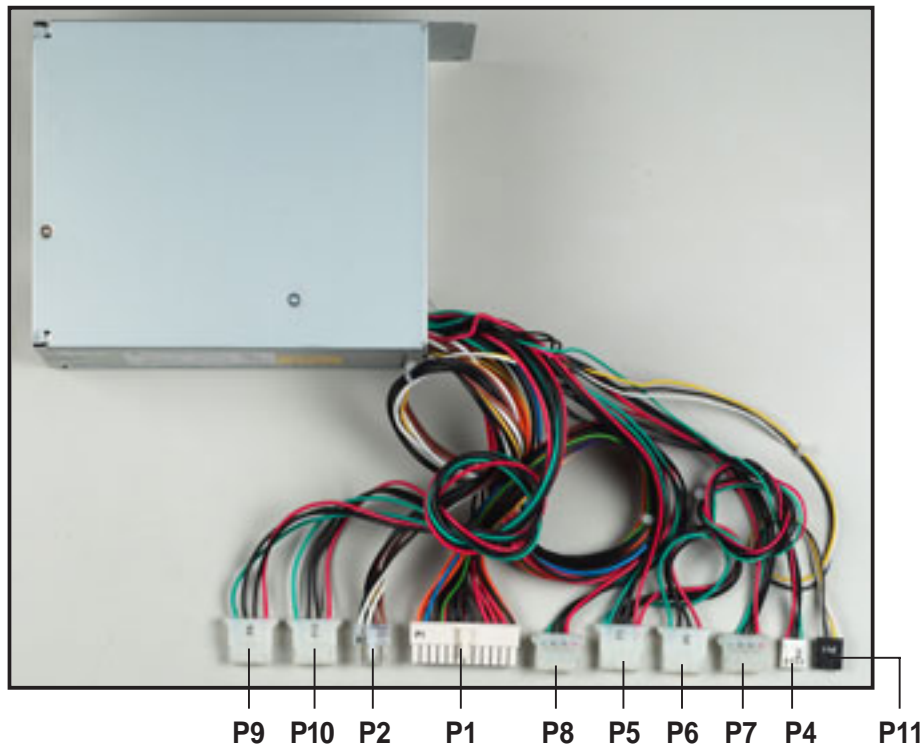

P1	Motherboard 24-pin ATX power connector
P2	Auxilliary 8-pin power connector
P4	Floppy disk drive
P5	ODD device (CD/DVD-ROM)
P6	Peripheral device (optical drive)
P7	Peripheral device (available)
P8	Peripheral device (available)
P9	Peripheral device (available)
P10	Peripheral device (available)
P11	Power SMBus connector

A.1.2 Specifications

Input characteristics

Input Voltage

Normal Range 100 to 127 V ~ 10 A

Autorange 200 to 240 V ~ 5 A

Input Frequency Range 50 Hz to 60 Hz

DC Output characteristics

Output Voltage	Max (A)
+3.33V	20
+5V	24
+12V	15
-12V	0.5
-5V	0.5
+5VSB	2.0

A.2 600 W dual/redundant power supply

A.2.1 General description

The 600 W dual/redundant-type power supply has 11 plugs. Take note of the devices which you should connect to the plugs.

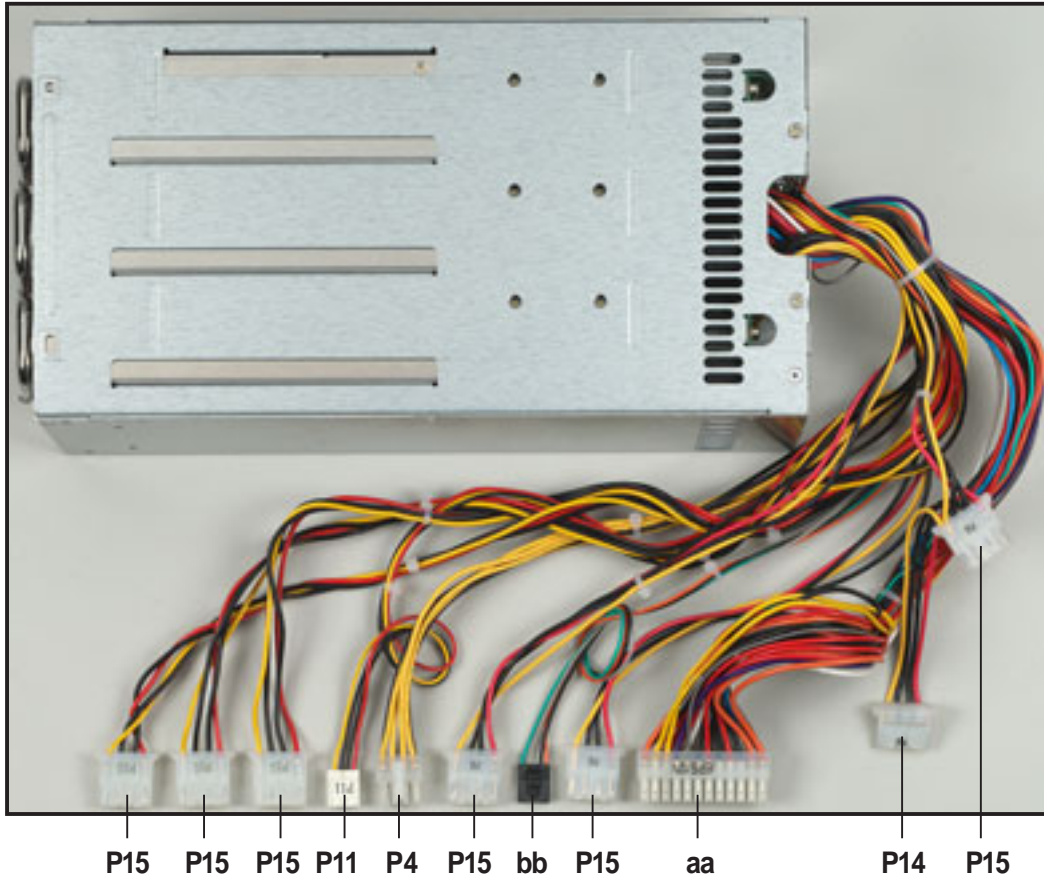

aa	Motherboard 24-pin ATX power connector
bb	Power SMBus connector
P4	Motherboard 8-pin +12V AUX power connector
P11	Floppy disk drive
P14	Peripheral device (available)
P15	Peripheral devices (available)

A.2.2 Specifications

Input characteristics

Input Voltage	
Normal Range	100 to 240 Vac
Minimum	90 Vac
Maximum	264 Vac
Input Frequency Range	47Hz to 63Hz

DC Output characteristics

Output Voltage	Max (A)	Max Power (W)
+3.33V	40	580
+5V	50	580
+12V	34	580
-12V	1.0	12
-5V	0.5	2.5
+5VSB	2.0	15

Operating conditions

Efficiency	65 % minimum
Hold-up Time	16 mS
Over Power Protection	overloaded to 110 ~ 150 %
Hold-up Time	16 mS
Temperature	104° F to 122° F (40° C - 50° C)
Relative Humidity	20% - 90% non-condensing at 104° F (40° C)
Altitude	Sea level to 10,000 ft
Mean Time Between Failures	MTBF > 100,000 hours at 25° C

A.3 Simple fixes



Some problems that you may encounter are not due to defects on the system or the components. These problems only requires simple troubleshooting actions that you can perform by yourself.

Problem	Action
The power LED on the server or on the monitor do not light up	<ol style="list-style-type: none">1. Check if the power cable is properly connected to the power connector in the system rear panel.2. Make sure that the power cables are connected to a grounded power outlet.3. Press the power button to make sure that the system is turned on.
The keyboard does not work	Check if the keyboard cable is properly connected to the PS/2 keyboard port.
The mouse does not work	Check if the mouse cable is properly connected to the mouse port.
The system does not perform power-on self tests (POST) after it was turned on	<ol style="list-style-type: none">1. Check the memory modules and make sure you installed the DIMMs the system supports.2. Make sure that the DIMMs are properly installed on the sockets.

Problem	Action
<p>The system continuously beeps after it was turned on</p>	<ol style="list-style-type: none"> 1. Check the memory modules and make sure you installed supported DIMMs. 2. Make sure that the DIMMs are properly installed on the sockets.
<p>The message “Non-system disk or disk error” appears</p>	<ol style="list-style-type: none"> 1. Check if a bootable HDD is active. 2. Check if the HDDs are properly installed.
<p>Network connection not available</p>	<ol style="list-style-type: none"> 1. Make sure that the network cable is connected to the LAN port on the rear panel. 2. Make sure that you have installed the LAN drivers from the support CD.

