

**ASUS<sup>®</sup>**

**ESC2000 G2**

*Workstation*

*User Guide*



E7227

First Edition

April 2012

**Copyright © 2012 ASUSTeK COMPUTER INC. All Rights Reserved.**

No part of this manual, including the products and software described in it, may be reproduced, transmitted, transcribed, stored in a retrieval system, or translated into any language in any form or by any means, except documentation kept by the purchaser for backup purposes, without the express written permission of ASUSTeK COMPUTER INC. ("ASUS").

ASUS provides this manual "as is" without warranty of any kind, either express or implied, including but not limited to the implied warranties or conditions of merchantability or fitness for a particular purpose. In no event shall ASUS, its directors, officers, employees, or agents be liable for any indirect, special, incidental, or consequential damages (including damages for loss of profits, loss of business, loss of use or data, interruption of business and the like), even if ASUS has been advised of the possibility of such damages arising from any defect or error in this manual or product.

Specifications and information contained in this manual are furnished for informational use only, and are subject to change at any time without notice, and should not be construed as a commitment by ASUS. ASUS assumes no responsibility or liability for any errors or inaccuracies that may appear in this manual, including the products and software described in it.

Product warranty or service will not be extended if: (1) the product is repaired, modified or altered, unless such repair, modification or alteration is authorized in writing by ASUS; or (2) the serial number of the product is defaced or missing.

Products and corporate names appearing in this manual may or may not be registered trademarks or copyrights of their respective companies, and are used only for identification or explanation and to the owners' benefit, without intent to infringe.

# Contents

Notices.....	viii
Safety information .....	ix
About this guide .....	x

## Chapter 1: Product introduction

1.1	System package contents .....	1-2
1.2	Serial number label .....	1-2
1.3	System specifications .....	1-3
1.4	Front panel features.....	1-5
1.5	Rear panel features.....	1-6
1.6	Internal features .....	1-7
1.7	LED information .....	1-8
1.7.1	Front panel LEDs .....	1-8
1.7.2	Rear panel LEDs.....	1-8

## Chapter 2: Hardware setup

2.1	Chassis cover.....	2-2
2.1.1	Removing the side cover .....	2-2
2.1.2	Reinstalling the side cover .....	2-3
2.2	Motherboard overview.....	2-4
2.3	Central Processing Unit (CPU) .....	2-5
2.3.1	CPU installation .....	2-6
2.3.2	CPU heatsink and fan assembly installation.....	2-8
2.4	System memory .....	2-10
2.4.1	Overview .....	2-10
2.4.2	Memory Configurations.....	2-10
2.4.3	Installing a DIMM .....	2-11
2.4.4	Removing a DIMM .....	2-12
2.5	Front panel assembly .....	2-13
2.5.1	Removing the front panel assembly.....	2-13
2.5.2	Reinstalling the front panel assembly .....	2-13
2.6	5.25-inch drives.....	2-14
2.7	SATA hard disk drives .....	2-15
2.7.1	Installing the HDD module cage .....	2-15
2.7.2	Removing the HDD module cage .....	2-16
2.7.3	Installing a hot-swap SATA hard disk drive .....	2-16

# Contents

2.7.4	Removing and reinstalling the backplane .....	2-18
<b>2.8</b>	<b>Expansion cards .....</b>	<b>2-19</b>
2.8.1	Installing an expansion card .....	2-20
2.8.2	Configuring an expansion card .....	2-21
<b>2.9</b>	<b>Cable connections .....</b>	<b>2-22</b>
2.9.1	Motherboard connections .....	2-22
2.9.2	SATA backplane connections .....	2-23
<b>2.10</b>	<b>Removable components.....</b>	<b>2-25</b>
2.10.1	Removing rear system fan .....	2-25
2.10.2	Removing front system fan .....	2-26
<b>2.11</b>	<b>Installing the ASMB6 management board .....</b>	<b>2-27</b>

## Chapter 3: Motherboard Info

<b>3.1</b>	<b>Motherboard layout.....</b>	<b>3-2</b>
<b>3.2</b>	<b>Jumpers .....</b>	<b>3-5</b>
<b>3.3</b>	<b>Onboard buttons and switches .....</b>	<b>3-8</b>
<b>3.4</b>	<b>Onboard LEDs .....</b>	<b>3-9</b>
<b>3.5</b>	<b>Connectors .....</b>	<b>3-14</b>
3.5.1	Rear panel connectors.....	3-14
3.5.2	Audio I/O connections.....	3-15
3.5.4	Internal connectors .....	3-18

## Chapter 4: BIOS setup

<b>4.1</b>	<b>Managing and updating your BIOS .....</b>	<b>4-2</b>
4.1.1	ASUS CrashFree BIOS 3 utility .....	4-2
4.1.2	ASUS EZ Flash 2 Utility .....	4-3
4.1.3	BUPDATER utility.....	4-4
<b>4.2</b>	<b>BIOS setup program .....</b>	<b>4-6</b>
4.2.1	BIOS menu screen.....	4-7
4.2.2	Menu bar.....	4-7
4.2.3	Menu items .....	4-8
4.2.4	Submenu items .....	4-8
4.2.5	Navigation keys.....	4-8
4.2.6	General help .....	4-8
4.2.7	Configuration fields .....	4-8
4.2.8	Pop-up window .....	4-8

# Contents

4.2.9	Scroll bar .....	4-8
<b>4.3</b>	<b>Main menu .....</b>	<b>4-9</b>
4.3.1	System Date [Day xx/xx/xxxx] .....	4-9
4.3.2	System Time [xx:xx:xx] .....	4-9
<b>4.4</b>	<b>Ai Tweaker menu .....</b>	<b>4-10</b>
4.4.1	DRAM Timing Control .....	4-12
<b>4.5</b>	<b>Advanced menu .....</b>	<b>4-14</b>
4.5.1	CPU Configuration .....	4-14
4.5.2	CPU Power Management Configuration .....	4-17
4.5.3	Chipset Configuration .....	4-20
4.5.4	PCH SATA Configuration .....	4-26
4.5.5	PCH SCU SAS Configuration .....	4-27
4.5.6	PCI Subsystem Settings .....	4-28
4.5.7	USB Configuration .....	4-31
4.5.8	ACPI Settings .....	4-32
4.5.9	WHEA Configuration .....	4-33
4.5.10	APM .....	4-34
4.5.11	Serial Port Console Redirection .....	4-35
4.5.12	Onboard LAN Configuration .....	4-38
4.5.13	Marvell SATA Configuration .....	4-38
4.5.14	Onboard Devices Configuration .....	4-39
4.5.15	Runtime Error Logging .....	4-40
<b>4.6</b>	<b>Server Management menu .....</b>	<b>4-41</b>
4.6.1	System Event Log .....	4-42
4.6.2	BMC network configuration .....	4-43
<b>4.7</b>	<b>Event Logs menu .....</b>	<b>4-44</b>
4.7.1	Change Smbios Event Log Settings .....	4-45
<b>4.8</b>	<b>Boot menu .....</b>	<b>4-47</b>
<b>4.9</b>	<b>Monitor menu .....</b>	<b>4-50</b>
<b>4.10</b>	<b>Security menu .....</b>	<b>4-52</b>
<b>4.11</b>	<b>Tool menu .....</b>	<b>4-53</b>
<b>4.12</b>	<b>Exit menu .....</b>	<b>4-54</b>
 <b>Chapter 5: RAID configuration</b>		
<b>5.1</b>	<b>RAID configurations .....</b>	<b>5-2</b>

# Contents

- 5.1.1 RAID definitions ..... 5-2
- 5.1.2 Installing Serial ATA hard disks ..... 5-3
- 5.1.3 Setting the RAID item in BIOS ..... 5-3
- 5.2 LSI Software RAID Configuration Utility ..... 5-4**
  - 5.2.1 Creating a RAID set ..... 5-5
  - 5.2.2 Adding or viewing a RAID configuration ..... 5-11
  - 5.2.3 Initializing the virtual drives ..... 5-12
  - 5.2.4 Rebuilding failed drives ..... 5-16
  - 5.2.5 Checking the drives for data consistency ..... 5-18
  - 5.2.6 Deleting a RAID configuration ..... 5-21
  - 5.2.7 Selecting the boot drive from a RAID set ..... 5-22
  - 5.2.8 Enabling WriteCache ..... 5-23
- 5.3 Intel® Rapid Storage Technology enterprise SCU/SATA  
Option ROM Utility ..... 5-24**
  - 5.3.1 Creating a RAID set ..... 5-25
  - 5.3.2 Creating a Recovery set ..... 5-26
  - 5.3.3 Deleting a RAID set ..... 5-28
  - 5.3.4 Resetting disks to Non-RAID ..... 5-29
  - 5.3.5 Exiting the Intel® Rapid Storage Technology utility ..... 5-29
  - 5.3.6 Rebuilding the RAID ..... 5-30
  - 5.3.7 Setting the Boot array in the BIOS Setup Utility ..... 5-32
- 5.1.5 Marvell RAID utility ..... 5-33
- 5.4 Intel® Rapid Storage Technology enterprise Utility  
(Windows) ..... 5-37**
  - 5.4.1 Creating a RAID set ..... 5-38
  - 5.4.2 Change Volume Type ..... 5-40
  - 5.4.3 Delete volume ..... 5-41
  - 5.4.4 Preferences ..... 5-42

**Chapter 6: Driver installation**

- 6.1 RAID driver installation ..... 6-2**
  - 6.1.1 Creating a RAID driver disk ..... 6-2
  - 6.1.2 Installing the RAID controller driver ..... 6-4
- 6.2 Intel® Chipset Device Software installation ..... 6-13**
- 6.3 Intel® Network Connections Software installation ..... 6-15**

# Contents

6.4	Audio driver installation .....	6-18
6.5	Intel® C600 Series Chipset SAS RAID (SATA mode) Drivers installation.....	6-20
6.6	Marvell Magni installation .....	6-21
6.7	Intel® Rapid Storage Technology enterprise 3.0 installation .	6-22
6.8	Marvell Storage Utility installation .....	6-25
6.9	Asmedia ASM104x USB 3.0 Host Controller Driver installation .....	6-29
6.10	Intel® WG82574L Gigabit Adapters Driver installation.....	6-32
6.11	VGA driver installation.....	6-35
6.12	Management applications and utilities installation .....	6-38
6.12.1	Running the support DVD .....	6-38
6.12.2	Drivers menu .....	6-38
6.12.3	Utilities menu .....	6-39
6.12.4	Make disk menu .....	6-39
6.12.5	Contact information .....	6-39
 <b>Chapter 7: Multiple GPU technology support</b>		
7.1	AMD® CrossFireX™ technology .....	7-2
7.1.1	Requirements.....	7-2
7.1.2	Before you begin.....	7-2
7.1.3	Installing two CrossFireX™ graphics cards .....	7-3
5.1.4	Installing the device drivers.....	7-4
5.1.5	Enabling the AMD® CrossFireX™ technology.....	7-4
7.2	NVIDIA® SLI™ technology .....	7-5
7.2.1	Requirements.....	7-5
7.2.2	Installing two SLI-ready graphics cards .....	7-5
7.2.3	Installing three SLI-ready graphics cards.....	7-6
7.2.4	Installing four SLI-ready graphics cards.....	7-7
7.2.5	Installing the device drivers.....	7-8
7.2.6	Enabling the NVIDIA® SLI™ technology .....	7-8
7.3	NVIDIA® CUDA™ technology .....	7-11
7.3.1	Requirements.....	7-11
7.3.2	Installing CUDA-ready graphics cards .....	7-11

# Notices

## Federal Communications Commission Statement

This device complies with Part 15 of the FCC Rules. Operation is subject to the following two conditions:

- This device may not cause harmful interference, and
- This device must accept any interference received including interference that may cause undesired operation.

This equipment has been tested and found to comply with the limits for a Class A digital device, pursuant to Part 15 of the FCC Rules. These limits are designed to provide reasonable protection against harmful interference in a residential installation. This equipment generates, uses and can radiate radio frequency energy and, if not installed and used in accordance with manufacturer's instructions, may cause harmful interference to radio communications. However, there is no guarantee that interference will not occur in a particular installation. If this equipment does cause harmful interference to radio or television reception, which can be determined by turning the equipment off and on, the user is encouraged to try to correct the interference by one or more of the following measures:

- Reorient or relocate the receiving antenna.
- Increase the separation between the equipment and receiver.
- Connect the equipment to an outlet on a circuit different from that to which the receiver is connected.
- Consult the dealer or an experienced radio/TV technician for help.



---

**WARNING!** The use of shielded cables for connection of the monitor to the graphics card is required to assure compliance with FCC regulations. Changes or modifications to this unit not expressly approved by the party responsible for compliance could void the user's authority to operate this equipment.

---

## Canadian Department of Communications Statement

This digital apparatus does not exceed the Class B limits for radio noise emissions from digital apparatus set out in the Radio Interference Regulations of the Canadian Department of Communications.

This Class B digital apparatus complies with Canadian ICES-003.

## REACH

Complying with the REACH (Registration, Evaluation, Authorization, and Restriction of Chemicals) regulatory framework, we publish the chemical substances in our products at ASUS REACH website at <http://green.asus.com/english/REACH.htm>.



# Safety information

## Electrical Safety

- Before installing or removing signal cables, ensure that the power cables for the system unit and all attached devices are unplugged.
- To prevent electrical shock hazard, disconnect the power cable from the electrical outlet before relocating the system.
- When adding or removing any additional devices to or from the system, contact a qualified service technician or your dealer. Ensure that the power cables for the devices are unplugged before the signal cables are connected. If possible, disconnect all power cables from the existing system before you service.
- If the power supply is broken, do not try to fix it by yourself. Contact a qualified service technician or your dealer.

## Operation Safety

- Servicing of this product or units is to be performed by trained service personnel only.
- Before operating the server, carefully read all the manuals included with the server package.
- Before using the server, make sure all cables are correctly connected and the power cables are not damaged. If any damage is detected, contact your dealer as soon as possible.
- To avoid short circuits, keep paper clips, screws, and staples away from connectors, slots, sockets and circuitry.
- Avoid dust, humidity, and temperature extremes. Place the server on a stable surface.



This product is equipped with a three-wire power cable and plug for the user's safety. Use the power cable with a properly grounded electrical outlet to avoid electrical shock.

### Lithium-Ion Battery Warning

CAUTION! Danger of explosion if battery is incorrectly replaced. Replace only with the same or equivalent type recommended by the manufacturer. Dispose of used batteries according to the manufacturer's instructions.

### CD-ROM Drive Safety Warning

**CLASS 1 LASER PRODUCT**

### Heavy System

CAUTION! This server system is heavy. Ask for assistance when moving or carrying the system.



---

**DO NOT** throw the motherboard in municipal waste. This product has been designed to enable proper reuse of parts and recycling. This symbol of the crossed out wheeled bin indicates that the product (electrical and electronic equipment) should not be placed in municipal waste. Check local regulations for disposal of electronic products.

---



---

**DO NOT** throw the mercury-containing button cell battery in municipal waste. This symbol of the crossed out wheeled bin indicates that the battery should not be placed in municipal waste.

---

## About this guide

### Audience

This user guide is intended for system integrators, and experienced users with at least basic knowledge of configuring a server.

### Contents

This guide contains the following parts:

**1. Chapter 1: Product Introduction**

This chapter describes the general features of the server, including sections on front panel and rear panel specifications.

**2. Chapter 2: Hardware setup**

This chapter lists the hardware setup procedures that you have to perform when installing or removing system components.

**3. Chapter 3: Motherboard information**

This chapter includes the motherboard layout and brief descriptions of the jumpers and internal connectors.

**4. Chapter 4: BIOS information**

This chapter tells how to change system settings through the BIOS Setup menus and describes the BIOS parameters.

**5. Chapter 5: RAID configuration**

This chapter provides instructions for setting up, creating and configuring RAID sets using the available utilities.

**6. Chapter 6: Driver installation**

This chapter provides instructions for installing the necessary drivers for different system components.

**7. Chapter 7: Multiple GPU technology support**

This chapter describes how to install and configure multiple ATI® CrossFireX™ / NVIDIA® SLI™ graphics cards and NVIDIA® CUDA technology.

## Conventions

To make sure that you perform certain tasks properly, take note of the following symbols used throughout this manual.



**DANGER/WARNING:** Information to prevent injury to yourself when trying to complete a task.



**CAUTION:** Information to prevent damage to the components when trying to complete a task.



**IMPORTANT:** Instructions that you **MUST** follow to complete a task.



**NOTE:** Tips and additional information to help you complete a task.

## Typography

### **Bold text**

Indicates a menu or an item to select.

### *Italics*

Used to emphasize a word or a phrase.

### <Key>

Keys enclosed in the less-than and greater-than sign means that you must press the enclosed key.

Example: <Enter> means that you must press the Enter or Return key.

### <Key1+Key2+Key3>

If you must press two or more keys simultaneously, the key names are linked with a plus sign (+).

Example: <Ctrl+Alt+D>

### **Command**

Means that you must type the command exactly as shown, then supply the required item or value enclosed in brackets.

Example: At the DOS prompt, type the command line: `format A:/S`

## Where to find more information

Refer to the following sources for additional information and for product and software updates.

### 1. **ASUS websites**

The ASUS website provides updated information on ASUS hardware and software products. Refer to the ASUS contact information.

### 2. **Optional documentation**

Your product package may include optional documentation, such as warranty flyers, that may have been added by your dealer. These documents are not part of the standard package.

# Chapter 1

This chapter describes the general features of the workstation, including sections on front panel and rear panel specifications.



ASUS ESC2000 G2

# Product introduction

# 1.1 System package contents

Check your system package for the following items.

Model Name	ESC2000 G2
Chassis	ASUS T50A Pedestal 5U Rackmount Chassis
Motherboard	ASUS Z9PE-D8 WS workstation motherboard
Component	1 x 1350W 80+ Gold Single Power Supply 4 x hot-swap HDD trays 1 x Front I/O Board 1 x System Fan (Rear: 1 x 120mm x 38mm)
Accessories	1 x ESC2000 G2 User's Guide 1 x ESC2000 G2 Support DVD 2 x COM port cables 1 x VGA cable with bracket 1 x ASWM Enterprise DVD 1 x bag of screws 1 x AC power cable
Optional Items	Cooler for CPU 150W upgrade kit System Fan (Front: 1 x 80mm x 25mm)



If any of the above items is damaged or missing, contact your retailer.

# 1.2 Serial number label

Before requesting support from the ASUS Technical Support team, you must take note of the product's serial number containing 14 characters such as xxS0xxxxxxxxxx shown as the figure below. With the correct serial number of the product, ASUS Technical Support team members can then offer a quicker and satisfying solution to your problems.



## 1.3 System specifications

The ASUS ESC2000 G2 is a workstation featuring the ASUS Z9PE-D8 WS motherboard. The workstation supports Intel® LGA2011 Xeon® E5-2600 processor family, plus other latest technologies through the chipsets onboard.

Model Name		ESC2000 G2
Processor / System Bus		2 x Socket LGA2011
		Intel® Xeon® processor E5-2600 processor family (TDP=150W)
		QPI 6.4/7.2/8.0GT/s
Core Logic		Intel® C602 Chipset
Memory	Total Slots	8 (4-channel per CPU, 4 DIMM per CPU)
	Capacity	Maximum up to 64GB (UDIMM) Maximum up to 256GB (RDIMM) Maximum up to 256GB (LRDIMM)
	Memory Type	DDR3 800/1066/1333/1600 RDIMM DDR31066/1333/1600/1866(O.C.)/2000(O.C.)/2133 (O.C.) ECC UDIMM/Non-ECC UDIMM DDR3 1066/1333 LRDIMM
	Memory Size	1GB, 2GB, 4GB, 8GB, 16GB and 32GB (RDIMM) 1GB, 2GB, 4GB and 8GB (UDIMM) 8GB, 16GB and 32GB (LRDIMM)
Expansion Slots	Total PCI/PCI-X/PCI-E Slots	7
	Slot Type	4 x PCI-E 3.0 x16 slots (dual at x16/x16, quad at x8/x8/x8/x8) 2 x PCI-E 3.0 x16 slots (at x16 mode) 1 x PCI-E 3.0 x16 slot (at x8 mode)
Storage	SATA Controller	<b>Intel® C602-A:</b> <b>AHCI</b> <ul style="list-style-type: none"> <li>- 4 x SATA 3.0Gb/s ports</li> <li>- 2 x SATA 6.0Gb/s ports</li> <li>- Intel Rapid Storage Technology enterprise (supports RAID 0, 1, 5 and 10 for Windows® only)</li> <li>- LSI® MegaRAID (supports RAID 0, 1, and 10 for Linux/Windows®)</li> </ul>
		<b>SCU</b> <ul style="list-style-type: none"> <li>- 4 x SATA 3.0Gb/s ports</li> <li>- Intel Rapid Storage Technology enterprise (for Windows® only) supports software RAID 0, 1, 5 and 10 for all SATA ports</li> </ul>
Networking	LAN	<b>Marvell 88E9230 SATA controller:</b> <ul style="list-style-type: none"> <li>- 4 x SATA 6.0Gb/s ports (supports software RAID 0, 1, and 10 for Windows® only)</li> </ul>
		2 x Intel® 82574L Gigabit LAN controller

(continued on the next page)

<b>HDD Bays</b>		4 x Hot-swap 3.5" HDD Bays
<b>Graphic cards</b>		ASpeed AST2300 16MB
<b>Auxiliary Storage FDD / CD / DVD</b>		3 x 5.25" media bays (Optional: No ODD/DVD-RM)*  <b>*DVD-RW default for North America</b>
<b>Front Panel I/O</b>		2 x USB 3.0 ports (blue) 2 x USB 2.0 ports 1 x Line In 1 x Line Out
<b>Rear Panel I/O</b>		1 x PS/2 Keyboard/Mouse combo port 1 x S/PDIF Out (Optical) 2 x USB 3.0/2.0 ports (blue) 6 x USB 2.0/1.1 ports 2 x RJ45 ports (Intel® LAN) 8-channel Audio I/O
<b>OS Support</b>		Windows® Server 2008 R2 Windows® Server 2008 R2 Enterprise Windows® Server 2008 Enterprise 32/64-bit Windows® 7 Ultimate Service Pack 1 32/64-bit RedHat® Enterprise Linux Desktop WS 6.0 32/64-bit RedHat® Enterprise Linux AS5.7/6.2 32/64-bit SuSE® Linux Enterprise Desktop 11.1 32/64-bit SuSE® Linux Enterprise Server 11.2 32/64-bit CentOS 5.7/6.1 32/64-bit VMWare ESX4.1/ESXi4.1
<b>Management Solution</b>	<b>Software</b>	ASWM Enterprise
	<b>Out-of-Band Remote Management</b>	optional 1 x ASMB6-iKVM-over-internet
<b>Dimension (HH x WW x DD)</b>		445mm x 217.5mm x 545mm
<b>Net Weight Kg (CPU, DRAM &amp; HDD not included)</b>		17.2 Kg
<b>Power Supply</b>		1350W (80+) Gold Single Power Supply
<b>Power Rating</b>		Input: 115-240Vac, 14.5-6.5A, 50-60Hz, Class I
<b>Environment</b>		Operating temperature: 10°C–35°C Non-operating temperature: -40°C–70°C Non-operating humidity: 20%–90% (Non-condensing)

\*Specifications are subject to change without notice.



## 1.4 Front panel features

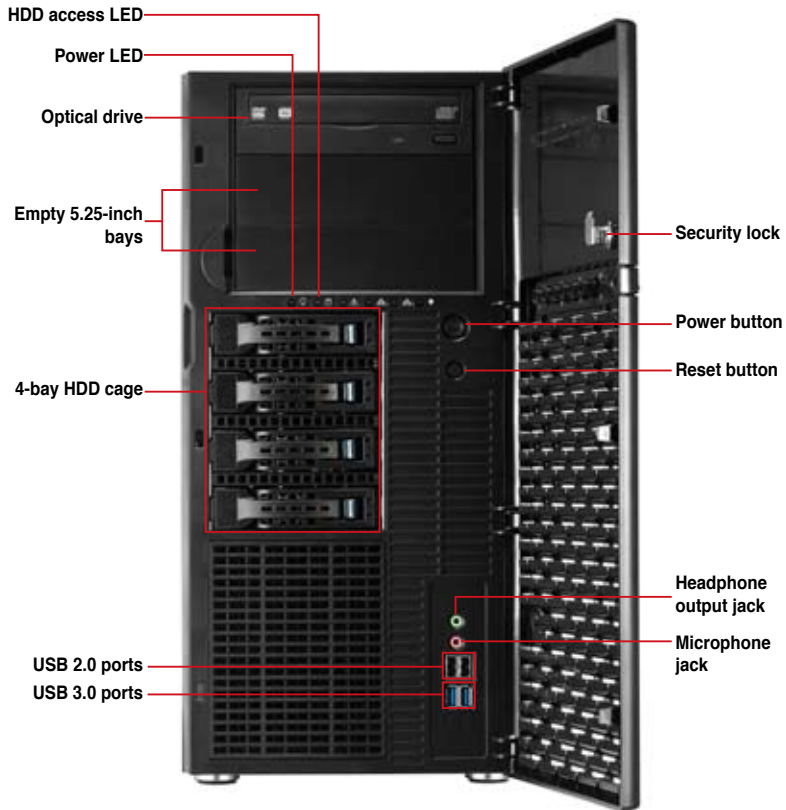

Refer to section 1.7.1 **Front panel LEDs** for the LED descriptions.

# 1.5 Rear panel features

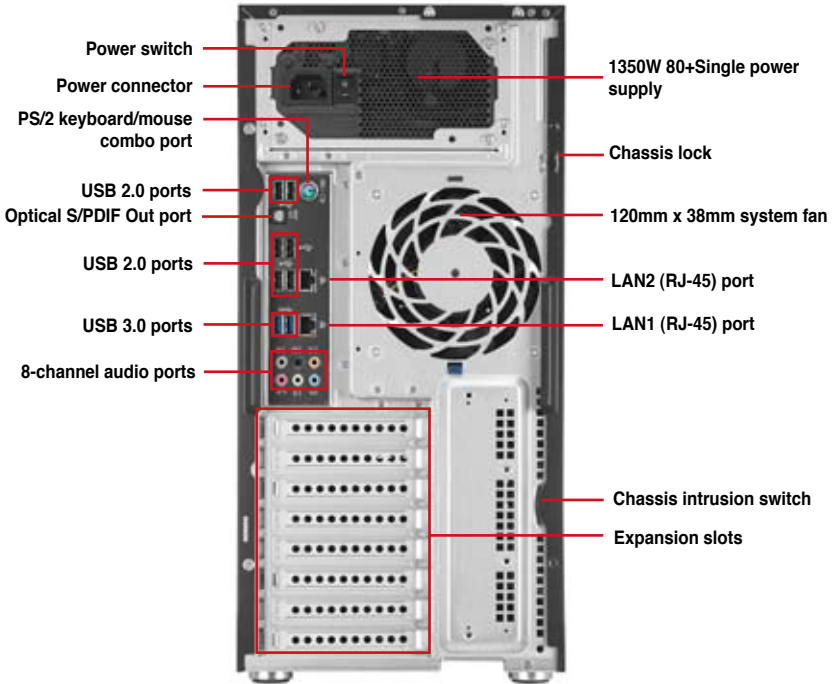

## 1.6 Internal features

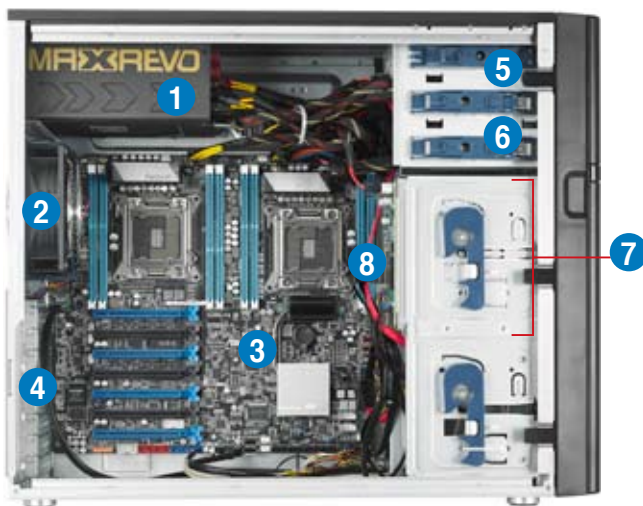

1. 1350W 80+ Gold Single Power supply unit
2. 120mm x 38mm system fan
3. ASUS Z9PE-D8 WS motherboard
4. Expansion card locks
5. Optical drive
6. 2 x 5.25-inch drive bays
7. 4-bay HDD module
8. SATA/SAS backplane board



Turn off the system power and detach the power supply before removing or replacing any system component.



The barebone workstation does not include a floppy disk drive and an optical disc drive. Connect a USB floppy disk drive or a USB ODD to any of the USB ports on the front or rear panel if you need to use a floppy disk or a optical disc.

**\*WARNING**  
**HAZARDOUS MOVING PARTS**  
**KEEP FINGERS AND OTHER BODY PARTS AWAY**

# 1.7 LED information

## 1.7.1 Front panel LEDs

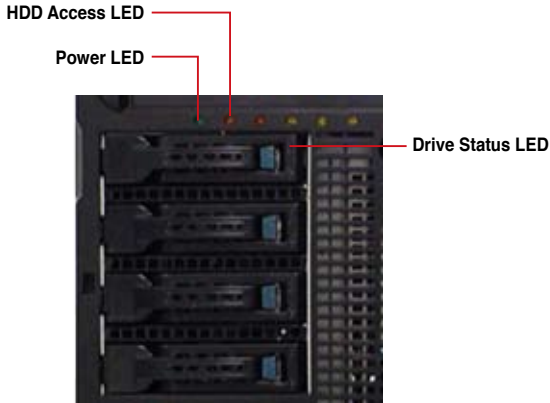

LED	Icon	Display status	Description
Power LED		ON	System power ON
HDD Access LED		OFF	No activity
		Blinking	Read/write data into the HDD
Drive status LED		Green	Bridge board connected to backplane Installed HDD is in good condition
		Red	HDD failure
		Green/Red blinking	HDD rebuilding using the RAID card



The Power and HDD Access LEDs are visible even if the system front bezel is closed.

## 1.7.2 Rear panel LEDs

Activity Link LED		Speed LED	
Status	Description	Status	Description
OFF	No link	OFF	10 Mbps connection
ORANGE	Linked	ORANGE	100 Mbps connection
BLINKING	Data activity	GREEN	1 Gbps connection

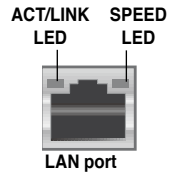

# Chapter 2

This chapter lists the hardware setup procedures that you have to perform when installing or removing system components.



ASUS ESC2000 G2

# Hardware setup

## 2.1 Chassis cover

### 2.1.1 Removing the side cover



- Ensure that you unplug the power cord before removing the side cover.
- Take extra care when removing the side cover. Keep your fingers from components inside the chassis that can cause injury, such as the CPU fan, rear fan, and other sharp-edged parts.
- The images of the workstation shown in this section are for reference purpose only and may not exactly match the model you purchase.

To remove the side cover:

1. Remove the two screws that secure the left side cover of the chassis.

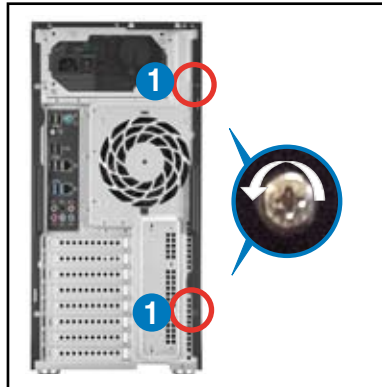

2. Slide the side cover for about half an inch toward the rear until it is disengaged from the chassis. Carefully lift the side cover and set it aside.

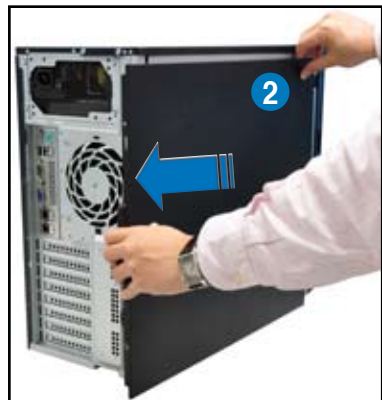

## 2.1.2 Reinstalling the side cover

To reinstall the side cover:

1. Match and insert the lower sliding edge of the side cover to the chassis edge.
2. Position the side cover to the chassis.

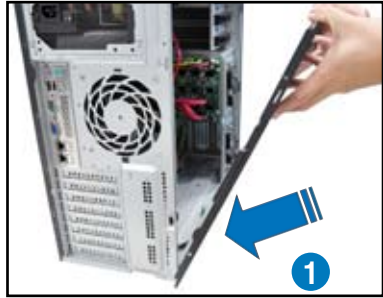

3. Slide the side cover toward the front panel until it snaps in place.

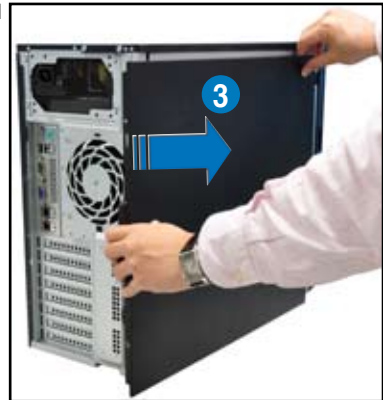

4. Drive in the two screws you removed earlier to secure the side cover.

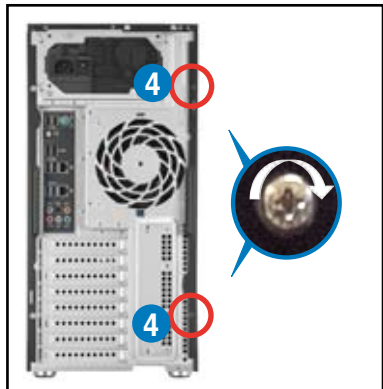

## 2.2 Motherboard overview

The barebone server comes with the Z9PE-D8 WS motherboard already installed. The motherboard is secured to the chassis by ten (10) screws as indicated by the circles in the illustration below.



Refer to **Chapter 3: Motherboard Information** for detailed information on the motherboard.

Place this side towards  
the rear of the chassis

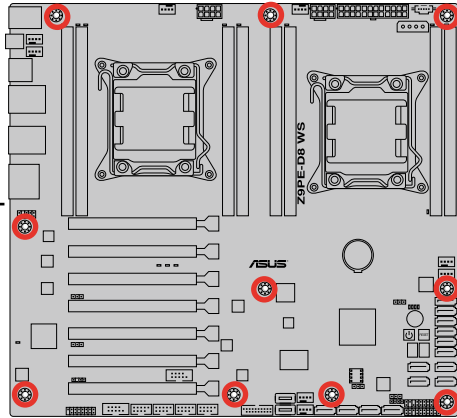

Ensure to unplug the power cord before installing or removing any motherboard component or connection. Failure to do so can cause you physical injury and damage the motherboard components.



## 2.3 Central Processing Unit (CPU)

The motherboard comes with a surface mount LGA2011 socket designed for the Intel® Xeon® E5-2600 series processors.

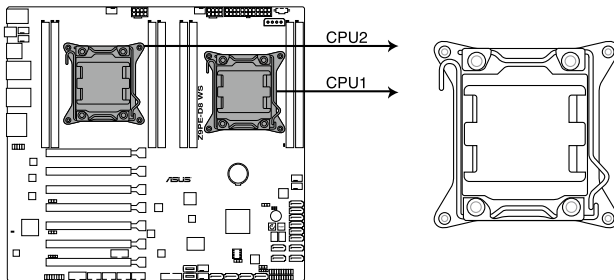

**Z9PE-D8 WS CPU LGA2011 Socket**



---

Ensure that all power cables are unplugged before installing the CPU.

---



- Upon purchase of the motherboard, ensure that the PnP cap is on the socket and the socket contacts are not bent. Contact your retailer immediately if the PnP cap is missing, or if you see any damage to the PnP cap/socket contacts/motherboard components. ASUS shoulders the repair cost only if the damage is shipment/transit-related.
  - Keep the cap after installing the motherboard. ASUS will process Return Merchandise Authorization (RMA) requests only if the motherboard comes with the cap on the LGA2011 socket.
  - The product warranty does not cover damage to the socket contacts resulting from incorrect CPU installation/removal, or misplacement/loss/incorrect removal of the PnP cap.
-

### 2.3.1 CPU installation



Please note the order in opening/ closing the double latch. Follow the instructions printed on the metal sealing hatch or the illustrations shown below in this manual. The plastic cap will pop up automatically once the CPU is in place and the hatch properly sealed down.

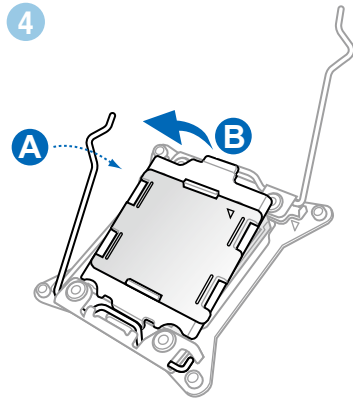
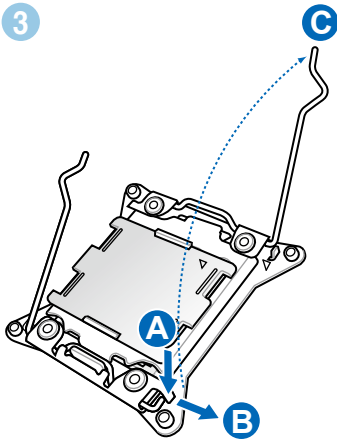
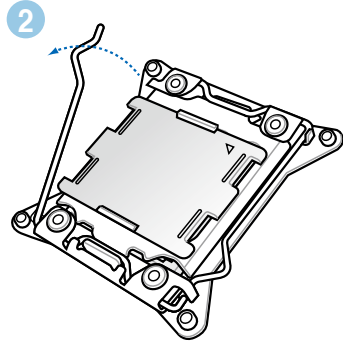
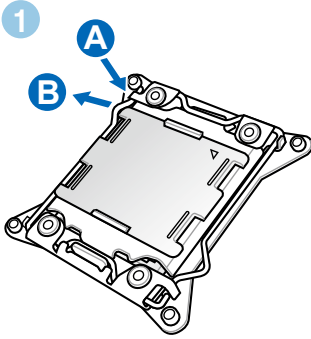

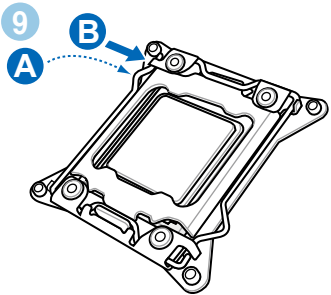
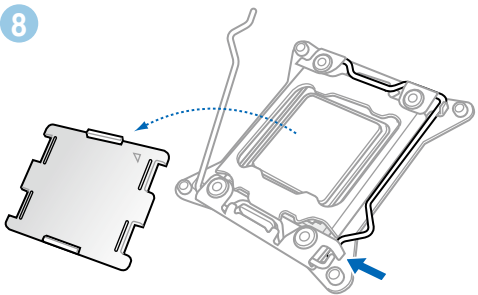
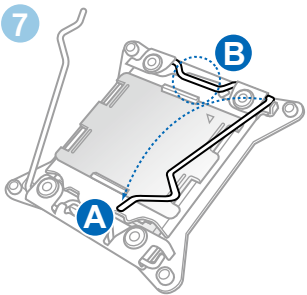
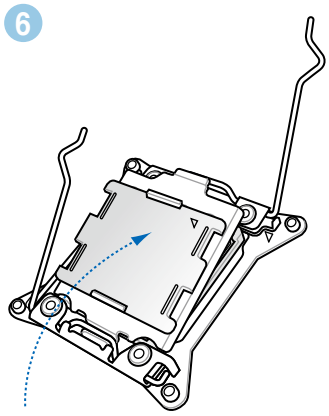
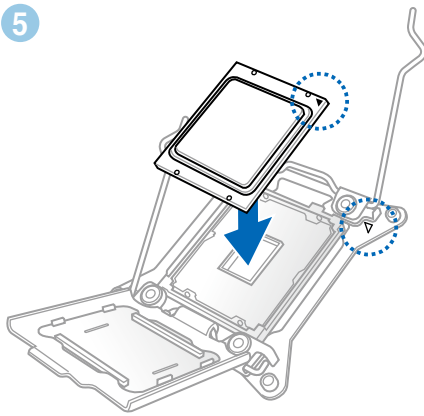

### 2.3.2 CPU heatsink and fan assembly installation

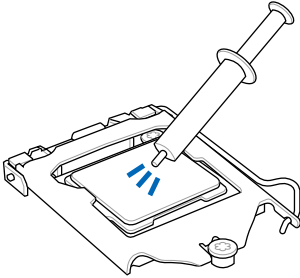

Apply the Thermal Interface Material to the CPU heatsink and CPU before you install the heatsink and fan if necessary.

#### To install the CPU heatsink and fan assembly

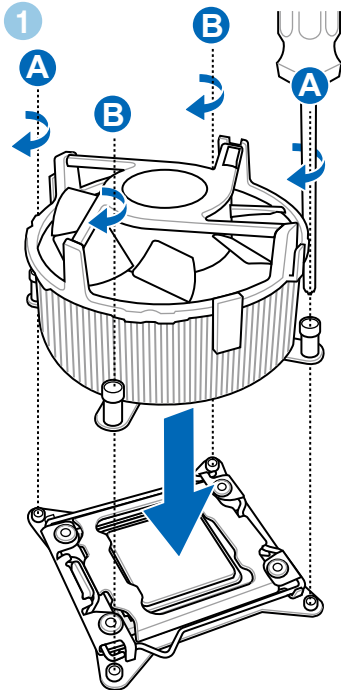

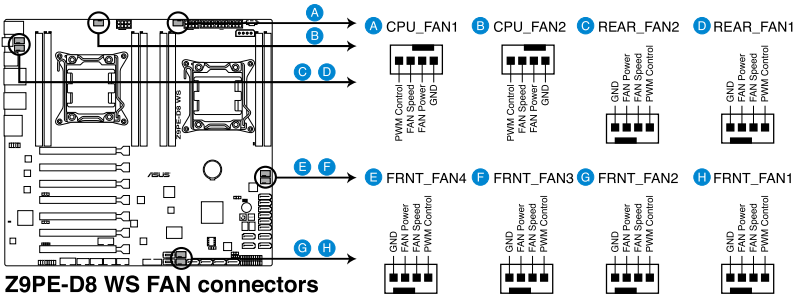
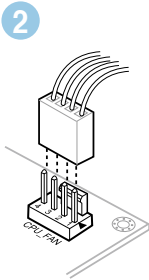

DO NOT forget to connect the **CPU\_FAN** connector! Hardware monitoring errors can occur if you fail to plug this connector.

## 2.4 System memory

### 2.4.1 Overview

The motherboard comes with eight (four DIMM per CPU) Double Data Rate 3 (DDR3) Dual Inline Memory Modules (DIMM) sockets.

A DDR3 module has the same physical dimensions as a DDR2 DIMM but is notched differently to prevent installation on a DDR2 DIMM socket. DDR3 modules are developed for better performance with less power consumption.

The figure illustrates the location of the DDR3 DIMM sockets:



A DDR3 module is notched differently from a DDR or DDR2 module. DO NOT install a DDR or DDR2 memory module to the DDR3 slot.

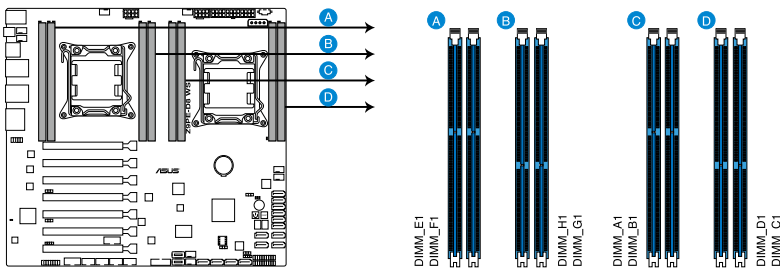

**Z9PE-D8 WS 240-pin DDR3 DIMM sockets**

### 2.4.2 Memory Configurations

You may install 1GB, 2GB, 4GB, 8GB, 16GB and 32GB\* RDIMMs or 1GB, 2GB, 4GB and 8GB\* with ECC/Non-ECC UDIMMs or 8GB, 16GB and 32GB\* LR-DIMMs into the DIMM sockets using the memory configurations in this section.

1 CPU Configuration (must on CPU1)				
	DIMM_A1	DIMM_B1	DIMM_C1	DIMM_D1
1 DIMMs	X			
2 DIMMs	X	X		
4 DIMMs	X	X	X	X



- \*Refer to ASUS Server AVL for latest update.
- Install the DIMMs starting from slot A1 (CPU1) and E1 (CPU2).
- Always install DIMMs with the same CAS latency. For optimum compatibility, it is recommended that you obtain memory modules from the same vendor.

2 CPU Configuration				
	DIMM_A1	DIMM_B1	DIMM_C1	DIMM_D1
1 DIMMs	X			
2 DIMMs	X			
4 DIMMs	X	X		
8 DIMMs	X	X	X	X

2 CPU Configuration				
	DIMM_E1	DIMM_F1	DIMM_G1	DIMM_H1
1 DIMMs				
2 DIMMs	X			
4 DIMMs	X	X		
8 DIMMs	X	X	X	X

### 2.4.3 Installing a DIMM



Ensure to unplug the power supply before adding or removing DIMMs or other system components. Failure to do so may cause severe damage to both the motherboard and the components.

1. Unlock a DIMM socket by pressing the retaining clip outward.
2. Align a DIMM on the socket such that the notch on the DIMM matches the DIMM slot key on the socket.

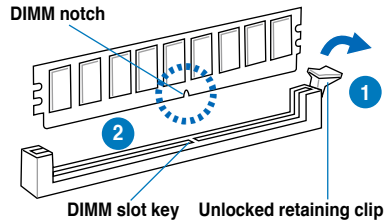

A DIMM is keyed with a notch so that it fits in only one direction. DO NOT force a DIMM into a socket in the wrong direction to avoid damaging the DIMM.

3. Hold the DIMM by both of its ends, then insert the DIMM vertically into the socket. Apply force to both ends of the DIMM simultaneously until the retaining clip snaps back into place, and the DIMM cannot be pushed in any further to ensure proper sitting of the DIMM.

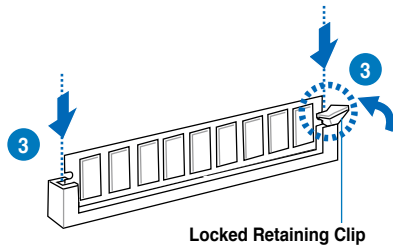

---

Always insert the DIMM into the socket VERTICALLY to prevent DIMM notch damage.

---

## 2.4.4 Removing a DIMM

1. Press the retaining clip outward to unlock the DIMM.
2. Remove the DIMM from the socket.

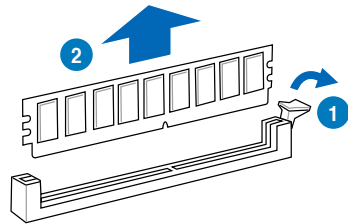

---

Support the DIMM lightly with your fingers when pressing the retaining clip. The DIMM might get damaged when it flips out with extra force.

---



## 2.5 Front panel assembly

Before you can install a 5.25-inch drive, you should first remove the front panel assembly (front bezel and front panel cover).

### 2.5.1 Removing the front panel assembly

To remove the front panel assembly:

1. Locate the three hooked tabs on the chassis side rail.
2. Shift the hooked tabs and take off the front bezel.

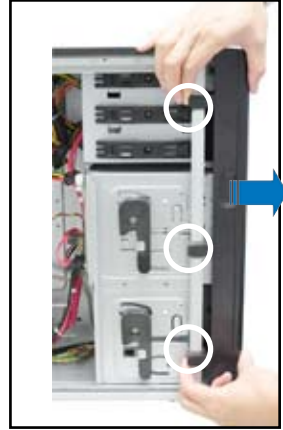

### 2.5.2 Reinstalling the front panel assembly

To reinstall the front panel assembly:

1. Hook the other side of the front panel assembly to the chassis.
2. Swing the front panel assembly and snap it back into place.



## 2.6 5.25-inch drives



Ensure to unplug the power cable before installing or removing any system components. Failure to do so may cause damage to the motherboard and other system components!

The system comes with three 5.25-inch drive bays located on the upper front part of the chassis. An optical drive that comes standard/ optional with the system package occupies the uppermost bay (labeled 1). The lower bays (labeled 2 and 3) are available for additional 5.25-inch optical, zip, or floppy disk drives.



You must remove the front panel assembly before installing a 5.25-inch drive.

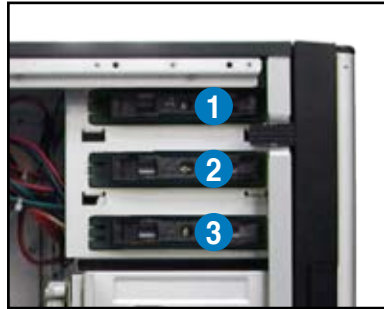

### Installing a 5.25-inch drive

1. Unscrew and remove the metal cover of the bay where you want to install the 5.25-inch drive, and take off the plastic cover on the front bezel at the same position.
2. Insert the drive into the bay and slide the bay lock to the right until it clicks in place.
3. Connect the SATA cable to the SATA connector on the back of the drive.
4. Connect a power plug from the power supply to the power connector on the back of the drive.

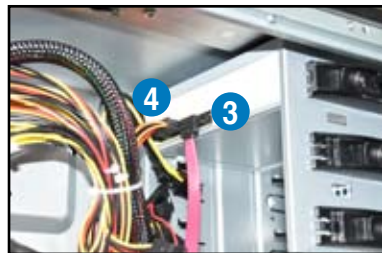

## 2.7 SATA hard disk drives

The hard disk drive module cage on the front panel, including externally removable trays for mounting SATA hard disk drives, allows you to access the drive trays by simply opening the front bezel.



An HDD module cage comes with a SATA backplane. Ensure of the type of HDD module cage you purchase before buying hard disks.

### 2.7.1 Installing the HDD module cage

1. Examine the chassis and ensure the bay space is free of wires and other obstructions.
2. Level the HDD module cage latch counterclockwise.
3. Insert the HDD module cage into the bay.

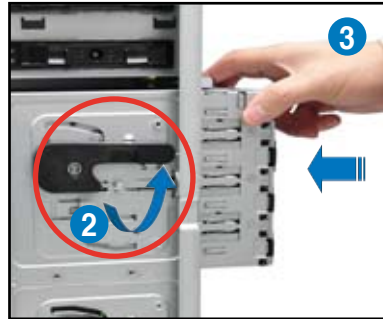

4. When the HDD module cage is completely inserted, the cage latch will be pushed back clockwise.



5. Lock the cage latch properly.
6. Connect the appropriate cables to the SATA backplane on the HDD module cage.



## 2.7.2 Removing the HDD module cage

1. Disconnect the all cables from the SATA backplane on the HDD module cage.
2. Level the HDD module cage latch counterclockwise. The HDD module cage will be pushed out of the chassis.



3. Completely pull out the HDD module cage.



## 2.7.3 Installing a hot-swap SATA hard disk drive

1. Release a drive tray by pushing the spring lock to the right, and then pulling the tray lever outward. The drive tray ejects slightly after you pull out the lever.



2. Firmly hold the tray lever and pull the drive tray out of the bay.



3. Take note of the drive tray holes. Each side has three holes to fit different types of hard disk drives. Use two screws on each side to secure the hard disk drive.



4. Place a SATA hard disk drive on the tray, and then secure it with four screws.



5. Carefully insert the drive tray and push it all the way to the depth of the bay until just a small fraction of the tray edge protrudes.



When installed, the SATA connector on the drive connects to the SATA interface on the backplane.

6. Push the tray lever until it clicks, and secures the drive tray in place. The drive tray is correctly placed when its front edge aligns with the bay edge.
7. Repeat steps 1 to 6 if you wish to install a second SATA drive.



## 2.7.4 Removing and reinstalling the backplane



DO NOT remove the backplane unless necessary!

1. Remove all hot-swap HDD trays from the chassis.
2. Disconnect all cables from the SATA backplane.
3. Loosen the four screws on the backplane.

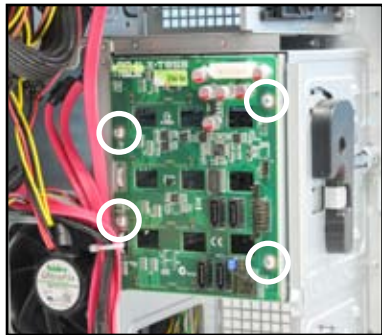

4. Firmly hold the backplane, lift it up and remove it from the module.
5. Follow the previous instructions in reverse to reinstall the backplane.

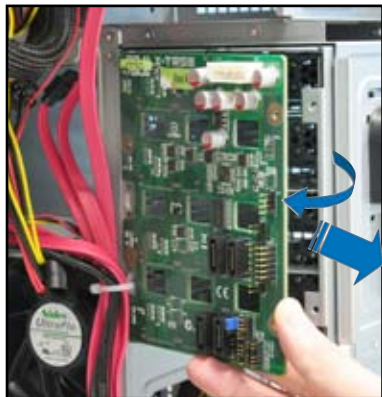

## 2.8 Expansion cards

The system is designed with an expansion card lock on the rear panel for you to install or remove an expansion card in less steps.



Ensure to unplug the power cord before installing or removing expansion cards. Failure to do so may cause severe damage to the motherboard and other system components!

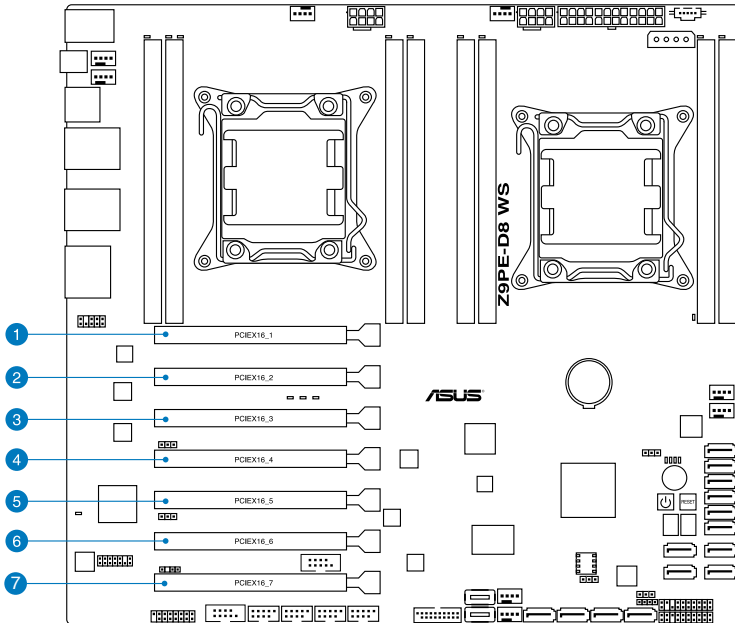

Slot No.	Slot Description
1	PCI-E x16 (Gen3 x16/ x8 mode, auto-switch to x8 mode when slot 2 is occupied)
2	PCI-E x16 (Gen3 x8 mode)
3	PCI-E x16 (Gen3 x16/ x8 mode; auto-switch to x8 mode when slot 4 is occupied)
4	PCI-E x16 (Gen3 x8 mode)
5	PCI-E x16 (Gen3 x16 mode)
6	PCI-E x16 (Gen3 x8 mode)
7	PCI-E x16 (Gen3 x16 mode)

## 2.8.1 Installing an expansion card

1. Before installing the expansion card, read the documentation that came with it and make the necessary hardware settings for the card.
2. Lay the system on its side on a flat, stable surface.
3. Push down the expansion card lock latch (step a) and lift up the expansion card lock (step b), as shown in the right figure.

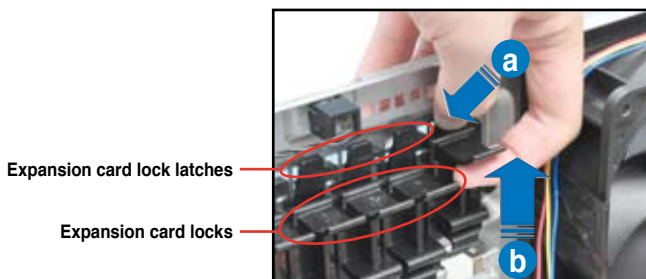

4. Remove the metal slot cover opposite the slot where you wish to install an expansion card.



5. Align the card golden fingers with the slot, and then press firmly until the card is completely seated on the slot.





- Restore the expansion card lock to its original position. A light click indicates that the card is locked in place.

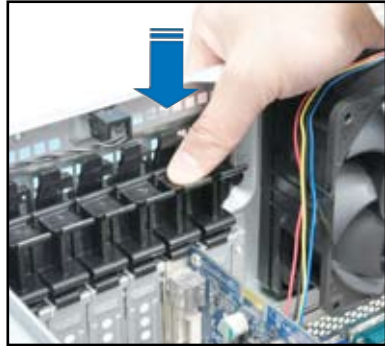

## 2.8.2 Configuring an expansion card

After installing the expansion card, configure it by adjusting the software settings.

- Turn on the system and change the necessary BIOS settings, if any. See Chapter 4 for information on BIOS setup.
- Install the software drivers for the expansion card.

### IRQ assignments for this motherboard

	A	B	C	D	E	F	G	H
PCIEx16_1	shared	-	-	-	-	-	-	-
PCIEx16_2	shared	-	-	-	-	-	-	-
PCIEx16_3	shared	-	-	-	-	-	-	-
PCIEx16_4	shared	-	-	-	-	-	-	-
PCIEx16_5	shared	-	-	-	-	-	-	-
PCIEx16_6	shared	-	-	-	-	-	-	-
PCIEx16_7	shared	-	-	-	-	-	-	-
Marvell9230	shared	-	-	-	-	-	-	-
VIA1394	-	-	shared	-	-	-	-	-
Asmedia USB3.0-1	-	-	shared	-	-	-	-	-
Asmedia USB3.0-2	-	-	-	shared	-	-	-	-
LAN1 (82574L)	shared	-	-	-	-	-	-	-
LAN2 (82574L)	-	shared	-	-	-	-	-	-
SATA Controller 1	-	-	-	shared	-	-	-	-
SATA Controller 2	-	-	-	shared	-	-	-	-
USB 2.0 Controller 1	-	-	-	-	-	-	-	shared
USB 2.0 Controller 2	-	shared	-	-	-	-	-	-
HD Audio	-	-	-	-	-	-	shared	-

## 2.9 Cable connections



- The bundled system cables are pre-connected before shipment. You do not need to disconnect these cables unless you will remove pre-installed components to install additional devices.
- Refer to Chapter 3 for detailed information on the connectors.

### 2.9.1 Motherboard connections

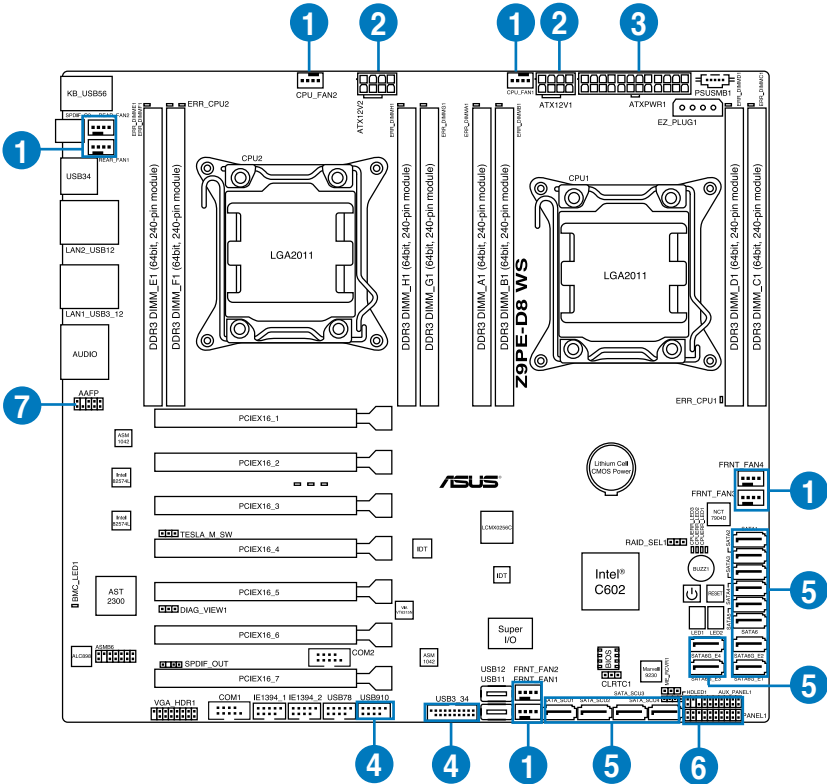

### Standard cables connected to the motherboard

1. System fan connectors (from power supply to motherboard)
2. 8-pin 12V power connectors (from power supply to motherboard)
3. 24-pin ATX power connector (from system fan to motherboard)
4. Front panel USB connectors (from motherboard to front I/O board)
5. SATA connectors (from motherboard to SATA backplane)
6. System/Auxiliary panel connectors (from motherboard to front I/O board)
7. Front panel audio connector (from motherboard to front I/O board)

## 2.9.2 SATA backplane connections

An SATA backplane comes pre-installed in the ESC2000 G2. The SATA backplane has four 22-pin SATA connectors to support Serial ATA hard disk drives. The backplane design incorporates a hot swap feature to allow easy connection or removal of SATA hard disks. The LEDs on the backplane connect to the front panel LEDs to indicate HDD status. See section **1.7 LED information** for details.

### Front side

The front side of the SATA backplane faces the front panel when installed. This side includes four SATA connectors for the hot swap drive trays.

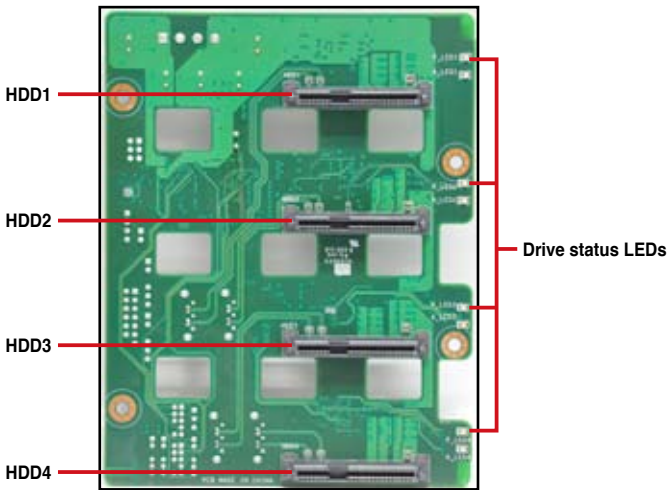

Each SATA connector is labeled (HDD1, HDD2, HDD3, HDD4) so you can easily determine their counterpart connectors at the back side of the backplane. Refer to the table for reference.



HDD Device	Front side connector	Back side connector
HDD 1	HDD1	CON1
HDD 2	HDD2	CON2
HDD 3	HDD3	CON3
HDD 4	HDD4	CON4

## Back side

The back side of the SATA backplane faces the rear panel when installed. This side includes the power connectors and SATA interfaces for the motherboard Serial ATA connectors.

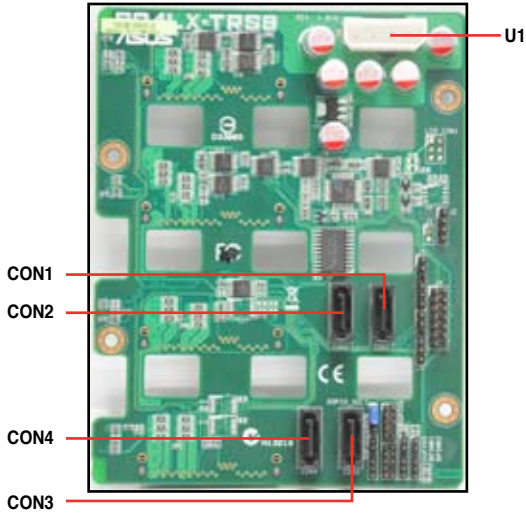

Connectors	Description
U1	Connects to 4-pin plug of the power supply
CON1/CON2/ CON3/CON4	Connects to SATA/SAS connectors on the motherboard

## 2.10 Removable components

You may need to remove previously installed system components when installing or removing system devices, or when you need to replace defective components. This section tells how to remove the front and rear system fans.

### 2.10.1 Removing rear system fan

To remove the rear system fan:

1. Unplug the system fan cable from the **CHA\_FAN1** connector on the motherboard.

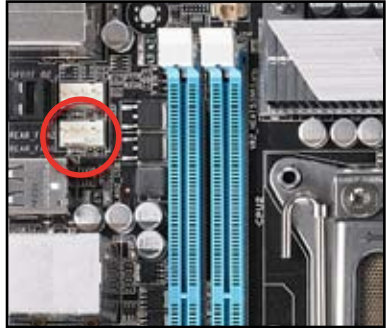

2. Shift the two hooked tabs leftward and rightward respectively.

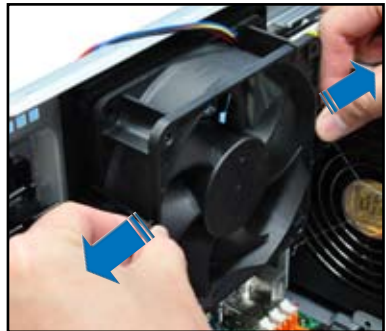

- Carefully take off the system fan.
- Follow the previous instructions in reverse to reinstall the rear system fan.



### 2.10.2 Removing front system fan

To remove the front system fan:

- Remove the two screws that secure the right side cover.

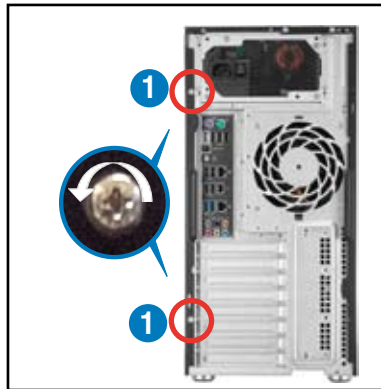

- Locate the front system fan near the 5.25-inch drive bays.
- Squeeze the front system fan latches (step a) and pull out the front system fan (step b), as shown in the right figure.
- Follow the previous instructions in reverse to reinstall the front system fan.

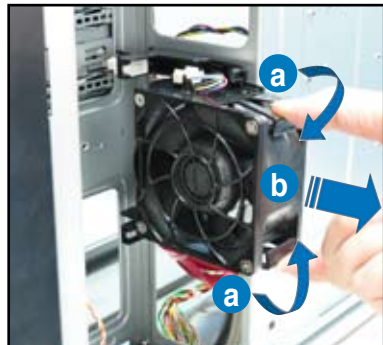

## 2.11 Installing the ASMB6 management board

Follow the steps below to install an optional ASMB management board on your motherboard.

1. Locate the ASMB6 header on the motherboard.



2. Orient and press the ASMB6 management card in place

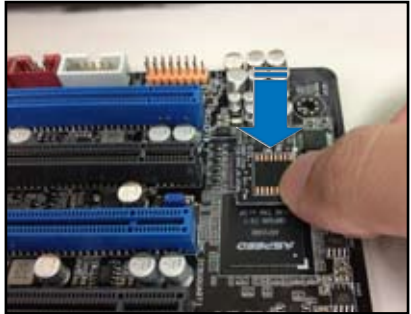





# Chapter 3

This chapter gives information about the motherboard that comes with the workstation. This chapter includes the motherboard layout, jumper settings, and connector locations.



ASUS ESC2000 G2

# Motherboard Info

# 3.1 Motherboard layout

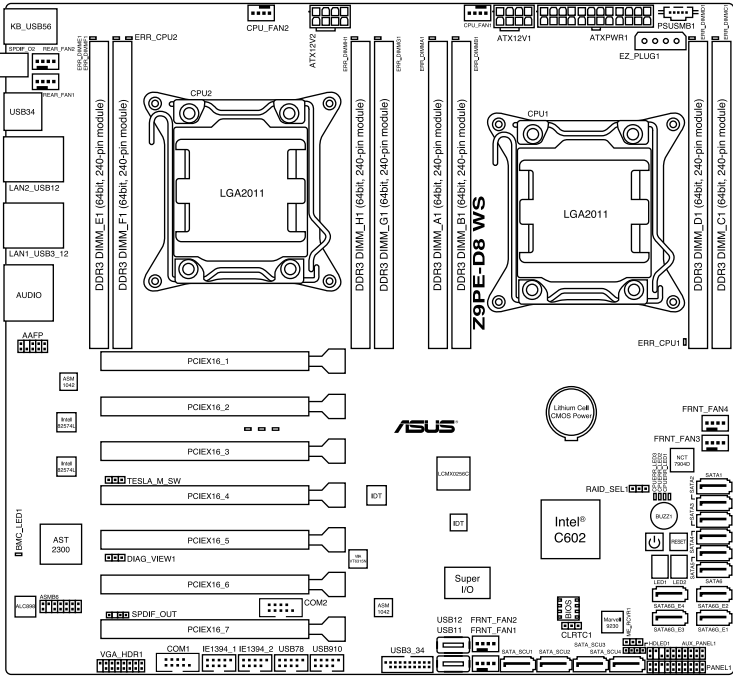

Refer to **3.5 Connectors** for more information about rear panel connectors and internal connectors.

## Layout contents

Internal connectors		Page
1.	Hard disk activity LED connector (4-pin HDLED1)	3-21
2.	USB connectors (10-1 pin USB78, USB910; A-type USB 12/11)	3-22
3.	USB connectors (USB3_34)	3-22
4.	CPU, front and rear fan connectors (4-pin CPU_FAN1-2, FRNT_FAN1-4, REAR_FAN1-2)	3-21
5.	Power supply SMBus Connector (PSUSMB1)	3-23
6.	Serial port connectors (10-1 pin COM1/COM2)	3-23
7.	Serial ATA 6.0/3.0 Gb/s connectors (7-pin SATA6G_1-2 [blue]; 7-pin SATA3G_3-6 [black])	3-19
8.	Marvell Serial ATA 6.0 Gb/s connectors (7-pin SATA6G_E1/E2/E3/E4 [gray])	3-18
9.	Serial ATA SCU connectors (7-pin SATA_SCU1-4 [black])	3-19
10.	EATX power connectors (24-pin EATXPWR1, 8-pin EATX12V1/EATX12V2)	3-20
11.	System panel connector (20-1 pin PANEL1)	3-24
12.	Auxiliary panel connector (20-2 pin AUX_PANEL1)	3-25
13.	Digital audio connector (4-1 pin SPDIF_OUT)	3-26
14.	IEEE 1394a port connectors (10-1 pin IE1394_1/2)	3-26
15.	VGA connector (VGA_HDR1)	3-27
16.	Front panel audio connector (10-1 pin AAFP)	3-27
17.	ASMB6 header (ASMB6)	3-28

Jumpers		Page
1.	Clear RTC RAM (CLRTC1)	3-5
2.	VGA Controller setting (DIAG_VIEW1)	3-6
3.	SMBUS connection setting (TESLA_M_SW)	3-6
4.	LSI MegaRAID or Intel RSTe selection jumper (3-pin RAID_SEL1)	3-7
5.	ME firmware force recovery setting (3-pin ME_RCVR1)	3-7

<b>Onboard LEDs</b>		<b>Page</b>
1.	Standby power LEDs	3-9
2.	DIMM Error LED (ERR_DIMM)	3-9
3.	Baseboard Management Controller LED (BMC_LED1)	3-10
4.	Q-Code LED (LED1_LED2)	3-11

<b>Slots/Socket</b>		<b>Page</b>
1.	CPU sockets	2-5
2.	DDR3 sockets	2-10
3.	PCI Express x8 / PCI Express x16 slots	2-19

<b>Onboard Buttons/switches</b>		<b>Page</b>
1.	Power on button	3-8
2.	Reset button	3-8

## 3.2 Jumpers

### 1. Clear RTC RAM (CLRRTC1)

This jumper allows you to clear the Real Time Clock (RTC) RAM in CMOS. You can clear the CMOS memory of date, time, and system setup parameters by erasing the CMOS RTC RAM data. The onboard button cell battery powers the RAM data in CMOS, which include system setup information such as system passwords.

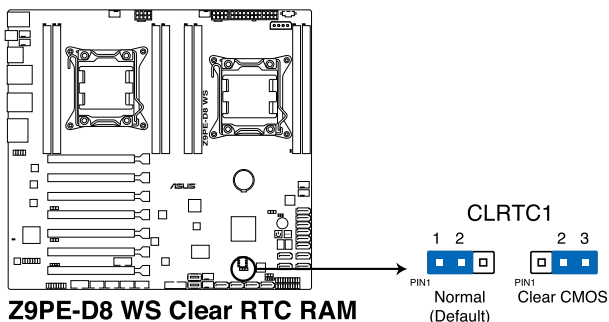

To erase the RTC RAM:

1. Turn OFF the computer and unplug the power cord.
2. Move the jumper cap from pins 1-2 (default) to pins 2-3. Keep the cap on pins 2-3 for about 5–10 seconds, then move the cap back to pins 1-2.
3. Plug the power cord and turn ON the computer.
4. Hold down the <Del> key during the boot process and enter BIOS setup to re-enter data.



Except when clearing the RTC RAM, never remove the cap on CLRRTC jumper default position. Removing the cap will cause system boot failure!



- If the steps above do not help, remove the onboard battery and move the jumper again to clear the CMOS RTC RAM data. After the CMOS clearance, reinstall the battery.
- You do not need to clear the RTC when the system hangs due to overclocking. For system failure due to overclocking, use the C.P.R. (CPU Parameter Recall) feature. Shut down and reboot the system so the BIOS can automatically reset parameter settings to default values.
- Due to the chipset behavior, AC power off is required to enable C.P.R. function. You must turn off and on the power supply or unplug and plug the power cord before rebooting the system.

**2. VGA controller setting (DIAG\_VIEW1)**

This jumper allows you to enable or disable the onboard VGA controller. Set to pins 1-2 to activate the VGA feature.

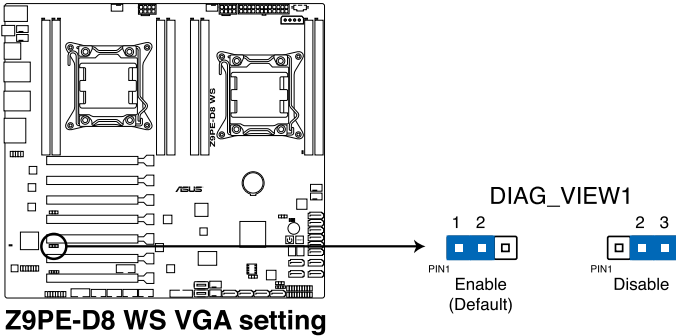

**3. SMBUS connection setting (TESLA\_M\_SW)**

This jumper allows you to select the connection to BMC or PHC for PCIE 1/3/5/7 SMBUS.

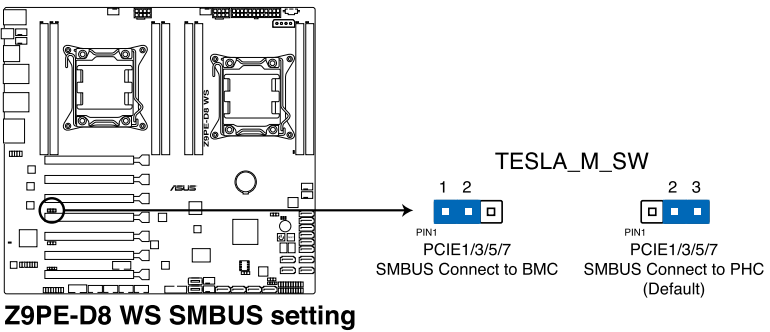

**4. LSI MegaRAID or Intel RSTe selection jumper (3-pin RAID\_SEL1)**

This jumper allows you to select the PCH SATA RAID mode to use LSI MegaRAID software or Intel® Rapid Storage Technology enterprise 3.0 RAID. Place the jumper caps over pins 1–2 if you want to use the LSI MegaRAID software RAID Utility (default); otherwise, place the jumper caps over pins 2–3 to use the Intel® Rapid Storage Technology Enterprise Option ROM Utility.

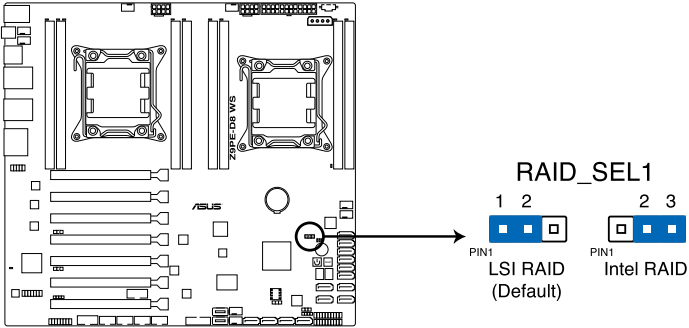

**Z9PE-D8 WS RAID setting**

**5. ME firmware force recovery setting (3-pin ME\_RCVR1)**

This jumper allows you to force Intel Management Engine (ME) boot from recovery mode when ME become corrupted.

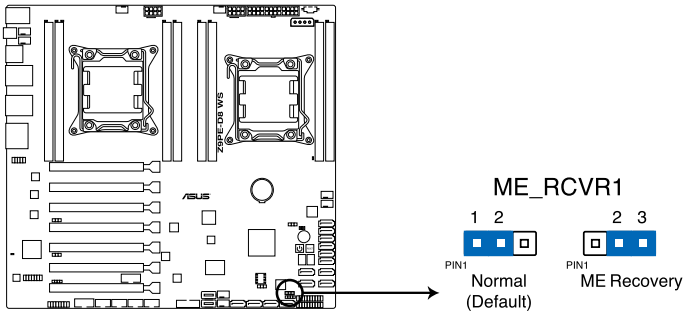

**Z9PE-D8 WS ME recovery setting**

### 3.3 Onboard buttons and switches

Onboard buttons and switches allow you to fine-tune performance when working on a bare or open-case system. This is ideal for overclockers and gamers who continually change settings to enhance system performance.

#### 1. Power-on button

The motherboard comes with a power-on button that allows you to power up or wake up the system. The button also lights up when the system is plugged to a power source indicating that you should shut down the system and unplug the power cable before removing or plugging in any motherboard component. The illustration below shows the location of the onboard power-on button.

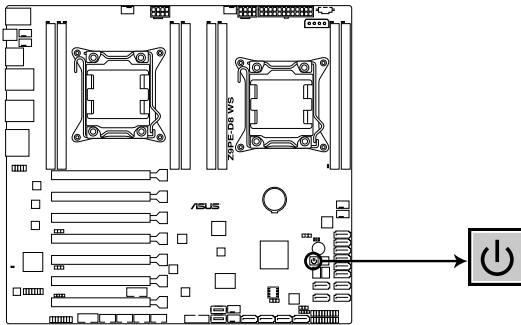

**Z9PE-D8 Power on button**

#### 2. Reset button

Press the reset button to reboot the system.

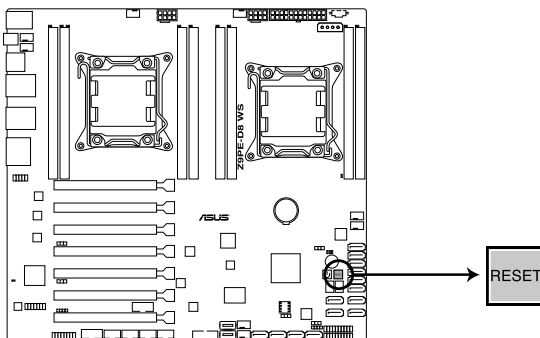

**Z9PE-D8 WS Reset button**



## 3.4 Onboard LEDs

### 1. Standby Power LEDs

The motherboard comes with a standby power LED that lights up to indicate that the system is ON, in sleep mode, or in soft-off mode. This is a reminder that you should shut down the system and unplug the power cable before removing or plugging in any motherboard component. The illustration below shows the location of the onboard LED. The Standby Power LEDs will light up once the system is connected to a power source

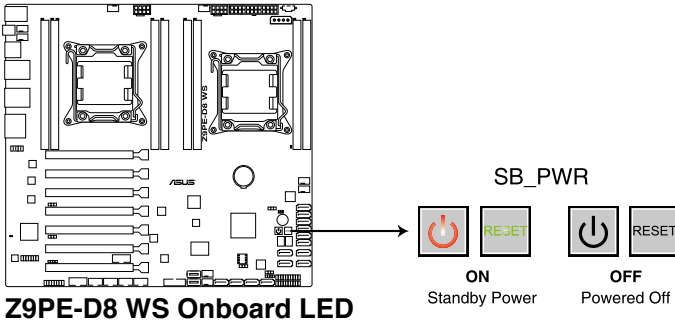

### 2. DIMM Error LED (ERR\_DIMM)

These LEDs light up to indicate an error in its nearby DIMM.

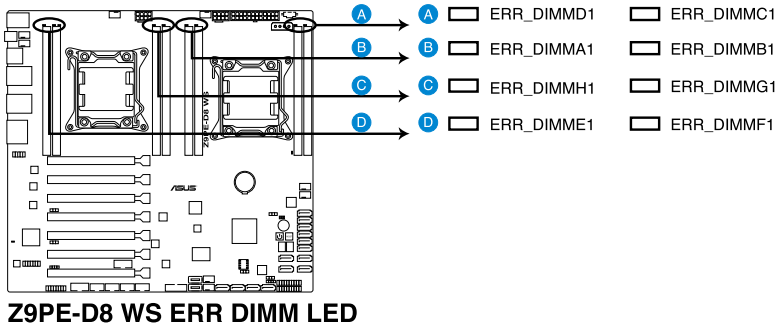

Enabled only with ASMB6-i KVM on-board.

### 3. Baseboard Management Controller LED (BMC\_LED1)

The BMC LED works with the ASUS ASMB6 management device and indicates its initiation status. When the PSU is plugged and the system is OFF, ASUS ASMB6 management device starts system initiation for about one (1) minute. The BMC LED blinks after system initiation finishes.

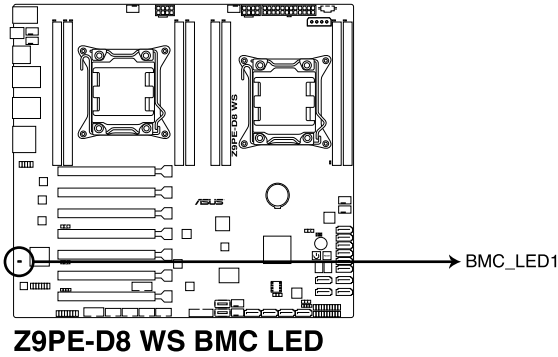

#### 4. Q-Code LEDs

The Q-Code LED design provides you the 2-digit display, allowing you to know the system status. Refer to the Q-Code table below for details.

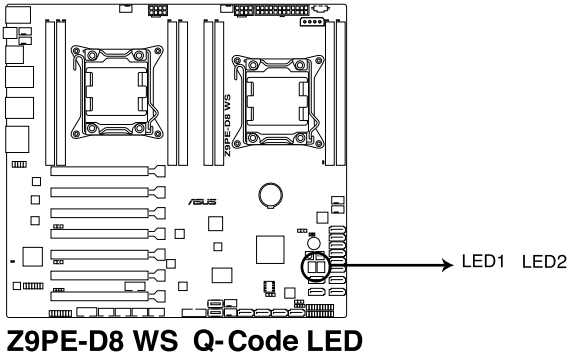

#### Q-Code table

Code	Description
00	Not used
01	Power on. Reset type detection (soft/hard).
02	AP initialization before microcode loading
03	System Agent initialization before microcode loading
04	PCH initialization before microcode loading
06	Microcode loading
07	AP initialization after microcode loading
08	System Agent initialization after microcode loading
09	PCH initialization after microcode loading
0A	Initialization after microcode loading
0B	Cache initialization
0C – 0D	Reserved for future AMI SEC error codes
0E	Microcode not found
0F	Microcode not loaded
10	PEI Core is started
11 – 14	Pre-memory CPU initialization is started
15 – 18	Pre-memory System Agent initialization is started
19 – 1C	Pre-memory PCH initialization is started
2B – 2F	Memory initialization
30	Reserved for ASL (see ASL Status Codes section below)

## Q-Code table (continued)

Code	Description
31	Memory Installed
32 – 36	CPU post-memory initialization
37 – 3A	Post-Memory System Agent initialization is started
3B – 3E	Post-Memory PCH initialization is started
4F	DXE IPL is started
50 – 53	Memory initialization error. Invalid memory type or incompatible memory speed
54	Unspecified memory initialization error
55	Memory not installed
56	Invalid CPU type or Speed
57	CPU mismatch
58	CPU self test failed or possible CPU cache error
59	CPU micro-code is not found or micro-code update is failed
5A	Internal CPU error
5B	Reset PPI is not available
5C – 5F	Reserved for future AMI error codes
E0	S3 Resume is started (S3 Resume PPI is called by the DXE IPL)
E1	S3 Boot Script execution
E2	Video repost
E3	OS S3 wake vector call
E4 – E7	Reserved for future AMI progress codes
E8	S3 Resume Failed
E9	S3 Resume PPI not Found
EA	S3 Resume Boot Script Error
EB	S3 OS Wake Error
EC – EF	Reserved for future AMI error codes
F0	Recovery condition triggered by firmware (Auto recovery)
F1	Recovery condition triggered by user (Forced recovery)
F2	Recovery process started
F3	Recovery firmware image is found
F4	Recovery firmware image is loaded
F5 – F7	Reserved for future AMI progress codes
F8	Recovery PPI is not available
F9	Recovery capsule is not found
FA	Invalid recovery capsule
FB – FF	Reserved for future AMI error codes
60	DXE Core is started
61	NVRAM initialization
62	Installation of the PCH Runtime Services

## Q-Code table (continued)

Code	Description
AC	Reserved for ASL (see ASL Status Codes section below)
AD	Ready To Boot event
AE	Legacy Boot event
AF	Exit Boot Services event
B0	Runtime Set Virtual Address MAP Begin
B1	Runtime Set Virtual Address MAP End
B2	Legacy Option ROM Initialization
B3	System Reset
B4	USB hot plug
B5	PCI bus hot plug
B6	Clean-up of NVRAM
B7	Configuration Reset (reset of NVRAM settings)
B8– BF	Reserved for future AML codes
D0	CPU initialization error
D1	System Agent initialization error
D2	PCH initialization error
D3	Some of the Architectural Protocols are not available
D4	PCI resource allocation error. Out of Resources
D5	No Space for Legacy Option ROM
D6	No Console Output Devices are found
D7	No Console Input Devices are found
D8	Invalid password
D9	Error loading Boot Option (LoadImage returned error)
DA	Boot Option is failed (StartImage returned error)
DB	Flash update is failed
DC	Reset protocol is not available

## ACPI/ASL Checkpoints

Code	Description
0x01	System is entering S1 sleep state
0x02	System is entering S2 sleep state
0x03	System is entering S3 sleep state
0x04	System is entering S4 sleep state
0x05	System is entering S5 sleep state
0x10	System is waking up from the S1 sleep state
0x20	System is waking up from the S2 sleep state
0x30	System is waking up from the S3 sleep state
0x40	System is waking up from the S4 sleep state
0xAC	System has transitioned into ACPI mode. Interrupt controller is in PIC mode.
0xAA	System has transitioned into ACPI mode. Interrupt controller is in APIC mode.

## 3.5 Connectors

### 3.5.1 Rear panel connectors

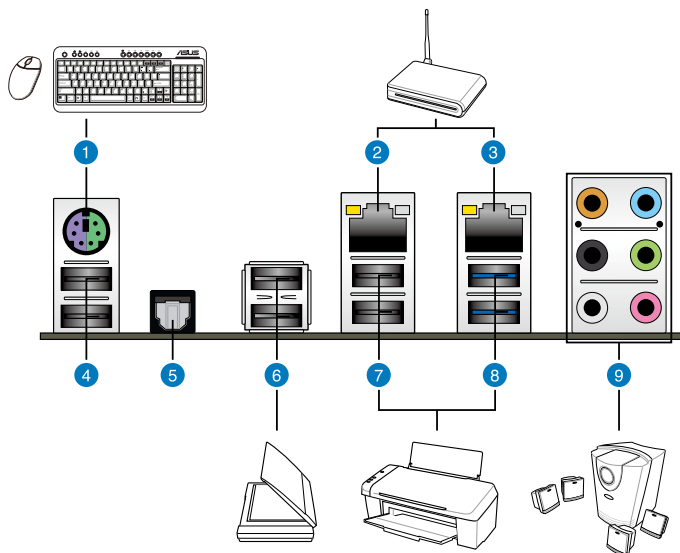

#### Rear panel connectors

1.	PS/2 keyboard/mouse combo port	6.	USB 2.0 ports 3 and 4
2.	LAN (RJ-45) port 2*	7.	USB 2.0 ports 1 and 2
3.	LAN (RJ-45) port 1*	8.	USB 3.0 ports 1 and 2
4.	USB 2.0 ports 5 and 6	9.	Audio I/O ports**
5.	Optical S/PDIF out port		

\*and \*\*: Refer to the tables on the next page for LAN port and audio port definitions.



- Due to USB 3.0 controller limitation, USB 3.0 devices can only be used under Windows® OS environment and after the USB 3.0 driver installation.
- USB 3.0 devices can only be used as data storage only.
- We strongly recommend that you connect USB 3.0 devices to USB 3.0 ports for faster and better performance for your USB 3.0 devices.

**\* LAN port LED indications**

Activity Link LED		Speed LED	
Status	Description	Status	Description
OFF	No link	OFF	10 Mbps connection
ORANGE	Linked	ORANGE	100 Mbps connection
BLINKING	Data activity	GREEN	1 Gbps connection

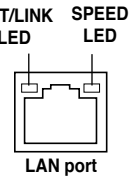

**\*\*Audio 2, 4, 6, or 8-channel configuration**

Port	Headset 2-channel	4-channel	6-channel	8-channel
Light Blue	Line In	Line In	Line In	Line In
Lime	Line Out	Front Speaker Out	Front Speaker Out	Front Speaker Out
Pink	Mic In	Mic In	Mic In	Mic In
Orange	–	–	Center/Subwoofer	Center/Subwoofer
Black	–	Rear Speaker Out	Rear Speaker Out	Rear Speaker Out
Gray	–	–	–	Side Speaker Out

**3.5.2 Audio I/O connections**

**Audio I/O ports**

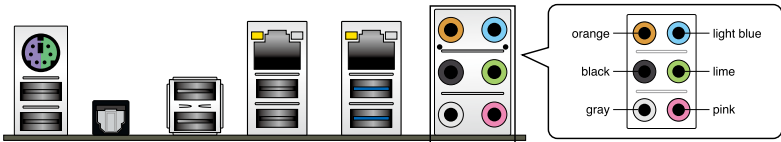

**Connect to Headphone and Mic**



### Connect to Stereo Speakers

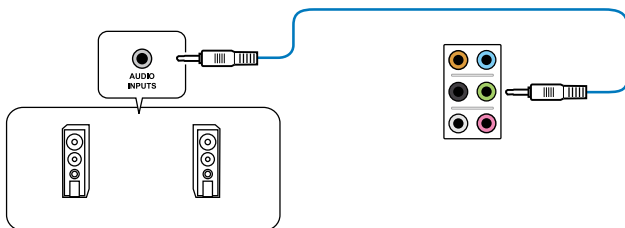

### Connect to 2.1 channel Speakers

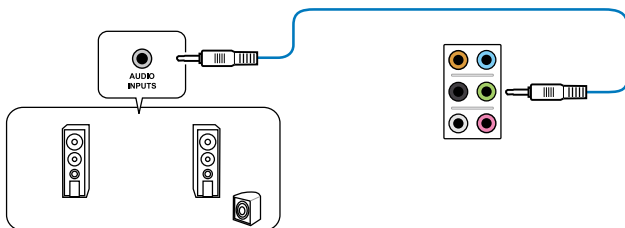

### Connect to 4.1 channel Speakers

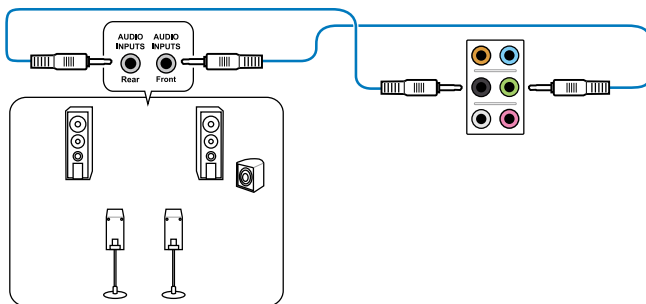



## Connect to 5.1 channel Speakers

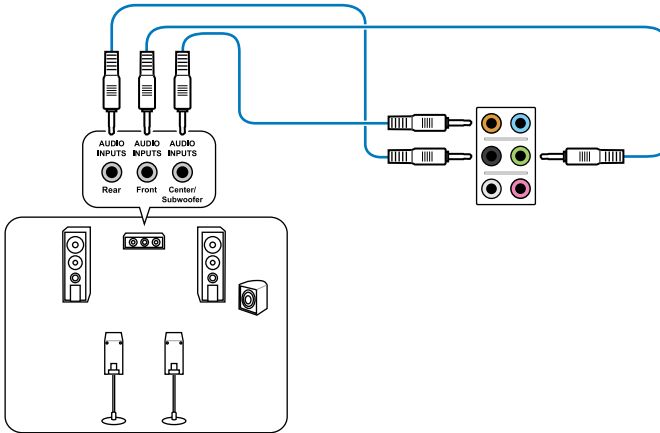

## Connect to 7.1 channel Speakers

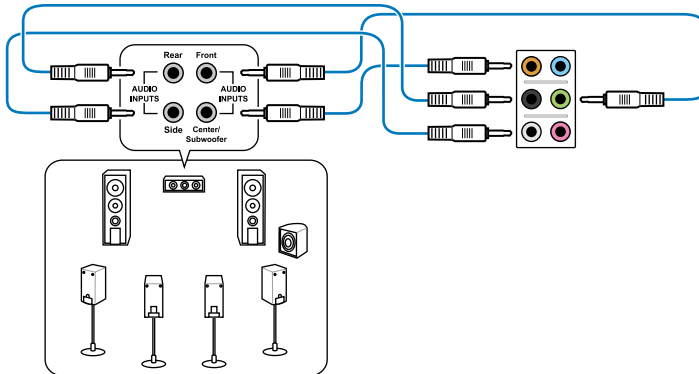

### 3.5.4 Internal connectors

#### 1. Marvell® Serial ATA 6.0 Gb/s connectors (7-pin SATA6G\_E1/E2/E3/E4 [gray])

These connectors connect to Serial ATA 6.0 Gb/s hard disk drives via Serial ATA 6.0 Gb/s signal cables.

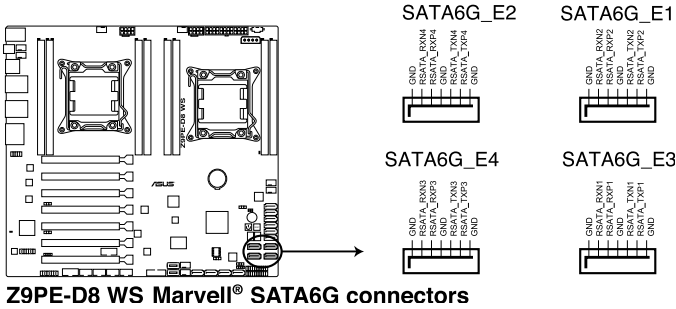

Z9PE-D8 WS Marvell® SATA6G connectors



- For high performance of ASUS SSD Caching, please connect one HDD and one SSD to Marvell® SATA6G\_E1/E2/E3/E4 connectors.
- For SSD Caching setup, you can use more than one SSD and only one HDD.
- You cannot use ASUS SSD Caching and Marvell® RAID at the same time.
- For regular usage, the SATA6G\_E1/E2/E3/E4 connectors are recommended for data drivers.
- You must install Windows® XP Service Pack 3 or later versions before using Serial ATA hard disk drives.
- Press <Ctrl> + <M> during POST to enter the Marvell® RAID utility to create or delete a RAID configuration.
- If you want to install a Windows operating system to a RAID configuration created using the Marvell® SATA controller, you have to create a RAID driver disk using the motherboard support DVD and load the driver during OS installation. For 32/64bit Windows XP OS, load first the **Marvell® shared library** driver, and then load **Marvell® 92xx SATA Controller Driver**. For Windows Vista / Windows 7 OS, load only the **Marvell® 92xx SATA Controller Driver**.

**2. Serial ATA 6.0/3.0 Gb/s connectors (7-pin SATA6G\_1-2 [blue]; 7-pin SATA3G\_3-6 [black])**

These connectors connect to Serial ATA 6.0Gb/s or 3.0 Gb/s hard disk drives and optical disc drives via Serial ATA 6.0Gb/s or 3.0 Gb/s signal cables.

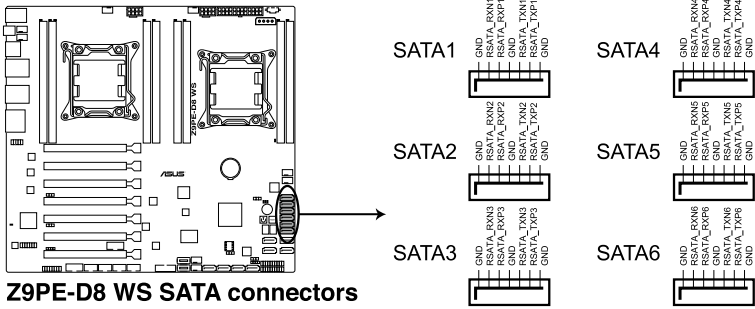

**Z9PE-D8 WS SATA connectors**

**3. Serial ATA SCU connectors (7-pin SATA\_SCU1-4 [black])**

These connectors connect to Serial ATA 3.0 Gb/s hard disk drives and optical disc drives via Serial ATA 3.0 Gb/s signal cables.

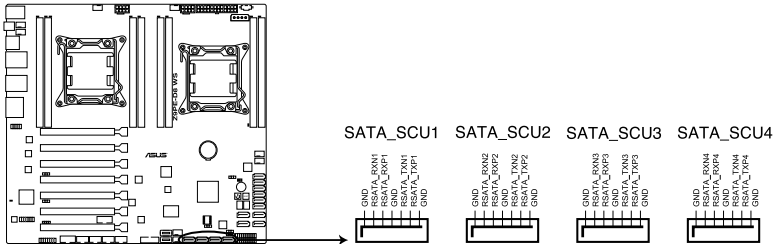

**Z9PE-D8 WS SATA3G connectors**

**4. EATX power connectors (24-pin EATXPWR1, 8-pin EATX12V1/EATX12V2)**

These connectors are for an EATX power supply plugs. The power supply plugs are designed to fit these connectors in only one orientation. Find the proper orientation and push down firmly until the connectors completely fit.

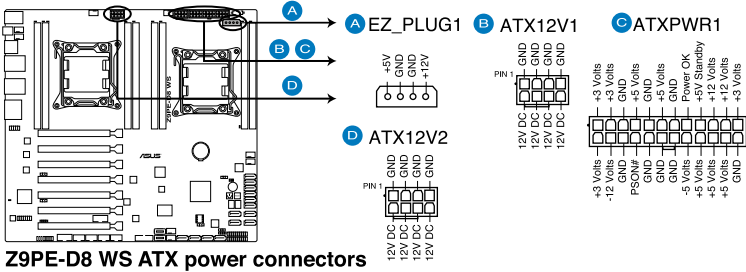

- DO NOT forget to connect the 24+8+8-pin power plugs; otherwise, the system will not boot up.
- Use of a PSU with a higher power output is recommended when configuring a system with more power-consuming devices. The system may become unstable or may not boot up if the power is inadequate.
- This motherboard supports EATX2.0 PSU or later version.
- Ensure that your power supply unit (PSU) can provide at least the minimum power required by your system.

**5. CPU, front and rear fan connectors (4-pin CPU\_FAN1-2, FRNT\_FAN1-4, REAR\_FAN1-2)**

The fan connectors support cooling fans. Connect the fan cables to the fan connectors on the motherboard, ensuring that the black wire of each cable matches the ground pin of the connector.

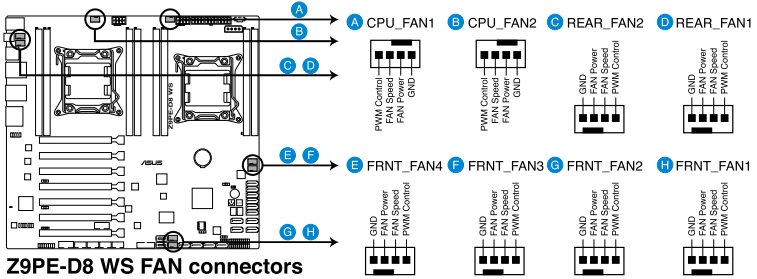

- DO NOT forget to connect the fan cables to the fan connectors. Insufficient air flow inside the system may damage the motherboard components.
- These are not jumpers! DO NOT place jumper caps on the fan connectors!
- All fans feature the ASUS Fan Speed Control technology.

**6. Hard disk activity LED connector (4-pin HDLED1)**

This LED connector is for the storage add-on card cable connected to the SATA or SAS add-on card. The read or write activities of any device connected to the SATA or SAS add-on card causes the front panel LED to light up.

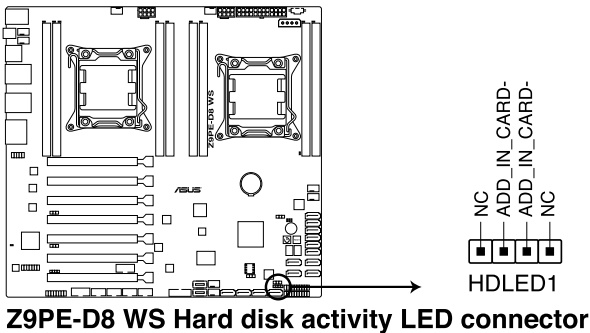

**7. USB connectors (10-1 pin USB78, USB910; A-Type USB12/11)**

These connectors are for USB 2.0 ports. Connect the USB module cables to connectors USB78 and USB910, then install the modules to a slot opening at the back of the system chassis. These USB connectors comply with USB 2.0 specification that supports up to 480 Mbps connection speed.

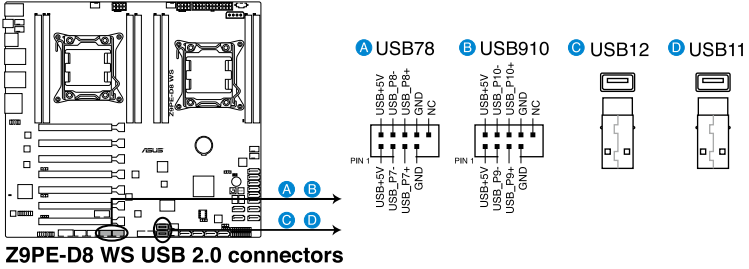

**8. USB connectors (USB3\_34)**

This connector is for USB 3.0 ports. Connect the USB module cable to connector USB3\_34.

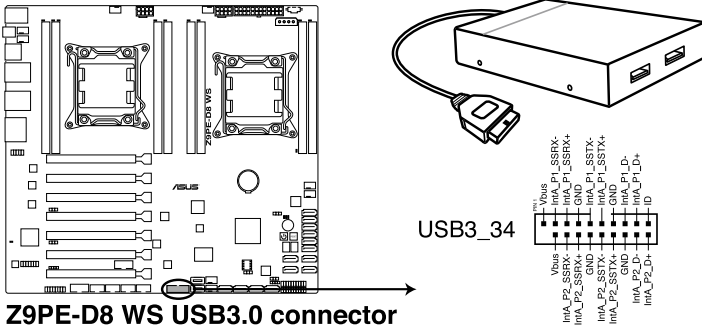

**9. Power supply SMBus Connector (PSUSMB1)**

This connector supplies power for low-speed system management communications.

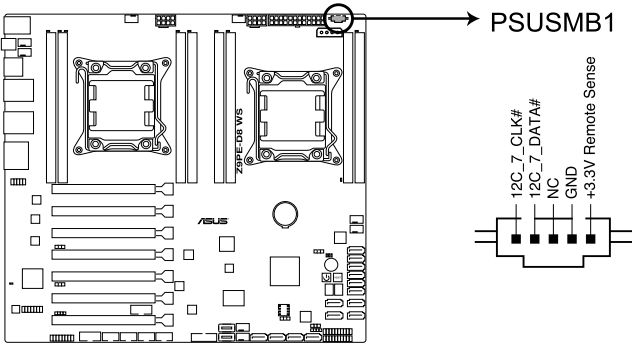

**Z9PE-D8 WS Power supply SMBus connector**

**10. Serial port connectors (10-1 pin COM1/COM2)**

These connectors are for the serial (COM) ports. Connect the serial port module cable to one of these connectors, then install the module to a slot opening at the back of the system chassis.

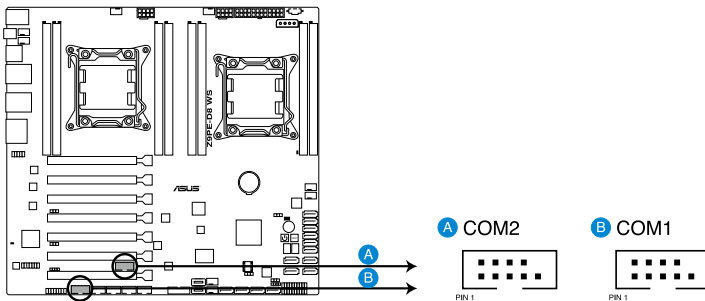

**Z9PE-D8 WS Serial port connectors**

### 11. System panel connector (20-1 pin PANEL1)

This connector supports several chassis-mounted functions.

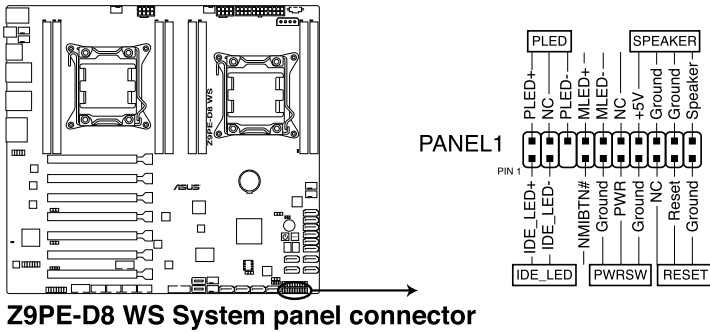

**Z9PE-D8 WS System panel connector**

#### (1) System power LED (3-pin PLED)

This 3-pin connector is for the system power LED. Connect the chassis power LED cable to this connector. The system power LED lights up when you turn on the system power, and blinks when the system is in sleep mode.

#### (2) System warning speaker (4-pin SPEAKER)

This 4-pin connector is for the chassis-mounted system warning speaker. The speaker allows you to hear system beeps and warnings.

#### (3) Hard disk drive activity LED (2-pin HDDLED)

This 2-pin connector is for the HDD Activity LED. Connect the HDD Activity LED cable to this connector. The HDD LED lights up or flashes when data is read from or written to the HDD.

#### (4) Power button/soft-off button (2-pin PWRSW)

This connector is for the system power button. Pressing the power button turns the system on or puts the system in sleep or soft-off mode depending on the BIOS settings. Pressing the power switch for more than four seconds while the system is ON turns the system OFF.

#### (5) Reset button (2-pin RESET)

This 2-pin connector is for the chassis-mounted reset button for system reboot without turning off the system power.



## 12. Auxiliary panel connector (20-2 pin AUX\_PANEL1)

This connector is for additional front panel features including front panel SMB, locator LED and switch, chassis intrusion, and LAN LEDs.

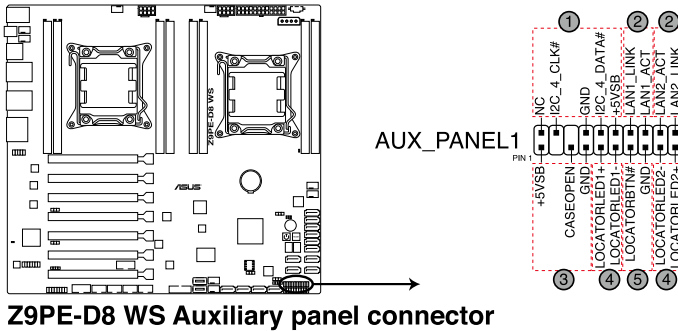

**Z9PE-D8 WS Auxiliary panel connector**

### (1) Front panel SMB (6-1 pin FPSMB)

These leads connect the front panel SMBus cable.

### (2) LAN activity LED (2-pin LAN12\_LED)

These leads are for Gigabit LAN activity LEDs on the front panel.

### (3) Chassis intrusion (4-1 pin CHASSIS)

These leads are for the intrusion detection feature for chassis with intrusion sensor or microswitch. When you remove any chassis component, the sensor triggers and sends a high-level signal to these leads to record a chassis intrusion event. The default setting is short CASEOPEN and GND pin by jumper cap to disable the function.

### (4) Locator LED (2-pin LOCATORLED1 and 2-pin LOCATORLED2)

These leads are for the locator LED1 and LED2 on the front panel. Connect the Locator LED cables to these 2-pin connector. The LEDs will light up when the Locator button is pressed.

### (5) Locator Button/Switch (2-pin LOCATORBTN)

These leads are for the locator button on the front panel. This button queries the state of the system locator.

### 13. Digital audio connector (4-1 pin SPDIF\_OUT)

This connector is for an additional Sony/Philips Digital Interface (S/PDIF) port(s). Connect the S/PDIF Out module cable to this connector, then install the module to a slot opening at the back of the system chassis.

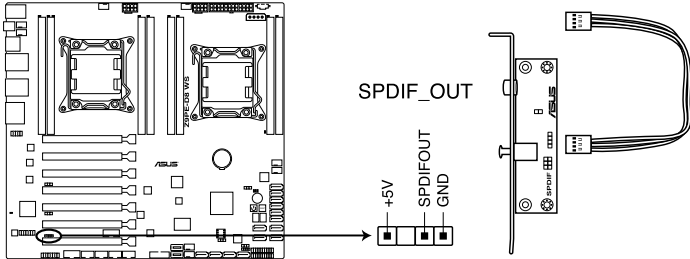

**Z9PE-D8 WS Digital audio connector**



The S/PDIF module is purchased separately.

### 14. IEEE 1394a port connectors (10-1 pin IE1394\_1/2)

These connectors are for IEEE 1394a port. Connect the IEEE 1394a module cable to this connector, then install the module to a slot opening at the back of the system chassis.

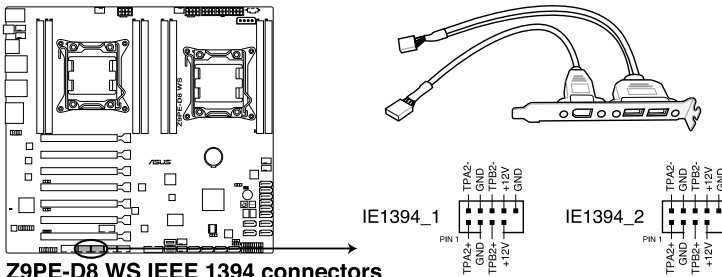

**Z9PE-D8 WS IEEE 1394 connectors**



Never connect a USB cable to the IEEE 1394a connector. Doing so will damage the motherboard!



The IEEE 1394a module is purchased separately.

### 15. VGA connector (VGA\_HDR1)

This connector supports the VGA High Dynamic-Range interface.

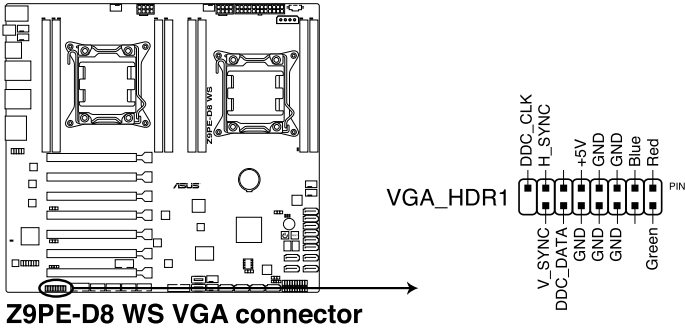

### 16. Front panel audio connector (10-1 pin AAFP)

This connector is for a chassis-mounted front panel audio I/O module that supports either HD Audio or legacy AC'97 audio standard. Connect one end of the front panel audio I/O module cable to this connector.

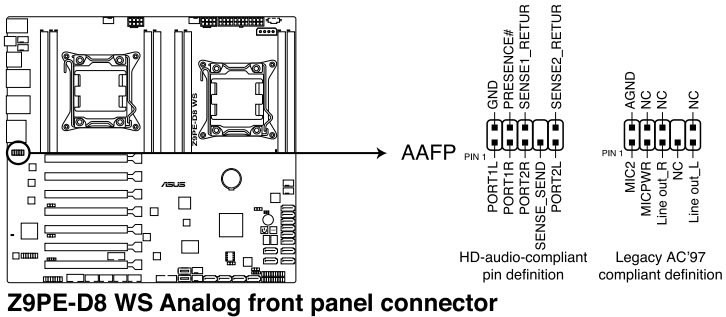

- We recommend that you connect a high-definition front panel audio module to this connector to avail of the motherboard's high-definition audio capability.
- If you want to connect a high-definition front panel audio module to this connector, set the Front Panel Type item in the BIOS setup to [HD]; if you want to connect an AC'97 front panel audio module to this connector, set the item to [AC97]. By default, this connector is set to [HD].

**17. ASMB6 header (ASMB6)**

This connector supports the ASUS Server Management Board 6 series.

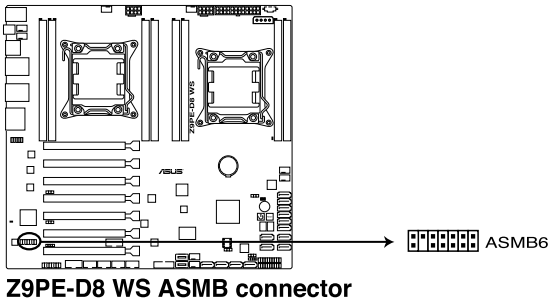

# Chapter 4

This chapter tells how to change the system settings through the BIOS Setup menus. Detailed descriptions of the BIOS parameters are also provided.



ASUS ESC2000 G2

# BIOS setup

## 4.1 Managing and updating your BIOS

The following utilities allow you to manage and update the motherboard Basic Input/Output System (BIOS) setup:

1. **ASUS CrashFree BIOS 3** (To recover the BIOS using a bootable USB flash disk drive when the BIOS file fails or gets corrupted.)
2. **ASUS EZ Flash 2** (Updates the BIOS using a USB flash disk.)
3. **BUPDATER utility** (Updates the BIOS in DOS mode using a bootable USB flash disk drive.)

Refer to the corresponding sections for details on these utilities.



---

Save a copy of the original motherboard BIOS file to a bootable USB flash disk drive in case you need to restore the BIOS in the future. Copy the original motherboard BIOS using the BUPDATER utility.

---

### 4.1.1 ASUS CrashFree BIOS 3 utility

The ASUS CrashFree BIOS 3 is an auto recovery tool that allows you to restore the BIOS file when it fails or gets corrupted during the updating process. You can update a corrupted BIOS file using a USB flash drive that contains the updated BIOS file.



---

Prepare a USB flash drive containing the updated motherboard BIOS before using this utility.

---

### Recovering the BIOS from a USB flash drive

To recover the BIOS from a USB flash drive:

1. Insert the USB flash drive with the original or updated BIOS file to one USB port on the system.
2. The utility will automatically recover the BIOS. It resets the system when the BIOS recovery finished.



---

**DO NOT** shut down or reset the system while recovering the BIOS! Doing so would cause system boot failure!

---



---

The recovered BIOS may not be the latest BIOS version for this motherboard. Visit the ASUS website at [www.asus.com](http://www.asus.com) to download the latest BIOS file.

---

## 4.1.2 ASUS EZ Flash 2 Utility

The ASUS EZ Flash 2 Utility feature allows you to update the BIOS without having to use a DOS-based utility.



Before you start using this utility, download the latest BIOS from the ASUS website at [www.asus.com](http://www.asus.com).

To update the BIOS using EZ Flash 2 Utility

1. Insert the USB flash disk that contains the latest BIOS file to the USB port.
2. Enter the BIOS setup program. Go to the **Tool** menu to select **ASUS EZ Flash 2 Utility** and press <Enter> to enable it.

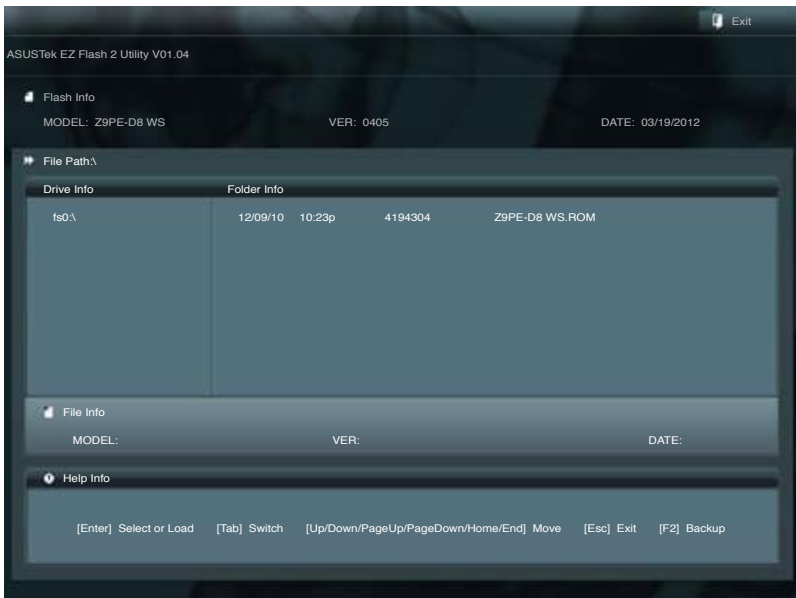

3. Press <Tab> to switch to the **Drive Info** field.
4. Press the Up/Down arrow keys to find the USB flash disk that contains the latest BIOS, and then press <Enter>.
5. Press <Tab> to switch to the **Folder Info** field.
6. Press the Up/Down arrow keys to find the BIOS file, and then press <Enter> to perform the BIOS update process. Reboot the system when the update process is done.



- 
- This function can support devices such as a USB flash disk with FAT 32/16 format and single partition only.
  - DO NOT shut down or reset the system while updating the BIOS to prevent system boot failure!
- 



Ensure to load the BIOS default settings to ensure system compatibility and stability. Press <F5> and select **Yes** to load the BIOS default settings.

---

### 4.1.3 BUPDATER utility



The succeeding BIOS screens are for reference only. The actual BIOS screen displays may not be the same as shown.

---

The BUPDATER utility allows you to update the BIOS file in DOS environment using a bootable USB flash disk drive with the updated BIOS file.

#### Updating the BIOS file

To update the BIOS file using the BUPDATER utility:

1. Visit the ASUS website at [www.asus.com](http://www.asus.com) and download the latest BIOS file for the motherboard. Save the BIOS file to a bootable USB flash disk drive.
2. Copy the BUPDATER utility (BUPDATER.exe) from the ASUS support website at [support.asus.com](http://support.asus.com) to the bootable USB flash disk drive you created earlier.
3. Boot the system in DOS mode, then at the prompt, type:

```
BUPDATER /i [filename] .ROM
```

where [filename] is the latest or the original BIOS file on the bootable USB flash disk drive, then press <Enter>.

```
A:\>BUPDATER /i[file name].ROM
```



The utility verifies the file, then starts updating the BIOS file.

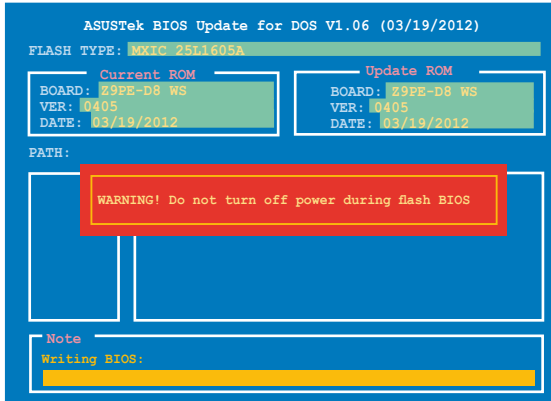

DO NOT shut down or reset the system while updating the BIOS to prevent system boot failure!

5. The utility returns to the DOS prompt after the BIOS update process is completed. Reboot the system from the hard disk drive.

```
The BIOS update is finished! Please restart your system.  
c:\>
```

## 4.2 BIOS setup program

This motherboard supports a programmable firmware chip that you can update using the provided utility described in section 4.1 **Managing and updating your BIOS**.

Use the BIOS Setup program when you are installing a motherboard, reconfiguring your system, or prompted to “Run Setup.” This section explains how to configure your system using this utility.

Even if you are not prompted to use the Setup program, you can change the configuration of your computer in the future. For example, you can enable the security password feature or change the power management settings. This requires you to reconfigure your system using the BIOS Setup program so that the computer can recognize these changes and record them in the CMOS RAM of the firmware chip.

The firmware chip on the motherboard stores the Setup utility. When you start up the computer, the system provides you with the opportunity to run this program. Press <Del> during the Power-On Self-Test (POST) to enter the Setup utility; otherwise, POST continues with its test routines.

If you wish to enter Setup after POST, restart the system by pressing <Ctrl+Alt+Delete>, or by pressing the reset button on the system chassis. You can also restart by turning the system off and then back on. Do this last option only if the first two failed.

The Setup program is designed to make it as easy to use as possible. Being a menu-driven program, it lets you scroll through the various sub-menus and make your selections from the available options using the navigation keys.



- The default BIOS settings for this motherboard apply for most conditions to ensure optimum performance. If the system becomes unstable after changing any BIOS settings, load the default settings to ensure system compatibility and stability. Press <F5> and select **Yes** to load the BIOS default settings.
- The BIOS setup screens shown in this section are for reference purposes only, and may not exactly match what you see on your screen.
- Visit the ASUS website ([www.asus.com](http://www.asus.com)) to download the latest BIOS file for this motherboard.

## 4.2.1 BIOS menu screen

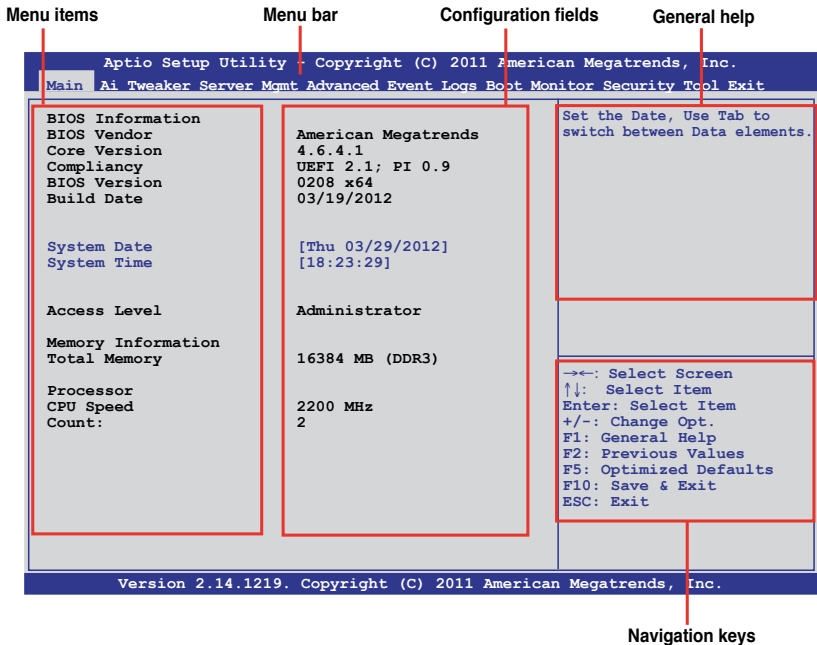

## 4.2.2 Menu bar

The menu bar on top of the screen has the following main items:

<b>Main</b>	For changing the basic system configuration
<b>Ai Tweaker</b>	For changing the Ai Tweaker settings
<b>Server Mgmt</b>	For changing the server management settings
<b>Advanced</b>	For changing the advanced system settings
<b>Event Logs</b>	For changing the event log settings
<b>Monitor</b>	For displaying the system temperature, power status, and changing the fan settings
<b>Security</b>	For changing the security settings
<b>Boot</b>	For changing the system boot configuration
<b>Tool</b>	For configuring options for special functions
<b>Exit</b>	For selecting the exit options

To select an item on the menu bar, press the right or left arrow key on the keyboard until the desired item is highlighted.

### **4.2.3 Menu items**

The highlighted item on the menu bar displays the specific items for that menu. For example, selecting **Main** shows the Main menu items.

The other items (Event Logs, Advanced, Monitor, Boot, Tool, and Exit) on the menu bar have their respective menu items.

### **4.2.4 Submenu items**

A solid triangle before each item on any menu screen means that the item has a submenu. To display the submenu, select the item and press <Enter>.

### **4.2.5 Navigation keys**

At the bottom right corner of a menu screen are the navigation keys for the BIOS setup program. Use the navigation keys to select items in the menu and change the settings.

### **4.2.6 General help**

At the top right corner of the menu screen is a brief description of the selected item.

### **4.2.7 Configuration fields**

These fields show the values for the menu items. If an item is user-configurable, you can change the value of the field opposite the item. You cannot select an item that is not user-configurable.

A configurable field is enclosed in brackets, and is highlighted when selected. To change the value of a field, select it and press <Enter> to display a list of options.

### **4.2.8 Pop-up window**

Select a menu item and press <Enter> to display a pop-up window with the configuration options for that item.

### **4.2.9 Scroll bar**

A scroll bar appears on the right side of a menu screen when there are items that do not fit on the screen. Press the Up/Down arrow keys or <Page Up> /<Page Down> keys to display the other items on the screen.

## 4.3 Main menu

When you enter the BIOS Setup program, the Main menu screen appears. The Main menu provides you an overview of the basic system information, and allows you to set the system date, time, language, and security settings.



The Server Management tab and menu appear only when you install the ASMB card on the motherboard.

```
Aptio Setup Utility - Copyright (C) 2011 American Megatrends, Inc.
Main  Ai Tweaker Advanced Server Mgmt Event Logs Boot Monitor Security Tool Exit

BIOS Information
BIOS Vendor          American Megatrends
Core Version         4.6.4.1
Compliancy           UEFI 2.1; PI 0.9
BIOS Version         0208 x64
Build Date           03/19/2012

System Date          [Thu 03/29/2012]
System Time          [15:07:28]

Access Level         Administrator

Memory Information
Total Memory         16384 MB (DDR3)

Processor
CPU Speed            2200 MHz
Count:               2

Set the Date, Use Tab to switch between Data elements.

->-: Select Screen
↑↓: Select Item
Enter: Select Item
+/-: Change Opt.
F1: General Help
F2: Previous Values
F5: Optimized Defaults
F10: Save & Exit
ESC: Exit

Version 2.14.1219. Copyright (C) 2011 American Megatrends, Inc.
```

### 4.3.1 System Date [Day xx/xx/xxxx]

Allows you to set the system date.

### 4.3.2 System Time [xx:xx:xx]

Allows you to set the system time.

## 4.4 Ai Tweaker menu

The Ai Tweaker menu items allow you to configure overclocking-related items.



Be cautious when changing the settings of the Ai Tweaker menu items. Incorrect field values can cause the system to malfunction.



The configuration options for this section vary depending on the CPU and DIMM model you installed on the motherboard.

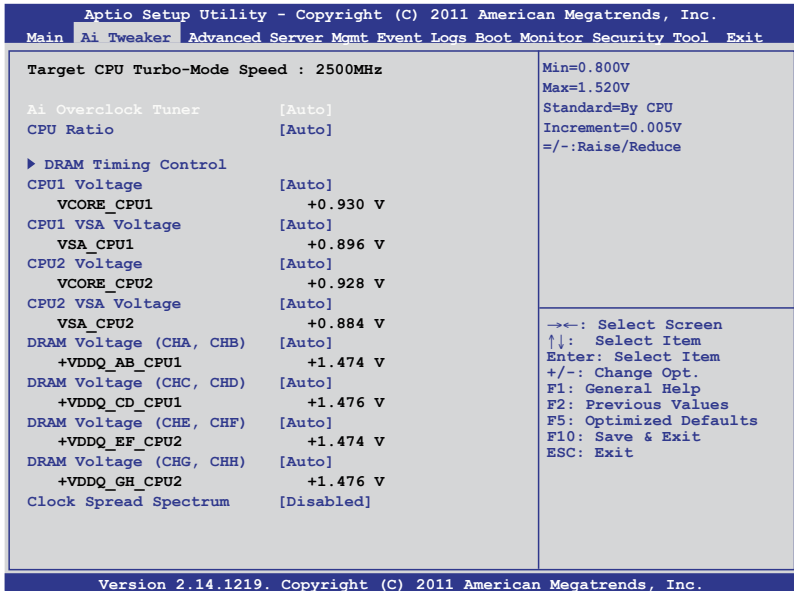

### Ai Overclock Tuner [Auto]

Allows you to select the CPU overclocking options to achieve the desired CPU internal frequency. Select any of these preset overclocking configuration options:

- [Auto] Loads the optimal settings for the system.
- [Manual] Allows you to individually set overclocking parameters.

### BCLK Frequency [XXX]

Allows you to adjust the CPU and VGA frequency to enhance the system performance. Set **Ai Overclock Tuner** to [Manual] to show BCLK Frequency. Use the <+> and <-> keys to adjust the value. You can also key in the desired value using the numeric keypad. The values range from 80.0MHz to 300.0MHz.

### **CPU Ratio [Auto]**

This item allows users adjust the maximum non-turbo CPU ratio. Use the <+> and <-> keys to adjust the value. The values range from 12 to 57 with 1 interval.

### **CPU1 Voltage [Auto]**

Use the <+> and <-> keys to adjust the value. The values range from 0.800V to 1.520V with 0.005V interval.

### **CPU1 VSA Voltage [Auto]**

Use the <+> and <-> keys to adjust the value. The values range from 0.800V to 1.520V with 0.005V interval.

### **CPU2 Voltage [Auto]**

Use the <+> and <-> keys to adjust the value. The values range from 0.800V to 1.520V with 0.005V interval.

### **CPU2 VSA Voltage [Auto]**

Use the <+> and <-> keys to adjust the value. The values range from 0.800V to 1.520V with 0.005V interval.

### **DRAM Voltage (CHA, CHB) [Auto]**

Use the <+> and <-> keys to adjust the value. The values range from 1.20V to 1.90V with 0.005V interval.

### **DRAM Voltage (CHC, CHD) [Auto]**

Use the <+> and <-> keys to adjust the value. The values range from 1.20V to 1.90V with 0.005V interval.

### **DRAM Voltage (CHE, CHF) [Auto]**

Use the <+> and <-> keys to adjust the value. The values range from 1.20V to 1.90V with 0.005V interval.

### **DRAM Voltage (CHG, CHH) [Auto]**

Use the <+> and <-> keys to adjust the value. The values range from 1.20V to 1.90V with 0.005V interval.

### **Clock Spread Spectrum [Disabled]**

[Disabled] Enhances BCLK overclocking ability.

[Enabled] For [EMI] control.

## 4.4.1 DRAM Timing Control

Aptio Setup Utility - Copyright (C) 2011 American Megatrends, Inc.

Main Ai Tweaker Advanced Server Mgmt Event Logs Boot Monitor Security Tool Exit

<b>Primary Timings</b>			Min=0.800V Max=1.520V Standard=By CPU Increment=0.005V = / - : Raise/Reduce
DRAM CAS# Latency		[Auto]	→←: Select Screen ↑↓: Select Item Enter: Select Item +/-: Change Opt. F1: General Help F2: Previous Values F5: Optimized Defaults F10: Save & Exit ESC: Exit
DRAM CAS# Latency	9		
DRAM RAS# to CAS# Delay		[Auto]	
DRAM RAS# to CAS# Delay	9		
DRAM RAS# PRE Time		[Auto]	
DRAM RAS# PRE Time	9		
DRAM RAS# ACT Time		[Auto]	
DRAM RAS# ACT Time	24		
DRAM COMMAND Mode		[Auto]	
DRAM COMMAND Mode	1		
<b>Secondary Timings</b>			
DRAM RAS# to RAS# Delay		[Auto]	
DRAM RAS# to RAS# Delay	4		
DRAM REF Cycle Time		[Auto]	
DRAM REF Cycle Time	74		
DRAM WRITE Recovery Time		[Auto]	
DRAM WRITE Recovery Time	10		
DRAM READ to PRE Time		[Auto]	
DRAM READ to PRE Time	5		
DRAM FOUR ACT WIN Time		[Auto]	
DRAM FOUR ACT WIN Time	20		
DRAM WRITE to READ Delay		[Auto]	
DRAM WRITE to READ Delay	5		

---

DRAM Write Latency		[Auto]
DRAM Write Latency	7	

Version 2.14.1219. Copyright (C) 2011 American Megatrends, Inc.



Use the scroll to view items.

### Primary Timings

#### DRAM CAS# Latency [Auto]

Use the <+> and <-> keys to adjust the value. The values range from 3 to 15 with 1 interval.

#### DRAM RAS# to CAS# Delay [Auto]

Use the <+> and <-> keys to adjust the value. The values range from 4 to 15 with 1 interval.

#### DRAM RAS# PRE Time [Auto]

Use the <+> and <-> keys to adjust the value. The values range from 4 to 15 with 1 interval.

#### DRAM RAS# ACT Time [Auto]

Use the <+> and <-> keys to adjust the value. The values range from 4 to 40 with 1 interval.



DRAM COMMAND Mode [Auto]

Use the <+> and <-> keys to adjust the value. The values range from 1 to 3 with 1 interval.

**Secondary Timings**

DRAM RAS# to RAS# Delay [Auto]

Use the <+> and <-> keys to adjust the value. The values range from 4 to 7 with 1 interval.

DRAM REF Cycle Time [Auto]

Use the <+> and <-> keys to adjust the value. The values range from 48 to 255 with 1 interval.

DRAM WRITE Recovery Time [Auto]

Use the <+> and <-> keys to adjust the value. The values range from 5 to 31 with 1 interval.

DRAM READ to PRE Time [Auto]

Use the <+> and <-> keys to adjust the value. The values range from 4 to 15 with 1 interval.

DRAM FOUR ACT WIN Time [Auto]

Use the <+> and <-> keys to adjust the value. The values range from 16 to 63 with 1 interval.

DRAM WRITE to READ Delay [Auto]

Use the <+> and <-> keys to adjust the value. The values range from 4 to 15 with 1 interval.

DRAM WRITE Latency [Auto]

Use the <+> and <-> keys to adjust the value. The values range from 1 to 15 with 1 interval.

## 4.5 Advanced menu

The Advanced menu items allow you to change the settings for the CPU and other system devices.



Take caution when changing the settings of the Advanced menu items. Incorrect field values can cause the system to malfunction.

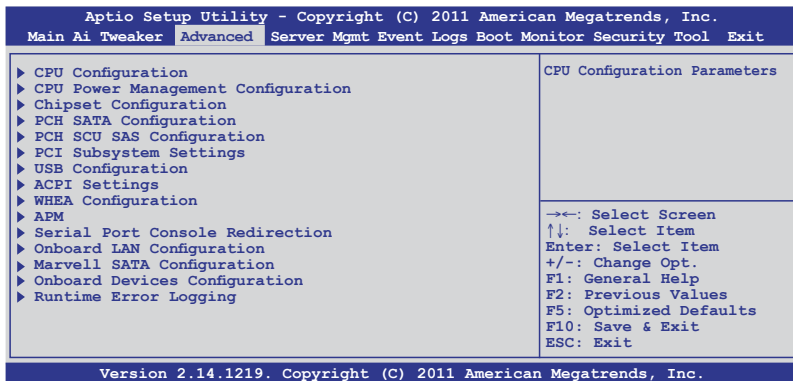

### 4.5.1 CPU Configuration

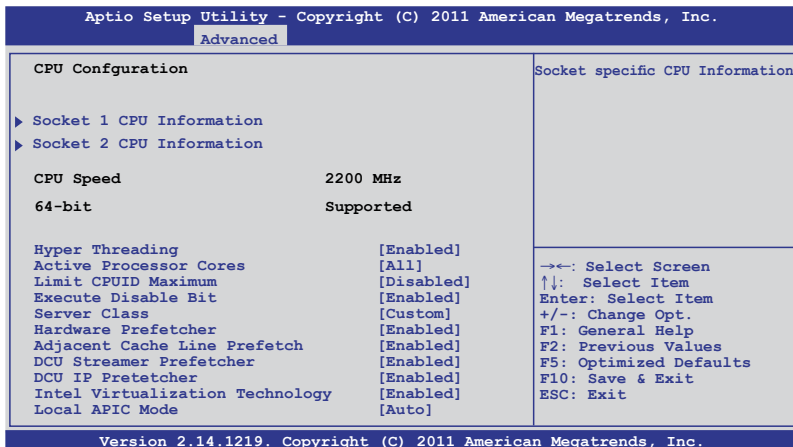

## Socket 1 CPU Information

Enter to view socket specific CPU Information.

Aptio Setup Utility - Copyright (C) 2011 American Megatrends, Inc.

Advanced

Socket 1 CPU Information	
Intel(R) Xeon(R) CPU E5-2660 0 @ 2.20GHz	
CPU Signature	206d6
Microcode Patch	613
Max CPU Speed	2200 MHz
Min CPU Speed	1200 MHz
Processor Cores	6
Intel HT Technology	Supported
Intel VT-X Technology	Supported
L1 Data Cache	32 kB x 8
L1 Code Cache	32 kB x 8
L2 Cache	256 kB x 8
L3 Cache	20480 kB

→←: Select Screen  
↑↓: Select Item  
Enter: Select Item  
+/-: Change Opt.  
F1: General Help  
F2: Previous Values  
F5: Optimized Defaults  
F10: Save & Exit  
ESC: Exit

Version 2.14.1219. Copyright (C) 2011 American Megatrends, Inc.

## Socket 2 CPU Information

Enter to view socket specific CPU Information.

Aptio Setup Utility - Copyright (C) 2011 American Megatrends, Inc.

Advanced

Socket 2 CPU Information	
Intel(R) Xeon(R) CPU E5-2660 0 @ 2.20GHz	
CPU Signature	206d6
Microcode Patch	613
Max CPU Speed	2200 MHz
Min CPU Speed	1200 MHz
Processor Cores	8
Intel HT Technology	Supported
Intel VT-X Technology	Supported
L1 Data Cache	32 kB x 8
L1 Code Cache	32 kB x 8
L2 Cache	256 kB x 8
L3 Cache	20480 kB

→←: Select Screen  
↑↓: Select Item  
Enter: Select Item  
+/-: Change Opt.  
F1: General Help  
F2: Previous Values  
F5: Optimized Defaults  
F10: Save & Exit  
ESC: Exit

Version 2.14.1219. Copyright (C) 2011 American Megatrends, Inc.

## Hyper Threading [Enabled]

This item allows you to enable/disable the Intel Hyper-Threading Technology function. Enable for Windows XP and Linux or disable for other OS. When disabled, only one thread per activated core is enabled.

Configuration options: [Disabled] [Enabled]

## Active Processor Cores [All]

This item sets the number of cores to enable in each processor package.

Configuration options: [All] [1] [2] [3] [4] [5] [6] [7]

## Limit CPUID Maximum [Disabled]

Setting this item to [Enabled] allows legacy operating system to boot even without support for CPUs with extended CPUID functions.

Configuration options: [Disabled] [Enabled]

## Execute Disable Bit [Enabled]

XP can prevent certain classes of malicious buffer overflow attacks when combined with a supporting OS (Windows Server 2003 SP1, Windows XP SP2, SuSE Linux 9.2, Redhat Enterprise 3 Update 3).

Configuration options: [Disabled] [Enabled]

## Server Class [Custom]

Use Intel recommended prefetch settings.

Configuration options: [Enterprise] [High Performance(HPC)] [Custom]



---

You can only customize the items below when you enable the Server Class to **[Custom]**.

### Hardware Prefetcher [Enabled]

This item allows you to turn on/off the mid level cache(L2) streamer prefetcher.

Configuration options: [Disabled] [Enabled]

### Adjacent Cache Line Prefetch [Enabled]

This item allows you to turn on/off prefetching of adjacent cache lines.

Configuration options: [Disabled] [Enabled]

### DCU Streamer Prefetcher [Enabled]

This item allows you to enable/disable prefetching of next L1 data line based upon multiple loads in same cache line.

Configuration options: [Disabled] [Enabled]

### DCU IP Prefetcher [Enabled]

This item allows you to enable/disable prefetching of next L1 line based upon sequential load history.

Configuration options: [Disabled] [Enabled]

## Intel Virtualization Technology [Enabled]

When this item is enabled, VMM can utilize the additional hardware capabilities provided by Vanderpool Technology.

Configuration options: [Disabled] [Enabled]

## Local APIC Mode [Auto]

Allows you to enable one or both the Advanced Programmable Interrupt Controllers (APIC) with APIC ID values greater than 254.

Configuration options: [Auto] [xAPIC] [x2APIC]

## 4.5.2 CPU Power Management Configuration

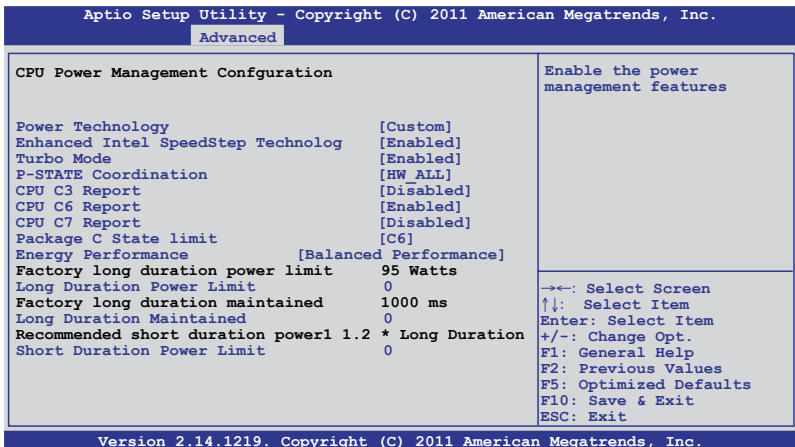

The screenshot shows the 'Advanced' tab of the Aptio Setup Utility. The main title is 'CPU Power Management Configuration'. On the right, there is a checkbox labeled 'Enable the power management features'. Below this, a list of settings is shown with their current values in brackets: Power Technology [Custom], Enhanced Intel SpeedStep Technolog [Enabled], Turbo Mode [Enabled], P-STATE Coordination [HW\_ALL], CPU C3 Report [Disabled], CPU C6 Report [Enabled], CPU C7 Report [Disabled], Package C State limit [C6], and Energy Performance [Balanced Performance]. At the bottom, there are several power limit settings: Factory long duration power limit (95 Watts), Long Duration Power Limit (0), Factory long duration maintained (1000 ms), Long Duration Maintained (0), Recommended short duration power1 1.2 \* Long Duration, and Short Duration Power Limit (0). A legend on the right side of the screen lists navigation keys: ←: Select Screen, ↑: Select Item, Enter: Select Item, +/-: Change Opt., F1: General Help, F2: Previous Values, F5: Optimized Defaults, F10: Save & Exit, and ESC: Exit. The footer of the utility reads 'Version 2.14.1219. Copyright (C) 2011 American Megatrends, Inc.'

## Power Technology [Custom]

This item allows you to enable power management features.

Configuration options: [Disable] [Energy Efficient] [Custom]



You can only customize the items below when you enable the Power Technology to [Custom].

### Enhanced Intel SpeedStep Technology [Enabled]

Enable Intel SpeedStep for allowing the system operation system to dynamically adjust processor voltage and cores frequency to result in decreased average power consumption and decreased average heat production.

Configuration options: [Disabled] [Enabled]

*Turbo Mode [Enabled]*

This item automatically allows processor cores to run faster than the base operating frequency if it's operating below power, current, and temperature specification limit.

Configuration options: [Disabled] [Enabled]

*P-STATE Coordination [HW\_ALL]*

This item allows you to change P-STATE Coordination type.

Configuration options: [HW\_ALL] [SW\_ALL] [SW\_ANY]

*CPU C3 Report [Disabled]*

This item allows you to enable/disable CPU C3(ACPI C2) report.

Configuration options: [Disabled] [Enabled]

*CPU C6 Report [Enabled]*

This item allows you to enable/disable CPU C6(ACPI C3) report.

Configuration options: [Disabled] [Enabled]

*Power Technology [Custom]*

This item allows you to enable power management features.

Configuration options: [Disable] [Energy Efficient] [Custom]

*Enhanced Intel SpeedStep Technology [Enabled]*

Enable Intel SpeedStep for allowing the system operation system to dynamically adjust processor voltage and cores frequency to result in decreased average power consumption and decreased average heat production.

Configuration options: [Disabled] [Enabled]

*Turbo Mode [Enabled]*

This item automatically allows processor cores to run faster than the base operating frequency if it's operating below power, current, and temperature specification limit.

Configuration options: [Disabled] [Enabled]

*P-STATE Coordination [HW\_ALL]*

This item allows you to change P-STATE Coordination type.

Configuration options: [HW\_ALL] [SW\_ALL] [SW\_ANY]

*CPU C3 Report [Disabled]*

This item allows you to enable/disable CPU C3(ACPI C2) report.

Configuration options: [Disabled] [Enabled]

*CPU C6 Report [Enabled]*

This item allows you to enable/disable CPU C6(ACPI C3) report.

Configuration options: [Disabled] [Enabled]

CPU C7 Report [Disabled]

This item allows you to enable/disable CPU C7(ACPI C3) report.

Configuration options: [Disabled] [Enabled]

Package C State limit [C6]

This item allows you to set package C State limit.

Configuration options: [C0] [C2] [C6] [C7] [No Limit]

**Energy Performance [Balanced Performance]**

This item allows you to optimize between performance and power savings.

Configuration options: [Performance] [Balanced Performance] [Balanced Energy] [Energy Efficient]

**Factory long duration power limit**                      **95Watts**

**Long Duration Power Limit**                      **0**

Allows you to set long duration power limit in watts. Use the <+> and <-> keys to adjust the value.

**Factory long duration maintained**                      **1000 ms**

**Long Duration Maintained**                      **0**

Allows you to set time window which the long duration power is maintained. Use the <+> and <-> keys to adjust the value.

**Recommended short duration power1**                      **1.2 \* Long Duration**

**Short Duration Power Limit**                      **0**

Allows you to set short duration power limit in watts. Use the <+> and <-> keys to adjust the value.

## 4.5.3 Chipset Configuration

Aptio Setup Utility - Copyright (C) 2011 American Megatrends, Inc.	
Advanced	
<ul style="list-style-type: none"><li>▶ QPI Configuration</li><li>▶ Memory Configuration</li><li>▶ CPU I/O Bridge Configuration</li><li>▶ PCH Configuration</li><li>▶ Intel(R) VT for Directed I/O Configuration</li></ul>	QPI Configuration Page

### QPI Configuration

Aptio Setup Utility - Copyright (C) 2011 American Megatrends, Inc.		
Advanced		
Current QPI Link Speed	Fast	Enable/Disable Isoc
Current QPI Link Freq	7.2 GT/s	
Isoc	[Enabled]	
QPI Link Speed Mode	[Fast]	
QPI Link Frequency Select	[Auto]	
QPI Link0s	[Disabled]	
QPI Link0p	[Disabled]	
QPI Link1	[Enabled]	

#### Isoc [Enabled]

Configuration options: [Disabled] [Enabled]

#### QPI Link Speed Mode [Fast]

This item allows you to select the QPI link speed as either the fast mode or slow mode.

Configuration options: [Slow] [Fast]

#### QPI Link Frequency Select [Auto]

This item allows for selecting the QPI link frequency

Configuration options: [Auto] [6.4 GT/s] [7.2 GT/s (Fast Mode Only)] [8.0 GT/s (Fast Mode Only)]

#### QPI Link0s [Disabled]

Configuration options: [Disabled] [Enabled]

#### QPI Link0p [Disabled]

Configuration options: [Disabled] [Enabled]

#### QPI Link1 [Enabled]

Configuration options: [Disabled] [Enabled]



# Memory Configuration

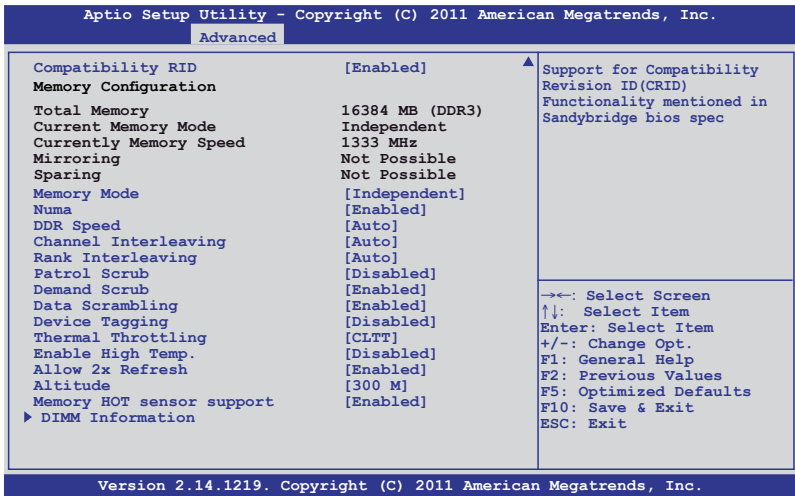

## Compatibility RID [Enabled]

Supports compatibility revision ID (CRID) functionality mentioned in Sandybridge BIOS spec.

Configuration options: [Enabled] [Disabled]

## Memory Mode [Independent]

Select the mode for memory initialization.

Configuration options: [Independent]

## Numa [Enabled]

Allows you to disable or enable Non Uniform Memory Access.

Configuration options: [Enabled] [Disabled]

## DDR Speed [Auto]

This item allows you to configure force DDR speed.

Configuration options: [Auto] [Force DDR3 800] [Force DDR3 1066] [Force DDR3 1333] [Force DDR3 1600] [Force DDR3 1866] [Force DDR3 2133] [Force DDR3 2400] [Force DDR3 2666]

## Channel Interleaving [Auto]

Select different channel interleaving setting.

Configuration options: [Auto] [1 Way] [2 Way] [3 Way] [4 Way]

*Rank Interleaving [Auto]*

Select different rank interleaving setting.

Configuration options: [Auto] [1 Way] [2 Way] [4 Way] [8 Way]

*Patrol Scrub [Disabled]*

This item allows you to enable/disable Patrol Scrub.

Configuration options: [Disabled] [Enabled]

*Demand Scrub [Enabled]*

This item allows you to enable/disable Demand Scrubbing Feature.

Configuration options: [Enabled] [Disabled]

*Data Scrambling [Enabled]*

This item allows you to enable/disable Data Scrambling.

Configuration options: [Enabled] [Disabled]

*Device Tagging [Disabled]*

This item allows you to enable/disable Device Tagging.

Configuration options: [Enabled] [Disabled]

*Thermal Throttling [CLTT]*

Configuration options: [Disabled] [OLTT] [CLTT]

*Enable High Temp. [Disabled]*

This item allows you to enable/disable high temperature mode.

Configuration options: [Disabled] [Enabled]

*Allow 2x Refresh [Enabled]*

This item allows you to enable/disable refreshing function.

Configuration options: [Disabled] [Enabled]

*Altitude [300 M]*

Shows system altitude above the sea level in meters.

Configuration options: [Auto] [300 M] [900 M] [1500 M] [3000 M]

*Memory Hot sensor support [Enabled]*

Configuration options: [Disabled] [Enabled]

## DIMM Information

Aptio Setup Utility - Copyright (C) 2011 American Megatrends, Inc.	
Advanced	
<b>CPU1 DIMM Information</b>	
DIMM_A1	Present 8192 MB (Indep
DIMM_B1	Not Present
DIMM_C1	Not Present
DIMM_D1	Not Present
<b>CPU2 DIMM Information</b>	
DIMM_E1	Not Present
DIMM_F1	Not Present
DIMM_G1	Present 8192 MB Inde[
DIMM_H1	Not Present

## **CPU IIO Bridge Configuration**

Aptio Setup Utility - Copyright (C) 2011 American Megatrends, Inc.	
Advanced	
Intel(R) I/OAT	[Disabled]
DCA Support	[Enabled]
VGA Priority	[Offboard]
TargetVGA	VGA From CPU

Version 2.14.1219. Copyright (C) 2011 American Megatrends, Inc.

### Intel(R) I/OAT [Disabled]

This item allows you to enable/disable Intel I/O acceleration technology.

Configuration options: [Disabled] [Enabled]

### DCA Support [Enabled]

This item allows you to enable/disable direct cache access support.

Configuration options: [Disabled] [Enabled]

### VGA Priority [offboard]

This item allows you to decide the priority between onboard and 1st offboard video device found.

Configuration options: [Onboard] [Offboard]

## PCH Configuration

Aptio Setup Utility - Copyright (C) 2011 American Megatrends, Inc.		
Advanced		
Name Stepping	Patsburg 06 (C1 Stepping)	Support for PCH Compatibility Revision ID (CRID) Functionality.
SB Chipset Configuration		
PCH Compatibility RID	[Disabled]	
Deep Sx	[Disabled]	
SCU devices	[Enabled]	
Onboard SATA RAID Oprom	[Enabled]	
Audio Configuration		
Azalia HD Audio	[Enabled]	
High Precision Event Timer Configuration		
High Precision Timer	[Enabled]	
		→←: Select Screen ↑↓: Select Item Enter: Select Item +/-: Change Opt. F1: General Help F2: Previous Values F5: Optimized Defaults F10: Save & Exit ESC: Exit

### PCH Compatibility RID [Disabled]

This item allows support for PCH compatibility.

Configuration options: [Disabled] [Enabled]

### Deep Sx [Disabled]

Configuration options: [Disabled] [Enabled in S5 (Battery)] [Enabled in S5] [Enabled in S4 and S5 (Battery)] [Enabled in S4 and S5]



Mobile platforms support deep S4/S5 in DC only and desktop platforms support deep S4/S5 in AC only.

### SCU devices [Enabled]

This item allows you to enable/disable Patsburg SCU devices.

Configuration options: [Enabled] [Disabled]

### Onboard SATA RAID Oprom [Enabled]

This item allows you to enable/disable onboard SATA RAID option rom if Launch Storage Oprom is enabled.

Configuration options: [Disabled] [Enabled]

## Audio Configuration

### Azalia HD Audio [Enabled]

This item allows you to enable/disable Azalia HD Audio.

Configuration options: [Disabled] [Enabled]

## High Precision Event Timer Configuration

### High Precision Timer [Enabled]

This item allows you to enable/disable High Precision Event Timer.

Configuration options: [Disabled] [Enabled]

## Intel(R) VT for Directed I/O Configuration

Aptio Setup Utility - Copyright (C) 2011 American Megatrends, Inc.		
Advanced		
Intel(R) VT-d	[Enabled]	Enables or Disables BIOS ACPI Auto Configuration.

### Intel(R) VT-d [Disabled]

This item allows you to enable or disable Intel VT-d.

Configuration options: [Enabled] [Disabled]



---

The following item appears only when you set **Intel(R) VT-d** to [Enabled].

---

### **Coherency Support [Disabled]**

This item allows you to enable/disable VT-d Engine Coherency support.

Configuration options: [Disabled] [Enabled]

### **ATS Support [Disabled]**

This item allows you to enable/disable VT-d Engine address translation services (ATS) support.

Configuration options: [Disabled] [Enabled]

## 4.5.4 PCH SATA Configuration

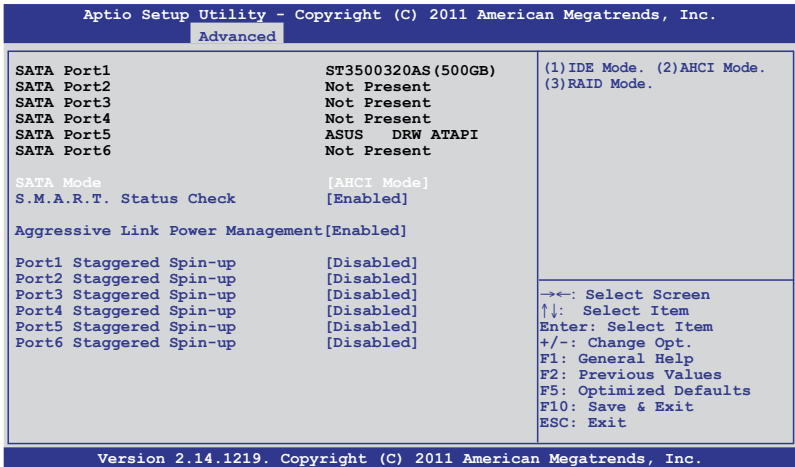

### SATA Mode [AHCI Mode]

This item allows you to set the SATA configuration.

Configuration options: [Disabled] [IDE Mode] [AHCI Mode] [RAID Mode]



- If you want to use the Serial ATA hard disk drives as Parallel ATA physical storage devices, set this item to [IDE Mode].
- If you want the Serial ATA hard disk drives to use the Advanced Host Controller Interface (AHCI), keep the default setting [AHCI Mode]. The AHCI allows the onboard storage driver to enable advanced Serial ATA features that increases storage performance on random workloads by allowing the drive to internally optimize the order of commands.
- If you want to create RAID sets with LSI MegaRAID utility, or Intel® Rapid Storage Technology Enterprise from the Serial ATA hard disk drives, set this item to [RAID Mode].

### AHCI Mode

Allows you to enable the Aggressive Link Power Management and support Staggered Spin-up.

### **S.M.A.R.T. Status Check [Enabled]**

S.M.A.R.T. (Self-Monitoring, Analysis and Reporting Technology) is a monitor system. When read/write of your hard disk errors occur, this feature allows the hard disk to report warning messages during the POST.

Configuration options: [Enabled] [Disabled]

### **Aggressive Link Power Management [Enabled]**

Configuration options: [Enabled] [Disabled]

### **Port 1-6 Staggered Spin-up [Disabled]**

Configuration options: [Enabled] [Disabled]

### IDE Mode

Allows you to to enable or disable the SATA controllers.

### **Serial-ATA Controller 0 [Enhanced]**

This item appears only when you set the **SATA Mode** item to [IDE Mode]. Set to [Enhanced] to support two SATA 6.0 Gb/s and two SATA 3.0 Gb/s devices. Set to [Compatible] when using Windows 98/NT/2000/MS-DOS. Up to four SATA devices are supported under these operating systems.

Configuration options: [Disabled] [Enhanced] [Compatible]

### **Serial-ATA Controller 1 [Enhanced]**

This item appears only when you set the SATA Mode item to [IDE Mode]. Set to [Enhanced] to support two SATA 3.0 Gb/s devices.

Configuration options: [Disabled] [Enhanced]

### **S.M.A.R.T. Status Check [Enabled]**

S.M.A.R.T. (Self-Monitoring, Analysis and Reporting Technology) is a monitor system. When read/write of your hard disk errors occur, this feature allows the hard disk to report warning messages during the POST.

Configuration options: [Enabled] [Disabled]

## **4.5.5 PCH SCU SAS Configuration**

The PCH SCU SAS configuration items appears only when you have installed the ASRK Module (optional) on the motherboard.

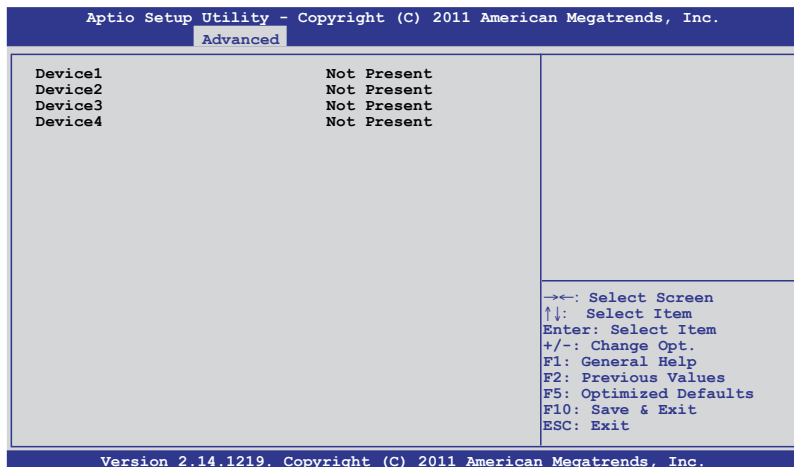

## 4.5.6 PCI Subsystem Settings

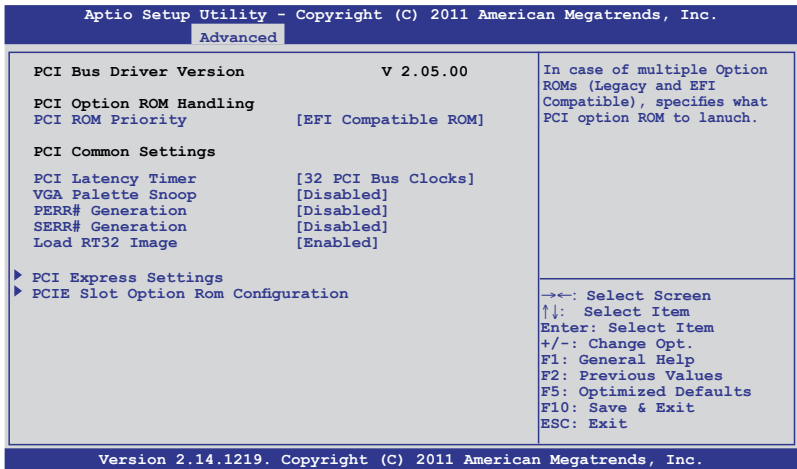

### PCI ROM Priority [EFI Compatible ROM]

This item specifies which PCI option ROM to launch between multiple option ROMs (Legacy and EFI Compatible).

Configuration options: [Legacy ROM] [EFI Compatible ROM]

### PCI Latency Timer [32 PCI Bus Clocks]

This item configures the value to be programmed into PCI Latency Timer Register.  
 Configuration options: [32 PCI Bus Clocks] [64 PCI Bus Clocks] [96 PCI Bus Clocks] [128 PCI Bus Clocks] [160 PCI Bus Clocks] [192 PCI Bus Clocks] [224 PCI Bus Clocks] [248 PCI Bus Clocks]

### VGA Palette Snoop [Disabled]

This item enables or disables VGA palette register snooping.  
 Configuration options: [Disabled] [Enabled]

### PERR# Generation [Disabled]

This item enables or disables PCI device to generate PERR#.  
 Configuration options: [Disabled] [Enabled]

### SERR# Generation [Disabled]

This item enables or disables PCI device to generate SERR#.  
 Configuration options: [Disabled] [Enabled]



## PCI Express Settings

Aptio Setup Utility - Copyright (C) 2011 American Megatrends, Inc.	
Advanced	
PCI Express Link Register Settings	Enables or Disables PCI Express Device Relaxed Ordering.
ASPM Support [Disabled]	
WARNING: Enabling ASPM may cause some PCI-E device to fail	
	→←: Select Screen ↑↓: Select Item Enter: Select Item +/-: Change Opt. F1: General Help F2: Previous Values F5: Optimized Defaults F10: Save & Exit ESC: Exit
Version 2.14.1219. Copyright (C) 2011 American Megatrends, Inc.	

### ASPM Support [Disabled]

This item allows you to set the ASPM level.

Configuration options: [Disabled] [Auto] [Force L0s]

[Force L0s] Force all links to L0s state.

[Auto] BIOS auto configure.

[Disabled] Disabled ASPM.

# PCIe Slot Option ROM Configuration

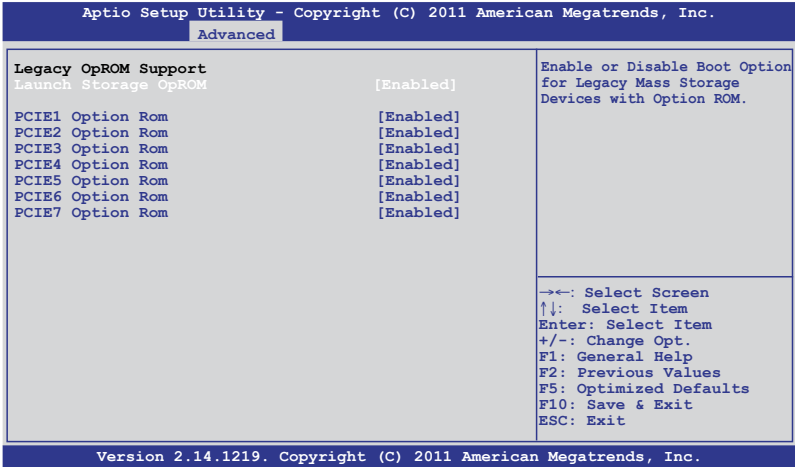

**Launch Storage OpROM [Enabled]**

This item allows you to enable or disable boot option for Legacy Mass Storage devices with Option ROM.

Configuration options: [Disabled] [Enabled]

**PCIE1 Option Rom [Enabled]**

Configuration options: [Disabled] [Enabled]

**PCIE2 Option Rom [Enabled]**

Configuration options: [Disabled] [Enabled]

**PCIE3 Option Rom [Enabled]**

Configuration options: [Disabled] [Enabled]

**PCIE4 Option Rom [Enabled]**

Configuration options: [Disabled] [Enabled]

**PCIE5 Option Rom [Enabled]**

Configuration options: [Disabled] [Enabled]

**PCIE6 Option Rom [Enabled]**

Configuration options: [Disabled] [Enabled]

**PCIE7 Option Rom [Enabled]**

Configuration options: [Disabled] [Enabled]

## 4.5.7 USB Configuration

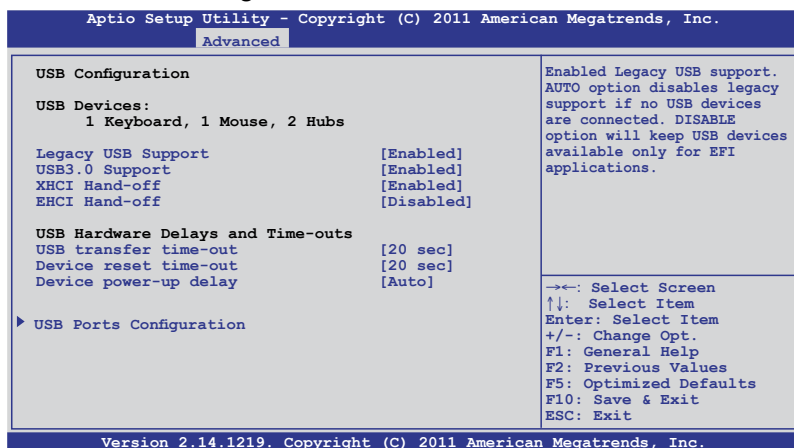

### Legacy USB Support [Enabled]

This item enables or disables Legacy USB device support.

Configuration options: [Enabled] [Disabled] [Auto]

### USB3.0 Support [Enabled]

This item enables or disables USB3.0 (XHCI) Controller support.

Configuration options: [Enabled] [Disabled]

### XHCI Hand-off [Enabled]

This is a workaround for OSeS without XHCI ownership change should be claimed by XHCI driver.

Configuration options: [Disabled] [Enabled]

### EHCI Hand-off [Disabled]

This is a workaround for OSeS without EHCI ownership change should be claimed by XHCI driver.

Configuration options: [Disabled] [Enabled]

### USB Hardware Delays and Time-outs

#### USB transfer time-out [20 sec]

This item sets the time-out value for control, bulk, and interrupt transfer.

Configuration options: [1 sec] [5 sec] [10 sec] [20 sec]

#### Device reset time-out [20 sec]

USB mass storage device Start Unit command time-out.

Configuration options: [10 sec] [20 sec] [30 sec] [40 sec]

## USB Ports Configuration

Aptio Setup Utility - Copyright (C) 2011 American Megatrends, Inc.		
Advanced		
EHCI Controller 1	[Enabled]	Enable/Disable USB 2.0 (EHCI) Support.
EHCI Controller 2	[Enabled]	
USB Port 1	[Enabled]	→←: Select Screen ↑↓: Select Item Enter: Select Item +/-: Change Opt. F1: General Help F2: Previous Values F5: Optimized Defaults F10: Save & Exit ESC: Exit
USB Port 2	[Enabled]	
USB Port 3	[Enabled]	
USB Port 4	[Enabled]	
USB Port 5	[Enabled]	
USB Port 6	[Enabled]	
USB Port 7	[Enabled]	
USB Port 8	[Enabled]	
USB Port 9	[Enabled]	
USB Port 10	[Enabled]	
USB Port 11	[Enabled]	
USB Port 12	[Enabled]	
USB Port 13	[Enabled]	
USB Port 14	[Enabled]	

Version 2.14.1219. Copyright (C) 2011 American Megatrends, Inc.

### EHCI Controller 1/2 [Enabled]

This item allows you to enable or disable USB 2.0 (EHCI) Support. If we disable the EHCI Controller in BIOS > South Bridge > USB configuration, the USB device will all disable in OS.

Configuration options: [Disabled] [Enabled]

### USB Port 1/14 [Enabled]

These items allow you to enable or disable USB ports 1 to 14.

Configuration options: [Disabled] [Enabled]

## 4.5.8 ACPI Settings

Aptio Setup Utility - Copyright (C) 2011 American Megatrends, Inc.		
Advanced		
<b>ACPI Settings</b>		Enables or Disables BIOS ACPI Auto Configuration.
Enable ACPI Auto Configuration	[Disabled]	
Enable Hibernation	[Enabled]	
ACPI Sleep State	[S3 (Suspend to RAM)]	
Lock Legacy Resources	[Disabled]	

## Enable ACPI Auto Configuration [Disabled]

Allows you to enable or disable BIOS ACPI Auto Configuration.

Configuration options: [Disabled] [Enabled]



The following item appears only when you set **Enabled ACPI Auto Configuration** to [Disabled].

### Enable Hibernation [Enabled]

Enables or disables system ability to Hibernate (OS/S4 sleep state). This option may be not effective with some OS.

Configuration options: [Disabled] [Enabled]

### ACPI Sleep State [S3 (Suspend to RAM)]

Allows you to set the ACPI Sleep State.

Configuration options: [Suspend Disabled] [S1 (CPU Stop Clock)] [S3 (Suspend to RAM)]

### Lock Legacy Resources [Disabled]

Allows to enable or disable Lock Legacy Resources.

Configuration options: [Disabled] [Enabled]

## 4.5.9 WHEA Configuration

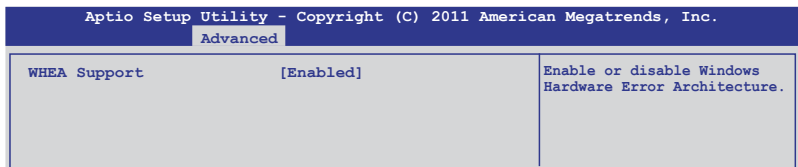

### **WHEA Support [Enabled]**

Allows you to enable or disable the Windows Hardware Error Architecture support.

Configuration options: [Disabled] [Enabled]

## 4.5.10 APM

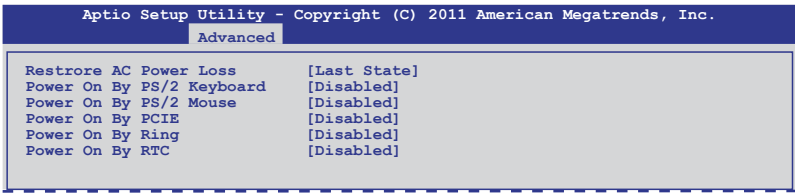

### Restore AC Power Loss [Last State]

When set to [Power Off], the system goes into off state after an AC power loss. When set to [Power On], the system will reboot after an AC power loss. When set to [Last State], the system goes into either off or on state, whatever the system state was before the AC power loss.

Configuration options: [Power Off] [Power On] [Last State]

### Power On By PS/2 Keyboard [Disabled]

[Disabled] Disables the PS/2 Keyboard from generating a wake event.

[Enabled] Enables the PS/2 Keyboard to generate a wake event.

### Power On By PS/2 Mouse [Disabled]

[Disabled] Disables the PS/2 Mouse from generating a wake event.

[Enabled] Enables the PS/2 Mouse to generate a wake event.

### Power On By PCIE [Disabled]

[Disabled] Disables the PCIE devices from generating a wake event.

[Enabled] Enables the PCIE devices to generate a wake event.

### Power On By Ring [Disabled]

[Disabled] Disables the Ring devices from generating a wake event.

[Enabled] Enables the Ring devices to generate a wake event.

### Power On By RTC [Disabled]

[Disabled] Disables RTC from generating a wake event.

[Enabled] When set to [Enabled], the items **RTC Alarm Date (Days)** and **Hour/Minute/Second** will become user-configurable with set values.

## 4.5.11 Serial Port Console Redirection

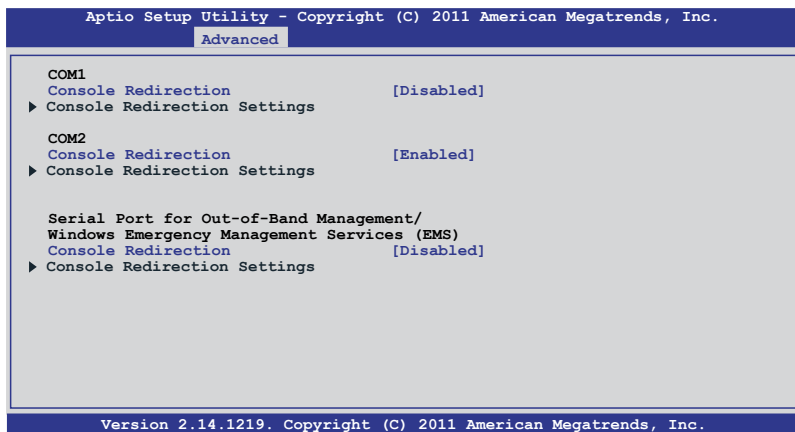

### COM1

#### Console Redirection [Disabled]

This item enables or disables the console redirection feature.

Configuration options: [Disabled] [Enabled]



The following item appears only when you set **Console Redirection** to [Enabled].

#### Console Redirection Settings

This item becomes configurable only when you enable the **Console Redirection** item. The settings specify how the host computer and the remote computer (which the user is using) will exchange data. Both computers should have the same or compatible settings.

##### Terminal Type [VT-UTF8]

Allows you to set the terminal type.

[VT100] ASCII char set

[VT100+] Extends VT100 to support color, function keys, etc.

[VT-UTF8] Uses UTF8 encoding to map Unicode chars onto 1 or more bytes

[ANSI] Extended ASCII char set

##### Bits per second [57600]

Selects serial port transmission speed. The speed must be matched on the other side. Long or noisy lines may require lower speeds.

Configuration options: [9600] [19200] [38400] [57600] [115200]

### Data Bits [8]

Configuration options: [7] [8]

### Parity [None]

A parity bit can be sent with the data bits to detect some transmission errors.

[Mark] and [Space] parity do not allow for error detection.

[None] No parity bit

[Even] Parity bit is 0 if the num of 1's in the data bits is even

[Odd] Parity bit is 0 if num of 1's in the data bits is odd

[Mark] Parity bit is always 1

[Space] Parity bit is always 0

### Stop Bits [1]

Stop bits indicate the end of a serial data packet. (A start bit indicates the beginning.)

The standard setting is 1 stop bit. Communication with slow devices may require more than 1 stop bit.

Configuration options: [1] [2]

### Flow Control [VT100]

Microsoft Windows Emergency Management Services (EMS) allow for remote management of a Windows Server OS through a serial port.

Configuration options: [VT100] [Hardware RTS/CTS] [Software Xon/Xoff]

### Recorder Mode [Disabled]

With this mode enabled, only text will be sent. This is to capture Terminal data.

Configuration options: [Disabled] [Enabled]

### Recorder 100x31 [Disabled]

This item allows you to enable or disable extended terminal resolution.

Configuration options: [Disabled] [Enabled]

### Legacy OS Redirction Resolution [80x24]

This item configures the number of rows and columns supported on legacy OS.

Configuration options: [80x24] [80x25]

## COM2

### **Console Redirection [Disabled]**

Enables or disables the console redirection feature.

Configuration options: [Disabled] [Enabled]

### **Console Redirection Settings**

Please refer to the description of the **Console Redirection Settings** item under **COM1** for details.



## Serial Port for Out-of-Band Management/ Windows Emergency Management Services (EMS)

### Console Redirection [Disabled]

Enables or disables the console redirection feature.

Configuration options: [Disabled] [Enabled]



---

The following item appears only when you set **Console Redirection** to [Enabled].

---

### Console Redirection Settings

#### Out-of-Band Mgmt Port [COM1]

Microsoft Windows Emergency Management Services (EMS) allow for remote management of a Windows Server OS through a serial port.

Configuration options: [COM1] [COM2]

#### Terminal Type [VT-UTF8]

Microsoft Windows Emergency Management Services (EMS) allow for remote management of a Windows Server OS through a serial port.

Configuration options: [VT100] [VT100+] [VT-UTF8] [ANSI]

#### Bits per second [115200]

Microsoft Windows Emergency Management Services (EMS) allow for remote management of a Windows Server OS through a serial port.

Configuration options: [9600] [19200] [57600] [115200]

#### Flow Control [VT100]

Microsoft Windows Emergency Management Services (EMS) allow for remote management of a Windows Server OS through a serial port.

Configuration options: [VT100] [Hardware RTS/CTS] [Software Xon/Xoff]

## 4.5.12 Onboard LAN Configuration

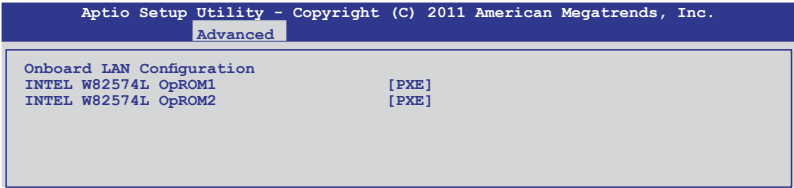

### INTEL W82574L OpROM1 [PXE]

This item launched INTEL W82574L OpROM1.

Configuration options: [Disabled] [PXE] [iSCSI]

### INTEL W82574L OpROM2 [PXE]

This item launched INTEL W82574L OpROM2.

Configuration options: [Disabled] [PXE] [iSCSI]

## 4.5.13 Marvell SATA Configuration

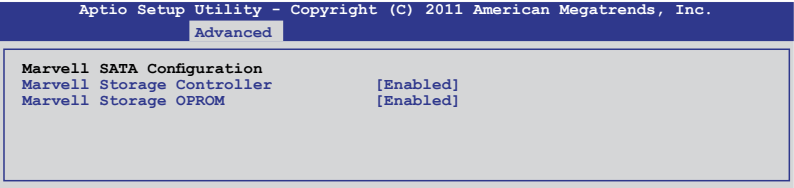

### Marvell Storage Controller [Enabled]

Configuration options: [Disabled] [Enabled]

#### Marvell Storage OPROM [Enabled]

Configuration options: [Disabled] [Enabled]

## 4.5.14 Onboard Devices Configuration

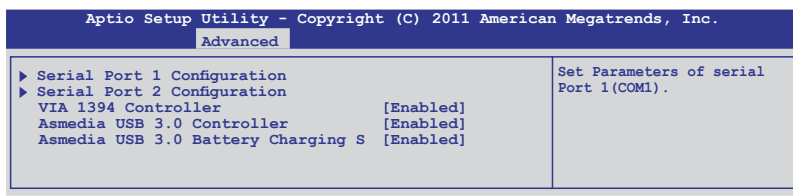

### Serial Port1/2 Configuration

This item allows you to set parameters of serial ports 1 and 2.

#### Serial Port [Enabled]

This item allows you to enable or disable the Serial Port.

Configuration options: [Disabled] [Enabled]

#### Device Mode [Standard Serial Port Mode]

This item allows you to change the serial port mode.

Configuration options: [Standard Serial Port Mode]

### VIA 1394 Controller [Enabled]

This item allows you to enable or disable VIA 1394.

Configuration options: [Disabled] [Enabled]

### Asmedia USB 3.0 Controller [Enabled]

This item allows you to enable or disable Asmedia USB 3.0.

Configuration options: [Disabled] [Enabled]

#### Asmedia USB 3.0 Battery Charging S [Enabled]

This item allows you to enable or disable Asmedia USB 3.0 Battery Charging S.

Configuration options: [Disabled] [Enabled]

## 4.5.15 Runtime Error Logging



### **Runtime Error Logging Support [Disabled]**

This item allows you to enable or disable Runtime Error Logging Support.

Configuration options: [Disabled] [Enabled]



---

The following item appears only when you set **Runtime Error Logging Support** to [Enabled].

---

### ***PCI Error Logging Support [Disabled]***

This item allows you to enable or disable PCI Error Logging.

Configuration options: [Disabled] [Enabled].

## 4.6 Server Management menu

The Server Management menu displays the server management status, and allows you to change the settings.



The Server Management menu appears only when you install ASMB card on the motherboard.

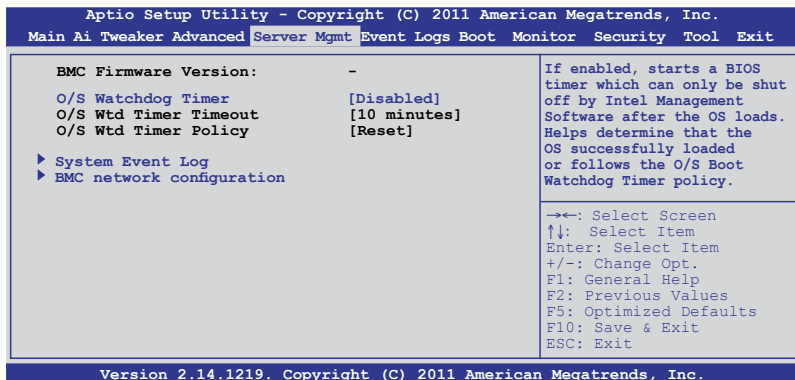

### O/S Watchdog Timer [Disabled]

If enabled, starts a BIOS timer which can only be shut off by Intel Management Software after the OS loads. Helps determine that the OS successfully loaded or follows the **O/S Boot Watchdog Timer Policy**.

Configuration options: [Enabled] [Disabled]

### O/S Wtd Timer Timeout [10 minutes]

Allows to configure the length of the O/S Boot Watchdog Timer. Not available if **O/S Boot Watchdog Timer** is disabled.

Configuration options: [5 minutes] [10 minutes] [15 minutes] [20 minutes]

### O/S Wtd Timer Policy [Reset]

Allows to configure how the system should respond if the **OS Boot Watchdog Timer** expires. Not available if **O/S Boot Watchdog Timer** is disabled.

Configuration options: [Do Nothing] [Reset] [Power Down]

## 4.6.1 System Event Log

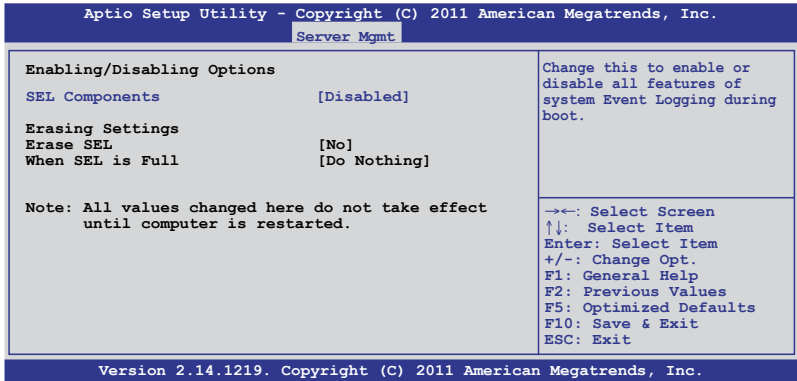

### SEL Components [Disabled]

Allows you to enable or disable all features of system Event Logging during boot.  
Configuration options: [Disabled] [Enabled]



- The following items appears only when you set **SEL Components** to [Enabled].
- All values changed here do not take effect until computer is restarted.

### Erase SEL [No]

Allows to choose options for erasing SEL.  
Configuration options: [No] [Yes, On next reset] [Yes, On every reset]

### When SEL is Full [Do Nothing]

Allows to choose options for reactions to a full SEL.  
Configuration options: [Do Nothing] [Erase Immediately]

## 4.6.2 BMC network configuration

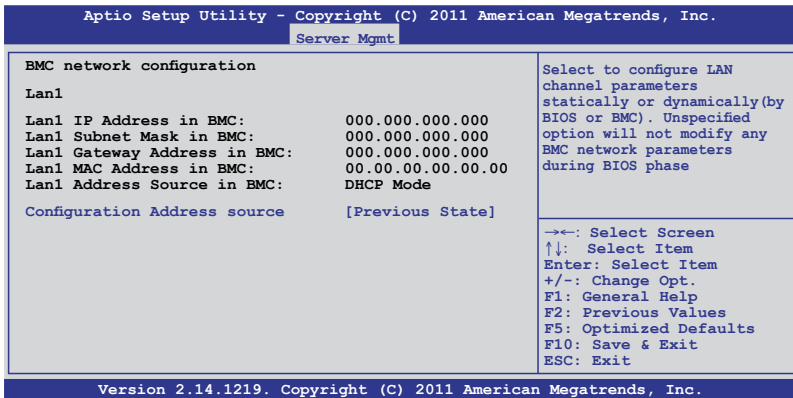

### Configuration Address source [Previous State]

Select to configure LAN channel parameters statically or dynamically (by BIOS or BMC). Unspecified option will not modify any BMC network parameters during BIOS phase.

Configuration options: [Previous State] [Static Mode] [DHCP Mode]



The following items appear only when you set **Configuration Address source** to [Static Mode].

#### Station IP address [0.0.0.0]

Allows to input Station IP address.

#### Subnet mask [0.0.0.0]

Allows to input Subnet mask.

#### Gateway IP address [0.0.0.0]

Allows to input Gateway IP address.

## 4.7 Event Logs menu

The Event Logs allows you to change or view the event log settings.



The Event Logs menu appears when the ASMB card is not installed on the motherboard.

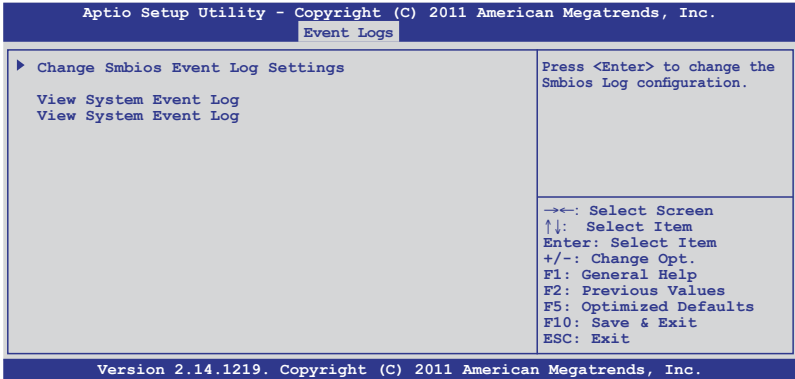

All values changed here do not take effect until computer is restarted.

### Change Smbios Event Log Settings

Press <Enter> to change the Smbios Event Log configuration.



For more information on this configuration, refer to [4.7.1 Change Smbios Event Log Settings](#).

### View Smbios Event Log

Press <Enter> to view all smbios event logs.

### View System Event Log

Press <Enter> to view all system event logs.



## 4.7.1 Change Smbios Event Log Settings

Aptio Setup Utility - Copyright (C) 2011 American Megatrends, Inc.	
Event Logs	
<b>Enabling/Disabling Options</b>	Change this to enable or disable all features of Smbios Event Logging during boot.
Smbios Event Log [Enabled]	
<b>Erasing Settings</b>	→←: Select Screen ↑↓: Select Item Enter: Select Item +/-: Change Opt. F1: General Help F2: Previous Values F5: Optimized Defaults F10: Save & Exit ESC: Exit
Erase Event Log [No]	
When Log is Full [Do Nothing]	
<b>Smbios Event Log Standard Settings</b>	
Log System Boot Event [Disabled]	
MECI 1	
METW 60	
<b>Custom Option</b>	
Log OEM Codes [Enabled]	
Convert OEM Codes [Disabled]	
Note: All values changed here do not take effect until computer is restarted.	

### Enabling/Disabling Options

#### Smbios Event Log [Enabled]

Change this to enable or disable all features of Smbios Event Logging during boot.

Configuration options: [Disabled] [Enabled]

### Erasing Settings

#### Erase Event Log [No]

Choose options for erasing Smbios Event Log. Erasing is done prior to any logging activation during reset.

Configuration options: [No] [Yes, Next reset] [Yes, Every reset]

#### When Log is Full [Do Nothing]

This item allows you to choose options for reactions to a full Smbios Event Log.

Configuration options: [Do Nothing] [Erase Immediately]

### Smbios Event Log Standard Settings

#### Log System Boot Event [Disabled]

This item allows you to choose options to enable/disable logging of System boot event.

Configuration options: [Enabled] [Disabled]

#### MECI [1]

This item allows you to set Mutiple Event Count Increment (MECI). The number of occurrences of a duplicate event that must pass before the multipl-event counter associated with the log entry is updated, specified as a numeric value in the range 1 to 255.

#### METW [60]

This item allows you to set Mutiple Event Time Windows (METW). The number of minutes which must pass between duplicate log entries which utilize a multiple-event counter. The value ranges from 0 to 99 minutes.

## **Custom Options**

### *Log OEM Codes [Enabled]*

This item allows you to enable or disable the logging of EFI Status Codes as OEM Codes (if not already converted to legacy).

Configuration options: [Disabled] [Enabled]

### *Convert OEM Codes [Disabled]*

This item allows you to enable or disable the converting of EFI Status Codes to Standard Smbios Types (Not all may be translated).

Configuration options: [Disabled] [Enabled]

## 4.8 Boot menu

The Boot menu items allow you to change the system boot options.

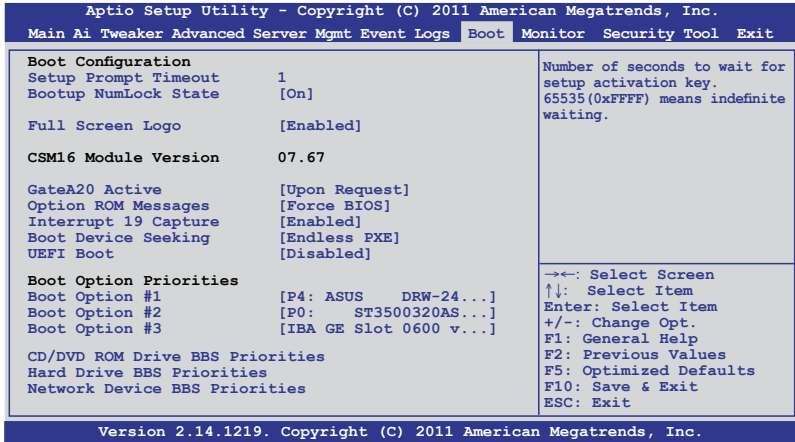

### Setup Prompt Timeout [xx]

Use the <+> and <-> keys to adjust the number of seconds to wait for setup activation key.

### Bootup NumLock State [On]

This item allows you to select the power-on state for the NumLock.

Configuration options: [Off] [On]

### Full Screen Logo [Enabled]

This item allows you to enable or disable the full screen logo display feature.

Configuration options: [Disabled] [Enabled]



1. Set Full Screen Logo to [Enabled] to use the ASUS MyLogo2™ feature.
2. Set Full Screen Logo to [Disabled] to select the desired Post Report waiting time from 1~10 sec.

### Post Report [5 sec]

Allows you to select a desired post report waiting time. This item only appears when you set the **Full Screen Logo** to [Disabled].

Configuration options: [1 sec] - [10 sec] [Until Press ESC]

## CSM16 Module Version

### GateA20 Active [Upon Request]

[Upon Request] GA20 can be disabled using BIOS services.

[Always] Do not allow disable GA20; this option is useful when any RT code is executed above 1MB.

### Option ROM Messages [Force BIOS]

Allows you to set the display mode for Options ROM.

Configuration options: [Force BIOS] [Keep Current]

### Interrupt 19 Capture [Enabled]

Allows Option ROMs to trap interrupt 19.

Configuration options: [Disabled] [Enabled]

### Boot Device Seeking [Endless PXE]

[Endless PXE] Continuous seek remote boot image until boot image found or user abort (press Ctrl+Alt+Del).

[Normal] Seek remote boot image once then stop.

### UEFI Boot [Disabled]

Enables or disables UEFI Boot.

Configuration options: [Disabled] [Enabled]

## Boot Option Priorities

These items specify the boot device priority sequence from the available devices. The number of device items that appears on the screen depends on the number of devices installed in the system.



- 
- To select the boot device during system startup, press <F8> when ASUS Logo appears.
  - To access Windows OS in Safe Mode, please press <F8> after POST.
- 

### Boot Option #1/#2/#3/#4 [IBA GE Slot 0600 v...]

Configuration options: [SATA P2: ASUS ...] [SATA P3: WDC WD80...] [AMI Virtual CDROM...] [IBA GE Slot 0600 v...]



---

These items appear only when you connect SATA ODD or hard drive to the SATA ports.

---

### CD/DVD ROM Drive BBS Priorities

### Hard Drive BBS Priorities

### Network Device BBS Priorities

These settings allow you to set the booting order of the SATA devices.

## Setup Mode [EZ Mode]

[Advanced Mode] Sets Advanced Mode as the default screen for entering the BIOS setup program.

[EZ Mode] Sets EZ Mode as the default screen for entering the BIOS setup program.

## Boot Option Priorities

These items specify the boot device priority sequence from the available devices. The number of device items that appears on the screen depends on the number of devices installed in the system. Select [Disabled] to disallow this function.



- 
- To select the boot device during system startup, press <F8> when ASUS Logo appears.
  - To access Windows OS in Safe Mode, press <F8> after POST.
- 

## Boot Override

These items displays the available devices. The number of device items that appears on the screen depends on the number of devices installed in the system. Click an item to start booting from the selected device.

## 4.9 Monitor menu

The Monitor menu displays the system temperature/power status, and allows you to change the fan settings.

```

Aptio Setup Utility - Copyright (C) 2011 American Megatrends, Inc.
Main AI Tweaker Advanced Server Mgmt Event Logs Boot Monitor Security Tool Exit

CPU1 Temperature          90.0°C/194.0°F
CPU2 Temperature          90.0°C/194.0°F
TR1 Temperature           18.0°C/64.4°F
TR2 Temperature           6.0°C/42.8°F
CPU FAN1 Speed            3658 RPM
CPU FAN2 Speed            3678 RPM
FRNT FAN1 Speed           N/A
FRNT FAN2 Speed           N/A
FRNT FAN3 Speed           N/A
FRNT FAN4 Speed           N/A
REAR FAN1 Speed           N/A
REAR FAN2 Speed           N/A
+VTT CPU                  +1.026 V
VCORE_CPU1                +0.996 V
VCORE_CPU2                +0.996 V
VSA_CPU1                  +0.898 V
VSA_CPU2                  +0.912 V
+VDDQ_AB_CPU1             +1.510 V
+VDDQ_CD_CPU1             +1.526 V
+VDDQ_EF_CPU2             +1.474 V
+VDDQ_GH_CPU2             +1.474 V
+5VSB                     +4.921 V
+5V                       +4.966 V
+12V                      +11.592 V
+3.3V                     +3.264 V

->-: Select Screen
↑↓: Select Item
Enter: Select Item
+/-: Change Opt.
F1: General Help
F2: Previous Values
F5: Optimized Defaults
F10: Save & Exit
ESC: Exit

-----
VBAT                      +3.168 V
+3.3VSB                   +3.234 V
FAN Speed Control         [Generic Mode]

Version 2.14.1219. Copyright (C) 2011 American Megatrends, Inc.
  
```



Use the scroll to view items.

### CPU 1/2; TR1 1/2 Temperature [xxx°C/xxx°F]

The onboard hardware monitor automatically detects and displays the CPU and motherboard component temperatures. Select **Ignore** if you do not wish to display the detected temperatures.

### CPU FAN1/2 Speed; FRNT FAN1–4 Speed; REAR FAN1/2 Speed [xxxx RPM] or [Ignore] / [N/A]

The onboard hardware monitor automatically detects and displays the speed of CPU fans, front fans, and rear fan in rotations per minute (RPM). If the fan is not connected to the motherboard, the field shows **N/A**.

**+VTT\_CPU Voltage, VCORE1/2 Voltage, VSA\_CPU1/2,  
+VDDQ\_AB\_CPU1 Voltage, +VDDQ\_CD\_CPU1 Voltage,  
+VDDQ\_EF\_CPU2 Voltage, +VDDQ\_GH\_CPU2 Voltage, +5VSB  
Voltage, +5V Voltage, +12V Voltage, +3.3V Voltage, VBAT Voltage,  
+3.3VSB Voltage**

The onboard hardware monitor automatically detects the voltage output through the onboard voltage regulators.

### **FAN Speed Control [Generic Mode]**

This item allows you to configure the ASUS Smart Fan feature that smartly adjusts the fan speeds for more efficient system operation.

Configuration options: [Generic Mode] [High Speed Mode] [Full Speed Mode]

## 4.10 Security menu

The Security menu items allow you to change the system security settings.

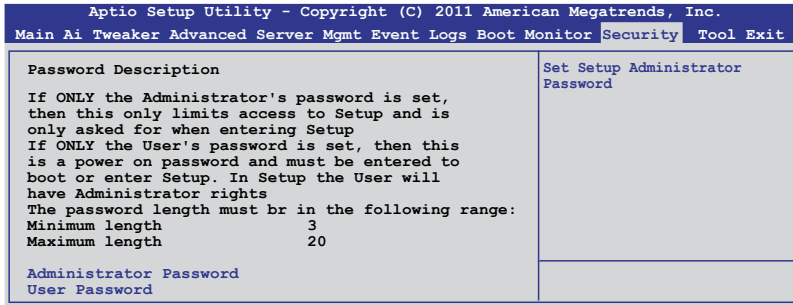

- If you have forgotten your BIOS password, erase the CMOS Real Time Clock (RTC) RAM to clear the BIOS password. See section 2.6 Jumpers for information on how to erase the RTC RAM.
- The **Administrator** or **User Password** items on top of the screen show the default **Not Installed**. After you set a password, these items show **Installed**.

### Administrator Password

If you have set an administrator password, we recommend that you enter the administrator password for accessing the system. Otherwise, you might be able to see or change only selected fields in the BIOS setup program.

To set an administrator password:

1. Select the **Administrator Password** item and press <Enter>.
2. From the **Create New Password** box, key in a password, then press <Enter>.
3. Confirm the password when prompted.

To change an administrator password:

1. Select the **Administrator Password** item and press <Enter>.
2. From the **Enter Current Password** box, key in the current password, then press <Enter>.
3. From the **Create New Password** box, key in a new password, then press <Enter>.
4. Confirm the password when prompted.

To clear the administrator password, follow the same steps as in changing an administrator password, but press <Enter> when prompted to create/confirm the password. After you clear the password, the **Administrator Password** item on top of the screen shows **Not Installed**.



## User Password

If you have set a user password, you must enter the user password for accessing the system. The **User Password** item on top of the screen shows the default **Not Installed**. After you set a password, this item shows **Installed**.

To set a user password:

1. Select the **User Password** item and press <Enter>.
2. From the **Create New Password** box, key in a password, then press <Enter>.
3. Confirm the password when prompted.

To change a user password:

1. Select the **User Password** item and press <Enter>.
2. From the **Enter Current Password** box, key in the current password, then press <Enter>.
3. From the **Create New Password** box, key in a new password, then press <Enter>.
4. Confirm the password when prompted.

To clear the user password, follow the same steps as in changing a user password, but press <Enter> when prompted to create/confirm the password. After you clear the password, the **User Password** item on top of the screen shows **Not Installed**.

## 4.11 Tool menu

The Tool menu items allow you to configure options for special functions. Select an item then press <Enter> to display the submenu.

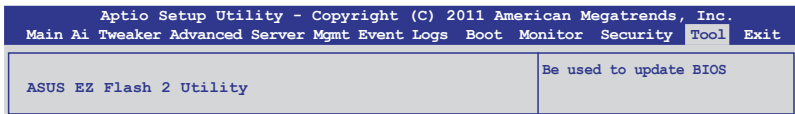

### ***ASUS EZ Flash 2 Utility***

This item allows you to run ASUS EZ Flash BIOS ROM Utility when you press <Enter>. Check section **4.1.2 ASUS EZ Flash 2 Utility** for details.

## 4.12 Exit menu

The Exit menu items allow you to save or discard your changes to the BIOS items.

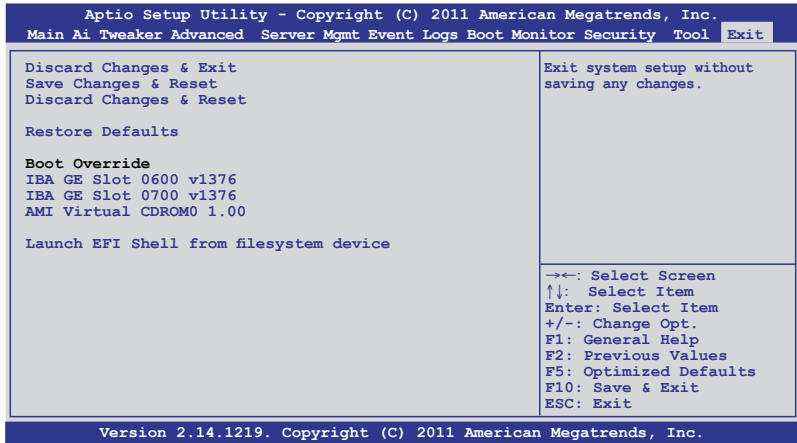

Pressing <Esc> does not immediately exit this menu. Select one of the options from this menu or <F10> from the legend bar to exit.

### Discard Changes & Exit

This option allows you to exit the Setup program without saving your changes. When you select this option or if you press <Esc>, a confirmation window appears. Select **Yes** to discard changes and exit.

### Save Changes & Reset

Once you are finished making your selections, choose this option from the Exit menu to ensure the values you selected are saved. When you select this option or if you press <F10>, a confirmation window appears. Select **Yes** to save changes and exit.

### Discard Changes & Reset

This option allows you to reset the Setup program without saving your changes. When you select this option, a confirmation window appears. Select **Yes** to discard changes and reset.

### Restore Defaults

This option allows you to restore/load defaults values for all the setup options. When you select this option, a confirmation window appears. Select **Yes** to load optimized defaults.

### Boot Override

These items displays the available devices. The device items that appears on the screen depends on the number of devices installed in the system. Click an item to start booting from the selected device.

# Chapter 5

This chapter provides instructions for setting up, creating and configuring RAID sets using the available utilities.



ASUS ESC2000 G2

# RAID configuration

## 5.1 RAID configurations

The system supports the following SATA RAID solutions:

- **LSI MegaRAID software RAID Configuration Utility** with RAID 0, RAID 1, and RAID 10 support (for both Linux and Windows OS).
- **Intel Rapid Storage Technology enterprise SCU / SATA Option ROM Utility** with RAID 0, RAID 1, RAID 10, and RAID 5 support (for Windows OS only).
- **Marvell RAID utility** with RAID 0 and RAID 1 support.



- 
- You must install Windows® XP Service Pack 3 or later versions before using Serial ATA hard disk drives. The Serial ATA RAID feature is available only if you are using Windows® XP SP3 or later versions.
  - Due to Windows® XP / Vista limitation, a RAID array with the total capacity over 2TB cannot be set as a boot disk. A RAID array over 2TB can only be set as a data disk only.
  - Intel® SATA ports do not support AHCI and RAID modes on Windows® XP.
  - If you want to install a Windows® operating system to a hard disk drive included in a RAID set, you have to create a RAID driver disk and load the RAID driver during OS installation. Refer to section **6.1.1 Creating a RAID driver disk** for details.
- 

### 5.1.1 RAID definitions

**RAID 0 (Data striping)** optimizes two identical hard disk drives to read and write data in parallel, interleaved stacks. Two hard disks perform the same work as a single drive but at a sustained data transfer rate, double that of a single disk alone, thus improving data access and storage. Use of two new identical hard disk drives is required for this setup.

**RAID 1 (Data mirroring)** copies and maintains an identical image of data from one drive to a second drive. If one drive fails, the disk array management software directs all applications to the surviving drive as it contains a complete copy of the data in the other drive. This RAID configuration provides data protection and increases fault tolerance to the entire system. Use two new drives or use an existing drive and a new drive for this setup. The new drive must be of the same size or larger than the existing drive.

**RAID 5** stripes both data and parity information across three or more hard disk drives. Among the advantages of RAID 5 configuration include better HDD performance, fault tolerance, and higher storage capacity. The RAID 5 configuration is best suited for transaction processing, relational database applications, enterprise resource planning, and other business systems. Use a minimum of three identical hard disk drives for this setup.

**RAID 10** is data striping and data mirroring combined without parity (redundancy data) having to be calculated and written. With the RAID 10 configuration you get all the benefits of both RAID 0 and RAID 1 configurations. Use four new hard disk drives or use an existing drive and three new drives for this setup.

### 5.1.2 Installing Serial ATA hard disks

The system supports Serial ATA hard disk drives. For optimal performance, install identical drives of the same model and capacity when creating a disk array.

To install the SATA hard disks for a RAID configuration:

1. Install the SATA hard disks into the drive bays.
2. Connect the SATA signal cables.
3. Connect a SATA power cable to the power connector on each drive.

### 5.1.3 Setting the RAID item in BIOS

You must enable the RAID function in the BIOS Setup before creating RAID set(s) using SATA HDDs. To do this:

1. Enter the BIOS Setup during POST.
2. Go to the **Advanced** menu > **SATA Configuration**, and then press <Enter>.
3. Set the **SATA Mode** item to [RAID Mode].
4. Save your changes, and then exit the BIOS Setup.



---

Refer to Chapter 4 for details on entering and navigating through the BIOS Setup.

---



---

Due to chipset limitation, when set any of SATA ports to RAID mode, all SATA ports run at RAID mode together.

---

## 5.2 LSI Software RAID Configuration Utility

The LSI MegaRAID software RAID configuration utility allows you to create RAID 0, RAID 1, or RAID 10 set(s) from SATA hard disk drives connected to the SATA connectors supported by the system southbridge chip.

To enter the LSI MegaRAID software RAID configuration utility:

1. Turn on the system after installing all the SATA hard disk drives.
2. During POST, the LSI MegaRAID software RAID configuration utility automatically detects the installed SATA hard disk drives and displays any existing RAID set(s). Press <Ctrl> + <M> to enter the utility.

```
LSI MegaRAID Software RAID BIOS Version A.10 09231523R
LSI SATA RAID Found at PCI Bus No:00 Dev No:1F
Device present at Port 0      ST3160812AS      152114MB
Device present at Port 1      ST3160812AS      152114MB
Device present at Port 2      ST3160812AS      152114MB
Device present at Port 3      ST3160812AS      152114MB
Press Ctrl-M or Enter to run LSI Software RAID Setup Utility.
```



- The LSI MegaRAID software RAID configuration utility automatically configures to RAID 1 when the SATA to RAID Mode is enabled.
- The RAID setup screens shown in this section are for reference only and may not exactly match the items on your screen due to the controller version difference.
- When you create RAID sets with the LSI MegaRAID software RAID configuration utility, the boot priority of the SATA optical drive has to be manually adjusted. Otherwise, the system will not boot from the connected SATA ODD.

3. The utility main window appears. Use the arrow keys to select an option from the **Management Menu** and then press <Enter>. Refer to the Management Menu descriptions on the next page.

At the bottom of the screen is the legend box. The keys on the legend box allow you to navigate through the setup menu options or execute commands. The keys on the legend box vary according to the menu level.

```
LSI Software RAID Configuration Utility Ver C.05 Apr 5, 2012
BIOS Version A.10.09231523R

Management Menu
Configure
Initialize
Objects
Rebuild
Check Consistency

Configure VD(s)

Use Cursor Keys to Navigate Between Items And Press Enter To Select An Option
```

Menu	Description
<b>Configure</b>	Allows you to create RAID 0, RAID 1 or RAID 10 set using the Easy Configuration or the New Configuration command. This menu also allows you to view, add, or clear RAID configurations or select the boot drive
<b>Initialize</b>	Allows you to initialize the virtual drives of a created RAID set
<b>Objects</b>	Allows you to initialize virtual drives or change the virtual drive parameters
<b>Rebuild</b>	Allows you to rebuild failed drives
<b>Check Consistency</b>	Allows you to check the data consistency of the virtual drives of a created RAID set

### 5.2.1 Creating a RAID set

The LSI Software RAID Configuration Utility allows you to create a RAID 0, RAID 1, or RAID 10 set using two types of configurations: **Easy** and **New**.

In **Easy Configuration**, the virtual drive parameters are set automatically.

In **New Configuration**, you manually set the virtual drive parameters.

#### Using Easy Configuration

To create a RAID set using the **Easy Configuration** option:

1. From the **Management Menu**, select **Configure > Easy Configuration**, and then press <Enter>.

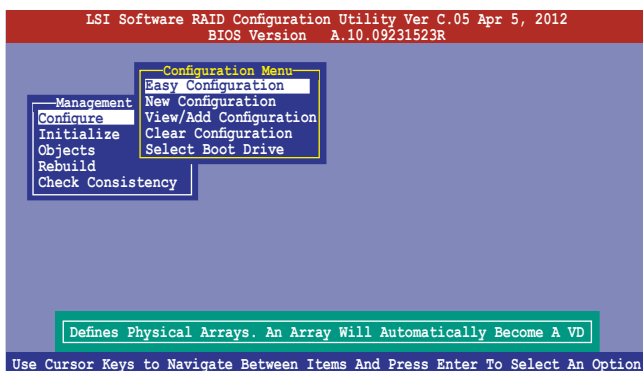

- The **ARRAY SELECTION MENU** displays the available drives connected to the SATA ports. Use the up/down arrow keys to select the drives you want to include in the RAID set, and then press <Space>. When selected, the drive indicator changes from **READY** to **ONLIN A[X]-[Y]**, where X is the array number, and Y is the drive number.

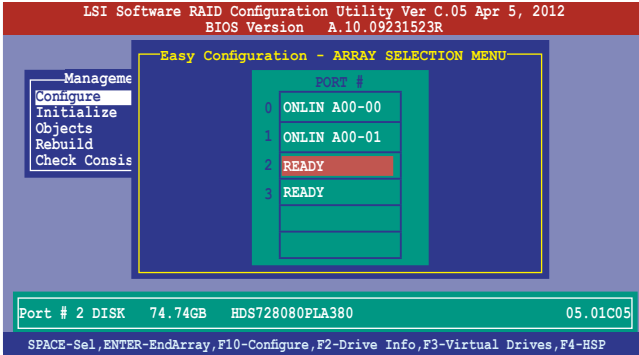

- The information of the selected hard disk drive displays at the bottom of the screen.
- You need at least two identical hard disk drives when creating a RAID 1 set.
- You need at least four identical hard disk drives when creating a RAID 10 set.

- Select all the drives required for the RAID set, and then press <F10> to configure array setting.
- Press <Space> to select the configurable array.

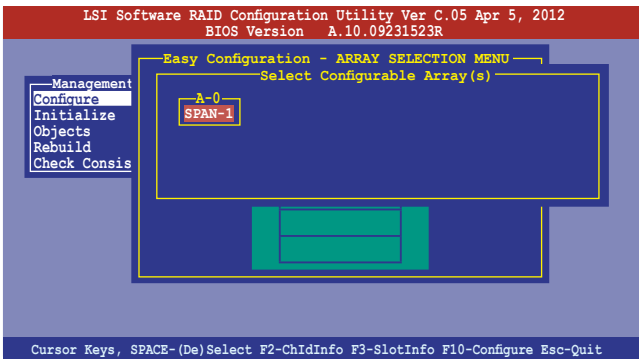



- Press <F10> again, the virtual drive information appears including a **Virtual Drive** menu that allows you to change the virtual drive parameters.

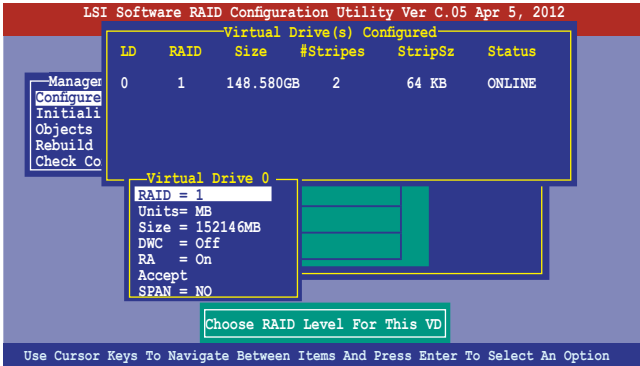

- Select **RAID** from the **Virtual Drive** sub-menu, and then press <Enter>.
- Select the **RAID** level from the menu, and then press <Enter>.

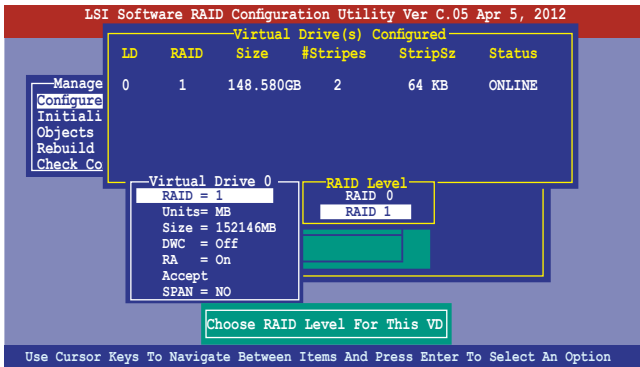

8. Select **Units** from the **Virtual Drive** sub-menu, and then press <Enter>.
9. Select the units for virtual drive size from the menu, and then press <Enter>.

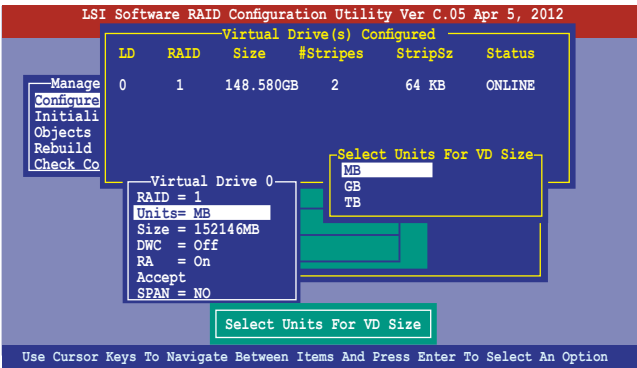

10. When creating a **RAID 1** or a **RAID 10** set, select **DWC** from the **Virtual Drive** menu, and then press <Enter>.
- When creating a **RAID 0** set, proceed to step 12.
11. Select **On** to enable the **Disk Write Cache** setting, and then press <Enter>.

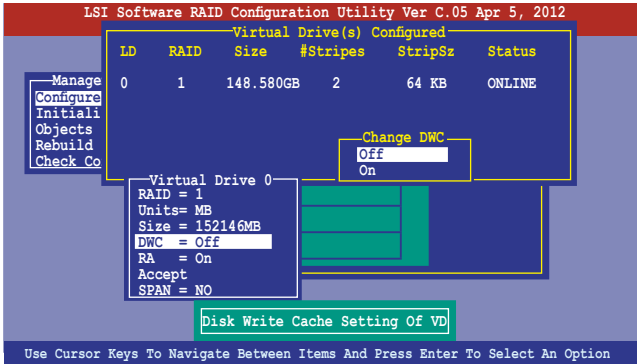

Enabling DWC can improve the performance, but with the risk of data loss.

12. When finished setting the selected virtual drive configuration, select **Accept** from the menu, and then press <Enter>.

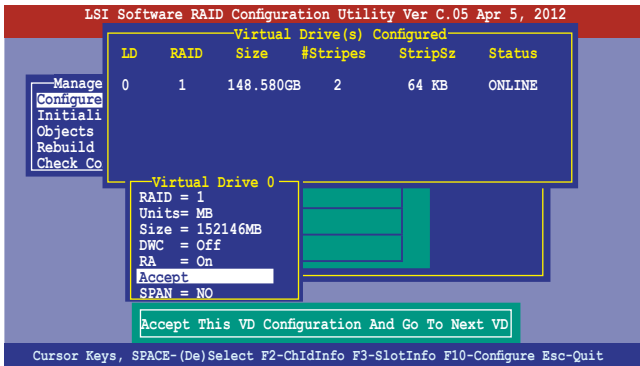

13. Follow step 2 to 10 to configure additional virtual drives.
14. Press <Esc> to finish RAID configuration. When prompted to save configuration, select **Yes** from the menu, and then press <Enter>.

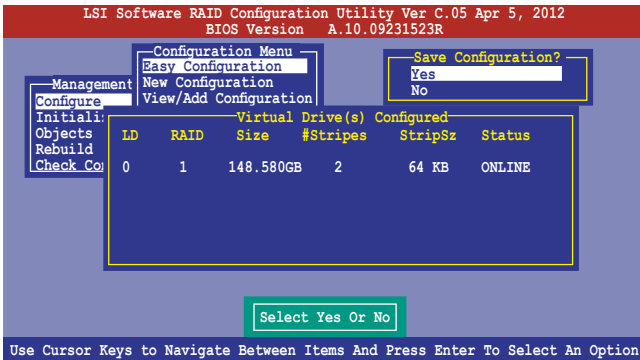

## Using New Configuration



When a RAID set already exists, using the **New Configuration** command erases the existing RAID configuration data. If you do not want to delete the existing RAID set, use the **View/Add Configuration** command to view or create another RAID configuration.

To create a RAID set using the **New Configuration** option:

1. From the **Management Menu**, select **Configure > New Configuration**, and then press <Enter>.

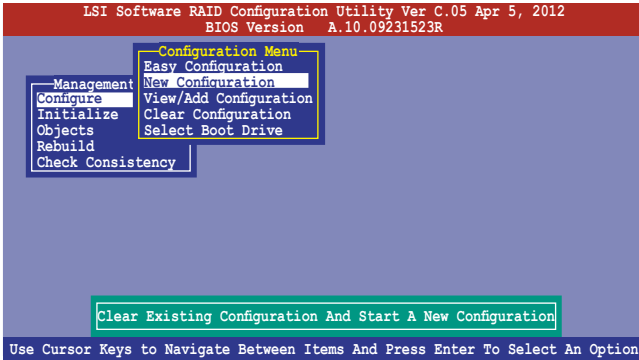

2. Follow step 2 to 9 of the previous section: **Using Easy Configuration**.
3. Select **Size** from the **Virtual Drive** menu, and then press <Enter>.
4. Key-in the desired virtual drive size, and then press <Enter>.

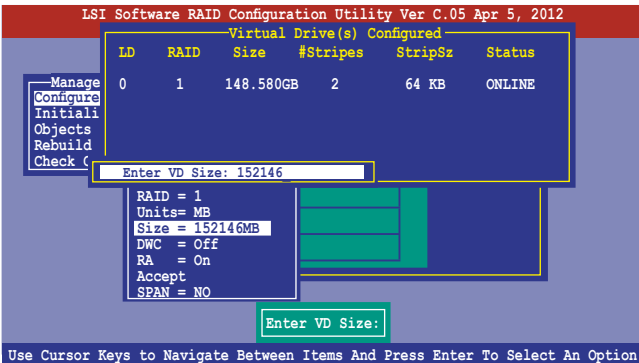

5. Follow step 10 to 14 of the previous section: **Using Easy Configuration** to create the RAID set.

## 5.2.2 Adding or viewing a RAID configuration

You can add a new RAID configuration or view an existing configuration using the **View/Add Configuration** command.

### Adding a new RAID configuration

To add a new RAID configuration:

1. From the **Management Menu**, select **Configure > View/Add Configuration**, and then press <Enter>.

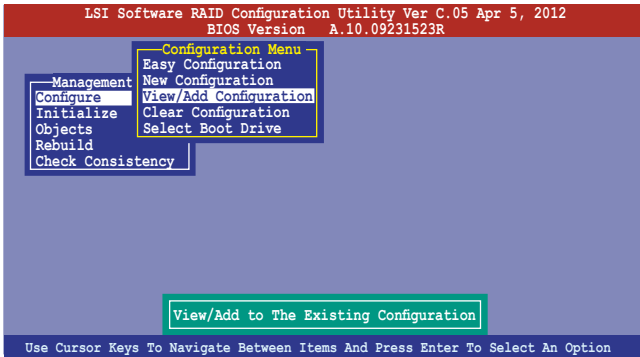

2. The **ARRAY SELECTION MENU** displays the available drives connected to the SATA ports. Select the drive(s) you want to include in the RAID set, then press <Space>. When selected, the drive indicator changes from **READY** to **ONLIN A[X]-[Y]**, where X is the array number, and Y is the drive number.

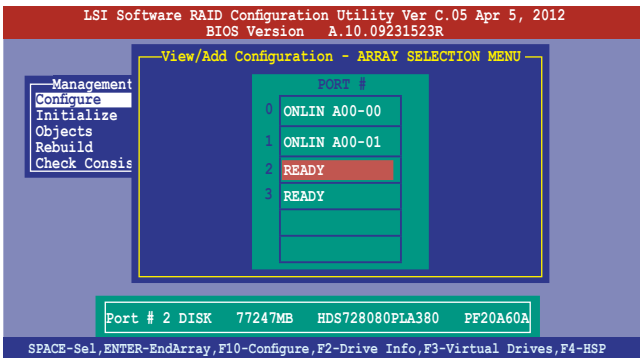

The information of the selected hard disk drive displays at the bottom of the screen.

3. Follow step 3 to 12 of section 5.2.1 **Creating a RAID set: Using Easy Configuration** to add a new RAID set.

### 5.2.3 Initializing the virtual drives

After creating the RAID set(s), you must initialize the virtual drives. You may initialize the virtual drives of a RAID set(s) using the **Initialize** or **Objects** command on the **Management Menu**.

#### Using the Initialize command

To initialize the virtual drive using the Initialize command:

1. From the **Management Menu**, select **Initialize**, and then press <Enter>.

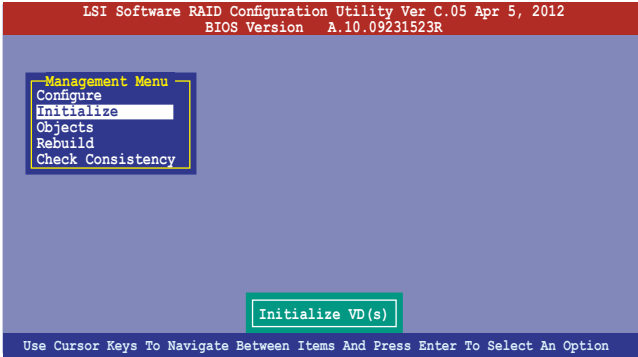

2. The screen displays the available RAID set(s) and prompts you to select the virtual drive to initialize. Use the arrow keys to select the virtual drive from the **Virtual Drive** selection, and then press <Space>.

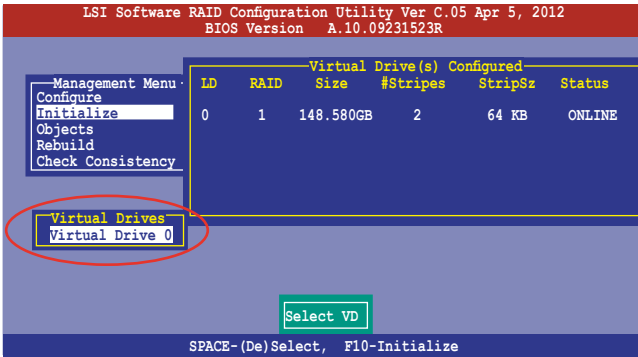

- Press <F10> to start initialization. When prompted, select **Yes** from the **Initialize?** dialog box, and then press <Enter>.

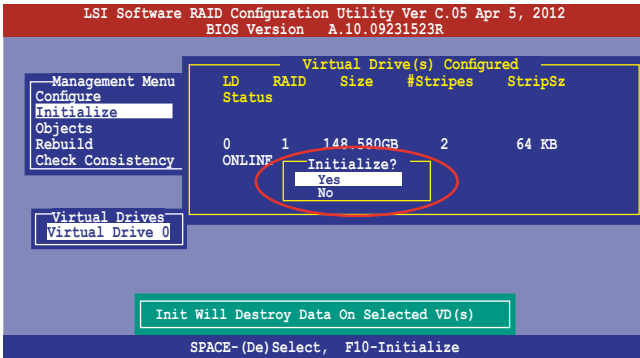

Initializing a virtual drive erases all data on the drive.

- A progress bar appears on screen. If desired, press <Esc> to abort initialization. When initialization is completed, press <Esc>.

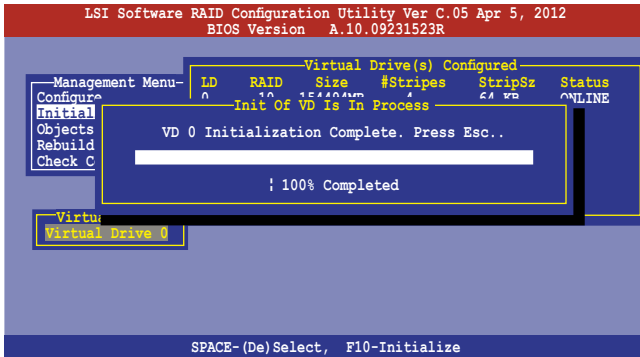

# Using the Objects command

To initialize the virtual drives using the **Objects** command

1. From the **Management Menu**, select **Objects > Virtual Drive**, and then press <Enter>.

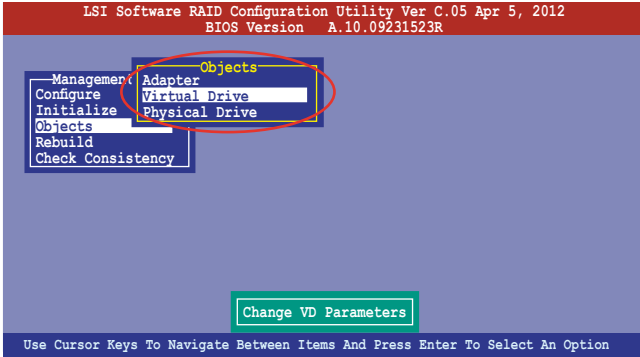

2. Select the virtual drive to initialize from the **Virtual Drives** sub-menu, and then press <Enter>.

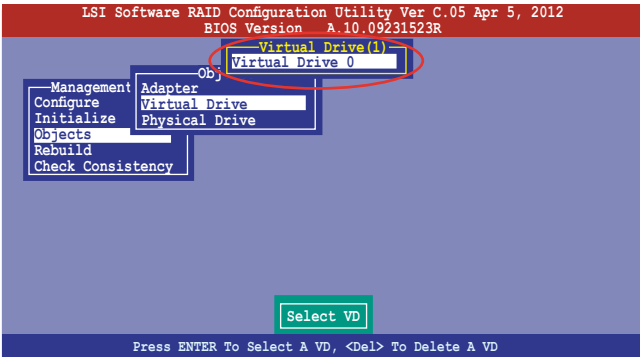



3. Select **Initialize** from the pop-up menu, and then press <Enter> to start initialization.

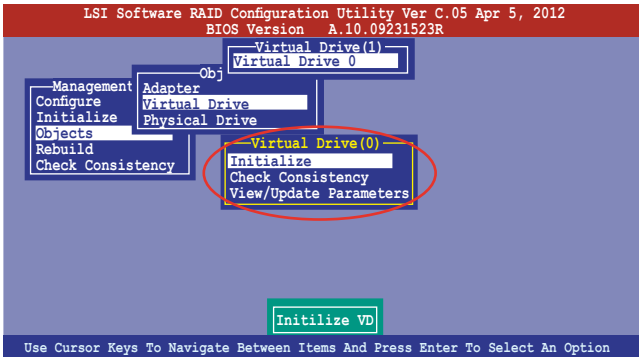

4. When prompted, press the <Space> to select **Yes** from the **Initialize?** dialog box, and then press <Enter>.

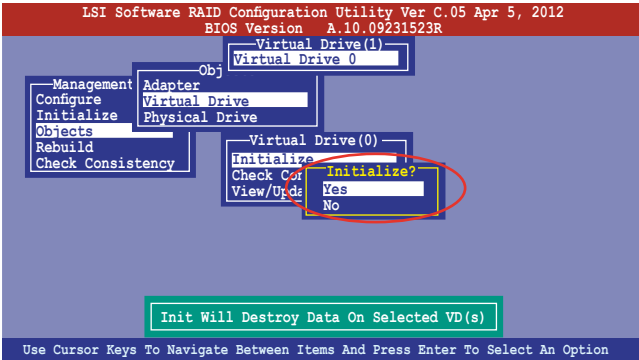

5. A progress bar appears on screen. If desired, press <Esc> to abort initialization. When initialization is completed, press <Esc>.

## 5.2.4 Rebuilding failed drives

You can manually rebuild failed hard disk drives using the **Rebuild** command in the **Management Menu**.

To rebuild a failed hard disk drive:

1. From the **Management Menu**, select **Rebuild**, and then press <Enter>.

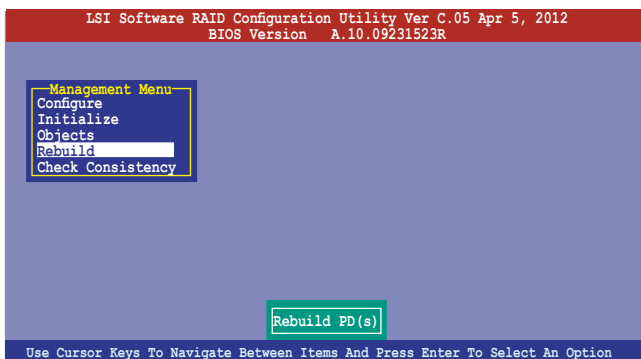

2. The **PHYSICAL DRIVES SELECTION MENU** displays the available drives connected to the SATA ports. Select the drive you want to rebuild, and then press <Space>.

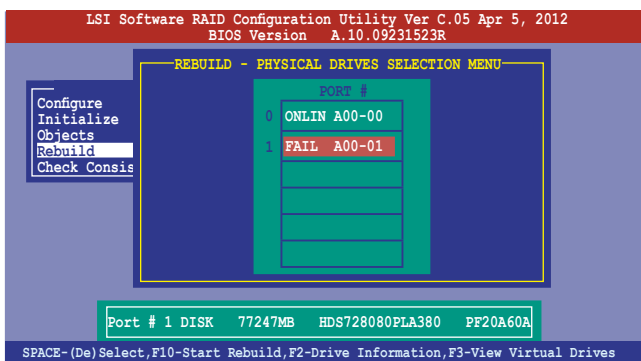

3. After selecting the drive to rebuild, press <F10>. When prompted, press <Y> to rebuild the drive.

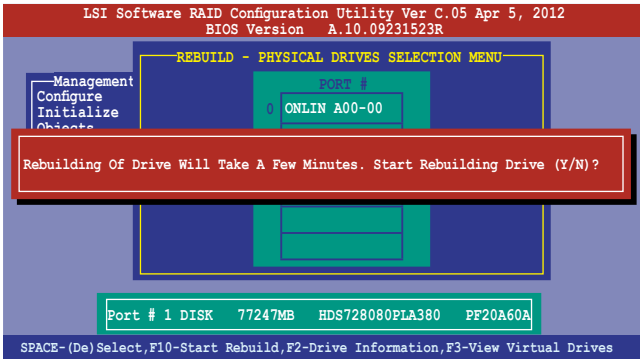

4. When rebuild is complete, press any key to continue.

## 5.2.5 Checking the drives for data consistency

You can check and verify the accuracy of data redundancy in the selected virtual drive. The utility can automatically detect and/or detect and correct any differences in data redundancy depending on the selected option in the **Objects > Adapter** menu.



The **Check Consistency** command is available only for virtual drives included in a RAID 1 or RAID 10 set.

### Using the Check Consistency Command

To check data consistency using the **Check Consistency** command

1. From the **Management Menu**, select **Check Consistency**, and then press <Enter>.

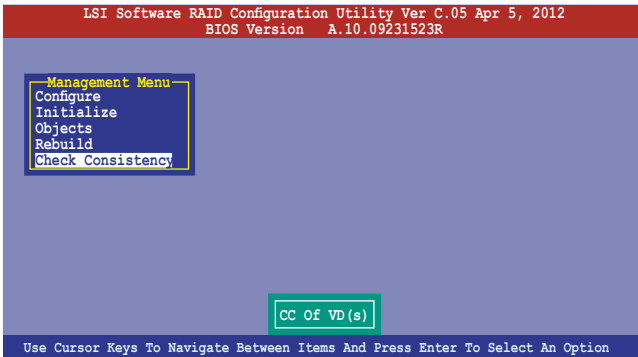

2. The screen displays the available RAID set(s) and prompts you to select the virtual drive to check. Press <Space> to select the virtual drive from the **Virtual Drive** sub-menu, and then press <F10>.

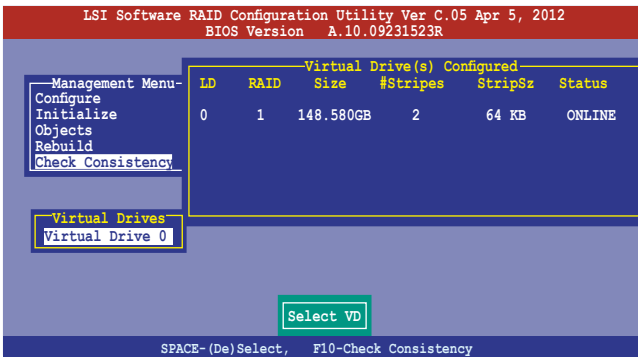

- When prompted, use the arrow keys to select **Yes** from the **Consistency Check?** dialog box, and then press <Enter>.

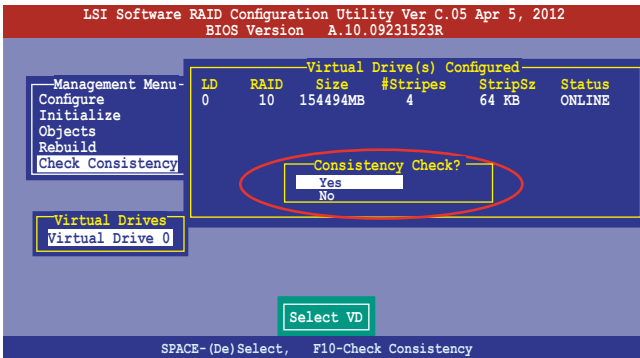

A progress bar appears on screen.

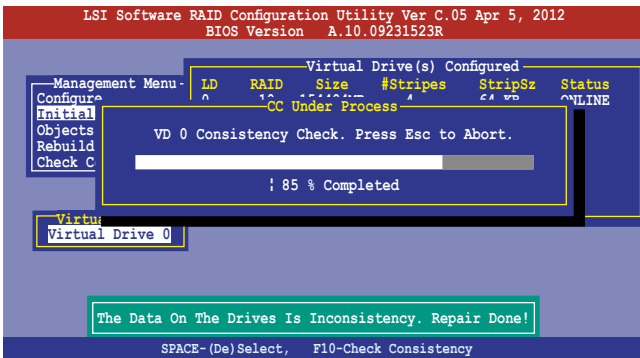

- While checking the disk consistency, press <Esc> to display the following options.
  - Stop** - Stops the consistency check. The utility stores the percentage of disk checked, and when you restart checking, it continues from the last percentage completed rather than from zero percent.
  - Continue** - Continues the consistency check.
  - Abort** - Aborts the consistency check. When you restart checking, it continues from zero percent.
- When checking is complete, press any key to continue.

## Using the Objects command

To check data consistency using the **Objects** command

1. From the **Management Menu**, select **Objects**, and then select **Virtual Drive** from the sub-menu.
2. Use the arrow keys to select the virtual drive you want to check, and then press <Enter>.
3. Select **Check Consistency** from the pop-up menu, and then press <Enter>.
4. When prompted, use the arrow keys to select **Yes** from the dialog box to check the drive.
5. When checking is complete, press any key to continue.

## 5.2.6 Deleting a RAID configuration

To delete a RAID configuration:

1. From the **Management Menu**, select **Configure > Clear Configuration**, and then press <Enter>.

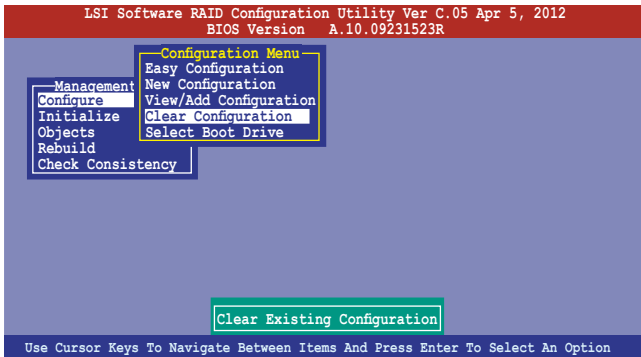

2. When prompted, use the arrow keys to select **Yes** from the **Clear Configuration?** dialog box, and then press <Enter>.

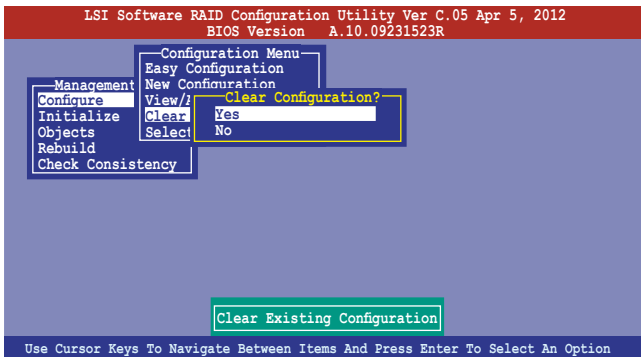

The utility clears all the current array(s).

3. Press any key to continue.

## 5.2.7 Selecting the boot drive from a RAID set

You must have created a new RAID configuration before you can select the boot drive from a RAID set. See section 5.2.1 **Creating a RAID set: Using New Configuration** for details.

To select the boot drive from a RAID set:

1. From the **Management Menu**, select **Configure > Select Boot Drive**, and then press <Enter>.

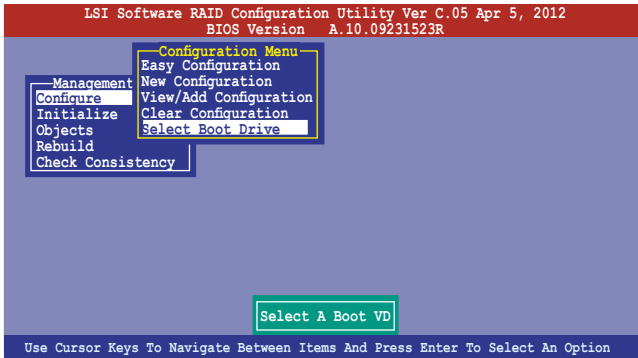

2. When prompted, use the arrow keys to select the bootable virtual drive from the list, then press <Enter>.

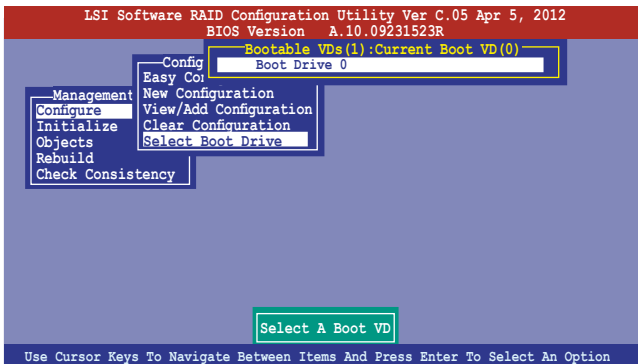

3. The virtual drive is selected as boot drive. Press any key to continue.



## 5.2.8 Enabling WriteCache

You may manually enable the RAID controller's WriteCache option after creating a RAID set to improve the data transmission performance.



When you enable WriteCache, you may lose data when a power interruption occurs while transmitting or exchanging data among the drives.



The WriteCache function is recommended for RAID 1 and RAID 10 sets.

To enable WriteCache:

1. From the **Management Menu**, select **Objects > Adapter**, select an existing adapter, and then press <Enter> to display the adapter properties.
2. Select **Disk WC**, and then press <Enter> to turn on the option.

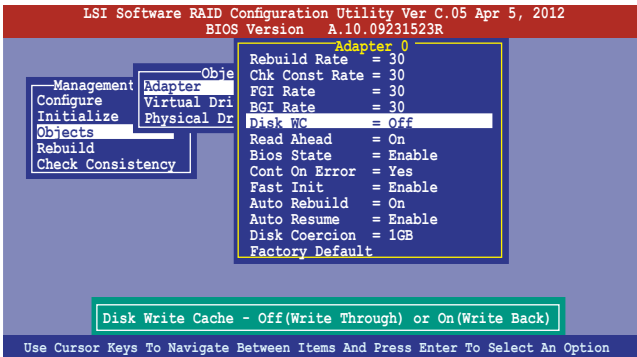

3. From the **Management Menu**, select **Objects > Virtual Drive**, select an existing adapter and press <Enter>. Select **View/Update Parameters** and press <Enter> to display the adapter properties.
4. Select **Disk WC**, and then press <Enter> to turn on the option.

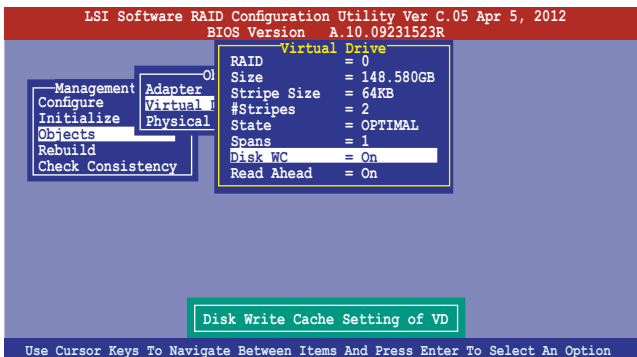

5. When finished, press any key to continue.

## 5.3 Intel® Rapid Storage Technology enterprise SCU/SATA Option ROM Utility

The Intel® Rapid Storage Technology enterprise SCU / SATA Option ROM utility allows you to create RAID 0, RAID 1, RAID 10 (RAID 1+0), and RAID 5 set(s) from Serial ATA hard disk drives that are connected to the Serial ATA connectors supported by the Southbridge.

You can create RAID mode by use of onboard AHCI SATA ports.

To use onboard SATA ports:

1. Install all the Serial ATA hard disk drives.
2. Turn on the system. During POST, press, <Delete> to enter BIOS. Go to **Advanced Menu > PCH SATA Configuration > SATA Mode**, then press <Enter>.
3. Set **SATA Mode** to **RAID Mode** and save, then reboot system.
4. During POST, press <Ctrl+l> to display the utility main menu.

To use SCU SATA ports:

1. Install all the SATA hard disk drives.
2. Turning on the system. During POST, press <Del> to enter BIOS. Go to **Advanced Menu > PCH SCU SATA Configuration**, then press <Enter>.
3. Confirm all the SATA hard disk drives you installed are correctly displayed, then reboot system.
4. During POST, press <Ctrl+l> to display the utility main menu.

To enter the Intel® Rapid Storage Technology enterprise SATA/SCU Option ROM utility:

1. Install all the Serial ATA hard disk drives.
2. Turn on the system.
3. During POST, press <Ctrl+l> to display the utility main menu.

```
Intel(R) Rapid Storage Technology - Option ROM - v3.0.0.1184
Copyright(C) 2003-11 Intel Corporation. All Rights Reserved.

[ MAIN MENU ]
1. Create RAID Volume
2. Delete RAID Volume
3. Reset Disks to Non-RAID
4. Exit

[ DISK/VOLUME INFORMATION ]

RAID Volumes:
None defined.

Physical Disks:
ID Drive Model Serial # Size Type/Status (Vol ID)
0 ST3300656SS HWAS0000991753TR 279.3GB Non-RAID Disk
1 ST3300656SS 37VN00009846RAJ1 279.3GB Non-RAID Disk
2 ST3300656SS 397600009846UEDY 279.3GB Non-RAID Disk
3 ST3300656SS GWC50000991756G6 279.3GB Non-RAID Disk

[↑]-Select [ESC]-Exit [ENTER]-Select Menu
```

The navigation keys at the bottom of the screen allow you to move through the menus and select the menu options.



The RAID BIOS setup screens shown in this section are for reference only and may not exactly match the items on your screen.



The utility supports maximum four hard disk drives for RAID configuration.

### 5.3.1 Creating a RAID set

To create a RAID set:

1. From the utility main menu, select **1. Create RAID Volume** and press <Enter>. The following screen appears:

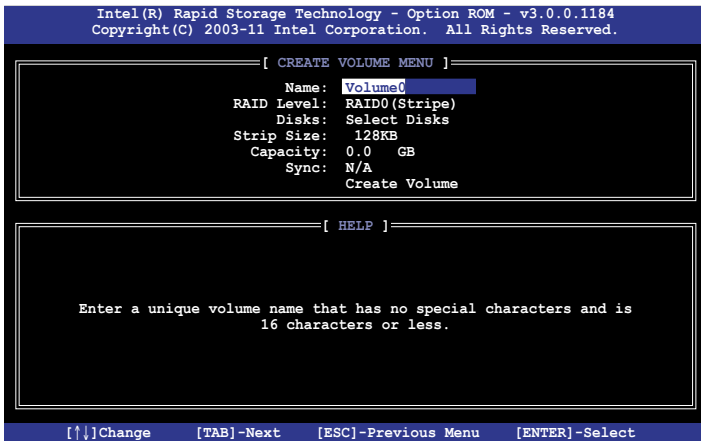

2. Enter a name for the RAID set and press <Enter>.
3. When the **RAID Level** item is selected, press the up/down arrow key to select a RAID level to create, and then press <Enter>.
4. When the **Disks** item is selected, press <Enter> to select the hard disk drives you want to include in the RAID set. The **SELECT DISKS** screen appears:

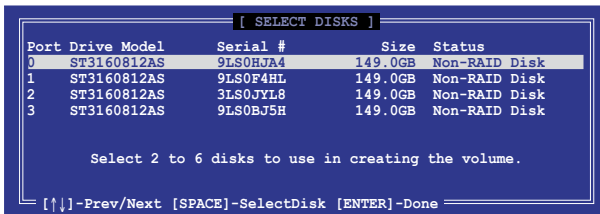

5. Use the up/down arrow key to select a drive, and then press <Space> to select. A small triangle marks the selected drive. Press <Enter> after completing your selection.
6. Use the up/down arrow key to select the stripe size for the RAID array (for RAID 0, 10 and 5 only), and then press <Enter>. The available stripe size values range from 4KB to 128KB. The following are typical values:
  - RAID 0: 128KB
  - RAID 10: 64KB
  - RAID 5: 64KB





---

We recommend a lower stripe size for server systems, and a higher stripe size for multimedia computer systems used mainly for audio and video editing.

---

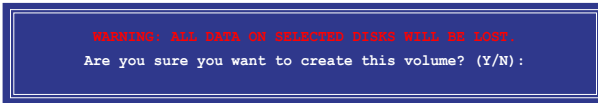
7. When the **Capacity** item is selected, enter the RAID volume capacity that you want and press <Enter>. The default value indicates the maximum allowed capacity.
8. When the **Create Volume** item is selected, press <Enter>. The following warning message appears:



9. Press <Y> to create the RAID volume and return to the main menu, or <N> to go back to the **CREATE VOLUME** menu.

### 5.3.2 Creating a Recovery set

To create a recovery set:

1. From the utility main menu, select **1. Create RAID Volume** and press <Enter>. The following screen appears.

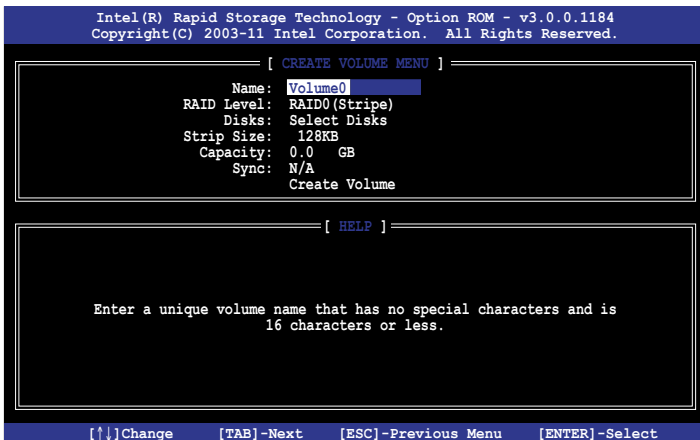

2. Enter a name for the recovery set and press <Enter>.
3. When the **RAID Level** item is selected, press the up/down arrow keys to select **Recovery**, and then press <Enter>.
4. When the **Disks** item is selected, press <Enter> to select the hard disk drives you want to include in the recovery set. The **SELECT DISKS** screen appears.

```

[ SELECT DISKS ]

Port Drive Model      Serial #      Size      Status
0  ST3300656SS  HWAS0000991753TR  279.3GB  Non-RAID Disk
1  ST3300656SS  37VN00009846RAJ1  279.3GB  Non-RAID Disk
2  ST3300656SS  397600009846UEDY  279.3GB  Non-RAID Disk
3  ST3300656SS  GWC50000991756G6  279.3GB  Non-RAID Disk

Select 1 Master and 1 Recovery disk to create volume.

[↑,↓]-Prev/Next [TAB]- (M)aster [SPACE]- (R)ecovery [ENTER]-Done

```

5. Use the up/down arrow keys to select a drive, press <TAB> to select a Master disk, and then press <SPACE> to select a Recovery disk. A small triangle marks the selected drive. Press <Enter> after completing your selection.
6. When the **Sync** item is selected, use the up/down arrow keys to select a sync option that you want and press <Enter>.
7. When the **Create Volume** item is selected, press <Enter>. The following warning message appears.

```

WARNING: ALL DATA ON SELECTED DISKS WILL BE LOST
Are you sure you want to create this volume? (Y/N):

```

8. Press <Y> to create the recovery set and return to the main menu, or <N> to go back to the **CREATE VOLUME** menu.



If a recovery set is created, you cannot add more RAID sets even when you have more non-RAID disks installed in your system.

### 5.3.3 Deleting a RAID set



Take caution when deleting a RAID set. You will lose all data on the hard disk drives when you delete a RAID set.

To delete a RAID set:

1. From the utility main menu, select **2. Delete RAID Volume** and press <Enter>. The following screen appears:

```
Intel(R) Rapid Storage Technology - Option ROM - v3.0.0.1184
Copyright(C) 2003-11 Intel Corporation. All Rights Reserved.

-----[ DELETE VOLUME MENU ]-----
Name      Level      Drives    Capacity  Status    Bootable
Volume0   RAID0(Stripe)  2         298.0GB   Normal    Yes

-----[ HELP ]-----

Deleting a volume will reset the disks to non-RAID.

WARNING: ALL DISK DATA WILL BE DELETED.
(This does not apply to Recovery volumes)

[↑↓]-Select      [ESC]-Previous Menu  [DEL]-Delete Volume
```

2. Use the up/down arrow key to select the RAID set you want to delete, and then press <Del>. The following warning message appears:

```
[ DELETE VOLUME VERIFICATION ]

ALL DATA IN THE VOLUME WILL BE LOST!
(This does not apply to Recovery volumes)

Are you sure you want to delete volume "Volume0"? (Y/N):
```

3. Press <Y> to delete the RAID set and return to the utility main menu, or press <N> to return to the **DELETE VOLUME** menu.

## 5.3.4 Resetting disks to Non-RAID



Take caution before you reset a RAID volume hard disk drive to non-RAID. Resetting a RAID volume hard disk drive deletes all internal RAID structure on the drive.

To reset a RAID set hard disk drive:

1. From the utility main menu, select **3. Reset Disks to Non-RAID** and press <Enter>. The following screen appears.

```
[ RESET RAID DATA ]

Resetting RAID disk will remove its RAID structures
and revert it to a non-RAID disk.

WARNING: Resetting a disk causes all data on the disk to be lost.
(This does not apply to Recovery volumes)

Port Drive Model      Serial #      Size  Status
0  ST3300656SS  HWAS0000991753TR  279.3GB  Member Disk
1  ST3300656SS  37VN00009846RAJ1  279.3GB  Member Disk

Select the disks that should be reset.

[↑↓]-Previous/Next [SPACE]-Selects [ENTER]-Selection Complete
```

2. Use the up/down arrow keys to select the RAID set drive(s) you want to reset, and then press <Space> to select.
3. Press <Enter> to reset the RAID set drive(s). A confirmation message appears.
4. Press <Y> to reset the drive(s) or press <N> to return to the utility main menu.

## 5.3.5 Exiting the Intel® Rapid Storage Technology utility

To exit the utility:

1. From the utility main menu, select **4. Exit**, and then press <Enter>. The following warning message appears.

```
[ CONFIRM EXIT ]

Are you sure you want to exit? (Y/N):
```

2. Press <Y> to exit or press <N> to return to the utility main menu.

### 5.3.6 Rebuilding the RAID



---

This option is only for the RAID 1 set.

---

#### Rebuilding the RAID with other non-RAID disk

If any of the SATA hard disk drives included in the RAID 1 array failed, the system displays the status of the RAID volume as **"Degraded"** during POST. You can rebuild the RAID array with other installed non-RAID disks.

To rebuild the RAID with other non-RAID disk:

1. At the prompt, press <Ctrl> + <L> to enter the Intel Rapid Storage Technology option ROM utility.
2. If there is a non-RAID SATA Hard Disk available, the utility will prompt to rebuild the RAID. Press <Enter>, and then use up/down arrow keys to select the destination disk or press <ESC> to exit.

```
[ DEGRADED VOLUME DETECTED ]

"Degraded" volume and disk available for rebuilding detected. Selecting
a disk initiates a rebuild. Rebuild completes in the operating system.

Select the port of destination disk for rebuilding (ESC to exit):
Port Drive Model      Serial #      Size
X   XXXXXXXXXXXX      XXXXXXXX     XX.XGB

[↑↓]-Previous/Next [ENTER]-Select [ESC]-Exit
```



---

Select a destination disk with the same size as the original hard disk.

---



- The utility immediately starts rebuilding after the disk is selected. The status of the degraded RAID volume is changed to **"Rebuild"**.

```

Intel(R) Rapid Storage Technology - Option ROM - 10.1.0.1008
Copyright(C) 2003-12 Intel Corporation. All Rights Reserved.

[ MAIN MENU ]
1. Create RAID Volume
2. Delete RAID Volume
3. Reset Disks to Non-RAID
4. Exit

[ DISK/VOLUME INFORMATION ]

RAID Volumes:
ID Name Level Strip Size Status Bootable
0 Volume0 RAID1(Mirror) N/A 149.0GB Rebuild Yes
* = Data is Encrypted

Physical Devices:
Port Drive Model Serial # Size Type/Status (Vol ID)
1 ST3160812AS 9LS0F4HL 149.0GB Member Disk(0)
2 ST3160812AS 3LS0JYL8 149.0GB Member Disk(0)

Volumes with "Rebuild" status will be rebuilt within the operating system.

[↑↓]-Select [ESC]-Exit [ENTER]-Select Menu

```

- Exit Intel Rapid Storage Technology and reboot the system.
- Select **Start > Programs > Intel Rapid Storage > Intel Rapid Storage Console** or click the **Intel Rapid Storage Technology** tray icon to load the Intel Rapid Storage Manager utility.
- From the **View** menu, select **Advanced Mode** to display the details of the Intel Rapid Storage Console.
- From the **Volumes view** option, select **RAID volume** to view the rebuilding status. When finished, the status is changed to **"Normal"**.

## Rebuilding the RAID with a new hard disk

If any of the SATA hard disk drives included in the RAID array failed, the system displays the status of the RAID volume as **"Degraded"** during POST. You may replace the disk drive and rebuild the RAID array.

To rebuild the RAID with a new hard disk:

- Remove the failed SATA hard disk and install a new SATA hard disk of the same specification into the same SATA Port.



---

Select a destination disk with the same size as the original hard disk.

---

- Reboot the system and then follow the steps in section **Rebuilding the RAID with other non-RAID disk**.

### 5.3.7 Setting the Boot array in the BIOS Setup Utility

You can set the boot priority sequence in the BIOS for your RAID arrays when creating multi-RAID using the Intel® Rapid Storage Technology.

To set the boot array in the BIOS:



---

Set at least one of the arrays bootable to boot from the hard disk.

---

1. Reboot the system and press <Del> to enter the BIOS setup utility during POST.
2. Go to the **Boot** menu and select the boot option priority.
3. Use up/down arrow keys to select the boot priority and press <Enter>. See section **4.7 Boot menu** for details.
4. From the **Exit** menu, select **Save Changes & Exit**, then press <Enter>.
5. When the confirmation window appears, select **Yes**, then press <Enter>.

## 5.1.5 Marvell RAID utility

The onboard Marvell SATA 6.0 Gb/s controller allows you to create a RAID 0, RAID 1 or RAID 10 array using two SATA hard disk drives. Refer to Chapter 2 of your system user manual for the exact location of the Marvell SATA 6.0 Gb/s connector.

To enter the Marvell utility, press **<Ctrl> + <M>** during POST.



All existing data on the hard disk drives will be erased when creating or deleting a RAID array. Ensure that you have back up all your data in your hard disk drives before making any change to the drive status.

```
Marvell BIOS Setup (c) 2011 Marvell Technology Group Ltd.
-----
Topology                               Information
HBA 0: Marvell 0                         Vendor ID       : 1B4B
  Virtual Disks                           Device ID       : 9130
  Free Physical Disks                     Revision ID     : B1
    PD 0: ST3160812AS                     BIOS Version    : 1.0.0.1028
    PD 8: ST3160812AS                     Firmware Version: 2.2.0.1105
                                           PCIe Speed Rate : 5.0Gbps
                                           Configure SATA as: AHCI Mode
-----
Help
Marvell RAID on chip controller.
ENTER: Operation  F10: Exit/Save  ESC: Return
```

### Create a RAID Array

1. Move the selection bar to **HBA 0: Marvell 0** and press **<Enter>**.
2. Select **Configuration Wizard** and press **<Enter>**.

```
Marvell BIOS Setup (c) 2011 Marvell Technology Group Ltd.
-----
-Configure->Select free disks-----
HBA 0: Marvell 0                         Port ID         : 0
  Virtual Disks                           PD ID          : 0
  Free Physical Disks                     Type           : SATA PD
    * PD 0: ST3160812AS                   Status        : Unconfigured
    PD 8: ST3160812AS                     Size          : 152626MB
                                           Feature Support: MCQ 3G 48Bits
                                           Current Speed : 3G
                                           Model         : ST3160812AS
                                           Serial        : 9LS0F4HL
                                           FW Version    : 3.AAE
-----
Help
Use space bar to select the free disks to be used in the array.
ENTER: Operation  SPACE: Select  F10: Exit/Save  ESC: Return
```

3. Press **<Space>** to select the hard drives to be included in the RAID array. An asterisk (\*) appears in front of the selected hard drive. After selecting all the drives needed for the RAID array, press **<Enter>** to continue.

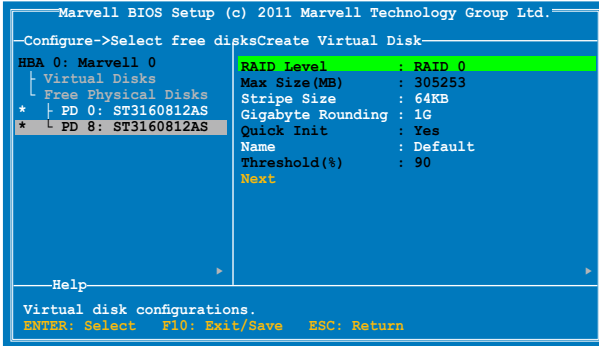

- Use the up or down arrow key to move the selection bar and press <Enter> to configure further RAID settings.

**RAID Level:** Select a RAID Level. Configuration options: [RAID 0] [RAID 1] [RAID 10] [HyperDuo]

**Stripe Size:** Specifies the size of single data block on the virtual disk. In general, a larger stripe size is recommended for applications requiring large data transfers such as audio, video, and graphics. A smaller stripe size is better for applications with content in much smaller size, such as e-mails and documents.

Configuration options: [32K] [64K]

**Gigabyte Rounding:** In the event of a single physical disk failure in a RAID 1 virtual disk, Gigabyte Rounding allows the replacement physical disk to be of a size slightly smaller than the existing physical disk. The capacity of the rebuilt virtual disk equals to the size of the smaller physical disk included in the RAID 1 array. The configuration options represent the tolerance value of drive capacity difference.

Configuration options: [None] [1G] [10G]

**Name:** Enter a name with 1–10 letters (no special characters) for the RAID array.

- Move the selection bar to **Next** and press <Enter>. The following warning message appears:



Press <Y> to create the RAID array, or press <N> to cancel. The new RAID array appears under Virtual Disks, as shown in the image below.

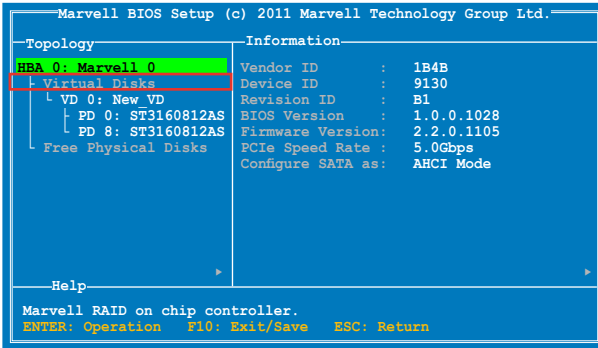

- Press <F10>. The following warning message appears:



Press <Y> to save the RAID setting and exit the Marvell RAID utility.

## Delete an existing RAID Array

- Select the RAID array to delete and press <Enter>. Select **Delete** and press <Enter>.

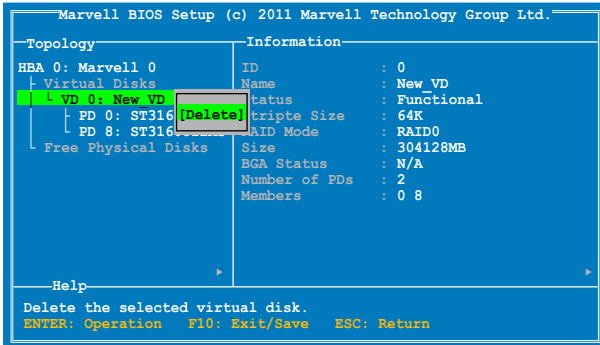

2. The following warning message appears:



Press <Y> to delete the selected RAID array. The following warning message appears:



Press <Y> to delete the Master Boot Record (MBR) from the selected RAID array.

3. Press <F10>. The following warning message appears:



Press <Y> to save the RAID setting and exit the Marvell RAID utility.

## 5.4 Intel® Rapid Storage Technology enterprise Utility (Windows)

The Intel® Rapid Storage Technology enterprise utility allows you to create RAID 0, RAID 1, RAID 10 (RAID 1+0), and RAID 5 set(s) from Serial ATA hard disk drives that are connected to the Serial ATA connectors supported by the Southbridge.

Before you using Intel® Rapid Storage Technology enterprise utility, you need to change BIOS setting first:

1. Enter the BIOS Setup during POST.
2. Go to the **Advanced Menu > Chipset Configuration > PCH Configuration > Onboard SATA Oprom**, then press <Enter>.
3. Set **Onboard SATA Oprom** to [Enabled].
4. Press <F10> to save your changes and exit the BIOS Setup.



You need to manually install the Intel® Rapid Storage Technology enterprise utility on a Windows® operating system. Please refer to the installation instructions in Chapter 6.

To enter the Intel® Rapid Storage Technology enterprise utility under Windows operating system:

1. Turn on the system to Windows desktop.
2. Click the **Intel® Rapid Storage Technology enterprise** icon to display the main menu.

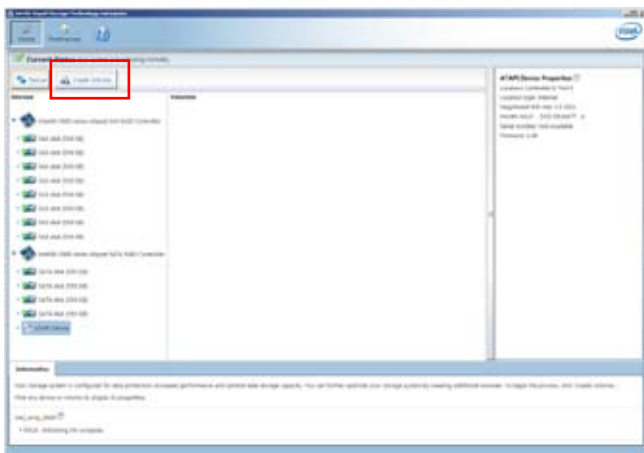

Your storage system is configured for data protection, increased performance and optimal data storage capacity. You can further optimize your storage system by creating additional volumes.



You can click **Rescan** to re-scan any attached hard disks.

# 5.4.1 Creating a RAID set

To create a RAID set

1. From the utility main menu, select **Create Volume** and select volume type.
2. Then click **Next**.

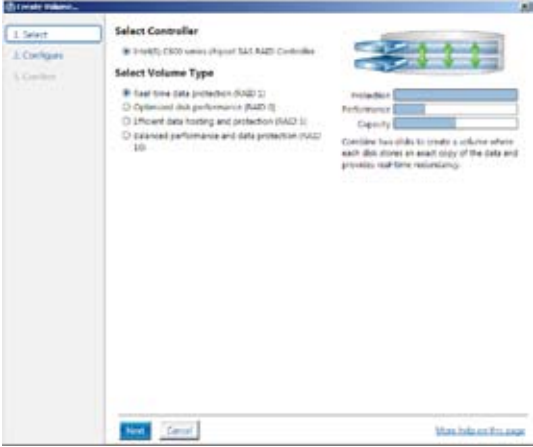

3. Enter a name for the RAID set, then select the array disks.
4. Select **Volume Size** tab, you can drag the bar to decide the volume size.
5. Then click **Next**.







- If you hard disk with existing data and you don't want to keep data from one of the selected disks, choose **NO** in next column (If displayed).
- If you want to **Enable volume write-back cache** or **Initialize volume**, you can click **Advanced** tab to select.

6. Confirm volume creation, than click **Create Volume** to continue.



This process could take a while depending on the number and size of the disks. You can continue using other applications during this time.

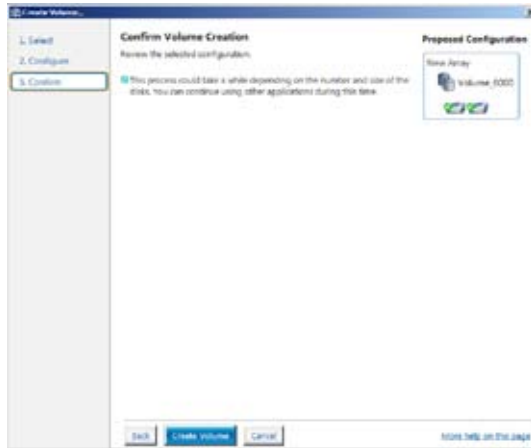

7. When display **Volume Creation Complete** message, you can click **OK** to finish.



You still need to partition your new volume using Windows Disk Management before adding any data.

- When you are finished, you will see the following screen in **Volumes** field and you can change related items in the **Volume Properties** field.

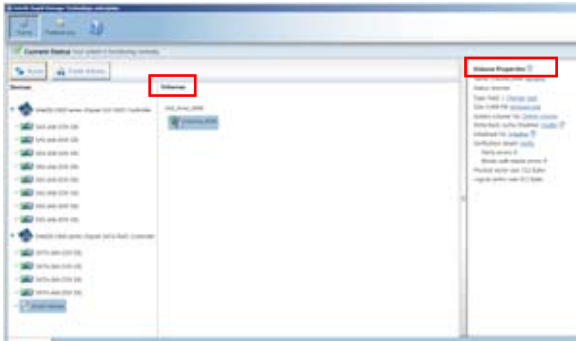

### 5.4.2 Change Volume Type

When you are finished to create a RAID set, you can view or change related items in the **Volume Properties** field.

To change the type in **Volume Properties**:

- Click the SAS array items you want to change in **Volumes** field.
- From the **Volume Properties** field, select **Type:RAID 1 Change type**.

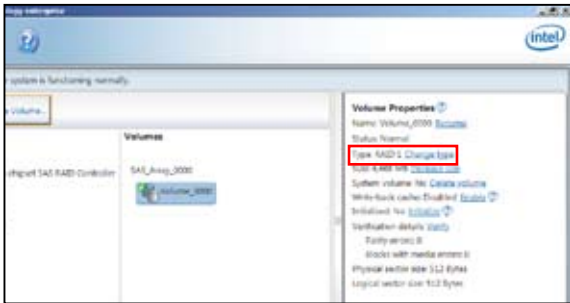

- You can change the **Name**, **Select the new volume type**, and **Select additional disks to include in the new volume** if needed.
- Then select the **Data stripe size** for the RAID array (for RAID 0, 10 and 5 only), and then click **OK**. The available stripe size values range from 4 KB to 128 KB. The following are typical values:  
 RAID 0: 128KB  
 RAID 10: 64KB  
 RAID 5: 64KB

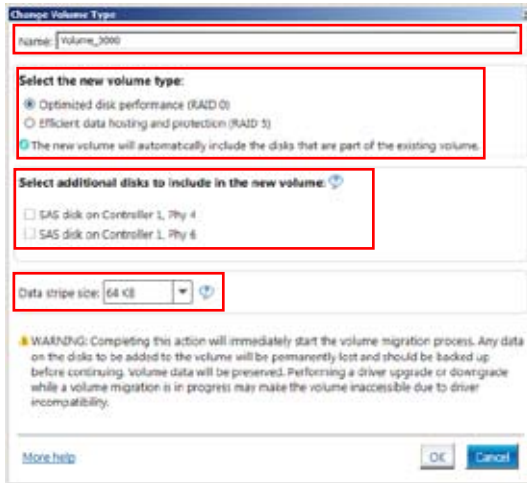

We recommend a lower stripe size for server systems, and a higher stripe size for multimedia computer systems used mainly for audio and video editing.

### 5.4.3 Delete volume



Take caution when deleting a volume. You will lose all data on the hard disk drives. Back up data before continuing.

To delete a volume:

1. From the utility main menu, select the volume (exp. Volume\_0000) in **Volumes** field you want to delete.

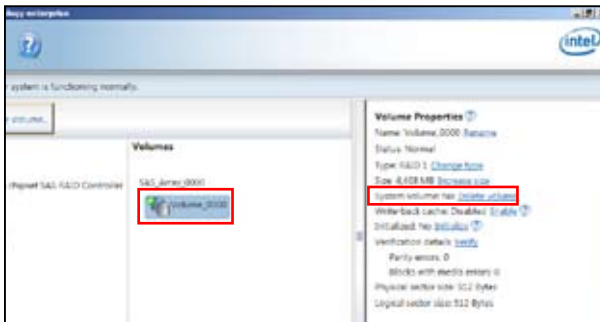

2. Then select **Delete volume** in **Volume Properties** field. The following screen appears.



3. Click **Yes** to delete the volume and return to the utility main menu, or click **No** to return to the main menu.

## 5.4.4 Preferences

### System Preferences

Allow you set to show the notification area icon and show system information, warning, or errors.

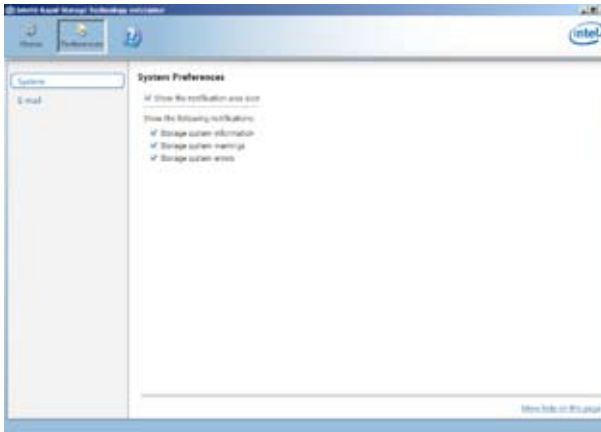

## E-Mail Preferences

Allow you set to sent e-mail of the following events:

- Storage system information
- Storage system warnings
- Storage system errors

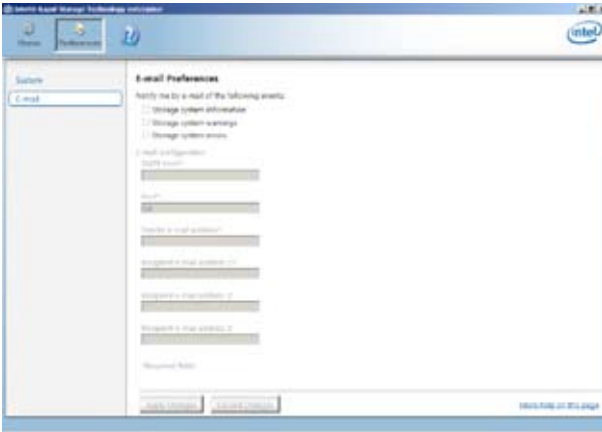



# Chapter 6

This chapter provides information on how to install the drivers for system components. This chapter also describes the software applications that the barebone workstation supports.



ASUS ESC2000 G2

# Driver installation

## 6.1 RAID driver installation

After creating the RAID sets for your server system, you are now ready to install an operating system to the independent hard disk drive or bootable array. This part provides the instructions on how to install the RAID controller drivers during OS installation.

### 6.1.1 Creating a RAID driver disk



The system does not include a floppy drive. You have to use a USB floppy drive when creating a SATA RAID driver disk.



If you have created RAID sets with the LSI Software RAID configuration utility, the boot priority of the SATA optical disk drive has to be manually adjusted. Otherwise, the system will not boot from the connected SATA ODD.

A floppy disk with the RAID driver is required when installing Windows® XP / Server 2003 or Linux operating system on a hard disk drive that is included in a RAID set. You can create a RAID driver disk in DOS (using the Makedisk application in the support DVD).

To create a RAID driver disk in DOS environment

1. Place the motherboard support DVD in the optical drive.
2. Restart the computer, and then enter the BIOS Setup.
3. Select the optical drive as the first boot priority to boot from the support DVD. Save your changes, and then exit the BIOS Setup.
4. Restart the computer. The Makedisk menu appears.



5. Use the arrow keys to select the type of RAID driver disk you want to create and press <Enter> to enter the sub-menu.

#### C60x INTEL RAID Driver

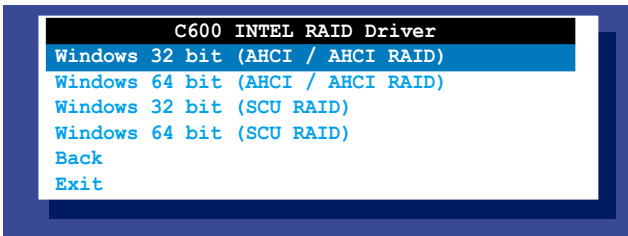



## LSI 2008 SAS2 Driver

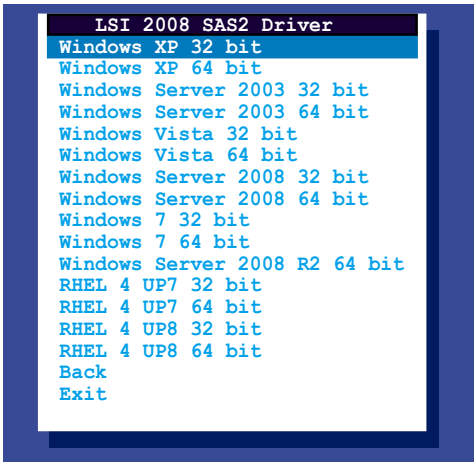

6. Locate the RAID driver and place a blank, high-density floppy disk to the floppy disk drive.
7. Press <Enter>.
8. Follow screen instructions to create the driver disk.

To create a RAID driver disk in Windows® environment:

1. Start Windows®.
2. Place the motherboard support DVD into the optical drive.
3. Go to the **Make disk** menu, and then select the type of RAID driver disk you want to create.
4. Insert a floppy disk into the USB floppy disk drive.
5. Follow succeeding screen instructions to complete the process.



---

Write-protect the floppy disk to avoid computer virus infection.

---

To create a RAID driver disk in Red Hat® Enterprise Linux server environment:

1. Insert a blank formatted high-density floppy disk to the USB floppy disk drive.
2. Type `dd if=XXX.img of=/dev/fd0` to decompress the file into the floppy disk from the following path in the support DVD:

For LSI MegaRAID Driver

`\\Drivers\C60x LSI RAID\Driver\makedisk\Linux`

3. Eject the floppy disk.

## 6.1.2 Installing the RAID controller driver

### For Windows® Server 2008 OS installation

To install the RAID controller driver when installing Windows® Server 2008 OS

1. Boot the computer using the Windows® Server 2008 OS installation disc. Follow the screen instructions to start installing Windows Server 2008.
2. When prompted to choose a type of installation, click **Custom (advanced)**.



3. Click **Load Driver**.

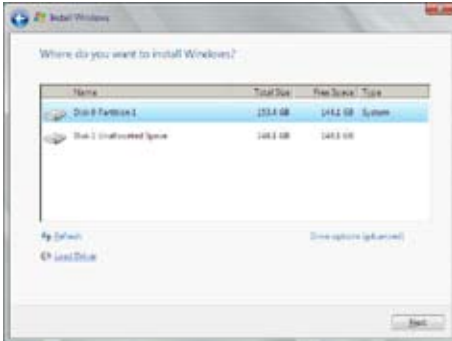

4. A message appears, reminding you to insert the installation media containing the driver of the RAID controller driver. If you have only one optical drive installed in your system, eject the Windows OS installation disc and replace with the motherboard Support DVD into the optical drive. Click **Browse** to continue.

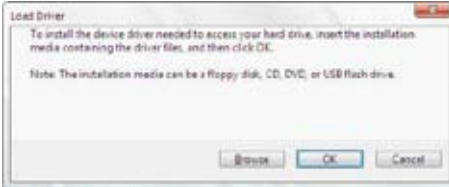

5. Locate the driver in the corresponding folder of the Support DVD, and then click **OK** to continue.
6. Select the RAID controller driver you need from the list and click **Next**.
7. When the system finishes loading the RAID driver, replace the motherboard Support DVD with the Windows Server installation disc. Select the drive to install Windows and click **Next**.

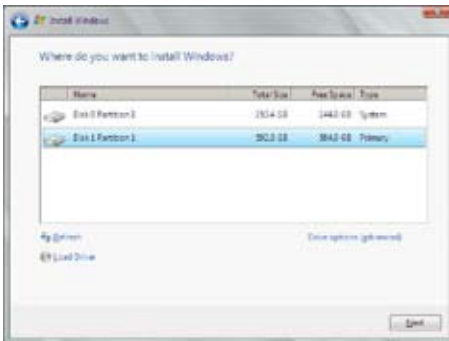

8. Setup then proceeds with the OS installation. Follow screen instructions to continue.

# For Red Hat® Enterprise Linux OS 5.6

To install the LSI MegaRAID controller driver when installing Red Hat® Enterprise OS:

1. Boot the system from the Red Hat® OS installation CD.
2. At the `boot:`, type `linux dd noprobe=ata1 noprobe=ata2...`, then press `<Enter>`.



The number of ata varies with the hard disk drive number you have when building a RAID set. For example, if you want to build a RAID set with 6 hard disk drives, type command line: `linux dd noprobe=ata1 noprobe=ata2 noprobe=ata3 noprobe=ata4 noprobe=ata5 noprobe=ata6`.

```
- To install or upgrade in graphical mode, press the <ENTER> key.
- To install or upgrade in text mode, type: linux text <ENTER>.
- Use the function keys listed below for more information.
[F1-Main] [F2-Options] [F3-General] [F4-Kernel] [F5-Rescue]
boot: linux dd noprobe=ata1 noprobe=ata2
```

3. Select **Yes** using the `<Tab>` key when asked if you have the driver disk, then press `<Enter>`.

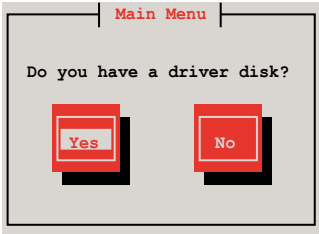

4. Insert the Red Hat® Enterprise RAID driver disk to the USB floppy disk drive, select **OK**, then press `<Enter>`.

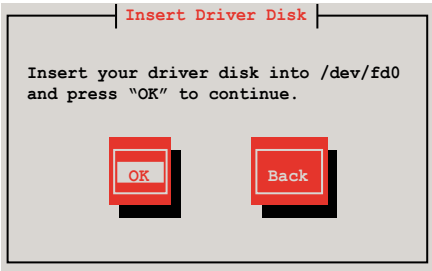

The drivers for the RAID card are installed to the system.

- When asked if you will load additional RAID controller drivers, select **No**, then press <Enter>.

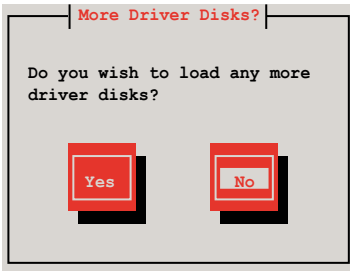

- Follow the onscreen instructions to finish the OS installation.
- When the installation is completed, DO NOT click **Reboot**. Press <Ctrl> + <Alt> + <F2> to switch to the command-line interface from graphic user interface.
- Type the following commands when using a Legacy floppy.

```
mkdir /mnt/driver
mount /dev/fd0 /mnt/driver
cd /mnt/driver
sh replace_ahci.sh
reboot
```

## For Red Hat® Enterprise Linux OS 6.1

To install the LSI MegaRAID controller driver when installing Red Hat® Enterprise OS:

- Boot the system from the Red Hat® OS installation CD.
- Press <Tab> to edit options.



3. Enter the following command at the boot: `Linux dd blacklist=iscsi blacklist=ahci nodmraid`, then press `<ENTER>`.



4. Select **Yes** using the `<Tab>` key when asked if you have the driver disk, then press `<Enter>`.

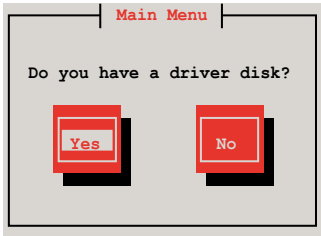

5. You have multiple devices which could serve as source for a driver disk. Choose one you like to use and select **OK**, then press <Enter>.

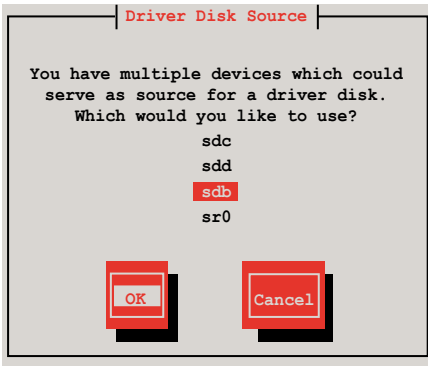

6. Insert the Red Hat® Enterprise RAID driver disk to the USB floppy disk drive, select **OK**, then press <Enter>.

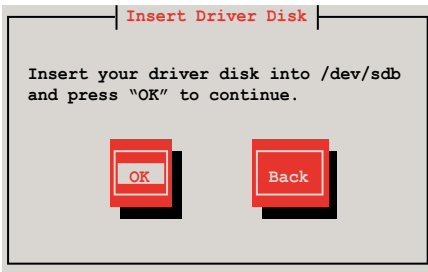

The drivers for the RAID card are installed to the system.

7. When asked if you will load additional RAID controller drivers, select **No**, then press <Enter>.

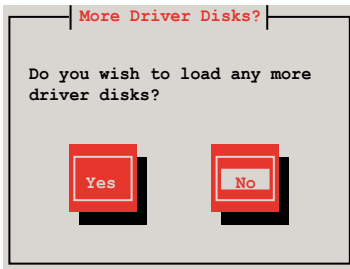

8. Follow the onscreen instructions to finish the OS installation.

## Preparing the Linux Driver

Ensure that there is another computer with a Linux-based OS to create the RAID driver. When creating the RAID driver, you may refer to the examples below which uses a 64bit SUSE Linux system to create a 64bit RAID driver for SUSE11 sp1.

1. Copy the image file into the Linux system.

Example: `megasr-15.00.0120.2012-1-sles11-ga-x86_64.img`

2. Create a folder.

Example: `image`

3. Mount the image file into the image folder using this command format:

`mount -o loop [image file name] image`

Example: `mount -o loop megasr-15-15.00.0120.2012-1-sles11-ga-x86_64.img image`



```
4ous@linux-doe5:/tmp> su -
Linux-doe5:~# ..
Linux-doe5:~# cd /tmp
Linux-doe5:/tmp# mount -o loop megasr-15.00.0120.2012-1-sles11-ga-x86_64.img image
Linux-doe5:/tmp# []
```

4. Copy the contents of the image directory, labeled as **01**, into a FAT32 USB drive.
5. Rename the **01** folder to **CD Image**.





## Installing SUSE 11 Linux OS

To install the LSI MegaRAID controller driver when installing SUSE Linux Enterprise Server OS:

1. Boot the system from the SUSE OS installation CD.
2. Use the arrow keys to select **Installation** from the **Boot Options** menu.



3. Press <F6>, then select **Yes** from the menu. Press <Enter>.



- Use the USB drive to provide the third-party driver during the OS installation. Type the command `brokenmodules=ahci` in **Boot Options** field, and press <Enter>.



- When below screen appears, select the USB floppy disk drive (sda) as the driver update medium. Select **OK**, then press <Enter>.

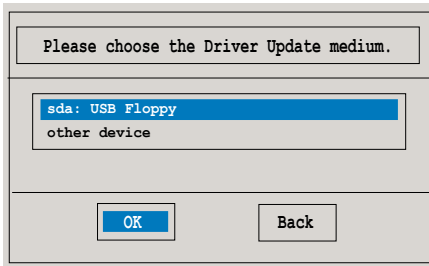

- Select **Back** and follow the onscreen instructions to finish the installation.

## 6.2 Intel® Chipset Device Software installation

This section provides the instructions on how to install the Intel® chipset device software on the system.

You need to manually install the Intel® chipset device software on a Windows operating system.

To install the Intel® chipset device software:

1. Restart the computer, and then log on with **Administrator** privileges.
2. Insert the motherboard/system support DVD to the optical drive. The support DVD automatically displays the **Drivers** menu if Autorun is enabled in your computer.



If Autorun is NOT enabled in your computer, browse the contents of the support DVD to locate the file **ASSETUP.EXE** from the **BIN** folder. Double-click the **ASSETUP.EXE** to run the support DVD.

3. Click the item **Intel Chipset Device Software** from the menu.



4. The **Intel(R) Chipset Device Software** window appears. Click **Next** to start installation.



5. Select **Yes** to accept the terms of the **License Agreement** and continue the process.



6. Read the **Readme File Information** and press **Next** to continue the installation.



7. Toggle **Yes, I want to restart the computer now** and click **Finish** to complete the setup process.



## 6.3 Intel® Network Connections Software installation

This section provides the instructions on how to install the Intel® Network Connections Software on the system.

You need to manually install the Intel® Network Connections Software on a Windows® operating system. To install the Intel® Network Connections Software:

1. Restart the computer, and then log on with **Administrator** privileges.
2. Insert the motherboard/system support DVD to the optical drive. The support DVD automatically displays the **Drivers** menu if Autorun is enabled in your computer.



- Windows® automatically detects the LAN controllers and displays a New Hardware Found window. Click **Cancel** to close this window.
- If Autorun is NOT enabled in your computer, browse the contents of the support DVD to locate the file **ASSETUP.EXE** from the **BIN** folder. Double-click the **ASSETUP.EXE** to run the DVD.

3. Click the **Intel® Network Connections Software** to begin installation.



4. Click **Install Drivers and Software** option to begin installation.



- Click **Next** when the **Intel(R) Network Connections–InstallShield Wizard** window appears.



- Toggle **I accept the terms in the license agreement** and click **Next** to continue.



- Click the **Intel(R) PROSet for Windows Device Manager** box, and then click **Next** to start the installation.

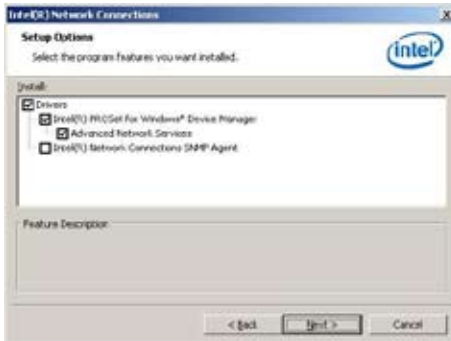

7. Follow the screen instructions to complete installation.

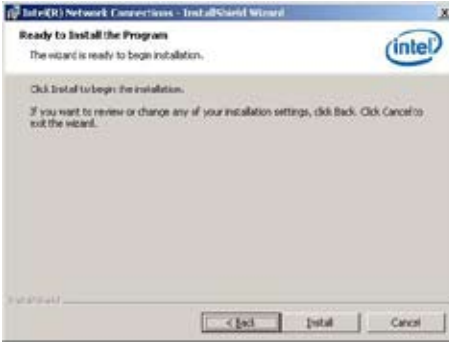

8. When finished, press **Finish** to continue.



## 6.4 Audio driver installation

This section provides the instructions on how to install the ASUS MIO Audio card/ Realtek High Definition Audio driver.

You need to manually install the **ASUS MIO Audio card/ Realtek High Definition Audio** driver on a Windows® operating system.

To install the **ASUS MIO Audio card/ Realtek High Definition Audio** driver:

1. Restart the computer, and then log on with **Administrator** privileges.
2. Insert the motherboard/system support DVD to the optical drive. The support DVD automatically displays the **Drivers** menu if Autorun is enabled in your computer.



If Autorun is NOT enabled in your computer, browse the contents of the support DVD to locate the file **ASSETUP.EXE** from the **BIN** folder. Double-click the **ASSETUP.EXE** to run the support DVD.

3. Click the **ASUS MIO Audio card/ Realtek High Definition Audio** to begin installation.



4. When the **Realtek High Definition Audio Driver** installation wizard appears, click **Yes** to start the installation.

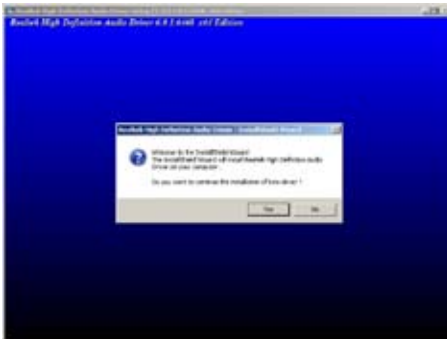



- When the installation completes, click **Yes, I want to restart my computer now** to restart your computer before using the program.



## 6.5 Intel® C600 Series Chipset SAS RAID (SATA mode) Drivers installation

This section provides the instructions on how to install the **Intel® C600 Series Chipset SAS RAID (SATA mode) Drivers** on the system.

You need to manually install the Intel® C600 Series Chipset SAS RAID (SATA mode) Drivers on a Windows operating system.

To install the drivers:

1. Restart the computer, and then log on with **Administrator** privileges.
2. Insert the motherboard/system support DVD to the optical drive. The support DVD automatically displays the **Drivers** menu if Autorun is enabled in your computer.



If Autorun is NOT enabled in your computer, browse the contents of the support DVD to locate the file **ASSETUP.EXE** from the **BIN** folder. Double-click the **ASSETUP.EXE** to run the support DVD.

3. Click the item **Intel® C600 Series Chipset SAS RAID (SATA mode) Drivers** from the menu, and then follow the onscreen instructions to complete the installation.



## 6.6 Marvell Magni installation

This section provides the instructions on how to install the **Marvell Magni** software on the system.

You need to manually install the Marvell Magni software on a Windows operating system.

To install the Marvell Magni driver:

1. Restart the computer, and then log on with **Administrator** privileges.
2. Insert the motherboard/system support DVD to the optical drive. The support DVD automatically displays the **Drivers** menu if Autorun is enabled in your computer.



If Autorun is NOT enabled in your computer, browse the contents of the support DVD to locate the file **ASSETUP.EXE** from the **BIN** folder. Double-click the **ASSETUP.EXE** to run the support DVD.

3. Click the item **Marvell Magni** software from the menu, and then follow the onscreen instructions to complete the installation.



## 6.7 Intel® Rapid Storage Technology enterprise 3.0 installation

This section provides the instructions on how to install the Intel® Rapid Storage Technology enterprise 3.0 on the system.

You need to manually install the Intel® Rapid Storage Technology enterprise 3.0 utility on a Windows® operating system.

To install the Intel® Rapid Storage Technology enterprise 3.0 utility:

1. Restart the computer, and then log on with **Administrator** privileges.
2. Insert the motherboard/system support DVD to the optical drive. The support DVD automatically displays the **Drivers** menu if Autorun is enabled in your computer.



If Autorun is NOT enabled in your computer, browse the contents of the support DVD to locate the file **ASSETUP.EXE** from the **BIN** folder. Double-click the **ASSETUP.EXE** to run the support DVD.

3. Click the **Intel® Rapid Storage Technology enterprise 3.0** to begin installation.



4. When the **Welcome to the Setup Program** appears, click **Next** to start the installation.



5. Read the **Warning** message and click **Next** to continue.



6. Read the **License Agreement** and click **Yes** to continue.



7. Read the **Readme File Information** and click **Next** to continue.



8. After completing the installation, click **Next** to complete the setup process.



9. Select **Yes, I want to restart my computer now** and click **Finish** to restart your computer before using the program.



## 6.8 Marvell Storage Utility installation

This section provides the instructions on how to install Marvell Storage Utility Driver.

To install the **Marvell Storage Utility** on a Windows® OS:

1. Restart the computer, and then log on with **Administrator** privileges.
2. Insert the motherboard/system support DVD to the optical drive. The DVD automatically displays the **Drivers** menu if Autorun is enabled in your computer.



If **Autorun** is NOT enabled in your computer, browse the contents of the support DVD to locate the file **AUTORUN.EXE** and double-click the **AUTORUN.EXE** and follow step 4 to run the installation.

3. Click **Marvell Storage Utility**.



4. When the **Marvell Storage Utility** installation wizard appears, click **Next** to start the installation.



5. Click **I accept the terms in the license agreement** and then click **Next** to continue.



6. Select the programs you want to install and click **Next** to continue.





7. Choose the destination folder to install and click **Install** to start the installation.



8. The programs you selected are being installed.



9. Click **Finish** to complete the installation.

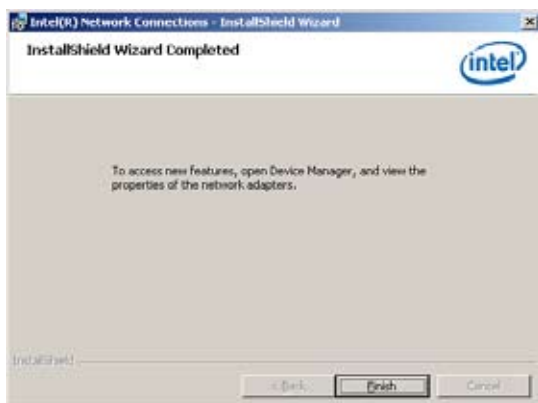

## 6.9 Asmedia ASM104x USB 3.0 Host Controller Driver installation

This section provides the instructions on how to install Asmedia ASM104x USB 3.0 Host Controller Driver.

To install the Asmedia ASM104x USB 3.0 Host Controller Driver on a Windows® OS:

1. Restart the computer, and then log on with **Administrator** privileges.
2. Insert the motherboard/system support DVD to the optical drive. The DVD automatically displays the **Drivers** menu if Autorun is enabled in your computer.



If **Autorun** is NOT enabled in your computer, browse the contents of the support DVD to locate the file **AUTORUN.EXE** and double-click the **AUTORUN.EXE** and follow step 4 to run the installation.

3. Click **Asmedia ASM104x USB 3.0 Host Controller Driver**.



- When the **Asmedia ASM104x USB 3.0 Host Controller Driver** installation wizard appears, click **Next** to start the installation.



- Click **I accept the terms in the license agreement** and then click **Next** to continue.



6. Click **Finish** to complete the installation and exit the wizard.



## 6.10 Intel® WG82574L Gigabit Adapters Driver installation

This section provides the instructions on how to install the Intel® WG82574L Gigabit Adapters Driver.

To install the **Intel® WG82574L Gigabit Adapters Driver** on a Windows® OS:

1. Restart the computer, and then log on with **Administrator** privileges.
2. Insert the motherboard/system support DVD to the optical drive. The DVD automatically displays the Drivers menu if Autorun is enabled in your computer.



If Autorun is NOT enabled in your computer, browse the contents of the support DVD to locate the file **AUTORUN.EXE** and double-click the **AUTORUN.EXE** and follow step 4 to run the installation.

3. Click **Intel® WG82574L Gigabit Adapters Driver**.



4. When the **Intel® WG82574L Gigabit Adapters Driver** installation wizard appears, click **Next** to start the installation.



5. Click **Modify** to change custom setup and then click **Next** to continue.



6. Select the programs you want to install and click **Next** to continue.



7. Click **Install** to begin installation.

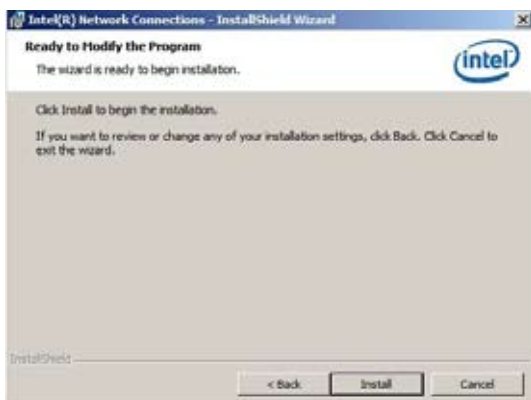

8. Click **Finish** to complete the installation.

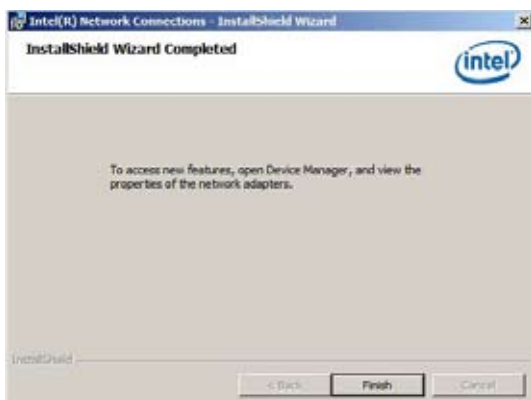



## 6.11 VGA driver installation

This section provides the instructions on how to install the ASPEED Video Graphics Adapter (VGA) driver.



- ASPEED SDT2300 Display Driver will only appear if you use the onboard VGA chipset.
- You need to manually install the ASPEED VGA driver on a Windows® operating system.

To install the ASPEED VGA driver:

1. Restart the computer, and then log on with **Administrator** privileges.
2. Insert the motherboard/system support DVD to the optical drive. The support DVD automatically displays the **Drivers** menu if Autorun is enabled in your computer.



If Autorun is NOT enabled in your computer, browse the contents of the support DVD to locate the file **ASSETUP.EXE** from the **BIN** folder. Double-click the **ASSETUP.EXE** to run the support DVD.

3. Click the **ASPEED AST2300 Display Driver** to begin installation.



4. When the **ASPEED Graphics** installation wizard appears, click **Next** to start the installation.



5. Toggle **I accept the terms in the license agreement** and click **Next** to continue.

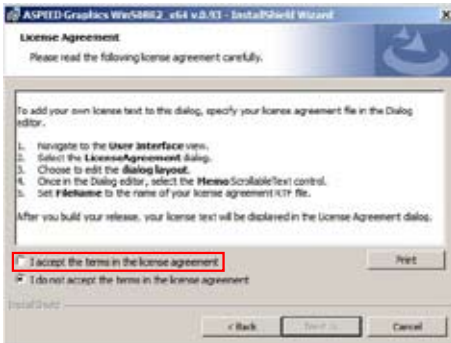

6. Enter the user information and click **Next** to continue.



7. Select a setup type and click **Next** to continue.



8. Click **Install** to start driver installation.

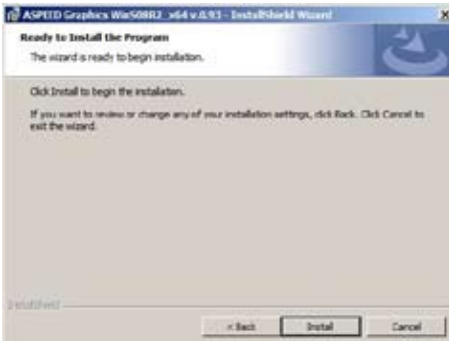

9. When the installation completes, click **Finish** to restart your computer before using the program.

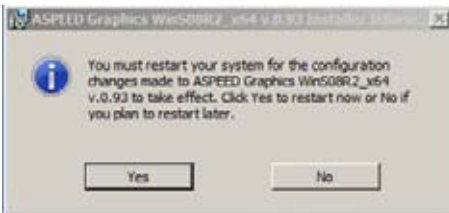

## 6.12 Management applications and utilities installation

The support DVD that came with the motherboard package contains the drivers, management applications, and utilities that you can install to avail all motherboard features.



The contents of the support DVD are subject to change at any time without notice. Visit the ASUS website ([www.asus.com](http://www.asus.com)) for updates.

### 6.12.1 Running the support DVD

Place the support DVD to the optical drive. The DVD automatically displays the Drivers menu if Autorun is enabled in your computer.



If Autorun is NOT enabled in your computer, browse the contents of the support DVD to locate the file **ASSETUP.EXE** from the **BIN** folder. Double-click the **ASSETUP.EXE** to run the support DVD.

### 6.12.2 Drivers menu

The Drivers menu shows the available device drivers if the system detects installed devices. Install the necessary drivers to activate the devices.



The screen display and driver options vary under different operating system versions.



### 6.12.3 Utilities menu

The Utilities menu displays the software applications and utilities that the motherboard supports. Click an item to install.



### 6.12.4 Make disk menu

The Make disk menu contains items to create the Intel RAID driver disks.



### 6.12.5 Contact information

Click the Contact tab to display the ASUS contact information. You can also find this information on the inside front cover of this user guide.





# Chapter 7

This chapter describes how to install and configure multiple AMD® CrossFireX™ / NVIDIA® SLI™ graphics cards and NVIDIA® CUDA technology.



ASUS ESC2000 G2

# Multiple GPU tech. support

## 7.1 AMD® CrossFireX™ technology

The motherboard supports the AMD® CrossFireX™ technology that allows you to install multi-graphics processing units (GPU) graphics cards. Follow the installation procedures in this section.

### 7.1.1 Requirements

- In Dual CrossFireX mode, you should have two identical CrossFireX-ready graphics cards or one CrossFireX-ready dual-GPU graphics card that are AMD® certified.
- Ensure that your graphics card driver supports the AMD CrossFireX technology. Download the latest driver from the AMD website ([www.amd.com](http://www.amd.com)).
- Ensure that your power supply unit (PSU) can provide at least the minimum power required by your system. See Chapter 2 for details.



- 
- We recommend that you install additional chassis fans for better thermal environment.
  - Visit the AMD Game website (<http://game.amd.com>) for the latest certified graphics card and the supported 3D application list.
- 

### 7.1.2 Before you begin

For AMD CrossFireX to work properly, you have to uninstall all existing graphics card drivers before installing AMD CrossFireX graphics cards to your system.

To uninstall existing graphics card drivers:

1. Close all current applications.
2. For Windows XP, go to **Control Panel > Add/Remove Programs**.  
For Windows 7, go to **Control Panel > Programs > Programs and Features**.
3. Select your current graphics card driver/s.
4. For Windows XP, select **Add/Remove**.  
For Windows 7, select **Uninstall**.
5. Turn off your computer.



### 7.1.3

## Installing two CrossFireX™ graphics cards



The following pictures are for reference only. The graphics cards and the motherboard layout may vary with models, but the installation steps remain the same.

1. Prepare two CrossFireX-ready graphics cards.
2. Insert the two graphics card into the PCIEX16 slots. If your motherboard has more than two PCIEX16 slots, refer to Chapter 2 in this user manual for the locations of the PCIEX16 slots recommended for multi-graphics card installation.
3. Ensure that the cards are properly seated on the slots.

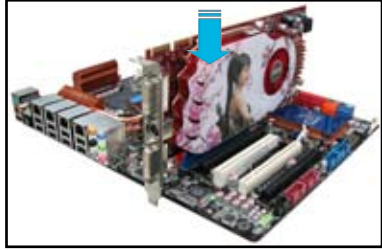

4. Align and firmly insert the CrossFireX bridge connector to the goldfingers on each graphics card. Ensure that the connector is firmly in place.

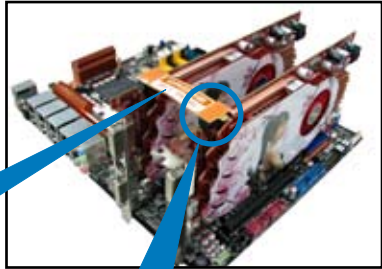

**CrossFireX bridge  
(bundled with graphics  
cards)**



**Goldfingers**

5. Connect two independent auxiliary power sources from the power supply to the two graphics cards separately.
6. Connect a VGA or a DVI cable to the graphics card.

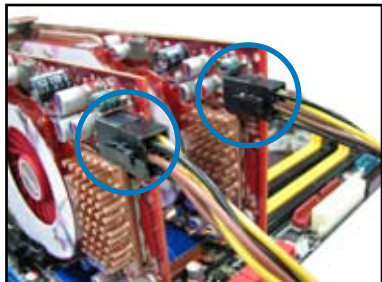

### 5.1.4 Installing the device drivers

Refer to the documentation that came with your graphics card package to install the device drivers.



Ensure that your PCI Express graphics card driver supports the AMD® CrossFireX™ technology. Download the latest driver from the AMD website ([www.amd.com](http://www.amd.com)).

### 5.1.5 Enabling the AMD® CrossFireX™ technology

After installing your graphics cards and the device drivers, enable the CrossFireX™ feature through the AMD Catalyst™ Control Center in Windows environment.

#### Launching the AMD VISION Engine Control Center

To launch the AMD VISION Engine Control Center:

1. Right-click on the Windows® desktop and select **AMD VISION Engine Control Center**. You can also right-click the AMD icon in the Windows notificAMDon area and select **Vision Engine Control Center**.

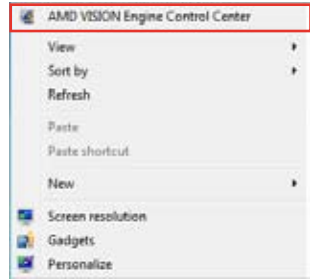

2. The **VISION Engine Control Center Setup Assistant** appears when the system detects the existence of multi-graphics cards. Click **Go** to continue to the **VISION Engine Control Center Advanced View** window.



#### Enabling Dual CrossFireX technology

1. In the Catalyst Control Center window, click **Graphics Settings > Performance > AMD CrossFireX™ Configuration**.
2. From the Graphics Adapter list, select the graphics card to act as the display GPU.
3. Select **Enable CrossFireX™**.
4. Click **Apply**, and then click **OK** to exit the window.



## 7.2 NVIDIA® SLI™ technology

The motherboard supports the NVIDIA® SLI™ (Scalable Link Interface) technology that allows you to install multi-graphics processing units (GPU) graphics cards. Follow the installation procedures in this section.

### 7.2.1 Requirements

- In Dual SLI mode, you should have two identical SLI-ready graphics cards that are NVIDIA® certified.
- In Triple SLI mode, you should have three identical SLI-ready graphics cards that are NVIDIA® certified.
- Ensure that your graphics card driver supports the NVIDIA SLI technology. Download the latest driver from the NVIDIA website ([www.nvidia.com](http://www.nvidia.com)).
- Ensure that your power supply unit (PSU) can provide at least the minimum power required by your system.



- 
- We recommend that you install additional chassis fans for better thermal environment.
  - Visit the NVIDIA zone website (<http://www.nzone.com>) for the latest certified graphics card and supported 3D application list.
- 

### 7.2.2 Installing two SLI-ready graphics cards



---

The following pictures are for reference only. The graphics cards and the motherboard layout may vary with models, but the installation steps remain the same.

---

1. Prepare two SLI-ready graphics cards.
2. Insert the two graphics card into the PCIEX16 slots. If your motherboard has more than two PCIEX16 slots, refer to Chapter 2 in this user manual for the locations of the PCIEX16 slots recommended for multi-graphics card installation.
3. Ensure that the cards are properly seated on the slots.

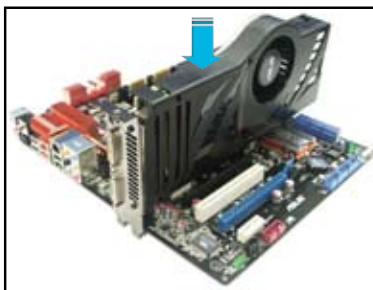

4. Align and firmly insert the SLI bridge connector to the goldfingers on each graphics card. Ensure that the connector is firmly in place.
5. Connect two independent auxiliary power sources from the power supply to the two graphics cards separately.
6. Connect a VGA or a DVI cable to the graphics card.

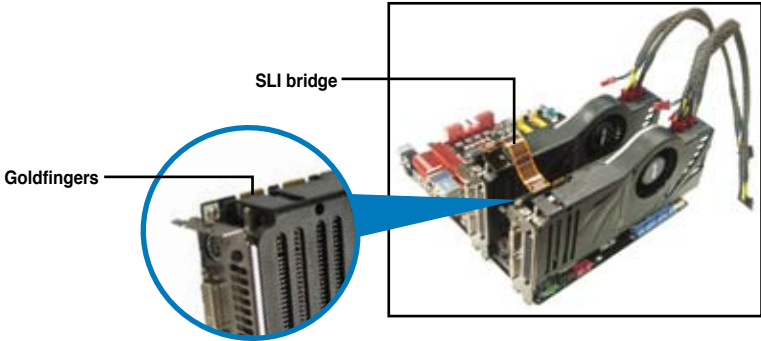

### 7.2.3 Installing three SLI-ready graphics cards

1. Prepare three SLI-ready graphics cards.
2. Insert the three graphics card into the PCIEX16 slots. If your motherboard has more than two PCIEX16 slots, refer to Chapter 2 in this user manual for the locations of the PCIEX16 slots recommended for multi-graphics card installation.
3. Ensure that the cards are properly seated on the slots.
4. Align and firmly insert the 3-Way SLI bridge connector to the goldfingers on each graphics card. Ensure that the connector is firmly in place.
5. Connect three independent auxiliary power sources from the power supply to the three graphics cards separately.
6. Connect a VGA or a DVI cable to the graphics card.

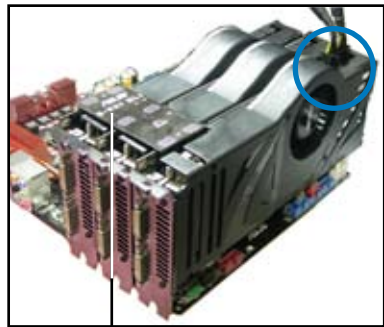
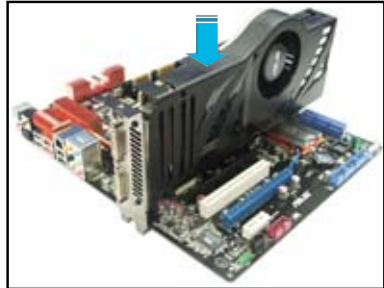

3-Way SLI bridge

## 7.2.4 Installing four SLI-ready graphics cards

1. Prepare four SLI-ready graphics cards.
2. Insert the four graphics card into the PCIEX16 slots. If your motherboard has more than two PCIEX16 slots, refer to Chapter 2 in this user manual for the locations of the PCIEX16 slots recommended for multi-graphics card installation.
3. Ensure that the cards are properly seated on the slots.
4. Align and firmly insert the 4-Way SLI bridge connector to the goldfingers on each graphics card. Ensure that the connector is firmly in place.
5. Connect four independent auxiliary power sources from the power supply to the four graphics cards separately.
6. Connect a VGA or a DVI cable to the graphics card.

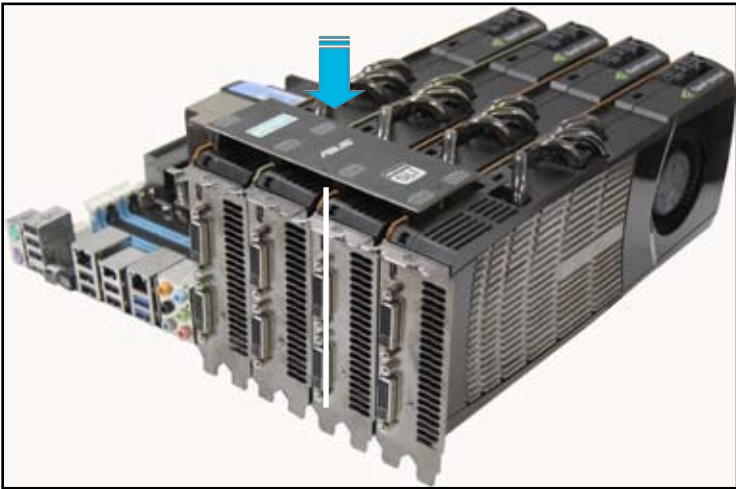

4-Way SLI bridge

## 7.2.5 Installing the device drivers

Refer to the documentation that came with your graphics card package to install the device drivers.



- Ensure that your PCI Express graphics card driver supports the NVIDIA® SLI™ technology. Download the latest driver from the NVIDIA website at [www.nvidia.com](http://www.nvidia.com).
- If you are using a Triple SLI system, ensure to install the NVIDIA® 3-way SLI driver under Windows® Vista™. The NVIDIA 3-way SLI technology is supported by Windows® Vista™ only.

## 7.2.6 Enabling the NVIDIA® SLI™ technology

After installing your graphics cards and the device drivers, enable the SLI feature in NVIDIA® Control Panel under the Windows® 7™ operating system.

### Launching the NVIDIA Control Panel

You can launch the NVIDIA Control Panel by the following two methods.

- A. Right click on the empty space of the Windows® desktop and select **NVIDIA Control Panel**.

The NVIDIA Control Panel window appears (See Step B5).



- B1. If you cannot see the NVIDIA Control Panel item in step (A), select **Personalize**.

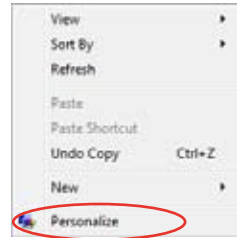

- B2. From the **Personalization** window, select **Display Settings**.

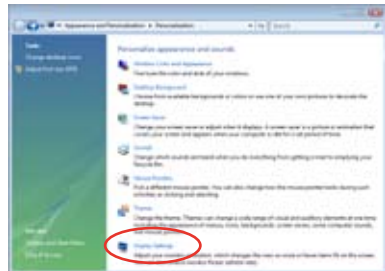

- B3. From the Display Settings dialog box, click **Advanced Settings**.

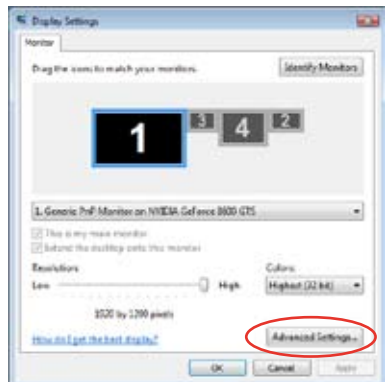

- B4. Select the NVIDIA GeForce tab, and then click **Start the NVIDIA Control Panel**.



- B5. The NVIDIA Control Panel window appears.



### Enabling SLI settings

From the NVIDIA Control Panel window, select **Set SLI Configuration**. Click **ENABLE SLI** and set the display for viewing SLI rendered content. When done, click **Apply**.





## 7.3 NVIDIA® CUDA™ technology

The motherboard supports the NVIDIA® CUDA™ technology and up to 4 NVIDIA® Telsa™ computing processor cards, providing the optimum multi purpose computing performance. Follow the installation procedures in this section.

### 7.3.1 Requirements

- 32/64-bit Microsoft® Windows XP/ Vista/ Linux RHEL5.X/ Open SuSE11.X OS
- The requirements of memory and power supply vary with the Telsa cards you installed.



- We recommend that you install additional chassis fans for better thermal environment.
- The installation steps might be a little different with the Telsa cards you selected and the VGA output functions. Visit <http://www.nvidia.com> for more details if needed.
- Visit the NVIDIA CUDA Zone website at [http://www.nvidia.com/object/cuda\\_home.html](http://www.nvidia.com/object/cuda_home.html) for the latest driver, list of CUDA-certified graphics card and supported 3D application list.

### 7.3.2 Installing CUDA-ready graphics cards



The following pictures are for reference only. The graphics cards and the motherboard layout may vary with models, but the general installation steps remain the same.

1. Insert four Tesla computing processor card(s) into the PCIe x16\_1, PCIe x16\_2, PCIe x16\_3, and PCIe x16\_4 slot. Ensure that the cards are properly seated on the slot.



2. Connect either one 8-pin power connector or two 6-pin power connectors from the power supply to the Quadro graphics card and Tesla computing processor card(s).
3. Connect a display cable to the graphics card.

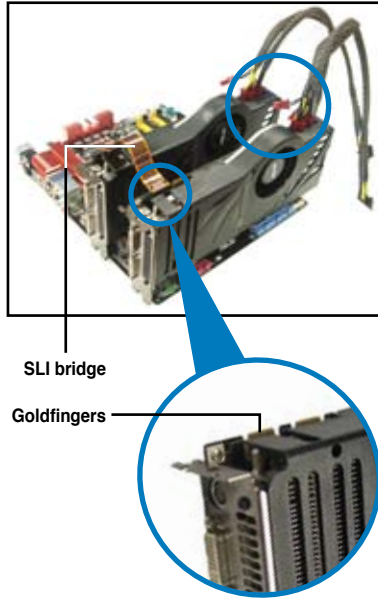

SLI bridge

Goldfingers

4. Refer to the documentation that came with your graphics card package to install the device drivers.
5. To verify graphics card driver installation, right-click **My Computer** and select **Properties** from the menu. Click the **Hardware** tab, and then click **Device Manager**. Click the “+” sign before **Display adapters**, and the installed graphics card and computing processor card(s) should appear.

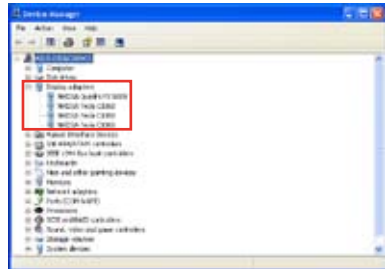

---

The screen differs based on the components you installed.

---

